



# PERLICK®

# R

RESIDENTIAL



2026 Residential Price List



→ Including the all new G5 Collection –  
The most advanced refrigeration ever

  
Milwaukee

♦ PRICING EFFECTIVE 01/01/2026  
Prices subject to change without notice

800.558.5592

perlick.com

# TABLE OF CONTENTS

<b>G5 Collection Refrigeration</b>			
Introduction.....	4		
Nomenclature.....	8		
Core Models.....	8		
Luxe Models.....	9		
ADA Height and Shallow Depth.....	13		
Door and Panel Options.....	14		
Panel Models.....	15		
<b>Column Refrigeration</b>			
Introduction.....	19		
Nomenclature.....	20		
Models.....	20		
Accessories.....	21		
<b>Signature Series Refrigeration</b>			
Nomenclature.....	23		
Marine Grade Intro.....	24		
<b>HP24 24" Signature Series</b>			
Marine Grade Outdoor Models.....	26		
<b>HH24 Signature Series Shallow Depth 18" Depth</b>			
Marine Grade Outdoor Models.....	28		
<b>HP15 15" Signature Series</b>			
Marine Grade Outdoor Models.....	30		
<b>15" Clear Ice Makers</b>			
Indoor/Outdoor Models.....	32		
<b>15" Cubelet Ice Makers</b>			
Indoor/Outdoor Models.....	33		
<b>Tobin Ellis Signature Series Mobile Bars</b>			
Tobin Ellis Series Mobile Bars.....	34		
<b>Perlick Mobile Tap</b>			
Features and Benefits.....	38		
Configurations.....	39		
<b>Beverage Dispensing Guide.....</b>	40		
<b>Accessories - Faucets and Couplers.....</b>	42		
<b>Accessories - Beverage Dispensing</b>			
Coffee Dispensing Kit.....	44		
Beer/Coffee Dispenser Tapping Kits, Faucets and Couplers.....	44		
<b>Accessories - Undercounter Refrigeration</b>			
Ice Maker Accessories.....	45		
Replacement Grilles.....	45		
Misc. Hardware.....	45		
Shelving/Shelving Components.....	46		
<b>Warranty.....</b>	47		





## A Letter from the Fifth Generation of the Perlick Family

For over a century, Perlick has been a family story—one of craftsmanship, care, and the belief that the spaces where we gather can bring us closer. From my great-great-grandfather, who founded Perlick in 1917, to today, each generation has carried forward a simple promise: to create equipment that is built to last, serve others better, and lead the industry forward.

Now, as the fifth generation to lead this company, I'm honored to introduce the G5 Collection – The most advanced refrigeration we've ever created. More than just a new product, it symbolizes the continuation of our legacy and vision: helping the world serve better.

Every detail of the G5 Collection is crafted to inspire—a reflection of five generations of Perlick innovation and care. Thoughtful high-performance features, quiet precision, and refined seamless design aesthetic come together to create spaces where gatherings feel effortless, every pour is flawless, and every moment unforgettable. Built with the same quality trusted by top bars and restaurants, the G5 Collection brings that unmatched performance and beauty home.

As Generation 5, I feel a deep responsibility to honor those who came before me while creating products that homeowners and professionals can trust for generations to come. The G5 Collection is our promise realized: built to inspire, made to last.

With gratitude,

A handwritten signature in black ink, appearing to be 'TJ' followed by a stylized surname.

Theodore "TJ" Perlick Molinari  
CEO, Fifth Generation Family Member



# G5 COLLECTION

## THE NEW STANDARD IN PREMIUM REFRIGERATION

With over a century of premier commercial expertise, we're elevating home refrigeration to a new expression of unmatched modern luxury.



## ➔ PROFESSIONAL PERFORMANCE

Our fastest cool-down ever, powered by Perlick's exclusive RAPIDcool™ technology, chills every beverage quickly, ultra-quietly and evenly throughout the entire cabinet

## ➔ EXCLUSIVE TECHNOLOGY

Smart-Defrost intuitively provides efficient frost-free operation adapting to use and environmental conditions with Smart-Monitoring continuously tracking performance for dependability, and remote support

## ➔ LUXURY DESIGN

Panel-ready options, with soft-closing articulating hinges, create a beautiful uninterrupted, fully concealed, seamless aesthetic to integrate into any uniquely curated space

## ➔ COMMERCIAL-GRADE

Fully stainless steel exteriors and interiors, corrosion resistance, certified for indoor and outdoor use, delivering reliable performance regardless of temperature or humidity, uses Perlick's Anti-Condensation System™—as trusted by the world's top bars and restaurants

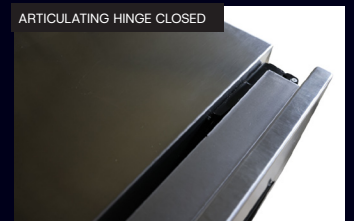
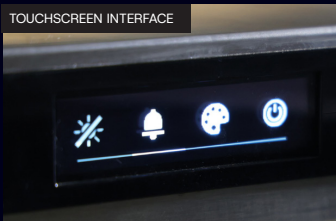

## ADDITIONAL BENEFITS

- Touchscreen UI + Total Color Control™ Lighting gives sleek, intuitive controls provide easy access to temperature lighting, and diagnostics—20+ dimming lighting curated states to perfectly enhance ambiance and harmonize with surrounding finishes
- Quick-Cool Mode delivers on-demand cooling 20% faster than our standard pull-down
- Patent-pending Front-Access Leveling Legs streamline installation with easy access—no tipping or repositioning required for adjustments
- Full-extension shelving provides maximum stability and smooth, vibration-dampened glides for easy loading and effortless access to the back of the cabinet
- Ultra-quiet performance, 55% quieter than previous models
- Glass doors feature Low E, Argon filled UV-resistant triple-pane thermal glass to limit energy transfer and add increased strength to indoor and outdoor performance
- More Eco-Friendly: Uses entirely sustainable stainless steel and R600a refrigerant with zero ODP and very low GWP
- Sabbath Mode Star-K certified in accordance with Halacha, Shabbat, and Jewish Holidays
- Exclusively designed, engineered and manufactured by Perlick

## G5 COLLECTION CORE MODELS

- Standard warranty for Core models provides 3-year full parts & labor, 6-year sealed system parts & labor, with 30-day initial aesthetics parts & labor
- Commercial-grade 400 series all stainless steel interiors and exteriors



## G5 COLLECTION LUXE MODELS

- Premium Warranty provides industry-leading 6 years parts & labor coverage
- Ultra Professional-Grade 300-Series all stainless steel interiors and exteriors, including full stainless steel shelving, providing additional protection in harsh environments





# G5 COLLECTION DEPTH AND HEIGHT OPTIONS

## SELECT YOUR DESIRED HEIGHT AND DEPTH

In addition to our line of standard height and depth undercounter equipment, the G5 collection also offers shallow-depth and ADA height options for certain product categories

**G5 SHALLOW DEPTH**



**G5 STANDARD DEPTH**



**G5 SHORT ADA HEIGHT**



**G5 STANDARD HEIGHT**





# NOMENCLATURE

## HOW MODEL NUMBERS ARE BUILT

Example – G5 Luxe 24" Beverage Center, Glass Door  
(Model No. G5BC24GL)

<b>G5BC24GL</b>	<b>G5</b> = GENERATION 5			
<b>G5BC24GL</b>	<b>BC</b> = BEVERAGE CENTER	<b>RE</b> = REFRIGERATOR	<b>WR</b> = WINE RESERVE	
	<b>BZ</b> = DUAL ZONE BEVERAGE	<b>WD</b> = DUAL ZONE WINE	<b>BD</b> = BEVERAGE DISPENSER	
	<b>RD</b> = REFRIGERATOR DRAWERS	<b>FD</b> = FREEZER DRAWERS		
<b>G5BC24GL</b>	<b>24</b> = 24" MODEL	<b>15</b> = 15" MODEL		
<b>G5BC24GL</b>	<b>G</b> = GLASS DOOR	<b>S</b> = SOLID DOOR		
<b>G5BC24GL</b>	<b>L</b> = LUXE	<b>C</b> = CORE		
	<b>D</b> = SHALLOW-DEPTH (LUXE)	<b>A</b> = ADA (CORE)		

## G5 COLLECTION CORE MODELS



G5BC24GC



G5BC24SC

### G5 CORE 24" BEVERAGE CENTER – 33°F (0.6°C) – 48°F (8.9°C)

UMRP

G5BC24SC	24" Beverage Center, Solid Door		<b>\$4,000</b>
G5BC24GC	24" Beverage Center, Glass Door		<b>\$4,300</b>
G5BC24SA	24" Beverage Center, Solid Door, ADA, G5		<b>\$4,000</b>
G5BC24GA	24" Beverage Center, Glass Door, ADA, G5		<b>\$4,300</b>



G5RE24GC



G5RE24SC

### G5 CORE 24" REFRIGERATOR – 33°F (0.6°C) – 48°F (8.9°C)

UMRP

G5RE24SC	24" Refrigerator, Solid Door, Hinge Right		<b>\$3,800</b>
G5RE24GC	24" Refrigerator, Glass Door, Hinge Right		<b>\$4,100</b>
G5RE24SA	24" Refrigerator, Solid Door, ADA, G5 Core		<b>\$3,800</b>
G5RE24GA	24" Refrigerator, Glass Door, ADA, G5 Core		<b>\$4,100</b>



G5WR24GC



G5WR24SC

### G5 CORE 24" WINE RESERVE – 40°F (4.4°C) – 68°F (20°C)

UMRP

G5WR24SC	24" Wine Reserve, Solid Door, Hinge Right		<b>\$4,700</b>
G5WR24GC	24" Wine Reserve, Glass Door, Hinge Right		<b>\$5,000</b>
G5WR24SA	24" Wine Reserve, Solid Door, ADA, G5 Core		<b>\$4,700</b>
G5WR24GA	24" Wine Reserve, Glass Door, ADA, G5 Core		<b>\$5,000</b>

\*All G5 products shown with panel (sold separately)



G5RD24SC

<b>G5 24" REFRIGERATOR DRAWERS – 33°F (0.6°C) – 48°F (8.9°C)</b>		UMRP
G5RD24SC	24" Refrigerator, Drawers	<b>\$4,900</b>
G5RD24SA	24" Refrigerator, Drawers, ADA,	<b>\$4,900</b>



G5FD24SA

<b>G5 24" FREEZER DRAWERS ADA – -10°(-23.3°) – 10°(-12.2°)</b>		UMRP
G5FD24SA	24" Freezer, Drawers, ADA	<b>\$5,400</b>



G5BD24SC

<b>G5 24" BEVERAGE DISPENSER – 33°F (0.6°C) – 48°F (8.9°C)</b>		UMRP
G5BD24SC	24" Beverage Dispenser, Solid Door, Hinge Right	<b>\$3,900</b>

\*Dispensing kits and accessories sold separately, see page 17

## G5 COLLECTION LUXE MODELS



G5RE15SL



G5RE15GL

<b>G5 LUXE 15" REFRIGERATOR – 33°F (0.6°C) – 48°F (8.9°C)</b>		UMRP
G5RE15SL	Refrigerator, Solid Door, 15" G5 Luxe	<b>\$4,800</b>
G5RE15GL	Refrigerator, Glass Door, 15" G5 Luxe	<b>\$5,100</b>



G5BC15GL



G5BC15SL

<b>G5 LUXE 15" BEVERAGE CENTER – 33°F (0.6°C) – 48°F (8.9°C)</b>		UMRP
G5BC15SL	15" Beverage Center, Solid Door,	<b>\$4,800</b>
G5BC15GL	15" Beverage Center, Glass Door,	<b>\$5,100</b>

\*All G5 products shown with panel (sold separately)



G5WR15GL



G5WR15SL

**G5 LUXE 15" WINE RESERVE – 40°F (4.4°C) – 68°F (20°C)**

UMRP

G5WR15SL	15" Wine Reserve, Solid Door, Hinge Right		<b>\$5,200</b>
G5WR15GL	15" Wine Reserve, Glass Door, Hinge Right		<b>\$5,500</b>



G5RD15SL

**G5 LUXE 15" REFRIGERATOR DRAWERS – 33°F (0.6°C) – 48°F (8.9°C)**

UMRP

G5RD15SL	15" Refrigerator, Drawers		<b>\$5,500</b>
----------	---------------------------	--	----------------



G5BD15SL

**G5 LUXE 15" BEVERAGE DISPENSER – 33°F (0.6°C) – 48°F (8.9°C)**

UMRP

G5BD15SL	15" Beverage Dispenser, Solid Door, Hinge Right		<b>\$4,500</b>
----------	---	--	----------------

\*Dispensing kits and accessories sold separately, see page 17



G5RE24GL



G5RE24SL

**G5 LUXE 24" REFRIGERATOR – 33°F (0.6°C) – 48°F (8.9°C)**

UMRP

G5RE24SL	24" Refrigerator, Solid Door, Hinge Right		<b>\$5,000</b>
G5RE24GL	24" Refrigerator, Glass Door, Hinge Right		<b>\$5,300</b>
G5RE24SD	24" Refrigerator, Solid Door, Shallow ADA, G5 Luxe		<b>\$5,000</b>
G5RE24GD	24" Refrigerator, Glass Door, Shallow ADA, G5 Luxe		<b>\$5,300</b>



G5BC24GL



G5BC24SL

**G5 LUXE 24" BEVERAGE CENTER – 33°F (0.6°C) – 48°F (8.9°C)**

UMRP

G5BC24SL	24" Beverage Center, Solid Door, Hinge Right		<b>\$5,000</b>
G5BC24GL	24" Beverage Center, Glass Door, Hinge Right		<b>\$5,300</b>
G5BC24SD	24" Beverage Center, Solid Door, Shallow ADA, Luxe		<b>\$5,000</b>
G5BC24GD	24" Beverage Center, Glass Door, Shallow ADA, Luxe		<b>\$5,300</b>

\*All G5 products shown with panel (sold separately)



– ENERGY STAR Qualified model



G5WR24GL



G5WR24SL

**G5 LUXE 24" WINE RESERVE - 40°F (4.4°C) - 68°F (20°C)**

UMRP

G5WR24SL	24" Wine Reserve, Solid Door, Hinge Right		<b>\$5,500</b>
G5WR24GL	24" Wine Reserve, Glass Door, Hinge Right		<b>\$5,800</b>
G5WR24SD	24" Wine Reserve, Solid Door, Shallow ADA, G5 Luxe		<b>\$5,500</b>
G5WR24GD	24" Wine Reserve, Glass Door, Shallow ADA, G5 Luxe		<b>\$5,800</b>



G5BZ24GL



G5BZ24SL

**G5 LUXE 24" DUAL ZONE BEVERAGE CENTER -**

Upper Zone - Wine: 40° (4.4°) - 68° (20°)

Lower Zone - Refrigerator: 33° (0.6°) - 42° (5.6°)

UMRP

G5BZ24SL	24" Dual Zone Beverage Center, Solid Door, Hinge Right		<b>\$6,000</b>
G5BZ24GL	24" Dual Zone Beverage Center, Glass Door, Hinge Right		<b>\$6,300</b>



G5WD24GL



G5WD24SL

**G5 LUXE 24" DUAL ZONE WINE RESERVE -**

Upper Zone - Wine: 40°F (4.4°C) - 68°F (20°C), Factory Set Point 55°F (12.8°C)

Lower Zone - Wine: 40°F (4.4°C) - 68°F (20°C), Factory Set Point 45°F (7.2°C)

UMRP

G5WD24SL	24" Dual Zone Wine Reserve, Solid Door, Hinge Right		<b>\$6,000</b>
G5WD24GL	24" Dual Zone Wine Reserve, Glass Door, Hinge Right		<b>\$6,300</b>



G5RD24SL

**G5 LUXE 24" REFRIGERATOR DRAWERS - 33°F (0.6°C) - 48°F (8.9°C)**

UMRP

G5RD24SL	24" Refrigerator, Drawers		<b>\$5,700</b>
----------	---------------------------	---	----------------



G5FD24SL

**G5 LUXE 24" FREEZER DRAWERS - -10°(-23.3°) - 10°(-12.2°)**

UMRP

G5FD24SL	24" Freezer, Drawers		<b>\$6,200</b>
----------	----------------------	--	----------------



G5DZ24SL

**G5 DUAL ZONE LUXE 24" REFRIGERATOR/FREEZER DRAWERS –**

Upper Zone – Refrigerator: 34° (1.1°) – 42° (5.6°) Factory Set Point 38° (3.3°)  
 Lower Zone – Freezer: -10° (-23.3°) – 10° (-12.2°) Factory Set Point 0° (-17.8°)

UMRP

G5DZ24SL	24" Dual Zone Ref/Freezer, Drawers, G5 Luxe	<b>\$7,000</b>
----------	---	----------------



G5BD24SL

**G5 LUXE 24" BEVERAGE DISPENSER – 33°F (0.6°C) – 48°F (8.9°C)**

UMRP

G5BD4SL	24" Beverage Dispenser, Solid Door, Hinge Right	 <b>\$4,700</b>
---------	---	--

\*Dispensing kits and accessories sold separately, see page 17



# G5 COLLECTION DOOR AND PANEL OPTIONS

## SELECT YOUR PERFECT COMBINATION

All cabinets are panel-ready and field reversible. Must choose a solid door, glass door, or drawers, then complete the look with a Perlick stainless steel panel (sold separately). When using Custom panels (provided by you or your designer), door/drawer options and stainless steel panel are not required.

**G5 CABINET + DOOR**  
(Units come without panel)

**STAINLESS PANEL\***  
(Sold separately by Perlick)

or

**CUSTOM PANEL**  
(Provided by you or your designer)

**SOLID DOOR**



**GLASS DOOR**

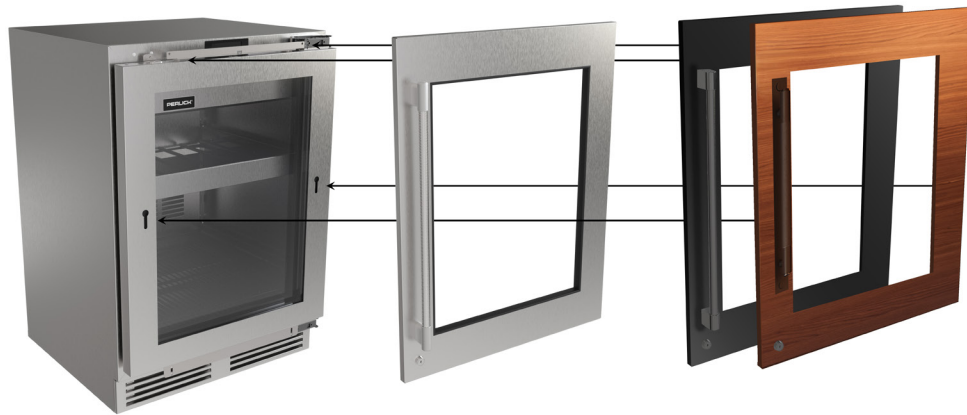

**DRAWERS**

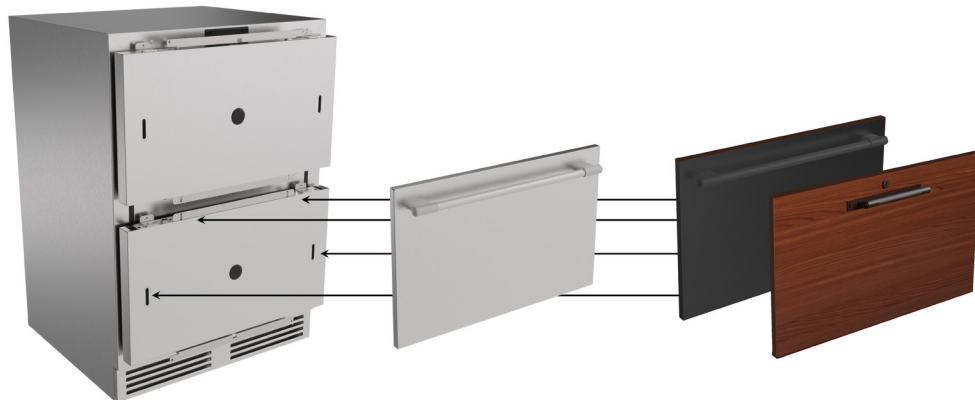

\*Stainless panel shown with Luxe premium knurled handle

# G5 COLLECTION PANEL MODELS

## LUXE PREMIUM PANELS WITH KNURLED HANDLE

300-series stainless steel panel with 304 stainless steel knurled grip cap & handle featuring Perlick's legacy emblem for a secure hold and timeless design



## CORE PANELS WITH TWO-TONE HANDLE

300-series stainless steel panel with Perlick's classic two-tone handle; made from zinc die cast end caps & stainless steel tube



## ALL G5 COLLECTION UNITS SHIP WITHOUT PANELS

Choose door and panel combination at time of order – solid door, glass door, or drawers with Perlick stainless steel panel (Luxe knurled or Core two-tone handle, locking or non-locking, right or left hinge) or your own custom panel



# G5 COLLECTION PANEL MODELS

	Model	Type	UMRP	Model	Type	UMRP
G5 COLLECTION PANELS	1056126	Premium Knurl Handle Overlay, Solid, Left, Locking	\$490	1056122	Two-Tone Handle Overlay, Solid, Left, Locking	\$400
	1056124	Premium Knurl Handle Overlay, Solid, Right, Locking	\$490	1056120	Two-Tone Handle Overlay, Solid, Right, Locking	\$400
	1056125	Premium Knurl Handle Overlay, Glass, Left, Locking	\$490	1056121	Two-Tone Handle Overlay, Glass, Left, Locking	\$400
	1056123	Premium Knurl Handle Overlay, Glass, Right, Locking	\$490	1056099	Two-Tone Handle Overlay, Glass, Right, Locking	\$400
	1056130	Premium Knurl Handle Overlay, Solid, Reversible, No Lock	\$460	1056128	Two-Tone Handle Overlay, Solid, Reversible, No Lock	\$370
	1056129	Premium Knurl Handle Overlay, Glass, Reversible, No Lock	\$460	1056127	Two-Tone Handle Overlay, Glass, Reversible, No Lock	\$370
	1056197	Premium Knurl Handle Overlay, Solid, Drawer Set, No Lock	\$960	1056195	Two-Tone Handle Overlay, Solid, Drawer Set, No Lock	\$780
	1056198	Premium Knurl Handle Overlay, Solid, Drawer Set, Locking	\$990	1056196	Two-Tone Handle Overlay, Solid, Drawer Set, Locking	\$810
	1056641	ADA Premium Knurl Handle Overlay, Glass, Reversible, No Lock	\$460	1056637	ADA Two-Tone Handle Overlay, Glass, Reversible, No Lock	\$370
	1056645	ADA Premium Knurl Handle Overlay, Solid, Left, No Lock	\$460	1056639	ADA Two-Tone Handle Overlay, Solid, Left, No Lock	\$370
	1056643	ADA Premium Knurl Handle Overlay, Solid, Right, No Lock	\$460	1056638	ADA Two-Tone Handle Overlay, Solid, Right, No Lock	\$370
	1056636	ADA Premium Knurl Handle Overlay, Solid, Left, Locking	\$490	1056628	ADA Two-Tone Handle Overlay, Solid, Left, Locking	\$400
	1056632	ADA Premium Knurl Overlay, Solid, Right, Locking	\$490	1056626	ADA Two-Tone Handle Overlay, Solid, Right, Locking	\$400
	1056634	ADA Premium Knurl Handle Overlay, Glass, Left, Locking	\$490	1056627	ADA Two-Tone Handle Overlay, Glass, Left, Locking	\$400
	1056630	ADA Premium Knurl Handle Overlay, Glass, Right, Locking	\$490	1056625	ADA Two-Tone Handle Overlay, Glass, Right, Locking	\$400
	1056201	ADA Premium Knurl Handle Overlay, Solid, Drawer Set, No Lock	\$960	1056199	ADA Two-Tone Handle Overlay, Solid, Drawer Set, No Lock	\$780
	1056202	ADA Premium Knurl Handle Overlay, Solid, Drawer Set, Locking	\$990	1056200	ADA Two-Tone Handle Overlay, Solid, Drawer Set, Locking	\$810
	1056640	15" Premium Knurl Handle Overlay, Glass, Reversible, No Lock	\$400			
	1056644	15" Premium Knurl Handle Overlay, Solid, Left, No Lock	\$400			
	1056642	15" Premium Knurl Overlay, Solid, Right, No Lock	\$400			
	1056635	15" Premium Knurl Handle Overlay, Solid, Left, Locking	\$420			
	1056631	15" Premium Knurl Handle Overlay, Solid, Right, Locking	\$420			
	1056633	15" Premium Knurl Handle Overlay, Glass, Left, Locking	\$420			
	1056629	15" Premium Knurl Handle Overlay, Glass, Right, Locking	\$420			
	1056204	15" Premium Knurl Handle Overlay, Solid, Drawer Set, No Lock	\$820			
1056205	15" Premium Knurl Handle Overlay, Solid, Drawer Set, Locking	\$850				

## OTHER ACCESSORIES

1056822	Kit, Accessory, Handle, Door, Knurled, UC, G5	<b>\$300</b>	1056372	Kit, Shelf, Wine, 24in, UC, G5	<b>\$340</b>
1056824	Kit, Accessory, Handle, Drawer, 24in, Knurled, UC, G5	<b>\$450</b>	1056373	Kit, Shelf, Coated Wire, Med Temp, 24in, UC, G5	<b>\$340</b>
1056825	Kit, Accessory, Handle, Drawer, 15in, Knurled, UC, G5	<b>\$400</b>	1056375	Kit, Shelf, Welded Ss, Shallow Depth 24in, UC, G5	<b>\$340</b>
1056826	Kit, Accessory, Handle, Door, Two-Tone, UC, G5	<b>\$200</b>	1056376	Kit, Shelf, Coated Wire, Shallow Depth 24in, UC, G5	<b>\$340</b>
1056827	Kit, Accessory, Handle, Drawer, 24in, Two-Tone, UC, G5	<b>\$300</b>	1056377	Kit, Shelf, Wine, Shallow Depth 24in, UC, G5	<b>\$340</b>
1056358	Kit, Shelf, Coated Wire, Low Temp, 24in, UC, G5	<b>\$340</b>	1056381	Kit, Shelf, Welded Ss, 15in, UC, G5	<b>\$440</b>
1056371	Kit, Shelf, Welded SS, 24in, UC, G5	<b>\$450</b>	1056382	Kit, Shelf, Wine, 15in, UC, G5	<b>\$330</b>

# G5 BEVERAGE DISPENSING ACCESSORIES

## BEVERAGE/COFFEE DISPENSER ACCESSORIES

TAPPING KITS		UMRP
66585-1	Single-faucet draft arm tapping kit	<b>\$1,530</b>
66585-2	Two-faucet draft arm tapping kit	<b>\$2,010</b>
69862-1	Single-faucet adara tapping kit	<b>\$1,660</b>
69862-2	Two-faucet adara tapping kit	<b>\$2,190</b>

COFFEE DISPENSING KITS		UMRP
RS-NDK	Perlick nitro dispensing kit, single infuser	<b>\$2,740</b>
RS-CDK	Iced coffee dispensing kit (includes parts, connections and nitrogen regulator)	<b>\$710</b>

- Kit includes all necessary components to dispense cold brew coffee from a Perlick refrigerator
- Kegs sold separately as part number RS-25KG
- For nitro cold brew, please see part RS-NDK



63927



650SS

BEVERAGE FAUCETS		UMRP
650SS	Stainless steel forward sealing faucet with flow control	<b>\$160</b>
63927	Stout faucet, brass, chrome plated body with stainless steel spout	<b>\$330</b>



308-40C



40030SSLD

KEG COUPLERS		UMRP
40030SSLD	Key coupler, low profile, D-style for domestic kegs	<b>\$240</b>
40030SSLS	Key coupler, low profile, S-style for imported kegs	<b>\$240</b>

## OTHER ACCESSORIES

2928F	Primary CO2 regulator	<b>\$250</b>
26161E	Secondary CO2 regulator	<b>\$230</b>
RS-NCY	Nitrogen cylinder, aluminum, 244 cu.in. interior volume	<b>\$220</b>
RS-25KG	2.5 Gallon standard keg	<b>\$430</b>
67782	Drip pan	<b>\$220</b>
63797	Beer dispenser cleaning kit (includes pump, sanitizer, and tools to clean lines)	<b>\$250</b>
BLC4	Sanitizer, beer dispenser 4 oz. bottle	<b>\$20</b>
BLC32	Sanitizer, beer dispenser 32 oz. bottle	<b>\$40</b>
67141-1	Perlick faucet handle	<b>\$120</b>
GT600	Growler filler tube	<b>\$30</b>





# COLUMN REFRIGERATION

Perlick's collection of single and dual-zone column appliances feature 24" and 30" Beverage Columns and Wine Reserve Columns — designed for precise temperature control and exceptional storage flexibility.

- Columns feature flush installation for full integration into surrounding cabinetry
- Touch screen control provides streamlined access to a variety of options
- Eye-catching mix of stainless steel interiors and vibrant white and blue lighting
- Dual zone models feature a state-of-the-art refrigeration system with two separate temperature zones, dual-chamber air filtration, and authentic humidity control
- Beverage Columns feature heavy duty, high capacity, stainless-steel shelving
- Wine models feature convertible display shelving and smart humidity
- Accessories include dual installation kit, side enclosure panels, etc.



# NOMENCLATURE

## HOW MODEL NUMBERS ARE BUILT

Example – 24" Column Dual-Zone Wine Column, Glass Overlay Door, Hinge Left, Lock Ready  
(Model No. CR24D-2-4LL)

\*All column products shown with panel (sold separately)

CR24D-2-4LL	C	=	COLUMN	CR24D-2-4LL	2	=	GENERATION 2
CR24D-2-4LL	R	=	REFRIGERATION	CR24D-2-4LL	4	=	PANEL READY GLASS DOOR*
CR24D-2-4LL	24	=	24" WIDE MODEL	30	=	30" WIDE MODEL	
CR24D-2-4LL	C	=	DUAL ZONE BEVERAGE	B	=	BEVERAGE	W = WINE RESERVE, SINGLE-ZONE
	D	=	WINE RESERVE, DUAL-ZONE				
CR24D-2-4LL	L	=	LEFT HINGE	R	=	RIGHT HINGE	
CR24D-2-4LL	L	=	LOCK READY				

## COLUMN REFRIGERATION MODELS



CR30B-2-4LL



CR30B-2-4LL



CR30C-2-4LL



CR30D-2-4LL

### 24" SINGLE ZONE BEVERAGE COLUMN – INDOOR

12.6 cu. ft. capacity

UMRP

CR24B-2-4LL	Glass door, overlay ready, hinged left	<b>\$10,500</b>
-------------	--	-----------------

CR24R-2-4RL	Glass door, overlay ready, hinged right	<b>\$10,500</b>
-------------	---	-----------------

### 24" DUAL ZONE BEVERAGE COLUMN – INDOOR

12.6 cu. ft. capacity

UMRP

CR24C-2-4RL	Glass door, overlay ready, hinged left	<b>\$11,550</b>
-------------	--	-----------------

CR24C-2-4LL	Glass door, overlay ready, hinged right	<b>\$11,550</b>
-------------	---	-----------------

### 24" SINGLE ZONE WINE COLUMN – INDOOR

12.6 cu. ft. capacity

UMRP

CR24W-2-4LL	Wine reserve, single-zone, glass overlay door, hinged left	<b>\$11,550</b>
-------------	--	-----------------

CR24W-2-4RL	Wine reserve, single-zone, glass overlay door, hinged right	<b>\$11,550</b>
-------------	---	-----------------

### 24" DUAL ZONE WINE COLUMN – INDOOR

12.6 cu. ft. capacity

UMRP

CR24D-2-4LL	Wine reserve, dual-zone, glass overlay door, hinged left	<b>\$12,600</b>
-------------	--	-----------------

CR24D-2-4RL	Wine reserve, dual-zone, glass overlay door, hinged right	<b>\$12,600</b>
-------------	---	-----------------

### 30" SINGLE ZONE BEVERAGE COLUMN – INDOOR

16.9 cu. ft. capacity

UMRP

CR30B-2-4LL	Glass door, overlay ready, hinged left	<b>\$11,550</b>
-------------	--	-----------------

CR30B-2-4RL	Glass door, overlay ready, hinged right	<b>\$11,550</b>
-------------	---	-----------------

### 30" DUAL ZONE BEVERAGE COLUMN – INDOOR

16.9 cu. ft. capacity

UMRP

CR30C-2-4RL	Glass door, overlay ready, hinged left	<b>\$12,600</b>
-------------	--	-----------------

CR30C-2-4LL	Glass door, overlay ready, hinged right	<b>\$12,600</b>
-------------	---	-----------------

### 30" SINGLE ZONE WINE COLUMN – INDOOR

16.9 cu. ft. capacity

UMRP

CR30W-2-4LL	Wine reserve, single-zone, glass overlay door, hinged left	<b>\$12,600</b>
-------------	--	-----------------

CR30W-2-4RL	Wine reserve, single-zone, glass overlay door, hinged right	<b>\$12,600</b>
-------------	---	-----------------

### 30" DUAL ZONE WINE COLUMN – INDOOR

16.9 cu. ft. capacity

UMRP

CR30D-2-4LL	Wine reserve, dual-zone, glass overlay door, hinged left	<b>\$13,650</b>
-------------	--	-----------------

CR30D-2-4RL	Wine reserve, dual-zone, glass overlay door, hinged right	<b>\$13,650</b>
-------------	---	-----------------

# COLUMN REFRIGERATION ACCESSORIES

## CR24 STAINLESS STEEL DOOR PANELS (4" TOE KICK, LESS LOCK)

UMRP

CR-SG-24PDL4	24" Stainless steel glass door panel left hinge with Perlick two tone handle	<b>\$920</b>
CR-SG-24PDR4	24" Stainless steel glass door panel right hinge with Perlick two tone handle	<b>\$920</b>

## CR24 STAINLESS STEEL DOOR PANELS (6" TOE KICK, LESS LOCK)

UMRP

CR-SG-24PDL6	24" Stainless steel glass door panel left hinge with Perlick two tone handle	<b>\$920</b>
CR-SG-24PDR6	24" Stainless steel glass door panel right hinge with Perlick two tone handle	<b>\$920</b>

## CR30 STAINLESS STEEL DOOR PANELS (4" TOE KICK, LESS LOCK)

UMRP

CR-SG-30PDL4	30" Stainless steel glass door panel left hinge with Perlick two tone handle	<b>\$1,180</b>
CR-SG-30PDR4	30" Stainless steel glass door panel right hinge with Perlick two tone handle	<b>\$1,180</b>

## CR30 STAINLESS STEEL DOOR PANELS (6" TOE KICK, LESS LOCK)

UMRP

CR-SG-30PDL6	30" Stainless steel glass door panel left hinge with Perlick two tone handle	<b>\$1,180</b>
CR-SG-30PDR6	30" Stainless steel glass door panel right hinge with Perlick two tone handle	<b>\$1,180</b>

## PRO HANDLE

UMRP

CR-PRO-HANDLE	Two tone Perlick pro handle (only when sold separately from stainless steel door panels)	<b>\$240</b>
---------------	--	--------------

## BUILT-IN TRIM KIT

UMRP

CR-ACC-TRIM	Left and right finish trim kit for built-in units	<b>\$170</b>
-------------	---	--------------

## AIR/ETHYLENE FILTER KITS

UMRP

CR-ACC-FILTER-C	Replacement carbon filter.	<b>\$70</b>
CR-ACC-FILTER-E	Replacement ethylene filter.	<b>\$70</b>

## DUAL INSTALLATION KITS

UMRP

CR-ACC-D1	Dual installation kit. Handle-to-handle or hinge-to-hinge. Includes anti-sweat heater.	<b>\$510</b>
CR-ACC-D1N	Dual installation kit. Handle-to-handle or hinge-to-hinge. No heater.	<b>\$410</b>
CR-ACC-D2N	Dual installation kit. Hinge-to-handle. No heater.	<b>\$410</b>

# SIGNATURE SERIES UNDERCOUNTER REFRIGERATION

Built on decades of innovation, the Signature Series offers exceptional performance and versatility in a range of sizes and styles for indoor, outdoor, or marine applications.





## SIGNATURE SERIES MODEL NUMBER NOMENCLATURE

BELOW IS A GUIDE TO HOW PERLICK UNDERCOUNTER MODEL NUMBERS ARE BUILT.

The following breakdown is for a 24" Signature Series Indoor Refrigerator with stainless steel glass door, hinged left (Model No. HP24RS-4-3L).

HP24RS-4-3L	H = Home products		
HP24RS-4-3L	P = Perlick Signature	C = Commercial	
	H = Shallow depth	A = ADA Compliant	
HP24RS-4-3L	15 = 15" wide model	24 = 24" wide model	
HP24RS-4-3L	F = Freezer	C = DZ Refrigerator/ wine reserve	D = DZ Wine reserve
	Z = DZ Freezer/Refrigerator	B = Beverage center	T = Beer dispenser
	R = Refrigerator	W = Wine reserve	
HP24RS-4-3L	S = Stand alone (SS exterior, Indoor)	B = Built-in (Vinyl-clad exterior, Indoor)	O = Outdoor (SS exterior) M = Marine Grade SS exterior
HP24RS-4-3L	4 = Generation 4		
HP24RS-4-3L	1 = Stainless steel solid door	3 = Stainless steel glass door	5 = Stainless steel drawers
	2 = Panel ready solid door*	4 = Panel ready glass door*	6 = Panel ready drawers*
HP24RS-4-3L	L = Left hinge	R = Right hinge	
HP24RS-4-3LL	L = Lock	DL = Drawer Lock	





## PERLICK'S MARINE AND COASTAL GRADE UNDERCOUNTER REFRIGERATION WITH PERLICK ARMOR™

Customers asked. We listened. Perlick created an upgraded version of our best-in-class undercounter refrigeration line designed to tackle the elements. Whether you own a home in coastal conditions, a boat, or a saltwater pool, the harsh effects of high-salt environments can wreak havoc and prematurely weather outdoor appliances. Perlick's **Marine and Coastal Grade Undercounter Refrigeration** featuring **Perlick Armor™** is built to endure the harshest environments while maintaining the consistent functionality and showroom quality finish you've come to expect from Perlick.

- Combines a mix of 316 and 304 stainless steel for food safety and easy cleaning rather than plastics, which can be found in some marine grade products
- A protective coating is applied to the refrigeration system for increased durability
- Units come equipped with upgraded 18-8 stainless steel and zinc plated fasteners to ensure rust won't form in attachment zones
- Our Perlick Armor™ upgrade package is available on all our HP and HH Series residential models

## PERLICK 24" SIGNATURE SERIES MARINE GRADE

Perlick's 24" Signature Series Marine and Coastal Undercounter Refrigeration offers a wide selection of storage options for food and beverages in your outdoor kitchen or entertaining space and features Perlick Armor™, an exclusive materials upgrade to protect against corrosion in the harshest environments. It is designed for life in the most extreme conditions, so you can enjoy the ultimate in refrigeration wherever you find paradise.

- Superior construction provides ideal combination of energy-efficient operation and powerful refrigeration performance ideal for food and beverages
- 1000 BTU/hr capacity delivers industry's most energy-efficient cool down
- Mix of all 316 and 304 stainless steel for optimal corrosion resistance food and beverage storage safety
- Upgraded 18-8 stainless steel and zinc plated fasteners ensure rust won't form in attachment zones
- E-coated condensers add durability to the refrigeration system in the most extreme conditions
- Perlick Anti-Condensation System™ eliminates condensation from forming on the cabinet for installations in high-humidity environments
- Full-extension shelving provides faster and safer product access with no reaching into the back of the cabinet
- Audible door alarm warns user if door is held open
- Select between **crisp white** and **cool blue** LED lighting
- Available with or without door locks (see page 4 for model number key)



HP24FM-4-1L

HP24FM-4-5

### 24" UNDERCOUNTER FREEZER – MARINE

		UMRP
HP24FM-4-1L	Freezer, stainless steel solid door, hinged left	\$7,010
HP24FM-4-1R	Freezer, stainless steel solid door, hinged right	\$7,010
HP24FM-4-2L	Freezer, panel ready solid door, hinged left	\$6,840
HP24FM-4-2R	Freezer, panel ready solid door, hinged right	\$6,840
HP24FM-4-5	Freezer drawers, stainless steel	\$7,840
HP24FM-4-6	Freezer drawers, panel ready	\$7,660



HP24RM-4-1L

HP24RM-4-3L

### 24" UNDERCOUNTER REFRIGERATOR – MARINE

		UMRP
HP24RM-4-1L	Refrigerator, stainless steel solid door, hinged left	\$6,570
HP24RM-4-1R	Refrigerator, stainless steel solid door, hinged right	\$6,570
HP24RM-4-2L	Refrigerator, panel ready solid door, hinged left	\$6,390
HP24RM-4-2R	Refrigerator, panel ready solid door, hinged right	\$6,390
HP24RM-4-3L	Refrigerator, stainless steel glass door, hinged left	\$6,790
HP24RM-4-3R	Refrigerator, stainless steel glass door, hinged right	\$6,790
HP24RM-4-4L	Refrigerator, panel ready glass door, hinged left	\$6,610
HP24RM-4-4R	Refrigerator, panel ready glass door, hinged right	\$6,610
HP24RM-4-5	Refrigerator drawers, stainless steel	\$7,390
HP24RM-4-6	Refrigerator drawers, panel ready	\$7,210



HP24RM-4-5



HP24ZM-4-5

**24" UNDERCOUNTER DUAL-ZONE FREEZER/REFRIGERATOR DRAWERS – MARINE**

		UMRP
HP24ZM-4-5	Dual-zone freezer/refrigerator drawers, stainless steel	<b>E \$8,750</b>
HP24ZM-4-6	Dual-zone freezer/refrigerator drawers, panel ready	<b>E \$8,580</b>



HP24CM-4-1L



HP24CM-4-3L

**24" UNDERCOUNTER DUAL-ZONE REFRIGERATOR/WINE RESERVE – MARINE**

		UMRP
HP24CM-4-1L	Dual-zone refrigerator/wine reserve, stainless steel solid door, hinged left	<b>E \$7,700</b>
HP24CM-4-1R	Dual-zone refrigerator/wine reserve, stainless steel solid door, hinged right	<b>E \$7,700</b>
HP24CM-4-2L	Dual-zone refrigerator/wine reserve, panel ready solid door, hinged left	<b>E \$7,510</b>
HP24CM-4-2R	Dual-zone refrigerator/wine reserve, panel ready solid door, hinged right	<b>E \$7,510</b>
HP24CM-4-3L	Dual-zone refrigerator/wine reserve, stainless steel glass door, hinged left	<b>E \$7,910</b>
HP24CM-4-3R	Dual-zone refrigerator/wine reserve, stainless steel glass door, hinged right	<b>E \$7,910</b>
HP24CM-4-4L	Dual-zone refrigerator/wine reserve, panel ready glass door, hinged left	<b>E \$7,740</b>
HP24CM-4-4R	Dual-zone refrigerator/wine reserve, panel ready glass door, hinged right	<b>E \$7,740</b>











HP24BM-4-1L



HP24BM-4-3L

**24" UNDERCOUNTER BEVERAGE CENTER – MARINE**

		UMRP
HP24BM-4-1L	Beverage center, stainless steel solid door, hinged left	 <b>\$6,650</b>
HP24BM-4-1R	Beverage center, stainless steel solid door, hinged right	 <b>\$6,650</b>
HP24BM-4-2L	Beverage center, panel ready solid door, hinged left	 <b>\$6,460</b>
HP24BM-4-2R	Beverage center, panel ready solid door, hinged right	 <b>\$6,460</b>
HP24BM-4-3L	Beverage center, stainless steel glass door, hinged left	 <b>\$6,860</b>
HP24BM-4-3R	Beverage center, stainless steel glass door, hinged right	 <b>\$6,860</b>
HP24BM-4-4L	Beverage center, panel ready glass door, hinged left	 <b>\$6,680</b>
HP24BM-4-4R	Beverage center, panel ready glass door, hinged right	 <b>\$6,680</b>



HP24WM-4-1L



HP24WM-4-3L

**24" UNDERCOUNTER SINGLE-ZONE WINE RESERVE – MARINE**

		UMRP
HP24WM-4-1L	Single-zone wine reserve, stainless steel solid door, hinged left	<b>\$7,080</b>
HP24WM-4-1R	Single-zone wine reserve, stainless steel solid door, hinged right	<b>\$7,080</b>
HP24WM-4-2L	Single-zone wine reserve, panel ready solid door, hinged left	<b>\$6,900</b>
HP24WM-4-2R	Single-zone wine reserve, panel ready solid door, hinged right	<b>\$6,900</b>
HP24WM-4-3L	Single-zone wine reserve, stainless steel glass door, hinged left	<b>\$7,290</b>
HP24WM-4-3R	Single-zone wine reserve, stainless steel glass door, hinged right	<b>\$7,290</b>
HP24WM-4-4L	Single-zone wine reserve, panel ready glass door, hinged left	<b>\$7,120</b>
HP24WM-4-4R	Single-zone wine reserve, panel ready glass door, hinged right	<b>\$7,120</b>



HP24DM-4-1L



HP24DM-4-3L

24" UNDERCOUNTER DUAL-ZONE WINE RESERVE – MARINE

UMRP

HP24DM-4-1L	Dual-zone wine reserve, stainless steel solid door, hinged left	\$7,770
HP24DM-4-1R	Dual-zone wine reserve, stainless steel solid door, hinged right	\$7,770
HP24DM-4-2L	Dual-zone wine reserve, panel ready solid door, hinged left	\$7,260
HP24DM-4-2R	Dual-zone wine reserve, panel ready solid door, hinged right	\$7,260
HP24DM-4-3L	Dual-zone wine reserve, stainless steel glass door, hinged left	\$7,650
HP24DM-4-3R	Dual-zone wine reserve, stainless steel glass door, hinged right	\$7,650
HP24DM-4-4L	Dual-zone wine reserve, panel ready glass door, hinged left	\$7,490
HP24DM-4-4R	Dual-zone wine reserve, panel ready glass door, hinged right	\$7,490











HP24TMO-4-1L-1



HP24TM-4-1L-2

24" UNDERCOUNTER BEER DISPENSER – MARINE

UMRP

HP24TM-4-1L-1	Beer dispenser, single tap, stainless steel solid door, hinged left	 \$7,400
HP24TM-4-1R-1	Beer dispenser, single tap, stainless steel solid door, hinged right	 \$7,400
HP24TM-4-2L-1	Beer dispenser, single tap, panel ready solid door, hinged left	 \$7,600
HP24TM-4-2R-1	Beer dispenser, single tap, panel ready solid door, hinged right	 \$7,600
HP24TM-4-1L-2	Beer dispenser, two tap, stainless steel solid door, hinged left	 \$8,310
HP24TM-4-1R-2	Beer dispenser, two tap, stainless steel solid door, hinged right	 \$8,310
HP24TM-4-2L-2	Beer dispenser, two tap, panel ready solid door, hinged left	 \$8,120
HP24TM-4-2R-2	Beer dispenser, two tap, panel ready solid door, hinged right	 \$8,120



### PERLICK SIGNATURE SERIES SHALLOW DEPTH MARINE

Perlick’s industry-exclusive 18" depth Signature Series Shallow Depth Marine Grade refrigeration provides storage for shallow depth outdoor spaces that can’t accommodate a traditional 24" depth. Its 32" height and ADA compliant design makes it perfect for accessible and aging-in-place designs. Its unique slim profile makes this model a designer favorite because of its incredible versatility. UL-rated for outdoor use.

- Superior construction provides a combination of energy-efficient operation and powerful refrigeration performance ideal for food and beverages
- 1000 BTU/hr capacity delivers the industry’s most energy-efficient cool down, indoors or outdoors
- Mix of all 316 and 304 stainless steel for optimal corrosion resistance food and beverage storage safety
- Upgraded 18-8 stainless steel and zinc plated fasteners ensure rust won’t form in attachment zones
- E-coated condensers add durability to the refrigeration system in the most extreme conditions
- Perlick Anti-Condensation System™ eliminates condensation from forming on the cabinet for installations in high-humidity environments
- Full-extension shelving provides faster and safer product access with no reaching into the back of the cabinet
- Digital control with audible door alarm
- Select between **crisp white** and **cool blue** LED lighting
- Available with or without door locks (see page 4 for model number key)



HH24RM-4-1R



HH24RM-4-3R

#### UNDERCOUNTER 18" DEPTH REFRIGERATOR – MARINE

			UMRP
HH24RM-4-1L	Refrigerator, stainless steel solid door, hinged left	E	\$5,800
HH24RM-4-1R	Refrigerator, stainless steel solid door, hinged right	E	\$5,800
HH24RM-4-2L	Refrigerator, panel ready solid door, hinged left	E	\$5,620
HH24RM-4-2R	Refrigerator, panel ready solid door, hinged right	E	\$5,620
HH24RM-4-3L	Refrigerator, stainless steel glass door, hinged left	E	\$6,010
HH24RM-4-3R	Refrigerator, stainless steel glass door, hinged right	E	\$6,010
HH24RM-4-4L	Refrigerator, panel ready glass door, hinged left	E	\$5,830
HH24RM-4-4R	Refrigerator, panel ready glass door, hinged right	E	\$5,830



HH24BM-4-1R



HH24BM-4-3R

#### UNDERCOUNTER 18" DEPTH BEVERAGE CENTER – MARINE

			UMRP
HH24BM-4-1L	Beverage center, stainless steel solid door, hinged left	E	\$5,870
HH24BM-4-1R	Beverage center, stainless steel solid door, hinged right	E	\$5,870
HH24BM-4-2L	Beverage center, panel ready solid door, hinged left	E	\$5,690
HH24BM-4-2R	Beverage center, panel ready solid door, hinged right	E	\$5,690
HH24BM-4-3L	Beverage center, stainless steel glass door, hinged left	E	\$6,090
HH24BM-4-3R	Beverage center, stainless steel glass door, hinged right	E	\$6,090
HH24BM-4-4L	Beverage center, panel ready glass door, hinged left	E	\$5,920
HH24BM-4-4R	Beverage center, panel ready glass door, hinged right	E	\$5,920



HH24WM-4-1R



HH24WM-4-3R

## UNDERCOUNTER 18" DEPTH WINE RESERVE – MARINE

		UMRP
HH24WM-4-1L	Wine reserve, stainless steel solid door, hinged left	E \$6,030
HH24WM-4-1R	Wine reserve, stainless steel solid door, hinged right	E \$6,030
HH24WM-4-2L	Wine reserve, panel ready solid door, hinged left	E \$5,840
HH24WM-4-2R	Wine reserve, panel ready solid door, hinged right	E \$5,840
HH24WM-4-3L	Wine reserve, stainless steel glass door, hinged left	E \$6,240
HH24WM-4-3R	Wine reserve, stainless steel glass door, hinged right	E \$6,240
HH24WM-4-4L	Wine reserve, panel ready glass door, hinged left	E \$6,050
HH24WM-4-4R	Wine reserve, panel ready glass door, hinged right	E \$6,050



## PERLICK 15" SIGNATURE SERIES MARINE GRADE

Perlick’s 15" Signature Series Marine and Coastal undercounter refrigeration is perfect for storing a variety of food and beverages in small outdoor spaces and features Perlick Armor™, an exclusive materials upgrade to protect against corrosion in the harshest environments. It’s designed for life in the most extreme conditions, so you can enjoy the ultimate in refrigeration wherever you find paradise.

- Superior construction provides a combination of energy-efficient operation and powerful refrigeration performance ideal for food and beverages
- 1000 BTU/hr capacity delivers the industry’s most energy-efficient cool down, indoors or outdoors
- Mix of all 316 and 304 stainless steel for optimal corrosion resistance and food and beverage storage safety
- Upgraded 18–8 stainless steel and zinc plated fasteners ensure rust won’t form in attachment zones
- E-coated condensers add durability to the refrigeration system in the most extreme conditions
- Commercial-grade all stainless steel interior and marine-grade stainless steel exterior provide superior durability and easy cleaning
- Full-extension shelving provides faster and safer product access with no reaching into the back of the cabinet
- Perlick Anti-Condensation System™ eliminates condensation from forming on the cabinet for installations in high-humidity environments
- Digital control with audible door alarm
- Select between **crisp white** and **cool blue** LED lighting
- Available with or without door locks (see page 4 for model number key)



### 15" UNDERCOUNTER REFRIGERATOR – MARINE

		UMRP
HP15RM-4-1L	Refrigerator, stainless steel solid door, hinged left	\$6,240
HP15RM-4-1R	Refrigerator, stainless steel solid door, hinged right	\$6,240
HP15RM-4-2L	Refrigerator, panel ready solid door, hinged left	\$6,050
HP15RM-4-2R	Refrigerator, panel ready solid door, hinged right	\$6,050
HP15RM-4-3L	Refrigerator, stainless steel glass door, hinged left	\$6,440
HP15RM-4-3R	Refrigerator, stainless steel glass door, hinged right	\$6,440
HP15RM-4-4L	Refrigerator, panel ready glass door, hinged left	\$6,260
HP15RM-4-4R	Refrigerator, panel ready glass door, hinged right	\$6,260
HP15RM-4-5	Refrigerator drawers, stainless steel	E  \$7,060
HP15RM-4-6	Refrigerator drawers, panel ready	E  \$6,870



HP15BM-4-1L



HP15BM-4-3L

**15" UNDERCOUNTER BEVERAGE CENTER – MARINE**

UMRP

HP15BM-4-1L	Beverage center, stainless steel solid door, hinged left	E	<b>\$6,300</b>
HP15BM-4-1R	Beverage center, stainless steel solid door, hinged right	E	<b>\$6,300</b>
HP15BM-4-2L	Beverage center, panel ready solid door, hinged left	E	<b>\$6,120</b>
HP15BM-4-2R	Beverage center, panel ready solid door, hinged right	E	<b>\$6,120</b>
HP15BM-4-3L	Beverage center, stainless steel glass door, hinged left	E	<b>\$6,530</b>
HP15BM-4-3R	Beverage center, stainless steel glass door, hinged right	E	<b>\$6,530</b>
HP15BM-4-4L	Beverage center, panel ready glass door, hinged left	E	<b>\$6,350</b>
HP15BM-4-4R	Beverage center, panel ready glass door, hinged right	E	<b>\$6,350</b>



HP15WM-4-1L



HP15WM-4-3L

**15" UNDERCOUNTER WINE RESERVE – MARINE**

UMRP

HP15WM-4-1L	Wine reserve, stainless steel solid door, hinged left		<b>\$6,590</b>
HP15WM-4-1R	Wine reserve, stainless steel solid door, hinged right		<b>\$6,590</b>
HP15WM-4-2L	Wine reserve, panel ready solid door, hinged left		<b>\$6,420</b>
HP15WM-4-2R	Wine reserve, panel ready solid door, hinged right		<b>\$6,420</b>
HP15WM-4-3L	Wine reserve, stainless steel glass door, hinged left		<b>\$6,820</b>
HP15WM-4-3R	Wine reserve, stainless steel glass door, hinged right		<b>\$6,820</b>
HP15WM-4-4L	Wine reserve, panel ready glass door, hinged left		<b>\$6,640</b>
HP15WM-4-4R	Wine reserve, panel ready glass door, hinged right		<b>\$6,640</b>



HP15TM-4-1L-1

**15" UNDERCOUNTER BEER DISPENSER – MARINE**

UMRP

HP15TM-4-1L-1	Beer dispenser, stainless steel solid door, hinged left		<b>\$7,430</b>
HP15TM-4-1R-1	Beer dispenser, stainless steel solid door, hinged right		<b>\$7,430</b>
HP15TM-4-2L-1	Beer dispenser, panel ready solid door, hinged left		<b>\$7,250</b>
HP15TM-4-2R-1	Beer dispenser, panel ready solid door, hinged right		<b>\$7,250</b>



## PERLICK CLEAR ICE MAKERS INDOOR/OUTDOOR

A beverage is only as good as the ice that keeps it cold. That’s why Perlick’s clear ice makers produce unique, top hat-shaped ice. Not only is it attractive, but it also ensures that each and every cube is free of impurities. NSF-approved.

- Produces 51 lbs of clear ice per 24 hours
- Storage capacity of 22 lbs of clear ice
- Top hat-shaped ice
- Indoor/outdoor model
- Ice scoop included
- Optional stainless steel toe kick available
- Factory installed drain pump
- Full 2-year warranty
- Dimensions: 15"W x 23"D x 33-1/2"H

Top Hat Shaped Cubes

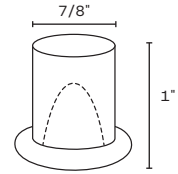

Ample Storage for 22 lbs of Ice



NSF Approved



HP15CI-1R

### 15" UNDERCOUNTER SIGNATURE SERIES CLEAR ICE MAKER – INDOOR/OUTDOOR

		UMRP
HP15CI-L	Clear ice maker, stainless steel solid door, hinged left	\$5,510
HP15CI-R	Clear ice maker, stainless steel solid door, hinged right	\$5,510
HP15CI-W	Clear ice maker, panel ready door, hinge reversible	\$5,510



HA15CI-1L

### 15" UNDERCOUNTER ADA CLEAR ICE MAKER – INDOOR/OUTDOOR

		UMRP
HA15CI-L	Clear ice maker, stainless steel solid door, hinged left	\$5,510
HA15CI-R	Clear ice maker, stainless steel solid door, hinged right	\$5,510
HA15CI-W	Clear ice maker, panel ready door, hinge reversible	\$5,510



Top hat-shaped ice



## PERLICK CUBELET ICE MAKERS INDOOR/OUTDOOR

Perlick's cubelet ice maker produces chewable, nugget-shaped ice. This ice is compacted to easily absorb the flavors of the beverages you pour over it and makes it easy to crunch. It's the perfect addition to any indoor or outdoor entertainment space.

- Produces 80 lbs of clear ice per 24 hours
- Storage capacity of 22 lbs of clear ice
- Cubelet-shaped ice
- Indoor/outdoor model
- Ice scoop included
- Optional stainless steel toe kick available
- Factory installed drain pump
- Full 2-year warranty
- Dimensions: 15"W x 23"D x 33-1/2"H

Pellet/Nugget Shaped Cubes

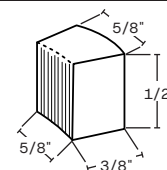

Ample Storage for 22 lbs of Ice



NSF Approved



HP15CU-1R

### 15" UNDERCOUNTER SIGNATURE SERIES CUBELET ICE MAKER – INDOOR/OUTDOOR

		UMRP
HP15CU-L	Cubelet ice maker, stainless steel solid door, hinged left	\$5,830
HP15CU-R	Cubelet ice maker, stainless steel solid door, hinged right	\$5,830
HP15CU-W	Cubelet ice maker, panel ready door, hinge reversible	\$5,830



HA15CU-1L

### 15" UNDERCOUNTER ADA CUBELET ICE MAKER – INDOOR/OUTDOOR

		UMRP
HA15CU-L	Cubelet ice maker, stainless steel solid door, hinged left	\$5,830
HA15CU-R	Cubelet ice maker, stainless steel solid door, hinged right	\$5,830
HA15CU-W	Cubelet ice maker, panel ready door, hinge reversible	\$5,830



Cubelet-shaped ice



# TOBIN ELLIS MOBILE BAR

Perlick's Tobin Ellis Residential Mobile Bars bring the best designs featured at the world's top bars and restaurants to the comfort of your own home. Styles for indoor, outdoor, or marine applications.





## TOBIN ELLIS LIMITED EDITION MOBILE BAR

Perlick's Tobin Ellis Residential Mobile Bars bring the best designs featured at the world's top bars and restaurants to the comfort of your own home! Perlick's line of mobile bars will elevate your home entertaining experience while making you feel like a professional mixologist utilizing our "bartender cockpit" design and luxury finishes.

- Luxury finishing with **eco-friendly recycled leather in Toffee Crocodile** complementing the chic **off-white Vanilla Sugar solid surface bar top** with custom smooth, rounded edges and corners for added comfort
- The bar counter features an **extra large inlaid 8" work board in a beautiful antique copper finish**, enhancing the grandeur aesthetic while keeping the bar surface clean and free of drips and spills
- Extend your celebrations into the night with **undercounter LED task lighting** so you can continue toasting with friends in low light settings
- Adds **ultimate flexibility**: move the Limited Edition Mobile Bar to your outdoor entertaining space for a patio party, then move back indoors to store
- Add ample capacity for any size soiree: capable of storing **up to 27 liters, 36 pieces of glassware, 40 cans or bottles of soda/beer, 3 types of ice, and more** depending on set up – all hidden from your guests' line of sight so they can focus on your beautiful setting

Inlaid Copper Workboard



Ample capacity for 3 types of ice



NSF-Approved



### 70" TOBIN ELLIS LIMITED EDITION MOBILE BAR – INDOOR/OUTDOOR

UMRP

RMB-001

Tobin Ellis Limited Edition Mobile Bar – 70"  
Two drainboards, bottle well, ice chest, and bottle rail

\$ 24,360



Eco-friendly toffee crocodile recycled leather

## TOBIN ELLIS MOBILE BARS

The **Tobin Ellis Mobile Bar** will help you elevate your home entertaining experience and transform into a mixologist through design with high-end home entertaining in mind.

- Easily move the bar anywhere inside or outside of your home for expanding your upscale home entertaining needs
- Two drainboards, insulated bottle well, insulated ice chest, and bottle rail
- Available in 46", 70" with 2 drainboards, and 70" with hand sink configurations

### All Tobin Ellis Mobile Bars feature:

- Black laminate exterior with white quartz engineered solid surface top
- Ample lower storage area for glasses, dry goods, canned goods, or beverages
- LED task lighting for operating in the evening and low light settings
- 42" Stainless speed rail that holds up to 20 standard liquor bottles
- 30" Insulated ice chest with sliding cover to store plenty of ice for any occasion
- 12" Insulated bottle well to store juices, syrups, mix, etc. in ice to keep chilled for serving
- Ice melt drainage tank to capture and easily remove draining water
- Locking 5" 304 stainless steel casters, for corrosion resistance, with polyurethane tread

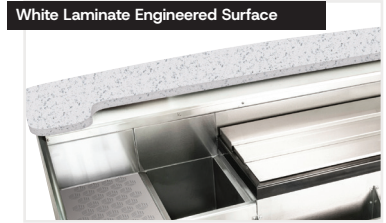

NSF Approved



RMB-002

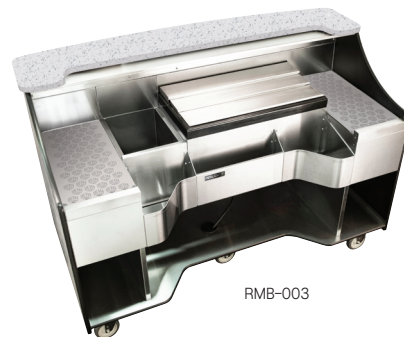

RMB-003

### 70" TOBIN ELLIS MOBILE BAR – INDOOR/OUTDOOR

		UMRP
RMB-002	<b>Tobin Ellis Mobile Bar – 70" With Sink:</b> One drainboard, bottle well, ice chest, bottle rail, hand wash sink, hot water heater	<b>\$22,470</b>
RMB-003	<b>Tobin Ellis Signature Series Mobile Bar – 70":</b> Two drainboards, bottle well, ice chest, and bottle rail	<b>\$19,060</b>



RMB-004

### 46" TOBIN ELLIS MOBILE BAR – INDOOR/OUTDOOR

		UMRP
RMB-004	<b>Tobin Ellis Mobile Bar – 46":</b> Bottle well, ice chest, and bottle rail	<b>\$13,920</b>

## PERLICK MOBILE TAP

Superior dispensing equipment paired with premium, commercial-grade refrigeration offers the ultimate combination for a durable and reliable system you can trust to deliver the perfect pour.

- **Two-faucet draft arm dispenses the following combinations of beverages:**
  - Nitro and cold brew coffee or wine
  - Beer and wine
  - Two varieties of wine
  - Two varieties of beer
- Kit includes a 24" refrigeration unit, two-faucet draft arm, all dispensing equipment, and casters for ease of mobility
- Forced-air refrigeration technology ensures consistent temperature throughout the entire keg and tower, maintaining flavor and minimizing foam
- Quick disconnect kegs included with HP24TS-2MNC
- Includes two low profile couplers (HP24TS-2MNC includes one coupler and two sets of quick disconnects with kegs)
- Large, easy-to-move casters offer flexibility to move the dispensing unit where needed
- Locking refrigeration door prevents tampering with components and beverages inside the unit



NSF-Approved



HP24TS-2MBW  
HP24TS-2MWW  
HP24TS-2MBB



HP24TS-2MNC  
Inside View of  
Nitro Coffee or Wine

PERLICK MOBILE TAP CONFIGURATIONS

Nitro and Coffee (HP24TS-2MNC)	Wine (HP24TS-2MBW)	Beer and Wine (HP24TS-2MWW)	Beer (HP24TS-2MBB)
24" Refrigeration Unit (HP24) • 2 Faucet Draft Arm Dispensing Kit • 3-3/4" Casters			
Nitrogen Regulator • Nitrogen Cylinder		CO2 Regulator • CO2 Cylinder	
(2) Quick Disconnects + 2.5 gallon kegs (1) Low Profile Coupler	(2) Low Profile Couplers		
(1) Stout Faucet (1) 630SS Faucet	(2) 630SS Faucets		
Nitro Infuser (1 Tap)			

PERLICK MOBILE TAP

		UMRP
HP24TS-2MNC	24" Mobile tap, 2 faucet nitro and cold brew with wine dispensing kit with casters	<b>\$10,440</b>
HP24TS-2MWW	24" Mobile tap, 2 faucet wine dispensing kit with casters	<b>\$6,720</b>
HP24TS-2MBW	24" Mobile tap, 2 faucet beer and wine dispensing kit with casters	<b>\$7,040</b>
HP24TS-2MBB	24" Mobile tap, 2 faucet beer dispensing kit with casters	<b>\$6,620</b>



## HOW IT WORKS

- Dispensing heads are attached directly to or just above the refrigerator
- The number of beverages corresponds to the size of your refrigeration unit
- A 24" refrigerator holds two 1/6-barrel kegs, while a 15" unit holds one

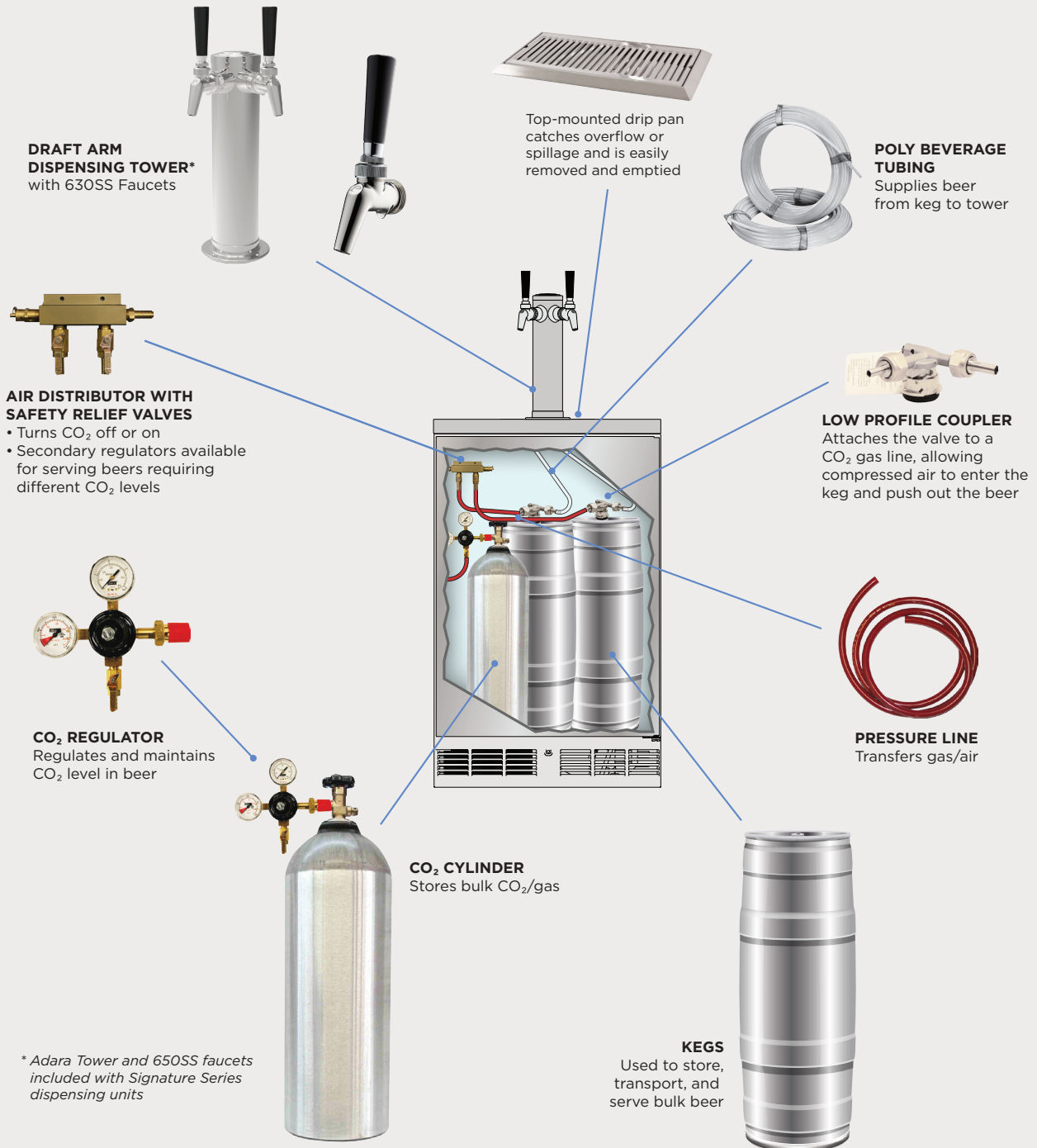

## BEER BASICS – TROUBLESHOOTING INFO

When you're expecting a full-bodied brew, a foamy or flat beer just won't do. If you experience excessive foam or no foam at all, chances are there is a quick and easy fix that will get you back to pouring the perfect beer in no time. Below are some of the most common beer dispenser problems and their solutions.

### PROBLEM: No beer is coming out of the tap

- **Check the gauge** to see if there is any pressure showing. It should read between 10–12 lbs. If not, your CO<sub>2</sub> tank may be empty.
- **Is the shut-off valve in the vertical (on) position?**  
*Note: Diagram shows the valve in the off position (horizontal).*

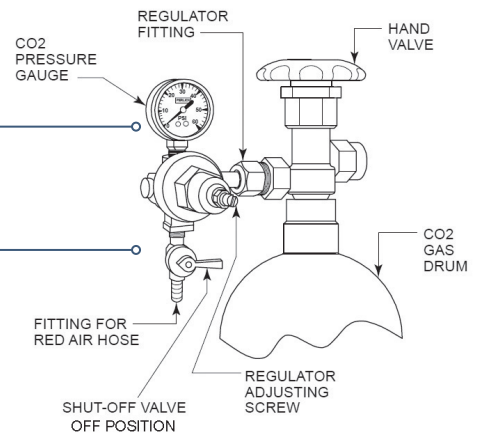

### PROBLEM: Flat beer

- **Check the gauge.** Is the pressure between 10–12 lbs? If not, turn the pressure up to its appropriate level. Low pressure can cause beer to flatten and pour slowly.
- **Dirty glassware will cause the head on a beer to quickly disappear.** Make sure your glassware is free of impurities before pouring.



### PROBLEM: Foamy beer

- **Check the gauge.** Is the pressure between 10–12 lbs? If not, turn the pressure down to its appropriate level. Pressure that is too high can cause beer to over carbonate in the keg and pour foamy.
- **Is the unit plugged in and cold?** Is the keg cold or, if purchased at room temperature, has it been in the dispenser for at least 24 hours? Attempting to tap a warm keg in a refrigerated unit will cause excessive foaming. Keep the temperature in the unit 36°–42°F, and make sure the keg is properly chilled before tapping.
- **Have you cleaned the equipment lately?** Regular cleaning of the system – from faucet to keg coupler – is important to keep beer stone, bacteria, and mold from building up. The factors listed above can quickly ruin a perfect brew!

36°-42°F



## WITH FORWARD SEALING FAUCETS, YOU'LL NEVER LOOK BACK

- 304 stainless steel construction won't pit or tarnish
- The flavor of the beverage will not be tainted
- Patented forward sealing design eliminates the need for a valve shaft exposed to beer and air
- Spout angle is more vertical, allowing more thorough draining after each pour
- No horizontal area for beer to collect
- NSF-approved



Perlick's patented, forward sealing design eliminates the need for a valve shaft exposed to beer and air.

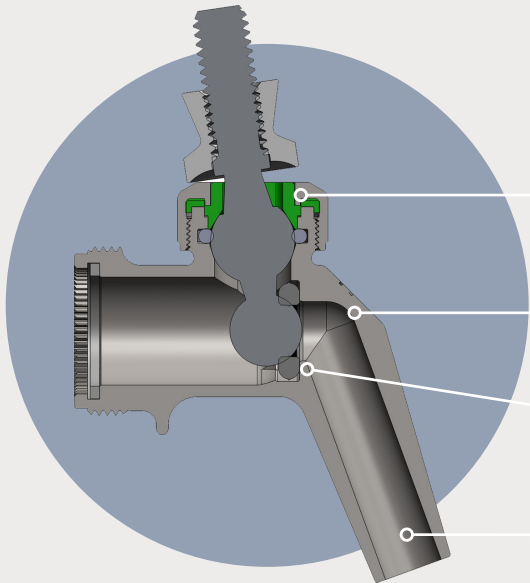

## THE MOST SANITARY BEVERAGE FAUCET EVER!

1. **Available for domestic or imported kegs**  
Supports the o-ring to maintain a positive seal and provide smooth tracking of the handle
2. **304 sanitary stainless steel for all parts that contact product**  
Protects flavor of beer or wine
3. **Floating front seal**  
Features a contoured profile to provide enhanced surface contact for a positive seal
4. **Spout angle is more vertical**
  - Provides for better pour and draining
  - Drop off begins just beyond the o-ring; no flat area for beer to collect

## LOW PROFILE COUPLER

- Available for domestic or imported kegs
- Space-saving design and flexibility
- Beverage contact areas are 304 stainless steel, making the couplers suitable for any beverage
- Easy to operate; lowest height
- Perlick's low profile couplers will fit the majority of domestic and imported beers

*\*There are some exceptions on imported brands, so please ensure you check with your supplier on the coupler style before purchasing.*

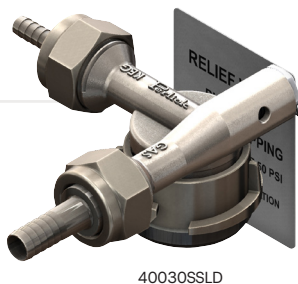

40030SSLD



## COFFEE DISPENSING KITS

- Kit includes the single nitrogen infuser and all necessary components to dispense nitro cold brew coffee from a Perlick refrigerator
- The kit now includes a stout faucet, allowing you to achieve the proper, creamy nitro coffee pour
- Also included is a secondary regulator, which allows for pouring a second beverage pushed with the same gas source
- Kegs sold separately as part number RS-25KG



RS-NDK installed  
in HP24 unit



### COFFEE DISPENSING KITS

		UMRP
RS-NDK	Perlick nitro dispensing kit, single infuser	<b>\$2,608</b>
RS-CDK	Iced coffee dispensing kit (includes parts, connections and nitrogen regulator)	<b>\$675</b>

- Kit includes all necessary components to dispense cold brew coffee from a Perlick refrigerator
- Kegs sold separately as part number RS-25KG
- For nitro cold brew, please see part RS-NDK



630SS



630SSTF

650SS



63927

63928



308-40C



40030SSLD

### BEER/COFFEE DISPENSER ACCESSORIES (HP15, HP24, HC24 MODELS)

#### TAPPING KITS

		UMRP
66585-1	Single-faucet draft arm tapping kit	<b>\$1,530</b>
66585-2	Two-faucet draft arm tapping kit	<b>\$2,010</b>
69862-1	Single-faucet adara tapping kit	<b>\$1,660</b>
69862-2	Two-faucet adara tapping kit	<b>\$2,190</b>

#### BEVERAGE FAUCETS

		UMRP
630SS	Stainless steel forward sealing beverage faucet	<b>\$120</b>
630SSTF	Stainless steel forward sealing beverage faucet in tarnish-free brass	<b>\$130</b>
650SS	Stainless steel forward sealing faucet with flow control	<b>\$160</b>
63927	Stout faucet, brass, chrome plated body with stainless steel spout	<b>\$330</b>
63928	Stout faucet, brass, gold tone, tarnish-free body with stainless steel spout	<b>\$330</b>
308-40C	Beer faucet lock for 630SS beer faucet	<b>E \$130</b>

#### KEG COUPLERS

		UMRP
40030SSLD	Key coupler, low profile, D-style for domestic kegs	<b>\$240</b>
40030SSLS	Key coupler, low profile, S-style for imported kegs	<b>\$240</b>



OTHER ACCESSORIES

2928F	Primary CO2 regulator	\$250
26161E	Secondary CO2 regulator	\$230
RS-NCY	Nitrogen cylinder, aluminum, 244 cu.in. interior volume	\$220
RS-25KG	2.5 Gallon standard keg	\$430
67782	Drip pan	\$220
63797	Beer dispenser cleaning kit (includes pump, sanitizer, and tools to clean lines)	\$250
BLC4	Sanitizer, beer dispenser 4 oz. bottle	\$20
BLC32	Sanitizer, beer dispenser 32 oz. bottle	\$40
67141-1	Perlick faucet handle	E \$120
63929	Sulli plugs	\$20
40106	Beer mechanic's wrench	\$60
GT600	Growler filler tube	\$30
67750	1/4" ID x 5 ft. beverage line for wine, coffee and cocktails	\$50.30
2925C	Primary nitrogen regulator	\$274
1007924	G Quick disconnect for gas line connection	\$20
1007924	L Quick disconnect for liquid line connection	\$20
3079	Stainless steel worm drive clamp	\$2.75



MISC. HARDWARE

		UMRP
(L) FACTORY INSTALLED	Door/drawer lock (factory installed accessory)	\$35
67439L	Door hinge kit, left	\$200
67439R	Door hinge kit, right	\$200
RS-SK-15L	Stacking kit for HP15 models, hinged left	\$390
RS-SK-15R	Stacking kit for HP15 models, hinged right	\$390
RS-SK-24L	Stacking kit for HP24, HC24, HA24 models, hinged left	\$390
RS-SK-24R	Stacking kit for HP24, HC24, HA24 models, hinged right	\$390
RS-SK-18L	Stacking kit for HH24 models, hinged left	\$390
RS-SK-18R	Stacking kit for HH24 models, hinged right	\$390
RS-TK-HA24-6	6" Toe kick kit (includes riser) for HA24 models	\$280
RS-TK-HH24-6	6" Toe kick kit (includes riser) for HH24 Models	\$270
66736-15	Caster kit for HP15 models	\$290
66736	Caster kit for HP24, HC24, HA models	\$510

\*Not compatible with new G5 undercounter line

ICE MAKER ACCESSORIES (H50/H80 MODELS)

		UMRP
63802A	Drain pump for H50 & H80C ice makers	\$451
67282	Optional stainless steel toe kick for H50 & H80C ice makers	\$140

**! WARNING: California Prop 65 Notice**  
 These products may expose you to chemicals including Chromium, which are known to the state of California to cause cancer and birth defects or other reproductive harm. For more information on whether a product in this list contains these chemicals, please refer to the specific product page at [perlick.com](http://perlick.com). Or to find out more about Prop 65, go to [P65Warnings.ca.gov](http://P65Warnings.ca.gov).

## GEN 4 UNDERCOUNTER ACCESSORIES

\*not compatible with new G5 undercounter line

Choose from a wide array of accessories to further customize your Perlick undercounter refrigeration. Whether matching surrounding cabinetry with wood wine fronts, getting your Perlick party-ready with a martini rack, or purchasing products for routine maintenance, Perlick has all the accessories to meet your storage and lifestyle needs.

- Choose from a variety of shelving options to store your favorite products
- Create modular column-style refrigeration with stacking kits to create a flush look between two units
- Replace stainless steel wine fronts with unfinished wood fronts that can be stained to match surrounding cabinetry
- Make any Perlick mobile with an easy-to-install caster kit
- Pour more varieties of beer with a low profile S-Series keg coupler.
- S-series couplers allow you to pour popular European brands such as: Heineken, Stella Artois, and Newcastle



### SHELVING FOR HP15 MODELS

UMRP

RS-15-15R	Shelf, refrigerator for HP15 models	<b>\$170</b>
RS-15-15W	Shelf, wine for HP15 models	<b>\$170</b>

\*Not compatible with new G5 undercounter line

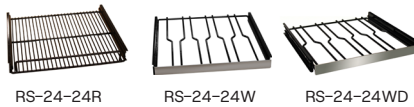

### SHELVING FOR HP24, HP48, HC24, HA24 MODELS

UMRP

RS-24-24R	Shelf, refrigerator for HP24, HC24, HA24 models	<b>\$200</b>
RS-24-24W	Shelf, wine for HP24, HP48, HC24, HA24 models	<b>\$200</b>
RS-24-24WD	Shelf, dual-zone wine for HP24D models	<b>\$200</b>
RS-24-24D	Shelf, divider shelf for HP24, HC24, HA24 models	<b>\$270</b>
RS-24-24M	Martini rack	<b>E \$400</b>

\*Not compatible with new G5 undercounter line

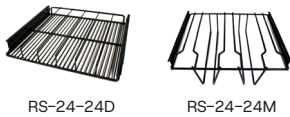

### SHELVING FOR HH24 MODELS

UMRP

RS-18-18R	Shelf, refrigerator for HH24 models	<b>\$230</b>
RS-18-18W	Shelf, wine for HH24 models	<b>\$270</b>

\*Not compatible with new G5 undercounter line



### SHELVING/DRAWER ACCESSORIES

UMRP

65629	Bottle presentation rack	<b>\$140</b>
67115-15	Wood faces for wine shelf, HP15 models (5/pk)	<b>\$170</b>
67115-24	Wood faces for wine shelf, HP15, HP24, HP48, HH24, HC24, HA models (7/pk)	<b>\$170</b>
67964	Stainless steel drawer dividers (3/pk) for HP24, HC24 drawer models	<b>\$140</b>
RK24DP	Drawer pan tray (includes stainless steel tray insert, 3 stainless steel pans and 3 translucent covers) for HP24, HC24, HA24 drawer models	<b>\$340</b>

\*Not compatible with new G5 undercounter line



# PERLICK CORPORATION

## RESIDENTIAL REFRIGERATION PRODUCTS LIMITED WARRANTY

### Residential Core Warranty

#### G5 Residential Undercounter Core Series Units & G2 Wine Column and Beverage Centers THREE-YEAR PARTS & LABOR, THIRTY DAY INITIAL QUALITY PARTS AND LABOR WARRANTY \*

For G5 Residential Undercounter Core Series Units, PERLICK warrants to the original purchaser of every new PERLICK refrigerated unit, the cabinet and all parts thereof, to be free from defects in material or workmanship under normal and proper use and maintenance as specified by PERLICK and upon proper installation and start-up in accordance with the Use & Care Guide supplied with each PERLICK unit. PERLICK'S obligation under this warranty is limited to a period of three (3) years from the date of original installation or thirty-nine (39) months after shipment date from PERLICK, whichever occurs first. It is PERLICK'S obligation under this warranty to cover any initial quality parts and labor limited to a period of thirty (30) days from the date of installation. The following items are covered under the thirty-day initial quality parts and labor warranty: door gaskets, hinge kits, drawer and shelf slides, and cosmetic defects. If components mentioned fall outside of the thirty day warranty, it is deemed NON-WARRANTY and will only be covered via concession approval. For warranty validation, be sure to properly register your unit at [www.Perlick.com](http://www.Perlick.com).

#### SIX-YEAR PARTS & LABOR SEALED SYSTEM WARRANTY\*

For G5 Residential Undercounter Core Series Units, Perlick warrants, to the original purchaser, its hermetically sealed system in material or workmanship under normal and proper use and maintenance as specified by PERLICK and upon proper installation and start-up in accordance with Use & Care Guide supplied with each PERLICK unit. : compressor, condenser, drier, connecting tubing, evaporator, and hot gas bypass valve; to be free from defects in both material and workmanship under normal and proper use and maintenance service for a period of six (6) years from the date of original installation, but not to exceed six (6) years and three (3) months after shipment from the manufacturer, whichever occurs first.

### Residential Luxe Warranty

#### G5 Residential Undercounter Luxe Series Units – SIX-YEAR PARTS & LABOR, THIRTY DAY INITIAL QUALITY PARTS AND LABOR WARRANTY \*

For G5 Residential Undercounter Luxe Series Units, PERLICK warrants to the original purchaser of every new PERLICK refrigerated unit, the cabinet and all parts thereof, to be free from defects in material or workmanship under normal and proper use and maintenance as specified by PERLICK and upon proper installation and start-up in accordance with the Use & Care Guide supplied with each PERLICK unit. PERLICK'S obligation under this warranty is limited to a period of six (6) years from the date of original installation or seventy-five (75) months after shipment date from PERLICK, whichever occurs first. It is PERLICK'S obligation under this warranty to cover any initial quality parts and labor limited to a period of thirty (30) days from the date of installation. The following items are covered under the thirty-day initial quality parts and labor warranty: door gaskets, hinge kits, drawer and shelf slides, and cosmetic defects. If components mentioned fall outside of the thirty-day warranty, it is deemed NON-WARRANTY and will only be covered via concession approval. For warranty validation, be sure to properly register your unit at [www.Perlick.com](http://www.Perlick.com).

### Residential Ice Maker Warranty

#### Undercounter Ice Makers (H50 & H80 Series) – TWO YEAR PARTS & LABOR WARRANTY\*

For Ice Makers. PERLICK warrants to the original purchaser of every new PERLICK refrigerated unit, the cabinet and all parts thereof, to be free from defects in material or workmanship under normal and proper use and maintenance as specified by PERLICK and upon proper installation and start-up in accordance with the Use & Care Guide supplied with each PERLICK unit. PERLICK'S obligation under this warranty is limited to a period of two (2) years from the date of original installation or twenty seven (27) months after shipment date from PERLICK, whichever occurs first.\*\* The optional Perlick drain pump carries a one year parts and labor warranty. The warranty period begins on the installation date of the drain pump. For warranty validation, be sure to properly register your unit at [www.Perlick.com](http://www.Perlick.com).

### Residential Column Warranty Produced 12/31/2025 or Before

#### Column Refrigeration (CR Series) – THREE-YEAR PARTS & LABOR WARRANTY\*

For Column Refrigeration, PERLICK warrants to the original purchaser of every new PERLICK refrigerated unit, the cabinet and all parts thereof, to be free from defects in material or workmanship under normal and proper use and maintenance as specified by PERLICK and upon proper installation and start-up in accordance with the Use & Care Guide supplied with each PERLICK unit. PERLICK'S obligation under this warranty is limited to a period of six (3) years from the date of original installation or 39 months (39) months after shipment date from PERLICK, whichever occurs first. For warranty validation, be sure to properly register your unit at [www.Perlick.com](http://www.Perlick.com).

#### SIX-YEAR PARTS & LABOR SEALED SYSTEM WARRANTY\*

For Column Refrigeration, Perlick warrants, to the original purchaser, its hermetically sealed system in material or workmanship under normal and proper use and maintenance as specified by PERLICK and upon proper installation and start-up in accordance with Use & Care Guide supplied with each PERLICK unit. : compressor, condenser, drier, connecting tubing, 8300 West Good Hope Road • Milwaukee, WI 53223 • 800.558.5592 • Fax 414.353.7069 • [info@perlick.com](mailto:info@perlick.com).

com • [www.perlick.com](http://www.perlick.com) evaporator, and hot gas bypass valve; to be free from defects in both material and workmanship under normal and proper use and maintenance service for a period of twelve (6) years from the date of original installation but not to exceed twelve (6) years and three (3) months after shipment from the manufacturer, whichever occurs first.

#### TWELVE YEAR SEALED SYSTEM WARRANTY – PARTS ONLY\*

For Column Refrigeration, Perlick warrants, to the original purchaser, its hermetically sealed system: compressor, condenser, drier, connecting tubing, evaporator, and hot gas bypass valve; to be free from defects in both material and workmanship under normal and proper use and maintenance service for a period of twelve (12) years from the date of original installation but not to exceed twelve (12) years and three (3) months after shipment from the manufacturer, whichever occurs first.

#### ONE YEAR FULL BEVERAGE DISPENSING EQUIPMENT PARTS & LABOR WARRANTY

For beverage dispensing equipment PERLICK warrants to the original purchaser of every new PERLICK dispensing component to be free from defects in material or workmanship under normal and proper use and maintenance as specified by PERLICK and upon proper installation and start-up in accordance with the Use & Care Guide supplied with each PERLICK unit. PERLICK'S obligation under this warranty is limited to a period of one (1) year from the date of original installation or fifteen (15) months after shipment date from PERLICK, whichever occurs first. For warranty validation, be sure to properly register your unit at [www.Perlick.com](http://www.Perlick.com).

#### ONE YEAR FULL BAR EQUIPMENT PARTS & LABOR WARRANTY

For bar equipment PERLICK warrants to the original purchaser of every new PERLICK bar equipment piece to be free from defects in material or workmanship under normal and proper use and maintenance as specified by PERLICK and upon proper installation and start-up in accordance with the Use & Care Guide supplied with each PERLICK unit. PERLICK'S obligation under this warranty is limited to a period of one (1) year from the date of original installation or fifteen (15) months after shipment date from PERLICK, whichever occurs first. For warranty validation, be sure to properly register your unit at [www.Perlick.com](http://www.Perlick.com).

#### TERMS APPLICABLE TO EACH WARRANTY

Any part covered under the above warranties that is determined by PERLICK to have been defective within the time frame is limited to the repair or replacement, including labor charges, of defective parts or assemblies. The labor warranty shall include standard straight time labor charges only and reasonable travel time, as determined by PERLICK.

#### WARRANTY CLAIMS

All claims for labor or parts must be made directly through PERLICK. All claims should include: model number and serial number of cabinet, proof of purchase, and date of installation. In case of warranted compressor, the compressor model tag must be returned to PERLICK along with the above listed information.

#### WHAT IS NOT COVERED BY THIS WARRANTY

Perlick's sole obligation under this warranty is limited to either repair or replacement of parts, subject to the additional limitations below. This warranty neither assumes nor authorizes any person to assume obligations other than those expressly covered by this warranty. No consequential damages. PERLICK is not responsible for economic loss, profit loss; or special, indirect or consequential damages, including without limitation, losses or damages arising from food or product spoilage claims whether or not on account or refrigeration failure.

**THE REMEDIES DESCRIBED ABOVE FOR EACH WARRANTY ARE THE ONLY ONES THAT PERLICK WILL PROVIDE, EITHER UNDER THIS WARRANTY OR UNDER ANY WARRANTY ARISING BY OPERATION OF LAW. PERLICK WILL NOT BE RESPONSIBLE FOR ANY CONSEQUENTIAL OR INCIDENTAL DAMAGES ARISING FROM THE BREACH OF THIS WARRANTY OR ANY OTHER WARRANTY, WHETHER EXPRESS, IMPLIED OR STATUTORY.**

Some states do not allow the exclusion or limitation of incidental or consequential damages, so the above limitation or exclusion may not apply to you. This warranty gives you specific legal rights and you may also have other legal rights that vary from state to state. To receive parts and/or service and the name of PERLICK factory certified service nearest you, contact Perlick's Technical Service Department by writing to it at Perlick Corporation, Attn: Technical Service Department, 8300 West Good Hope Road, Milwaukee, Wisconsin 53223; or by calling Perlick's Technical Support Department at 844-411-8050; or by e-mailing Perlick's Technical Support Department at [tech\\_service@partstown.com](mailto:tech_service@partstown.com). In addition, you can notify Perlick of a warranty claim by submitting the form on the Perlick website at [www.perlick.com](http://www.perlick.com)

All service provided by Perlick under this Warranty must be performed by Perlick's authorized service representatives, unless otherwise specified by Perlick in writing. Service will be provided during normal business hours.

\*Stainless steel (doors, panels, handles, product frames and interior surfaces) are covered by a limited 30-day parts and labor warranty for cosmetic defects.

\*\* For PERLICK floor models warranty terms & conditions, refer to PERLICK Display Unit Warranty Policy\*\*

\*\*All warranties are NON-transferable from the original purchaser\*\*



THE  
**PERLICK**<sup>®</sup>  
CORPORATION  
*Milwaukee*

