

**PRO  
CHEF**  
JULIEN

EVERYDAY STYLE



SINKS & ACCESSORIES

USD | Effective June 2<sup>nd</sup>, 2025

### CUSTOMER SERVICE

Our Customer Service Department is totally committed to providing support before, during, and after purchase. If you have a question or would like to place an order, a member of our team will be happy to provide advice and assistance. Contact us Monday to Friday, 8 a.m. to 5 p.m. EST.

1-800-461-3377  
customerservice@julien.ca

### WEBSITE

For more information about our products or to download their technical specifications, visit our website.

[prochef.ca](http://prochef.ca)

# TABLE OF CONTENT

Kitchen accomplished	04
How to read a product number	05
Icons used in this document	06
Warranty	52
Index	54

## STAINLESS STEEL SINKS AND ACCESSORIES

Installation methods	09
----------------------	----

### PROINOX H60 COLLECTION

Introduction	12
Dimensions	13
Bar/Prep sinks	14
Kitchen sinks	17
Utility sink	26

Accessories	27
-------------	----

### PROSTATION COLLECTION

Introduction	34
Bar/Prep sinks	36
Kitchen sinks	37
Accessories	40

## FIRECLAY SINKS AND ACCESSORIES

Introduction	43
--------------	----

### PROTERRA M125 COLLECTION

Introduction	46
Bar/Prep sinks	48
Kitchen sinks	49
Accessories	51

# KITCHEN ACCOMPLISHED!

Here at Julien, we've been cooking up a storm since 1946. We've become masters in the art of perfectly designing professional kitchens.

Today, our outstanding reputation precedes us throughout North America, where our expertise has become an essential tool for many world-renowned chefs.

Our Prochef brand features high-quality stainless steel sinks for every price range and any style of kitchen. Our team of qualified, dedicated people will listen to your needs and find innovative solutions. Whether it's for a new construction, a renovation or a multi-unit building, Prochef has the sink you need, no matter the size of your project. We commit to delivering orders of any scale projects in a timely manner.



DOING WHAT  
COMES  
NATURALLY



# HOW TO READ A PRODUCT NUMBER

Product numbers follow the same logic and include all the information on the collection, the installation, the dimension and the color finished of the product.

A. Example of a **sink** number:

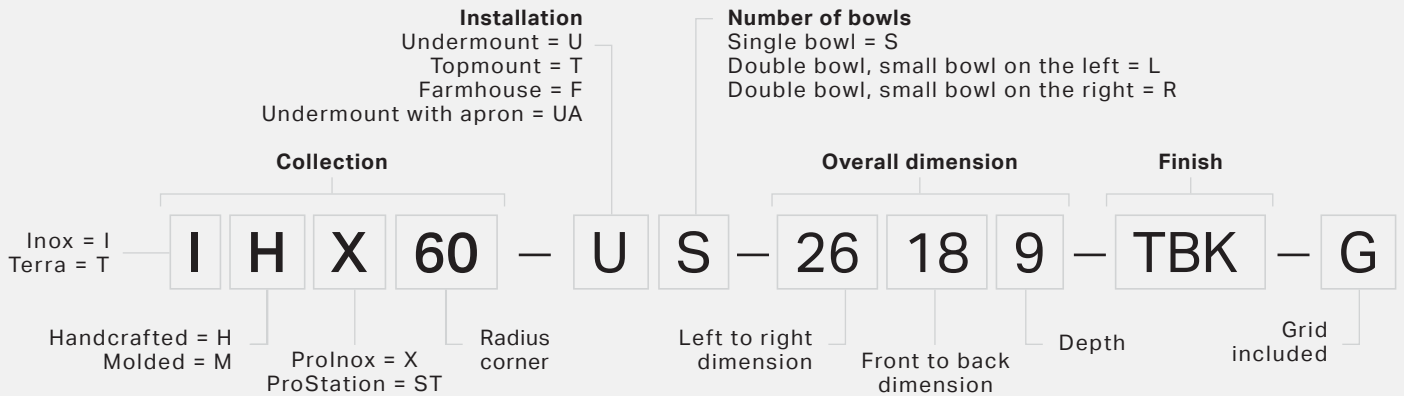

B. Example of a **grid** number:



# ICONS USED IN THIS CATALOG



Brushed steel finish



Handcrafted



Noise reduction



304 stainless steel grade



Undermount installation



Environmentally friendly



Gauge or thickness



Topmount installation



Drain and strainer included



Fireclay



Apronfront undermount installation



Grid included



Rounded corners



Integrated accessory ledge



Square corners



Superior drainage

# ALWAYS HANDCRAFTED STAINLESS STEEL



All our products are handcrafted from a single sheet of heavy duty 18 gauge stainless steel. This method results in a more defined bowl and material thickness throughout the whole sink. And remember, Prochef products come with a lifetime warranty, just one more way we're committed to simplifying your life.

## FABRICATION STEPS OF HANDCRAFTED STAINLESS STEEL SINKS

1. LASER CUTTING

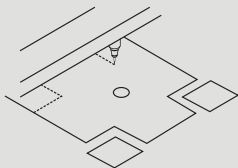

2. BENDING

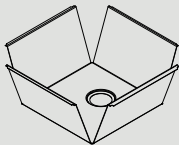

3. WELDING

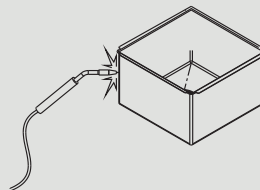

4. POLISHING

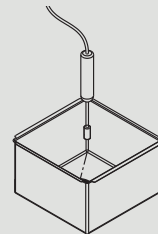

# INSTALLATION METHODS

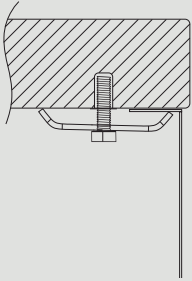

## UNDERMOUNT

This installation provides a 1/8" (3mm) overhang of the countertop over the flange of the bowl.

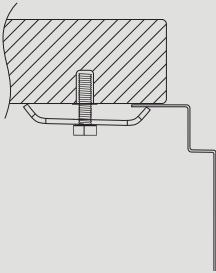

## REVEAL UNDERMOUNT

The reveal installation for our Prostation sinks leaves a positive reveal on the front and back of the sink. This installation lets you place your sink accessories on the exposed flange, allowing the countertop to act as a stopper for the accessories.

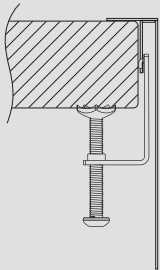

## TOPMOUNT

Topmount installation refers to placing the sink directly above the countertop. This installation method is compatible with most countertop materials.



BRING OUT  
THE CHEF IN YOU

PROINOX **H60**  
SINKS

BRING OUT THE CHEF IN YOU

# MATERIALS AND FINISHES

Stainless steel is undoubtedly the material that best meets the needs of the foodservice industry due to its antibacterial properties and durability.

Prochef sinks are made of high quality 18 gauge 304 stainless steel and offer the following benefits :

- Excellent strength
- Non-corrosive
- Long lasting
- Antibacterial
- Heat resistance
- Sustainable

In addition to our natural stainless steel, we also offer a new deeper black finish. To create a permanent black color, a physical vapor deposition (PVD) layer is bonded to the material.

Then, a Nano coating is pulverised, which makes the surface water-repellent for increased ease of cleaning. It also makes the surface practically impossible to scratch.

## Thickness chart

16 ga		1.5 mm (0.0595")
18 ga		1.2 mm (0.0480")
20 ga		0.9 mm (0.0355")
22 ga		0.7 mm (0.0291")

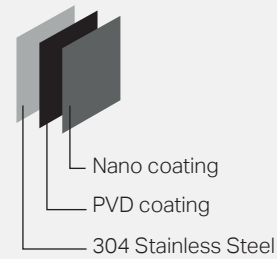

Stylish cross grooves for improved water drainage



Handcrafted

304

Durability:  
Premium grade 304 stainless steel



Two high-quality surface finishes:  
Brushed stainless steel and black stainless steel PVD



FDA APPROVED



Rounded corners for easy maintenance



Drain located towards rear providing more space under the sink



Sound deadening pads for maximum noise reduction



Stainless steel strainer and bottom grid included

# DIMENSIONS

	Bowl width	Overall width	Min. cabinet width
	12"	14"	18"
<b>BAR</b>	15"	17"	21"
<b>SMALL</b>	21"	23"	24"
<b>MEDIUM</b>	24"	26"	30"
<b>LARGE</b>	27"	29"	33"
<b>X-LARGE</b>	30"	32"	36"
<b>X-LARGE DOUBLE</b>	31" (18"/12")	33"	36"
<b>UTILITY</b>	22"	25"	27"

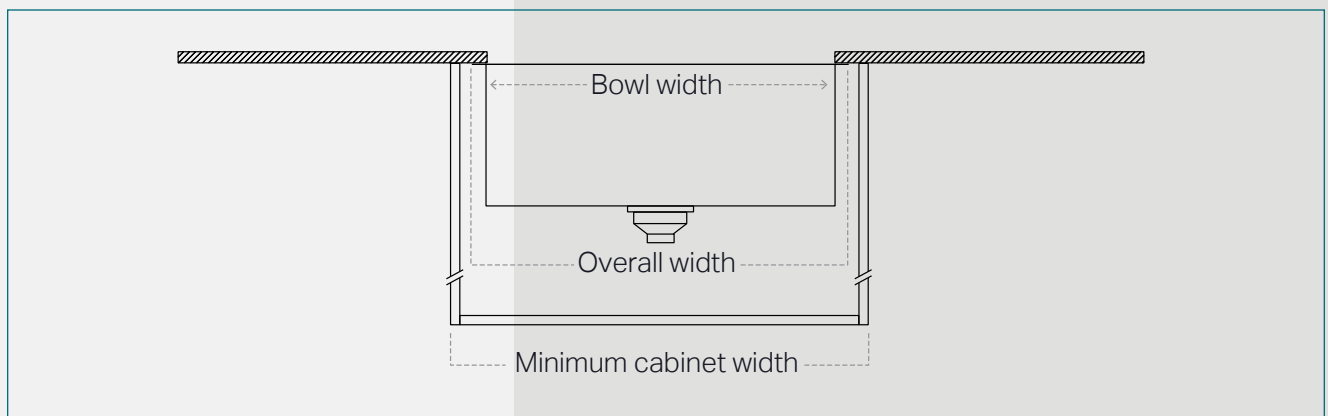

# BAR SINK

## UNDERMOUNT INSTALLATION

17" minimum cabinet



Linear brushed

### DIMENSIONS

BOWL  
12" x 16" x 8"  
OVERALL  
14" x 18" x 8"

### FEATURES

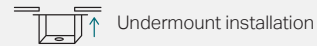

Undermount installation



0,60" corners

### MATERIAL

**304** Premium grade 304 stainless steel (18/10)

 -18 18 gauge thickness

### INCLUDED

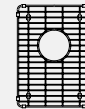

Grid



Drain

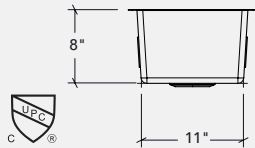
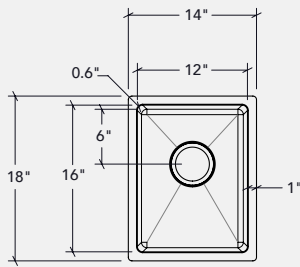

BAR SINK

PRICE LIST

PROCHEF

### PRICE

● IHX60-US-14188-G

\$ 585

# BAR SINK

## TOPMOUNT INSTALLATION

17" minimum cabinet

### DIMENSIONS

**BOWL**  
12" x 16" x 8"

**OVERALL**  
14" x 20" x 8"

### FEATURES

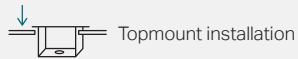

Topmount installation



0,60" corners

### MATERIAL

304

Premium grade 304 stainless steel (18/10)



18 gauge thickness

### INCLUDED

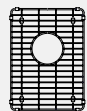

Grid



Drain



Linear brushed

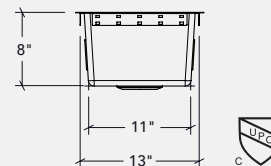
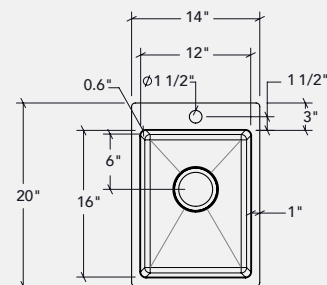

BAR SINK

### PRICE

IHX60-TS-14208-G

\$ 615

# BAR SINK

## UNDERMOUNT INSTALLATION

21" minimum cabinet

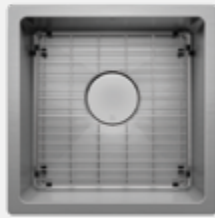

Linear brushed



Black PVD Nano coating

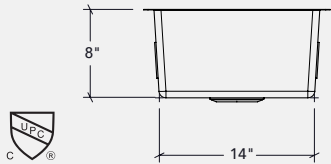
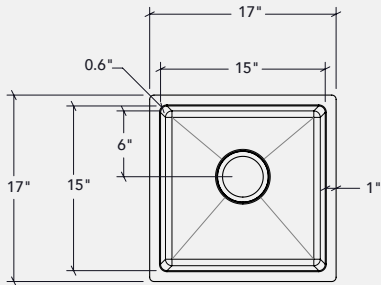

### DIMENSIONS

**BOWL**  
15" x 15" x 8"

**OVERALL**  
17" x 17" x 8"

### FEATURES



Undermount installation



0.60" corners

### MATERIAL

**304** Premium grade 304 stainless steel (18/10)

**18** 18 gauge thickness

### INCLUDED

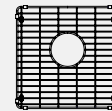

Grid



Drain

BAR SINK

PRICE LIST

PROCHEF

### PRICE

- IHX60-US-17178-G \$ 735
- IHX60-US-17178-TBK-G \$ 1 380

# SMALL | SINGLE BOWL UNDERMOUNT INSTALLATION

27" minimum cabinet

SMALL  
KITCHEN SINK

## DIMENSIONS

**BOWL**  
21" x 16" x 9"

**OVERALL**  
23" x 18" x 9"

## FEATURES

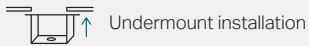

Undermount installation



0,60" corners

## MATERIAL

304

Premium grade 304 stainless steel (18/10)



18 gauge thickness

## INCLUDED

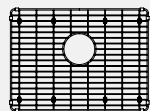

Grid



Drain

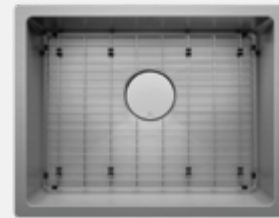

Linear brushed



Black PVD Nano coating

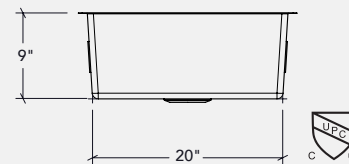
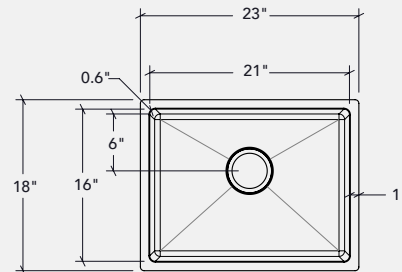

## PRICE

- IHX60-US-23189-G \$ 765
- IHX60-US-23189-TBK-G \$ 1 425

# SMALL | SINGLE BOWL TOPMOUNT INSTALLATION

27" minimum cabinet

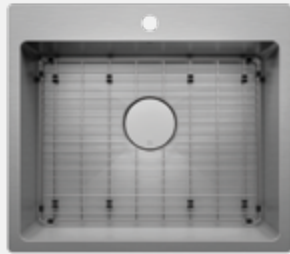

Linear brushed

## DIMENSIONS

**BOWL**  
21" x 16" x 9"  
**OVERALL**  
23" x 20" x 9"

## FEATURES

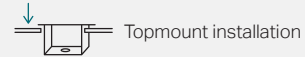

Topmount installation



0,60" corners

## MATERIAL

**304** Premium grade 304 stainless steel (18/10)

-18 18 gauge thickness

## INCLUDED

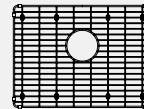

Grid



Drain

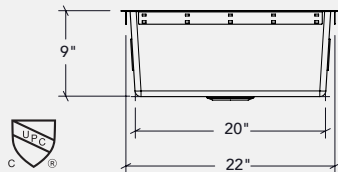
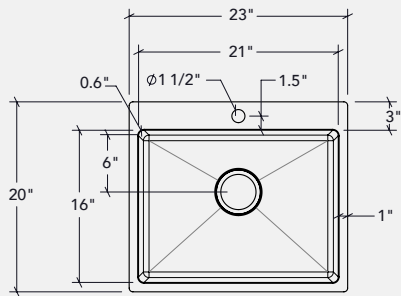

SMALL

KITCHEN SINK

PRICE LIST

PROCHEP

## PRICE

● IHX60-TS-23209-G

\$ 800

# MEDIUM | SINGLE BOWL UNDERMOUNT INSTALLATION

30" minimum cabinet

## DIMENSIONS

**BOWL**  
24" x 16" x 9"  
**OVERALL**  
26" x 18" x 9"

## FEATURES



Undermount installation



0,60" corners

## MATERIAL

**304** Premium grade 304 stainless steel (18/10)

-18 18 gauge thickness

## INCLUDED

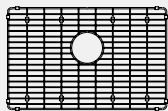

Grid



Drain

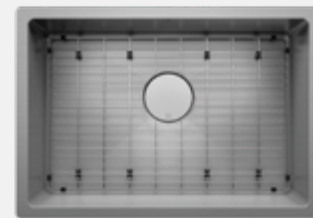

Linear brushed



Black PVD Nano coating

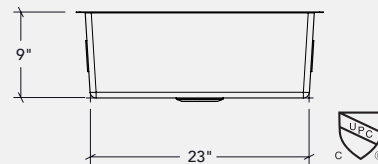
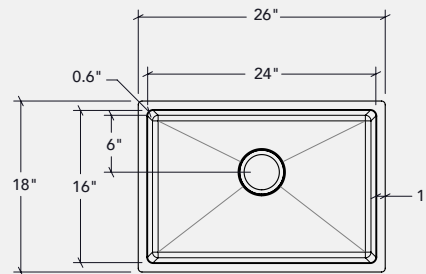

MEDIUM  
KITCHEN SINK

## PRICE

- IHX60-US-26189-G \$ 810
- IHX60-US-26189-TBK-G \$ 1 515

# MEDIUM | SINGLE BOWL TOPMOUNT INSTALLATION

30" minimum cabinet

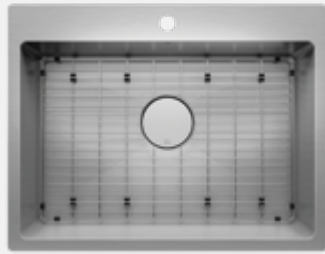

Linear brushed

## DIMENSIONS

**BOWL**  
24" x 16" x 9"  
**OVERALL**  
26" x 20" x 9"

## FEATURES

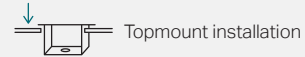

Topmount installation



0,60" corners

## MATERIAL

304

Premium grade 304 stainless steel (18/10)



18 gauge thickness

## INCLUDED

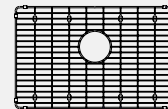

Grid



Drain

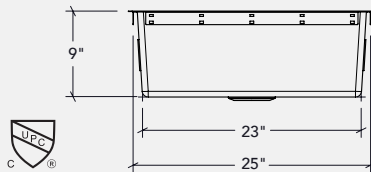
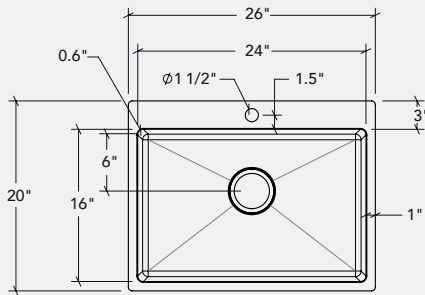

MEDIUM

KITCHEN SINK

PRICE LIST

PROCHEF

## PRICE

IHX60-TS-26209-G

\$ 850

# LARGE | SINGLE BOWL UNDERMOUNT INSTALLATION

33" minimum cabinet

LARGE  
KITCHEN SINK

## DIMENSIONS

**BOWL**  
27" × 16" × 9"

**OVERALL**  
29" × 18" × 9"

## FEATURES

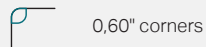
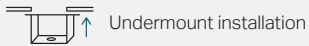

## MATERIAL

**304** Premium grade 304 stainless steel (18/10)

**-18** 18 gauge thickness

## INCLUDED

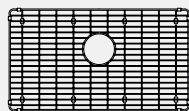

Grid



Drain

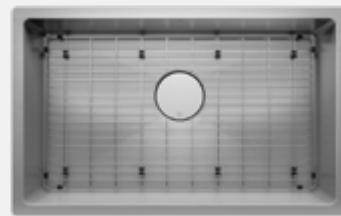

Linear brushed



Black PVD Nano coating

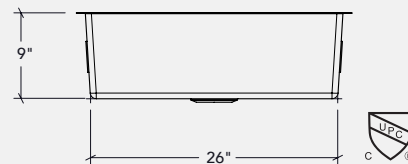
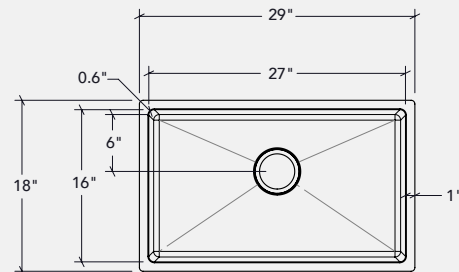

## PRICE

- IHX60-US-29189-G \$ 850
- IHX60-US-29189-TBK-G \$ 1 590

# X-LARGE | SINGLE BOWL UNDERMOUNT INSTALLATION

36" minimum cabinet



Linear brushed



Black PVD Nano coating

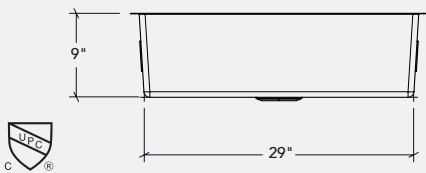
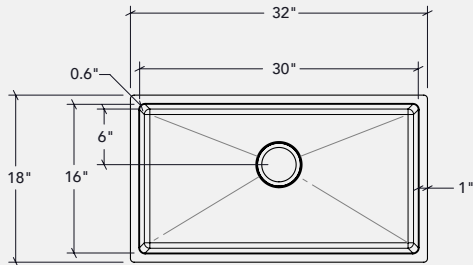

## DIMENSIONS

**BOWL**  
30" x 16" x 9"

**OVERALL**  
32" x 18" x 9"

## FEATURES

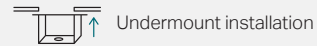

Undermount installation



0,60" corners

## MATERIAL

**304** Premium grade 304 stainless steel (18/10)

**-18** 18 gauge thickness

## INCLUDED

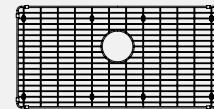

Grid



Drain

X-LARGE

KITCHEN SINK

PRICE LIST

PROCHEF

## PRICE

- IHX60-US-32189-G \$ 910
- IHX60-US-32189-TBK-G \$ 1 705

# X-LARGE | SINGLE BOWL

## APRONFRONT UNDERMOUNT INSTALLATION

36" minimum cabinet

KITCHEN SINK X-LARGE

### DIMENSIONS

**BOWL**  
30" × 16" × 9"

**OVERALL**  
32" × 18" × 9"

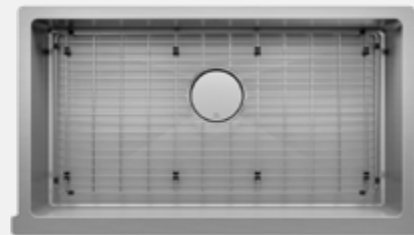

Linear brushed

### FEATURES

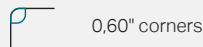
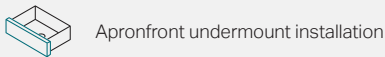

### MATERIAL

**304** Premium grade 304 stainless steel (18/10)

 -18 18 gauge thickness

### INCLUDED

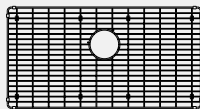

Grid



Drain

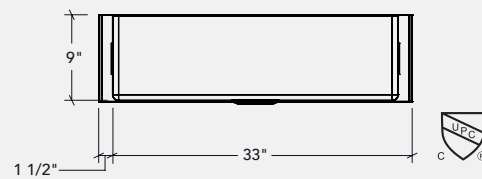
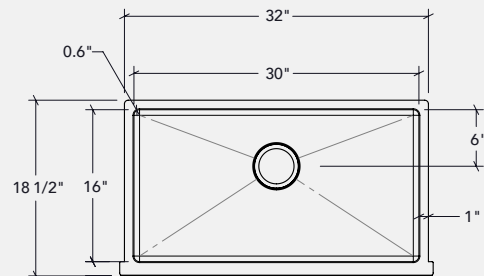

### PRICE

● IHX60-UAS-32189-G

\$ 1 180

# X-LARGE | DOUBLE BOWL UNDERMOUNT INSTALLATION

36" minimum cabinet

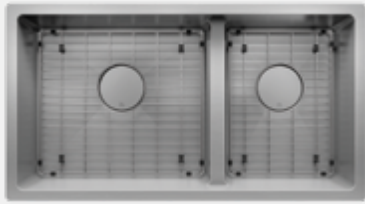

Linear brushed



Black PVD Nano coating

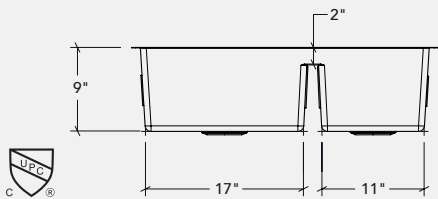
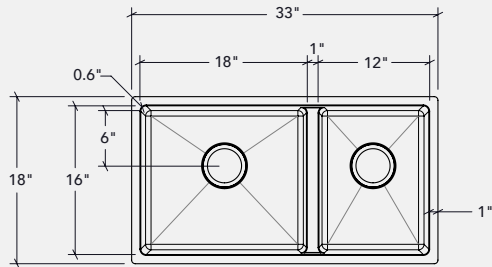

## DIMENSIONS

**BOWL**  
18/12" x 16" x 9"  
**OVERALL**  
33" x 18" x 9"

## FEATURES

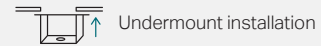

Undermount installation



0,60" corners

## MATERIAL

**304** Premium grade 304 stainless steel (18/10)

**-18** 18 gauge thickness

## INCLUDED

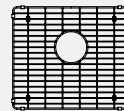

Grids

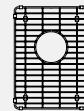

Drain

X-LARGE DOUBLE

KITCHEN SINK

PRICE LIST

PROCHEF

## PRICE

- IHX60-UR-33189-G \$ 1 080
- IHX60-UR-33189-TBK-G \$ 2 020

# X-LARGE | DOUBLE BOWL TOPMOUNT INSTALLATION

36" minimum cabinet

KITCHEN SINK X-LARGE DOUBLE

## DIMENSIONS

**BOWL**  
18 1/2" × 16" × 9"  
**OVERALL**  
33" × 20" × 9"

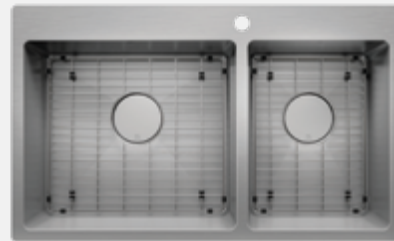

Linear brushed

## FEATURES

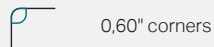
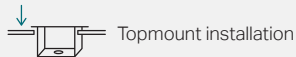

## MATERIAL

**304** Premium grade 304 stainless steel (18/10)

-18 18 gauge thickness

## INCLUDED

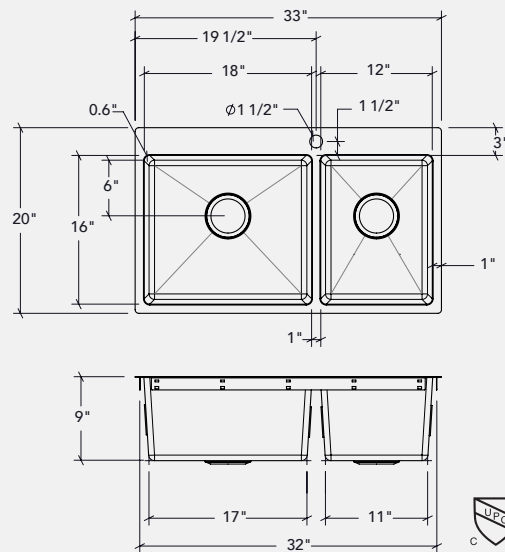
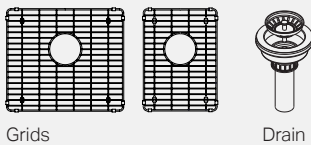

## PRICE

● IHX60-TR-33209-G

\$ 1 135

# UTILITY SINK

## DUALMOUNT INSTALLATION

27" minimum cabinet

SMALL

UTILITY SINK

PRICE LIST

PROCHEF

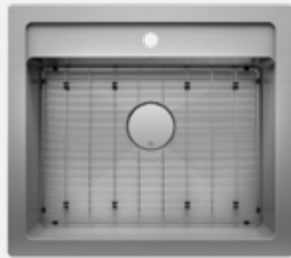

Linear brushed

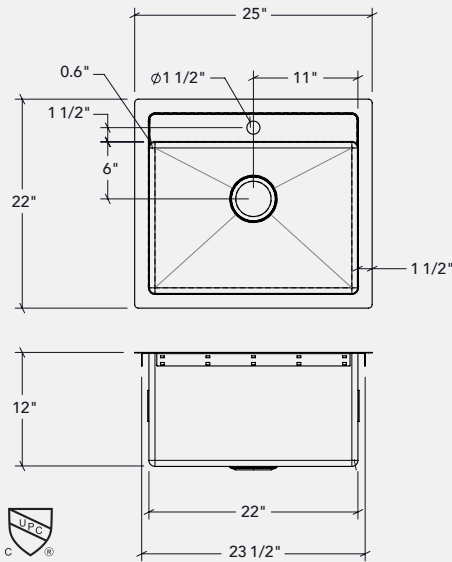

### DIMENSIONS

BOWL  
22" x 16" x 12"

OVERALL  
25" x 20" x 12"

### FEATURES

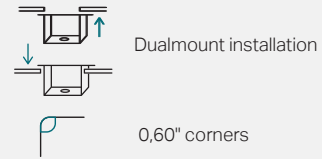

### MATERIAL

**304** Premium grade 304 stainless steel (18/10)

18 18 gauge thickness

### INCLUDED

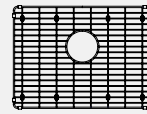

Grid



Drain

### PRICE

IHX60-DS-252212-G

\$ 1 465

# ACCESSORIES

## MIX & MATCH

GRIDS, DRAIN, BIN,  
COLANDER AND  
CUTTING BOARDS

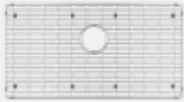
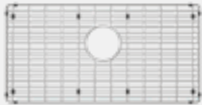
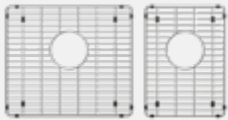
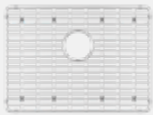

INCLUDED	SPECIFICATIONS		PRICE	
	STAINLESS STEEL	BLACK	SS	TBK
	<p><b>IHX-G-1418</b>  <b>Compatible sinks:</b>                      IHX60-US-14188-G                      IHX60-TS-14208-G  <b>Overall dimensions:</b>                      (A x B x C) 10¼" x 14¼" x 1¼"</p>	<p><b>IHX-G-1418-TBK</b>  <b>Compatible sinks:</b>                      IHX60-UR-33189-TBK-G    <b>Overall dimensions:</b>                      (A x B x C) 10¼" x 14¼" x 1¼"</p>	\$ 160	\$ 195
	<p><b>IHX-G-1717</b>  <b>Compatible sink:</b>                      IHX60-US-17178-G    <b>Overall dimensions:</b>                      (A x B x C) 13¼" x 13¼" x 1¼"</p>	<p><b>IHX-G-1717-TBK</b>  <b>Compatible sink:</b>                      IHX60-US-17178-TBK-G    <b>Overall dimensions:</b>                      (A x B x C) 13¼" x 13¼" x 1¼"</p>	\$ 160	\$ 195
	<p><b>IHX-G-2318</b>  <b>Compatible sinks:</b>                      IHX60-US-23189-G                      IHX60-TS-23209-G  <b>Overall dimensions:</b>                      (A x B x C) 19¼" x 14¼" x 1¼"</p>	<p><b>IHX-G-2318-TBK</b>  <b>Compatible sink:</b>                      IHX60-US-23189-TBK-G    <b>Overall dimensions:</b>                      (A x B x C) 19¼" x 14¼" x 1¼"</p>	\$ 165	\$ 210
	<p><b>IHX-G-2618</b>  <b>Compatible sinks:</b>                      IHX60-US-26189-G                      IHX60-TS-26209-G  <b>Overall dimensions:</b>                      (A x B x C) 22¼" x 14¼" x 1¼"</p>	<p><b>IHX-G-2618-TBK</b>  <b>Compatible sink:</b>                      IHX60-US-26189-TBK-G    <b>Overall dimensions:</b>                      (A x B x C) 19¼" x 14¼" x 1¼"</p>	\$ 180	\$ 225
	<p><b>IHX-G-2918</b>  <b>Compatible sink:</b>                      IHX60-US-29189-G  <b>Overall dimension:</b>                      (A x B x C) 25¼" x 14¼" x 1¼"</p>	<p><b>IHX-G-2918-TBK</b>  <b>Compatible sink:</b>                      IHX60-US-29189-TBK-G  <b>Overall dimension:</b>                      (A x B x C) 25¼" x 14¼" x 1¼"</p>	\$ 180	\$ 225

GRID INCLUDED	SPECIFICATIONS		PRICE	
	STAINLESS STEEL	BLACK	SS	TBK
	<p><b>IH-G-3016</b>  <b>Compatible sink:</b>                      IHX60-US-32189-G</p> <p><b>Overall dimensions:</b>                      (A x B x C) 29<sup>5</sup>/<sub>8</sub>" x 15<sup>5</sup>/<sub>8</sub>" x 1<sup>1</sup>/<sub>4</sub>"</p>	N/A	\$ 190	N/A
	<p><b>IHX-G-3218</b>  <b>Compatible sink:</b>                      IHX60-US-32189-G</p> <p><b>Overall dimensions:</b>                      (A x B x C) 28<sup>1</sup>/<sub>4</sub>" x 14<sup>1</sup>/<sub>4</sub>" x 1<sup>1</sup>/<sub>4</sub>"</p>	<p><b>IHX-G-3218-TBK</b>  <b>Compatible sink:</b>                      IHX60-US-32189-TBK-G</p> <p><b>Overall dimensions:</b>                      (A x B x C) 28<sup>1</sup>/<sub>4</sub>" x 14<sup>1</sup>/<sub>4</sub>" x 1<sup>1</sup>/<sub>4</sub>"</p>	\$ 190	\$ 235
	<p><b>IHX-G-2018</b>  <b>IHX-G-1418</b>  <b>Compatible sinks:</b>                      IHX60-UR-33189-G                      IHX60-TR-33209-G</p> <p><b>Overall dimensions:</b>                      (A x B x C)                      16<sup>1</sup>/<sub>4</sub>" x 14<sup>1</sup>/<sub>4</sub>" x 1<sup>1</sup>/<sub>4</sub>"                      10<sup>1</sup>/<sub>4</sub>" x 14<sup>1</sup>/<sub>4</sub>" x 1<sup>1</sup>/<sub>4</sub>"</p>	<p><b>IHX-G-2018-TBK</b>  <b>IHX-G-1418-TBK</b>  <b>Compatible sink:</b>                      IHX60-UR-33189-TBK-G</p> <p><b>Overall dimensions:</b>                      (A x B x C)                      16<sup>1</sup>/<sub>4</sub>" x 14<sup>1</sup>/<sub>4</sub>" x 1<sup>1</sup>/<sub>4</sub>"                      10<sup>1</sup>/<sub>4</sub>" x 14<sup>1</sup>/<sub>4</sub>" x 1<sup>1</sup>/<sub>4</sub>"</p>	\$ 165 \$ 160	\$ 210 \$ 195
	<p><b>IH-G-2216</b>  <b>Compatible sink:</b>                      IHX60-DS-252212-G</p> <p><b>Overall dimensions:</b>                      (A x B x C) 21<sup>5</sup>/<sub>8</sub>" x 15<sup>5</sup>/<sub>8</sub>" x 1<sup>1</sup>/<sub>4</sub>"</p>		\$ 170	N/A

ACCESSORIES

**Features**

- ▣ 304 stainless steel
- ▣ Two finishes offered :
  - Electro-polished stainless steel
  - Black PVD coating
- ▣ Silicone legs and bumpers prevent the grid from sliding around and scratching the sink

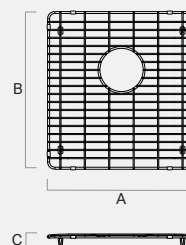

ACCESSORIES

SPECIFICATIONS

PRICE

INCLUDED

STAINLESS STEEL

BLACK

SS

TBK



**DRAIN AND STRAINER FOR STAINLESS STEEL SINKS**

**AA-SA-3.5-SA**

**Compatible sinks:**  
All

**Overall dimensions:**  
4 1/2" x 7 3/4"

**DRAIN AND STRAINER FOR STAINLESS STEEL SINKS, BLACK PVD**

**AA-SA-3.5-TBK**

**Compatible sinks:**  
All

**Overall dimensions:**  
4 1/2" x 7 3/4"

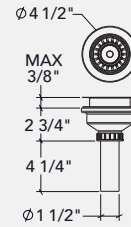

\$ 80

\$ 100



**DRAIN CAP FOR STAINLESS STEEL SINKS**

**AA-DC-3.5-SA**

**Compatible sinks:**  
All

**Overall dimensions:**  
Ø 4 1/2"

**DRAIN CAP FOR STAINLESS STEEL SINKS, BLACK PVD**

**AA-DC-3.5-TBK**

**Compatible sinks:**  
All

**Overall dimension:s**  
Ø 4 1/2"

\$ 50

\$ 70





ACCESSORIES

PRICE LIST

PROCHEF

**Features**

- 304 brushed finish stainless steel (18/10)
- Polypropylene body
- 1 1/2" x 4" tailpiece included
- Removable basket

ACCESSORIES	SPECIFICATIONS	PRICE
	<p><b>COLANDER</b></p> <p><b>IH-CA-16</b></p> <p><b>Compatible sinks:</b> All</p> <p><b>Overall dimensions:</b> 6" x 17 1/8" x 3 1/4"</p>	<p>\$ 275</p>
	<p><b>BIN</b></p> <p><b>IH-BI-16</b></p> <p><b>Compatible sinks:</b> All</p> <p><b>Overall dimensions:</b> 6" x 17 1/8" x 3 1/4"</p>	<p>\$ 275</p>
	<p><b>SANALITE CUTTING BOARD</b></p> <p><b>IH-BB-16-WH</b></p> <p><b>Compatible sinks:</b> All</p> <p><b>Overall dimensions:</b> 12" x 16 1/2" x 3/4"</p>	<p>\$ 220</p>
	<p><b>MAPLE WOOD CUTTING BOARD</b></p> <p><b>IH-BA-16-MA</b></p> <p><b>Compatible sinks:</b> All</p> <p><b>Overall dimensions:</b> 11 7/8" x 17 1/8" x 1 1/4"</p>	<p>\$ 255</p>

ACCESSORIES

**Features**

- Safe for all food preparation
- NSF certified and meets FDA regulation





# VERSATILITY AT ITS FINEST

PROSTATION  
SINKS

# OPTIMIZE SPACE AND TIME

While this undermount sink with reveal installation and accessories is the solution to increasing workspace, it also improves meal preparation by centralizing all steps.

All accessories are designed to fit with the 2 level design and are easy to maintain as they are dishwasher safe. The woodfiber is also heat and moisture resistant.

Both the sink and its accessories are recognized as environmentally friendly material.

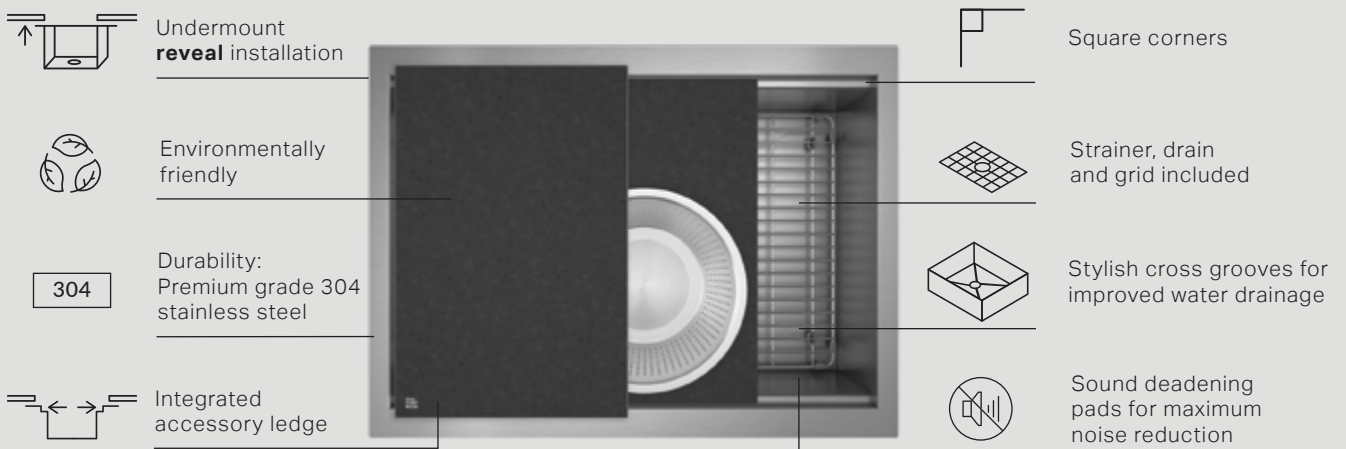



## ACCESSORIES



Moisture-resistant  
and antibacterial



Dishwasher safe  
boards and bowls



Heat-resistant



Woodfiber  
material



Environmentally  
friendly



# BAR SINK

## REVEAL UNDERMOUNT INSTALLATION

18" minimum cabinet



Linear brushed

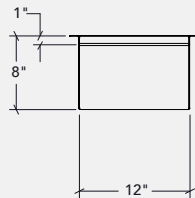
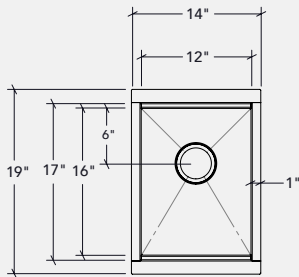

### DIMENSIONS

BOWL  
12" x 16" x 8"

OVERALL  
14" x 19" x 8"

### FEATURES

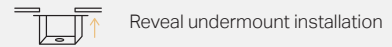

Reveal undermount installation

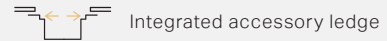

Integrated accessory ledge

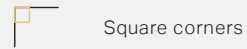

Square corners

### MATERIAL

**304** Premium grade 304 stainless steel (18/10)

18 18 gauge thickness

### INCLUDED



Condiment bowls

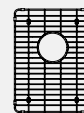

Grid



Drain

BAR SINK

PRICE LIST

PROCHEF

### PRICE

IHST-US-141908-G

\$ 795

# MEDIUM | SINGLE BOWL

## REVEAL UNDERMOUNT INSTALLATION

30" minimum cabinet

MEDIUM  
KITCHEN SINK

### DIMENSIONS

**BOWL**  
25" x 16" x 10"

**OVERALL**  
27" x 19" x 10"

### FEATURES

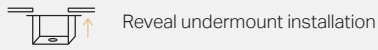

Reveal undermount installation



Integrated accessory ledge



Square corners



Linear brushed

### MATERIAL

**304** Premium grade 304 stainless steel (18/10)

 18 18 gauge thickness

### INCLUDED

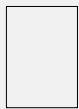

Cutting board



Mixing bowl and colander set

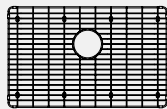

Grid



Drain

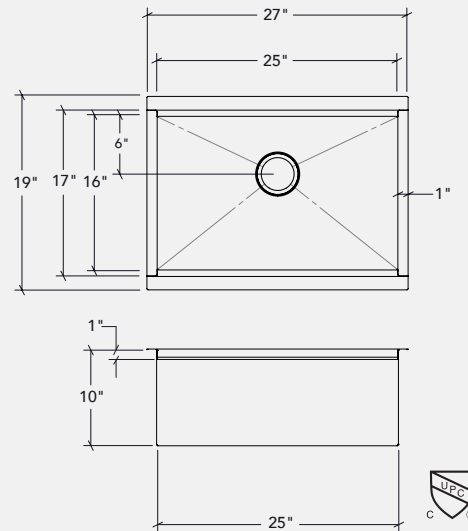

### PRICE

 IHST-US-271910-G

\$ 1 105

# X-LARGE | SINGLE BOWL

## REVEAL UNDERMOUNT INSTALLATION

36" minimum cabinet



Linear brushed

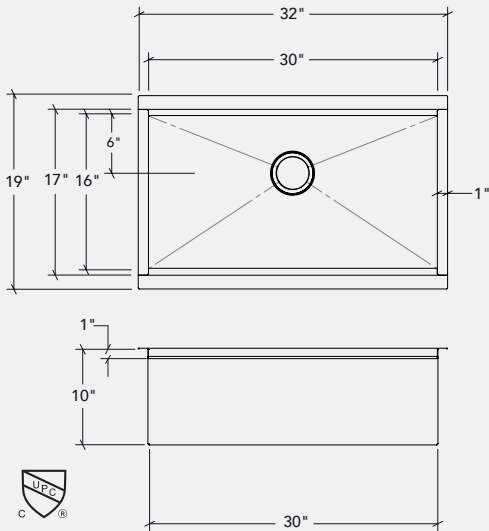

### DIMENSIONS

**BOWL**  
30" x 16" x 10"

**OVERALL**  
32" x 19" x 10"

### FEATURES

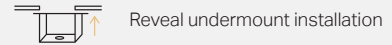

Reveal undermount installation

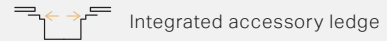

Integrated accessory ledge

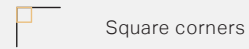

Square corners

### MATERIAL

**304** Premium grade 304 stainless steel (18/10)

18 18 gauge thickness

### INCLUDED



Cutting board



Mixing bowl and colander set

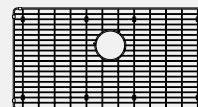

Grid



Drain

X-LARGE

KITCHEN SINK

PRICE LIST

PROCHEP

### PRICE

IHST-US-321910-G

\$ 1 240

# X-LARGE | DOUBLE BOWL

## REVEAL UNDERMOUNT INSTALLATION

36" minimum cabinet

### DIMENSIONS

**BOWL**  
18/12" × 16" × 8/10"

**OVERALL**  
33" × 19" × 10"

### FEATURES

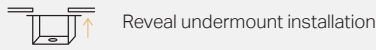

Reveal undermount installation



Integrated accessory ledge



Square corners

### MATERIAL

**304** Premium grade 304 stainless steel (18/10)

18 18 gauge thickness

### INCLUDED

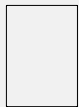

Cutting board



Mixing bowl and colander set

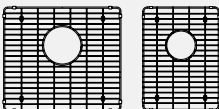

Grids



Drain



Linear brushed

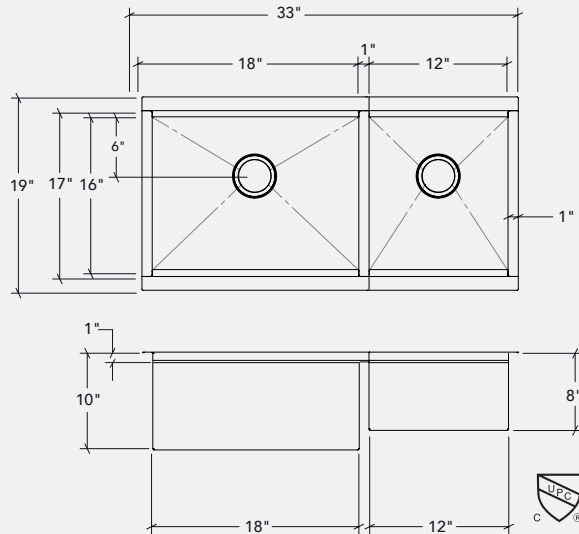

KITCHEN SINK X-LARGE DOUBLE

### PRICE

IHST-UR-331910-G

\$ 1 465







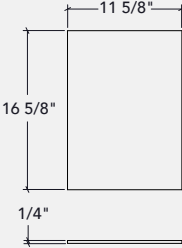

PROSTATION

# ACCESSORIES

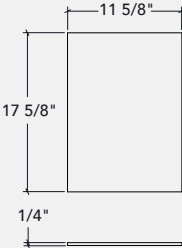
CENTRALIZE  
YOUR MEAL PREP  
OPERATIONS

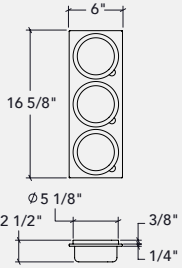
CHOPPING, SLICING, DRAINING  
AND MUCH MORE

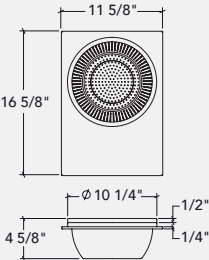

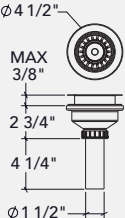
ACCESSORIES	SPECIFICATIONS	PRICE	
INCLUDED			
	<p><b>WOODFIBER CUTTING BOARD</b></p> <p><b>IH-BC-16-BK</b></p> <p><b>Compatible sinks:</b> Prostation sinks</p> <p><b>Overall dimensions:</b> 11 5/8" x 16 5/8" x 1/4"</p>		\$ 105
	<p><b>WOODFIBER CUTTING BOARD</b></p> <p><b>IH-BD-16-BK</b></p> <p><b>Compatible sinks:</b> Prostation sinks</p> <p><b>Overall dimensions:</b> 11 5/8" x 17 5/8" x 1/4"</p>		\$ 105
	<p><b>CONDIMENT BOWLS (3)</b></p> <p><b>IH-SA-16-BK</b></p> <p><b>Compatible sinks:</b> Prostation sinks</p> <p><b>Overall dimensions:</b> 6" x 16 5/8" x 2 1/2"</p>		\$ 135
	<p><b>MIXING BOWL AND STRAINER SET</b></p> <p><b>IH-SB-16-BK</b></p> <p><b>Compatible sinks:</b> Prostation sinks</p> <p><b>Overall dimensions:</b> 11 5/8" x 16 5/8" x 4 5/8"</p>		\$ 160
	<p><b>DRAIN AND STRAINER FOR STAINLESS STEEL SINKS</b></p> <p><b>AA-SA-3.5-SA</b></p> <p><b>Compatible sinks:</b> All</p> <p><b>Overall dimensions:</b> 4 1/2" x 7 3/4"</p>		\$ 80

ACCESSORIES

GRID

INCLUDED

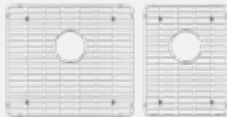
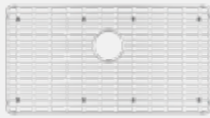
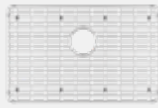

SPECIFICATIONS

STAINLESS STEEL

**IH-G-1216**

**Compatible sink:**  
IHST-US-141908-G

**Overall dimensions:**  
11<sup>5</sup>/<sub>8</sub>" x 15<sup>5</sup>/<sub>8</sub>" x 1<sup>1</sup>/<sub>4</sub>"

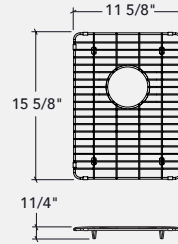

\$ 160

**IH-G-2516**

**Compatible sink:**  
IHST-US-271910-G

**Overall dimensions:**  
24<sup>5</sup>/<sub>8</sub>" x 15<sup>5</sup>/<sub>8</sub>" x 1<sup>1</sup>/<sub>4</sub>"

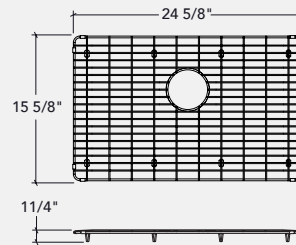

\$ 180

**IH-G-3016**

**Compatible sink:**  
IHST-US-321910-G

**Overall dimensions:**  
29<sup>5</sup>/<sub>8</sub>" x 15<sup>5</sup>/<sub>8</sub>" x 1<sup>1</sup>/<sub>4</sub>"

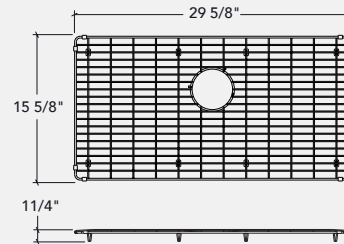

\$ 190

**IH-G-1216 + IH-G-1816**

**Compatible sink:**  
IHST-UR-331910-G

**Overall dimensions:**  
11<sup>5</sup>/<sub>8</sub>" x 15<sup>5</sup>/<sub>8</sub>" x 1<sup>1</sup>/<sub>4</sub>"  
17<sup>5</sup>/<sub>8</sub>" x 15<sup>5</sup>/<sub>8</sub>" x 1<sup>1</sup>/<sub>4</sub>"

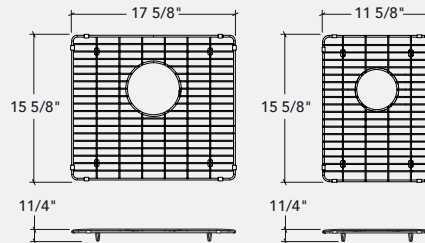

\$ 160

\$ 165

**Features**

- 304 stainless steel
- Silicone legs and bumpers prevent the grid from sliding around and scratching the sink



# ONLY THE FINEST FIRECLAY

Our skilled artisans expertly blend their craftsmanship with meticulously chosen, high-quality materials to create the perfect fireclay sinks.



INSPIRED BY  
YESTERDAY  
FOCUSED ON  
TODAY

PROTERRA M125  
SINKS

# TIMELESS STYLE

Always classy, the Proterra is the answer to a customer looking for durable and easy to maintain product.

With its flat aprons and rounded corners, this sink is the result of hand-finishing techniques.

It is more resistant to breakage, scratches and nicks than most types of ceramics. It also withstands heat, stains and resists standard household chemicals.

With the proper installation, it is also compatible to waste disposal units.



Apronfront installation



1 3/4" thickness



Fine fireclay, enameled glossy white finish



Rounded corners



Stainless steel strainer and drain included



Non-porous finish, hygienic and easy to clean





# SMALL | SINGLE BOWL APRONFRONT INSTALLATION

27" minimum cabinet



### DIMENSIONS

**BOWL**  
20<sup>5</sup>/<sub>8</sub>" × 14<sup>3</sup>/<sub>4</sub>" × 9"  
**OVERALL**  
24" × 18<sup>1</sup>/<sub>8</sub>" × 9<sup>7</sup>/<sub>8</sub>"

### FEATURES



Apronfront installation



1,25" corners

### MATERIAL



Fine fireclay



1 3/4" thickness

### INCLUDED



Drain

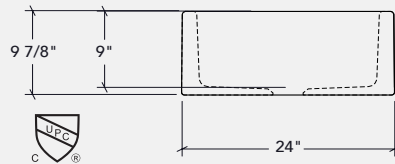
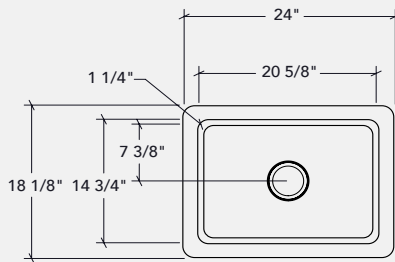

SMALL

KITCHEN SINK

PRICE LIST

PROCHEF

### PRICE

● TM125-FS-241810

\$ 1 055

# MEDIUM | SINGLE BOWL

## APRONFRONT INSTALLATION

33" minimum cabinet

MEDIUM  
KITCHEN SINK



### DIMENSIONS

**BOWL**  
26 5/8" × 14 3/4" × 9"

**OVERALL**  
30" × 18 1/8" × 9 7/8"

### FEATURES



Apronfront installation



1.25" corners

### MATERIAL



Fine fireclay



1 3/4" thickness

### INCLUDED



Drain

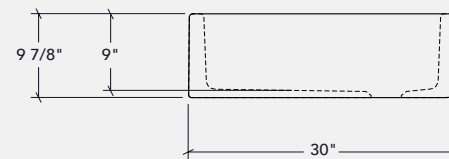
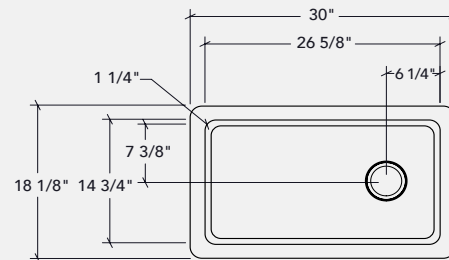

### PRICE

● TM125-FS-301810

\$ 1 200

# X-LARGE | SINGLE BOWL APRONFRONT INSTALLATION

39" minimum cabinet



### DIMENSIONS

**BOWL**  
32<sup>5</sup>/<sub>8</sub>" × 14<sup>3</sup>/<sub>4</sub>" × 9"  
**OVERALL**  
36" × 18<sup>1</sup>/<sub>8</sub>" × 9<sup>7</sup>/<sub>8</sub>"

### FEATURES



Apronfront installation



1,25" corners

### MATERIAL



Fine fireclay



-1<sup>3</sup>/<sub>4</sub>" 1<sup>3</sup>/<sub>4</sub>" thickness

### INCLUDED



Drain

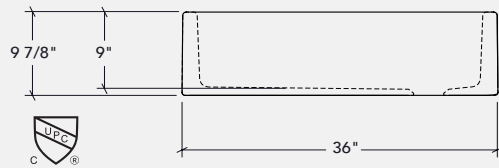
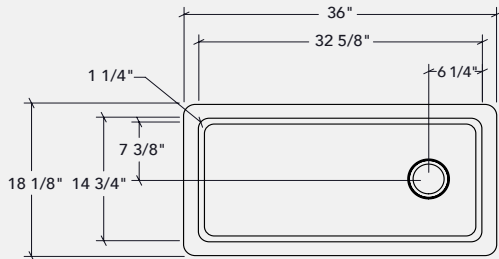

X-LARGE

KITCHEN SINK

PRICE LIST







PROCHEF

### PRICE

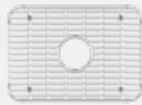
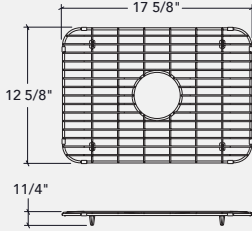
● TM125-FS-361810

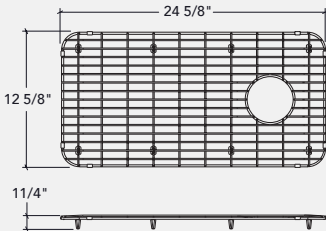
\$ 1 455

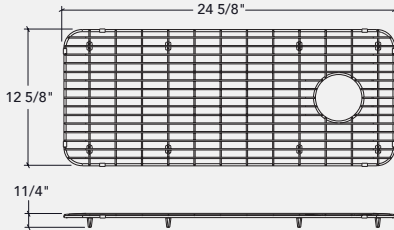
# ACCESSORIES

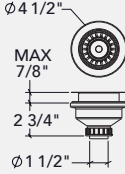
ACCESSORIES	SPECIFICATIONS	PRICE
INCLUDED		
	<p><b>TM-G-2014</b>  <b>Compatible sink:</b>                      TM125-FS-241810</p> <p><b>Overall dimensions:</b>                      17<sup>5</sup>/<sub>8</sub>" x 12<sup>5</sup>/<sub>8</sub>" x 1<sup>1</sup>/<sub>4</sub>"</p> 	<p>\$ 165</p>
	<p><b>TM-G-2614</b>  <b>Compatible sink:</b>                      TM125-FS-301810</p> <p><b>Overall dimensions:</b>                      24<sup>5</sup>/<sub>8</sub>" x 12<sup>5</sup>/<sub>8</sub>" x 1<sup>1</sup>/<sub>4</sub>"</p> 	<p>\$ 180</p>
	<p><b>TM-G-3214</b>  <b>Compatible sink:</b>                      TM125-FS-361810</p> <p><b>Overall dimensions:</b>                      30<sup>3</sup>/<sub>8</sub>" x 12<sup>5</sup>/<sub>8</sub>" x 1<sup>1</sup>/<sub>4</sub>"</p> 	<p>\$ 195</p>
	<p><b>DRAIN AND STRAINER FOR FIRECLAY SINKS</b></p> <p><b>TM-SA-3.5-SA</b>  <b>Compatible sinks:</b>                      Protterra sinks</p> <p><b>Overall dimensions:</b>                      4 1/2" x 3 5/8"</p> 	<p>\$ 85</p>

ACCESSORIES

# WARRANTY

## STAINLESS STEEL SINKS WITH BRUSHED AND PVD FINISHES

JULIEN offers a LIMITED LIFETIME WARRANTY on the fixed components of its PROCHEF stainless steel sinks, ensuring them against defects of material and workmanship. This warranty is limited to defects or damages resulting from a normal residential use and does not cover the following:

- Surface corrosion (chemical or natural)
- Scuffs or scratches
- Misuse, abnormal or abusive use
- Dents, deformations caused by the impact of any object
- Common signs of wear and tear
- Improper installation, care and/or maintenance
- Commercial use
- Environmental factors causing damage
- Shipping or freight damage

## FIRECLAY SINKS

JULIEN offers a LIMITED FIVE (5) YEAR WARRANTY on its PROCHEF fireclay sinks, ensuring them against defects in materials and workmanship as well as discoloration/staining. This warranty is limited to defects or damages resulting from normal residential use and does not cover the following:

- Misuse, abnormal, negligent or abusive use
- Scratches, chips or dents (reported after installation – please inspect sink carefully prior to installation)
- Use of abrasives and/or chemicals (such as undiluted bleach)
- Common signs of wear and tear
- Improper installation, care and/or maintenance
- Commercial use
- Environmental factors causing damage
- Shipping or freight damage

## ACCESSORIES AND MOVING PARTS

JULIEN offers a LIMITED ONE (1) YEAR WARRANTY on moving parts, and PROCHEF accessories against defects in materials and workmanship. This warranty is limited to defects or damages resulting from normal residential use and does not cover:

- Surface corrosion (chemical or natural)
- Scratches or abrasions
- Damages caused by improper use, abnormal or abusive use, negligence
- Dents, deformations caused by the impact of any object
- Common signs of wear and tear
- Improper installation, care and/or maintenance
- Commercial use
- Environmental factors causing damage
- Shipping or freight damage

## GENERALITIES

JULIEN may at its sole discretion, repair, replace or make appropriate adjustments to the products or components proven to be defective in order to restore to good working condition.

In no event, even if product or components are found to be defective, shall JULIEN'S liability exceed the price paid for the product. JULIEN reserves the right to inspect the installation prior to the replacement or repair of the product or its component parts. JULIEN may at its discretion require pictures prior to analyzing the claim. This limited warranty is null and void if the product or components have been repaired, altered or modified other than by JULIEN or under its supervision.

This limited warranty replaces any and all other warranty, expressed or implied, including implied warranties of merchantability or fitness for a particular purpose. Laws governing product warranties may vary from one state or province to another. This warranty is not intended to contravene to the public order and shall not be so interpreted.

This limited warranty extends only to the original owner/end user in residential applications and is not transferable to any subsequent purchaser. In the event of a warranty claim, original proof of purchase (sales receipt) will be required. Shipping and handling costs (for returning the product or components for repairs or to replace product or components) are not covered under this limited warranty.

Also excluded from this limited warranty is any labour, workmanship or other costs incurred in connection with the product or components removal, repairs, replacement, adjustment or installation and any incidental or consequential damages. Warranty will be null and void for any damage resulting from installation not respecting the instructions and JULIEN will not be held responsible for any costs incurred. In the event of a limited warranty claim, original proof of purchase will be required – save original sales receipt. If you believe you have a warranty claim or for more information on the warranty of our products, please contact our customer service.

1-800-461-3377

customerservice@julien.ca

# INDEX

PRODUCT	PAGE	PKG. DIMENSIONS	PKG. WEIGHT
IHX60-US-14188-G	14	21¼" × 17¼" × 11¼"	19 lbs
IHX60-TS-14208-G	15	23¼" × 17¼" × 11¼"	20 lbs
IHX60-US-17178-G	16	20¼" × 20¼" × 13¼"	20 lbs
IHX60-US-17178-TBK-G	16	20¼" × 20¼" × 13¼"	20 lbs
IHX60-US-23189-G	17	26¼" × 21¼" × 14"	26 lbs
IHX60-US-23189-TBK-G	17	26¼" × 21¼" × 14"	26 lbs
IHX60-TS-23209-G	18	26¼" × 23¼" × 12¼"	30 lbs
IHX60-US-26189-G	19	29¼" × 21¼" × 14"	28 lbs
IHX60-US-26189-TBK-G	19	29¼" × 21¼" × 14"	30 lbs
IHX60-TS-26209-G	20	29¼" × 23¼" × 12¼"	32 lbs
IHX60-US-29189-G	21	32¼" × 21¼" × 14"	30 lbs
IHX60-US-29189-TBK-G	21	32¼" × 21¼" × 14"	30 lbs
IHX60-US-32189-G	22	35¼" × 21¼" × 14"	33 lbs
IHX60-US-32189-TBK-G	22	35¼" × 21¼" × 14"	33 lbs
IHX60-UAS-32189-G	23	36½" × 21¾" × 12¼"	40 lbs
IHX60-UR-33189-G	24	36¼" × 21¼" × 14"	33 lbs
IHX60-UR-33189-TBK-G	24	36¼" × 21¼" × 14"	33 lbs
IHX60-TR-33209-G	25	36" × 23¼" × 12¼"	42 lbs
IHX60-DS-252212-G	26	28¼" × 25¼" × 16¾"	34 lbs
IHX-G-1418	28,29	26" × 19¼" × 1½"	4 lbs
IHX-G-1418-TBK	29,29	26" × 19¼" × 1½"	4 lbs
IHX-G-1717	28	26" × 19¼" × 1½"	4 lbs
IHX-G-1717-TBK	28	26" × 19¼" × 1½"	4 lbs
IHX-G-2318	28	26" × 19¼" × 1½"	5 lbs
IHX-G-2318-TBK	28	26" × 19¼" × 1½"	5 lbs
IHX-G-2618	28	38" × 19¼" × 1½"	7 lbs
IHX-G-2618-TBK	28	38" × 19¼" × 1½"	7 lbs
IHX-G-2918	28	38" × 19¼" × 1½"	7 lbs
IHX-G-2918-TBK	28	38" × 19¼" × 1½"	7 lbs

PRODUCT	PAGE	PKG. DIMENSIONS	PKG. WEIGHT
IH-G-3016	29,41	38" × 19¼" × 1½"	8 lbs
IHX-G-3218	29	38" × 19¼" × 1½"	8 lbs
IHX-G-3218-TBK	29	38" × 19¼" × 1½"	8 lbs
IH-G-2216	29	26" × 19¼" × 1½"	6 lbs
IHST-US-141908-G	36	17¾" × 22¾" × 15¼"	-
IHST-US-271910-G	37	30¾" × 22¾" × 15¼"	-
IHST-US-321910-G	38	35¾" × 22¾" × 15¼"	-
IHST-UR-331910-G	39	36¾" × 22¾" × 15¼"	-
IH-G-1216	42	26" × 19¼" × 1½"	4 lbs
IH-G-2516	42	38" × 19¼" × 1½"	7 lbs
IH-G-1816	42	26" × 19¼" × 1½"	5 lbs
TM125-FS-241810	48	29" × 25¾" × 15½"	66 lbs
TM125-FS-301810	49	35" × 25¾" × 15½"	75 lbs
TM125-FS-361810	50	41" × 25¾" × 15½"	86 lbs
TM-G-2014	51	26" × 19¼" × 1½"	6 lbs
TM-G-2614	51	38" × 19¼" × 1½"	7 lbs
TM-G-3214	51	38" × 19¼" × 1½"	8 lbs





1-800-461-3377  
customerservice@julien.ca

955, Lachance Street, Quebec (Quebec)  
Canada G1P 2H3

prochef.ca

Product: PC-PRICE-LIST-EN-USD-2025-06  
A-2025-06

996310214