



GLASSCRAFTERS INC.

## 2025 STANDARD MIRRORED CABINETS PRICE SHEETS

Price sheet includes, frameless and framed cabinets

Issued 7/1/25

GlassCrafters offers a non-beveled standard mirror or a 3/4" beveled mirror option for each of the five decorative framed styles. All cabinets feature rust-proof Satin Anodized aluminum construction. Each GlassCrafters' cabinet features Blum hinges and soft close cushions. All doors are precisely mitered eliminating plastic seals and vinyls. Decorative framed doors are manufactured with satin aluminum interior door frames to best complement our five decorative finishes. Surface mounted and semi-recessed cabinets require the purchase of side mirror kits.

---

### CONTENTS

MIRRORED CABINET ACCESSORIES - page 1  
ELECTRIC OPTION - pages 2, 3

#### FRAMELESS CABINETS

FRAMELESS FLAT MIRROR - pages 4-12  
FRAMELESS BEVELED MIRROR - pages 4-12  
FULL-LENGTH CABINETS - pages 11-12  
TRI-VIEW CABINETS - page 13  
VERTICAL TIER CABINETS - page 14

#### FRAMED CABINETS

DECO - pages 7-10  
LEXINGTON - pages 4-12  
PARK AVE - pages 4-12  
SOHO - pages 7-10  
TRINITY - pages 4-12

CABINET PARTS LIST - pages 15-17

CABINET ORDER FORM - page 30

#### BATH LIGHTING

CHELSEA ILLUMINATED FRAMELESS & FRAMED MIRRORS - pages 25, 26, 27  
VERTICAL LED TASK LIGHTS - pages 28, 29

Note: Individual mirrored cabinet product specifications and installation instruction sheets are available for download at [www.GlassCraftersMirroredCabinets.com](http://www.GlassCraftersMirroredCabinets.com).



GLASSCRAFTERS INC.

## 2025 STANDARD WALL MIRRORS PRICE SHEETS

Price sheet includes, frameless and framed wall mirrors

Issued 7/1/25

GlassCrafters offers decorative frameless and framed mirrors to compliment any design, Traditional, Contemporary or Transitional. The decorative wall mirrors include all the necessary installation hardware. Custom sizes available, consult GlassCrafters for size, price and availability.

---

### CONTENTS

#### DECORATIVE FRAMELESS MIRRORS / CENTER MIRRORS

FLAT MIRRORS - pages 18, 19

ARCHED FLAT MIRRORS - pages 18, 19

BEVELED MIRRORS - pages 18, 19

ARCHED BEVELED MIRRORS - pages 18, 19

#### DECORATIVE FRAMED MIRRORS

DECO - pages 22, 23

LEXINGTON - pages 20-23

PARK AVE - pages 20-23

SOHO - pages 22, 23

TRINITY - pages 20-23

#### ACCESSORIES

CENTER MIRROR GLASS SHELF - page 24

MIRROR ORDER FORM - page 31

Note: Individual wall mirror product specifications and installation instruction sheets are available for download at [www.GlassCraftersMirroredCabinets.com](http://www.GlassCraftersMirroredCabinets.com).

---

**NEW**

**MIRRORRED CABINET ACCESSORIES**

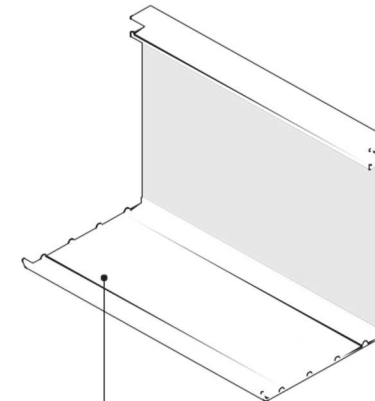

**Cosmetic Shelf Accessory**

- Eyeliner Pencils
- Brushes
- Mascara Containers

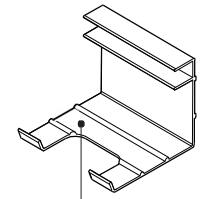

**Razor Holder**

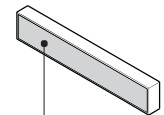

**Magnet**

- Tweezers
- Clippers

- Customized Storage
- Reduced Clutter
- Enhanced Functionality

GlassCrafters' mirrored cabinet storage accessories provide convenience and enhanced organization. Storage accessory kits combine a cosmetic shelf for neatly storing brushes and mascara containers, a razor holder, and a magnet for holding metal tweezers and clippers. Accessory kits come standard with GlassCrafters' 4" and 6" deep mirrored cabinet offerings, not including GlassCrafters' Full-Length mirrored cabinets.

GlassCrafters' Mirrored Cabinet Storage Accessories are included with the following 4" & 6" deep frameless and framed Mirrored Cabinets: GC1624, GC1630, GC1636, GC2030, GC2036, GC2430, GC2436, GC3630-TRI, GC3636-TRI, GC4830-TRI, and GC4836-TRI.

Note: Storage accessory kit model codes are GCMCA-04-01 for 4" deep cabinets and GCMCA-06-01 for 6" deep cabinets.

Note: Product specifications and installation instruction sheets for all product models are available for download at [www.GlassCraftersMirroredCabinets.com](http://www.GlassCraftersMirroredCabinets.com).

## MIRRORED CABINET ELECTRIC OPTION includes 3X Magnification Mirror Accessory

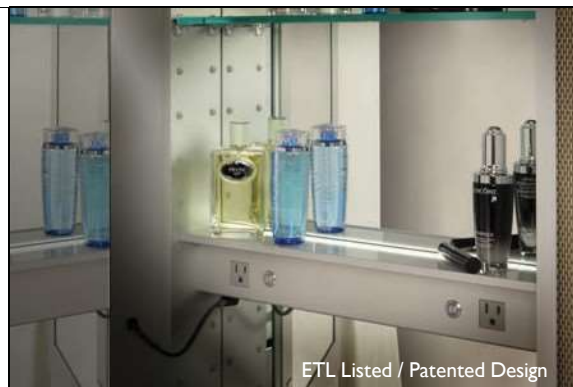

### ELECTRIC option features:

- 2 Electrical AC Outlets
- Integral LED Light
- Heated Door Defogger
- Illuminated Indicator Switches

Available with the following 4” & 6” deep frameless and framed Mirrored Cabinets including:  
GCI630, GCI636, GC2030, GC2036, GC2430, GC2436

Not currently available for GCI624, Tri-View, Full-Length or custom size cabinets.

**Pricing:** Based on the desired cabinet model, add an additional \$550.00 to the standard Mirrored Cabinet list price for total cost of cabinet with Electric Option.

All Mirrored Cabinets with the Electric Option must be selected with left or right sided hinges. (Add “EL” or “ER” to model code)

Refer to GlassCrafters’ Mirrored Cabinet Electric Option installation instructions for all electrical requirements prior to purchase. Installation instructions are available online at [www.GlassCraftersMirroredCabinets.com](http://www.GlassCraftersMirroredCabinets.com) and with the purchased cabinet. All wiring should be done by a qualified licensed electrician.

**MIRRORED CABINETS with ELECTRIC OPTION includes 3X Magnification Mirror Accessory**

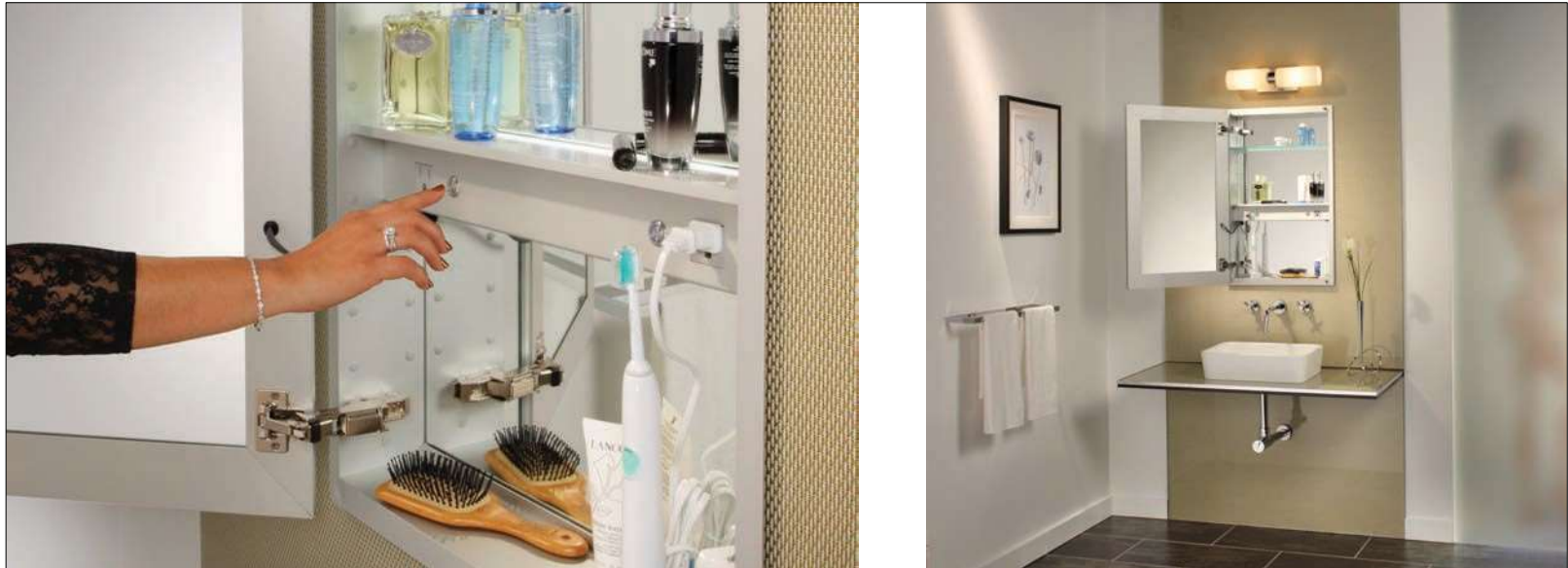

The above images feature GlassCrafters' GC2030-4-SC-BM-EL Mirrored Cabinet with Electric option and left side hinged door

EXAMPLE ORDERING NUMBER DETAILS	GC	20	30	—	4	—	SC	—	TR	—	BM	—	PC	—	EL*
		↓ Width	↓ Height		↓ Depth		↓ Cabinet Finish Satin Chrome		↓ Trinity Frame		↓ Beveled Mirror		↓ Polished Chrome Finish		↓ Electric Option with Left Side Hinged Door

Electric option is available with the following 4" & 6" deep frameless and framed Mirrored Cabinets including: GC1630, GC1636, GC2030, GC2036, GC2430, GC2436.

\*For left or right sided door hinges, add "EL" or "ER" to model code.

All wiring should be done by a qualified licensed electrician in a manner that conforms to the National Electric code. For information concerning wiring requirements, see installation instructions prior to purchase.

## DECORATIVE FINISHES



Plated Polished  
Chrome (PC)



Plated Polished  
Nickel (PN)

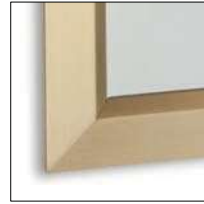

Satin Brass (SB)



Brushed Nickel (BN)



Brushed Bronze (BB)



Iron-Black (IB)



Oil Rubbed  
Bronze (OR)

[Plated - Polished / Mirror Like Finish]

[Satin Finish]

[Brushed / Matte Finish]

[Powder Coated /  
Durable - Matte Finish]

## GC1624 16" Width x 24" Height 4" Depth - Rough Opening: 14 3/8" x 23 3/8"

	Overall Dimension Width x Height	Model	Frameless Mirror	List Price				Electric Option (EL, ER)	Side Mirror Kit - Surface Mount	
				SB, IB	BN, PC, PN	OR	BB			
FLAT MIRROR	15" x 24"	GC1624-4-SC-FM	\$682					N/A	SMK4-24	+ \$115
BEVELED MIRROR	15" x 24"	GC1624-4-SC-BM	\$761					N/A	SMK4-24	+ \$115
LEXINGTON	15 1/8" x 24 1/8"	GC1624-4-SC-LE		\$1305	\$1275	\$1099	\$1099	N/A	SMK4-24	+ \$115
LEXINGTON 3/4" BEVEL	15 1/8" x 24 1/8"	GC1624-4-SC-LE-BM		N/A	\$1885	\$1661	\$1661	N/A	SMK4-24	+ \$115
PARK AVE	15 1/4" x 24 1/4"	GC1624-4-SC-PA		\$1643	\$1618	\$1117	N/A	N/A	SMK4-24	+ \$115
PARK AVE 3/4" BEVEL	15 1/4" x 24 1/4"	GC1624-4-SC-PA-BM		N/A	\$2226	\$1678	N/A	N/A	SMK4-24	+ \$115
TRINITY	15 1/8" x 24 1/8"	GC1624-4-SC-TR		\$1305	\$1275	\$1099	\$1099	N/A	SMK4-24	+ \$115
TRINITY 3/4" BEVEL	15 1/8" x 24 1/8"	GC1624-4-SC-TR-BM		N/A	\$1885	\$1661	\$1661	N/A	SMK4-24	+ \$115

Note: Product specifications and installation instruction sheets for all product models are available for download at [www.GlassCraftersMirroredCabinets.com](http://www.GlassCraftersMirroredCabinets.com).

For custom size cabinet orders, please contact GlassCrafters Inc. directly at [sales@glasscraftersinc.com](mailto:sales@glasscraftersinc.com) concerning delivery times and pricing.

Electric Option is not currently available for custom size cabinets. All sales for custom size cabinets are final.



## 2025 STANDARD MIRRORED CABINETS PRICE SHEETS

Price sheet includes, frameless and framed cabinets

Issued 7/1/25

### GC1630 16" Width x 30" Height 4" Depth - Rough Opening: 14 3/8" x 29 3/8"

Add \$550.00 to list price for Electric Option. See pages 1 and 2 for more details.

	Overall Dimension Width x Height	Model	Frameless Mirror	List Price				Electric Option (EL, ER)	Side Mirror Kit - Surface Mount	
				SB, IB	BN, PC, PN	OR	BB			
FLAT MIRROR	15" x 30"	GC1630-4-SC-FM	\$796					\$550	SMK4-30	+ \$115
BEVELED MIRROR	15" x 30"	GC1630-4-SC-BM	\$853					\$550	SMK4-30	+ \$115
LEXINGTON	15 1/8" x 30 1/8"	GC1630-4-SC-LE		\$1450	\$1434	\$1235	\$1235	\$550	SMK4-30	+ \$115
LEXINGTON 3/4" BEVEL	15 1/8" x 30 1/8"	GC1630-4-SC-LE-BM		N/A	\$2046	\$1799	\$1799	\$550	SMK4-30	+ \$115
PARK AVE	15 1/4" x 30 1/4"	GC1630-4-SC-PA		\$1795	\$1783	\$1255	N/A	\$550	SMK4-30	+ \$115
PARK AVE 3/4" BEVEL	15 1/4" x 30 1/4"	GC1630-4-SC-PA-BM		N/A	\$2395	\$1818	N/A	\$550	SMK4-30	+ \$115
TRINITY	15 1/8" x 30 1/8"	GC1630-4-SC-TR		\$1450	\$1434	\$1235	\$1235	\$550	SMK4-30	+ \$115
TRINITY 3/4" BEVEL	15 1/8" x 30 1/8"	GC1630-4-SC-TR-BM		N/A	\$2046	\$1799	\$1799	\$550	SMK4-30	+ \$115

### GC1630 16" Width x 30" Height 6" Depth - Rough Opening: 14 3/8" x 29 3/8"

Add 550.00 to list price for Electric Option. See pages 1 and 2 for more details.

	Overall Dimension Width x Height	Model	Frameless Mirror	List Price				Electric Option (EL, ER)	Side Mirror Kit - Semi Recessed / Surface Mount	
				SB, IB	BN, PC, PN	OR	BB			
FLAT MIRROR	15" x 30"	GC1630-6-SC-FM	\$1227					\$550	SMRK2-30 / SMK6-30	+ \$115
BEVELED MIRROR	15" x 30"	GC1630-6-SC-BM	\$1275					\$550	SMRK2-30 / SMK6-30	+ \$115
LEXINGTON	15 1/8" x 30 1/8"	GC1630-6-SC-LE		\$1881	\$1903	\$1666	\$1666	\$550	SMRK2-30 / SMK6-30	+ \$115
LEXINGTON 3/4" BEVEL	15 1/8" x 30 1/8"	GC1630-6-SC-LE-BM		N/A	\$2506	\$2222	\$2222	\$550	SMRK2-30 / SMK6-30	+ \$115
PARK AVE	15 1/4" x 30 1/4"	GC1630-6-SC-PA		\$2226	\$2251	\$1686	N/A	\$550	SMRK2-30 / SMK6-30	+ \$115
PARK AVE 3/4" BEVEL	15 1/4" x 30 1/4"	GC1630-6-SC-PA-BM		N/A	\$2855	\$2241	N/A	\$550	SMRK2-30 / SMK6-30	+ \$115
TRINITY	15 1/8" x 30 1/8"	GC1630-6-SC-TR		\$1881	\$1903	\$1666	\$1666	\$550	SMRK2-30 / SMK6-30	+ \$115
TRINITY 3/4" BEVEL	15 1/8" x 30 1/8"	GC1630-6-SC-TR-BM		N/A	\$2506	\$2222	\$2222	\$550	SMRK2-30 / SMK6-30	+ \$115

Note: Product specifications and installation instruction sheets for all product models are available for download at [www.GlassCraftersMirroredCabinets.com](http://www.GlassCraftersMirroredCabinets.com).

For custom size cabinet orders, please contact GlassCrafters Inc. directly at [sales@glasscraftersinc.com](mailto:sales@glasscraftersinc.com) concerning delivery times and pricing.

Electric Option is not currently available for custom size cabinets. All sales for custom size cabinets are final.



## 2025 STANDARD MIRRORED CABINETS PRICE SHEETS

Price sheet includes, frameless and framed cabinets

Issued 7/1/25

### GC1636 16" Width x 36" Height 4" Depth - Rough Opening: 14 3/8" x 35 3/8"

Add \$550.00 to list price for Electric Option. See pages 1 and 2 for more details.

	Overall Dimension Width x Height	Model	Frameless Mirror	List Price				Electric Option (EL, ER)	Side Mirror Kit - Surface Mount	
				SB, IB	BN, PC, PN	OR	BB			
FLAT MIRROR	15" x 36"	GC1636-4-SC-FM	\$943					\$550	SMK4-36	+ \$125
BEVELED MIRROR	15" x 36"	GC1636-4-SC-BM	\$999					\$550	SMK4-36	+ \$125
LEXINGTON	15 1/8" x 36 1/8"	GC1636-4-SC-LE		\$1630	\$1629	\$1403	\$1403	\$550	SMK4-36	+ \$125
LEXINGTON 3/4" BEVEL	15 1/8" x 36 1/8"	GC1636-4-SC-LE-BM		N/A	\$2239	\$1965	\$1965	\$550	SMK4-36	+ \$125
PARK AVE	15 1/4" x 36 1/4"	GC1636-4-SC-PA		\$1981	\$1984	\$1426	N/A	\$550	SMK4-36	+ \$125
PARK AVE 3/4" BEVEL	15 1/4" x 36 1/4"	GC1636-4-SC-PA-BM		N/A	\$2595	\$1987	N/A	\$550	SMK4-36	+ \$125
TRINITY	15 1/8" x 36 1/8"	GC1636-4-SC-TR		\$1630	\$1629	\$1403	\$1403	\$550	SMK4-36	+ \$125
TRINITY 3/4" BEVEL	15 1/8" x 36 1/8"	GC1636-4-SC-TR-BM		N/A	\$2239	\$1965	\$1965	\$550	SMK4-36	+ \$125

### GC1636 16" Width x 36" Height 6" Depth - Rough Opening: 14 3/8" x 35 3/8"

Add \$550.00 to list price for Electric Option. See pages 1 and 2 for more details.

	Overall Dimension Width x Height	Model	Frameless Mirror	List Price				Electric Option (EL, ER)	Side Mirror Kit - Semi Recessed / Surface Mount	
				SB, IB	BN, PC, PN	OR	BB			
FLAT MIRROR	15" x 36"	GC1636-6-SC-FM	\$1377					\$550	SMRK2-36 / SMK6-36	+ \$125
BEVELED MIRROR	15" x 36"	GC1636-6-SC-BM	\$1431					\$550	SMRK2-36 / SMK6-36	+ \$125
LEXINGTON	15 1/8" x 36 1/8"	GC1636-6-SC-LE		\$2062	\$2099	\$1837	\$1837	\$550	SMRK2-36 / SMK6-36	+ \$125
LEXINGTON 3/4" BEVEL	15 1/8" x 36 1/8"	GC1636-6-SC-LE-BM		N/A	\$2708	\$2397	\$2397	\$550	SMRK2-36 / SMK6-36	+ \$125
PARK AVE	15 1/4" x 36 1/4"	GC1636-6-SC-PA		\$2414	\$2455	\$1858	N/A	\$550	SMRK2-36 / SMK6-36	+ \$125
PARK AVE 3/4" BEVEL	15 1/4" x 36 1/4"	GC1636-6-SC-PA-BM		N/A	\$3064	\$2420	N/A	\$550	SMRK2-36 / SMK6-36	+ \$125
TRINITY	15 1/8" x 36 1/8"	GC1636-6-SC-TR		\$2062	\$2099	\$1837	\$1837	\$550	SMRK2-36 / SMK6-36	+ \$125
TRINITY 3/4" BEVEL	15 1/8" x 36 1/8"	GC1636-6-SC-TR-BM		N/A	\$2708	\$2397	\$2397	\$550	SMRK2-36 / SMK6-36	+ \$125

Note: Product specifications and installation instruction sheets for all product models are available for download at [www.GlassCraftersMirroredCabinets.com](http://www.GlassCraftersMirroredCabinets.com).

For custom size cabinet orders, please contact GlassCrafters Inc. directly at [sales@glasscraftersinc.com](mailto:sales@glasscraftersinc.com) concerning delivery times and pricing.

Electric Option is not currently available for custom size cabinets. All sales for custom size cabinets are final.



## 2025 STANDARD MIRRORED CABINETS PRICE SHEETS

Price sheet includes, frameless and framed cabinets

Issued 7/1/25

### GC2030 20" Width x 30" Height 4" Depth - Rough Opening: 18 3/8" x 29 3/8"

Add \$550.00 to list price for Electric Option. See pages 1 and 2 for more details.

	Overall Dimension Width x Height	Model	Frameless Mirror	List Price				Electric Option (EL, ER)	Side Mirror Kit - Surface Mount	
				SB, IB	BN, PC, PN	OR	BB			
FLAT MIRROR	19" x 30"	GC2030-4-SC-FM	\$856					\$550	SMK4-30	+ \$115
BEVELED MIRROR	19" x 30"	GC2030-4-SC-BM	\$913					\$550	SMK4-30	+ \$115
DECO	19 1/8" x 30 1/8"	GC2030-4-SC-DE		N/A	\$1575	\$1331	\$1331	\$550	SMK4-30	+ \$115
DECO 3/4" BEVEL	19 1/8" x 30 1/8"	GC2030-4-SC-DE-BM		N/A	\$2186	\$1894	\$1894	\$550	SMK4-30	+ \$115
LEXINGTON	19 1/8" x 30 1/8"	GC2030-4-SC-LE		\$1532	\$1521	\$1310	\$1310	\$550	SMK4-30	+ \$115
LEXINGTON 3/4" BEVEL	19 1/8" x 30 1/8"	GC2030-4-SC-LE-BM		N/A	\$2134	\$1872	\$1872	\$550	SMK4-30	+ \$115
PARK AVE	19 1/4" x 30 1/4"	GC2030-4-SC-PA		\$1880	\$1875	\$1331	N/A	\$550	SMK4-30	+ \$115
PARK AVE 3/4" BEVEL	19 1/4" x 30 1/4"	GC2030-4-SC-PA-BM		N/A	\$2486	\$1894	N/A	\$550	SMK4-30	+ \$115
SOHO	19 1/8" x 30 1/8"	GC2030-4-SC-SO		N/A	\$1575	\$1331	\$1331	\$550	SMK4-30	+ \$115
SOHO 3/4" BEVEL	19 1/8" x 30 1/8"	GC2030-4-SC-SO-BM		N/A	\$2186	\$1894	\$1894	\$550	SMK4-30	+ \$115
TRINITY	19 1/8" x 30 1/8"	GC2030-4-SC-TR		\$1532	\$1521	\$1310	\$1310	\$550	SMK4-30	+ \$115
TRINITY 3/4" BEVEL	19 1/8" x 30 1/8"	GC2030-4-SC-TR-BM		N/A	\$2134	\$1872	\$1872	\$550	SMK4-30	+ \$115

### GC2030 20" Width x 30" Height 6" Depth - Rough Opening: 18 3/8" x 29 3/8"

Add \$550.00 to list price for Electric Option. See pages 1 and 2 for more details.

	Overall Dimension Width x Height	Model	Frameless Mirror	List Price				Electric Option (EL, ER)	Side Mirror Kit - Semi Recessed / Surface Mount	
				SB, IB	BN, PC, PN	OR	BB			
FLAT MIRROR	19" x 30"	GC2030-6-SC-FM	\$1288					\$550	SMRK2-30 / SMK6-30	+ \$115
BEVELED MIRROR	19" x 30"	GC2030-6-SC-BM	\$1346					\$550	SMRK2-30 / SMK6-30	+ \$115
DECO	19 1/8" x 30 1/8"	GC2030-6-SC-DE		N/A	\$2045	\$1763	\$1763	\$550	SMRK2-30 / SMK6-30	+ \$115
DECO 3/4" BEVEL	19 1/8" x 30 1/8"	GC2030-6-SC-DE-BM		N/A	\$2658	\$2326	\$2326	\$550	SMRK2-30 / SMK6-30	+ \$115
LEXINGTON	19 1/8" x 30 1/8"	GC2030-6-SC-LE		\$1964	\$1993	\$1742	\$1742	\$550	SMRK2-30 / SMK6-30	+ \$115
LEXINGTON 3/4" BEVEL	19 1/8" x 30 1/8"	GC2030-6-SC-LE-BM		N/A	\$2604	\$2306	\$2306	\$550	SMRK2-30 / SMK6-30	+ \$115
PARK AVE	19 1/4" x 30 1/4"	GC2030-6-SC-PA		\$2313	\$2345	\$1763	N/A	\$550	SMRK2-30 / SMK6-30	+ \$115
PARK AVE 3/4" BEVEL	19 1/4" x 30 1/4"	GC2030-6-SC-PA-BM		N/A	\$2958	\$2326	N/A	\$550	SMRK2-30 / SMK6-30	+ \$115
SOHO	19 1/8" x 30 1/8"	GC2030-6-SC-SO		N/A	\$2045	\$1763	\$1763	\$550	SMRK2-30 / SMK6-30	+ \$115
SOHO 3/4" BEVEL	19 1/8" x 30 1/8"	GC2030-6-SC-SO-BM		N/A	\$2658	\$2326	\$2326	\$550	SMRK2-30 / SMK6-30	+ \$115
TRINITY	19 1/8" x 30 1/8"	GC2030-6-SC-TR		\$1964	\$1993	\$1742	\$1742	\$550	SMRK2-30 / SMK6-30	+ \$115
TRINITY 3/4" BEVEL	19 1/8" x 30 1/8"	GC2030-6-SC-TR-BM		N/A	\$2604	\$2306	\$2306	\$550	SMRK2-30 / SMK6-30	+ \$115

Note: Product specifications and installation instruction sheets for all product models are available for download at [www.GlassCraftersMirroredCabinets.com](http://www.GlassCraftersMirroredCabinets.com).

For custom size cabinet orders, please contact GlassCrafters Inc. directly at [sales@glasscraftersinc.com](mailto:sales@glasscraftersinc.com) concerning delivery times and pricing.

Electric Option is not currently available for custom size cabinets. All sales for custom size cabinets are final.



## 2025 STANDARD MIRRORED CABINETS PRICE SHEETS

Price sheet includes, frameless and framed cabinets

Issued 7/1/25

### GC2036 20" Width x 36" Height 4" Depth - Rough Opening: 18 3/8" x 35 3/8"

Add \$550.00 to list price for Electric Option. See pages 1 and 2 for more details.

	Overall Dimension Width x Height	Model	Frameless Mirror	List Price				Electric Option (EL, ER)	Side Mirror Kit - Surface Mount	
				SB, IB	BN, PC, PN	OR	BB			
FLAT MIRROR	19" x 36"	GC2036-4-SC-FM	\$1003					\$550	SMK4-36	+ \$125
BEVELED MIRROR	19" x 36"	GC2036-4-SC-BM	\$1059					\$550	SMK4-36	+ \$125
DECO	19 1/8" x 36 1/8"	GC2036-4-SC-DE		N/A	\$1776	\$1502	\$1502	\$550	SMK4-36	+ \$125
DECO 3/4" BEVEL	19 1/8" x 36 1/8"	GC2036-4-SC-DE-BM		N/A	\$2388	\$2063	\$2063	\$550	SMK4-36	+ \$125
LEXINGTON	19 1/8" x 36 1/8"	GC2036-4-SC-LE		\$1710	\$1716	\$1478	\$1478	\$550	SMK4-36	+ \$125
LEXINGTON 3/4" BEVEL	19 1/8" x 36 1/8"	GC2036-4-SC-LE-BM		N/A	\$2328	\$2040	\$2040	\$550	SMK4-36	+ \$125
PARK AVE	19 1/4" x 36 1/4"	GC2036-4-SC-PA		\$2065	\$2076	\$1502	N/A	\$550	SMK4-36	+ \$125
PARK AVE 3/4" BEVEL	19 1/4" x 36 1/4"	GC2036-4-SC-PA-BM		N/A	\$2688	\$2063	N/A	\$550	SMK4-36	+ \$125
SOHO	19 1/8" x 36 1/8"	GC2036-4-SC-SO		N/A	\$1776	\$1502	\$1502	\$550	SMK4-36	+ \$125
SOHO 3/4" BEVEL	19 1/8" x 36 1/8"	GC2036-4-SC-SO-BM		N/A	\$2388	\$2063	\$2063	\$550	SMK4-36	+ \$125
TRINITY	19 1/8" x 36 1/8"	GC2036-4-SC-TR		\$1710	\$1716	\$1478	\$1478	\$550	SMK4-36	+ \$125
TRINITY 3/4" BEVEL	19 1/8" x 36 1/8"	GC2036-4-SC-TR-BM		N/A	\$2328	\$2040	\$2040	\$550	SMK4-36	+ \$125

### GC2036 20" Width x 36" Height 6" Depth - Rough Opening: 18 3/8" x 35 3/8"

Add \$550.00 to list price for Electric Option. See pages 1 and 2 for more details.

	Overall Dimension Width x Height	Model	Frameless Mirror	List Price				Electric Option (EL, ER)	Side Mirror Kit - Semi Recessed / Surface Mount	
				SB, IB	BN, PC, PN	OR	BB			
FLAT MIRROR	19" x 36"	GC2036-6-SC-FM	\$1436					\$550	SMRK2-36 / SMK6-36	+ \$125
BEVELED MIRROR	19" x 36"	GC2036-6-SC-BM	\$1492					\$550	SMRK2-36 / SMK6-36	+ \$125
DECO	19 1/8" x 36 1/8"	GC2036-6-SC-DE		N/A	\$2246	\$1934	\$1934	\$550	SMRK2-36 / SMK6-36	+ \$125
DECO 3/4" BEVEL	19 1/8" x 36 1/8"	GC2036-6-SC-DE-BM		N/A	\$2858	\$2496	\$2496	\$550	SMRK2-36 / SMK6-36	+ \$125
LEXINGTON	19 1/8" x 36 1/8"	GC2036-6-SC-LE		\$2144	\$2186	\$1910	\$1910	\$550	SMRK2-36 / SMK6-36	+ \$125
LEXINGTON 3/4" BEVEL	19 1/8" x 36 1/8"	GC2036-6-SC-LE-BM		N/A	\$2798	\$2473	\$2473	\$550	SMRK2-36 / SMK6-36	+ \$125
PARK AVE	19 1/4" x 36 1/4"	GC2036-6-SC-PA		\$2499	\$2546	\$1934	N/A	\$550	SMRK2-36 / SMK6-36	+ \$125
PARK AVE 3/4" BEVEL	19 1/4" x 36 1/4"	GC2036-6-SC-PA-BM		N/A	\$3158	\$2496	N/A	\$550	SMRK2-36 / SMK6-36	+ \$125
SOHO	19 1/8" x 36 1/8"	GC2036-6-SC-SO		N/A	\$2246	\$1934	\$1934	\$550	SMRK2-36 / SMK6-36	+ \$125
SOHO 3/4" BEVEL	19 1/8" x 36 1/8"	GC2036-6-SC-SO-BM		N/A	\$2858	\$2496	\$2496	\$550	SMRK2-36 / SMK6-36	+ \$125
TRINITY	19 1/8" x 36 1/8"	GC2036-6-SC-TR		\$2144	\$2186	\$1910	\$1910	\$550	SMRK2-36 / SMK6-36	+ \$125
TRINITY 3/4" BEVEL	19 1/8" x 36 1/8"	GC2036-6-SC-TR-BM		N/A	\$2798	\$2473	\$2473	\$550	SMRK2-36 / SMK6-36	+ \$125

Note: Product specifications and installation instruction sheets for all product models are available for download at [www.GlassCraftersMirroredCabinets.com](http://www.GlassCraftersMirroredCabinets.com).

For custom size cabinet orders, please contact GlassCrafters Inc. directly at [sales@glasscraftersinc.com](mailto:sales@glasscraftersinc.com) concerning delivery times and pricing.

Electric Option is not currently available for custom size cabinets. All sales for custom size cabinets are final.



## 2025 STANDARD MIRRORED CABINETS PRICE SHEETS

Price sheet includes, frameless and framed cabinets

Issued 7/1/25

### GC2430 24" Width x 30" Height 4" Depth - Rough Opening: 22 3/8" x 29 3/8"

Add \$550.00 to list price for Electric Option. See pages 1 and 2 for more details.

	Overall Dimension Width x Height	Model	Frameless Mirror	List Price				Electric Option (EL, ER)	Side Mirror Kit - Surface Mount	
				SB, IB	BN, PC, PN	OR	BB			
FLAT MIRROR	23" x 30"	GC2430-4-SC-FM	\$946					\$550	SMK4-30	+ \$115
BEVELED MIRROR	23" x 30"	GC2430-4-SC-BM	\$1006					\$550	SMK4-30	+ \$115
DECO	23 1/8" x 30 1/8"	GC2430-4-SC-DE		N/A	\$1700	\$1436	\$1436	\$550	SMK4-30	+ \$115
DECO 3/4" BEVEL	23 1/8" x 30 1/8"	GC2430-4-SC-DE-BM		N/A	\$2315	\$2002	\$2002	\$550	SMK4-30	+ \$115
LEXINGTON	23 1/8" x 30 1/8"	GC2430-4-SC-LE		\$1643	\$1643	\$1415	\$1415	\$550	SMK4-30	+ \$115
LEXINGTON 3/4" BEVEL	23 1/8" x 30 1/8"	GC2430-4-SC-LE-BM		N/A	\$2259	\$1980	\$1980	\$550	SMK4-30	+ \$115
PARK AVE	23 1/4" x 30 1/4"	GC2430-4-SC-PA		\$1995	\$2000	\$1436	N/A	\$550	SMK4-30	+ \$115
PARK AVE 3/4" BEVEL	23 1/4" x 30 1/4"	GC2430-4-SC-PA-BM		N/A	\$2615	\$2002	N/A	\$550	SMK4-30	+ \$115
SOHO	23 1/8" x 30 1/8"	GC2430-4-SC-SO		N/A	\$1700	\$1436	\$1436	\$550	SMK4-30	+ \$115
SOHO 3/4" BEVEL	23 1/8" x 30 1/8"	GC2430-4-SC-SO-BM		N/A	\$2315	\$2002	\$2002	\$550	SMK4-30	+ \$115
TRINITY	23 1/8" x 30 1/8"	GC2430-4-SC-TR		\$1643	\$1643	\$1415	\$1415	\$550	SMK4-30	+ \$115
TRINITY 3/4" BEVEL	23 1/8" x 30 1/8"	GC2430-4-SC-TR-BM		N/A	\$2259	\$1980	\$1980	\$550	SMK4-30	+ \$115

### GC2430 24" Width x 30" Height 6" Depth - Rough Opening: 22 3/8" x 29 3/8"

Add \$550.00 to list price for Electric Option. See pages 1 and 2 for more details.

	Overall Dimension Width x Height	Model	Frameless Mirror	List Price				Electric Option (EL, ER)	Side Mirror Kit - Semi Recessed / Surface Mount	
				SB, IB	BN, PC, PN	OR	BB			
FLAT MIRROR	23" x 30"	GC2430-6-SC-FM	\$1379					\$550	SMRK2-30 / SMK6-30	+ \$115
BEVELED MIRROR	23" x 30"	GC2430-6-SC-BM	\$1439					\$550	SMRK2-30 / SMK6-30	+ \$115
DECO	23 1/8" x 30 1/8"	GC2430-6-SC-DE		N/A	\$2170	\$1869	\$1869	\$550	SMRK2-30 / SMK6-30	+ \$115
DECO 3/4" BEVEL	23 1/8" x 30 1/8"	GC2430-6-SC-DE-BM		N/A	\$2786	\$2436	\$2436	\$550	SMRK2-30 / SMK6-30	+ \$115
LEXINGTON	23 1/8" x 30 1/8"	GC2430-6-SC-LE		\$2076	\$2114	\$1847	\$1847	\$550	SMRK2-30 / SMK6-30	+ \$115
LEXINGTON 3/4" BEVEL	23 1/8" x 30 1/8"	GC2430-6-SC-LE-BM		N/A	\$2729	\$2413	\$2413	\$550	SMRK2-30 / SMK6-30	+ \$115
PARK AVE	23 1/4" x 30 1/4"	GC2430-6-SC-PA		\$2429	\$2470	\$1869	N/A	\$550	SMRK2-30 / SMK6-30	+ \$115
PARK AVE 3/4" BEVEL	23 1/4" x 30 1/4"	GC2430-6-SC-PA-BM		N/A	\$3086	\$2436	N/A	\$550	SMRK2-30 / SMK6-30	+ \$115
SOHO	23 1/8" x 30 1/8"	GC2430-6-SC-SO		N/A	\$2170	\$1869	\$1869	\$550	SMRK2-30 / SMK6-30	+ \$115
SOHO 3/4" BEVEL	23 1/8" x 30 1/8"	GC2430-6-SC-SO-BM		N/A	\$2786	\$2436	\$2436	\$550	SMRK2-30 / SMK6-30	+ \$115
TRINITY	23 1/8" x 30 1/8"	GC2430-6-SC-TR		\$2076	\$2114	\$1847	\$1847	\$550	SMRK2-30 / SMK6-30	+ \$115
TRINITY 3/4" BEVEL	23 1/8" x 30 1/8"	GC2430-6-SC-TR-BM		N/A	\$2729	\$2413	\$2413	\$550	SMRK2-30 / SMK6-30	+ \$115

Note: Product specifications and installation instruction sheets for all product models are available for download at [www.GlassCraftersMirroredCabinets.com](http://www.GlassCraftersMirroredCabinets.com).

For custom size cabinet orders, please contact GlassCrafters Inc. directly at [sales@glasscraftersinc.com](mailto:sales@glasscraftersinc.com) concerning delivery times and pricing.

Electric Option is not currently available for custom size cabinets. All sales for custom size cabinets are final.



## 2025 STANDARD MIRRORED CABINETS PRICE SHEETS

Price sheet includes, frameless and framed cabinets

Issued 7/1/25

### GC2436 24" Width x 36" Height 4" Depth - Rough Opening: 22 3/8" x 35 3/8"

Add \$550.00 to list price for Electric Option. See pages 1 and 2 for more details.

	Overall Dimension Width x Height	Model	Frameless Mirror	List Price				Electric Option (EL, ER)	Side Mirror Kit - Surface Mount	
				SB, IB	BN, PC, PN	OR	BB			
FLAT MIRROR	23" x 36"	GC2436-4-SC-FM	\$1095					\$550	SMK4-36	+ \$125
BEVELED MIRROR	23" x 36"	GC2436-4-SC-BM	\$1155					\$550	SMK4-36	+ \$125
DECO	23 1/8" x 36 1/8"	GC2436-4-SC-DE		N/A	\$1904	\$1609	\$1609	\$550	SMK4-36	+ \$125
DECO 3/4" BEVEL	23 1/8" x 36 1/8"	GC2436-4-SC-DE-BM		N/A	\$2519	\$2175	\$2175	\$550	SMK4-36	+ \$125
LEXINGTON	23 1/8" x 36 1/8"	GC2436-4-SC-LE		\$1824	\$1839	\$1582	\$1582	\$550	SMK4-36	+ \$125
LEXINGTON 3/4" BEVEL	23 1/8" x 36 1/8"	GC2436-4-SC-LE-BM		N/A	\$2454	\$2149	\$2149	\$550	SMK4-36	+ \$125
PARK AVE	23 1/4" x 36 1/4"	GC2436-4-SC-PA		\$2183	\$2204	\$1609	N/A	\$550	SMK4-36	+ \$125
PARK AVE 3/4" BEVEL	23 1/4" x 36 1/4"	GC2436-4-SC-PA-BM		N/A	\$2819	\$2175	N/A	\$550	SMK4-36	+ \$125
SOHO	23 1/8" x 36 1/8"	GC2436-4-SC-SO		N/A	\$1904	\$1609	\$1609	\$550	SMK4-36	+ \$125
SOHO 3/4" BEVEL	23 1/8" x 36 1/8"	GC2436-4-SC-SO-BM		N/A	\$2519	\$2175	\$2175	\$550	SMK4-36	+ \$125
TRINITY	23 1/8" x 36 1/8"	GC2436-4-SC-TR		\$1824	\$1839	\$1582	\$1582	\$550	SMK4-36	+ \$125
TRINITY 3/4" BEVEL	23 1/8" x 36 1/8"	GC2436-4-SC-TR-BM		N/A	\$2454	\$2149	\$2149	\$550	SMK4-36	+ \$125

### GC2436 24" Width x 36" Height 6" Depth - Rough Opening: 22 3/8" x 35 3/8"

Add \$550.00 to list price for Electric Option. See pages 1 and 2 for more details.

	Overall Dimension Width x Height	Model	Frameless Mirror	List Price				Electric Option (EL, ER)	Side Mirror Kit - Semi Recessed / Surface Mount	
				SB, IB	BN, PC, PN	OR	BB			
FLAT MIRROR	23" x 36"	GC2436-6-SC-FM	\$1526					\$550	SMRK2-36 / SMK6-36	+ \$125
BEVELED MIRROR	23" x 36"	GC2436-6-SC-BM	\$1587					\$550	SMRK2-36 / SMK6-36	+ \$125
DECO	23 1/8" x 36 1/8"	GC2436-6-SC-DE		N/A	\$2373	\$2040	\$2040	\$550	SMRK2-36 / SMK6-36	+ \$125
DECO 3/4" BEVEL	23 1/8" x 36 1/8"	GC2436-6-SC-DE-BM		N/A	\$2989	\$2608	\$2608	\$550	SMRK2-36 / SMK6-36	+ \$125
LEXINGTON	23 1/8" x 36 1/8"	GC2436-6-SC-LE		\$2255	\$2308	\$2014	\$2014	\$550	SMRK2-36 / SMK6-36	+ \$125
LEXINGTON 3/4" BEVEL	23 1/8" x 36 1/8"	GC2436-6-SC-LE-BM		N/A	\$2925	\$2582	\$2582	\$550	SMRK2-36 / SMK6-36	+ \$125
PARK AVE	23 1/4" x 36 1/4"	GC2436-6-SC-PA		\$2614	\$2673	\$2040	N/A	\$550	SMRK2-36 / SMK6-36	+ \$125
PARK AVE 3/4" BEVEL	23 1/4" x 36 1/4"	GC2436-6-SC-PA-BM		N/A	\$3289	\$2608	N/A	\$550	SMRK2-36 / SMK6-36	+ \$125
SOHO	23 1/8" x 36 1/8"	GC2436-6-SC-SO		N/A	\$2373	\$2040	\$2040	\$550	SMRK2-36 / SMK6-36	+ \$125
SOHO 3/4" BEVEL	23 1/8" x 36 1/8"	GC2436-6-SC-SO-BM		N/A	\$2989	\$2608	\$2608	\$550	SMRK2-36 / SMK6-36	+ \$125
TRINITY	23 1/8" x 36 1/8"	GC2436-6-SC-TR		\$2255	\$2308	\$2014	\$2014	\$550	SMRK2-36 / SMK6-36	+ \$125
TRINITY 3/4" BEVEL	23 1/8" x 36 1/8"	GC2436-6-SC-TR-BM		N/A	\$2925	\$2582	\$2582	\$550	SMRK2-36 / SMK6-36	+ \$125

Note: Product specifications and installation instruction sheets for all product models are available for download at [www.GlassCraftersMirroredCabinets.com](http://www.GlassCraftersMirroredCabinets.com).

For custom size cabinet orders, please contact GlassCrafters Inc. directly at [sales@glasscraftersinc.com](mailto:sales@glasscraftersinc.com) concerning delivery times and pricing.

Electric Option is not currently available for custom size cabinets. All sales for custom size cabinets are final.

## 2025 STANDARD MIRRORED CABINETS PRICE SHEETS

Price sheet includes, frameless and framed cabinets

Issued 7/1/25

### DECORATIVE FINISHES



Plated Polished  
Chrome (PC)



Plated Polished  
Nickel (PN)



Satin Brass (SB)



Brushed Nickel (BN)



Iron-Black (IB)

[Plated - Polished / Mirror Like Finish]

[Satin Finish]

[Brushed / Matte Finish]

[Powder Coated /  
Durable - Matte Finish]

### Full-Length Cabinet GC1672 16" Width x 72" Height 4" Depth - Rough Opening: 14 3/8" x 72 1/8"

	Overall Dimension Width x Height	Model	Frameless Mirror	List Price			Electric Option (EL, ER)	Side Mirror Kit - Semi Recessed / Surface Mount	
				SB	BN, PC, PN	IB			
FLAT MIRROR	15" x 72"	GC1672-4-SC-FM*	\$2450				N/A	SMK4-72	\$345
BEVELED MIRROR	15" x 72"	GC1672-4-SC-BM*	\$2496				N/A	SMK4-72	\$345
LEXINGTON	15 1/8" x 72 1/8"	GC1672-4-SC-LE*		\$3283	\$3681	\$3559	N/A	SMK4-72	\$345
PARK AVE	15 1/4" x 72 1/4"	GC1672-4-SC-PA*		\$3681	\$4075	\$3597	N/A	SMK4-72	\$345
TRINITY	15 1/8" x 72 1/8"	GC1672-4-SC-TR*		\$3283	\$3681	\$3559	N/A	SMK4-72	\$345

\* Handed door must be ordered with left or right side hinges. Add "L" or "R" to end of model code.

Note: Product specifications and installation instruction sheets for all product models are available for download at [www.GlassCraftersMirroredCabinets.com](http://www.GlassCraftersMirroredCabinets.com). Full-Length handle accessory comes standard with frameless cabinet only. For custom size cabinet orders, please contact GlassCrafters Inc. directly at [sales@glasscraftersinc.com](mailto:sales@glasscraftersinc.com) concerning delivery times and pricing. All sales for custom size cabinets are final.



Electric Option currently not available for this unit

## 2025 STANDARD MIRRORED CABINETS PRICE SHEETS

Price sheet includes, frameless and framed cabinets

Issued 7/1/25

### Full-Length Cabinet GC1672 16" Width x 72" Height 6" Depth - Rough Opening: 14 3/8" x 72 1/8"

	Overall Dimension Width x Height	Model	List Price				Electric Option (EL, ER)	Side Mirror Kit - Semi Recessed / Surface Mount	
			Frameless Mirror	SB	BN, PC, PN	IB			
FLAT MIRROR	15" x 72"	GC1672-6-SC-FM*	\$2582				N/A	SMRK2-72 / SMK6-72	\$345 / \$400
BEVELED MIRROR	15" x 72"	GC1672-6-SC-BM*	\$2634				N/A	SMRK2-72 / SMK6-72	\$345 / \$400
LEXINGTON	15 1/8" x 72 1/8"	GC1672-6-SC-LE*		\$3421	\$3825	\$3908	N/A	SMRK2-72 / SMK6-72	\$345 / \$400
PARK AVE	15 1/4" x 72 1/4"	GC1672-6-SC-PA*		\$3813	\$4219	\$3945	N/A	SMRK2-72 / SMK6-72	\$345 / \$400
TRINITY	15 1/8" x 72 1/8"	GC1672-6-SC-TR*		\$3421	\$3825	\$3908	N/A	SMRK2-72 / SMK6-72	\$345 / \$400

\* Handed door must be ordered with left or right side hinges. Add "L" or "R" to end of model code.

### Full-Length Cabinet GC2072 20" Width x 72" Height 4" Depth - Rough Opening: 18 3/8" x 72 1/8"

	Overall Dimension Width x Height	Model	List Price				Electric Option (EL, ER)	Side Mirror Kit - Surface Mount	
			Frameless Mirror	SB	BN, PC, PN	IB			
FLAT MIRROR	19" x 72"	GC2072-4-SC-FM*	\$2542				N/A	SMK4-72	\$345
BEVELED MIRROR	19" x 72"	GC2072-4-SC-BM*	\$2582				N/A	SMK4-72	\$345
LEXINGTON	19 1/8" x 72 1/8"	GC2072-4-SC-LE*		\$3416	\$3831	\$3920	N/A	SMK4-72	\$345
PARK AVE	19 1/4" x 72 1/4"	GC2072-4-SC-PA*		\$3813	\$4225	\$3961	N/A	SMK4-72	\$345
TRINITY	19 1/8" x 72 1/8"	GC2072-4-SC-TR*		\$3416	\$3831	\$3920	N/A	SMK4-72	\$345

\* Handed door must be ordered with left or right side hinges. Add "L" or "R" to end of model code.

### Full-Length Cabinet GC2072 20" Width x 72" Height 6" Depth - Rough Opening: 18 3/8" x 72 1/8"

	Overall Dimension Width x Height	Model	List Price				Electric Option (EL, ER)	Side Mirror Kit - Semi Recessed / Surface Mount	
			Frameless Mirror	SB	BN, PC, PN	IB			
FLAT MIRROR	19" x 72"	GC2072-6-SC-FM*	\$2766				N/A	SMRK2-72 / SMK6-72	\$345 / \$400
BEVELED MIRROR	19" x 72"	GC2072-6-SC-BM*	\$2806				N/A	SMRK2-72 / SMK6-72	\$345 / \$400
LEXINGTON	19 1/8" x 72 1/8"	GC2072-6-SC-LE*		\$3640	\$4075	\$4304	N/A	SMRK2-72 / SMK6-72	\$345 / \$400
PARK AVE	19 1/4" x 72 1/4"	GC2072-6-SC-PA*		\$4038	\$4469	\$4345	N/A	SMRK2-72 / SMK6-72	\$345 / \$400
TRINITY	19 1/8" x 72 1/8"	GC2072-6-SC-TR*		\$3640	\$4075	\$4304	N/A	SMRK2-72 / SMK6-72	\$345 / \$400

\* Handed door must be ordered with left or right side hinges. Add "L" or "R" to end of model code.

Note: Product specifications and installation instruction sheets for all product models are available for download at [www.GlassCraftersMirroredCabinets.com](http://www.GlassCraftersMirroredCabinets.com).

Full-Length handle accessory comes standard with frameless cabinet only. For custom size cabinet orders, please contact

GlassCrafters Inc. directly at [sales@glasscraftersinc.com](mailto:sales@glasscraftersinc.com) concerning delivery times and pricing. All sales for custom size cabinets are final.



Electric Option currently not available for this unit

## 2025 STANDARD MIRRORED CABINETS PRICE SHEETS

Issued 7/1/25

Price sheet includes, frameless and framed cabinets

### Tri-view Cabinet GC3630 36" Width x 30" Height 4" Depth - Rough Opening: 35 3/8" x 29 3/8"

	Overall Dimension Width x Height	Model	List Price	Electric Option (EL, ER)	Side Mirror Kit - Surface Mount	
FLAT MIRROR	36" x 30"	GC3630-4-SC-FM-TRI	\$1576	N/A	SMK4-30	+ \$115
BEVELED MIRROR	36" x 30"	GC3630-4-SC-BM-TRI	\$1658	N/A	SMK4-30	+ \$115

### Tri-view Cabinet GC3636 36" Width x 36" Height 4" Depth - Rough Opening: 35 3/8" x 35 3/8"

	Overall Dimension Width x Height	Model	List Price	Electric Option (EL, ER)	Side Mirror Kit - Surface Mount	
FLAT MIRROR	36" x 36"	GC3636-4-SC-FM-TRI	\$1,741	N/A	SMK4-36	+ \$125
BEVELED MIRROR	36" x 36"	GC3636-4-SC-BM-TRI	\$1,824	N/A	SMK4-36	+ \$125

### Tri-view Cabinet GC4830 48" Width x 30" Height 4" Depth - Rough Opening: 47 3/8" x 29 3/8"

	Overall Dimension Width x Height	Model	List Price	Electric Option (EL, ER)	Side Mirror Kit - Surface Mount	
FLAT MIRROR	48" x 30"	GC4830-4-SC-FM-TRI	\$1741	N/A	SMK4-36	+ \$115
BEVELED MIRROR	48" x 30"	GC4830-4-SC-BM-TRI	\$1824	N/A	SMK4-36	+ \$115

### Tri-view Cabinet GC4836 48" Width x 36" Height 4" Depth - Rough Opening: 47 3/8" x 35 3/8"

	Overall Dimension Width x Height	Model	List Price	Electric Option (EL, ER)	Side Mirror Kit - Surface Mount	
FLAT MIRROR	48" x 36"	GC4836-4-SC-FM-TRI	\$1990	N/A	SMK4-36	+ \$125
BEVELED MIRROR	48" x 36"	GC4836-4-SC-BM-TRI	\$2072	N/A	SMK4-36	+ \$125

Note: Product specifications and installation instruction sheets for all product models are available for download at [www.GlassCraftersMirroredCabinets.com](http://www.GlassCraftersMirroredCabinets.com).

For custom size cabinet orders, please contact GlassCrafters Inc. directly at [sales@glasscraftersinc.com](mailto:sales@glasscraftersinc.com) concerning delivery times and pricing.

All sales for custom size cabinets are final.



## 2025 STANDARD MIRRORED CABINETS PRICE SHEETS

Price sheet includes, frameless and framed cabinets

Issued 7/1/25

### Vertical Tier Mirrored Cabinet 4" Depth (Flat Mirror / Beveled Mirror)

\*\*Add \$550.00 to list price for Electric Option. See pages 1 and 2 for more details.

Overall Dimension Width x Height	Model	List Price		Electric Option (EL, ER)	Side Mirror Kit - Surface Mount	
		Flat Mirror	Beveled Mirror			
15" x 54 3/4"	VTS-1654-4-SC-FM	\$1610	\$1750	\$550	SRMK4-54	+ \$345
15" x 60 3/4"	VTS-1660-4-SC-FM	\$1682	\$1796	\$550	SRMK4-60	+ \$345
15" x 66 3/4"	VTS-1666-4-SC-FM	\$1830	\$1944	\$550	SRMK4-66	+ \$345
15" x 72 3/4"	VTS-1672-4-SC-FM	\$1978	\$2091	\$550	SRMK4-72	+ \$345
19" x 60 3/4"	VTS-2060-4-SC-FM	\$1802	\$1914	\$550	SRMK4-60	+ \$345
19" x 66 3/4"	VTS-2066-4-SC-FM	\$1950	\$2062	\$550	SRMK4-66	+ \$345
19" x 72 3/4"	VTS-2072-4-SC-FM	\$2096	\$2209	\$550	SRMK4-72	+ \$345
23" x 60 3/4"	VTS-2460-4-SC-FM	\$1984	\$2103	\$550	SRMK4-60	+ \$345
23" x 66 3/4"	VTS-2466-4-SC-FM	\$2132	\$2249	\$550	SRMK4-66	+ \$345
23" x 72 3/4"	VTS-2472-4-SC-FM	\$2280	\$2399	\$550	SRMK4-72	+ \$345

\* Available with 3/4" bevel mirror, change "FM" to "BM" in the model code.

### Vertical Tier Mirrored Cabinet 6" Depth (Flat Mirror / Beveled Mirror)

\*\*Add \$550.00 to list price for Electric Option. See pages 1 and 2 for more details.

Overall Dimension Width x Height	Model	List Price		Option (EL, ER)	Side Mirror Kit - Semi Recessed / Surface Mount	
		Flat Mirror	Beveled Mirror			
15" x 60 3/4"	VTS-1660-6-SC-FM	\$2326	\$2427	\$550	SRMK2-60 / SRMK6-60	+ \$345 / + \$400
15" x 66 3/4"	VTS-1666-6-SC-FM	\$2477	\$2583	\$550	SRMK2-66 / SRMK6-66	+ \$345 / + \$400
15" x 72 3/4"	VTS-1672-6-SC-FM	\$2625	\$2736	\$550	SRMK2-72 / SRMK6-72	+ \$345 / + \$400
19" x 60 3/4"	VTS-2060-6-SC-FM	\$2451	\$2563	\$550	SRMK2-60 / SRMK6-60	+ \$345 / + \$400
19" x 66 3/4"	VTS-2066-6-SC-FM	\$2506	\$2619	\$550	SRMK2-66 / SRMK6-66	+ \$345 / + \$400
19" x 72 3/4"	VTS-2072-6-SC-FM	\$2745	\$2858	\$550	SRMK2-72 / SRMK6-72	+ \$345 / + \$400
23" x 60 3/4"	VTS-2460-6-SC-FM	\$2631	\$2752	\$550	SRMK2-60 / SRMK6-60	+ \$345 / + \$400
23" x 66 3/4"	VTS-2466-6-SC-FM	\$2780	\$2899	\$550	SRMK2-66 / SRMK6-66	+ \$345 / + \$400
23" x 72 3/4"	VTS-2472-6-SC-FM	\$2928	\$3048	\$550	SRMK2-72 / SRMK6-72	+ \$345 / + \$400

\* Available with 3/4" bevel mirror, change "FM" to "BM" in the model code.

\*\* Please contact GlassCrafters Inc. directly to order a Vertical Tier Mirrored Cabinet with Electric Option

Rough Opening Height: Overall cabinet height (minus) 3/8" = R.O. Height for VTS

Example: Two (2) 30" height cabinets = 60 3/4" Total height (minus) 3/8" = Rough Opening: 60 3/8"

Note: Rough opening sizes are listed on GlassCrafters' product specification sheets. Product specifications and installation instruction sheets for all product models are available for download at [www.GlassCraftersMirroredCabinets.com](http://www.GlassCraftersMirroredCabinets.com).

For custom size cabinet orders, please contact GlassCrafters Inc. directly at [sales@glasscraftersinc.com](mailto:sales@glasscraftersinc.com) concerning delivery times and pricing.

Electric Option is not currently available for custom size cabinets. All sales for custom size cabinets are final.

Carefully confirm all parts and read installation instructions before you start. Please refer to the specific installation sheet for the parts list and item counts for each model number. Please make note of the list price per piece. Contact GlassCrafters for additional shipping charges.

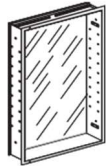

1

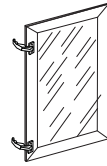

2



3



4

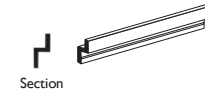

5



6

DESCRIPTION	CABINET	DOOR (BOXED SEPARATELY)	PLASTIC WALL ANCHORS	WALL ANCHOR SCREWS	BOTTOM SURFACE MOUNT WALL BRACKET	TOP SURFACE MOUNT BRACKET
PART #	GCXXXX-X-Cab	GCXXXX-X-D	#10 PWA	#10 X 1.5 Phillips	414-03	425-00
LIST PRICE	Consult GlassCrafters	Consult GlassCrafters	\$0.60	\$0.60	\$14.00	\$5.20



7



8



9

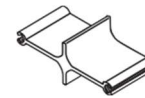

10

Note:  
24" = 2  
30" = 2  
36" = 3  
72" = 3

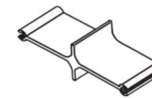

11



12

DESCRIPTION	SCREW CAPS	SHELF CLIP	HOLE PLUGS	4" DEEP CABINET CONNECTOR	6" DEEP CABINET CONNECTOR	CABINET CONNECTOR MOUNTING SCREW
PART #	434-00	439-01	433-00	426-00	429-00	18-85510-32x.5
LIST PRICE	\$0.60	\$2.00	\$0.60	\$14.00	\$18.00	\$0.60



13



14

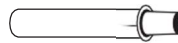

15



16



17

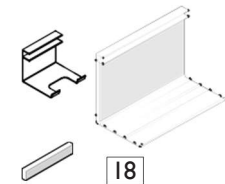

18

DESCRIPTION	HINGE COVER NAME PLATE	30 DEGREE LIMIT CLIP	SOFT CLOSE CUSHION	3X MAGNIFICATION MIRROR	FULL-LENGTH DOOR HANDLE	4" DEEP CABINET ACCESSORY KIT
PART #	904-00	901-00	900-00	950-01	GCCH-01	GCMCA-04-01
LIST PRICE	\$4.00	\$2.00	\$15.00	\$40.00	\$35.00	\$64.00



# PARTS LIST - MİRRORED CABINET

Issued 7/1/25

Carefully confirm all parts and read installation instructions before you start. Please refer to the specific installation sheet for the parts list and item counts for each model number. Please make note of the list price per piece. Contact GlassCrafters for additional shipping charges.

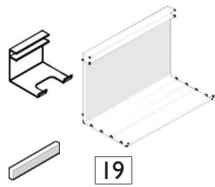

DESCRIPTION	6" DEEP CABINET ACCESSORY KIT
PART #	GCMCA-06-01
LIST PRICE	\$75.00



GLASSCRAFTERS INC.

## PARTS LIST - GLASS SHELF

Issued 7/1/25

Each glass shelf will require four (4) shelf clips. Use care when handling non-tempered glass.

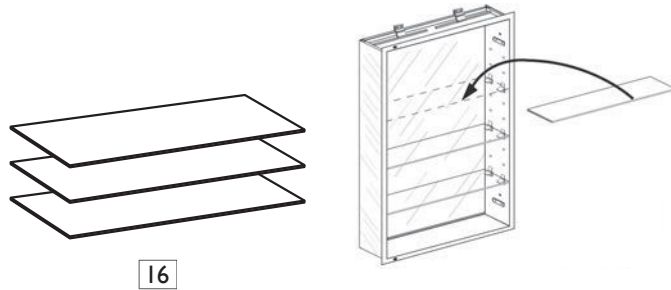

Note:  
 24" Height Series- 2 Shelves  
 30" Height Series- 3 Shelves  
 36" Height Series- 4 Shelves  
 72" Height Series- 8 Shelves

DESCRIPTION	CLEAR GLASS SHELF ONLY					
PART #	417-01-A	417-06-A	417-02-A	417-07-A	417-03-A	417-08-A
MODEL	16W x 4" Deep	16W x 6" Deep	20W x 4" Deep	20W x 6" Deep	24W x 4" Deep	24W x 6" Deep
SHELF SIZE	3 7/16" x 13 1/4"	5 7/16" x 13 1/4"	3 7/16" x 17 1/4"	5 7/16" x 17 1/4"	3 7/16" x 21 1/4"	5 7/16" x 21 1/4"
LIST PRICE	\$30.00	\$35.00	\$40.00	\$46.00	\$52.00	\$58.00



## 2025 STANDARD WALL MIRRORS PRICE SHEETS

Issued 7/1/25

Price sheet includes, frameless and framed wall mirrors

Four choices of frameless wall mirrors are available to complete a horizontal combination of surface-mounted mirrored cabinets or as a stand-alone mirror to complement a hallway or powder room. The wall mirrors include all necessary installation hardware. When adding the frameless mirror to a combination of surface mounted cabinets, please refer to page 19 to add a glass shelf under the center mirror. Custom sizes available, consult GlassCrafters for size, price and availability. Note: All Wall Mirrors come equipped with hanging hardware attached. It is important to specify either a vertical or horizontal orientation when ordering Wall Mirrors from GlassCrafters.

### CENTER MIRRORS

#### Decorative Frameless Mirrors

##### 24" Height (Flat Mirror / Beveled Mirror)

Overall Dimension Width x Height	Model	List Price	
		Flat Mirror	Beveled Mirror
15" x 24"	C-FM-1624*	\$529	\$588
19" x 24"	C-FM-2024*	\$552	\$617
23" x 24"	C-FM-2424*	\$575	\$646

\* Available with 3/4" bevel mirror, change "FM" to "BM" in the model code.

#### Decorative Frameless Mirrors

##### 30" Height (Flat Mirror / Beveled Mirror)

Overall Dimension Width x Height	Model	List Price	
		Flat Mirror	Beveled Mirror
15" x 30"	C-FM-1630*	\$541	\$609
19" x 30"	C-FM-2030*	\$564	\$638
23" x 30"	C-FM-2430*	\$587	\$667
26" x 30"	C-FM-2630*	\$598	\$681
30" x 30"	C-FM-3030*	\$610	\$698
34" x 30"	C-FM-3430*	\$621	\$716

\* Available with 3/4" bevel mirror, change "FM" to "BM" in the model code.

Note: Product specifications and installation instruction sheets for all product models are available for download at [www.GlassCraftersMirroredCabinets.com](http://www.GlassCraftersMirroredCabinets.com).

For custom size wall mirror orders, please contact GlassCrafters Inc. directly at [sales@glasscraftersinc.com](mailto:sales@glasscraftersinc.com) concerning delivery times and pricing.

All sales for custom size wall mirrors are final.



## 2025 STANDARD WALL MIRRORS PRICE SHEETS

Price sheet includes, frameless and framed wall mirrors

Issued 7/1/25

### CENTER MIRRORS

#### Decorative Frameless Mirrors

#### 36" Height (Flat Mirror / Beveled Mirror)

Overall Dimension Width x Height	Model	List Price	
		Flat Mirror	Beveled Mirror
15" x 36"	C-FM-1636*	\$552	\$629
19" x 36"	C-FM-2036*	\$575	\$658
23" x 36"	C-FM-2436*	\$598	\$687
26" x 36"	C-FM-2636*	\$610	\$701
30" x 36"	C-FM-3036*	\$621	\$719
34" x 36"	C-FM-3436*	\$633	\$736

\* Available with 3/4" bevel mirror, change "FM" to "BM" in the model code.

Note: Product specifications and installation instruction sheets for all product models are available for download at [www.GlassCraftersMirroredCabinets.com](http://www.GlassCraftersMirroredCabinets.com).

For custom size wall mirror orders, please contact GlassCrafters Inc. directly at [sales@glasscraftersinc.com](mailto:sales@glasscraftersinc.com) concerning delivery times and pricing.

All sales for custom size wall mirrors are final.

Price sheet includes, frameless and framed wall mirrors

GlassCrafters offers five choices of decorative framed wall mirrors to complement your design. Traditional, Contemporary or Transitional, GlassCrafters has the right look for you. The decorative framed wall mirrors include all necessary installation hardware. Custom sizes available up to 36" x 36", consult GlassCrafters for size, price and availability. Note: All Wall Mirrors come equipped with hanging hardware attached. It is important to specify either a vertical or horizontal orientation when ordering Wall Mirrors from GlassCrafters.

## DECORATIVE FINISHES



Plated Polished  
Chrome (PC)



Plated Polished  
Nickel (PN)



Satin Brass (SB)



Brushed Nickel (BN)



Brushed Bronze (BB)



Iron-Black (IB)

[Plated - Polished / Mirror Like Finish]

[Satin Finish]

[Brushed / Matte Finish]

[Powder Coated /  
Durable - Matte Finish]

## Decorative Framed Mirrors 16" Width x 24" Height

	Overall Dimension Width x Height	Model	List Price			
			SB, IB	BN, PC, PN	OR	BB
LEXINGTON	15 1/8" x 24 1/8"	DF-FM-1624-LE	\$ 1,152	\$ 1,122	\$ 946	\$ 946
LEXINGTON 3/4" BEVEL	15 1/8" x 24 1/8"	DF-BM-1624-LE	\$ 1,211	\$ 1,181	\$ 1,005	\$ 1,005
PARK AVE	15 1/4" x 24 1/4"	DF-FM-1624-PA	\$ 1,490	\$ 1,465	\$ 964	N/A
PARK AVE 3/4" BEVEL	15 1/4" x 24 1/4"	DF-BM-1624-PA	\$ 1,549	\$ 1,524	\$ 1,023	N/A
TRINITY	15 1/8" x 24 1/8"	DF-FM-1624-TR	\$ 1,152	\$ 1,122	\$ 946	\$ 946
TRINITY 3/4" BEVEL	15 1/8" x 24 1/8"	DF-BM-1624-TR	\$ 1,211	\$ 1,181	\$ 1,005	\$ 1,005

Note: Product specifications and installation instruction sheets for all product models are available for download at [www.GlassCraftersMirroredCabinets.com](http://www.GlassCraftersMirroredCabinets.com).

For custom size cabinet orders, please contact GlassCrafters Inc. directly at [sales@glasscraftersinc.com](mailto:sales@glasscraftersinc.com) concerning delivery times and pricing.

Electric Option is not currently available for custom size cabinets. All sales for custom size cabinets are final.



## 2025 STANDARD WALL MIRRORS PRICE SHEETS

Price sheet includes, frameless and framed wall mirrors

Issued 7/1/25

### Decorative Framed Mirrors 16" Width x 30" Height

	Overall Dimension Width x Height	Model	List Price			
			SB, IB	BN, PC, PN	OR	BB
LEXINGTON	15 1/8" x 30 1/8"	DF-FM-1630-LE	\$ 1,195	\$ 1,179	\$ 980	\$ 980
LEXINGTON 3/4" BEVEL	15 1/8" x 30 1/8"	DF-BM-1630-LE	\$ 1,263	\$ 1,247	\$ 1,048	\$ 1,048
PARK AVE	15 1/4" x 30 1/4"	DF-FM-1630-PA	\$ 1,540	\$ 1,528	\$ 1,000	N/A
PARK AVE 3/4" BEVEL	15 1/4" x 30 1/4"	DF-BM-1630-PA	\$ 1,608	\$ 1,596	\$ 1,068	N/A
TRINITY	15 1/8" x 30 1/8"	DF-FM-1630-TR	\$ 1,195	\$ 1,179	\$ 980	\$ 980
TRINITY 3/4" BEVEL	15 1/8" x 30 1/8"	DF-BM-1630-TR	\$ 1,263	\$ 1,247	\$ 1,048	\$ 1,048

### Decorative Framed Mirrors 16" Width x 36" Height

	Overall Dimension Width x Height	Model	List Price			
			SB, IB	BN, PC, PN	OR	BB
LEXINGTON	15 1/8" x 36 1/8"	DF-FM-1636-LE	\$ 1,239	\$ 1,238	\$ 1,012	\$ 1,012
LEXINGTON 3/4" BEVEL	15 1/8" x 36 1/8"	DF-BM-1636-LE	\$ 1,316	\$ 1,315	\$ 1,089	\$ 1,089
PARK AVE	15 1/4" x 36 1/4"	DF-FM-1636-PA	\$ 1,590	\$ 1,593	\$ 1,035	N/A
PARK AVE 3/4" BEVEL	15 1/4" x 36 1/4"	DF-BM-1636-PA	\$ 1,667	\$ 1,667	\$ 1,112	N/A
TRINITY	15 1/8" x 36 1/8"	DF-FM-1636-TR	\$ 1,239	\$ 1,238	\$ 1,012	\$ 1,012
TRINITY 3/4" BEVEL	15 1/8" x 36 1/8"	DF-BM-1636-TR	\$ 1,316	\$ 1,315	\$ 1,089	\$ 1,089

Note: Product specifications and installation instruction sheets for all product models are available for download at [www.GlassCraftersMirroredCabinets.com](http://www.GlassCraftersMirroredCabinets.com).

For custom size cabinet orders, please contact GlassCrafters Inc. directly at [sales@glasscraftersinc.com](mailto:sales@glasscraftersinc.com) concerning delivery times and pricing.

Electric Option is not currently available for custom size cabinets. All sales for custom size cabinets are final.



## 2025 STANDARD WALL MIRRORS PRICE SHEETS

Price sheet includes, frameless and framed wall mirrors

Issued 7/1/25

### Decorative Framed Mirrors 20" Width x 30" Height

	Overall Dimension Width x Height	Model	List Price			
			SB, IB	BN, PC, PN	OR	BB
DECO	19 1/8" x 30 1/8"	DF-FM-2030-DE	N/A	\$ 1,283	\$ 1,039	\$ 1,039
DECO 3/4" BEVEL	19 1/8" x 30 1/8"	DF-BM-2030-DE	N/A	\$ 1,357	\$ 1,113	\$ 1,113
LEXINGTON	19 1/8" x 30 1/8"	DF-FM-2030-LE	\$ 1,240	\$ 1,229	\$ 1,018	\$ 1,018
LEXINGTON 3/4" BEVEL	19 1/8" x 30 1/8"	DF-BM-2030-LE	\$ 1,314	\$ 1,303	\$ 1,092	\$ 1,092
PARK AVE	19 1/4" x 30 1/4"	DF-FM-2030-PA	\$ 1,588	\$ 1,583	\$ 1,039	N/A
PARK AVE 3/4" BEVEL	19 1/4" x 30 1/4"	DF-BM-2030-PA	\$ 1,662	\$ 1,657	\$ 1,113	N/A
SOHO	19 1/8" x 30 1/8"	DF-FM-2030-SO	N/A	\$ 1,283	\$ 1,039	\$ 1,039
SOHO 3/4" BEVEL	19 1/8" x 30 1/8"	DF-BM-2030-SO	N/A	\$ 1,357	\$ 1,113	\$ 1,113
TRINITY	19 1/8" x 30 1/8"	DF-FM-2030-TR	\$ 1,240	\$ 1,229	\$ 1,018	\$ 1,018
TRINITY 3/4" BEVEL	19 1/8" x 30 1/8"	DF-BM-2030-TR	\$ 1,314	\$ 1,303	\$ 1,092	\$ 1,092

### Decorative Framed Mirrors 20" Width x 36" Height

	Overall Dimension Width x Height	Model	List Price			
			SB, IB	BN, PC, PN	OR	BB
DECO	19 1/8" x 36 1/8"	DF-FM-2036-DE	N/A	\$ 1,348	\$ 1,074	\$ 1,074
DECO 3/4" BEVEL	19 1/8" x 36 1/8"	DF-BM-2036-DE	N/A	\$ 1,431	\$ 1,157	\$ 1,157
LEXINGTON	19 1/8" x 36 1/8"	DF-FM-2036-LE	\$ 1,282	\$ 1,288	\$ 1,050	\$ 1,050
LEXINGTON 3/4" BEVEL	19 1/8" x 36 1/8"	DF-BM-2036-LE	\$ 1,365	\$ 1,371	\$ 1,133	\$ 1,133
PARK AVE	19 1/4" x 36 1/4"	DF-FM-2036-PA	\$ 1,637	\$ 1,648	\$ 1,074	N/A
PARK AVE 3/4" BEVEL	19 1/4" x 36 1/4"	DF-BM-2036-PA	\$ 1,720	\$ 1,731	\$ 1,157	N/A
SOHO	19 1/8" x 36 1/8"	DF-FM-2036-SO	N/A	\$ 1,348	\$ 1,074	\$ 1,074
SOHO 3/4" BEVEL	19 1/8" x 36 1/8"	DF-BM-2036-SO	N/A	\$ 1,431	\$ 1,157	\$ 1,157
TRINITY	19 1/8" x 36 1/8"	DF-FM-2036-TR	\$ 1,282	\$ 1,288	\$ 1,050	\$ 1,050
TRINITY 3/4" BEVEL	19 1/8" x 36 1/8"	DF-BM-2036-TR	\$ 1,365	\$ 1,371	\$ 1,133	\$ 1,133

Note: Product specifications and installation instruction sheets for all product models are available for download at [www.GlassCraftersMirroredCabinets.com](http://www.GlassCraftersMirroredCabinets.com).

For custom size cabinet orders, please contact GlassCrafters Inc. directly at [sales@glasscraftersinc.com](mailto:sales@glasscraftersinc.com) concerning delivery times and pricing.

Electric Option is not currently available for custom size cabinets. All sales for custom size cabinets are final.



## 2025 STANDARD WALL MIRRORS PRICE SHEETS

Price sheet includes, frameless and framed wall mirrors

Issued 7/1/25

### Decorative Framed Mirrors 24" Width x 30" Height

	Overall Dimension Width x Height	Model	List Price			
			SB, IB	BN, PC, PN	OR	BB
DECO	23 1/8" x 30 1/8"	DF-FM-2430-DE	N/A	\$ 1,341	\$ 1,077	\$ 1,077
DECO 3/4" BEVEL	23 1/8" x 30 1/8"	DF-BM-2430-DE	N/A	\$ 1,421	\$ 1,157	\$ 1,157
LEXINGTON	23 1/8" x 30 1/8"	DF-FM-2430-LE	\$ 1,284	\$ 1,284	\$ 1,056	\$ 1,056
LEXINGTON 3/4" BEVEL	23 1/8" x 30 1/8"	DF-BM-2430-LE	\$ 1,364	\$ 1,364	\$ 1,136	\$ 1,136
PARK AVE	23 1/4" x 30 1/4"	DF-FM-2430-PA	\$ 1,636	\$ 1,641	\$ 1,077	N/A
PARK AVE 3/4" BEVEL	23 1/4" x 30 1/4"	DF-BM-2430-PA	\$ 1,716	\$ 1,721	\$ 1,157	N/A
SOHO	23 1/8" x 30 1/8"	DF-FM-2430-SO	N/A	\$ 1,341	\$ 1,077	\$ 1,077
SOHO 3/4" BEVEL	23 1/8" x 30 1/8"	DF-BM-2430-SO	N/A	\$ 1,421	\$ 1,157	\$ 1,157
TRINITY	23 1/8" x 30 1/8"	DF-FM-2430-TR	\$ 1,284	\$ 1,284	\$ 1,056	\$ 1,056
TRINITY 3/4" BEVEL	23 1/8" x 30 1/8"	DF-BM-2430-TR	\$ 1,364	\$ 1,364	\$ 1,136	\$ 1,136

### Decorative Framed Mirrors 24" Width x 36" Height

	Overall Dimension Width x Height	Model	List Price			
			SB, IB	BN, PC, PN	OR	BB
DECO	23 1/8" x 36 1/8"	DF-FM-2436-DE	N/A	\$ 1,407	\$ 1,112	\$ 1,112
DECO 3/4" BEVEL	23 1/8" x 36 1/8"	DF-BM-2436-DE	N/A	\$ 1,496	\$ 1,201	\$ 1,201
LEXINGTON	23 1/8" x 36 1/8"	DF-FM-2436-LE	\$ 1,327	\$ 1,342	\$ 1,085	\$ 1,085
LEXINGTON 3/4" BEVEL	23 1/8" x 36 1/8"	DF-BM-2436-LE	\$ 1,416	\$ 1,431	\$ 1,174	\$ 1,174
PARK AVE	23 1/4" x 36 1/4"	DF-FM-2436-PA	\$ 1,686	\$ 1,707	\$ 1,112	N/A
PARK AVE 3/4" BEVEL	23 1/4" x 36 1/4"	DF-BM-2436-PA	\$ 1,775	\$ 1,796	\$ 1,201	N/A
SOHO	23 1/8" x 36 1/8"	DF-FM-2436-SO	N/A	\$ 1,407	\$ 1,112	\$ 1,112
SOHO 3/4" BEVEL	23 1/8" x 36 1/8"	DF-BM-2436-SO	N/A	\$ 1,496	\$ 1,201	\$ 1,201
TRINITY	23 1/8" x 36 1/8"	DF-FM-2436-LE	\$ 1,327	\$ 1,342	\$ 1,085	\$ 1,085
TRINITY 3/4" BEVEL	23 1/8" x 36 1/8"	DF-BM-2436-TR	\$ 1,416	\$ 1,431	\$ 1,174	\$ 1,174

Note: Product specifications and installation instruction sheets for all product models are available for download at [www.GlassCraftersMirroredCabinets.com](http://www.GlassCraftersMirroredCabinets.com).

For custom size cabinet orders, please contact GlassCrafters Inc. directly at [sales@glasscraftersinc.com](mailto:sales@glasscraftersinc.com) concerning delivery times and pricing.

Electric Option is not currently available for custom size cabinets. All sales for custom size cabinets are final.

GlassCrafters offers an extensive array of glass shelving sizes to fit your bath dimensions. Combine two surface-mounted cabinets with a center wall mirror and glass shelf kit for greater storage and a custom appearance. The center mirror shelf kit includes all necessary installation hardware. Standard glass thickness is 1/2”.

For matching size center mirrors in a variety of styles see the Decorative Frameless Mirror page

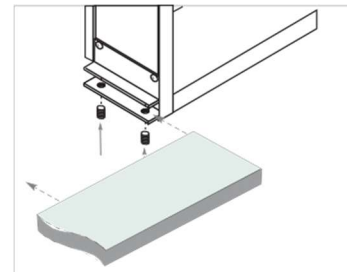
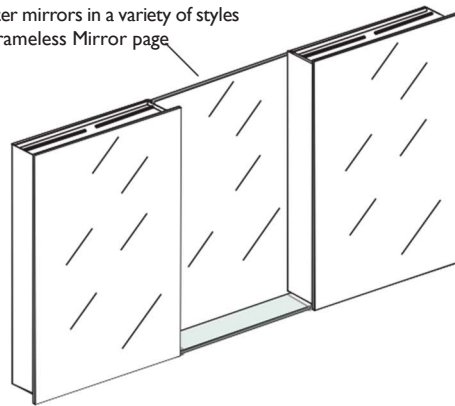

### Center Mirror Glass Shelf 4” Depth

Overall Dimension Width x Height	Model	List Price
15" x 3 3/4"	GS-16-4	\$150
19" x 3 3/4"	GS-20-4	\$175
23" x 3 3/4"	GS-24-4	\$200
26" x 3 3/4"	GS-26-4	\$225
30" x 3 3/4"	GS-30-4	\$250
36" x 3 3/4"	GS-34-4	\$275

### Center Mirror Glass Shelf 6” Depth

Overall Dimension Width x Height	Model	List Price
15" x 5 3/4"	GS-16-6	\$195
19" x 5 3/4"	GS-20-6	\$220
23" x 5 3/4"	GS-24-6	\$245
26" x 5 3/4"	GS-26-6	\$270
30" x 5 3/4"	GS-30-6	\$295
36" x 5 3/4"	GS-34-6	\$320

NEW

## ULTRA THIN, ILLUMINATED WALL MIRROR COLLECTION

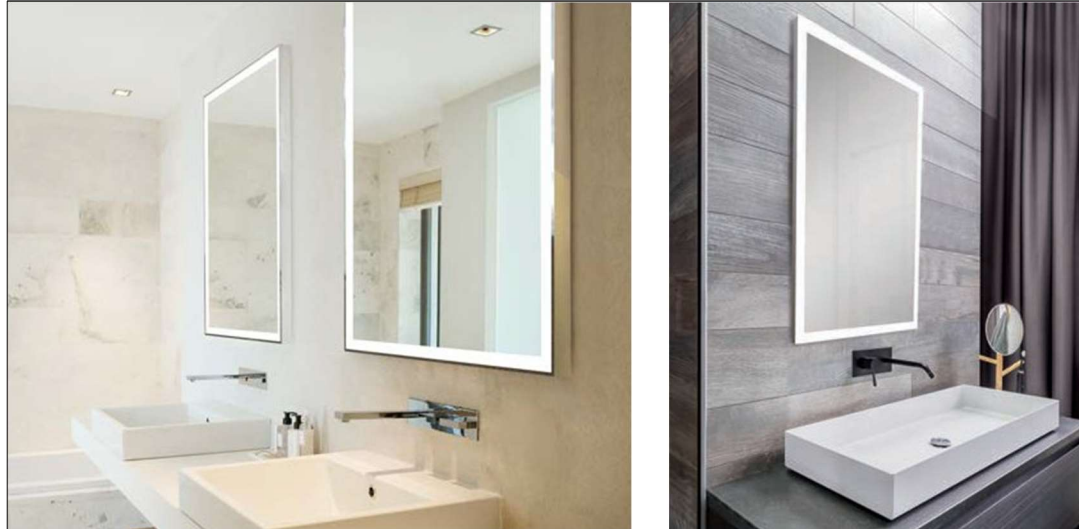

Tribeca Framed Illuminated Mirror  
With Polished Chrome Finish

Chelsea Frameless  
Illuminated Mirror

### Illuminated Mirror features:

- Low Profile Design
- High Output Dimmable LED Light Source
- Natural White Light (3000 Kelvin)
- Ideal Color Rendering Index (90+ CRI)
- Mirror Defogger
- Available In Three Convenient Sizes
- Frame Is Available In Seven Finishes
- Uses Standard Wall Switch CL Dimmers
- Easy To Install
- ELT Certification

The Chelsea Collection illuminated mirror with Tribeca decorative frame by GlassCrafters offers superior light functionality that is unparalleled. Delivering high output, dimmable LED, warm white light with built-in mirror defogger, the illuminated mirror was created to enhance your daily grooming experience. The Tribeca frame's carefully detailed design and multiple finish options will make a style statement in any bath space or makeup station.

Frameless Sizes- 24"x30"x1 5/16"\*, 24"x36"x1 5/16"\*, 36"x36"x1 5/16"

Framed Sizes- 24"x30"x1 5/8"\*, 24"x36"x1 5/8"\*, 36"x36"x1 5/8"

\*Rectangular Illuminated Mirrors Can Be Installed Either Portrait Or Landscape

Note: Product specifications and installation instruction sheets for all product models are available for download at [www.GlassCraftersMirroredCabinets.com](http://www.GlassCraftersMirroredCabinets.com).

For custom size illuminated mirror projects, please contact GlassCraters Inc. directly at [sales@glasscraftersinc.com](mailto:sales@glasscraftersinc.com) concerning delivery times and pricing.

All sales for custom size illuminated mirror projects are final.

NEW

## ULTRA THIN, ILLUMINATED WALL MIRROR COLLECTION



Tribeca Framed Illuminated Mirror  
With Satin Brass Finish



Tribeca Framed Illuminated Mirror  
With Iron-Black (Matte) Finish

### Recommended Lutron C•L Dimmer Controls (purchase separately)



Maestro Sensor & Dimmer



Maestro Dimmer



Diva Dimmer

### Frame Details

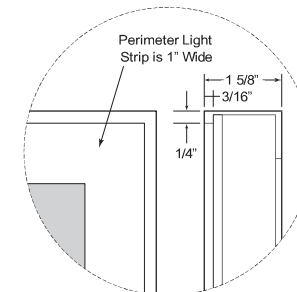

Note: Product specifications and installation instruction sheets for all product models are available for download at [www.GlassCraftersMirroredCabinets.com](http://www.GlassCraftersMirroredCabinets.com).  
For custom size illuminated mirror projects, please contact GlassCraters Inc. directly at [sales@glasscraftersinc.com](mailto:sales@glasscraftersinc.com) concerning delivery times and pricing.  
All sales for custom size illuminated mirror projects are final.

## DECORATIVE FINISHES



Plated Polished  
Chrome (PC)

[Plated - Polished / Mirror Like Finish]



Plated Polished  
Nickel (PN)



Polished Chrome  
Anodized (CHA)

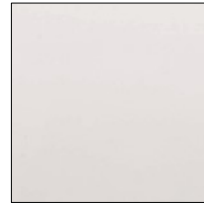

Polished Nickel  
Anodized (PNA)

[Anodized Finish]



Brushed Nickel  
Anodized (BN)

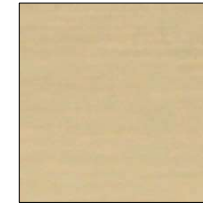

Satin Brass  
Anodized (SB)

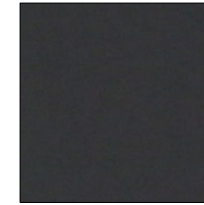

Iron-Black (IB)

[Powder Coated /  
Durable - Matte Finish]

## Frameless Illuminated Mirrors with Defogger

Overall Dimension Width x Height	Model	List Price
		Frameless Mirror
24" x 30	GCCHE-IM-2430	\$654
24" x 36	GCCHE-IM-2436	\$704
36" x 36"	GCCHE-IM-3636	\$924

## Tribeca Framed Illuminated Mirrors with Defogger

Overall Dimension Width x Height	Model	List Price						
		PC	PN	CHA	PNA	BN	SB	IB
24" x 30	GCCHE-IM-2430-TB	\$1,364	\$1,364	\$922	\$922	\$922	\$972	\$922
24" x 36	GCCHE-IM-2436-TB	\$1,601	\$1,601	\$1,141	\$1,141	\$1,141	\$1,191	\$1,141
36" x 36"	GCCHE-IM-3636-TB	\$1,807	\$1,807	\$1,263	\$1,263	\$1,263	\$1,313	\$1,263

Note: Product specifications and installation instruction sheets for all product models are available for download at [www.GlassCraftersMirroredCabinets.com](http://www.GlassCraftersMirroredCabinets.com).

For custom size illuminated mirror projects, please contact GlassCrafters Inc. directly at [sales@glasscraftersinc.com](mailto:sales@glasscraftersinc.com) concerning delivery times and pricing.

All sales for custom size illuminated mirror projects are final.

## VERTICAL LED TASK LIGHTS for recessed or surface mounted frameless mirrored cabinets



Features UL recognized components

**Vertical LED Task Lights features:**

- Linear illumination reduces shadows across face
- 2700 - 3000 Kelvin color temperature value (warm white light)
- Angled diffuser designed to project precise light towards user's face
- LED lamping is both energy efficient and longer lasting

GlassCrafters' Vertical LED Task Lights illuminate your daily grooming activities with energy efficient, optimal warm white light and integrate seamlessly into any decor. Providing a minimal, low profile design aesthetic, the 2 1/2" wide Vertical LED Task Lights are easy to install and complement GlassCrafters' 24" and 30" high, frameless flat or beveled mirrored cabinets.

**This product is discontinued. Pricing is available while inventory lasts.\***

### Vertical LED Task Lights VTL 2.5" Width x 24" and 30" Heights - for 4" or 6" deep cabinets

Overall Dimension Width x Height (per light)	Model	List Price (price per pair of lights)	
2.5" x 24"	VTL-24-001	\$325	Non-dimming
2.5" x 30"	VTL-30-001	\$350	Non-dimming

Modular lighting that attaches to side of cabinet. Add 4 3/4" to the width for all Rough Openings and Framing for cabinets with Vertical LED Task Lights. For Roughing-in Opening and Overall Dimensions, see the modified Roughing Dimensions shown in the Vertical LED Task Lights manual that are applicable to all cabinet sizes and models.

Note: Product specifications and installation instruction sheets for all product models are available for download at [www.GlassCraftersMirroredCabinets.com](http://www.GlassCraftersMirroredCabinets.com). Vertical LED Task Lights are not available in custom sizes.

**VERTICAL LED TASK LIGHTS** for recessed or surface mounted frameless mirrored cabinets

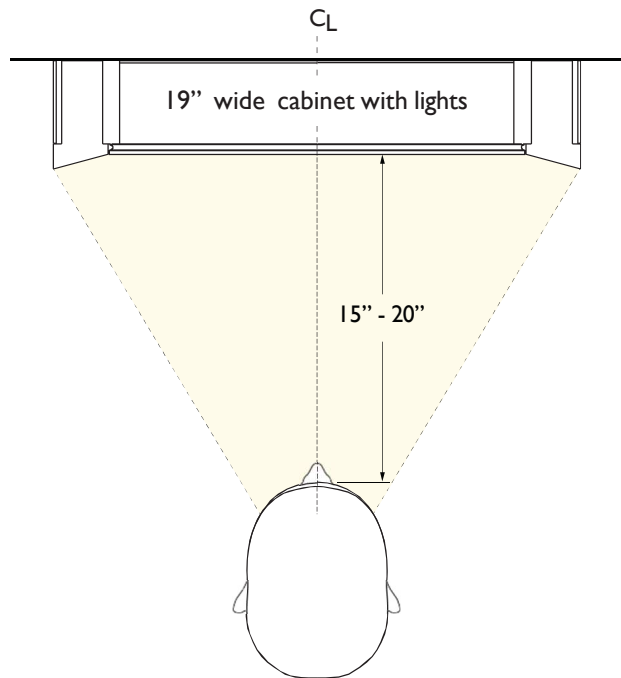

Providing ideal illumination for daily grooming activities.

1200k

4100k



GlassCrafters' lights range between 2700 - 3000 Kelvin color temperature.

Specifically designed to precisely project light at user's face, reducing shadows for makeup or shaving applications. We have found that 2700 - 3000 Kelvin color temperature (warm white light) with a color rendering index of 80-90 (for enhanced skin tones) provides the best environment for personal grooming tasks.

Note: Product specifications and installation instruction sheets for all product models are available for download at [www.GlassCraftersMirroredCabinets.com](http://www.GlassCraftersMirroredCabinets.com). Vertical LED Task Lights are not available in custom sizes.



GLASSCRAFTERS INC.

# MIRRORED CABINET ORDER FORM

Email to [sales@glasscraftersinc.com](mailto:sales@glasscraftersinc.com) or Fax to (888) 233-7362

Purchase Order

#

Date \_\_\_\_\_

Bill To: \_\_\_\_\_

Ship To: \_\_\_\_\_

Check if same as Bill To:

DEALER \_\_\_\_\_

DEALER \_\_\_\_\_

ADDRESS \_\_\_\_\_

ADDRESS \_\_\_\_\_

CITY \_\_\_\_\_ STATE \_\_\_\_\_

CITY \_\_\_\_\_ STATE \_\_\_\_\_

PHONE \_\_\_\_\_

PHONE \_\_\_\_\_

FAX \_\_\_\_\_

FAX \_\_\_\_\_

Ordered by: \_\_\_\_\_ Estimated Delivery Date: \_\_\_\_\_

EXAMPLE ORDERING NUMBER DETAILS	GC	16	30	—	4	—	SC	—	TR	—	BM	—	PC	—	EL*	—	SMK**
	Width		Height		Depth		Cabinet Finish Satin Chrome		Trinity Frame		Beveled Mirror		Polished Chrome Finish		Electric Option with Left Side Hinged Door		Side Mirror Kits

Qty	Model #	Cabinet List	Recess	Semi Recess	Surface Mount	TOTAL
_____	_____	_____	n/c	_____	_____	_____
_____	_____	_____	n/c	_____	_____	_____
_____	_____	_____	n/c	_____	_____	_____
_____	_____	_____	n/c	_____	_____	_____
_____	_____	_____	n/c	_____	_____	_____

\*Electric option is available with the following 4" & 6" deep frameless and framed Mirrored Cabinets including: GC 1630, GC 1636, GC 2030, GC 2036, GC 2430, GC 2436. For left or right sided door hinges, add "EL" or "ER" to model code. All wiring should be done by a qualified licensed electrician in a manner that conforms to the National Electric code. For information concerning wiring requirements, see installation instructions prior to purchase.

\*\*Surface Mount and Semi Recessed Cabinets require Side Mirrors



GLASSCRAFTERS INC.

# MIRRORED CABINET ORDER FORM

Email to [sales@glasscraftersinc.com](mailto:sales@glasscraftersinc.com) or Fax to (888) 233-7362

Signature Required

Date

Purchase Order

#

Date \_\_\_\_\_



GLASSCRAFTERS INC.

# WALL MIRROR ORDER FORM

Email to sales@glasscraftersinc.com or Fax to (888) 233-7362

Purchase Order

#

Date \_\_\_\_\_

Bill To: \_\_\_\_\_

Ship To: \_\_\_\_\_

Check if same as Bill To:

DEALER \_\_\_\_\_

DEALER \_\_\_\_\_

ADDRESS \_\_\_\_\_

ADDRESS \_\_\_\_\_

CITY \_\_\_\_\_ STATE \_\_\_\_\_

CITY \_\_\_\_\_ STATE \_\_\_\_\_

PHONE \_\_\_\_\_

PHONE \_\_\_\_\_

FAX \_\_\_\_\_

FAX \_\_\_\_\_

Ordered by: \_\_\_\_\_ Estimated Delivery Date: \_\_\_\_\_

EXAMPLE ORDERING NUMBER DETAILS	DF	—	BM	—	16		30	—	LE	—	PC
			Beveled Mirror		Width		Depth		Lexington		Polished Chrome Finish

Qty	Model #	Vertical Orientation	Horizontal Orientation	Wall Mirror List	TOTAL
_____	_____	_____	_____	_____	_____
_____	_____	_____	_____	_____	_____
_____	_____	_____	_____	_____	_____
_____	_____	_____	_____	_____	_____
_____	_____	_____	_____	_____	_____

Signature Required

Date