



 **BLUESTAR[®]**

2025 PRICE LIST
EFFECTIVE APRIL 1, 2025

TABLE OF CONTENTS

COOKING: FREESTANDING RANGES

5	Dual Fuel Series
12	Platinum Series – Induction
14	Platinum Series – All Gas
19	Nova (RNB) Series
33	Culinary Series – Open Burner
35	Culinary Series – Sealed Burner
39	Culinary Series - Induction
40	Freestanding Range Customization & Accessories

COOKING: RANGETOPS & COOKTOPS

42	X8™ Drop-In Cooktops
44	Platinum Series
46	Induction Cooktop
47	Nova (RNB) Series
54	Rangetop & Cooktop Customization & Accessories

DISHWASHER & DISHWASHER PANEL

56	24" Built-In Dishwasher
57	24" Dishwasher Panel

COOKING: WALL OVENS

59	Electric Wall Ovens
63	Gas Wall Ovens
66	Wall Oven Customization & Accessories

REFRIGERATION

68	PRO Built-In Refrigerators
70	Column Refrigerators
72	Column Freezers
75	Additional Trim Options: Column Refrigeration
76	Freestanding Refrigerator

VENTILATION

78	Hood Selection Guide
79	Duct Selection Guide
80	Professional Series Wall Hoods
85	Liners
88	Designer Series Wall Hoods
101	Designer Series Island Hoods
103	Abbaka Series
110	Ventilation Accessories & Wall Liners
111	Customization Summary Guide

To Place and/or Check Order Status

Phone: (800) 449 – 8691 or (610) 376 – 7479

Submit orders to: sales@bluestarcooking.com

When ordering specify LP or Natural Gas, Elevation, etc.

Inspect all deliveries immediately upon receipt and prior to signing for items in good condition. Note any damage to the box and/or items and contact BlueStar customer service by email to report damage same day. All shipments are FOB origin. Consignee is responsible for repair/replacement charges and for filing freight claims.

- BlueStar will ship dealer orders to their designated store or warehouse location
- Orders of \$20,000 or more shipped as one shipment qualify for pre-paid freight
- Freight charges for non-qualifying orders will be subject to the following cost schedule

Ranges, Cooktops, Rangetops, Wall Ovens, Indoor Charbroiler and Ventilation Hoods (Wall or Island with Blower)	\$150
--	-------

Refrigerators	\$225
---------------	-------

- Deliveries requiring Liftgate service will incur a \$50 flat fee per delivery
- Will-Call orders are subject to a \$25 Will-Call charge per order
- The freight program does not apply to small package orders/shipments that would typically be shipped via UPS or FedEx, such as color samples and backguards not shipped with a major unit.
- All freight charges for small package orders/shipments, except for warranty parts, will be invoiced to the dealer.

Get the Look: 48" Platinum Series Induction Range in Green Grey with Brushed Brass trim



FREESTANDING RANGES

Get the Look: 36" Dual Fuel Range

RANGE COMPARISON: DUAL FUEL & ALL-GAS RANGES

Dual Fuel Series



Platinum™ Series



Nova (RNB) Series



Culinary (RCS) Series Open



Culinary (RCS) Series Sealed



Feature

Feature	Dual Fuel Series	Platinum™ Series	Nova (RNB) Series	Culinary (RCS) Series Open	Culinary (RCS) Series Sealed
Available Sizes	30", 36", 48" & 60"	24", 30", 36", 48" & 60"	24", 30", 36", 48" & 60"	30" & 36"	24", 30", 36" & 48"
25,000 BTU to 500 BTU X-8™ Sealed Burners	■				
25,000 BTU Open Burners		■			
22,000 BTU Open Burners		■	■		
21,000 BTU Sealed Burners					■
18,000 BTU to 500 BTU X8™ Sealed Burners	■				
18,000 BTU Open Burner		■			
15,000 BTU Open Burner		■	■	■	
130° Simmer Open Burner		■	■	■	
Precise True Convection Electric Oven	■				
Extra-large gas convection oven with Infrared Broiler		■	■	■	■
Integrated Wok Cooking		■	■	■	
Interchangeable Griddle & Charbroiler		■			
PowR™ Oven Technology		■			
1,000+ Colors & Finishes	■	■	■	■	■
Multiple Trim Options	■	■	■	■	■
Painted Knobs	■	■	■	■	■
Swing Doors			■		
Integrated Griddle, Charbroiler or French Top	Griddle Only		■		
Backguard Options	■	■	■	■	■

60" DUAL FUEL | X-8™ BURNER RANGES

BlueStar Model Number Guide:

Base Model (BSDF6010B) 10 Burners Natural Gas Stainless Steel Finish Standard Trim	LP Models Add (L) for LP/Propane Gas	Add code below for desired color (C) 190 Standard RAL (Semi-Gloss) Colors (CF) Specialty Finish (190 Matte RAL, Precious Metals & Textures) (CC) Custom Colors	Add (PLT) for Plated Trim Includes plated bezels, door handle, handle end and logo. See available options below.
--	--	--	---

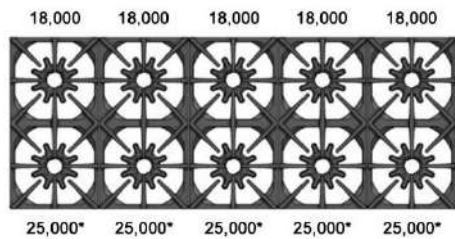

(*) 4% less output when configured for LP/Propane

FEATURES:

- Exclusive X-8™ star-shaped burner offers unmatched versatility and control on EVERY burner
- Go from extra-high sear – up to 25,000 BTUs – to an ultra-low warm of 500 BTUs on all burners
- Oversized True Convection electric oven offers even and consistent multi-rack cooking
- Fits commercial-size 18" x 26" baking sheets
- 8 cooking modes including Bake, Convection Bake, Roast, Convection Roast, Convection, Broil, Proof & Dehydrate, plus Sabbath setting and temperature probe
- Intuitive 7" touchscreen control with Quick Start™ cooking in 3 easy touches
- Environmentally friendly, gentle 90-minute express cleaning mode + Continuum Clean™ technology
- Unmatched customization – choose from 1,000+ colors and multiple trim finishes
- Handcrafted in Pennsylvania since 1880

PRODUCT SPECIFICATIONS:

- Overall Dimensions: 59 7/8" W x 26 1/2" D x 36" H
- Oven Interior: 26 1/4" W x 20" D x 16 5/8" H
- Bake Element Rating: 3500W (2500W Inner / 1000W Outer)
- Broiler Rating: 5000W (2500 Inner / 2500W Outer)
- Large Oven Convection Element Rating: 2800W

- Top Burner Rating (Front): Nat: 25,000 BTUs | LP: 24,000 BTUs
- Top Burner Rating (Rear): 18,000 BTUs
- Simmer Burner Rating: 500 BTUs

Model	Description (* Denotes item that must be specified)	UMRP	MSRP
Natural Gas Models: 60" Dual Fuel All Burner Range			
BSDF6010B	10 Burner Nat Gas Stainless Steel Standard Trim	\$ 20,495	\$ 23,570
BSDF6010BPLT	10 Burner Nat Gas Stainless Steel Plated Trim*	\$ 22,990	\$ 26,440
BSDF6010BC	10 Burner Nat Gas Std RAL Color* Standard Trim	\$ 21,990	\$ 25,290
BSDF6010BCPLT	10 Burner Nat Gas Std RAL Color* Plated Trim*	\$ 24,485	\$ 28,160
BSDF6010BCF	10 Burner Nat Gas Spec Finish* Standard Trim	\$ 23,090	\$ 26,555
BSDF6010BCFPLT	10 Burner Nat Gas Spec Finish* Plated Trim*	\$ 25,585	\$ 29,425
BSDF6010BCC	10 Burner Nat Gas Custom Color* Standard Trim	\$ 24,490	\$ 28,165
BSDF6010BCCPLT	10 Burner Nat Gas Custom Color* Plated Trim*	\$ 26,985	\$ 31,035
LP/Propane Models: 60" Dual Fuel All Burner Range			
BSDF6010BL	10 Burner LP Gas Stainless Steel Standard Trim	\$ 20,495	\$ 23,570
BSDF6010BLPLT	10 Burner LP Gas Stainless Steel Plated Trim*	\$ 22,990	\$ 26,440
BSDF6010BLC	10 Burner LP Gas Std RAL Color* Standard Trim	\$ 21,990	\$ 25,290
BSDF6010BLCPLT	10 Burner LP Gas Std RAL Color* Plated Trim*	\$ 24,485	\$ 28,160
BSDF6010BLCF	10 Burner LP Gas Spec Finish* Standard Trim	\$ 23,090	\$ 26,555
BSDF6010BLCFPLT	10 Burner LP Gas Spec Finish* Plated Trim*	\$ 25,585	\$ 29,425
BSDF6010BLCC	10 Burner LP Gas Custom Color* Standard Trim	\$ 24,490	\$ 28,165
BSDF6010BLCCPLT	10 Burner LP Gas Custom Color* Plated Trim*	\$ 26,985	\$ 31,035
BACKGUARD OPTIONS:			
All BlueStar freestanding appliances must be installed with a UL approved backguard. All units ship standard with a UL approved Island Trim unless otherwise specified.			
IT60DF	Island Trim Backguard (If purchased separately)	\$ 1,210	\$ 1,390
BG60DF	6" Backguard for 60" Dual Fuel Series	\$ 1,530	\$ 1,760
SDHS60DF	24" High Shelf for 60" Dual Fuel Series	\$ 2,900	\$ 3,335
KNOB & PAINTED BODY SIDE OPTIONS: (Total Knobs: 10)			
SIDES-C	Add Painted Sides (All colors)	\$ 765	\$ 880
KN-BLK	Standard Black Knob (Must be ordered with unit)	N/C	N/C
KN-C	Knob: Standard 190 RAL Color	\$ 115 ea	\$ 130 ea
KN-CF	Knob: Spec Finish (Matte RAL, Textured RAL or Prec Metals)	\$ 185 ea	\$ 215 ea
KN-PLT	Knob: Plated Trim (See options below)	\$ 250 ea	\$ 290 ea
PLATED TRIM OPTIONS: (Includes bezels, door handle, handle ends and logo)			
Antique Brass, Brushed Brass, Polished Brass, Brushed Copper & Pewter			
See page 40 for additional customization and accessories for Freestanding Ranges			

- Electrical Requirements: 240VAC, 60Hz, 50 AMPs, 1 PH (Unit must be on a Non-GFI, dedicated outlet)
- Operating Gas Pressure: Nat: 5" WC | LP: 10" WC
- Incoming Gas Line Size: 3/4"
- Installation Clearance (Below Counter): 0" side cabinet | 0" back wall
- Installation Clearance (Above Counter): 6" side cabinet
- Door Clearance: 20" from front of door
- Shipping Weight: 750 lbs

60" DUAL FUEL | X-8™ BURNER RANGES

BlueStar Model Number Guide:

Base Model (BSDF606G) 6 Burners & 12" Griddle Natural Gas Stainless Steel Finish Standard Trim	LP Models Add (L) for LP/Propane Gas	Add code below for desired color (C) 190 Standard RAL (Semi-Gloss) Colors (CF) Specialty Finish (190 Matte RAL, Precious Metals & Textures) (CC) Custom Colors	Add (PLT) for Plated Trim Includes plated bezels, door handle, handle end and logo. See available options below.
--	--	--	---

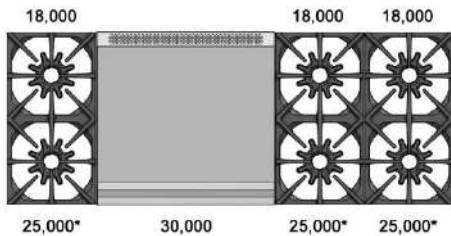

(*) 4% less output when configured for LP/Propane

FEATURES:

- Exclusive X-8™ star-shaped burner offers unmatched versatility and control on EVERY burner
- Go from extra-high sear – up to 25,000 BTUs – to an ultra-low warm of 500 BTUs on all burners
- Oversized True Convection electric oven offers even and consistent multi-rack cooking
- Fits commercial-size 18" x 26" baking sheets
- 8 cooking modes including Bake, Convection Bake, Roast, Convection Roast, Convection, Broil, Proof & Dehydrate, plus Sabbath setting and temperature probe
- Intuitive 7" touchscreen control with Quick Start™ cooking in 3 easy touches
- Environmentally friendly, gentle 90-minute express cleaning mode + Continu Clean™ technology
- Unmatched customization – choose from 1,000+ colors and multiple trim finishes
- Handcrafted in Pennsylvania since 1880

PRODUCT SPECIFICATIONS:

- Overall Dimensions: 59 7/8"W x 26 1/2"D x 36"H
- Oven Interior: 26 1/4"W x 20"D x 16 5/8"H
- Bake Element Rating: 3500W (2500W Inner / 1000W Outer)
- Broiler Rating: 5000W (2500 Inner / 2500W Outer)
- Large Oven Convection Element Rating: 2800W
- Top Burner Rating (Front): Nat: 25,000 BTUs | LP: 24,000 BTUs
- Top Burner Rating (Rear): 18,000 BTUs
- Simmer Burner Rating: 500 BTUs
- Griddle Rating: 15,000 BTUs

Model	Description (*) Denotes item that must be specified	UMRP	MSRP
Natural Gas Models: 60" Dual Fuel Range with 24" Griddle			
BSDF606G	6 Burner 24" Griddle Nat Gas Stainless Steel Standard Trim	\$ 21,495	\$ 24,720
BSDF606GPLT	6 Burner 24" Griddle Nat Gas Stainless Steel Plated Trim*	\$ 23,990	\$ 27,590
BSDF606GC	6 Burner 24" Griddle Nat Gas Std RAL Paint* Standard Trim	\$ 22,990	\$ 26,440
BSDF606GCPLT	6 Burner 24" Griddle Nat Gas Std RAL Paint* Plated Trim*	\$ 25,485	\$ 29,310
BSDF606GCF	6 Burner 24" Griddle Nat Gas Spec Finish* Standard Trim	\$ 24,090	\$ 27,705
BSDF606GCFPLT	6 Burner 24" Griddle Nat Gas Spec Finish* Plated Trim*	\$ 26,585	\$ 30,575
BSDF606GCC	6 Burner 24" Griddle Nat Gas Custom Color* Standard Trim	\$ 25,490	\$ 29,315
BSDF606GCCPLT	6 Burner 24" Griddle Nat Gas Custom Color* Plated Trim*	\$ 27,985	\$ 32,185
LP/Propane Models: 60" Dual Fuel Range with 24" Griddle			
BSDF606GL	6 Burner 24" Griddle LP Gas Stainless Steel Standard Trim	\$ 21,495	\$ 24,720
BSDF606GLPLT	6 Burner 24" Griddle LP Gas Stainless Steel Plated Trim*	\$ 23,990	\$ 27,590
BSDF606GLC	6 Burner 24" Griddle LP Gas Std RAL Paint* Standard Trim	\$ 22,990	\$ 26,440
BSDF606GLCPLT	6 Burner 24" Griddle LP Gas Std RAL Paint* Plated Trim*	\$ 25,485	\$ 29,310
BSDF606GLCF	6 Burner 24" Griddle LP Gas Spec Finish* Standard Trim	\$ 24,090	\$ 27,705
BSDF606GLCFPLT	6 Burner 24" Griddle LP Gas Spec Finish* Plated Trim*	\$ 26,585	\$ 30,575
BSDF606GLCC	6 Burner 24" Griddle LP Gas Custom Color* Standard Trim	\$ 25,490	\$ 29,315
BSDF606GLCCPLT	6 Burner 24" Griddle LP Gas Custom Color* Plated Trim*	\$ 27,985	\$ 32,185
BACKGUARD OPTIONS:			
All BlueStar freestanding appliances must be installed with a UL approved backguard. All units ship standard with a UL approved Island Trim unless otherwise specified.			
IT60DF	Island Trim Backguard (<i>If purchased separately</i>)	\$ 1,210	\$ 1,390
BG60DF	6" Backguard for 60" Dual Fuel Series	\$ 1,530	\$ 1,760
SDHS60DF	24" High Shelf for 60" Dual Fuel Series	\$ 2,900	\$ 3,335
KNOB & PAINTED BODY SIDE OPTIONS: (Total Knobs: 8)			
SIDES-C	Add Painted Sides (All colors)	\$ 765	\$ 880
KN-BLK	Standard Black Knob (<i>Must be ordered with unit</i>)	N/C	N/C
KN-C	Knob: Standard 190 RAL Color	\$ 115 ea	\$ 130 ea
KN-CF	Knob: Spec Finish (Matte RAL, Textured RAL or Prec Metals)	\$ 185 ea	\$ 215 ea
KN-PLT	Knob: Plated Trim (See options below)	\$ 250 ea	\$ 290 ea
PLATED TRIM OPTIONS: (Includes bezels, door handle, handle ends and logo)			
Antique Brass, Brushed Brass, Polished Brass, Brushed Copper & Pewter			
See page 40 for additional customization and accessories for Freestanding Ranges			

- Electrical Requirements: 240VAC, 60Hz, 50 AMPs, 1 PH (*Unit must be on a Non-GFI, dedicated outlet*)
- Operating Gas Pressure: Nat: 5" WC | LP: 10" WC
- Incoming Gas Line Size: 3/4"
- Installation Clearance (Below Counter): 0" side cabinet | 0" back wall
- Installation Clearance (Above Counter): 6" side cabinet
- Door Clearance: 20" from front of door
- Shipping Weight: 750 lbs

48" DUAL FUEL | X-8™ BURNER RANGES

BlueStar Model Number Guide:

Base Model (BSDF488B) 8 Burners Natural Gas Stainless Steel Finish Standard Trim	LP Models Add (L) for LP/Propane Gas	Add code below for desired color (C) 190 Standard RAL (Semi-Gloss) Colors (CF) Specialty Finish (190 Matte RAL, Precious Metals & Textures) (CC) Custom Colors	Add (PLT) for Plated Trim Includes plated bezels, door handle, handle end and logo. See available options below.
--	--	--	---

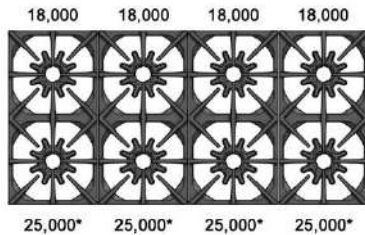

(*) 4% less output when configured for LP/Propane

FEATURES:

- Exclusive X-8™ star-shaped burner offers unmatched versatility and control on EVERY burner
- Go from extra-high sear – up to 25,000 BTUs – to an ultra-low warm of 500 BTUs on all burners
- Oversized True Convection electric oven offers even and consistent multi-rack cooking
- Fits commercial-size 18" x 26" baking sheets
- 8 cooking modes including Bake, Convection Bake, Roast, Convection Roast, Convection, Broil, Proof & Dehydrate, plus Sabbath setting and temperature probe
- Intuitive 7" touchscreen control with Quick Start™ cooking in 3 easy touches
- Environmentally friendly, gentle 90-minute express cleaning mode + Continuum Clean™ technology
- Unmatched customization – choose from 1,000+ colors and multiple trim finishes
- Handcrafted in Pennsylvania since 1880

PRODUCT SPECIFICATIONS:

- Overall Dimensions: 47 7/8"W x 26 1/2"D x 36"H
- Large Oven Interior: 26 1/4"W x 20"D x 16 5/8"H
- Bake Element Rating: 3500W (2500W Inner / 1000W Outer)
- Broiler Rating: 5000W (2500 Inner / 2500W Outer)
- Large Oven Convection Element Rating: 2800W
- Small Oven Interior: 14 1/8"W x 20"D x 16 5/8"H
- Bake Element Rating: 2100W
- Small Oven Convection Element Rating: 2800W
- Top Burner Rating (Front): Nat: 25,000 BTUs | LP: 24,000 BTUS
- Top Burner Rating (Rear): 18,000 BTUs
- Simmer Burner Rating: 500 BTUs

Model	Description (*) Denotes item that must be specified	UMRP	MSRP
Natural Gas Models: 48" Dual Fuel All Burner Range			
BSDF488B	8 Burner Nat Gas Stainless Steel Standard Trim	\$ 15,995	\$ 18,395
BSDF488BPLT	8 Burner Nat Gas Stainless Steel Plated Trim*	\$ 18,190	\$ 20,920
BSDF488BC	8 Burner Nat Gas Std RAL Color* Standard Trim	\$ 17,490	\$ 20,115
BSDF488BCPLT	8 Burner Nat Gas Std RAL Color* Plated Trim*	\$ 19,685	\$ 22,640
BSDF488BCF	8 Burner Nat Gas Spec Finish* Standard Trim	\$ 18,590	\$ 21,380
BSDF488BCFPLT	8 Burner Nat Gas Spec Finish* Plated Trim*	\$ 20,785	\$ 23,905
BSDF488BCC	8 Burner Nat Gas Custom Color* Standard Trim	\$ 19,990	\$ 22,990
BSDF488BCCPLT	8 Burner Nat Gas Custom Color* Plated Trim*	\$ 22,185	\$ 25,515
LP/Propane Models: 48" Dual Fuel All Burner Range			
BSDF488BL	8 Burner LP Gas Stainless Steel Standard Trim	\$ 15,995	\$ 18,395
BSDF488BLPLT	8 Burner LP Gas Stainless Steel Plated Trim*	\$ 18,190	\$ 20,920
BSDF488BLC	8 Burner LP Gas Std RAL Color* Standard Trim	\$ 17,490	\$ 20,115
BSDF488BLCPLT	8 Burner LP Gas Std RAL Color* Plated Trim*	\$ 19,685	\$ 22,640
BSDF488BLCF	8 Burner LP Gas Spec Finish* Standard Trim	\$ 18,590	\$ 21,380
BSDF488BLCFPLT	8 Burner LP Gas Spec Finish* Plated Trim*	\$ 20,785	\$ 23,905
BSDF488BLCC	8 Burner LP Gas Custom Color* Standard Trim	\$ 19,990	\$ 22,990
BSDF488BLCCPLT	8 Burner LP Gas Custom Color* Plated Trim*	\$ 22,185	\$ 25,515
BACKGUARD OPTIONS:			
All BlueStar freestanding appliances must be installed with a UL approved backguard. All units ship standard with a UL approved Island Trim unless otherwise specified.			
IT48DF	Island Trim Backguard (If purchased separately)	\$ 955	\$ 1,100
BG648DF	6" Backguard for 48" Dual Fuel Series	\$ 1,040	\$ 1,195
SDHS48DF	24" High Shelf for 48" Dual Fuel Series	\$ 2,340	\$ 2,690
KNOB & PAINTED BODY SIDE OPTIONS: (Total Knobs: 8)			
SIDES-C	Add Painted Sides (All colors)	\$ 765	\$ 880
KN-BLK	Standard Black Knob (Must be ordered with unit)	N/C	N/C
KN-C	Knob: Standard 190 RAL Color	\$ 115 ea	\$ 130 ea
KN-CF	Knob: Spec Finish (Matte RAL, Textured RAL or Prec Metals)	\$ 185 ea	\$ 215 ea
KN-PLT	Knob: Plated Trim (See options below)	\$ 250 ea	\$ 290 ea
PLATED TRIM OPTIONS: (Includes bezels, door handle, handle ends and logo)			
Antique Brass, Brushed Brass, Polished Brass, Brushed Copper & Pewter			
See page 40 for additional customization and accessories for Freestanding Ranges			

- Electrical Requirements: 240VAC, 60Hz, 50 AMPs, 1 PH (Unit must be on a Non-GFI, dedicated outlet)
- Operating Gas Pressure: Nat: 5" WC | LP: 10" WC
- Incoming Gas Line Size: 3/4"
- Installation Clearance (Below Counter): 0" side cabinet | 0" back wall
- Installation Clearance (Above Counter): 6" side cabinet
- Door Clearance: 20" from front of door
- Shipping Weight: 640 lbs

48" DUAL FUEL | X-8™ BURNER RANGES

BlueStar Model Number Guide:

Base Model (BSDF486G) 6 Burners 12" Griddle Natural Gas Stainless Steel Finish Standard Trim	LP Models Add (L) for LP/Propane Gas	Add code below for desired color (C) 190 Standard RAL (Semi-Gloss) Colors (CF) Specialty Finish (190 Matte RAL, Precious Metals & Textures) (CC) Custom Colors	Add (PLT) for Plated Trim Includes plated bezels, door handle, handle end and logo. See available options below.
--	--	--	---

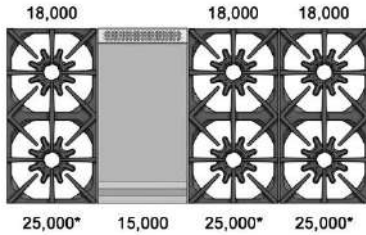

(*) 4% less output when configured for LP/Propane

FEATURES:

- Exclusive X-8™ star-shaped burner offers unmatched versatility and control on EVERY burner
- Go from extra-high sear – up to 25,000 BTUs – to an ultra-low warm of 500 BTUs on all burners
- Commercial-grade steel griddle with precise temperature control
- Oversized True Convection electric oven offers even and consistent multi-rack cooking
- Fits commercial-size 18" x 26" baking sheets
- 8 cooking modes including Bake, Convection Bake, Roast, Convection Roast, Convection, Broil, Proof & Dehydrate, plus Sabbath setting and temperature probe
- Intuitive 7" touchscreen control with Quick Start™ cooking in 3 easy touches
- Environmentally friendly, gentle 90-minute express cleaning mode + Continuum Clean™ technology
- Unmatched customization – choose from 1,000+ colors and multiple trim finishes
- Handcrafted in Pennsylvania since 1880

PRODUCT SPECIFICATIONS:

- Overall Dimensions: 47 7/8"W x 26 1/2"D x 36"H
- Large Oven Interior: 26 1/4"W x 20"D x 16 5/8"H
- Bake Element Rating: 3500W (2500W Inner/ 1000W Outer)
- Broiler Rating: 5000W (2500 Inner / 2500W Outer)
- Large Oven Convection Element Rating: 2800W

- Small Oven Interior: 14 1/8"W x 20"D x 16 5/8"H
- Bake Element Rating: 2100W
- Small Oven Convection Element Rating: 2800W

- Top Burner Rating (Front): Nat: 25,000 BTUs | LP: 24,000 BTUs
- Top Burner Rating (Rear): 18,000 BTUs
- Simmer Burner Rating: 500 BTUs
- 12" Griddle Rating: 15,000 BTUs

Model	Description (*) Denotes item that must be specified	UMRP	MSRP
Natural Gas Models: 48" Dual Fuel Range with 12" Griddle			
BSDF486G	6 Burner 12" Griddle Nat Gas Stainless Steel Standard Trim	\$ 16,995	\$ 19,545
BSDF486GPLT	6 Burner 12" Griddle Nat Gas Stainless Steel Plated Trim*	\$ 19,190	\$ 22,070
BSDF486GC	6 Burner 12" Griddle Nat Gas Std RAL Color* Standard Trim	\$ 18,490	\$ 21,265
BSDF486GCPLT	6 Burner 12" Griddle Nat Gas Std RAL Color* Plated Trim*	\$ 20,685	\$ 23,790
BSDF486GCF	6 Burner 12" Griddle Nat Gas Spec Finish* Standard Trim	\$ 19,590	\$ 22,530
BSDF486GCFPLT	6 Burner 12" Griddle Nat Gas Spec Finish* Plated Trim*	\$ 21,785	\$ 25,055
BSDF486GCC	6 Burner 12" Griddle Nat Gas Custom Color* Standard Trim	\$ 20,990	\$ 24,140
BSDF486GCCPLT	6 Burner 12" Griddle Nat Gas Custom Color* Plated Trim*	\$ 23,185	\$ 26,665
LP/Propane Models: 48" Dual Fuel Range with 12" Griddle			
BSDF486GL	6 Burner 12" Griddle LP Gas Stainless Steel Standard Trim	\$ 16,995	\$ 19,545
BSDF486GLPLT	6 Burner 12" Griddle LP Gas Stainless Steel Plated Trim*	\$ 19,190	\$ 22,070
BSDF486GLC	6 Burner 12" Griddle LP Gas Std RAL Color* Standard Trim	\$ 18,490	\$ 21,265
BSDF486GLCPLT	6 Burner 12" Griddle LP Gas Std RAL Color* Plated Trim*	\$ 20,685	\$ 23,790
BSDF486GLCF	6 Burner 12" Griddle LP Gas Spec Finish* Standard Trim	\$ 19,590	\$ 22,530
BSDF486GLCFPLT	6 Burner 12" Griddle LP Gas Spec Finish* Plated Trim*	\$ 21,785	\$ 25,055
BSDF486GLCC	6 Burner 12" Griddle LP Gas Custom Color* Standard Trim	\$ 20,990	\$ 24,140
BSDF486GLCCPLT	6 Burner 12" Griddle LP Gas Custom Color* Plated Trim*	\$ 23,185	\$ 26,665
BACKGUARD OPTIONS:			
All BlueStar freestanding appliances must be installed with a UL approved backguard. All units ship standard with a UL approved Island Trim unless otherwise specified.			
IT48DF	Island Trim Backguard (If purchased separately)	\$ 955	\$ 1,100
BG648DF	6" Backguard for 48" Dual Fuel Series	\$ 1,040	\$ 1,195
SDHS48DF	24" High Shelf for 48" Dual Fuel Series	\$ 2,340	\$ 2,690
KNOB & PAINTED BODY SIDE OPTIONS: (Total Knobs: 7)			
SIDES-C	Add Painted Sides (All colors)	\$ 765	\$ 880
KN-BLK	Standard Black Knob (Must be ordered with unit)	N/C	N/C
KN-C	Knob: Standard 190 RAL Color	\$ 115 ea	\$ 130 ea
KN-CF	Knob: Spec Finish (Matte RAL, Textured RAL or Prec Metals)	\$ 185 ea	\$ 215 ea
KN-PLT	Knob: Plated Trim (See options below)	\$ 250 ea	\$ 290 ea
PLATED TRIM OPTIONS: (Includes bezels, door handle, handle ends and logo)			
Antique Brass, Brushed Brass, Polished Brass, Brushed Copper & Pewter			
See page 40 for additional customization and accessories for Freestanding Ranges			

- Electrical Requirements: 240VAC, 60Hz, 50 AMPs, 1 PH (Unit must be on a Non-GFI, dedicated outlet)
- Operating Gas Pressure: Nat: 5" WC | LP: 10" WC
- Incoming Gas Line Size: 3/4"
- Installation Clearance (Below Counter): 0" side cabinet | 0" back wall
- Installation Clearance (Above Counter): 6" side cabinet
- Door Clearance: 20" from front of door
- Shipping Weight: 665 lbs

36" DUAL FUEL | X-8™ BURNER RANGES

BlueStar Model Number Guide:

Base Model (BSDF366B) 6 Burners Natural Gas Stainless Steel Finish Standard Trim	LP Models Add (L) for LP/Propane Gas	Add code below for desired color (C) 190 Standard RAL (Semi-Gloss) Colors (CF) Specialty Finish (190 Matte RAL, Precious Metals & Textures) (CC) Custom Colors	Add (PLT) for Plated Trim Includes plated bezels, door handle, handle end and logo. See available options below.
--	--	--	---

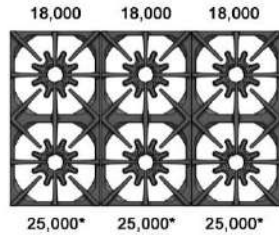

(*) 4% less output when configured for LP/Propane

FEATURES:

- Exclusive X-8™ star-shaped burner offers unmatched versatility and control on EVERY burner
- Go from extra-high sear – up to 25,000 BTUs – to an ultra-low warm of 500 BTUs on all burners
- Oversized True Convection electric oven offers even and consistent multi-rack cooking
- Fits commercial-size 18" x 26" baking sheets
- 8 cooking modes including Bake, Convection Bake, Roast, Convection Roast, Convection, Broil, Proof & Dehydrate, plus Sabbath setting and temperature probe
- Intuitive 7" touchscreen control with Quick Start™ cooking in 3 easy touches
- Environmentally friendly, gentle 90-minute express cleaning mode + Continuum Clean™ technology
- Unmatched customization – choose from 1,000+ colors and multiple trim finishes
- Handcrafted in Pennsylvania since 1880

PRODUCT SPECIFICATIONS:

- Overall Dimensions: 35 7/8"W x 26 1/2"D x 36"H
- Large Oven Interior: 29"W x 20"D x 16 5/8"H
- Bake Element Rating: 3500W (2500W Inner/ 1000W Outer)
- Broiler Rating: 5000W (2500 Inner / 2500W Outer)
- Large Oven Convection Element Rating: 2800W
- Top Burner Rating (Front): Nat: 25,000 BTUs | LP: 24,000 BTUS
- Top Burner Rating (Rear): 18,000 BTUs
- Simmer Burner Rating: 500 BTUs

Model	Description (* Denotes item that must be specified)	UMRP	MSRP
Natural Gas Models: 36" Dual Fuel All Burner Range			
BSDF366B	6 Burner Nat Gas Stainless Steel Standard Trim	\$ 11,995	\$ 13,795
BSDF366BPLT	6 Burner Nat Gas Stainless Steel Plated Trim*	\$ 13,890	\$ 15,975
BSDF366BC	6 Burner Nat Gas Std RAL Color* Standard Trim	\$ 13,190	\$ 15,170
BSDF366BCPLT	6 Burner Nat Gas Std RAL Color* Plated Trim*	\$ 15,085	\$ 17,350
BSDF366BCF	6 Burner Nat Gas Spec Finish* Standard Trim	\$ 14,190	\$ 16,320
BSDF366BCFPLT	6 Burner Nat Gas Spec Finish* Plated Trim*	\$ 16,085	\$ 18,500
BSDF366BCC	6 Burner Nat Gas Custom Color* Standard Trim	\$ 15,690	\$ 18,045
BSDF366BCCPLT	6 Burner Nat Gas Custom Color* Plated Trim*	\$ 17,585	\$ 20,225
LP/Propane Models: 36" Dual Fuel All Burner Range			
BSDF366BL	6 Burner LP Gas Stainless Steel Standard Trim	\$ 11,995	\$ 13,795
BSDF366BLPLT	6 Burner LP Gas Stainless Steel Plated Trim*	\$ 13,890	\$ 15,975
BSDF366BLC	6 Burner LP Gas Std RAL Color* Standard Trim	\$ 13,190	\$ 15,170
BSDF366BLCPLT	6 Burner LP Gas Std RAL Color* Plated Trim*	\$ 15,085	\$ 17,350
BSDF366BLCF	6 Burner LP Gas Spec Finish* Standard Trim	\$ 14,190	\$ 16,320
BSDF366BLCFPLT	6 Burner LP Gas Spec Finish* Plated Trim*	\$ 16,085	\$ 18,500
BSDF366BLCC	6 Burner LP Gas Custom Color* Standard Trim	\$ 15,690	\$ 18,045
BSDF366BLCCPLT	6 Burner LP Gas Custom Color* Plated Trim*	\$ 17,585	\$ 20,225
BACKGUARD OPTIONS:			
All BlueStar freestanding appliances must be installed with a UL approved backguard. All units ship standard with a UL approved Island Trim unless otherwise specified.			
IT36DF	Island Trim Backguard (If purchased separately)	\$ 665	\$ 765
BG636DF	6" Backguard for 36" Dual Fuel Series	\$ 720	\$ 830
SDHS36DF	24" High Shelf for 36" Dual Fuel Series	\$ 1,690	\$ 1,945
KNOB & PAINTED BODY SIDE OPTIONS: (Total Knobs 6)			
SIDES-C	Add Painted Sides (All colors)	\$ 765	\$ 880
KN-BLK	Standard Black Knob (Must be ordered with unit)	N/C	N/C
KN-C	Knob: Standard 190 RAL Color	\$ 115 ea	\$ 130 ea
KN-CF	Knob: Spec Finish (Matte RAL, Textured RAL or Prec Metals)	\$ 185 ea	\$ 215 ea
KN-PLT	Knob: Plated Trim (See options below)	\$ 250 ea	\$ 290 ea
PLATED TRIM OPTIONS: (Includes bezels, door handle, handle ends and logo)			
Antique Brass, Brushed Brass, Polished Brass, Brushed Copper & Pewter			
See page 40 for additional customization and accessories for Freestanding Ranges			

- Electrical Requirements: 240VAC, 60Hz, 40 AMPs, 1 PH (Unit must be on a Non-GFI, dedicated outlet)
- Operating Gas Pressure: Nat: 5" WC | LP: 10" WC
- Incoming Gas Line Size: 3/4"
- Installation Clearance (Below Counter): 0" side cabinet | 0" back wall
- Installation Clearance (Above Counter): 6" side cabinet
- Door Clearance: 20" from front of door
- Shipping Weight: 425 lbs

36" DUAL FUEL | X-8™ BURNER RANGES

BlueStar Model Number Guide:

Base Model (BSDF364G) 4 Burners 12" Griddle Natural Gas Stainless Steel Finish Standard Trim	LP Models Add (L) for LP/Propane Gas	Add code below for desired color (C) 190 Standard RAL (Semi-Gloss) Colors (CF) Specialty Finish (190 Matte RAL, Precious Metals & Textures) (CC) Custom Colors	Add (PLT) for Plated Trim Includes plated bezels, door handle, handle end and logo. See available options below.
--	--	--	---

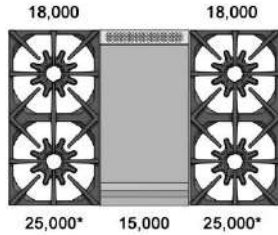

(*) 4% less output when configured for LP/Propane

Model	Description (* Denotes item that must be specified)	UMRP	MSRP
Natural Gas Models: 36" Dual Fuel Range with 12" Griddle			
BSDF364G	4 Burner 12" Griddle Nat Gas Stainless Steel Standard Trim	\$ 12,995	\$ 14,945
BSDF364GPLT	4 Burner 12" Griddle Nat Gas Stainless Steel Plated Trim*	\$ 14,890	\$ 17,125
BSDF364GC	4 Burner 12" Griddle Nat Gas Std RAL Color* Standard Trim	\$ 14,190	\$ 16,320
BSDF364GCPLT	4 Burner 12" Griddle Nat Gas Std RAL Color* Plated Trim*	\$ 16,085	\$ 18,500
BSDF364GCF	4 Burner 12" Griddle Nat Gas Spec Finish* Standard Trim	\$ 15,190	\$ 17,470
BSDF364GCFPLT	4 Burner 12" Griddle Nat Gas Spec Finish* Plated Trim*	\$ 17,085	\$ 19,650
BSDF364GCC	4 Burner 12" Griddle Nat Gas Custom Color* Standard Trim	\$ 16,690	\$ 19,195
BSDF364GCCPLT	4 Burner 12" Griddle Nat Gas Custom Color* Plated Trim*	\$ 18,585	\$ 21,375
LP/Propane Models: 36" Dual Fuel Range with 12" Griddle			
BSDF364GL	4 Burner 12" Griddle LP Gas Stainless Steel Standard Trim	\$ 12,995	\$ 14,945
BSDF364GLPLT	4 Burner 12" Griddle LP Gas Stainless Steel Plated Trim*	\$ 14,890	\$ 17,125
BSDF364GLC	4 Burner 12" Griddle LP Gas Std RAL Color* Standard Trim	\$ 14,190	\$ 16,320
BSDF364GLCPLT	4 Burner 12" Griddle LP Gas Std RAL Color* Plated Trim*	\$ 16,085	\$ 18,500
BSDF364GLCF	4 Burner 12" Griddle LP Gas Spec Finish* Standard Trim	\$ 15,190	\$ 17,470
BSDF364GLCFPLT	4 Burner 12" Griddle LP Gas Spec Finish* Plated Trim*	\$ 17,085	\$ 19,650
BSDF364GLCC	4 Burner 12" Griddle LP Gas Custom Color* Standard Trim	\$ 16,690	\$ 19,195
BSDF364GLCCPLT	4 Burner 12" Griddle LP Gas Custom Color* Plated Trim*	\$ 18,585	\$ 21,375
BACKGUARD OPTIONS:			
All BlueStar freestanding appliances must be installed with a UL approved backguard. All units ship standard with a UL approved Island Trim unless otherwise specified.			
IT36DF	Island Trim Backguard (If purchased separately)	\$ 665	\$ 765
BG636DF	6" Backguard for 36" Dual Fuel Series	\$ 720	\$ 830
SDHS36DF	24" High Shelf for 36" Dual Fuel Series	\$ 1,690	\$ 1,945
KNOB & PAINTED BODY SIDE OPTIONS: (Total Knobs 6)			
SIDES-C	Add Painted Sides (All colors)	\$ 765	\$ 880
KN-BLK	Standard Black Knob (Must be ordered with unit)	N/C	N/C
KN-C	Knob: Standard 190 RAL Color	\$ 115 ea	\$ 130 ea
KN-CF	Knob: Spec Finish (Matte RAL, Textured RAL or Prec Metals)	\$ 185 ea	\$ 215 ea
KN-PLT	Knob: Plated Trim (See options below)	\$ 250 ea	\$ 290 ea
PLATED TRIM OPTIONS: (Includes bezels, door handle, handle ends and logo)			
Antique Brass, Brushed Brass, Polished Brass, Brushed Copper & Pewter			
See page 40 for additional customization and accessories for Freestanding Ranges			

FEATURES:

- Exclusive X-8™ star-shaped burner offers unmatched versatility and control on EVERY burner
- Go from extra-high sear – up to 25,000 BTUs – to an ultra-low warm of 500 BTUs on all burners
- Commercial-grade steel griddle with precise temperature control
- Oversized True Convection electric oven offers even and consistent multi-rack cooking
- Fits commercial-size 18" x 26" baking sheets
- 8 cooking modes including Bake, Convection Bake, Roast, Convection Roast, Convection, Broil, Proof & Dehydrate, plus Sabbath setting and temperature probe
- Intuitive 7" touchscreen control with Quick Start™ cooking in 3 easy touches
- Environmentally friendly, gentle 90-minute express cleaning mode + Continuum Clean™ technology
- Unmatched customization – choose from 1,000+ colors and multiple trim finishes
- Handcrafted in Pennsylvania since 1880

PRODUCT SPECIFICATIONS:

- Overall Dimensions: 35 7/8"W x 26 1/2"D x 36"H
- Large Oven Interior: 29"W x 20"D x 16 5/8"H
- Bake Element Rating: 3500W (2500W Inner / 1000W Outer)
- Broiler Rating: 5000W (2500W Inner / 2500W Outer)
- Large Oven Convection Element Rating: 2800W

- Top Burner Rating (Front): Nat: 25,000 BTUs | LP: 24,000 BTUs
- Top Burner Rating (Rear): 18,000 BTUs
- Simmer Burner Rating: 500 BTUs
- 12" Griddle Rating: 15,000 BTUs

- Electrical Requirements: 240VAC, 60Hz, 40 AMPs, 1 PH (Unit must be on a Non-GFI, dedicated outlet)
- Operating Gas Pressure: Nat: 5" WC | LP: 10" WC
- Incoming Gas Line Size: 3/4"
- Installation Clearance (Below Counter): 0" side cabinet | 0" back wall
- Installation Clearance (Above Counter): 6" side cabinet
- Door Clearance: 20" from front of door
- Shipping Weight: 450 lbs

30" DUAL FUEL | X-8™ BURNER RANGES

BlueStar Model Number Guide:

Base Model (BSDF304B) 4 Burners Natural Gas Stainless Steel Finish Standard Trim	LP Models Add (L) for LP/Propane Gas	Add code below for desired color (C) 190 Standard RAL (Semi-Gloss) Colors (CF) Specialty Finish (190 Matte RAL, Precious Metals & Textures) (CC) Custom Colors	Add (PLT) for Plated Trim Includes plated bezels, door handle, handle end and logo. See available options below.
--	--	--	---

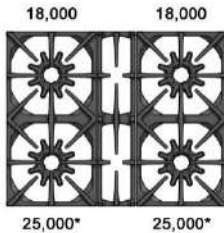

(*) 4% less output when configured for LP/Propane

FEATURES:

- Exclusive X-8™ star-shaped burner offers unmatched versatility and control on EVERY burner
- Go from extra-high sear – up to 25,000 BTUs – to an ultra-low warm of 500 BTUs on all burners
- Commercial-grade steel griddle with precise temperature control
- Oversized True Convection electric oven offers even and consistent multi-rack cooking
- Fits commercial-size 18" x 26" baking sheets
- 8 cooking modes including Bake, Convection Bake, Roast, Convection Roast, Convection, Broil, Proof & Dehydrate, plus Sabbath setting and temperature probe
- Intuitive 7" touchscreen control with Quick Start™ cooking in 3 easy touches
- Environmentally friendly, gentle 90-minute express cleaning mode + Continuum Clean™ technology
- Unmatched customization – choose from 1,000+ colors and multiple trim finishes
- Handcrafted in Pennsylvania since 1880

PRODUCT SPECIFICATIONS:

- Overall Dimensions: 29 7/8"W x 26 1/2"D x 36"H
- Large Oven Interior: 26 3/4"W x 20"D x 16 5/8"H
- Bake Element Rating: 3500W (2500W Inner/ 1000W Outer)
- Broiler Rating: 5000W (2500 Inner / 2500W Outer)
- Large Oven Convection Element Rating: 2800W

- Top Burner Rating (Front): Nat: 25,000 BTUs | LP: 24,000 BTUs
- Top Burner Rating (Rear): 18,000 BTUs
- Simmer Burner Rating: 500 BTUs

Model	Description (*) Denotes item that must be specified	UMRP	MSRP
Natural Gas Models: 30" Dual Fuel All Burner Range			
BSDF304B	4 Burner Nat Gas Stainless Steel Standard Trim	\$ 8,295	\$ 9,540
BSDF304BPLT	4 Burner Nat Gas Stainless Steel Plated Trim*	\$ 9,890	\$ 11,375
BSDF304BC	4 Burner Nat Gas Std RAL Color* Standard Trim	\$ 9,490	\$ 10,915
BSDF304BCPLT	4 Burner Nat Gas Std RAL Color* Plated Trim*	\$ 11,085	\$ 12,750
BSDF304BCF	4 Burner Nat Gas Spec Finish* Standard Trim	\$ 10,490	\$ 12,065
BSDF304BCFPLT	4 Burner Nat Gas Spec Finish* Plated Trim*	\$ 12,085	\$ 13,900
BSDF304BCC	4 Burner Nat Gas Custom Color* Standard Trim	\$ 11,990	\$ 13,790
BSDF304BCCPLT	4 Burner Nat Gas Custom Color* Plated Trim*	\$ 13,585	\$ 15,625
LP/Propane Models: 30" Dual Fuel All Burner Range			
BSDF304BL	4 Burner LP Gas Stainless Steel Standard Trim	\$ 8,295	\$ 9,540
BSDF304BLPLT	4 Burner LP Gas Stainless Steel Plated Trim*	\$ 9,890	\$ 11,375
BSDF304BLC	4 Burner LP Gas Std RAL Color* Standard Trim	\$ 9,490	\$ 10,915
BSDF304BLCPLT	4 Burner LP Gas Std RAL Color* Plated Trim*	\$ 11,085	\$ 12,750
BSDF304BLCF	4 Burner LP Gas Spec Finish* Standard Trim	\$ 10,490	\$ 12,065
BSDF304BLCFPLT	4 Burner LP Gas Spec Finish* Plated Trim*	\$ 12,085	\$ 13,900
BSDF304BLCC	4 Burner LP Gas Custom Color* Standard Trim	\$ 11,990	\$ 13,790
BSDF304BLCCPLT	4 Burner LP Gas Custom Color* Plated Trim*	\$ 13,585	\$ 15,625
BACKGUARD OPTIONS:			
All BlueStar freestanding appliances must be installed with a UL approved backguard. All units ship standard with a UL approved Island Trim unless otherwise specified.			
IT30DF	Island Trim Backguard (If purchased separately)	\$ 565	\$ 650
BG630DF	6" Backguard for 30" Dual Fuel Series	\$ 605	\$ 695
SDHS30DF	24" High Shelf for 30" Dual Fuel Series	\$ 1,460	\$ 1,680
KNOB & PAINTED BODY SIDE OPTIONS: (Total Knobs: 5)			
SIDES-C	Add Painted Sides (All colors)	\$ 765	\$ 880
KN-BLK	Standard Black Knob (Must be ordered with unit)	N/C	N/C
KN-C	Knob: Standard 190 RAL Color	\$ 115 ea	\$ 130 ea
KN-CF	Knob: Spec Finish (Matte RAL, Textured RAL or Prec Metals)	\$ 185 ea	\$ 215 ea
KN-PLT	Knob: Plated Trim (See options below)	\$ 250 ea	\$ 290 ea
PLATED TRIM OPTIONS: (Includes bezels, door handle, handle ends and logo)			
Antique Brass, Brushed Brass, Polished Brass, Brushed Copper & Pewter			
See page 40 for additional customization and accessories for Freestanding Ranges			

- Electrical Requirements: 240VAC, 60Hz, 40 AMPs, 1 PH (Unit must be on a Non-GFI, dedicated outlet)
- Operating Gas Pressure: Nat: 5" WC | LP: 10" WC
- Incoming Gas Line Size: 3/4"
- Installation Clearance (Below Counter): 0" side cabinet | 0" back wall
- Installation Clearance (Above Counter): 6" side cabinet
- Door Clearance: 20" from front of door
- Shipping Weight: 375 lbs

48" PLATINUM SERIES INDUCTION | INDUCTION RANGES

BlueStar Model Number Guide:

Base Model (BSPIR486Z) 6 Zone Induction Stainless Steel Finish Standard Trim	Add code below for desired color (C) 190 Standard RAL (Semi-Gloss) Colors (CF) Specialty Finish (190 Matte RAL, Precious Metals & Textures) (CC) Custom Colors	Add (PLT) for Plated Trim Includes plated bezels, door handle, handle end and logo. See available options below.
--	--	---



Model	Description (* Denotes item that must be specified)	UMRP	MSRP
INDUCTION: 48" PLATINUM SERIES			
BSPIR486Z	6 Zone Induction Stainless Steel Standard Trim	\$ 15,995	\$ 18,825
BSPIR486ZPLT	6 Zone Induction Stainless Steel Plated Trim*	\$ 18,190	\$ 21,020
BSPIR486ZC	6 Zone Induction Std RAL Color* Standard Trim	\$ 17,490	\$ 20,320
BSPIR486ZCPLT	6 Zone Induction Std RAL Color* Plated Trim*	\$ 19,685	\$ 22,515
BSPIR486ZCF	6 Zone Induction Spec Finish* Standard Trim	\$ 18,590	\$ 21,420
BSPIR486ZCFPLT	6 Zone Induction Spec Finish* Plated Trim*	\$ 20,785	\$ 23,615
BSPIR486ZCC	6 Zone Induction Custom Color* Standard Trim	\$ 19,990	\$ 22,820
BSPIR486ZCCPLT	6 Zone Induction Custom Color* Plated Trim*	\$ 22,185	\$ 25,015
BACKGUARD OPTIONS:			
All BlueStar freestanding appliances must be installed with a UL approved backguard. All units ship standard with a UL approved Island Trim. No other backguard options available for this model.			
KNOB & PAINTED BODY SIDE OPTIONS: (Total Knobs: 6)			
SIDES-C	Add Painted Sides (All colors)	\$ 765	\$ 880
KN-BLK	Standard Black Knob (<i>Must be ordered with unit</i>)	N/C	N/C
KN-C	Knob: Standard 190 RAL Color	\$ 115 ea	\$ 130 ea
KN-CF	Knob: Spec Finish (Matte RAL, Textured RAL or Prec Metals)	\$ 185 ea	\$ 215 ea
KN-PLT	Knob: Plated Trim (See options below)	\$ 250 ea	\$ 290 ea
PLATED TRIM OPTIONS: (Includes bezels, door handle, handle ends and logo)			
Antique Brass, Brushed Brass, Polished Brass, Brushed Copper & Pewter			
See page 40 for additional customization and accessories for Freestanding Ranges			

FEATURES:

- Largest surface cooking capacity, including two 11" zones
- Industry first – matte finish durable scratch and stain resistant cooking surface
- Most powerful cooking zone available at 7,400-Watts
- Versatile and efficient cooking surface with six individual, oversized cooking zones
- Two bridge functions creating dual power zones for oversized cookware like roasting pans and griddles
- Patent-pending, power-level indicator light for each zone
- Instant response and precise control on each cooking zone with nine levels of heat, plus simmer & keep warm options
- Power Optimization System for uninterrupted cooking
- Extra-Large True Convection oven offers even and consistent multi-rack cooking
- Fits commercial-size 18" x 26" baking sheets
- 8 cooking modes including Bake, Convection Bake, Roast, Convection Roast, Convection, Broil, Proof & Dehydrate, plus Sabbath setting and temperature probe
- Intuitive 7" touchscreen control with Quick Start™ cooking in 3 easy touches
- Environmentally friendly, gentle 90-minute express cleaning mode + Continuum Clean™ technology
- Unmatched customization – choose from 1,000+ colors and multiple trim finishes
- Handcrafted in Pennsylvania since 1880

PRODUCT SPECIFICATIONS:

- Unit Dimensions: 47 7/8"W x 26 1/2"D x 35 3/4" – 36 1/2"H
- Top Burner Boost Rating: 3,700 W
- Top Burner Rating: 2,100 W
- Left Bridge: 7,400 W
- Right Bridge: 3,700 W
- Large Oven Interior: 26 1/4"W x 20"D x 16 5/8"H
- Bake Element Rating: 3,500 W (2,500 W Inner / 1,000 W Outer)
- Broiler Element Rating: 5,000 W (2,500 W Inner / 2,500 W Outer)
- Convection Element Rating: 2,800 W
- Small Oven Interior: 14 1/8"W x 20"D x 16 5/8"H
- Small Oven Bake Element Rating: 2,100 W
- Small Oven Convection Element Rating: 2,800 W
- Electrical Requirements: 240/208 VAC, 60Hz, 50 AMPS
- Unit must be on a Non-GFI dedicated outlet
- Unit Weight: 750 lbs.

36" PLATINUM SERIES INDUCTION | INDUCTION RANGES

BlueStar Model Number Guide:		
Base Model (BSPIR365Z) 5 Zone Induction Stainless Steel Finish Standard Trim	Add code below for desired color (C) 190 Standard RAL (Semi-Gloss) Colors (CF) Specialty Finish (190 Matte RAL, Precious Metals & Textures) (CC) Custom Colors	Add (PLT) for Plated Trim Includes plated bezels, door handle, handle end and logo. See available options below.



FEATURES:

- Largest surface cooking capacity, including one 11" zones
- Industry first – matte finish durable scratch and stain resistant cooking surface
- Most powerful cooking zone available at 7,400-Watts
- Versatile and efficient cooking surface with five individual, oversized cooking zones
- Two bridge functions creating dual power zones for oversized cookware like roasting pans and griddles
- Patent-pending, power-level indicator light for each zone
- Instant response and precise control on each cooking zone with nine levels of heat, plus simmer & keep warm options
- Power Optimization System for uninterrupted cooking
- Extra-Large True Convection oven offers even and consistent multi-rack cooking
- Fits commercial-size 18" x 26" baking sheets
- 8 cooking modes including Bake, Convection Bake, Roast, Convection Roast, Convection Broil, Proof & Dehydrate, plus Sabbath setting and temperature probe
- Intuitive 7" touchscreen control with Quick Start™ cooking in 3 easy touches
- Environmentally friendly, gentle 90-minute express cleaning mode + Continu Clean™ technology
- Unmatched customization – choose from 1,000+ colors and multiple trim finishes
- Handcrafted in Pennsylvania since 1880

Model	Description (* Denotes item that must be specified)	UMRP	MSRP
INDUCTION: 36" PLATINUM SERIES			
BSPIR365Z	5 Zone Induction Stainless Steel Standard Trim	\$ 11,995	\$ 13,795
BSPIR365ZPLT	5 Zone Induction Stainless Steel Plated Trim*	\$ 13,890	\$ 15,975
BSPIR365ZC	5 Zone Induction Std RAL Color* Standard Trim	\$ 13,190	\$ 15,170
BSPIR365ZCPLT	5 Zone Induction Std RAL Color* Plated Trim*	\$ 15,085	\$ 17,350
BSPIR365ZCF	5 Zone Induction Spec Finish* Standard Trim	\$ 14,190	\$ 16,320
BSPIR365ZCFPLT	5 Zone Induction Spec Finish* Plated Trim*	\$ 16,085	\$ 18,500
BSPIR365ZCC	5 Zone Induction Custom Color* Standard Trim	\$ 15,690	\$ 18,045
BSPIR365ZCCPLT	5 Zone Induction Custom Color* Plated Trim*	\$ 17,585	\$ 20,225
BACKGUARD OPTIONS:			
All BlueStar freestanding appliances must be installed with a UL approved backguard. All units ship standard with a UL approved Island Trim. No other backguard options available for this model.			
KNOB & PAINTED BODY SIDE OPTIONS: (Total Knobs: 5)			
SIDES-C	Add Painted Sides (All colors)	\$ 765	\$ 880
KN-BLK	Standard Black Knob (<i>Must be ordered with unit</i>)	N/C	N/C
KN-C	Knob: Standard 190 RAL Color	\$ 115 ea	\$ 130 ea
KN-CF	Knob: Spec Finish (Matte RAL, Textured RAL or Prec Metals)	\$ 185 ea	\$ 215 ea
KN-PLT	Knob: Plated Trim (See options below)	\$ 250 ea	\$ 290 ea
PLATED TRIM OPTIONS: (Includes bezels, door handle, handle ends and logo)			
Antique Brass, Brushed Brass, Polished Brass, Brushed Copper & Pewter			
See page 40 for additional customization and accessories for Freestanding Ranges			

PRODUCT SPECIFICATIONS:

- Unit Dimensions: 35 7/8"W x 26 1/2"D x 35 3/4" – 36 1/2"H
- Top Burner Boost Rating: 3,700 W
- Top Burner Rating: 2,300 W
- Left Bridge: 7,400 W
- Right Bridge: 3,700 W
- Large Oven Interior: 29"W x 20"D x 16 5/8"H
- Bake Element Rating: 3,500 W (2,500 W Inner / 1,000 W Outer)
- Broiler Element Rating: 5,000 W (2,500 W Inner / 2,500 W Outer)
- Convection Element Rating: 2,800 W
- Electrical Requirements: 240/208 VAC, 60Hz, 50 AMPS
- Unit must be on a Non-GFI dedicated outlet
- Unit Weight: 450 lbs.

60" PLATINUM SERIES | OPEN BURNER RANGES

BlueStar Model Number Guide:

Base Model (BSP6010B) 10 Burners Natural Gas Stainless Steel Finish Standard Trim	LP Models Add (L) for LP/Propane Gas	Add code below for desired color (C) 190 Standard RAL (Semi-Gloss) Colors (CF) Specialty Finish (190 Matte RAL, Precious Metals & Textures) (CC) Custom Colors	Add (PLT) for Plated Trim Includes plated bezels, door handle, handle end and logo. See available options below.
---	--	--	---

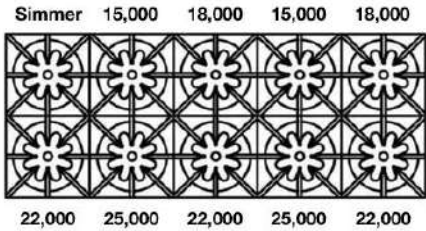

FEATURES:

- 25,000 BTU PrimaNova™ burners
- All burners, plus Interchangeable Griddle and Charbroiler accessory
- The PowR Oven™ provides 40% faster preheating and 30% increase in oven efficiency
- Precise 130° simmer burner
- Integrated wok cooking
- Extra-large oven with True European Convection and 1850° infrared broiler
- Accommodates a full-size commercial 18" x 26" baking sheet
- Includes full extension rack
- Unmatched customization – choose from 1,000+ colors and multiple trim finishes
- Handcrafted in Pennsylvania since 1880

PRODUCT SPECIFICATIONS:

- Unit Dimensions: 59.875"W x 24"D x 36.75"H
- Oven Interior: 26.438"W x 20"D x 15"H
- Top Burner Power: 25,000 BTUs
- Simmer Burner: 9,000 BTUs
- Electrical Reqs: 120V, 60Hz, 15 AMPS, 1PH
- Gas Pressure: NAT: 5.0" WC, LP 10.0" WC
- Incoming Gas Line Size: 3/4"
- Unit Weight: 930 lbs.

Model	Description (* Denotes item that must be specified)	UMRP	MSRP
Natural Gas Models: 60" Platinum Series			
BSP6010B	10 Burner Nat Gas Stainless Steel Standard Trim	\$ 18,995	\$ 21,845
BSP6010BPLT	10 Burner Nat Gas Stainless Steel Plated Trim*	\$ 21,490	\$ 24,715
BSP6010BC	10 Burner Nat Gas Std RAL Color* Standard Trim	\$ 20,490	\$ 23,565
BSP6010BCPLT	10 Burner Nat Gas Std RAL Color* Plated Trim*	\$ 22,985	\$ 26,435
BSP6010BCF	10 Burner Nat Gas Specialty Finish* Standard Trim	\$ 21,590	\$ 24,830
BSP6010BCFPLT	10 Burner Nat Gas Specialty Finish* Plated Trim*	\$ 24,085	\$ 27,700
BSP6010BCC	10 Burner Nat Gas Custom Color* Standard Trim	\$ 22,990	\$ 26,440
BSP6010BCCPLT	10 Burner Nat Gas Custom Color* Plated Trim*	\$ 25,485	\$ 29,310
LP/Propane Models: 60" Platinum Series			
BSP6010BL	10 Burner LP Gas Stainless Steel Standard Trim	\$ 18,995	\$ 21,845
BSP6010BLPLT	10 Burner LP Gas Stainless Steel Plated Trim*	\$ 21,490	\$ 24,715
BSP6010BLC	10 Burner LP Gas Std RAL Color* Standard Trim	\$ 20,490	\$ 23,565
BSP6010BLCPLT	10 Burner LP Gas Std RAL Color* Plated Trim*	\$ 22,985	\$ 26,435
BSP6010BLCF	10 Burner LP Gas Specialty Finish* Standard Trim	\$ 21,590	\$ 24,830
BSP6010BLCFPLT	10 Burner LP Gas Specialty Finish* Plated Trim*	\$ 24,085	\$ 27,700
BSP6010BLCC	10 Burner LP Gas Custom Color* Standard Trim	\$ 22,990	\$ 26,440
BSP6010BLCCPLT	10 Burner LP Gas Custom Color* Plated Trim*	\$ 25,485	\$ 29,310
BACKGUARD OPTIONS:			
All BlueStar freestanding appliances must be installed with a UL approved backguard. All units ship standard with a UL approved Island Trim unless otherwise specified.			
BG660BSP	6" Backguard	\$ 1,530	\$ 1,760
BG6017BSP	17" Backguard	\$ 2,480	\$ 2,850
SDHS60BSP	24" High Shelf	\$ 2,900	\$ 3,335
KNOB & PAINTED BODY SIDE OPTIONS: (Total Knobs: 12)			
SIDES-C	Add Painted Sides (All colors)	\$ 765	\$ 880
KN-BLK	Standard Black Knob (Must be ordered with unit)	N/C	N/C
KN-C	Knob: Standard 190 RAL Color	\$ 115 ea	\$ 130 ea
KN-CF	Knob: Spec Finish (Matte RAL, Textured RAL or Prec Metals)	\$ 185 ea	\$ 215 ea
KN-PLT	Knob: Plated Trim (See options below)	\$ 250 ea	\$ 290 ea
PLATED TRIM OPTIONS: (Includes bezels, door handle, handle ends and logo)			
Antique Brass, Brushed Brass, Polished Brass, Brushed Copper & Pewter			
See page 40 for additional customization and accessories for Freestanding Ranges			

48" PLATINUM SERIES | OPEN BURNER RANGES

BlueStar Model Number Guide:			
Base Model (BSP488B) 8 Burners Natural Gas Stainless Steel Finish Standard Trim	LP Models Add (L) for LP/Propane Gas	Add code below for desired color (C) 190 Standard RAL (Semi-Gloss) Colors (CF) Specialty Finish (190 Matte RAL, Precious Metals & Textures) (CC) Custom Colors	Add (PLT) for Plated Trim Includes plated bezels, door handle, handle end and logo. See available options below.

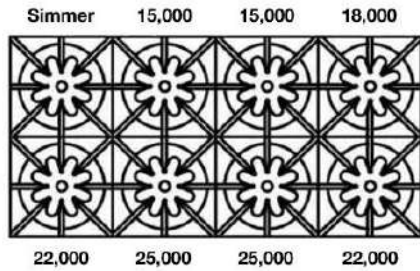

FEATURES:

- 25,000 BTU PrimaNova™ burners
- All burners, plus Interchangeable Griddle and Charbroiler accessory
- The PowR Oven™ provides 40% faster preheating and 30% increase in oven efficiency
- Precise 130° simmer burner
- Integrated wok cooking
- Extra-large oven with True European Convection and 1850° infrared broiler
- Accommodates a full-size commercial 18" x 26" baking sheet
- Includes full extension rack
- Unmatched customization – choose from 1,000+ colors and multiple trim finishes
- Handcrafted in Pennsylvania since 1880

PRODUCT SPECIFICATIONS:

- Unit Dimensions: 47.875"W x 24"D x 36.75"H
- Large Oven Intr: 26.438"W x 20"D x 15"H
- Small Oven Intr: 13.578"W x 20"D x 15"H
- Top Burner Power: 25,000 BTUs
- Simmer Burner: 9,000 BTUs
- Electrical Reqs: 120V, 60Hz, 15 AMPS, 1PH
- Gas Pressure: NAT: 5.0" WC, LP 10.0" WC
- Incoming Gas Line Size: ¾"
- Unit Weight: 750 lbs.

Model	Description (* Denotes item that must be specified)	UMRP	MSRP
Natural Gas Models: 48" Platinum Series			
BSP488B	8 Burner Nat Gas Stainless Steel Standard Trim	\$ 14,295	\$ 16,440
BSP488BPLT	8 Burner Nat Gas Stainless Steel Plated Trim*	\$ 16,490	\$ 18,965
BSP488BC	8 Burner Nat Gas Std RAL Color* Standard Trim	\$ 15,790	\$ 18,160
BSP488BCPLT	8 Burner Nat Gas Std RAL Color* Plated Trim*	\$ 17,985	\$ 20,685
BSP488BCF	8 Burner Nat Gas Specialty Finish* Standard Trim	\$ 16,890	\$ 19,425
BSP488BCFPLT	8 Burner Nat Gas Specialty Finish* Plated Trim*	\$ 19,085	\$ 21,950
BSP488BCC	8 Burner Nat Gas Custom Color* Standard Trim	\$ 18,290	\$ 21,035
BSP488BCCPLT	8 Burner Nat Gas Custom Color* Plated Trim*	\$ 20,485	\$ 23,560
LP/Propane Models: 48" Platinum Series			
BSP488BL	8 Burner LP Gas Stainless Steel Standard Trim	\$ 14,295	\$ 16,440
BSP488BLPLT	8 Burner LP Gas Stainless Steel Plated Trim*	\$ 16,490	\$ 18,965
BSP488BLC	8 Burner LP Gas Std RAL Color* Standard Trim	\$ 15,790	\$ 18,160
BSP488BLCPLT	8 Burner LP Gas Std RAL Color* Plated Trim*	\$ 17,985	\$ 20,685
BSP488BLCF	8 Burner LP Gas Specialty Finish* Standard Trim	\$ 16,890	\$ 19,425
BSP488BLCFPLT	8 Burner LP Gas Specialty Finish* Plated Trim*	\$ 19,085	\$ 21,950
BSP488BLCC	8 Burner LP Gas Custom Color* Standard Trim	\$ 18,290	\$ 21,035
BSP488BLCCPLT	8 Burner LP Gas Custom Color* Plated Trim*	\$ 20,485	\$ 23,560
BACKGUARD OPTIONS:			
All BlueStar freestanding appliances must be installed with a UL approved backguard. All units ship standard with a UL approved Island Trim unless otherwise specified.			
BG648BSP	6" Backguard	\$ 1,040	\$ 1,195
BG4817BSP	17" Backguard	\$ 2,180	\$ 2,505
SDHS48BSP	24" High Shelf	\$ 2,340	\$ 2,690
KNOB & PAINTED BODY SIDE OPTIONS: (Total Knobs: 10)			
SIDES-C	Add Painted Sides (All colors)	\$ 765	\$ 880
KN-BLK	Standard Black Knob (<i>Must be ordered with unit</i>)	N/C	N/C
KN-C	Knob: Standard 190 RAL Color	\$ 115 ea	\$ 130 ea
KN-CF	Knob: Spec Finish (Matte RAL, Textured RAL or Prec Metals)	\$ 185 ea	\$ 215 ea
KN-PLT	Knob: Plated Trim (See options below)	\$ 250 ea	\$ 290 ea
PLATED TRIM OPTIONS: (Includes bezels, door handle, handle ends and logo)			
Antique Brass, Brushed Brass, Polished Brass, Brushed Copper & Pewter			
See page 40 for additional customization and accessories for Freestanding Ranges			

36" PLATINUM SERIES | OPEN BURNER RANGES

BlueStar Model Number Guide:

Base Model (BSP366B) 6 Burners Natural Gas Stainless Steel Finish Standard Trim	LP Models Add (L) for LP/Propane Gas	Add code below for desired color (C) 190 Standard RAL (Semi-Gloss) Colors (CF) Specialty Finish (190 Matte RAL, Precious Metals & Textures) (CC) Custom Colors	Add (PLT) for Plated Trim Includes plated bezels, door handle, handle end and logo. See available options below.
---	--	--	---

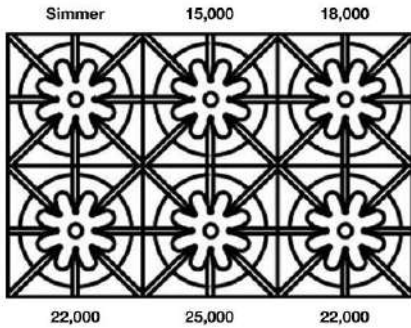

FEATURES:

- 25,000 BTU PrimaNova™ burners
- All burners, plus Interchangeable Griddle and Charbroiler accessory
- The PowR Oven™ provides 40% faster preheating and 30% increase in oven efficiency
- Precise 130° simmer burner
- Integrated wok cooking
- Extra-large oven with True European Convection and 1850° infrared broiler
- Accommodates a full-size commercial 18" x 26" baking sheet
- Includes full extension rack
- Unmatched customization – choose from 1,000+ colors and multiple trim finishes
- Handcrafted in Pennsylvania since 1880

PRODUCT SPECIFICATIONS:

- Unit Dimensions: 35.875"W x 24"D x 36.75"H
- Oven Interior: 29.25"W x 20"D x 15"H
- Top Burner Power: 25,000 BTUs
- Simmer Burner: 9,000 BTUs
- Electrical Reqs: 120V, 60Hz, 15 AMPS, 1PH
- Gas Pressure: NAT: 5.0" WC, LP 10.0" WC
- Incoming Gas Line Size: ½"
- Unit Weight: 555 lbs.

Model	Description (* Denotes item that must be specified)	UMRP	MSRP
Natural Gas Models: 36" Platinum Series			
BSP366B	6 Burner Nat Gas Stainless Steel Standard Trim	\$ 10,495	\$ 12,070
BSP366BPLT	6 Burner Nat Gas Stainless Steel Plated Trim*	\$ 12,390	\$ 14,250
BSP366BC	6 Burner Nat Gas Std RAL Color* Standard Trim	\$ 11,690	\$ 13,445
BSP366BCPLT	6 Burner Nat Gas Std RAL Color* Plated Trim*	\$ 13,585	\$ 15,625
BSP366BCF	6 Burner Nat Gas Specialty Finish* Standard Trim	\$ 12,690	\$ 14,595
BSP366BCFPLT	6 Burner Nat Gas Specialty Finish* Plated Trim*	\$ 14,585	\$ 16,775
BSP366BCC	6 Burner Nat Gas Custom Color* Standard Trim	\$ 14,190	\$ 16,320
BSP366BCCPLT	6 Burner Nat Gas Custom Color* Plated Trim*	\$ 16,085	\$ 18,500
LP/Propane Models: 36" Platinum Series			
BSP366BL	6 Burner LP Gas Stainless Steel Standard Trim	\$ 10,495	\$ 12,070
BSP366BLPLT	6 Burner LP Gas Stainless Steel Plated Trim*	\$ 12,390	\$ 14,250
BSP366BLC	6 Burner LP Gas Std RAL Color* Standard Trim	\$ 11,690	\$ 13,445
BSP366BLCPLT	6 Burner LP Gas Std RAL Color* Plated Trim*	\$ 13,585	\$ 15,625
BSP366BLCF	6 Burner LP Gas Specialty Finish* Standard Trim	\$ 12,690	\$ 14,595
BSP366BLCFPLT	6 Burner LP Gas Specialty Finish* Plated Trim*	\$ 14,585	\$ 16,775
BSP366BLCC	6 Burner LP Gas Custom Color* Standard Trim	\$ 14,190	\$ 16,320
BSP366BLCCPLT	6 Burner LP Gas Custom Color* Plated Trim*	\$ 16,085	\$ 18,500
BACKGUARD OPTIONS:			
All BlueStar freestanding appliances must be installed with a UL approved backguard. All units ship standard with a UL approved Island Trim unless otherwise specified.			
BG636BSP	6" Backguard	\$ 720	\$ 830
BG3617BSP	17" Backguard	\$ 1,460	\$ 1,680
SDHS36BSP	24" High Shelf	\$ 1,690	\$ 1,945
KNOB & PAINTED BODY SIDE OPTIONS: (Total Knobs: 7)			
SIDES-C	Add Painted Sides (All colors)	\$ 765	\$ 880
KN-BLK	Standard Black Knob (<i>Must be ordered with unit</i>)	N/C	N/C
KN-C	Knob: Standard 190 RAL Color	\$ 115 ea	\$ 130 ea
KN-CF	Knob: Spec Finish (Matte RAL, Textured RAL or Prec Metals)	\$ 185 ea	\$ 215 ea
KN-PLT	Knob: Plated Trim (See options below)	\$ 250 ea	\$ 290 ea
PLATED TRIM OPTIONS: (Includes bezels, door handle, handle ends and logo)			
Antique Brass, Brushed Brass, Polished Brass, Brushed Copper & Pewter			
See page 40 for additional customization and accessories for Freestanding Ranges			

30" PLATINUM SERIES | OPEN BURNER RANGES

BlueStar Model Number Guide:

<p style="text-align: center;">Base Model (BSP304B) 4 Burners Natural Gas Stainless Steel Finish Standard Trim</p>	<p style="text-align: center;">LP Models Add (L) for LP/Propane Gas</p>	<p style="text-align: center;">Add code below for desired color (C) 190 Standard RAL (Semi-Gloss) Colors (CF) Specialty Finish (190 Matte RAL, Precious Metals & Textures) (CC) Custom Colors</p>	<p style="text-align: center;">Add (PLT) for Plated Trim Includes plated bezels, door handle, handle end and logo. See available options below.</p>
---	--	--	--

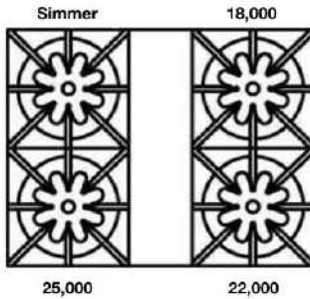

FEATURES:

- 25,000 BTU PrimaNova™ burners
- All burners, plus Interchangeable Griddle and Charbroiler accessory
- The PowR Oven™ provides 40% faster preheating and 30% increase in oven efficiency
- Precise 130° simmer burner
- Integrated wok cooking
- Extra-large oven with True European Convection and 1850° infrared broiler
- Accommodates a full-size commercial 18" x 26" baking sheet
- Unmatched customization – choose from 1,000+ colors and multiple trim finishes
- Includes full extension rack
- Handcrafted in Pennsylvania since 1880

PRODUCT SPECIFICATIONS:

- Unit Dimensions: 29.875W x 24"D x 36.75"H
- Oven Interior: 26.438"W x 20"D x 15"H
- Top Burner Power: 25,000 BTUs
- Simmer Burner: 9,000 BTUs
- Electrical Reqs: 120V, 60Hz, 15 AMPS, 1PH
- Gas Pressure: NAT: 5.0" WC, LP 10.0" WC
- Incoming Gas Line Size: ½
- Unit Weight: 480 lbs.

Model	Description (* Denotes item that must be specified)	UMRP	MSRP
Natural Gas Models: 30" Platinum Series			
BSP304B	4 Burner Nat Gas Stainless Steel Standard Trim	\$ 7,795	\$ 8,965
BSP304BPLT	4 Burner Nat Gas Stainless Steel Plated Trim*	\$ 9,390	\$ 10,800
BSP304BC	4 Burner Nat Gas Std RAL Color* Standard Trim	\$ 8,990	\$ 10,340
BSP304BCPLT	4 Burner Nat Gas Std RAL Color* Plated Trim*	\$ 10,585	\$ 12,175
BSP304BCF	4 Burner Nat Gas Specialty Finish* Standard Trim	\$ 9,990	\$ 11,490
BSP304CFPLT	4 Burner Nat Gas Specialty Finish* Plated Trim*	\$ 11,585	\$ 13,325
BSP304BCC	4 Burner Nat Gas Custom Color* Standard Trim	\$ 11,490	\$ 13,215
BSP304BCCPLT	4 Burner Nat Gas Custom Color* Plated Trim*	\$ 13,085	\$ 15,050
LP/Propane Models: 30" Platinum Series			
BSP304BL	4 Burner LP Gas Stainless Steel Standard Trim	\$ 7,795	\$ 8,965
BSP304BLPLT	4 Burner LP Gas Stainless Steel Plated Trim*	\$ 9,390	\$ 10,800
BSP304BLC	4 Burner LP Gas Std RAL Color* Standard Trim	\$ 8,990	\$ 10,340
BSP304BLCPLT	4 Burner LP Gas Std RAL Color* Plated Trim*	\$ 10,585	\$ 12,175
BSP304BLCF	4 Burner LP Gas Specialty Finish* Standard Trim	\$ 9,990	\$ 11,490
BSP304BLCFPLT	4 Burner LP Gas Specialty Finish* Plated Trim*	\$ 11,585	\$ 13,325
BSP304BLCC	4 Burner LP Gas Custom Color* Standard Trim	\$ 11,490	\$ 13,215
BSP304BLCCPLT	4 Burner LP Gas Custom Color* Plated Trim*	\$ 13,085	\$ 15,050
BACKGUARD OPTIONS:			
All BlueStar freestanding appliances must be installed with a UL approved backguard. All units ship standard with a UL approved Island Trim unless otherwise specified.			
BG630BSP	6" Backguard	\$ 605	\$ 695
BG3017BSP	17" Backguard	\$ 1,120	\$ 1,290
SDHS30BSP	24" High Shelf	\$ 1,460	\$ 1,680
KNOB & PAINTED BODY SIDE OPTIONS: (Total Knobs: 5)			
SIDES-C	Add Painted Sides (All colors)	\$ 765	\$ 880
KN-BLK	Standard Black Knob (<i>Must be ordered with unit</i>)	N/C	N/C
KN-C	Knob: Standard 190 RAL Color	\$ 115 ea	\$ 130 ea
KN-CF	Knob: Spec Finish (Matte RAL, Textured RAL or Prec Metals)	\$ 185 ea	\$ 215 ea
KN-PLT	Knob: Plated Trim (See options below)	\$ 250 ea	\$ 290 ea
PLATED TRIM OPTIONS: (Includes bezels, door handle, handle ends and logo)			
Antique Brass, Brushed Brass, Polished Brass, Brushed Copper & Pewter			
See page 40 for additional customization and accessories for Freestanding Ranges			

24" PLATINUM SERIES | OPEN BURNER RANGES

BlueStar Model Number Guide:

Base Model (BSP244B) 4 Burners Natural Gas Stainless Steel Finish Standard Trim	LP Models Add (L) for LP/Propane Gas	Add code below for desired color (C) 190 Standard RAL (Semi-Gloss) Colors (CF) Specialty Finish (190 Matte RAL, Precious Metals & Textures) (CC) Custom Colors	Add (PLT) for Plated Trim Includes plated bezels, door handle, handle end and logo. See available options below.
---	--	--	---

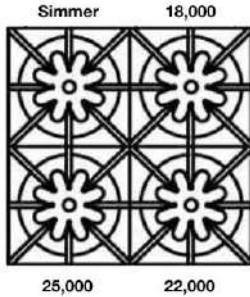

FEATURES:

- 25,000 BTU PrimaNova™ burners
- All burners, plus Interchangeable Griddle and Charbroiler accessory
- The PowR Oven™ provides 40% faster preheating and 30% increase in oven efficiency
- Precise 130° simmer burner
- Integrated wok cooking
- Extra-large oven with True European Convection and 1850° infrared broiler
- Accommodates a half-size commercial 18" x 13" baking sheet
- Includes full extension rack
- Unmatched customization – choose from 1,000+ colors and multiple trim finishes
- Handcrafted in Pennsylvania since 1880

PRODUCT SPECIFICATIONS:

- Unit Dimensions: 23.875"W x 24"D x 36.75"H
- Oven Interior: 20.25"W x 20"D x 15"H
- Top Burner Power: 25,000 BTUs
- Simmer Burner: 9,000 BTUs
- Electrical Reqs: 120V, 60Hz, 15 AMPS, 1PH
- Gas Pressure: NAT: 5.0" WC, LP 10.0" WC
- Incoming Gas Line Size: ½
- Unit Weight: 435 lbs.

Model	Description (* Denotes item that must be specified)	UMRP	MSRP
Natural Gas Models: 24" Platinum Series			
BSP244B	4 Burner Nat Gas Stainless Steel Standard Trim	\$ 7,095	\$ 8,160
BSP244BPLT	4 Burner Nat Gas Stainless Steel Plated Trim*	\$ 8,690	\$ 9,995
BSP244BC	4 Burner Nat Gas Std RAL Color* Standard Trim	\$ 8,290	\$ 9,535
BSP244BCPLT	4 Burner Nat Gas Std RAL Color* Plated Trim*	\$ 9,885	\$ 11,370
BSP244BCF	4 Burner Nat Gas Specialty Finish* Standard Trim	\$ 9,290	\$ 10,685
BSP244BCFPLT	4 Burner Nat Gas Specialty Finish* Plated Trim*	\$ 10,885	\$ 12,520
BSP244BCC	4 Burner Nat Gas Custom Color* Standard Trim	\$ 10,790	\$ 12,410
BSP244BCCPLT	4 Burner Nat Gas Custom Color* Plated Trim*	\$ 12,385	\$ 14,245
LP/Propane Models: 24" Platinum Series			
BSP244BL	4 Burner LP Gas Stainless Steel Standard Trim	\$ 7,095	\$ 8,160
BSP244BLPLT	4 Burner LP Gas Stainless Steel Plated Trim*	\$ 8,690	\$ 9,995
BSP244BLC	4 Burner LP Gas Std RAL Color* Standard Trim	\$ 8,290	\$ 9,535
BSP244BLCPLT	4 Burner LP Gas Std RAL Color* Plated Trim*	\$ 9,885	\$ 11,370
BSP244BLCF	4 Burner LP Gas Specialty Finish* Standard Trim	\$ 9,290	\$ 10,685
BSP244BLCFPLT	4 Burner LP Gas Specialty Finish* Plated Trim*	\$ 10,885	\$ 12,520
BSP244BLCC	4 Burner LP Gas Custom Color* Standard Trim	\$ 10,790	\$ 12,410
BSP244BLCCPLT	4 Burner LP Gas Custom Color* Plated Trim*	\$ 12,385	\$ 14,245
BACKGUARD OPTIONS:			
All BlueStar freestanding appliances must be installed with a UL approved backguard. All units ship standard with a UL approved Island Trim unless otherwise specified.			
BG624BSP	6" Backguard	\$ 605	\$ 695
BG2417BSP	17" Backguard	\$ 1,120	\$ 1,290
SDHS24BSP	24" High Shelf	\$ 1,460	\$ 1,680
ADDITIONAL PAINT, KNOB AND CUSTOMIZATION OPTIONS: (Total Knobs: 5)			
SIDES-C	Add Painted Sides (All colors)	\$ 765	\$ 880
KN-BLK	Standard Black Knob (<i>Must be ordered with unit</i>)	N/C	N/C
KN-C	Knob: Standard 190 RAL Color	\$ 115 ea	\$ 130 ea
KN-CF	Knob: Spec Finish (Matte RAL, Textured RAL or Prec Metals)	\$ 185 ea	\$ 215 ea
KN-PLT	Knob: Plated Trim (See options below)	\$ 250 ea	\$ 290 ea
PLATED TRIM OPTIONS: (Includes bezels, door handle, handle ends and logo)			
Antique Brass, Brushed Brass, Polished Brass, Brushed Copper & Pewter			
See page 40 for additional customization and accessories for Freestanding Ranges			

60" NOVA (RNB) SERIES | OPEN BURNER RANGES

BlueStar Model Number Guide:

Base Model (RNB6010BV2) 10 Burners Natural Gas Stainless Steel Finish Standard Trim	LP Models Add (L) for LP/Propane Gas	Add code below for desired color (C) 190 Standard RAL (Semi-Gloss) Colors (CF) Specialty Finish (190 Matte RAL, Precious Metals & Textures) (CC) Custom Colors	Add (PLT) for Plated Trim Includes plated bezels, door handle, handle end and logo. See available options below.
---	--	--	---

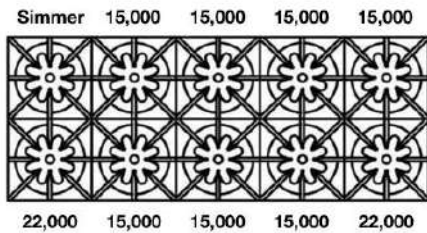

FEATURES:

- 22,000 BTU UltraNova™ burners & 15,000 BTU Nova™ burners
- Available with all burners or add integrated griddle, charbroiler or French top
- Extra-large convection oven with 1850° infrared broiler that accommodates a full size 18" x 26" commercial baking sheet
- Available with swing doors
- Unmatched customization – choose from 1,000+ colors and multiple trim finishes
- Handcrafted in Pennsylvania since 1880

PRODUCT SPECIFICATIONS:

- Unit Dimensions: 59.875"W x 24"D x 36.75"H
- Oven Interior: 26.438"W x 20"D x 15"H
- Top Burner Power: 22,000 BTUs
- Simmer Burner: 9,000 BTUs
- Electrical Reqs: 120V, 60Hz, 15 AMPS, 1PH
- Gas Pressure: NAT: 5.0" WC, LP 10.0" WC
- Incoming Gas Line Size: ¾"
- Unit Weight: 800 lbs.

Model	Description (* Denotes item that must be specified)	UMRP	MSRP
Natural Gas Models: 60" Nova (RNB) Series			
RNB6010BV2	10 Burner Nat Gas Stainless Steel Standard Trim	\$ 18,795	\$ 21,615
RNB6010BV2PLT	10 Burner Nat Gas Stainless Steel Plated Trim*	\$ 21,290	\$ 24,485
RNB6010BV2C	10 Burner Nat Gas Std RAL Color* Standard Trim	\$ 20,290	\$ 23,335
RNB6010BV2CPLT	10 Burner Nat Gas Std RAL Color* Plated Trim*	\$ 22,785	\$ 26,205
RNB6010BV2CF	10 Burner Nat Gas Specialty Finish* Standard Trim	\$ 21,390	\$ 24,600
RNB6010BV2CFPLT	10 Burner Nat Gas Specialty Finish* Plated Trim*	\$ 23,885	\$ 27,470
RNB6010BV2CC	10 Burner Nat Gas Custom Color* Standard Trim	\$ 22,790	\$ 26,210
RNB6010BV2CCPLT	10 Burner Nat Gas Custom Color* Plated Trim*	\$ 25,285	\$ 29,080
LP/Propane Models: 60" Nova (RNB) Series			
RNB6010BV2L	10 Burner LP Gas Stainless Steel Standard Trim	\$ 18,795	\$ 21,615
RNB6010BV2LPLT	10 Burner LP Gas Stainless Steel Plated Trim*	\$ 21,290	\$ 24,485
RNB6010BV2LC	10 Burner LP Gas Std RAL Color* Standard Trim	\$ 20,290	\$ 23,335
RNB6010BV2LCPLT	10 Burner LP Gas Std RAL Color* Plated Trim*	\$ 22,785	\$ 26,205
RNB6010BV2LCF	10 Burner LP Gas Specialty Finish* Standard Trim	\$ 21,390	\$ 24,600
RNB6010BV2LCFPLT	10 Burner LP Gas Specialty Finish* Plated Trim*	\$ 23,885	\$ 27,470
RNB6010BV2LCC	10 Burner LP Gas Custom Color* Standard Trim	\$ 22,790	\$ 26,210
RNB6010BV2LCCPLT	10 Burner LP Gas Custom Color* Plated Trim*	\$ 25,285	\$ 29,080
BACKGUARD OPTIONS:			
All BlueStar freestanding appliances must be installed with a UL approved backguard. All units ship standard with a UL approved Island Trim unless otherwise specified.			
BG660BSP	6" Backguard	\$ 1,530	\$ 1,760
BG6017BSP	17" Backguard	\$ 2,480	\$ 2,850
SDHS60BSP	24" High Shelf	\$ 2,900	\$ 3,335
KNOB & PAINTED BODY SIDE OPTIONS: (Total Knobs: 12)			
SIDES-C	Add Painted Sides (All colors)	\$ 765	\$ 880
KN-BLK	Standard Black Knob (<i>Must be ordered with unit</i>)	N/C	N/C
KN-C	Knob: Standard 190 RAL Color	\$ 115 ea	\$ 130 ea
KN-CF	Knob: Spec Finish (Matte RAL, Textured RAL or Prec Metals)	\$ 185 ea	\$ 215 ea
KN-PLT	Knob: Plated Trim (See options below)	\$ 250 ea	\$ 290 ea
SWING DOOR OPTIONS:			
SWING DOOR – LH	Swing Door – Left Hinge for Nova (RNB) Series	\$ 1,530	\$ 1,760
SWING DOOR – RH	Swing Door – Right Hinge for Nova (RNB) Series	\$ 1,530	\$ 1,760
PLATED TRIM OPTIONS: (Includes bezels, door handle, handle ends and logo)			
Antique Brass, Brushed Brass, Polished Brass, Brushed Copper & Pewter			
See page 40 for additional customization and accessories for Freestanding Ranges			

60" NOVA (RNB) SERIES | OPEN BURNER RANGES

**60" Nova (RNB) Series
with 12" Charbroiler**

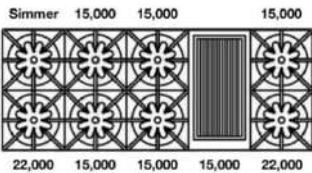

Model	Description (* Denotes item that must be specified)	UMRP	MSRP
Natural Gas Models: 60" Nova Series with 12" Charbroiler			
RNB608CBV2	8 Burner 12" Charbroiler Nat Gas Stainless Steel Standard Trim	\$ 17,995	\$ 20,695
RNB608CBV2PLT	8 Burner 12" Charbroiler Nat Gas Stainless Steel Plated Trim*	\$ 20,490	\$ 23,565
RNB608CBV2C	8 Burner 12" Charbroiler Nat Gas Std RAL Paint* Standard Trim	\$ 19,490	\$ 22,415
RNB608CBV2CPLT	8 Burner 12" Charbroiler Nat Gas Std RAL Paint* Plated Trim*	\$ 21,985	\$ 25,285
RNB608CBV2CF	8 Burner 12" Charbroiler Nat Gas Specialty Finish* Standard Trim	\$ 20,590	\$ 23,680
RNB608CBV2CFPLT	8 Burner 12" Charbroiler Nat Gas Specialty Finish* Plated Trim*	\$ 23,085	\$ 26,550
RNB608CBV2CC	8 Burner 12" Charbroiler Nat Gas Custom Color* Standard Trim	\$ 21,990	\$ 25,290
RNB608CBV2CCPLT	8 Burner 12" Charbroiler Nat Gas Custom Color* Plated Trim*	\$ 24,485	\$ 28,160
LP/Propane Models: 60" Nova Series with 12" Charbroiler			
RNB608CBV2L	8 Burner 12" Charbroiler LP Gas Stainless Steel Standard Trim	\$ 17,995	\$ 20,695
RNB608CBV2LPLT	8 Burner 12" Charbroiler LP Gas Stainless Steel Plated Trim*	\$ 20,490	\$ 23,565
RNB608CBV2LC	8 Burner 12" Charbroiler LP Gas Std RAL Paint* Standard Trim	\$ 19,490	\$ 22,415
RNB608CBV2LCPLT	8 Burner 12" Charbroiler LP Gas Std RAL Paint* Plated Trim*	\$ 21,985	\$ 25,285
RNB608CBV2LCF	8 Burner 12" Charbroiler LP Gas Specialty Finish* Standard Trim	\$ 20,590	\$ 23,680
RNB608CBV2LCFPLT	8 Burner 12" Charbroiler LP Gas Specialty Finish* Plated Trim*	\$ 23,085	\$ 26,550
RNB608CBV2LCC	8 Burner 12" Charbroiler LP Gas Custom Color* Standard Trim	\$ 21,990	\$ 25,290
RNB608CBV2LCCPLT	8 Burner 12" Charbroiler LP Gas Custom Color* Plated Trim*	\$ 24,485	\$ 28,160
Customization & Accessory Options: (See page 40) Total Knobs: 11			

**60" Nova (RNB) Series
with 24" Charbroiler**

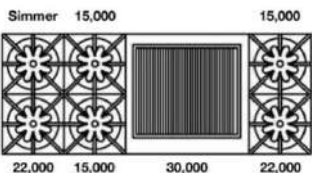

Natural Gas Models: 60" Nova Series with 24" Charbroiler			
RNB606CBV2	6 Burner 24" Charbroiler Nat Gas Stainless Steel Standard Trim	\$ 18,495	\$ 21,270
RNB606CBV2PLT	6 Burner 24" Charbroiler Nat Gas Stainless Steel Plated Trim*	\$ 20,990	\$ 24,140
RNB606CBV2C	6 Burner 24" Charbroiler Nat Gas Std RAL Paint* Standard Trim	\$ 19,990	\$ 22,990
RNB606CBV2CPLT	6 Burner 24" Charbroiler Nat Gas Std RAL Paint* Plated Trim*	\$ 22,485	\$ 25,860
RNB606CBV2CF	6 Burner 24" Charbroiler Nat Gas Specialty Finish* Standard Trim	\$ 21,090	\$ 24,255
RNB606CBV2CFPLT	6 Burner 24" Charbroiler Nat Gas Specialty Finish* Plated Trim*	\$ 23,585	\$ 27,125
RNB606CBV2CC	6 Burner 24" Charbroiler Nat Gas Custom Color* Standard Trim	\$ 22,490	\$ 25,865
RNB606CBV2CCPLT	6 Burner 24" Charbroiler Nat Gas Custom Color* Plated Trim*	\$ 24,985	\$ 28,735
LP/Propane Models: 60" Nova Series with 24" Charbroiler			
RNB606CBV2L	6 Burner 24" Charbroiler LP Gas Stainless Steel Standard Trim	\$ 18,495	\$ 21,270
RNB606CBV2LPLT	6 Burner 24" Charbroiler LP Gas Stainless Steel Plated Trim*	\$ 20,990	\$ 24,140
RNB606CBV2LC	6 Burner 24" Charbroiler LP Gas Std RAL Paint* Standard Trim	\$ 19,990	\$ 22,990
RNB606CBV2LCPLT	6 Burner 24" Charbroiler LP Gas Std RAL Paint* Plated Trim*	\$ 22,485	\$ 25,860
RNB606CBV2LCF	6 Burner 24" Charbroiler LP Gas Specialty Finish* Standard Trim	\$ 21,090	\$ 24,255
RNB606CBV2LCFPLT	6 Burner 24" Charbroiler LP Gas Specialty Finish* Plated Trim*	\$ 23,585	\$ 27,125
RNB606CBV2LCC	6 Burner 24" Charbroiler LP Gas Custom Color* Standard Trim	\$ 22,490	\$ 25,865
RNB606CBV2LCCPLT	6 Burner 24" Charbroiler LP Gas Custom Color* Plated Trim*	\$ 24,985	\$ 28,735
Customization & Accessory Options: (See page 40) Total Knobs: 10			

60" NOVA (RNB) SERIES | OPEN BURNER RANGES

60" Nova (RNB) Series with 12" Griddle

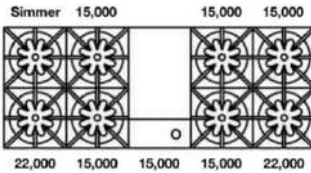

Model	Description (* Denotes item that must be specified)	UMRP	MSRP
Natural Gas Models: 60" Nova Series with 12" Griddle			
RNB608GV2	8 Burner 12" Griddle Nat Gas Stainless Steel Standard Trim	\$ 17,995	\$ 20,695
RNB608GV2PLT	8 Burner 12" Griddle Nat Gas Stainless Steel Plated Trim*	\$ 20,490	\$ 23,565
RNB608GV2C	8 Burner 12" Griddle Nat Gas Std RAL Paint* Standard Trim	\$ 19,490	\$ 22,415
RNB608GV2CPLT	8 Burner 12" Griddle Nat Gas Std RAL Paint* Plated Trim*	\$ 21,985	\$ 25,285
RNB608GV2CF	8 Burner 12" Griddle Nat Gas Specialty Finish* Standard Trim	\$ 20,590	\$ 23,680
RNB608GV2CFPLT	8 Burner 12" Griddle Nat Gas Specialty Finish* Plated Trim*	\$ 23,085	\$ 26,550
RNB608GV2CC	8 Burner 12" Griddle Nat Gas Custom Color* Standard Trim	\$ 21,990	\$ 25,290
RNB608GV2CCPLT	8 Burner 12" Griddle Nat Gas Custom Color* Plated Trim*	\$ 24,485	\$ 28,160
LP/Propane Models: 60" Nova Series with 12" Griddle			
RNB608GV2L	8 Burner 12" Griddle LP Gas Stainless Steel Standard Trim	\$ 17,995	\$ 20,695
RNB608GV2LPLT	8 Burner 12" Griddle LP Gas Stainless Steel Plated Trim*	\$ 20,490	\$ 23,565
RNB608GV2LC	8 Burner 12" Griddle LP Gas Std RAL Paint* Standard Trim	\$ 19,490	\$ 22,415
RNB608GV2LCPLT	8 Burner 12" Griddle LP Gas Std RAL Paint* Plated Trim*	\$ 21,985	\$ 25,285
RNB608GV2LCF	8 Burner 12" Griddle LP Gas Specialty Finish* Standard Trim	\$ 20,590	\$ 23,680
RNB608GV2LCFPLT	8 Burner 12" Griddle LP Gas Specialty Finish* Plated Trim*	\$ 23,085	\$ 26,550
RNB608GV2LCC	8 Burner 12" Griddle LP Gas Custom Color* Standard Trim	\$ 21,990	\$ 25,290
RNB608GV2LCCPLT	8 Burner 12" Griddle LP Gas Custom Color* Plated Trim*	\$ 24,485	\$ 28,160
Customization & Accessory Options: (See page 40) Total Knobs: 11			

60" Nova (RNB) Series with 24" Griddle

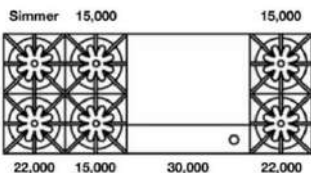

Model	Description (* Denotes item that must be specified)	UMRP	MSRP
Natural Gas Models: 60" Nova Series with 24" Griddle			
RNB606GV2	6 Burner 24" Griddle Nat Gas Stainless Steel Standard Trim	\$ 18,695	\$ 21,500
RNB606GV2PLT	6 Burner 24" Griddle Nat Gas Stainless Steel Plated Trim*	\$ 21,190	\$ 24,370
RNB606GV2C	6 Burner 24" Griddle Nat Gas Std RAL Paint* Standard Trim	\$ 20,190	\$ 23,220
RNB606GV2CPLT	6 Burner 24" Griddle Nat Gas Std RAL Paint* Plated Trim*	\$ 22,685	\$ 26,090
RNB606GV2CF	6 Burner 24" Griddle Nat Gas Specialty Finish* Standard Trim	\$ 21,290	\$ 24,485
RNB606GV2CFPLT	6 Burner 24" Griddle Nat Gas Specialty Finish* Plated Trim*	\$ 23,785	\$ 27,355
RNB606GV2CC	6 Burner 24" Griddle Nat Gas Custom Color* Standard Trim	\$ 22,690	\$ 26,095
RNB606GV2CCPLT	6 Burner 24" Griddle Nat Gas Custom Color* Plated Trim*	\$ 25,185	\$ 28,965
LP/Propane Models: 60" Nova Series with 24" Griddle			
RNB606GV2L	6 Burner 24" Griddle LP Gas Stainless Steel Standard Trim	\$ 18,695	\$ 21,500
RNB606GV2LPLT	6 Burner 24" Griddle LP Gas Stainless Steel Plated Trim*	\$ 21,190	\$ 24,370
RNB606GV2LC	6 Burner 24" Griddle LP Gas Std RAL Paint* Standard Trim	\$ 20,190	\$ 23,220
RNB606GV2LCPLT	6 Burner 24" Griddle LP Gas Std RAL Paint* Plated Trim*	\$ 22,685	\$ 26,090
RNB606GV2LCF	6 Burner 24" Griddle LP Gas Specialty Finish* Standard Trim	\$ 21,290	\$ 24,485
RNB606GV2LCFPLT	6 Burner 24" Griddle LP Gas Specialty Finish* Plated Trim*	\$ 23,785	\$ 27,355
RNB606GV2LCC	6 Burner 24" Griddle LP Gas Custom Color* Standard Trim	\$ 22,690	\$ 26,095
RNB606GV2LCCPLT	6 Burner 24" Griddle LP Gas Custom Color* Plated Trim*	\$ 25,185	\$ 28,965
Customization & Accessory Options: (See page 40) Total Knobs: 10			

60" NOVA (RNB) SERIES | OPEN BURNER RANGES

**60" Nova (RNB) Series
with 12" Griddle & Charbroiler**

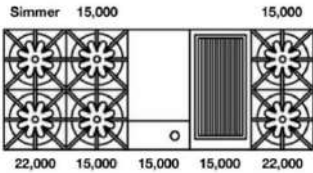

Model	Description (* Denotes item that must be specified)	UMRP	MSRP
Natural Gas Models: 60" Nova Series with 12" Griddle & Charbroiler			
RNB606GCBV2	6 Burner 12" Griddle & Char Br. Nat Gas Stainless Steel Standard Trim	\$ 18,895	\$ 21,730
RNB606GCBV2PLT	6 Burner 12" Griddle & Char Br. Nat Gas Stainless Steel Plated Trim*	\$ 21,390	\$ 24,600
RNB606GCBV2C	6 Burner 12" Griddle & Char Br. Nat Gas Std RAL Paint* Standard Trim	\$ 20,390	\$ 23,450
RNB606GCBV2CPLT	6 Burner 12" Griddle & Char Br. Nat Gas Std RAL Paint* Plated Trim*	\$ 22,885	\$ 26,320
RNB606GCBV2CF	6 Burner 12" Griddle & Char Br. Nat Gas Specialty Finish* Standard Trim	\$ 21,490	\$ 24,715
RNB606GCBV2CFPLT	6 Burner 12" Griddle & Char Br. Nat Gas Specialty Finish* Plated Trim*	\$ 23,985	\$ 27,585
RNB606GCBV2CC	6 Burner 12" Griddle & Char Br. Nat Gas Custom Color* Standard Trim	\$ 22,890	\$ 26,325
RNB606GCBV2CCPLT	6 Burner 12" Griddle & Char Br. Nat Gas Custom Color* Plated Trim*	\$ 25,385	\$ 29,195
LP/Propane Models: 60" Nova Series with 12" Griddle & Charbroiler			
RNB606GCBV2L	6 Burner 12" Griddle & Char Br. LP Gas Stainless Steel Standard Trim	\$ 18,895	\$ 21,730
RNB606GCBV2LPLT	6 Burner 12" Griddle & Char Br. LP Gas Stainless Steel Plated Trim*	\$ 21,390	\$ 24,600
RNB606GCBV2LC	6 Burner 12" Griddle & Char Br. LP Gas Std RAL Paint* Standard Trim	\$ 20,390	\$ 23,450
RNB606GCBV2LCPLT	6 Burner 12" Griddle & Char Br. LP Gas Std RAL Paint* Plated Trim*	\$ 22,885	\$ 26,320
RNB606GCBV2LCF	6 Burner 12" Griddle & Char Br. LP Gas Specialty Finish* Standard Trim	\$ 21,490	\$ 24,715
RNB606GCBV2LCFPLT	6 Burner 12" Griddle & Char Br. LP Gas Specialty Finish* Plated Trim*	\$ 23,985	\$ 27,585
RNB606GCBV2LCC	6 Burner 12" Griddle & Char Br. LP Gas Custom Color* Standard Trim	\$ 22,890	\$ 26,325
RNB606GCBV2LCCPLT	6 Burner 12" Griddle & Char Br. LP Gas Custom Color* Plated Trim*	\$ 25,385	\$ 29,195
Customization & Accessory Options: (See page 40) Total Knobs: 10			

**60" Nova (RNB) Series
with 24" French Top**

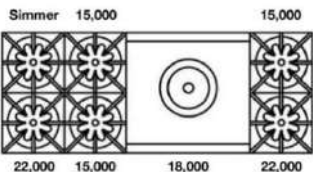

Natural Gas Models: 60" Nova Series with 24" French Top			
RNB606FTV2	6 Burner 24" French Top Nat Gas Stainless Steel Standard Trim	\$ 19,995	\$ 22,995
RNB606FTV2PLT	6 Burner 24" French Top Nat Gas Stainless Steel Plated Trim*	\$ 22,490	\$ 25,865
RNB606FTV2C	6 Burner 24" French Top Nat Gas Std RAL Paint* Standard Trim	\$ 21,490	\$ 24,715
RNB606FTV2CPLT	6 Burner 24" French Top Nat Gas Std RAL Paint* Plated Trim*	\$ 23,985	\$ 27,585
RNB606FTV2CF	6 Burner 24" French Top Nat Gas Specialty Finish* Standard Trim	\$ 22,590	\$ 25,980
RNB606FTV2CFPLT	6 Burner 24" French Top Nat Gas Specialty Finish* Plated Trim*	\$ 25,085	\$ 28,850
RNB606FTV2CC	6 Burner 24" French Top Nat Gas Custom Color* Standard Trim	\$ 23,990	\$ 27,590
RNB606FTV2CCPLT	6 Burner 24" French Top Nat Gas Custom Color* Plated Trim*	\$ 26,485	\$ 30,460
LP/Propane Models: 60" Nova Series with 24" French Top			
RNB606FTV2L	6 Burner 24" French Top LP Gas Stainless Steel Standard Trim	\$ 19,995	\$ 22,995
RNB606FTV2LPLT	6 Burner 24" French Top LP Gas Stainless Steel Plated Trim*	\$ 22,490	\$ 25,865
RNB606FTV2LC	6 Burner 24" French Top LP Gas Std RAL Paint* Standard Trim	\$ 21,490	\$ 24,715
RNB606FTV2LCPLT	6 Burner 24" French Top LP Gas Std RAL Paint* Plated Trim*	\$ 23,985	\$ 27,585
RNB606FTV2LCF	6 Burner 24" French Top LP Gas Specialty Finish* Standard Trim	\$ 22,590	\$ 25,980
RNB606FTV2LCFPLT	6 Burner 24" French Top LP Gas Specialty Finish* Plated Trim*	\$ 25,085	\$ 28,850
RNB606FTV2LCC	6 Burner 24" French Top LP Gas Custom Color* Standard Trim	\$ 23,990	\$ 27,590
RNB606FTV2LCCPLT	6 Burner 24" French Top LP Gas Custom Color* Plated Trim*	\$ 26,485	\$ 30,460
Customization & Accessory Options: (See page 40) Total Knobs: 9			

48" NOVA (RNB) SERIES | OPEN BURNER RANGES

BlueStar Model Number Guide:

<p>Base Model (RNB488BV2) 8 Burners Natural Gas Stainless Steel Finish Standard Trim</p>	<p>LP Models Add (L) for LP/Propane Gas</p>	<p>Add code below for desired color (C) 190 Standard RAL (Semi-Gloss) Colors (CF) Specialty Finish (190 Matte RAL, Precious Metals & Textures) (CC) Custom Colors</p>	<p>Add (PLT) for Plated Trim Includes plated bezels, door handle, handle end and logo. See available options below.</p>
---	--	--	--

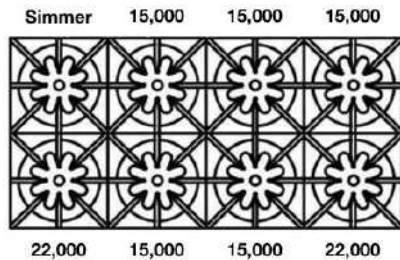

FEATURES:

- 22,000 BTU UltraNova™ burners & 15,000 BTU Nova™ burners
- Available with all burners or add integrated griddle, charbroiler or French top
- Extra-large convection oven with 1850° infrared broiler that accommodates a full size 18" x 26" commercial baking sheet
- Integrated wok cooking
- Unmatched customization – choose from 1,000+ colors and multiple trim finishes
- Handcrafted in Pennsylvania since 1880

PRODUCT SPECIFICATIONS:

- Unit Dimensions: 47.875"W x 24"D x 36.75"H
- Large Oven Inlr: 26.438"W x 20"D x 15"H
- Small Oven Inlr: 13.578"W x 20"D x 15"H
- Top Burner Power: 22,000 BTUs
- Simmer Burner: 9,000 BTUs
- Electrical Reqs: 120V, 60Hz, 15 AMPS, 1PH
- Gas Pressure: NAT: 5.0" WC, LP 10.0" WC
- Incoming Gas Line Size: ¾"
- Unit Weight: 645 lbs.

Model	Description (* Denotes item that must be specified)	UMRP	MSRP
Natural Gas Models: 48" Nova (RNB) Series			
RNB488BV2	8 Burner Nat Gas Stainless Steel Standard Trim	\$ 11,495	\$ 13,220
RNB488BV2PLT	8 Burner Nat Gas Stainless Steel Plated Trim*	\$ 13,690	\$ 15,745
RNB488BV2C	8 Burner Nat Gas Std RAL Color* Standard Trim	\$ 12,990	\$ 14,940
RNB488BV2CPLT	8 Burner Nat Gas Std RAL Color* Plated Trim*	\$ 15,185	\$ 17,465
RNB488BV2CF	8 Burner Nat Gas Specialty Finish* Standard Trim	\$ 14,090	\$ 16,205
RNB488BV2CFPLT	8 Burner Nat Gas Specialty Finish* Plated Trim*	\$ 16,285	\$ 18,730
RNB488BV2CC	8 Burner Nat Gas Custom Color* Standard Trim	\$ 15,490	\$ 17,815
RNB488BV2CCPLT	8 Burner Nat Gas Custom Color* Plated Trim*	\$ 17,685	\$ 20,340
LP/Propane Models: 48" Nova (RNB) Series			
RNB488BV2L	8 Burner LP Gas Stainless Steel Standard Trim	\$ 11,495	\$ 13,220
RNB488BV2LPLT	8 Burner LP Gas Stainless Steel Plated Trim*	\$ 13,690	\$ 15,745
RNB488BV2LC	8 Burner LP Gas Std RAL Color* Standard Trim	\$ 12,990	\$ 14,940
RNB488BV2LCPLT	8 Burner LP Gas Std RAL Color* Plated Trim*	\$ 15,185	\$ 17,465
RNB488BV2LCF	8 Burner LP Gas Specialty Finish* Standard Trim	\$ 14,090	\$ 16,205
RNB488BV2LCFPLT	8 Burner LP Gas Specialty Finish* Plated Trim*	\$ 16,285	\$ 18,730
RNB488BV2LCC	8 Burner LP Gas Custom Color* Standard Trim	\$ 15,490	\$ 17,815
RNB488BV2LCCPLT	8 Burner LP Gas Custom Color* Plated Trim*	\$ 17,685	\$ 20,340
BACKGUARD OPTIONS:			
All BlueStar freestanding appliances must be installed with a UL approved backguard. All units ship standard with a UL approved Island Trim unless otherwise specified.			
BG648BSP	6" Backguard	\$ 1,040	\$ 1,195
BG4817BSP	17" Backguard	\$ 2,180	\$ 2,505
SDHS48BSP	24" High Shelf	\$ 2,340	\$ 2,690
KNOB & PAINTED BODY SIDE OPTIONS: (Total Knobs: 10)			
SIDES-C	Add Painted Sides (All colors)	\$ 765	\$ 880
KN-BLK	Standard Black Knob (<i>Must be ordered with unit</i>)	N/C	N/C
KN-C	Knob: Standard 190 RAL Color	\$ 115 ea	\$ 130 ea
KN-CF	Knob: Spec Finish (Matte RAL, Textured RAL or Prec Metals)	\$ 185 ea	\$ 215 ea
KN-PLT	Knob: Plated Trim (See options below)	\$ 250 ea	\$ 290 ea
SWING DOOR OPTIONS:			
SWING DOOR – LH	Swing Door – Left Hinge for Nova (RNB) Series	\$ 1,530	\$ 1,760
SWING DOOR – RH	Swing Door – Right Hinge for Nova (RNB) Series	\$ 1,530	\$ 1,760
PLATED TRIM OPTIONS: (Includes bezels, door handle, handle ends and logo)			
Antique Brass, Brushed Brass, Polished Brass, Brushed Copper & Pewter			
See page 40 for additional customization and accessories for Freestanding Ranges			

48" NOVA (RNB) SERIES | OPEN BURNER RANGES

**48" Nova (RNB) Series
with 12" Griddle**

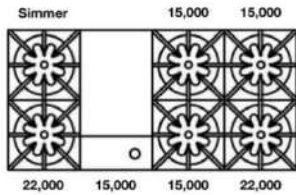

Model	Description (* Denotes item that must be specified)	UMRP	MSRP
Natural Gas Models: 48" Nova (RNB) Series with 12" Griddle			
RNB486GV2	6 Burner 12" Griddle Nat Gas Stainless Steel Standard Trim	\$ 12,495	\$ 14,370
RNB486GV2PLT	6 Burner 12" Griddle Nat Gas Stainless Steel Plated Trim*	\$ 14,690	\$ 16,895
RNB486GV2C	6 Burner 12" Griddle Nat Gas Std RAL Paint* Standard Trim	\$ 13,990	\$ 16,090
RNB486GV2CPLT	6 Burner 12" Griddle Nat Gas Std RAL Paint* Plated Trim*	\$ 16,185	\$ 18,615
RNB486GV2CF	6 Burner 12" Griddle Nat Gas Specialty Finish* Standard Trim	\$ 15,090	\$ 17,355
RNB486GV2CFPLT	6 Burner 12" Griddle Nat Gas Specialty Finish* Plated Trim*	\$ 17,285	\$ 19,880
RNB486GV2CC	6 Burner 12" Griddle Nat Gas Custom Color* Standard Trim	\$ 16,490	\$ 18,965
RNB486GV2CCPLT	6 Burner 12" Griddle Nat Gas Custom Color* Plated Trim*	\$ 18,685	\$ 21,490
LP/Propane Models: 48" Nova (RNB) Series with 12" Griddle			
RNB486GV2L	6 Burner 12" Griddle LP Gas Stainless Steel Standard Trim	\$ 12,495	\$ 14,370
RNB486GV2LPLT	6 Burner 12" Griddle LP Gas Stainless Steel Plated Trim*	\$ 14,690	\$ 16,895
RNB486GV2LC	6 Burner 12" Griddle LP Gas Std RAL Paint* Standard Trim	\$ 13,990	\$ 16,090
RNB486GV2LCPLT	6 Burner 12" Griddle LP Gas Std RAL Paint* Plated Trim*	\$ 16,185	\$ 18,615
RNB486GV2LCF	6 Burner 12" Griddle LP Gas Specialty Finish* Standard Trim	\$ 15,090	\$ 17,355
RNB486GV2LCFPLT	6 Burner 12" Griddle LP Gas Specialty Finish* Plated Trim*	\$ 17,285	\$ 19,880
RNB486GV2LCC	6 Burner 12" Griddle LP Gas Custom Color* Standard Trim	\$ 16,490	\$ 18,965
RNB486GV2LCCPLT	6 Burner 12" Griddle LP Gas Custom Color* Plated Trim*	\$ 18,685	\$ 21,490
Customization & Accessory Options: (See page 40) Total Knobs: 9			

**48" Nova (RNB) Series
with 12" Charbroiler**

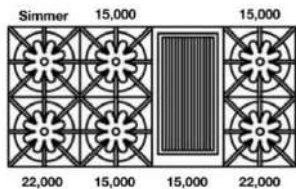

Natural Gas Models: 48" Nova (RNB) Series with 12" Charbroiler			
RNB486CBV2	6 Burner 12" Charbroiler Nat Gas Stainless Steel Standard Trim	\$ 12,495	\$ 14,370
RNB486CBV2PLT	6 Burner 12" Charbroiler Nat Gas Stainless Steel Plated Trim*	\$ 14,690	\$ 16,895
RNB486CBV2C	6 Burner 12" Charbroiler Nat Gas Std RAL Paint* Standard Trim	\$ 13,990	\$ 16,090
RNB486CBV2CPLT	6 Burner 12" Charbroiler Nat Gas Std RAL Paint* Plated Trim*	\$ 16,185	\$ 18,615
RNB486CBV2CF	6 Burner 12" Charbroiler Nat Gas Specialty Finish* Standard Trim	\$ 15,090	\$ 17,355
RNB486CBV2CFPLT	6 Burner 12" Charbroiler Nat Gas Specialty Finish* Plated Trim*	\$ 17,285	\$ 19,880
RNB486CBV2CC	6 Burner 12" Charbroiler Nat Gas Custom Color* Standard Trim	\$ 16,490	\$ 18,965
RNB486CBV2CCPLT	6 Burner 12" Charbroiler Nat Gas Custom Color* Plated Trim*	\$ 18,685	\$ 21,490
LP/Propane Models: 48" Nova (RNB) Series with 12" Charbroiler			
RNB486CBV2L	6 Burner 12" Charbroiler LP Gas Stainless Steel Standard Trim	\$ 12,495	\$ 14,370
RNB486CBV2LPLT	6 Burner 12" Charbroiler LP Gas Stainless Steel Plated Trim*	\$ 14,690	\$ 16,895
RNB486CBV2LC	6 Burner 12" Charbroiler LP Gas Std RAL Paint* Standard Trim	\$ 13,990	\$ 16,090
RNB486CBV2LCPLT	6 Burner 12" Charbroiler LP Gas Std RAL Paint* Plated Trim*	\$ 16,185	\$ 18,615
RNB486CBV2LCF	6 Burner 12" Charbroiler LP Gas Specialty Finish* Standard Trim	\$ 15,090	\$ 17,355
RNB486CBV2LCFPLT	6 Burner 12" Charbroiler LP Gas Specialty Finish* Plated Trim*	\$ 17,285	\$ 19,880
RNB486CBV2LCC	6 Burner 12" Charbroiler LP Gas Custom Color* Standard Trim	\$ 16,490	\$ 18,965
RNB486CBV2LCCPLT	6 Burner 12" Charbroiler LP Gas Custom Color* Plated Trim*	\$ 18,685	\$ 21,490
Customization & Accessory Options: (See page 40) Total Knobs: 9			

48" NOVA (RNB) SERIES | OPEN BURNER RANGES

**48" Nova (RNB) Series
with 24" Griddle**

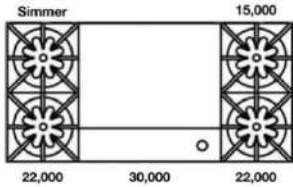

Model	Description (* Denotes item that must be specified)	UMRP	MSRP
Natural Gas Models: 48" Nova (RNB) Series with 24" Griddle			
RNB484GV2	4 Burner 24" Griddle Nat Gas Stainless Steel Standard Trim	\$ 13,395	\$ 15,405
RNB484GV2PLT	4 Burner 24" Griddle Nat Gas Stainless Steel Plated Trim*	\$ 15,590	\$ 17,930
RNB484GV2C	4 Burner 24" Griddle Nat Gas Std RAL Paint* Standard Trim	\$ 14,890	\$ 17,125
RNB484GV2CPLT	4 Burner 24" Griddle Nat Gas Std RAL Paint* Plated Trim*	\$ 17,085	\$ 19,650
RNB484GV2CF	4 Burner 24" Griddle Nat Gas Specialty Finish* Standard Trim	\$ 15,990	\$ 18,390
RNB484GV2CFPLT	4 Burner 24" Griddle Nat Gas Specialty Finish* Plated Trim*	\$ 18,185	\$ 20,915
RNB484GV2CC	4 Burner 24" Griddle Nat Gas Custom Color* Standard Trim	\$ 17,390	\$ 20,000
RNB484GV2CCPLT	4 Burner 24" Griddle Nat Gas Custom Color* Plated Trim*	\$ 19,585	\$ 22,525
LP/Propane Models: 48" Nova (RNB) Series with 24" Griddle			
RNB484GV2L	4 Burner 24" Griddle LP Gas Stainless Steel Standard Trim	\$ 13,395	\$ 15,405
RNB484GV2LPLT	4 Burner 24" Griddle LP Gas Stainless Steel Plated Trim*	\$ 15,590	\$ 17,930
RNB484GV2LC	4 Burner 24" Griddle LP Gas Std RAL Paint* Standard Trim	\$ 14,890	\$ 17,125
RNB484GV2LCPLT	4 Burner 24" Griddle LP Gas Std RAL Paint* Plated Trim*	\$ 17,085	\$ 19,650
RNB484GV2LCF	4 Burner 24" Griddle LP Gas Specialty Finish* Standard Trim	\$ 15,990	\$ 18,390
RNB484GV2LCFPLT	4 Burner 24" Griddle LP Gas Specialty Finish* Plated Trim*	\$ 18,185	\$ 20,915
RNB484GV2LCC	4 Burner 24" Griddle LP Gas Custom Color* Standard Trim	\$ 17,390	\$ 20,000
RNB484GV2LCCPLT	4 Burner 24" Griddle LP Gas Custom Color* Plated Trim*	\$ 19,585	\$ 22,525
Customization & Accessory Options: (See page 40) Total Knobs: 8			

**48" Nova (RNB) Series
with 24" Charbroiler**

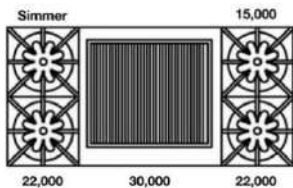

Natural Gas Models: 48" Nova (RNB) Series with 24" Charbroiler			
RNB484CBV2	4 Burner 24" Charbroiler Nat Gas Stainless Steel Standard Trim	\$ 13,395	\$ 15,405
RNB484CBV2PLT	4 Burner 24" Charbroiler Nat Gas Stainless Steel Plated Trim*	\$ 15,590	\$ 17,930
RNB484CBV2C	4 Burner 24" Charbroiler Nat Gas Std RAL Paint* Standard Trim	\$ 14,890	\$ 17,125
RNB484CBV2CPLT	4 Burner 24" Charbroiler Nat Gas Std RAL Paint* Plated Trim*	\$ 17,085	\$ 19,650
RNB484CBV2CF	4 Burner 24" Charbroiler Nat Gas Specialty Finish* Standard Trim	\$ 15,990	\$ 18,390
RNB484CBV2CFPLT	4 Burner 24" Charbroiler Nat Gas Specialty Finish* Plated Trim*	\$ 18,185	\$ 20,915
RNB484CBV2CC	4 Burner 24" Charbroiler Nat Gas Custom Color* Standard Trim	\$ 17,390	\$ 20,000
RNB484CBV2CCPLT	4 Burner 24" Charbroiler Nat Gas Custom Color* Plated Trim*	\$ 19,585	\$ 22,525
LP/Propane Models: 48" Nova (RNB) Series with 12" Charbroiler			
RNB484CBV2L	4 Burner 24" Charbroiler LP Gas Stainless Steel Standard Trim	\$ 13,395	\$ 15,405
RNB484CBV2LPLT	4 Burner 24" Charbroiler LP Gas Stainless Steel Plated Trim*	\$ 15,590	\$ 17,930
RNB484CBV2LC	4 Burner 24" Charbroiler LP Gas Std RAL Paint* Standard Trim	\$ 14,890	\$ 17,125
RNB484CBV2LCPLT	4 Burner 24" Charbroiler LP Gas Std RAL Paint* Plated Trim*	\$ 17,085	\$ 19,650
RNB484CBV2LCF	4 Burner 24" Charbroiler LP Gas Specialty Finish* Standard Trim	\$ 15,990	\$ 18,390
RNB484CBV2LCFPLT	4 Burner 24" Charbroiler LP Gas Specialty Finish* Plated Trim*	\$ 18,185	\$ 20,915
RNB484CBV2LCC	4 Burner 24" Charbroiler LP Gas Custom Color* Standard Trim	\$ 17,390	\$ 20,000
RNB484CBV2LCCPLT	4 Burner 24" Charbroiler LP Gas Custom Color* Plated Trim*	\$ 19,585	\$ 22,525
Customization & Accessory Options: (See page 40) Total Knobs: 8			

48" NOVA (RNB) SERIES | OPEN BURNER RANGES

**48" Nova (RNB) Series
with 12" Griddle & Charbroiler**

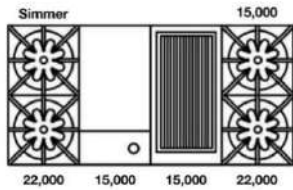

Model	Description (* Denotes item that must be specified)	UMRP	MSRP
Natural Gas Models: 48" Nova (RNB) Series with 12" Griddle & Charbroiler			
RNB484GCBV2	4 Burner 12" Griddle & Char Br. Nat Gas Stainless Steel Standard Trim	\$ 13,995	\$ 16,095
RNB484GCBV2PLT	4 Burner 12" Griddle & Char Br. Nat Gas Stainless Steel Plated Trim*	\$ 16,190	\$ 18,620
RNB484GCBV2C	4 Burner 12" Griddle & Char Br. Nat Gas Std RAL Paint* Standard Trim	\$ 15,490	\$ 17,815
RNB484GCBV2CPLT	4 Burner 12" Griddle & Char Br. Nat Gas Std RAL Paint* Plated Trim*	\$ 17,685	\$ 20,340
RNB484GCBV2CF	4 Burner 12" Griddle & Char Br. Nat Gas Specialty Finish* Standard Trim	\$ 16,590	\$ 19,080
RNB484GCBV2CFPLT	4 Burner 12" Griddle & Char Br. Nat Gas Specialty Finish* Plated Trim*	\$ 18,785	\$ 21,605
RNB484GCBV2CC	4 Burner 12" Griddle & Char Br. Nat Gas Custom Color* Standard Trim	\$ 17,990	\$ 20,690
RNB484GCBV2CCPLT	4 Burner 12" Griddle & Char Br. Nat Gas Custom Color* Plated Trim*	\$ 20,185	\$ 23,215
LP/Propane Models: 48" Nova (RNB) Series with 12" Griddle & Charbroiler			
RNB484GCBV2L	4 Burner 12" Griddle & Char Br LP Gas Stainless Steel Standard Trim	\$ 13,995	\$ 16,095
RNB484GCBV2LPLT	4 Burner 12" Griddle & Char Br LP Gas Stainless Steel Plated Trim*	\$ 16,190	\$ 18,620
RNB484GCBV2LC	4 Burner 12" Griddle & Char Br LP Gas Std RAL Paint* Standard Trim	\$ 15,490	\$ 17,815
RNB484GCBV2LCPLT	4 Burner 12" Griddle & Char Br LP Gas Std RAL Paint* Plated Trim*	\$ 17,685	\$ 20,340
RNB484GCBV2LCF	4 Burner 12" Griddle & Char Br LP Gas Specialty Finish* Standard Trim	\$ 16,590	\$ 19,080
RNB484GCBV2LCFPLT	4 Burner 12" Griddle & Char Br LP Gas Specialty Finish* Plated Trim*	\$ 18,785	\$ 21,605
RNB484GCBV2LCC	4 Burner 12" Griddle & Char Br LP Gas Custom Color* Standard Trim	\$ 17,990	\$ 20,690
RNB484GCBV2LCCPLT	4 Burner 12" Griddle & Char Br LP Gas Custom Color* Plated Trim*	\$ 20,185	\$ 23,215
Customization & Accessory Options: (See page 40) Total Knobs: 8			

**48" Nova (RNB) Series
with 24" French Top**

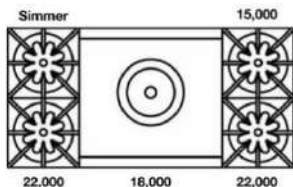

Model	Description (* Denotes item that must be specified)	UMRP	MSRP
Natural Gas Models: 48" Nova (RNB) Series with 24" French Top			
RNB484FTBV2	4 Burner 24" French Top Nat Gas Stainless Steel Standard Trim	\$ 14,295	\$ 16,440
RNB484FTBV2PLT	4 Burner 24" French Top Nat Gas Stainless Steel Plated Trim*	\$ 16,490	\$ 18,965
RNB484FTBV2C	4 Burner 24" French Top Nat Gas Std RAL Paint* Standard Trim	\$ 15,790	\$ 18,160
RNB484FTBV2CPLT	4 Burner 24" French Top Nat Gas Std RAL Paint* Plated Trim*	\$ 17,985	\$ 20,685
RNB484FTBV2CF	4 Burner 24" French Top Nat Gas Specialty Finish* Standard Trim	\$ 16,890	\$ 19,425
RNB484FTBV2CFPLT	4 Burner 24" French Top Nat Gas Specialty Finish* Plated Trim*	\$ 19,085	\$ 21,950
RNB484FTBV2CC	4 Burner 24" French Top Nat Gas Custom Color* Standard Trim	\$ 18,290	\$ 21,035
RNB484FTBV2CCPLT	4 Burner 24" French Top Nat Gas Custom Color* Plated Trim*	\$ 20,485	\$ 23,560
LP/Propane Models: 48" Nova (RNB) Series with 24" French Top			
RNB484FTBV2L	4 Burner 24" French Top LP Gas Stainless Steel Standard Trim	\$ 14,295	\$ 16,440
RNB484FTBV2LPLT	4 Burner 24" French Top LP Gas Stainless Steel Plated Trim*	\$ 16,490	\$ 18,965
RNB484FTBV2LC	4 Burner 24" French Top LP Gas Std RAL Paint* Standard Trim	\$ 15,790	\$ 18,160
RNB484FTBV2LCPLT	4 Burner 24" French Top LP Gas Std RAL Paint* Plated Trim*	\$ 17,985	\$ 20,685
RNB484FTBV2LCF	4 Burner 24" French Top LP Gas Specialty Finish* Standard Trim	\$ 16,890	\$ 19,425
RNB484FTBV2LCFPLT	4 Burner 24" French Top LP Gas Specialty Finish* Plated Trim*	\$ 19,085	\$ 21,950
RNB484FTBV2LCC	4 Burner 24" French Top LP Gas Custom Color* Standard Trim	\$ 18,290	\$ 21,035
RNB484FTBV2LCCPLT	4 Burner 24" French Top LP Gas Custom Color* Plated Trim*	\$ 20,485	\$ 23,560
Customization & Accessory Options: (See page 40) Total Knobs: 7			

36" NOVA (RNB) SERIES | OPEN BURNER RANGES

BlueStar Model Number Guide:

<p>Base Model (RNB366BV2) 6 Burners Natural Gas Stainless Steel Finish Standard Trim</p>	<p>LP Models Add (L) for LP/Propane Gas</p>	<p>Add code below for desired color (C) 190 Standard RAL (Semi-Gloss) Colors (CF) Specialty Finish (190 Matte RAL, Precious Metals & Textures) (CC) Custom Colors</p>	<p>Add (PLT) for Plated Trim Includes plated bezels, door handle, handle end and logo. See available options below.</p>
---	--	--	--

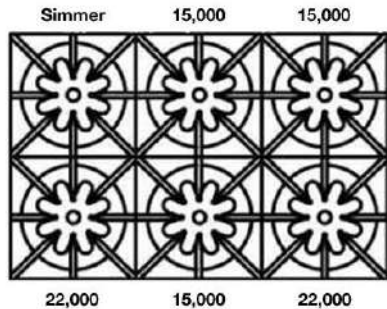

FEATURES:

- 22,000 BTU UltraNova™ burners & 15,000 BTU Nova™ burners
- Precise 130° simmer burner
- Available with all burners or add integrated griddle or charbroiler
- Extra-large convection oven with 1850° infrared broiler that accommodates a full size 18" x 26" commercial baking sheet
- Includes full extension rack
- Integrated wok cooking
- Available with swing doors
- Unmatched customization – choose from 1,000+ colors and multiple trim finishes
- Handcrafted in Pennsylvania since 1880

PRODUCT SPECIFICATIONS:

- Unit Dimensions: 35.875"W x 24"D x 36.75"H
- Oven Interior: 29.25"W x 20"D x 15"H
- Top Burner Power: 22,000 BTUs
- Simmer Burner: 9,000 BTUs
- Electrical Reqs: 120V, 60Hz, 15 AMPS, 1PH
- Gas Pressure: NAT: 5.0" WC, LP 10.0" WC
- Incoming Gas Line Size: ½"
- Unit Weight: 470 lbs.

Model	Description (* Denotes item that must be specified)	UMRP	MSRP
Natural Gas Models: 36" Nova (RNB) Series			
RNB366BV2	6 Burner Nat Gas Stainless Steel Standard Trim	\$ 7,495	\$ 8,620
RNB366BV2PLT	6 Burner Nat Gas Stainless Steel Plated Trim*	\$ 9,390	\$ 10,800
RNB366BV2C	6 Burner Nat Gas Std RAL Color* Standard Trim	\$ 8,690	\$ 9,995
RNB366BV2CPLT	6 Burner Nat Gas Std RAL Color* Plated Trim*	\$ 10,585	\$ 12,175
RNB366BV2CF	6 Burner Nat Gas Specialty Finish* Standard Trim	\$ 9,690	\$ 11,145
RNB366BV2CFPLT	6 Burner Nat Gas Specialty Finish* Plated Trim*	\$ 11,585	\$ 13,325
RNB366BV2CC	6 Burner Nat Gas Custom Color* Standard Trim	\$ 11,190	\$ 12,870
RNB366BV2CCPLT	6 Burner Nat Gas Custom Color* Plated Trim*	\$ 13,085	\$ 15,050
LP/Propane Models: 36" Nova (RNB) Series			
RNB366BV2L	6 Burner LP Gas Stainless Steel Standard Trim	\$ 7,495	\$ 8,620
RNB366BV2LPLT	6 Burner LP Gas Stainless Steel Plated Trim*	\$ 9,390	\$ 10,800
RNB366BV2LC	6 Burner LP Gas Std RAL Color* Standard Trim	\$ 8,690	\$ 9,995
RNB366BV2LCPLT	6 Burner LP Gas Std RAL Color* Plated Trim*	\$ 10,585	\$ 12,175
RNB366BV2LCF	6 Burner LP Gas Specialty Finish* Standard Trim	\$ 9,690	\$ 11,145
RNB366BV2LCFPLT	6 Burner LP Gas Specialty Finish* Plated Trim*	\$ 11,585	\$ 13,325
RNB366BV2LCC	6 Burner LP Gas Custom Color* Standard Trim	\$ 11,190	\$ 12,870
RNB366BV2LCCPLT	6 Burner LP Gas Custom Color* Plated Trim*	\$ 13,085	\$ 15,050
BACKGUARD OPTIONS:			
All BlueStar freestanding appliances must be installed with a UL approved backguard. All units ship standard with a UL approved Island Trim unless otherwise specified.			
BG636BSP	6" Backguard	\$ 720	\$ 830
BG3617BSP	17" Backguard	\$ 1,460	\$ 1,680
SDHS36BSP	24" High Shelf	\$ 1,690	\$ 1,945
KNOB & PAINTED BODY SIDE OPTIONS: (Total Knobs: 7)			
SIDES-C	Add Painted Sides (All colors)	\$ 765	\$ 880
KN-BLK	Standard Black Knob (<i>Must be ordered with unit</i>)	N/C	N/C
KN-C	Knob: Standard 190 RAL Color	\$ 115 ea	\$ 130 ea
KN-CF	Knob: Spec Finish (Matte RAL, Textured RAL or Prec Metals)	\$ 185 ea	\$ 215 ea
KN-PLT	Knob: Plated Trim (See options below)	\$ 250 ea	\$ 290 ea
SWING DOOR OPTIONS:			
SWING DOOR – LH	Swing Door – Left Hinge for Nova (RNB) Series	\$ 1,530	\$ 1,760
SWING DOOR – RH	Swing Door – Right Hinge for Nova (RNB) Series	\$ 1,530	\$ 1,760
PLATED TRIM OPTIONS: (Includes bezels, door handle, handle ends and logo)			
Antique Brass, Brushed Brass, Polished Brass, Brushed Copper & Pewter			
See page 40 for additional customization and accessories for Freestanding Ranges			

36" NOVA (RNB) SERIES | OPEN BURNER RANGES

**36" Nova (RNB) Series
with 12" Griddle**

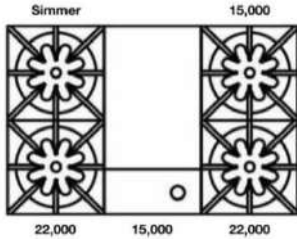

Model	Description (* Denotes item that must be specified)	UMRP	MSRP
Natural Gas Models: 36" Nova (RNB) Series with 12" Griddle			
RNB364GV2	4 Burner 12" Griddle Nat Gas Stainless Steel Standard Trim	\$ 8,495	\$ 9,770
RNB364GV2PLT	4 Burner 12" Griddle Nat Gas Stainless Steel Plated Trim*	\$ 10,390	\$ 11,950
RNB364GV2C	4 Burner 12" Griddle Nat Gas Std RAL Paint* Standard Trim	\$ 9,690	\$ 11,145
RNB364GV2CPLT	4 Burner 12" Griddle Nat Gas Std RAL Paint* Plated Trim*	\$ 11,585	\$ 13,325
RNB364GV2CF	4 Burner 12" Griddle Nat Gas Specialty Finish* Standard Trim	\$ 10,690	\$ 12,295
RNB364GV2CFPLT	4 Burner 12" Griddle Nat Gas Specialty Finish* Plated Trim*	\$ 12,585	\$ 14,475
RNB364GV2CC	4 Burner 12" Griddle Nat Gas Custom Color* Standard Trim	\$ 12,190	\$ 14,020
RNB364GV2CCPLT	4 Burner 12" Griddle Nat Gas Custom Color* Plated Trim*	\$ 14,085	\$ 16,200
LP/Propane Models: 36" Nova (RNB) Series with 12" Griddle			
RNB364GV2L	4 Burner 12" Griddle LP Gas Stainless Steel Standard Trim	\$ 8,495	\$ 9,770
RNB364GV2LPLT	4 Burner 12" Griddle LP Gas Stainless Steel Plated Trim*	\$ 10,390	\$ 11,950
RNB364GV2LC	4 Burner 12" Griddle LP Gas Std RAL Paint* Standard Trim	\$ 9,690	\$ 11,145
RNB364GV2LCPLT	4 Burner 12" Griddle LP Gas Std RAL Paint* Plated Trim*	\$ 11,585	\$ 13,325
RNB364GV2LCF	4 Burner 12" Griddle LP Gas Specialty Finish* Standard Trim	\$ 10,690	\$ 12,295
RNB364GV2LCFPLT	4 Burner 12" Griddle LP Gas Specialty Finish* Plated Trim*	\$ 12,585	\$ 14,475
RNB364GV2LCC	4 Burner 12" Griddle LP Gas Custom Color* Standard Trim	\$ 12,190	\$ 14,020
RNB364GV2LCCPLT	4 Burner 12" Griddle LP Gas Custom Color* Plated Trim*	\$ 14,085	\$ 16,200
Customization & Accessory Options: (See page 40) Total Knobs: 6			

**36" Nova (RNB) Series
with 12" Charbroiler**

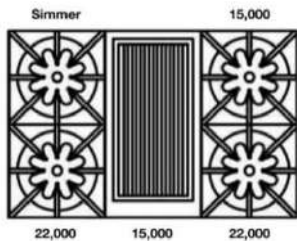

Model	Description (* Denotes item that must be specified)	UMRP	MSRP
Natural Gas Models: 36" Nova (RNB) Series with 12" Charbroiler			
RNB364CBV2	4 Burner 12" Charbroiler Nat Gas Stainless Steel Standard Trim	\$ 8,495	\$ 9,770
RNB364CBV2PLT	4 Burner 12" Charbroiler Nat Gas Stainless Steel Plated Trim*	\$ 10,390	\$ 11,950
RNB364CBV2C	4 Burner 12" Charbroiler Nat Gas Std RAL Paint* Standard Trim	\$ 9,690	\$ 11,145
RNB364CBV2CPLT	4 Burner 12" Charbroiler Nat Gas Std RAL Paint* Plated Trim*	\$ 11,585	\$ 13,325
RNB364CBV2CF	4 Burner 12" Charbroiler Nat Gas Specialty Finish* Standard Trim	\$ 10,690	\$ 12,295
RNB364CBV2CFPLT	4 Burner 12" Charbroiler Nat Gas Specialty Finish* Plated Trim*	\$ 12,585	\$ 14,475
RNB364CBV2CC	4 Burner 12" Charbroiler Nat Gas Custom Color* Standard Trim	\$ 12,190	\$ 14,020
RNB364CBV2CCPLT	4 Burner 12" Charbroiler Nat Gas Custom Color* Plated Trim*	\$ 14,085	\$ 16,200
LP/Propane Models: 36" Nova (RNB) Series with 12" Charbroiler			
RNB364CBV2L	4 Burner 12" Charbroiler LP Gas Stainless Steel Standard Trim	\$ 8,495	\$ 9,770
RNB364CBV2LPLT	4 Burner 12" Charbroiler LP Gas Stainless Steel Plated Trim*	\$ 10,390	\$ 11,950
RNB364CBV2LC	4 Burner 12" Charbroiler LP Gas Std RAL Paint* Standard Trim	\$ 9,690	\$ 11,145
RNB364CBV2LCPLT	4 Burner 12" Charbroiler LP Gas Std RAL Paint* Plated Trim*	\$ 11,585	\$ 13,325
RNB364CBV2LCF	4 Burner 12" Charbroiler LP Gas Specialty Finish* Standard Trim	\$ 10,690	\$ 12,295
RNB364CBV2LCFPLT	4 Burner 12" Charbroiler LP Gas Specialty Finish* Plated Trim*	\$ 12,585	\$ 14,475
RNB364CBV2LCC	4 Burner 12" Charbroiler LP Gas Custom Color* Standard Trim	\$ 12,190	\$ 14,020
RNB364CBV2LCCPLT	4 Burner 12" Charbroiler LP Gas Custom Color* Plated Trim*	\$ 14,085	\$ 16,200
Customization & Accessory Options: (See page 40) Total Knobs: 6			

30" NOVA (RNB) SERIES | OPEN BURNER RANGES

BlueStar Model Number Guide:			
Base Model (RNB304BV2) 4 Burners Natural Gas Stainless Steel Finish Standard Trim	LP Models Add (L) for LP/Propane Gas	Add code below for desired color (C) 190 Standard RAL (Semi-Gloss) Colors (CF) Specialty Finish (190 Matte RAL, Precious Metals & Textures) (CC) Custom Colors	Add (PLT) for Plated Trim Includes plated bezels, door handle, handle end and logo. See available options below.

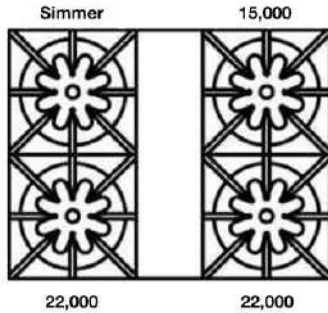

FEATURES:

- 22,000 BTU UltraNova™ burners & 15,000 BTU Nova™ burners
- Precise 130° simmer burner
- Extra-large convection oven with 1850° infrared broiler that accommodates a full size 18" x 26" commercial baking sheet
- Includes full extension rack
- Integrated wok cooking
- Available with swing doors
- Unmatched customization – choose from 1,000+ colors and multiple trim finishes
- Handcrafted in Pennsylvania since 1880

PRODUCT SPECIFICATIONS:

- Unit Dimensions: 29.875W x 24"D x 36.75"H
- Oven Interior: 26.438"W x 20"D x 15"H
- Top Burner Power: 22,000 BTUs
- Simmer Burner: 9,000 BTUs
- Electrical Reqs: 120V, 60Hz, 15 AMPS, 1PH
- Gas Pressure: NAT: 5.0" WC, LP 10.0" WC
- Incoming Gas Line Size: ½"
- Unit Weight: 420 lbs.

Model	Description (* Denotes item that must be specified)	UMRP	MSRP
Natural Gas Models: 30" Nova (RNB) Series			
RNB304BV2	4 Burner Nat Gas Stainless Steel Standard Trim	\$ 5,795	\$ 6,665
RNB304BV2PLT	4 Burner Nat Gas Stainless Steel Plated Trim*	\$ 7,390	\$ 8,500
RNB304BV2C	4 Burner Nat Gas Std RAL Color* Standard Trim	\$ 6,990	\$ 8,040
RNB304BV2CPLT	4 Burner Nat Gas Std RAL Color* Plated Trim*	\$ 8,585	\$ 9,875
RNB304BV2CF	4 Burner Nat Gas Specialty Finish* Standard Trim	\$ 7,990	\$ 9,190
RNB304BV2CFPLT	4 Burner Nat Gas Specialty Finish* Plated Trim*	\$ 9,585	\$ 11,025
RNB304BV2CC	4 Burner Nat Gas Custom Color* Standard Trim	\$ 9,490	\$ 10,915
RNB304BV2CCPLT	4 Burner Nat Gas Custom Color* Plated Trim*	\$ 11,085	\$ 12,750
LP/Propane Models: 30" Nova (RNB) Series			
RNB304BV2L	4 Burner LP Gas Stainless Steel Standard Trim	\$ 5,795	\$ 6,665
RNB304BV2LPLT	4 Burner LP Gas Stainless Steel Plated Trim*	\$ 7,390	\$ 8,500
RNB304BV2LC	4 Burner LP Gas Std RAL Color* Standard Trim	\$ 6,990	\$ 8,040
RNB304BV2LCPLT	4 Burner LP Gas Std RAL Color* Plated Trim*	\$ 8,585	\$ 9,875
RNB304BV2LCF	4 Burner LP Gas Specialty Finish* Standard Trim	\$ 7,990	\$ 9,190
RNB304BV2LCFPLT	4 Burner LP Gas Specialty Finish* Plated Trim*	\$ 9,585	\$ 11,025
RNB304BV2LCC	4 Burner LP Gas Custom Color* Standard Trim	\$ 9,490	\$ 10,915
RNB304BV2LCCPLT	4 Burner LP Gas Custom Color* Plated Trim*	\$ 11,085	\$ 12,750
BACKGUARD OPTIONS:			
All BlueStar freestanding appliances must be installed with a UL approved backguard. All units ship standard with a UL approved Island Trim unless otherwise specified.			
BG630BSP	6" Backguard	\$ 605	\$ 695
BG3017BSP	17" Backguard	\$ 1,120	\$ 1,290
SDHS30BSP	24" High Shelf	\$ 1,460	\$ 1,680
KNOB & PAINTED BODY SIDE OPTIONS: (Total Knobs: 5)			
SIDES-C	Add Painted Sides (All colors)	\$ 765	\$ 880
KN-BLK	Standard Black Knob (<i>Must be ordered with unit</i>)	N/C	N/C
KN-C	Knob: Standard 190 RAL Color	\$ 115 ea	\$ 130 ea
KN-CF	Knob: Spec Finish (Matte RAL, Textured RAL or Prec Metals)	\$ 185 ea	\$ 215 ea
KN-PLT	Knob: Plated Trim (See options below)	\$ 250 ea	\$ 290 ea
SWING DOOR OPTIONS:			
SWING DOOR – LH	Swing Door – Left Hinge for Nova (RNB) Series	\$ 1,530	\$ 1,760
SWING DOOR – RH	Swing Door – Right Hinge for Nova (RNB) Series	\$ 1,530	\$ 1,760
PLATED TRIM OPTIONS: (Includes bezels, door handle, handle ends and logo)			
Antique Brass, Brushed Brass, Polished Brass, Brushed Copper & Pewter			
See page 40 for additional customization and accessories for Freestanding Ranges			

24" NOVA (RNB) SERIES | OPEN BURNER RANGES

BlueStar Model Number Guide:

Base Model (RNB244BV2) 4 Burners Natural Gas Stainless Steel Finish Standard Trim	LP Models Add (L) for LP/Propane Gas	Add code below for desired color (C) 190 Standard RAL (Semi-Gloss) Colors (CF) Specialty Finish (190 Matte RAL, Precious Metals & Textures) (CC) Custom Colors	Add (PLT) for Plated Trim Includes plated bezels, door handle, handle end and logo. See available options below.
---	--	--	---

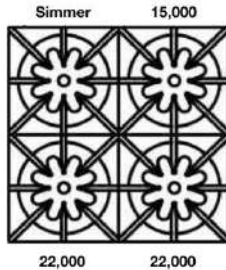

FEATURES:

- 22,000 BTU UltraNova™ burners & 15,000 BTU Nova™ burners
- Precise 130° simmer burner
- Available with all burners or all integrated griddle, charbroiler or French top
- Extra-large convection oven with 1850° infrared broiler that accommodates a half size 18" x 13" commercial baking sheet
- Includes full extension rack
- Integrated wok cooking
- Available with swing doors
- Unmatched customization – choose from 1,000+ colors and multiple trim finishes
- Handcrafted in Pennsylvania since 1880

PRODUCT SPECIFICATIONS:

- Unit Dimensions: 23.875"W x 24"D x 36.75"H
- Oven Interior: 20.25"W x 20"D x 15"H
- Top Burner Power: 22,000 BTUs
- Simmer Burner: 9,000 BTUs
- Electrical Reqs: 120V, 60Hz, 15 AMPS, 1PH
- Gas Pressure: NAT: 5.0" WC, LP 10.0" WC
- Incoming Gas Line Size: ½"
- Unit Weight: 365 lbs.

Model	Description (* Denotes item that must be specified)	UMRP	MSRP
Natural Gas Models: 24" Nova (RNB) Series			
RNB244BV2	4 Burner Nat Gas Stainless Steel Standard Trim	\$ 5,495	\$ 6,320
RNB244BV2PLT	4 Burner Nat Gas Stainless Steel Plated Trim*	\$ 7,090	\$ 8,155
RNB244BV2C	4 Burner Nat Gas Std RAL Color* Standard Trim	\$ 6,690	\$ 7,695
RNB244BV2CPLT	4 Burner Nat Gas Std RAL Color* Plated Trim*	\$ 8,285	\$ 9,530
RNB244BV2CF	4 Burner Nat Gas Specialty Finish* Standard Trim	\$ 7,690	\$ 8,845
RNB244BV2CFPLT	4 Burner Nat Gas Specialty Finish* Plated Trim*	\$ 9,285	\$ 10,680
RNB244BV2CC	4 Burner Nat Gas Custom Color* Standard Trim	\$ 9,190	\$ 10,570
RNB244BV2CCPLT	4 Burner Nat Gas Custom Color* Plated Trim*	\$ 10,785	\$ 12,405
LP/Propane Models: 24" Nova (RNB) Series			
RNB244BV2L	4 Burner LP Gas Stainless Steel Standard Trim	\$ 5,495	\$ 6,320
RNB244BV2LPLT	4 Burner LP Gas Stainless Steel Plated Trim*	\$ 7,090	\$ 8,155
RNB244BV2LC	4 Burner LP Gas Std RAL Color* Standard Trim	\$ 6,690	\$ 7,695
RNB244BV2LCPLT	4 Burner LP Gas Std RAL Color* Plated Trim*	\$ 8,285	\$ 9,530
RNB244BV2LCF	4 Burner LP Gas Specialty Finish* Standard Trim	\$ 7,690	\$ 8,845
RNB244BV2LCFPLT	4 Burner LP Gas Specialty Finish* Plated Trim*	\$ 9,285	\$ 10,680
RNB244BV2LCC	4 Burner LP Gas Custom Color* Standard Trim	\$ 9,190	\$ 10,570
RNB244BV2LCCPLT	4 Burner LP Gas Custom Color* Plated Trim*	\$ 10,785	\$ 12,405
BACKGUARD OPTIONS:			
All BlueStar freestanding appliances must be installed with a UL approved backguard. All units ship standard with a UL approved Island Trim unless otherwise specified.			
BG624BSP	6" Backguard	\$ 605	\$ 695
BG2417BSP	17" Backguard	\$ 1,120	\$ 1,290
SDHS24BSP	24" High Shelf	\$ 1,460	\$ 1,680
KNOB & PAINTED BODY SIDE OPTIONS: (Total Knobs: 5)			
SIDES-C	Add Painted Sides (All colors)	\$ 765	\$ 880
KN-BLK	Standard Black Knob (<i>Must be ordered with unit</i>)	N/C	N/C
KN-C	Knob: Standard 190 RAL Color	\$ 115 ea	\$ 130 ea
KN-CF	Knob: Spec Finish (Matte RAL, Textured RAL or Prec Metals)	\$ 185 ea	\$ 215 ea
KN-PLT	Knob: Plated Trim (See options below)	\$ 250 ea	\$ 290 ea
SWING DOOR OPTIONS:			
SWING DOOR – LH	Swing Door – Left Hinge for Nova (RNB) Series	\$ 1,530	\$ 1,760
SWING DOOR – RH	Swing Door – Right Hinge for Nova (RNB) Series	\$ 1,530	\$ 1,760
PLATED TRIM OPTIONS: (Includes bezels, door handle, handle ends and logo)			
Antique Brass, Brushed Brass, Polished Brass, Brushed Copper & Pewter			
See page 40 for additional customization and accessories for Freestanding Ranges			

24" NOVA (RNB) SERIES | OPEN BURNER RANGES

24" Nova (RNB) Series - All Griddle

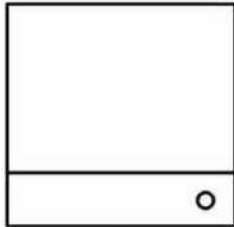

30,000

Model	Description (* Denotes item that must be specified)	UMRP	MSRP
Natural Gas Models: 24" Nova Series – All Griddle			
RNB24GV2	24" Nova Series 24" Griddle Nat Gas Stainless Steel Standard Trim	\$ 5,995	\$ 6,895
RNB24GV2PLT	24" Nova Series 24" Griddle Nat Gas Stainless Steel Plated Trim*	\$ 7,590	\$ 8,730
RNB24GV2C	24" Nova Series 24" Griddle Nat Gas Std RAL Paint* Standard Trim	\$ 7,190	\$ 8,270
RNB24GV2CPLT	24" Nova Series 24" Griddle Nat Gas Std RAL Paint* Plated Trim*	\$ 8,785	\$ 10,105
RNB24GV2CF	24" Nova Series 24" Griddle Nat Gas Specialty Finish* Standard Trim	\$ 8,190	\$ 9,420
RNB24GV2CFPLT	24" Nova Series 24" Griddle Nat Gas Specialty Finish* Plated Trim*	\$ 9,785	\$ 11,255
RNB24GV2CC	24" Nova Series 24" Griddle Nat Gas Custom Color* Standard Trim	\$ 9,690	\$ 11,145
RNB24GV2CCPLT	24" Nova Series 24" Griddle Nat Gas Custom Color* Plated Trim*	\$ 11,285	\$ 12,980
LP/Propane Models: 24" Nova Series – All Griddle			
RNB24GV2L	24" Nova Series 24" Griddle LP Gas Stainless Steel Standard Trim	\$ 5,995	\$ 6,895
RNB24GV2LPLT	24" Nova Series 24" Griddle LP Gas Stainless Steel Plated Trim*	\$ 7,590	\$ 8,730
RNB24GV2LC	24" Nova Series 24" Griddle LP Gas Std RAL Paint* Standard Trim	\$ 7,190	\$ 8,270
RNB24GV2LCPLT	24" Nova Series 24" Griddle LP Gas Std RAL Paint* Plated Trim*	\$ 8,785	\$ 10,105
RNB24GV2LCF	24" Nova Series 24" Griddle LP Gas Specialty Finish* Standard Trim	\$ 8,190	\$ 9,420
RNB24GV2LCFPLT	24" Nova Series 24" Griddle LP Gas Specialty Finish* Plated Trim*	\$ 9,785	\$ 11,255
RNB24GV2LCC	24" Nova Series 24" Griddle LP Gas Custom Color* Standard Trim	\$ 9,690	\$ 11,145
RNB24GV2LCCPLT	24" Nova Series 24" Griddle LP Gas Custom Color* Plated Trim*	\$ 11,285	\$ 12,980
Customization & Accessory Options: (See page 40) Total Knobs: 3			

24" Nova (RNB) Series - All Charbroiler

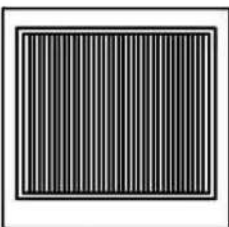

30,000

Natural Gas Models: 24" Nova Series – All Charbroiler			
RNB24CBV2	24" Nova Series 24" Charbroiler Nat Gas Stainless Steel Standard Trim	\$ 5,995	\$ 6,895
RNB24CBV2PLT	24" Nova Series 24" Charbroiler Nat Gas Stainless Steel Plated Trim*	\$ 7,590	\$ 8,730
RNB24CBV2C	24" Nova Series 24" Charbroiler Nat Gas Std RAL Paint* Standard Trim	\$ 7,190	\$ 8,270
RNB24CBV2CPLT	24" Nova Series 24" Charbroiler Nat Gas Std RAL Paint* Plated Trim*	\$ 8,785	\$ 10,105
RNB24CBV2CF	24" Nova Series 24" Charbroiler Nat Gas Specialty Finish* Standard Trim	\$ 8,190	\$ 9,420
RNB24CBV2CFPLT	24" Nova Series 24" Charbroiler Nat Gas Specialty Finish* Plated Trim*	\$ 9,785	\$ 11,255
RNB24CBV2CC	24" Nova Series 24" Charbroiler Nat Gas Custom Color* Standard Trim	\$ 9,690	\$ 11,145
RNB24CBV2CCPLT	24" Nova Series 24" Charbroiler Nat Gas Custom Color* Plated Trim*	\$ 11,285	\$ 12,980
LP/Propane Models: 24" Nova Series – Charbroiler			
RNB24CBV2L	24" Nova Series 24" Charbroiler LP Gas Stainless Steel Standard Trim	\$ 5,995	\$ 6,895
RNB24CBV2LPLT	24" Nova Series 24" Charbroiler LP Gas Stainless Steel Plated Trim*	\$ 7,590	\$ 8,730
RNB24CBV2LC	24" Nova Series 24" Charbroiler LP Gas Std RAL Paint* Standard Trim	\$ 7,190	\$ 8,270
RNB24CBV2LCPLT	24" Nova Series 24" Charbroiler LP Gas Std RAL Paint* Plated Trim*	\$ 8,785	\$ 10,105
RNB24CBV2LCF	24" Nova Series 24" Charbroiler LP Gas Specialty Finish* Standard Trim	\$ 8,190	\$ 9,420
RNB24CBV2LCFPLT	24" Nova Series 24" Charbroiler LP Gas Specialty Finish* Plated Trim*	\$ 9,785	\$ 11,255
RNB24CBV2LCC	24" Nova Series 24" Charbroiler LP Gas Custom Color* Standard Trim	\$ 9,690	\$ 11,145
RNB24CBV2LCCPLT	24" Nova Series 24" Charbroiler LP Gas Custom Color* Plated Trim*	\$ 11,285	\$ 12,980
Customization & Accessory Options: (See page 40) Total Knobs: 3			

24" NOVA (RNB) SERIES | OPEN BURNER RANGES

24" Nova (RNB) Series - All French Top

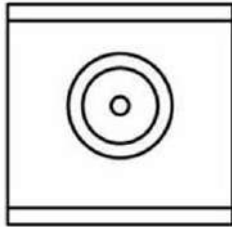

18,000

Model	Description (* Denotes item that must be specified)	UMRP	MSRP
Natural Gas Models: 24" Nova Series – All French Top			
RNB24FTV2	24" Nova Series 24" French Top Nat Gas Stainless Steel Standard Trim	\$ 6,495	\$ 7,470
RNB24FTV2PLT	24" Nova Series 24" French Top Nat Gas Stainless Steel Plated Trim*	\$ 8,090	\$ 9,305
RNB24FTV2C	24" Nova Series 24" French Top Nat Gas Std RAL Paint* Standard Trim	\$ 7,690	\$ 8,845
RNB24FTV2CPLT	24" Nova Series 24" French Top Nat Gas Std RAL Paint* Plated Trim*	\$ 9,285	\$ 10,680
RNB24FTV2CF	24" Nova Series 24" French Top Nat Gas Specialty Finish* Standard Trim	\$ 8,690	\$ 9,995
RNB24FTV2CFPLT	24" Nova Series 24" French Top Nat Gas Specialty Finish* Plated Trim*	\$ 10,285	\$ 11,830
RNB24FTV2CC	24" Nova Series 24" French Top Nat Gas Custom Color* Standard Trim	\$ 10,190	\$ 11,720
RNB24FTV2CCPLT	24" Nova Series 24" French Top Nat Gas Custom Color* Plated Trim*	\$ 11,785	\$ 13,555
LP/Propane Models: 24" Nova Series – All French Top			
RNB24FTV2L	24" Nova Series 24" French Top LP Gas Stainless Steel Standard Trim	\$ 6,495	\$ 7,470
RNB24FTV2LPLT	24" Nova Series 24" French Top LP Gas Stainless Steel Plated Trim*	\$ 8,090	\$ 9,305
RNB24FTV2LC	24" Nova Series 24" French Top LP Gas Std RAL Paint* Standard Trim	\$ 7,690	\$ 8,845
RNB24FTV2LCPLT	24" Nova Series 24" French Top LP Gas Std RAL Paint* Plated Trim*	\$ 9,285	\$ 10,680
RNB24FTV2LCF	24" Nova Series 24" French Top LP Gas Specialty Finish* Standard Trim	\$ 8,690	\$ 9,995
RNB24FTV2LCFPLT	24" Nova Series 24" French Top LP Gas Specialty Finish* Plated Trim*	\$ 10,285	\$ 11,830
RNB24FTV2LCC	24" Nova Series 24" French Top LP Gas Custom Color* Standard Trim	\$ 10,190	\$ 11,720
RNB24FTV2LCCPLT	24" Nova Series 24" French Top LP Gas Custom Color* Plated Trim*	\$ 11,785	\$ 13,555
Customization & Accessory Options: (See page 40) Total Knobs: 2			

36" CULINARY (RCS) SERIES | OPEN BURNER RANGES

BlueStar Model Number Guide:			
Base Model (RCS366BV2) 6 Burners Natural Gas Stainless Steel Finish Standard Trim	LP Models Add (L) for LP/Propane Gas	Add code below for desired color (C) 190 Standard RAL (Semi-Gloss) Colors (CF) Specialty Finish (190 Matte RAL, Precious Metals & Textures) (CC) Custom Colors	Add (PLT) for Plated Trim Includes plated bezels, door handle, handle end and logo. See available options below.

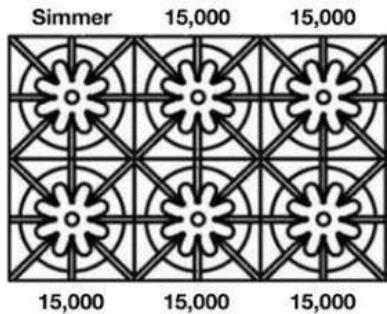

FEATURES:

- Restaurant-style 15,000 BTU open burners
- Precise 130° simmer burner
- Integrated wok cooking – no wok ring required
- Oversized convection oven accommodates full size 18" x 26" baking sheet
- 1850° infrared broiler
- Unmatched customization – choose from 1,000+ colors and multiple trim finishes
- Handcrafted in Pennsylvania
- Includes standard island trim backguard
- Available in Natural or LP gas

PRODUCT SPECIFICATIONS:

- 36" Unit Dimensions: 35.875"W x 24"D x 36.75"H
- 36" Oven Interior: 29.25"W x 20"D x 15"H
- Top Burner Power: 15,000 BTUs
- Simmer Burner: 9,000 BTUs
- Electrical Requirements: 120V, 60Hz, 15 AMPS, 1PH
- Gas Pressure: NAT: 5.0" WC, LP 10.0" WC
- Incoming Gas Line Size: ½"
- 36" Unit Weight: 470 lbs.

Model	Description (* Denotes item that must be specified)	UMRP	MSRP
Natural Gas Models: 36" Culinary Series – Open Burner			
RCS366BV2	6 Burner Nat Gas Stainless Steel Standard Trim	\$ 4,995	\$ 5,875
RCS366BV2PLT	6 Burner Nat Gas Stainless Steel Plated Trim*	\$ 6,890	\$ 8,105
RCS366BV2C	6 Burner Nat Gas Std RAL Color* Standard Trim	\$ 6,190	\$ 7,280
RCS366BV2CPLT	6 Burner Nat Gas Std RAL Color* Plated Trim*	\$ 8,085	\$ 9,510
RCS366BV2CF	6 Burner Nat Gas Specialty Finish* Standard Trim	\$ 7,190	\$ 8,460
RCS366BV2CFPLT	6 Burner Nat Gas Specialty Finish* Plated Trim*	\$ 9,085	\$ 10,690
RCS366BV2CC	6 Burner Nat Gas Custom Color* Standard Trim	\$ 8,690	\$ 10,225
RCS366BV2CCPLT	6 Burner Nat Gas Custom Color* Plated Trim*	\$ 10,585	\$ 12,455
LP/Propane Models: 36" Culinary Series – Open Burner			
RCS366BV2L	6 Burner LP Gas Stainless Steel Standard Trim	\$ 4,995	\$ 5,875
RCS366BV2LPLT	6 Burner LP Gas Stainless Steel Plated Trim*	\$ 6,890	\$ 8,105
RCS366BV2LC	6 Burner LP Gas Std RAL Color* Standard Trim	\$ 6,190	\$ 7,280
RCS366BV2LCPLT	6 Burner LP Gas Std RAL Color* Plated Trim*	\$ 8,085	\$ 9,510
RCS366BV2LCF	6 Burner LP Gas Specialty Finish* Standard Trim	\$ 7,190	\$ 8,460
RCS366BV2LCFPLT	6 Burner LP Gas Specialty Finish* Plated Trim*	\$ 9,085	\$ 10,690
RCS366BV2LCC	6 Burner LP Gas Custom Color* Standard Trim	\$ 8,690	\$ 10,225
RCS366BV2LCCPLT	6 Burner LP Gas Custom Color* Plated Trim*	\$ 10,585	\$ 12,455
BACKGUARD OPTIONS:			
All BlueStar freestanding appliances must be installed with a UL approved backguard. All units ship standard with a UL approved Island Trim unless otherwise specified.			
BG636BSP	6" Backguard for 36" RCS Range	\$ 720	\$ 830
BG3617BSP	17" Backguard for 36" RCS Range	\$ 1,460	\$ 1,680
SDHS36BSP	24" High Shelf for 36" RCS Range	\$ 1,690	\$ 1,945
KNOB OPTIONS: (Total Knobs: 7)			
SIDES-C	Add Painted Sides (All colors)	\$ 765	\$ 880
KN-BLK	Standard Black Knob (<i>Must be ordered with unit</i>)	N/C	N/C
KN-C	Knob: Standard 190 RAL Color	\$ 115 ea	\$ 130 ea
KN-CF	Knob: Spec Finish (Matte RAL, Textured RAL or Prec Metals)	\$ 185 ea	\$ 215 ea
KN-PLT	Knob: Plated Trim (See options below)	\$ 250 ea	\$ 290 ea
Antique Brass, Brushed Brass, Polished Brass, Brushed Copper & Pewter			
See page 40 for additional customization and accessories for Freestanding Ranges			

30" CULINARY (RCS) SERIES | OPEN BURNER RANGES

BlueStar Model Number Guide:

Base Model (RCS304BV2) 4 Burners Natural Gas Stainless Steel Finish Standard Trim	LP Models Add (L) for LP/Propane Gas	Add code below for desired color (C) 190 Standard RAL (Semi-Gloss) Colors (CF) Specialty Finish (190 Matte RAL, Precious Metals & Textures) (CC) Custom Colors	Add (PLT) for Plated Trim Includes plated bezels, door handle, handle end and logo. See available options below.
---	--	--	---

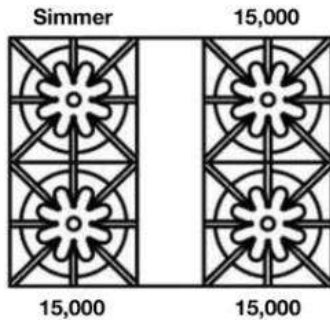

FEATURES:

- Restaurant-style 15,000 BTU open burners
- Precise 130° simmer burner
- Integrated wok cooking – no wok ring required
- Oversized convection oven accommodates full size 18" x 26" baking sheet
- 1850° infrared broiler
- Unmatched customization – choose from 1,000+ colors and multiple trim finishes
- Handcrafted in Pennsylvania
- Includes standard island trim backguard
- Available in Natural or LP gas

PRODUCT SPECIFICATIONS:

- 30" Unit Dimensions: 29.875W x 24"D x 36.75"H
- 30" Oven Interior: 26.438"W x 20"D x 15"H
- Top Burner Power: 15,000 BTUs
- Simmer Burner: 9,000 BTUs
- Electrical Requirements: 120V, 60Hz, 15 AMPS, 1PH
- Gas Pressure: NAT: 5.0" WC, LP 10.0" WC
- Incoming Gas Line Size: ½"
- 30" Unit Weight: 420 lbs.

Model	Description (* Denotes item that must be specified)	UMRP	MSRP
Natural Gas Models: 30" Culinary Series – Open Burner			
RCS304BV2	4 Burner Nat Gas Stainless Steel Standard Trim	\$ 3,995	\$ 4,700
RCS304BV2PLT	4 Burner Nat Gas Stainless Steel Plated Trim*	\$ 5,590	\$ 6,575
RCS304BV2C	4 Burner Nat Gas Std RAL Color* Standard Trim	\$ 5,190	\$ 6,105
RCS304BV2CPLT	4 Burner Nat Gas Std RAL Color* Plated Trim*	\$ 6,785	\$ 7,980
RCS304BV2CF	4 Burner Nat Gas Specialty Finish* Standard Trim	\$ 6,190	\$ 7,280
RCS304BV2CFPLT	4 Burner Nat Gas Specialty Finish* Plated Trim*	\$ 7,785	\$ 9,160
RCS304BV2CC	4 Burner Nat Gas Custom Color* Standard Trim	\$ 7,690	\$ 9,045
RCS304BV2CCPLT	4 Burner Nat Gas Custom Color* Plated Trim*	\$ 9,285	\$ 10,925
LP/Propane Models: 30" Culinary Series – Open Burner			
RCS304BV2L	4 Burner LP Gas Stainless Steel Standard Trim	\$ 3,995	\$ 4,700
RCS304BV2LPLT	4 Burner LP Gas Stainless Steel Plated Trim*	\$ 5,590	\$ 6,575
RCS304BV2LC	4 Burner LP Gas Std RAL Color* Standard Trim	\$ 5,190	\$ 6,105
RCS304BV2LCPLT	4 Burner LP Gas Std RAL Color* Plated Trim*	\$ 6,785	\$ 7,980
RCS304BV2LCF	4 Burner LP Gas Specialty Finish* Standard Trim	\$ 6,190	\$ 7,280
RCS304BV2LCFPLT	4 Burner LP Gas Specialty Finish* Plated Trim*	\$ 7,785	\$ 9,160
RCS304BV2LCC	4 Burner LP Gas Custom Color* Standard Trim	\$ 7,690	\$ 9,045
RCS304BV2LCCPLT	4 Burner LP Gas Custom Color* Plated Trim*	\$ 9,285	\$ 10,925
BACKGUARD OPTIONS:			
All BlueStar freestanding appliances must be installed with a UL approved backguard. All units ship standard with a UL approved Island Trim unless otherwise specified.			
BG630BSP	6" Backguard for 30" RCS Range	\$ 605	\$ 695
BG3017BSP	17" Backguard for 30" RCS Range	\$ 1,120	\$ 1,290
SDHS30BSP	24" High Shelf for 30" RCS Range	\$ 1,460	\$ 1,680
KNOB OPTIONS: (Total Knobs: 5)			
SIDES-C	Add Painted Sides (All colors)	\$ 765	\$ 880
KN-BLK	Standard Black Knob (<i>Must be ordered with unit</i>)	N/C	N/C
KN-C	Knob: Standard 190 RAL Color	\$ 115 ea	\$ 130 ea
KN-CF	Knob: Spec Finish (Matte RAL, Textured RAL or Prec Metals)	\$ 185 ea	\$ 215 ea
KN-PLT	Knob: Plated Trim (See options below)	\$ 250 ea	\$ 290 ea
Antique Brass, Brushed Brass, Polished Brass, Brushed Copper & Pewter			
See page 40 for additional customization and accessories for Freestanding Ranges			

48" CULINARY (RCS) SERIES | SEALED BURNER RANGES

BlueStar Model Number Guide:			
Base Model (RCS48SBV2) 8 Burners Natural Gas Stainless Steel Finish Standard Trim	LP Models Add (L) for LP/Propane Gas	Add code below for desired color (C) 190 Standard RAL (Semi-Gloss) Colors (CF) Specialty Finish (190 Matte RAL, Precious Metals & Textures) (CC) Custom Colors	Add (PLT) for Plated Trim Includes plated bezels, door handle, handle end and logo. See available options below.

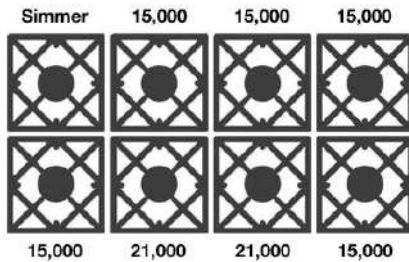

FEATURES:

- Sealed burner design with up to 21,000 BTUs of power (18,000 BTUs on LP/Propane models)
- Precise simmer burner
- Extra-large convection oven with 1850° infrared broiler that accommodates a full size 18" x 26" commercial baking sheet.
- 24" depth for compatibility with standard kitchen cabinetry
- Unmatched customization – choose from 1,000+ colors and multiple trim finishes
- Handcrafted in Pennsylvania since 1880

PRODUCT SPECIFICATIONS:

- Unit Dimensions: 47.875"W x 24"D x 36.75"H
- Large Oven Intr: 26.438"W x 20"D x 15"H
- Small Oven Intr: 13.578"W x 20"D x 15"H
- Top Burner Power: NAT: 21,000 BTUs / LP: 18,000 BTUs
- Simmer Burner: 5,000 BTUs
- Electrical Reqs: 120V, 60Hz, 15 AMPS, 1PH
- Gas Pressure: NAT: 5.0" WC, LP 10.0" WC
- Incoming Gas Line Size: ¾"
- Unit Weight: 645 lbs.

Model	Description (* Denotes item that must be specified)	UMRP	MSRP
Natural Gas Models: 48" Culinary Series – Sealed Burner			
RCS48SBV2	8 Burner Nat Gas Stainless Steel Standard Trim	\$ 9,295	\$ 10,690
RCS48SBV2PLT	8 Burner Nat Gas Stainless Steel Plated Trim*	\$ 11,490	\$ 13,215
RCS48SBV2C	8 Burner Nat Gas Std RAL Color* Standard Trim	\$ 10,790	\$ 12,410
RCS48SBV2CPLT	8 Burner Nat Gas Std RAL Color* Plated Trim*	\$ 12,985	\$ 14,935
RCS48SBV2CF	8 Burner Nat Gas Specialty Finish* Standard Trim	\$ 11,890	\$ 13,675
RCS48SBV2CFPLT	8 Burner Nat Gas Specialty Finish* Plated Trim*	\$ 14,085	\$ 16,200
RCS48SBV2CC	8 Burner Nat Gas Custom Color* Standard Trim	\$ 13,290	\$ 15,285
RCS48SBV2CCPLT	8 Burner Nat Gas Custom Color* Plated Trim*	\$ 15,485	\$ 17,810
LP/Propane Models: 48" Culinary Series – Sealed Burner			
RCS48SBV2L	8 Burner LP Gas Stainless Steel Standard Trim	\$ 9,295	\$ 10,690
RCS48SBV2LPLT	8 Burner LP Gas Stainless Steel Plated Trim*	\$ 11,490	\$ 13,215
RCS48SBV2LC	8 Burner LP Gas Std RAL Color* Standard Trim	\$ 10,790	\$ 12,410
RCS48SBV2LCPLT	8 Burner LP Gas Std RAL Color* Plated Trim*	\$ 12,985	\$ 14,935
RCS48SBV2LCF	8 Burner LP Gas Specialty Finish* Standard Trim	\$ 11,890	\$ 13,675
RCS48SBV2LCFPLT	8 Burner LP Gas Specialty Finish* Plated Trim*	\$ 14,085	\$ 16,200
RCS48SBV2LCC	8 Burner LP Gas Custom Color* Standard Trim	\$ 13,290	\$ 15,285
RCS48SBV2LCCPLT	8 Burner LP Gas Custom Color* Plated Trim*	\$ 15,485	\$ 17,810
BACKGUARD OPTIONS:			
All BlueStar freestanding appliances must be installed with a UL approved backguard. All units ship standard with a UL approved Island Trim unless otherwise specified.			
BG648SB	6" Backguard	\$ 1,040	\$ 1,195
KNOB & PAINTED BODY SIDE OPTIONS: (Total Knobs: 10)			
SIDES-C	Add Painted Sides (All colors)	\$ 765	\$ 880
KN-BLK	Standard Black Knob (<i>Must be ordered with unit</i>)	N/C	N/C
KN-C	Knob: Standard 190 RAL Color	\$ 115 ea	\$ 130 ea
KN-CF	Knob: Spec Finish (Matte RAL, Textured RAL or Prec Metals)	\$ 185 ea	\$ 215 ea
KN-PLT	Knob: Plated Trim (See options below)	\$ 250 ea	\$ 290 ea
PLATED TRIM OPTIONS: (Includes bezels, door handle, handle ends and logo)			
Antique Brass, Brushed Brass, Polished Brass, Brushed Copper & Pewter			
See page 40 for additional customization and accessories for Freestanding Ranges			

36" CULINARY (RCS) SERIES | SEALED BURNER RANGES

BlueStar Model Number Guide:

Base Model (RCS36SBV2) 6 Burners Natural Gas Stainless Steel Finish Standard Trim	LP Models Add (L) for LP/Propane Gas	Add code below for desired color (C) 190 Standard RAL (Semi-Gloss) Colors (CF) Specialty Finish (190 Matte RAL, Precious Metals & Textures) (CC) Custom Colors	Add (PLT) for Plated Trim Includes plated bezels, door handle, handle end and logo. See available options below.
---	--	--	---

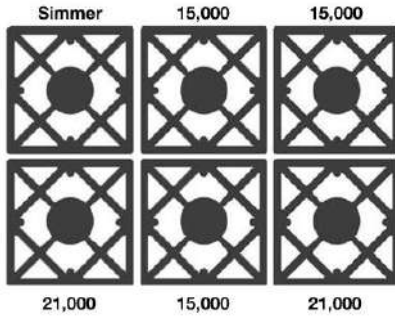

FEATURES:

- Sealed burner design with up to 21,000 BTUs of power (18,000 BTUs on LP/Propane models)
- Precise simmer burner
- Extra-large convection oven with 1850° infrared broiler that accommodates a full size 18" x 26" commercial baking sheet.
- 24" depth for compatibility with standard kitchen cabinetry
- Unmatched customization – choose from 1,000+ colors and multiple trim finishes
- Handcrafted in Pennsylvania since 1880

PRODUCT SPECIFICATIONS:

- Unit Dimensions: 35.875"W x 24"D x 36.75"H
- Oven Interior: 29.25"W x 20"D x 15"H
- Top Burner Power: NAT: 21,000 BTUs / LP: 18,000 BTUs
- Simmer Burner: 5,000 BTUs
- Electrical Reqs: 120V, 60Hz, 15 AMPS, 1PH
- Gas Pressure: NAT: 5.0" WC, LP 10.0" WC
- Incoming Gas Line Size: ½"
- Unit Weight: 420 lbs.

Model	Description (* Denotes item that must be specified)	UMRP	MSRP
Natural Gas Models: 36" Culinary Series – Sealed Burner			
RCS36SBV2	6 Burner Nat Gas Stainless Steel Standard Trim	\$ 4,995	\$ 5,875
RCS36SBV2PLT	6 Burner Nat Gas Stainless Steel Plated Trim*	\$ 6,890	\$ 8,105
RCS36SBV2C	6 Burner Nat Gas Std RAL Color* Standard Trim	\$ 6,190	\$ 7,280
RCS36SBV2CPLT	6 Burner Nat Gas Std RAL Color* Plated Trim*	\$ 8,085	\$ 9,510
RCS36SBV2CF	6 Burner Nat Gas Specialty Finish* Standard Trim	\$ 7,190	\$ 8,460
RCS36SBV2CFPLT	6 Burner Nat Gas Specialty Finish* Plated Trim*	\$ 9,085	\$ 10,690
RCS36SBV2CC	6 Burner Nat Gas Custom Color* Standard Trim	\$ 8,690	\$ 10,225
RCS36SBV2CCPLT	6 Burner Nat Gas Custom Color* Plated Trim*	\$ 10,585	\$ 12,455
LP/Propane Models: 36" Culinary Series – Sealed Burner			
RCS36SBV2L	6 Burner LP Gas Stainless Steel Standard Trim	\$ 4,995	\$ 5,875
RCS36SBV2LPLT	6 Burner LP Gas Stainless Steel Plated Trim*	\$ 6,890	\$ 8,105
RCS36SBV2LC	6 Burner LP Gas Std RAL Color* Standard Trim	\$ 6,190	\$ 7,280
RCS36SBV2LCPLT	6 Burner LP Gas Std RAL Color* Plated Trim*	\$ 8,085	\$ 9,510
RCS36SBV2LCF	6 Burner LP Gas Specialty Finish* Standard Trim	\$ 7,190	\$ 8,460
RCS36SBV2LCFPLT	6 Burner LP Gas Specialty Finish* Plated Trim*	\$ 9,085	\$ 10,690
RCS36SBV2LCC	6 Burner LP Gas Custom Color* Standard Trim	\$ 8,690	\$ 10,225
RCS36SBV2LCCPLT	6 Burner LP Gas Custom Color* Plated Trim*	\$ 10,585	\$ 12,455
BACKGUARD OPTIONS:			
All BlueStar freestanding appliances must be installed with a UL approved backguard. All units ship standard with a UL approved Island Trim unless otherwise specified.			
BG636SB	6" Backguard	\$ 720	\$ 830
BG3617SB	17" Backguard	\$ 1,460	\$ 1,680
SDHS36SB	24" High Shelf	\$ 1,690	\$ 1,945
KNOB & PAINTED BODY SIDE OPTIONS: (Total Knobs: 7)			
SIDES-C	Add Painted Sides (All colors)	\$ 765	\$ 880
KN-BLK	Standard Black Knob (<i>Must be ordered with unit</i>)	N/C	N/C
KN-C	Knob: Standard 190 RAL Color	\$ 115 ea	\$ 130 ea
KN-CF	Knob: Spec Finish (Matte RAL, Textured RAL or Prec Metals)	\$ 185 ea	\$ 215 ea
KN-PLT	Knob: Plated Trim (See options below)	\$ 250 ea	\$ 290 ea
PLATED TRIM OPTIONS: (Includes bezels, door handle, handle ends and logo)			
Antique Brass, Brushed Brass, Polished Brass, Brushed Copper & Pewter			
See page 40 for additional customization and accessories for Freestanding Ranges			

30" CULINARY (RCS) SERIES | SEALED BURNER RANGES

BlueStar Model Number Guide:			
Base Model (RCS30SBV2) 4 Burners Natural Gas Stainless Steel Finish Standard Trim	LP Models Add (L) for LP/Propane Gas	Add code below for desired color (C) 190 Standard RAL (Semi-Gloss) Colors (CF) Specialty Finish (190 Matte RAL, Precious Metals & Textures) (CC) Custom Colors	Add (PLT) for Plated Trim Includes plated bezels, door handle, handle end and logo. See available options below.

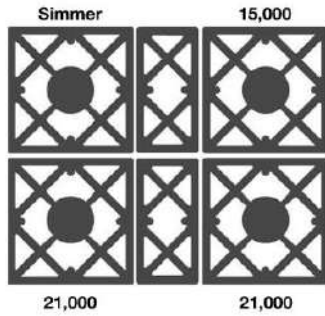

FEATURES:

- Sealed burner design with up to 21,000 BTUs of power (18,000 BTUs on LP/Propane models)
- Precise simmer burner
- Extra-large convection oven with 1850° infrared broiler that accommodates a full size 18" x 26" commercial baking sheet. 24" model accommodates half size baking sheet.
- 24" depth for compatibility with standard kitchen cabinetry
- Unmatched customization – choose from 1,000+ colors and multiple trim finishes
- Handcrafted in Pennsylvania since 1880

PRODUCT SPECIFICATIONS:

- Unit Dimensions: 29.875"W x 24"D x 36.75"H
- Oven Interior: 26.438"W x 20"D x 15"H
- Top Burner Power: NAT: 21,000 BTUs / LP: 18,000 BTUs
- Simmer Burner: 5,000 BTUs
- Electrical Reqs: 120V, 60Hz, 15 AMPS, 1PH
- Gas Pressure: NAT: 5.0" WC, LP 10.0" WC
- Incoming Gas Line Size: ½"
- Unit Weight: 380 lbs.

Model	Description (* Denotes item that must be specified)	UMRP	MSRP
Natural Gas Models: 30" Culinary Series – Sealed Burner			
RCS30SBV2	4 Burner Nat Gas Stainless Steel Standard Trim	\$ 3,995	\$ 4,700
RCS30SBV2PLT	4 Burner Nat Gas Stainless Steel Plated Trim*	\$ 5,590	\$ 6,575
RCS30SBV2C	4 Burner Nat Gas Std RAL Color* Standard Trim	\$ 5,190	\$ 6,105
RCS30SBV2CPLT	4 Burner Nat Gas Std RAL Color* Plated Trim*	\$ 6,785	\$ 7,980
RCS30SBV2CF	4 Burner Nat Gas Specialty Finish* Standard Trim	\$ 6,190	\$ 7,280
RCS30SBV2CFPLT	4 Burner Nat Gas Specialty Finish* Plated Trim*	\$ 7,785	\$ 9,160
RCS30SBV2CC	4 Burner Nat Gas Custom Color* Standard Trim	\$ 7,690	\$ 9,045
RCS30SBV2CCPLT	4 Burner Nat Gas Custom Color* Plated Trim*	\$ 9,285	\$ 10,925
LP/Propane Models: 30" Culinary Series – Sealed Burner			
RCS30SBV2L	4 Burner LP Gas Stainless Steel Standard Trim	\$ 3,995	\$ 4,700
RCS30SBV2LPLT	4 Burner LP Gas Stainless Steel Plated Trim*	\$ 5,590	\$ 6,575
RCS30SBV2LC	4 Burner LP Gas Std RAL Color* Standard Trim	\$ 5,190	\$ 6,105
RCS30SBV2LCPLT	4 Burner LP Gas Std RAL Color* Plated Trim*	\$ 6,785	\$ 7,980
RCS30SBV2LCF	4 Burner LP Gas Specialty Finish* Standard Trim	\$ 6,190	\$ 7,280
RCS30SBV2LCFPLT	4 Burner LP Gas Specialty Finish* Plated Trim*	\$ 7,785	\$ 9,160
RCS30SBV2LCC	4 Burner LP Gas Custom Color* Standard Trim	\$ 7,690	\$ 9,045
RCS30SBV2LCCPLT	4 Burner LP Gas Custom Color* Plated Trim*	\$ 9,285	\$ 10,925
BACKGUARD OPTIONS:			
All BlueStar freestanding appliances must be installed with a UL approved backguard. All units ship standard with a UL approved Island Trim unless otherwise specified.			
BG630SB	6" Backguard	\$ 720	\$ 830
BG3017SB	17" Backguard	\$ 1,460	\$ 1,680
SDHS30SB	24" High Shelf	\$ 1,690	\$ 1,945
KNOB & PAINTED BODY SIDE OPTIONS: (Total Knobs: 5)			
SIDES-C	Add Painted Sides (All colors)	\$ 765	\$ 880
KN-BLK	Standard Black Knob (<i>Must be ordered with unit</i>)	N/C	N/C
KN-C	Knob: Standard 190 RAL Color	\$ 115 ea	\$ 130 ea
KN-CF	Knob: Spec Finish (Matte RAL, Textured RAL or Prec Metals)	\$ 185 ea	\$ 215 ea
KN-PLT	Knob: Plated Trim (See options below)	\$ 250 ea	\$ 290 ea
PLATED TRIM OPTIONS: (Includes bezels, door handle, handle ends and logo)			
Antique Brass, Brushed Brass, Polished Brass, Brushed Copper & Pewter			
See page 40 for additional customization and accessories for Freestanding Ranges			

24" CULINARY (RCS) SERIES | SEALED BURNER RANGES

BlueStar Model Number Guide:

Base Model (RCS24SBV2) 4 Burners Natural Gas Stainless Steel Finish Standard Trim	LP Models Add (L) for LP/Propane Gas	Add code below for desired color (C) 190 Standard RAL (Semi-Gloss) Colors (CF) Specialty Finish (190 Matte RAL, Precious Metals & Textures) (CC) Custom Colors	Add (PLT) for Plated Trim Includes plated bezels, door handle, handle end and logo. See available options below.
---	--	--	---

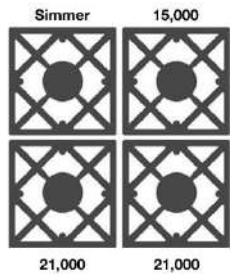

FEATURES:

- Sealed burner design with up to 21,000 BTUs of power (18,000 BTUs on LP/Propane models)
- Precise simmer burner
- Extra-large convection oven with 1850° infrared broiler that accommodates a half size 18" x 13" commercial baking sheet.
- 24" depth for compatibility with standard kitchen cabinetry
- Unmatched customization – choose from 1,000+ colors and multiple trim finishes
- Handcrafted in Pennsylvania since 1880

PRODUCT SPECIFICATIONS:

- Unit Dimensions: 23.875"W x 24"D x 36.75"H
- Oven Interior: 20.25"W x 20"D x 15"H
- Top Burner Power: NAT: 21,000 BTUs / LP: 18,000 BTUs
- Simmer Burner: 5,000 BTUs
- Electrical Reqs: 120V, 60Hz, 15 AMPS, 1PH
- Gas Pressure: NAT: 5.0" WC, LP 10.0" WC
- Incoming Gas Line Size: ½"
- Unit Weight: 365 lbs

Model	Description (* Denotes item that must be specified)	UMRP	MSRP
Natural Gas Models: 24" Culinary Series – Sealed Burner			
RCS24SBV2	4 Burner Nat Gas Stainless Steel Standard Trim	\$ 4,195	\$ 4,825
RCS24SBV2PLT	4 Burner Nat Gas Stainless Steel Plated Trim*	\$ 5,790	\$ 6,660
RCS24SBV2C	4 Burner Nat Gas Std RAL Color* Standard Trim	\$ 5,390	\$ 6,200
RCS24SBV2CPLT	4 Burner Nat Gas Std RAL Color* Plated Trim*	\$ 6,985	\$ 8,035
RCS24SBV2CF	4 Burner Nat Gas Specialty Finish* Standard Trim	\$ 6,390	\$ 7,350
RCS24SBV2CFPLT	4 Burner Nat Gas Specialty Finish* Plated Trim*	\$ 7,985	\$ 9,185
RCS24SBV2CC	4 Burner Nat Gas Custom Color* Standard Trim	\$ 7,890	\$ 9,075
RCS24SBV2CCPLT	4 Burner Nat Gas Custom Color* Plated Trim*	\$ 9,485	\$ 10,910
LP/Propane Models: 24" Culinary Series – Sealed Burner			
RCS24SBV2L	4 Burner LP Gas Stainless Steel Standard Trim	\$ 4,195	\$ 4,825
RCS24SBV2LPLT	4 Burner LP Gas Stainless Steel Plated Trim*	\$ 5,790	\$ 6,660
RCS24SBV2LC	4 Burner LP Gas Std RAL Color* Standard Trim	\$ 5,390	\$ 6,200
RCS24SBV2LCPLT	4 Burner LP Gas Std RAL Color* Plated Trim*	\$ 6,985	\$ 8,035
RCS24SBV2LCF	4 Burner LP Gas Specialty Finish* Standard Trim	\$ 6,390	\$ 7,350
RCS24SBV2LCFPLT	4 Burner LP Gas Specialty Finish* Plated Trim*	\$ 7,985	\$ 9,185
RCS24SBV2LCC	4 Burner LP Gas Custom Color* Standard Trim	\$ 7,890	\$ 9,075
RCS24SBV2LCCPLT	4 Burner LP Gas Custom Color* Plated Trim*	\$ 9,485	\$ 10,910
BACKGUARD OPTIONS:			
All BlueStar freestanding appliances must be installed with a UL approved backguard. All units ship standard with a UL approved Island Trim unless otherwise specified.			
BG624SB	6" Backguard	\$ 605	\$ 695
BG2417SB	17" Backguard	\$ 1,120	\$ 1,290
SDHS24SB	24" High Shelf	\$ 1,460	\$ 1,680
KNOB & PAINTED BODY SIDE OPTIONS: (Total Knobs: 5)			
SIDES-C	Add Painted Sides (All colors)	\$ 765	\$ 880
KN-BLK	Standard Black Knob (<i>Must be ordered with unit</i>)	N/C	N/C
KN-C	Knob: Standard 190 RAL Color	\$ 115 ea	\$ 130 ea
KN-CF	Knob: Spec Finish (Matte RAL, Textured RAL or Prec Metals)	\$ 185 ea	\$ 215 ea
KN-PLT	Knob: Plated Trim (See options below)	\$ 250 ea	\$ 290 ea
PLATED TRIM OPTIONS: (Includes bezels, door handle, handle ends and logo)			
Antique Brass, Brushed Brass, Polished Brass, Brushed Copper & Pewter			
See page 40 for additional customization and accessories for Freestanding Ranges			

30" CULINARY (RCS) SERIES | INDUCTION RANGE

BlueStar Model Number Guide:			
Base Model (BSIR30) 4 Zones Induction Stainless Steel Finish Standard Trim	LP Models Add (L) for LP/Propane Gas	Add code below for desired color (C) 190 Standard RAL (Semi-Gloss) Colors (CF) Specialty Finish (190 Matte RAL, Precious Metals & Textures) (CC) Custom Colors	Add (PLT) for Plated Trim Includes plated bezels, door handle, handle end and logo. See available options below.



7 7/8" Diameter
1,850 W
3,000 W Boost

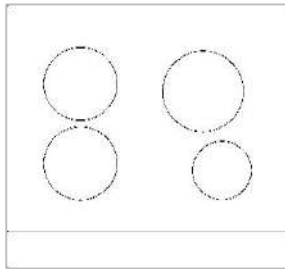

7 7/8" Diameter
1,850 W
3,000 W Boost

8 5/8" Diameter
2,300 W
3,700 W Boost

6 1/4" Diameter
1,400 W
2,200 W Boost

Model	Description (* Denotes item that must be specified)	UMRP	MSRP
Induction: 30" Induction Range			
BSIR30	4 Zone Induction Stainless Steel Standard Trim	\$ 6,995	\$ 8,045
BSIR30PLT	4 Zone Induction Stainless Steel Plated Trim*	\$ 8,590	\$ 9,880
BSIR30C	4 Zone Induction Std RAL Color* Standard Trim	\$ 8,190	\$ 9,420
BSIR30CPLT	4 Zone Induction Std RAL Color* Plated Trim*	\$ 9,785	\$ 11,255
BSIR30CF	4 Zone Induction Spec Finish* Standard Trim	\$ 9,190	\$ 10,570
BSIR30CFPLT	4 Zone Induction Spec Finish* Plated Trim*	\$ 10,785	\$ 12,405
BSIR30CC	4 Zone Induction Custom Color* Standard Trim	\$ 10,690	\$ 12,295
BSIR30CCPLT	4 Zone Induction Custom Color* Plated Trim*	\$ 12,285	\$ 14,130
KNOB & PAINTED BODY SIDE OPTIONS: (Total Knobs: 6)			
SIDES-C	Add Painted Sides (All colors)	\$ 765	\$ 880
KN-BLK	Standard Black Knob (<i>Must be ordered with unit</i>)	N/C	N/C
KN-C	Knob: Standard 190 RAL Color	\$ 115 ea	\$ 130 ea
KN-CF	Knob: Spec Finish (Matte RAL, Textured RAL or Prec Metals)	\$ 185 ea	\$ 215 ea
KN-PLT	Knob: Plated Trim (See options below)	\$ 250 ea	\$ 290 ea
PLATED TRIM OPTIONS: (Includes bezels, door handle, handle ends and logo)			
Antique Brass, Brushed Brass, Polished Brass, Brushed Copper & Pewter			
See page 40 for additional customization and accessories for Freestanding Ranges			

FEATURES:

- Four round cooking zones automatically adjust to the size of your cookware
- Nine heat levels on each zone for exceptional control
- Power Booster boils a gallon of water in less than 5 minutes
- Heat Accelerator kickstarts cooking on all zones
- Keep Warm allows two levels of even, low temperatures
- Hot-surface light indicates when safe to touch
- Oversized, electric convection oven accommodates a full size 18" x 26" commercial baking sheet
- Five selectable cooking modes: Bake, Convection Bake, Fast Preheat, Broil & Convection Broil
- Powerful 2500 watt top and bottom heating elements
- Lock function enables knobs to be electronically locked
- Available in 1,000+ colors and finishes
- Handcrafted in Pennsylvania since 1880

PRODUCT SPECIFICATIONS:

- Unit Dimensions: 29.875"W x 24"D x 36.75"H
- Oven Interior: 26.438"W x 20"D x 15"H
- Front Left Burner: 3,000 watts
- Front Right Burner: 2,200 watts
- Back Left Burner: 3,000 watts
- Back Right Burner: 3,700 watts
- Broiler Element: 2,500 watts
- Bake Element: 2,500 watts
- Elec. Req: 240 volt, 60 Hertz, 50 Amp, Single phase

CUSTOMIZATION & ACCESSORY OPTIONS | FREESTANDING RANGES

Item	Description	UMRP	MSRP
CONFIGURATION OPTIONS: (Available on Platinum & Nova/RNB Series Only)			
BURNER CHG	Add (1) Star Burner – RNB / RGTNB (Simmer, 15K & 22K) BSP (Simmer, 15K, 18K, 22K or 25K) or Swap (2) Star Burners – RNB / RGTNB / BSP	\$ 715	\$ 820
SWING DOOR – LH	Swing Door – Left Hinge – 24", 30", 36", 48" (Left Oven) & 60" (Left Oven) (RNB Series Only)	\$ 1,530	\$ 1,760
SWING DOOR – RH	Swing Door – Right Hinge - 24", 30", 36", 48" (Right Oven) & 60" (Right Oven) (RNB Series Only)	\$ 1,530	\$ 1,760
PAINT OPTIONS: (Available on Platinum, Nova/RNB & Culinary Series – Sealed Burner Series Only)			
SIDES-C	Body Sides: Standard RAL (Semi-Gloss) (2) Body sides – RNB/Platinum Excludes Pearl, Luminous & Aluminum) Must be ordered with painted range	\$ 765	\$ 880
KN-C	Knob: Standard RAL (Semi-Gloss) Knob – Factory Installed . (Excludes Pearl, Luminous & Aluminum)	\$ 115 ea	\$ 130 ea
SIDES-CF	Body Sides: Specialty Finish (Matte RAL, Textured RAL or Precious Metals) (2) Body Sides – Nova/RNB , Platinum or Culinary Series – Sealed Burner. (Excludes Pearl, Luminous & Aluminum)	\$ 765	\$ 880
KN-CF	Knob: Specialty Finish (Matte RAL, Textured RAL or Precious Metals) – Factory Installed .	\$ 185 ea	\$ 215 ea
SIDES-CC	Body Sides: Custom Color (2) Body Sides. MUST be ordered with 24" – 60" Custom Color appliance.	\$ 765	\$ 880
KN-CC	Knob: Custom Color Knob – Factory Installed. MUST be ordered with 24" – 60" Custom Color appliance.	\$ 200 ea	\$ 230 ea
PLATING OPTIONS:			
KN-PLT	Knob: Plated Trim	\$ 250 ea	\$ 290 ea
BZ-PLT	Bezel: Plated Trim	\$ 175 ea	\$ 200 ea
ACCESSORIES:			
IT24BSP	24" Island Trim Backguard for Platinum, Nova (RNB) and RCS Open Burner Ranges	\$ 565	\$ 650
IT30BSP	30" Island Trim Backguard for Platinum, Nova (RNB) and RCS Open Burner Ranges	\$ 565	\$ 650
IT36BSP	36" Island Trim Backguard for Platinum, Nova (RNB) and RCS Open Burner Ranges	\$ 665	\$ 765
IT48BSP	48" Island Trim Backguard for Platinum, Nova (RNB) and RCS Open Burner Ranges	\$ 955	\$ 1,100
IT60BSP	60" Island Trim Backguard for Platinum, Nova (RNB) and RCS Open Burner Ranges	\$ 1,210	\$ 1,390
IT24SB	24" Island Trim Backguard for RCS Sealed Burner Ranges	\$ 565	\$ 650
IT30SB	30" Island Trim Backguard for RCS Sealed Burner Ranges	\$ 565	\$ 650
IT36SB	36" Island Trim Backguard for RCS Sealed Burner Ranges	\$ 665	\$ 765
IT48SB	48" Island Trim Backguard for RCS Sealed Burner Ranges	\$ 955	\$ 1,100
KN-BLK	Standard Black Knob	\$ 115 ea	\$ 130 ea
KN-SS	Knob: Brushed Stainless Steel	\$ 115 ea	\$ 130 ea
BZ-SS	Bezel: Brushed Stainless Steel	\$ 65 ea	\$ 75 ea
CSK-1000002	Full Extension Rack for 24" Freestanding Ranges & Wall Ovens	\$ 550	\$ 635
CSK-1000003	Full Extension Rack for 30" Freestanding Ranges & Wall Ovens	\$ 590	\$ 680
CSK-1000004	Full Extension Rack for 36" Freestanding Ranges & Wall Ovens	\$ 620	\$ 715
704406	Standard Oven Rack for 24" Freestanding Ranges & Wall Ovens	\$ 120	\$ 140
704405	Standard Oven Rack for 30" Freestanding Ranges & Wall Ovens	\$ 155	\$ 180
704402	Standard Oven Rack for 36" Freestanding Ranges & Wall Ovens	\$ 175	\$ 200
704407	Standard Oven Rack for 48" Freestanding Range Small Oven	\$ 115	\$ 130
731202	Rotating Caster (w/o Brake – Not Installed) 24" – 36" units require 2 ea 48" – 60" units require 3 ea.	\$ 145 ea	\$ 165 ea
731201	Locking Caster (w/ Brake – Not Installed) 24" – 36" units require 2 ea 48" – 60" units require 3 ea.	\$ 160 ea	\$ 185 ea
723101	Standard Leg 2.5" Tall (Not Installed) 24" – 36" units require 4 ea 48" – 60" units require 6 ea.	\$ 200 ea	\$ 230 ea
723102	High Leg 5.5" Tall (Not Installed) 24" – 36" units require 4 ea 48" – 60" units require 6 ea.	\$ 220 ea	\$ 255 ea
BSPICBG12	Interchangeable Griddle Charbroiler – 4 piece	\$ 1,315	\$ 1,510
138901	Wok Ring Drop-In Cooktop Only	\$ 175	\$ 200



COOKTOPS & RANGETOPS

Get the Look: 36" Drop-In Cooktop

36" DROP-IN COOKTOP | X-8™ BURNER COOKTOPS

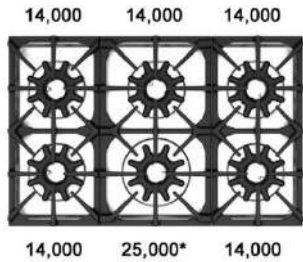
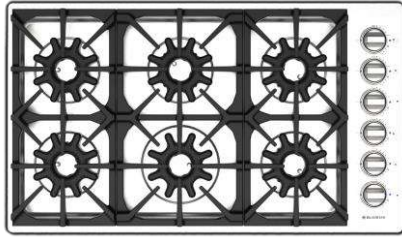

(*) 4% less output when configured for LP/Propane

Model	Description (*) Denotes item that must be specified	UMRP	MSRP
Natural Gas Models: 36" X8™ Burner Drop-In Cooktops			
BSDCTX8366B	6 Burners Nat Gas Stainless Steel Std Trim	\$ 2,745	\$ 3,155
BSDCTX8366BPLT	6 Burners Nat Gas Stainless Steel Plated Trim*	\$ 3,840	\$ 4,415
LP/Propane Models: 36" X8™ Burner Drop-In Cooktops			
BSDCTX8366BL	6 Burners LP Gas Stainless Steel Std Trim	\$ 2,745	\$ 3,155
BSDCTX8366BLPLT	6 Burners LP Gas Stainless Steel Plated Trim*	\$ 3,840	\$ 4,415
KNOB OPTIONS: (Total Knobs: 6)			
KN-C	Knob: Standard 190 RAL Color	\$ 115 ea	\$ 130 ea
KN-CF	Knob: Spec Finish (Matte RAL, Textured RAL or Prec Metals)	\$ 185 ea	\$ 215 ea
KN-PLT	Knob: Plated Trim (See options below)	\$ 250 ea	\$ 290 ea
PLATED TRIM OPTIONS: (Includes bezels and logo)			
Antique Brass, Brushed Brass, Polished Brass, Brushed Copper & Pewter			

FEATURES:

- Most powerful gas cooktop with 95,000 BTUs
- Six exclusive X-8™ sealed burners with full-spectrum power, performance, and versatility from EVERY burner
- One 25,000 BTU power burner
- Five 14,000 BTU burners
- Low 500 BTU setting on every single burner
- Professional grade cast iron grates
- Customize with 190 painted knob colors and multiple trim options
- Handcrafted in Pennsylvania since 1880

PRODUCT SPECIFICATIONS:

- Unit Dimensions: 36"W x 21"D x 4"
- Top Burner Power: 25,000 BTUs
- Low Burner Power: 500 BTUs (All Burners)
- Electrical Reqs: 120V, 60Hz, 15 AMPS
- Gas Pressure: NAT: 5.0" WC, LP 10.0" WC
- Gas Line Size: ½"

30" DROP-IN COOKTOP | X-8™ BURNER COOKTOPS

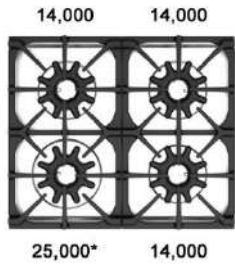
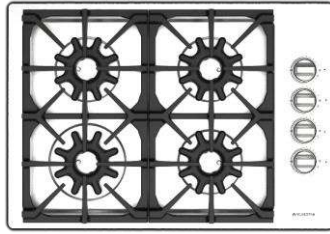

(*) 4% less output when configured for LP/Propane

Model	Description (* Denotes item that must be specified)	UMRP	MSRP
Natural Gas Models: 30" X8™ Burner Drop-In Cooktops			
BSDCTX8304B	4 Burners Nat Gas Stainless Steel Std Trim	\$ 2,195	\$ 2,525
BSDCTX8304BPLT	4 Burners Nat Gas Stainless Steel Plated Trim*	\$ 2,990	\$ 3,440
LP/Propane Models: 30" X8™ Burner Drop-In Cooktops			
BSDCTX8304BL	4 Burners LP Gas Stainless Steel Std Trim	\$ 2,195	\$ 2,525
BSDCTX8304BLPLT	4 Burners LP Gas Stainless Steel Plated Trim*	\$ 2,990	\$ 3,440
KNOB OPTIONS: (Total Knobs: 4)			
KN-C	Knob: Standard 190 RAL Color	\$ 115 ea	\$ 130 ea
KN-CF	Knob: Spec Finish (Matte RAL, Textured RAL or Prec Metals)	\$ 185 ea	\$ 215 ea
KN-PLT	Knob: Plated Trim (See options below)	\$ 250 ea	\$ 290 ea
PLATED TRIM OPTIONS: (Includes bezels and logo)			
Antique Brass, Brushed Brass, Polished Brass, Brushed Copper & Pewter			

FEATURES:

- Four exclusive X-8™ sealed burners with full-spectrum power, performance, and versatility from EVERY burner
- One 25,000 BTU power burner
- Three 14,000 BTU burners
- Low 500 BTU setting on every single burner
- Professional grade cast iron grates
- Customize with 190 painted knob colors and multiple trim options
- Handcrafted in Pennsylvania since 1880

PRODUCT SPECIFICATIONS:

- Unit Dimensions: 30"W x 21"D x 4"
- Top Burner Power: 25,000 BTUs
- Low Burner Power: 500 BTUs (All Burners)
- Electrical Reqs: 120V, 60Hz, 15 AMPS
- Gas Pressure: NAT: 5.0" WC, LP 10.0" WC
- Gas Line Size: ½"

60" PLATINUM SERIES | OPEN BURNER RANGETOPS



Simmer 15,000 18,000 15,000 18,000

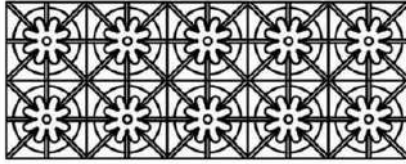

22,000 25,000 22,000 25,000 22,000

FEATURES:

- 25,000 BTU PrimaNova™ burners
- All burners, plus Interchangeable Griddle and Charbroiler accessory
- Precise 130° simmer burner
- Integrated wok cooking
- Customize with 190 color knobs and multiple trim options
- Handcrafted in Pennsylvania since 1880

PRODUCT SPECIFICATIONS:

- Unit Dimensions: 59.875"W x 24"D x 8.625"H
- Top Burner Power: 25,000 BTUs
- Simmer Burner: 9,000 BTUs
- Electrical Reqs: 120V, 60Hz, 15 AMPS, 1PH
- Gas Pressure: NAT: 5.0" WC, LP 10.0" WC
- Gas Line Size: ¾"
- Unit Weight: 410 lbs.

Model	Description (* Denotes item that must be specified)	UMRP	MSRP
Natural Gas Models: 60" Platinum Series Rangetop			
BSPRT6010B	10 Burners Nat Gas Stainless Steel Std Trim	\$ 10,895	\$ 12,530
BSPRT6010BPLT	10 Burners Nat Gas Stainless Steel Plated Trim*	\$ 12,690	\$ 14,595
LP/Propane Models: 60" Platinum Series Rangetop			
BSPRT6010BL	10 Burners LP Gas Stainless Steel Std Trim	\$ 10,895	\$ 12,530
BSPRT6010BLPLT	10 Burners LP Gas Stainless Steel Plated Trim*	\$ 12,690	\$ 14,595
BACKGUARD OPTIONS See Page 54 for Additional Customization & Accessory Options			
All BlueStar freestanding appliances must be installed with a UL approved backguard. All units ship standard with a UL approved Island Trim unless otherwise specified.			
BG660BSP	6" Backguard	\$ 1,530	\$ 1,760
BG6017BSP	17" Backguard	\$ 2,480	\$ 2,850
SDHS60BSP	24" High Shelf	\$ 2,900	\$ 3,335
KNOB OPTIONS: (Total Knobs: 10)			
KN-BLK	Standard Black Knob (<i>Must be ordered with unit</i>)	N/C	N/C
KN-C	Knob: Standard 190 RAL Color	\$ 115 ea	\$ 130 ea
KN-CF	Knob: Spec Finish (Matte RAL, Textured RAL or Prec Metals)	\$ 185 ea	\$ 215 ea
KN-PLT	Knob: Plated Trim (See options below)	\$ 250 ea	\$ 290 ea
PLATED TRIM OPTIONS: (Includes bezels and logo)			
Antique Brass, Brushed Brass, Polished Brass, Brushed Copper & Pewter			

48" PLATINUM SERIES | OPEN BURNER RANGETOPS



Simmer 15,000 15,000 18,000

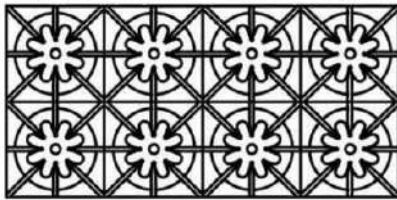

22,000 25,000 25,000 22,000

FEATURES:

- 25,000 BTU PrimaNova™ burners
- All burners, plus Interchangeable Griddle and Charbroiler accessory
- Precise 130° simmer burner
- Integrated wok cooking
- Customize with 190 color knobs and multiple trim options
- Handcrafted in Pennsylvania since 1880

PRODUCT SPECIFICATIONS:

- Unit Dimensions: 47.875"W x 24"D x 8.625"H
- Top Burner Power: 25,000 BTUs
- Simmer Burner: 9,000 BTUs
- Electrical Reqs: 120V, 60Hz, 15 AMPS, 1PH
- Gas Pressure: NAT: 5.0" WC, LP 10.0" WC
- Gas Line Size: ¾"
- Unit Weight: 345 lbs.

Model	Description (* Denotes item that must be specified)	UMRP	MSRP
Natural Gas Models: 48" Platinum Series Rangetop			
BSPRT488B	8 Burners Nat Gas Stainless Steel Std Trim	\$ 7,595	\$ 8,735
BSPRT488BPLT	8 Burners Nat Gas Stainless Steel Plated Trim*	\$ 9,090	\$ 10,455
LP/Propane Models: 48" Platinum Series Rangetop,			
BSPRT488BL	8 Burners LP Gas Stainless Steel Std Trim	\$ 7,595	\$ 8,735
BSPRT488BLPLT	8 Burners LP Gas Stainless Steel Plated Trim*	\$ 9,090	\$ 10,455
BACKGUARD OPTIONS See Page 54 for Additional Customization & Accessory Options			
All BlueStar freestanding appliances must be installed with a UL approved backguard. All units ship standard with a UL approved Island Trim unless otherwise specified.			
BG648BSP	6" Backguard	\$ 1,040	\$ 1,195
BG4817BSP	17" Backguard	\$ 2,180	\$ 2,505
SDHS48BSP	24" High Shelf	\$ 2,340	\$ 2,690
KNOB OPTIONS: (Total Knobs: 8)			
KN-BLK	Standard Black Knob (<i>Must be ordered with unit</i>)	N/C	N/C
KN-C	Knob: Standard 190 RAL Color	\$ 115 ea	\$ 130 ea
KN-CF	Knob: Spec Finish (Matte RAL, Textured RAL or Prec Metals)	\$ 185 ea	\$ 215 ea
KN-PLT	Knob: Plated Trim (See options below)	\$ 250 ea	\$ 290 ea
PLATED TRIM OPTIONS: (Includes bezels and logo)			
Antique Brass, Brushed Brass, Polished Brass, Brushed Copper & Pewter			

36" PLATINUM SERIES | OPEN BURNER RANGETOPS

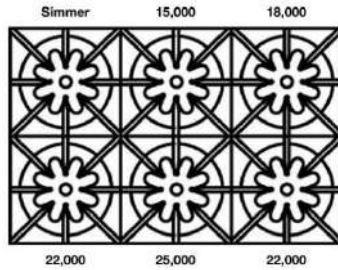

FEATURES:

- 25,000 BTU PrimaNova™ burners
- All burners, plus Interchangeable Griddle and Charbroiler accessory
- Precise 130° simmer burner
- Integrated wok cooking
- Customize with 190 color knobs and multiple trim options
- Handcrafted in Pennsylvania since 1880

PRODUCT SPECIFICATIONS:

- Unit Dimensions: 35.875"W x 24"D x 8.625"H
- Top Burner Power: 25,000 BTUs
- Simmer Burner: 9,000 BTUs
- Electrical Reqs: 120V, 60Hz, 15 AMPS, 1PH
- Gas Pressure: NAT: 5.0" WC, LP 10.0" WC
- Gas Line Size: ½"
- Unit Weight: 285 lbs.

Model	Description (* Denotes item that must be specified)	UMRP	MSRP
Natural Gas Models: 36" Platinum Series Rangetop			
BSPRT366B	6 Burners Nat Gas Stainless Steel Std Trim	\$ 6,395	\$ 7,355
BSPRT366BPLT	6 Burners Nat Gas Stainless Steel Plated Trim*	\$ 7,490	\$ 8,615
LP/Propane Models: 36" Platinum Series Rangetop			
BSPRT366BL	6 Burners LP Gas Stainless Steel Std Trim	\$ 6,395	\$ 7,355
BSPRT366BLPLT	6 Burners LP Gas Stainless Steel Plated Trim*	\$ 7,490	\$ 8,615
BACKGUARD OPTIONS See Page 54 for Additional Customization & Accessory Options			
All BlueStar freestanding appliances must be installed with a UL approved backguard. All units ship standard with a UL approved Island Trim unless otherwise specified.			
BG636BSP	6" Backguard	\$ 720	\$ 830
BG3617BSP	17" Backguard	\$ 1,460	\$ 1,680
SDHS36BSP	24" High Shelf	\$ 1,690	\$ 1,945
KNOB OPTIONS: (Total Knobs: 6)			
KN-BLK	Standard Black Knob (<i>Must be ordered with unit</i>)	N/C	N/C
KN-C	Knob: Standard 190 RAL Color	\$ 115 ea	\$ 130 ea
KN-CF	Knob: Spec Finish (Matte RAL, Textured RAL or Prec Metals)	\$ 185 ea	\$ 215 ea
KN-PLT	Knob: Plated Trim (See options below)	\$ 250 ea	\$ 290 ea
PLATED TRIM OPTIONS: (Includes bezels and logo)			
Antique Brass, Brushed Brass, Polished Brass, Brushed Copper & Pewter			

30" PLATINUM SERIES | OPEN BURNER RANGETOPS

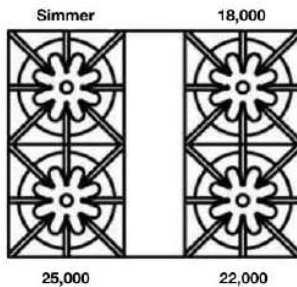

FEATURES:

- 25,000 BTU PrimaNova™ burners
- All burners, plus Interchangeable Griddle and Charbroiler accessory
- Precise 130° simmer burner
- Integrated wok cooking
- Customize with 190 color knobs and multiple trim options
- Handcrafted in Pennsylvania since 1880

PRODUCT SPECIFICATIONS:

- Unit Dimensions: 29.875"W x 24"D x 8.625"H
- Top Burner Power: 25,000 BTUs
- Simmer Burner: 9,000 BTUs
- Electrical Reqs: 120V, 60Hz, 15 AMPS, 1PH
- Gas Pressure: NAT: 5.0" WC, LP 10.0" WC
- Gas Line Size: ½"
- Unit Weight: 235 lbs.

Model	Description (* Denotes item that must be specified)	UMRP	MSRP
Natural Gas Models: 30" Platinum Series Rangetop			
BSPRT304B	4 Burners Nat Gas Stainless Steel Std Trim	\$ 5,795	\$ 6,665
BSPRT304BPLT	4 Burners Nat Gas Stainless Steel Plated Trim*	\$ 6,590	\$ 7,580
LP/Propane Models: 30" Platinum Series Rangetop			
BSPRT304BL	4 Burners LP Gas Stainless Steel Std Trim	\$ 5,795	\$ 6,665
BSPRT304BLPLT	4 Burners LP Gas Stainless Steel Plated Trim*	\$ 6,590	\$ 7,580
BACKGUARD OPTIONS See Page 54 for Additional Customization & Accessory Options			
All BlueStar freestanding appliances must be installed with a UL approved backguard. All units ship standard with a UL approved Island Trim unless otherwise specified.			
BG630BSP	6" Backguard	\$ 605	\$ 695
BG3017BSP	17" Backguard	\$ 1,120	\$ 1,290
SDHS30BSP	24" High Shelf	\$ 1,460	\$ 1,680
KNOB OPTIONS: (Total Knobs: 4)			
KN-BLK	Standard Black Knob (<i>Must be ordered with unit</i>)	N/C	N/C
KN-C	Knob: Standard 190 RAL Color	\$ 115 ea	\$ 130 ea
KN-CF	Knob: Spec Finish (Matte RAL, Textured RAL or Prec Metals)	\$ 185 ea	\$ 215 ea
KN-PLT	Knob: Plated Trim (See options below)	\$ 250 ea	\$ 290 ea
PLATED TRIM OPTIONS: (Includes bezels and logo)			
Antique Brass, Brushed Brass, Polished Brass, Brushed Copper & Pewter			

24" PLATINUM SERIES | OPEN BURNER RANGETOPS

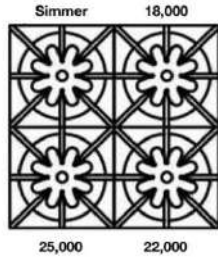

FEATURES:

- 25,000 BTU PrimaNova™ burners
- All burners, plus Interchangeable Griddle and Charbroiler accessory
- Precise 130° simmer burner
- Integrated wok cooking
- Customize with 190 color knobs and multiple trim options
- Handcrafted in Pennsylvania since 1880

PRODUCT SPECIFICATIONS:

- Unit Dimensions: 23.875"W x 24"D x 8.625"H
- Top Burner Power: 25,000 BTUs
- Simmer Burner: 9,000 BTUs
- Electrical Reqs: 120V, 60Hz, 15 AMPS, 1PH
- Gas Pressure: NAT: 5.0" WC, LP 10.0" WC
- Gas Line Size: ½"
- Unit Weight: 220 lbs.

Model	Description (* Denotes item that must be specified)	UMRP	MSRP
Natural Gas Models: 24" Platinum Series Rangetop			
BSPRT244B	4 Burners Nat Gas Stainless Steel Std Trim	\$ 5,495	\$ 6,320
BSPRT244BPLT	4 Burners Nat Gas Stainless Steel Plated Trim*	\$ 6,290	\$ 7,235
LP/Propane Models: 24" Platinum Series Rangetop			
BSPRT244BL	4 Burners LP Gas Stainless Steel Std Trim	\$ 5,495	\$ 6,320
BSPRT244BLPLT	4 Burners LP Gas Stainless Steel Plated Trim*	\$ 6,290	\$ 7,235
BACKGUARD OPTIONS See Page 54 for Additional Customization & Accessory Options			
All BlueStar freestanding appliances must be installed with a UL approved backguard. All units ship standard with a UL approved Island Trim unless otherwise specified.			
BG624BSP	6" Backguard	\$ 605	\$ 695
BG2417BSP	17" Backguard	\$ 1,120	\$ 1,290
SDHS24BSP	24" High Shelf	\$ 1,460	\$ 1,680
KNOB OPTIONS: (Total Knobs: 4)			
KN-BLK	Standard Black Knob (<i>Must be ordered with unit</i>)	N/C	N/C
KN-C	Knob: Standard 190 RAL Color	\$ 115 ea	\$ 130 ea
KN-CF	Knob: Spec Finish (Matte RAL, Textured RAL or Prec Metals)	\$ 185 ea	\$ 215 ea
KN-PLT	Knob: Plated Trim (See options below)	\$ 250 ea	\$ 290 ea
PLATED TRIM OPTIONS: (Includes bezels and logo)			
Antique Brass, Brushed Brass, Polished Brass, Brushed Copper & Pewter			

36" INDUCTION SERIES | INDUCTION COOKTOP



FEATURES:

- Features a searing 5,500 Watt burner
- Rapid "Heat Accelerator" technology for no-wait cooking, heats 50% faster than gas
- Exceptional temperature control with 12 cooking settings
- Maximum cooking surface fits up to 5 pots or pans
- Seamless 2-burner bridging technology, perfect for grilling or searing
- Gentle simmer capabilities, down to 200 degrees
- Perfect "Keep Warm" (150 degrees) feature for entertaining ease
- Intuitive design with sleek push-to-turn knobs and easy-to-clean, scratch resistant, non-staining glass top
- Safety knob lock feature & no-touch hot surface indicator light
- Customize with 190 color knobs and multiple trim options

PRODUCT SPECIFICATIONS:

- Unit Dims: 36 1/16"W x 21 1/8"D x 3 7/8"H
- 31/64" from counter to top of glass
- Electrical: 230V, 50 amp, 50/60Hz
- Connection: 2 Phases
- Diameter: 3 x 10 AWG (Provided)

Model	Description (* Denotes item that must be specified)	UMRP	MSRP
36" Induction Cooktop			
BSP36INDCKT	5 Burner Induction Std Trim	\$ 4,395	\$ 5,055
BSP36INDCKTPLT	5 Burner Induction Plated Trim*	\$ 5,490	\$ 6,315
KNOB OPTIONS: (Total Knobs: 5)			
KN-C	Knob: Standard 190 RAL Color	\$ 115 ea	\$ 130 ea
KN-CF	Knob: Spec Finish (Matte RAL, Textured RAL or Prec Metals)	\$ 185 ea	\$ 215 ea
KN-PLT	Knob: Plated Trim (See options below)	\$ 250 ea	\$ 290 ea
PLATED TRIM OPTIONS: (Includes bezels and logo)			
Antique Brass, Brushed Brass, Polished Brass, Brushed Copper & Pewter			

60" NOVA (RGTNB) SERIES | OPEN BURNER RANGETOPS



Simmer 15,000 15,000 15,000 15,000

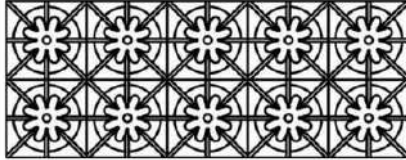

22,000 15,000 15,000 15,000 22,000

FEATURES:

- 22,000 BTU UltraNova™ burners & 15,000 BTU Nova™ burners
- Precise 130° simmer burner
- Available with all burners or add integrated griddle, charbroiler or French top
- Integrated wok cooking
- Customize with 190 color knobs and multiple trim options
- Handcrafted in Pennsylvania since 1880

PRODUCT SPECIFICATIONS:

- Unit Dimensions: 59.875"W x 24"D x 8.625"H
- Top Burner Power: 22,000 BTUs
- Simmer Burner: 9,000 BTUs
- Electrical Reqs: 120V, 60Hz, 15 AMPS, 1PH
- Gas Pressure: NAT: 5.0" WC, LP 10.0" WC
- Gas Line Size: 3/4"
- Unit Weight: 330 lbs.

Model	Description (* Denotes item that must be specified)	UMRP	MSRP
Natural Gas Models: 60" Nova Series Rangetop			
RGTNB6010BV2	10 Burners Nat Gas Stainless Steel Std Trim	\$ 10,195	\$ 11,725
RGTNB6010BV2PLT	10 Burners Nat Gas Stainless Steel Plated Trim*	\$ 11,990	\$ 13,790
LP/Propane Models: 60" Nova Series Rangetop			
RGTNB6010BV2L	10 Burners LP Gas Stainless Steel Std Trim	\$ 10,195	\$ 11,725
RGTNB6010BV2LPLT	10 Burners LP Gas Stainless Steel Plated Trim*	\$ 11,990	\$ 13,790
BACKGUARD OPTIONS See Page 54 for Additional Customization & Accessory Options			
All BlueStar freestanding appliances must be installed with a UL approved backguard. All units ship standard with a UL approved Island Trim unless otherwise specified.			
BG660BSP	6" Backguard	\$ 1,530	\$ 1,760
BG6017BSP	17" Backguard	\$ 2,480	\$ 2,850
SDHS60BSP	24" High Shelf	\$ 2,900	\$ 3,335
KNOB OPTIONS: (Total Knobs: 10)			
KN-BLK	Standard Black Knob (Must be ordered with unit)	N/C	N/C
KN-C	Knob: Standard 190 RAL Color	\$ 115 ea	\$ 130 ea
KN-CF	Knob: Spec Finish (Matte RAL, Textured RAL or Prec Metals)	\$ 185 ea	\$ 215 ea
KN-PLT	Knob: Plated Trim (See options below)	\$ 250 ea	\$ 290 ea
PLATED TRIM OPTIONS: (Includes bezels and logo)			
Antique Brass, Brushed Brass, Polished Brass, Brushed Copper & Pewter			

60" Nova (RNB) Rangetop with 12" Griddle



Simmer 15,000 15,000 15,000

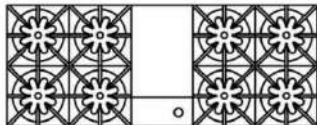

22,000 15,000 15,000 15,000 22,000

Model	Description (* - Denotes item that must be specified)	UMRP	MSRP
Natural Gas Models: 60" Nova Series Rangetop			
RGTNB608GV2	8 Burner 12" Griddle Nat Gas Stainless Steel Standard Trim	\$ 9,985	\$ 11,380
RGTNB608GV2PLT	8 Burner 12" Griddle Nat Gas Stainless Steel Plated Trim*	\$ 11,690	\$ 13,445
LP/Propane Models: 60" Nova Series Rangetop			
RGTNB608GV2L	8 Burner 12" Griddle LP Gas Stainless Steel Standard Trim	\$ 9,985	\$ 11,380
RGTNB608GV2LPLT	8 Burner 12" Griddle LP Gas Stainless Steel Plated Trim*	\$ 11,690	\$ 13,445
Customization & Accessory Options: (See page 54) Total Knobs: 9			

60" Nova (RNB) Rangetop with 12" Charbroiler



Simmer 15,000 15,000 15,000

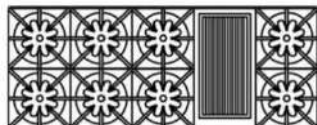

22,000 15,000 15,000 15,000 22,000

Model	Description (* - Denotes item that must be specified)	UMRP	MSRP
Natural Gas Models: 60" Nova Series Rangetop with 12" Charbroiler			
RGTNB608CBV2	8 Burner 12" Charbroiler Nat Gas Stainless Steel Standard Trim	\$ 9,985	\$ 11,380
RGTNB608CBV2PLT	8 Burner 12" Charbroiler Nat Gas Stainless Steel Plated Trim*	\$ 11,690	\$ 13,445
LP/Propane Models: 60" Nova Series Rangetop with 12" Charbroiler			
RGTNB608CBV2L	8 Burner 12" Charbroiler LP Gas Stainless Steel Standard Trim	\$ 9,985	\$ 11,380
RGTNB608CBV2LPLT	8 Burner 12" Charbroiler LP Gas Stainless Steel Plated Trim*	\$ 11,690	\$ 13,445
Customization & Accessory Options: (See page 54) Total Knobs: 9			

60" NOVA (RGTNB) SERIES | OPEN BURNER RANGETOPS

**60" Nova (RNB) Rangetop
with 24" Griddle**

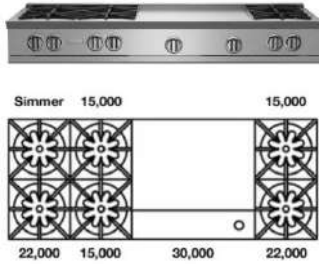

Model	Description (* - Denotes item that must be specified)	UMRP	MSRP
Natural Gas Models: 60" Nova Series Rangetop with 24" Griddle			
RGTNB606GV2	6 Burner 24" Griddle Nat Gas Stainless Steel Standard Trim	\$ 10,195	\$ 11,725
RGTNB606GV2PLT	6 Burner 24" Griddle Nat Gas Stainless Steel Plated Trim*	\$ 11,990	\$ 13,790
LP/Propane Models: 60" Nova Series Rangetop with 24" Griddle			
RGTNB606GV2L	6 Burner 24" Griddle LP Gas Stainless Steel Standard Trim	\$ 10,195	\$ 11,725
RGTNB606GV2LPLT	6 Burner 24" Griddle LP Gas Stainless Steel Plated Trim*	\$ 11,990	\$ 13,790
Customization & Accessory Options: (See page 54) Total Knobs: 8			

**60" Nova (RNB) Rangetop
with 24" Charbroiler**

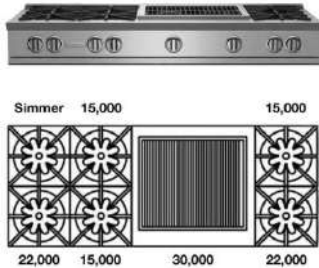

Model	Description (* - Denotes item that must be specified)	UMRP	MSRP
Natural Gas Models: 60" Nova Series Rangetop with 24" Charbroiler			
RGTNB606CBV2	6 Burner 24" Charbroiler Nat Gas Stainless Steel Standard Trim	\$ 10,195	\$ 11,725
RGTNB606CBV2PLT	6 Burner 24" Charbroiler Nat Gas Stainless Steel Plated Trim*	\$ 11,990	\$ 13,790
Natural Gas Models: 60" Nova Series Rangetop with 24" Charbroiler			
RGTNB606CBV2L	6 Burner 24" Charbroiler LP Gas Stainless Steel Standard Trim	\$ 10,195	\$ 11,725
RGTNB606CBV2LPLT	6 Burner 24" Charbroiler LP Gas Stainless Steel Plated Trim*	\$ 11,990	\$ 13,790
Customization & Accessory Options: (See page 54) Total Knobs: 8			

**60" Nova (RNB) Rangetop
with 12" Griddle & Charbroiler**

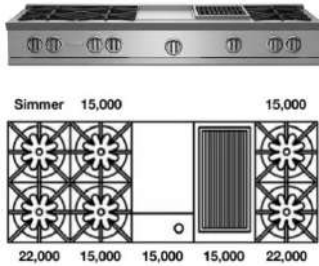

Model	Description (* - Denotes item that must be specified)	UMRP	MSRP
Natural Gas Models: 60" Nova Series Rangetop with 12" Griddle & Charbroiler			
RGTNB4606GCBV2	6 Burner 12" Griddle & Char Br. Nat Gas Stainless Steel Standard Trim	\$ 10,695	\$ 12,300
RGTNB606GCBV2PLT	6 Burner 12" Griddle & Char Br. Nat Gas Stainless Steel Plated Trim*	\$ 12,490	\$ 14,365
LP/Propane Models: 60" Nova Series Rangetop with 12" Griddle & Charbroiler			
RGTNB606GCBV2L	6 Burner 24" Griddle LP Gas Stainless Steel Standard Trim	\$ 10,195	\$ 11,725
RGTNB606GCBV2LPLT	6 Burner 24" Griddle LP Gas Stainless Steel Plated Trim*	\$ 11,990	\$ 13,790
Customization & Accessory Options: (See page 54) Total Knobs: 8			

**60" Nova (RNB) Rangetop
with 24" French Top**

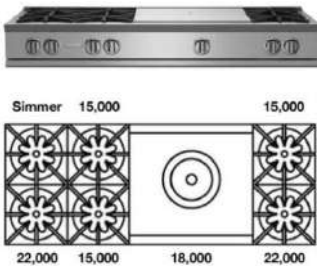

Model	Description (* - Denotes item that must be specified)	UMRP	MSRP
Natural Gas Models: 60" Nova Series Rangetop with 24" French Top			
RGTNB606FTV2	6 Burner 24" French Top Nat Gas Stainless Steel Standard Trim	\$ 10,995	\$ 12,645
RGTNB606FTV2PLT	6 Burner 24" French Top Nat Gas Stainless Steel Plated Trim*	\$ 12,790	\$ 14,710
LP/Propane Models: 60" Nova Series Rangetop with 24" French Top			
RGTNB606FTV2L	6 Burner 24" French Top LP Gas Stainless Steel Standard Trim	\$ 10,995	\$ 12,645
RGTNB606FTV2LPLT	6 Burner 24" French Top LP Gas Stainless Steel Plated Trim*	\$ 12,790	\$ 14,710
Customization & Accessory Options: (See page 54) Total Knobs: 7			

48" NOVA (RGTNB) SERIES | OPEN BURNER RANGETOPS

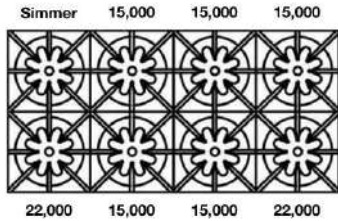

FEATURES:

- 22,000 BTU UltraNova™ burners & 15,000 BTU Nova™ burners
- Precise 130° simmer burner
- Available with all burners or add integrated griddle, charbroiler or French top
- Integrated wok cooking
- Customize with 190 color knobs and multiple trim options
- Handcrafted in Pennsylvania since 1880

PRODUCT SPECIFICATIONS:

- Unit Dimensions: 47.875"W x 24"D x 8.625"H
- Top Burner Power: 22,000 BTUs
- Simmer Burner: 9,000 BTUs
- Electrical Reqs: 120V, 60Hz, 15 AMPS, 1PH
- Gas Pressure: NAT: 5.0" WC, LP 10.0" WC
- Gas Line Size: 3/4"
- Unit Weight: 295 lbs.

Model	Description (* Denotes item that must be specified)	UMRP	MSRP
Natural Gas Models: 48" Nova Series Rangetop			
RGTNB488BV2	8 Burners Nat Gas Stainless Steel Std Trim	\$ 6,395	\$ 7,355
RGTNB488BV2PLT	8 Burners Nat Gas Stainless Steel Plated Trim*	\$ 7,890	\$ 9,075
LP/Propane Models: 48" Nova Series Rangetop			
RGTNB488BV2L	8 Burners LP Gas Stainless Steel Std Trim	\$ 6,395	\$ 7,355
RGTNB488BV2LPLT	8 Burners LP Gas Stainless Steel Plated Trim*	\$ 7,890	\$ 9,075
BACKGUARD OPTIONS See Page 54 for Additional Customization & Accessory Options			
All BlueStar freestanding appliances must be installed with a UL approved backguard. All units ship standard with a UL approved Island Trim unless otherwise specified.			
BG648BSP	6" Backguard	\$ 1,040	\$ 1,195
BG4817BSP	17" Backguard	\$ 2,180	\$ 2,505
SDHS48BSP	24" High Shelf	\$ 2,340	\$ 2,690
KNOB OPTIONS: (Total Knobs: 8)			
KN-BLK	Standard Black Knob (<i>Must be ordered with unit</i>)	N/C	N/C
KN-C	Knob: Standard 190 RAL Color	\$ 115 ea	\$ 130 ea
KN-CF	Knob: Spec Finish (Matte RAL, Textured RAL or Prec Metals)	\$ 185 ea	\$ 215 ea
KN-PLT	Knob: Plated Trim (See options below)	\$ 250 ea	\$ 290 ea
PLATED TRIM OPTIONS: (Includes bezels and logo)			
Antique Brass, Brushed Brass, Polished Brass, Brushed Copper & Pewter			

48" Nova (RNB) Rangetop with 12" Griddle

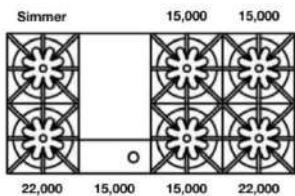

Model	Description (* - Denotes item that must be specified)	UMRP	MSRP
Natural Gas Models: 48" Nova Series Rangetop with 12" Griddle			
RGTNB486GV2	6 Burner 12" Griddle Nat Gas Stainless Steel Standard Trim	\$ 6,595	\$ 7,585
RGTNB486GV2PLT	6 Burner 12" Griddle Nat Gas Stainless Steel Plated Trim*	\$ 8,090	\$ 9,305
LP/Propane Models: 48" Nova Series Rangetop with 12" Griddle			
RGTNB486GV2L	6 Burner 12" Griddle LP Gas Stainless Steel Standard Trim	\$ 6,595	\$ 7,585
RGTNB486GV2LPLT	6 Burner 12" Griddle LP Gas Stainless Steel Plated Trim*	\$ 8,090	\$ 9,305
Customization & Accessory Options: (See page 54) Total Knobs: 7			

48" Nova (RNB) Rangetop with 12" Charbroiler

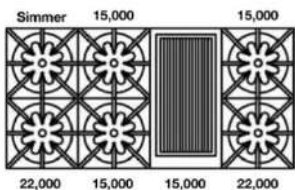

Model	Description (* - Denotes item that must be specified)	UMRP	MSRP
Natural Gas Models: 48" Nova Series Rangetop with 12" Charbroiler			
RGTNB486CBV2	6 Burner 12" Charbroiler Nat Gas Stainless Steel Standard Trim	\$ 6,595	\$ 7,585
RGTNB486CBV2PLT	6 Burner 12" Charbroiler Nat Gas Stainless Steel Plated Trim*	\$ 8,090	\$ 9,305
LP/Propane Models: 48" Nova Series Rangetop with 12" Charbroiler			
RGTNB486CBV2L	6 Burner 12" Charbroiler LP Gas Stainless Steel Standard Trim	\$ 6,595	\$ 7,585
RGTNB486CBV2LPLT	6 Burner 12" Charbroiler LP Gas Stainless Steel Plated Trim*	\$ 8,090	\$ 9,305
Customization & Accessory Options: (See page 54) Total Knobs: 7			

48" NOVA (RGTNB) SERIES | OPEN BURNER RANGETOPS

48" Nova (RNB) Rangetop
with 24" Griddle

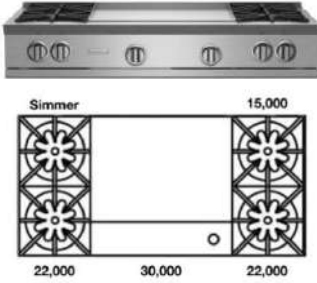

Model	Description (* - Denotes item that must be specified)	UMRP	MSRP
Natural Gas Models: 48" Nova Series Rangetop with 24" Griddle			
RGTNB484GV2	6 Burner 24" Griddle Nat Gas Stainless Steel Standard Trim	\$ 7,195	\$ 8,275
RGTNB484GV2PLT	6 Burner 24" Griddle Nat Gas Stainless Steel Plated Trim*	\$ 8,690	\$ 9,995
LP/Propane Models: 48" Nova Series Rangetop with 24" Griddle			
RGTNB484GV2L	6 Burner 24" Griddle LP Gas Stainless Steel Standard Trim	\$ 7,195	\$ 8,275
RGTNB484GV2LPLT	6 Burner 24" Griddle LP Gas Stainless Steel Plated Trim*	\$ 8,690	\$ 9,995
Customization & Accessory Options: (See page 54) Total Knobs: 6			

48" Nova (RNB) Rangetop
with 24" Charbroiler

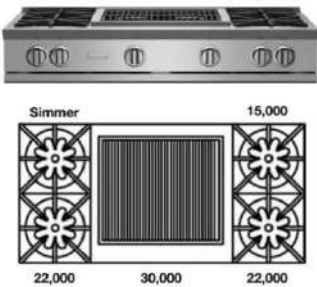

Model	Description (* - Denotes item that must be specified)	UMRP	MSRP
Natural Gas Models: 48" Nova Series Rangetop with 24" Charbroiler			
RGTNB484CBV2	4 Burner 24" Charbroiler Nat Gas Stainless Steel Standard Trim	\$ 7,195	\$ 8,275
RGTNB484CBV2PLT	4 Burner 24" Charbroiler Nat Gas Stainless Steel Plated Trim*	\$ 8,690	\$ 9,995
LP/Propane Models: 48" Nova Series Rangetop with 24" Charbroiler			
RGTNB484CBV2L	4 Burner 24" Charbroiler LP Gas Stainless Steel Standard Trim	\$ 7,195	\$ 8,275
RGTNB484CBV2LPLT	4 Burner 24" Charbroiler LP Gas Stainless Steel Plated Trim*	\$ 8,690	\$ 9,995
Customization & Accessory Options: (See page 54) Total Knobs: 6			

48" Nova (RNB) Rangetop
with 12" Griddle & Charbroiler

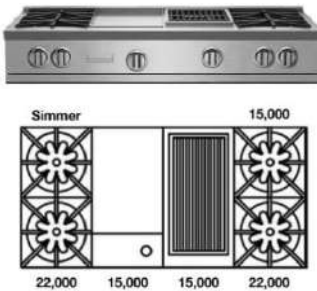

Model	Description (* - Denotes item that must be specified)	UMRP	MSRP
Natural Gas Models: 48" Nova Series Rangetop with 12" Griddle & Charbroiler			
RGTNB484GCBV2	4 Burner 12" Griddle & Char Br. Nat Gas Stainless Steel Standard Trim	\$ 7,395	\$ 8,505
RGTNB484GCBV2PLT	4 Burner 12" Griddle & Char Br. Nat Gas Stainless Steel Plated Trim*	\$ 8,890	\$ 10,225
LP/Propane Models: 48" Nova Series Rangetop with 12" Griddle & Charbroiler			
RGTNB484GCBV2L	4 Burner 12" Griddle & Char Br. LP Gas Stainless Steel Standard Trim	\$ 7,395	\$ 8,505
RGTNB484GCBV2LPLT	4 Burner 12" Griddle & Char Br. LP Gas Stainless Steel Plated Trim*	\$ 8,890	\$ 10,225
Customization & Accessory Options: (See page 54) Total Knobs: 6			

48" Nova (RNB) Rangetop
with 24" French Top

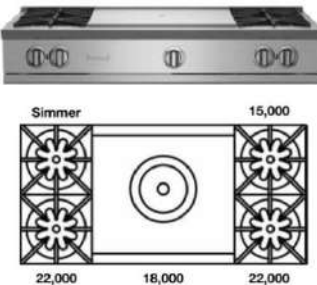

Model	Description (* - Denotes item that must be specified)	UMRP	MSRP
Natural Gas Models: 48" Nova Series Rangetop with 24" French Top			
RGTNB484FTBV2	4 Burner 24" French Top Nat Gas Stainless Steel Standard Trim	\$ 7,925	\$ 9,115
RGTNB484FTBV2PLT	4 Burner 24" French Top Nat Gas Stainless Steel Plated Trim*	\$ 9,420	\$ 10,835
LP/Propane Models: 48" Nova Series Rangetop with 24" French Top			
RGTNB484FTBV2L	4 Burner 24" French Top LP Gas Stainless Steel Standard Trim	\$ 7,925	\$ 9,115
RGTNB484FTBV2LPLT	4 Burner 24" French Top LP Gas Stainless Steel Plated Trim*	\$ 9,420	\$ 10,835
Customization & Accessory Options: (See page 54) Total Knobs: 5			

36" NOVA (RGTNB) SERIES | OPEN BURNER RANGETOPS

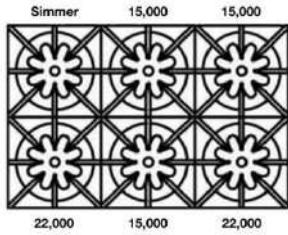

FEATURES:

- 22,000 BTU UltraNova™ burners & 15,000 BTU Nova™ burners
- Precise 130° simmer burner
- Available with all burners or add integrated griddle, charbroiler or French top
- Integrated wok cooking
- Customize with 190 color knobs and multiple trim options
- Handcrafted in Pennsylvania since 1880

PRODUCT SPECIFICATIONS:

- Unit Dimensions: 35.875"W x 24"D x 8.625"H
- Top Burner Power: 22,000 BTUs
- Simmer Burner: 9,000 BTUs
- Electrical Req's: 120V, 60Hz, 15 AMPS, 1PH
- Gas Pressure: NAT: 5.0" WC, LP 10.0" WC
- Gas Line Size: 1/2"
- Unit Weight: 220 lbs.

Model	Description (* Denotes item that must be specified)	UMRP	MSRP
Natural Gas Models: 36" Nova Series Rangetop			
RGTNB366BV2	6 Burners Nat Gas Stainless Steel Std Trim	\$ 5,095	\$ 5,860
RGTNB366BV2PLT	6 Burners Nat Gas Stainless Steel Plated Trim*	\$ 6,190	\$ 7,120
LP/Propane Models: 36" Nova Series Rangetop			
RGTNB366BV2L	6 Burners LP Gas Stainless Steel Std Trim	\$ 5,095	\$ 5,860
RGTNB366BV2LPLT	6 Burners LP Gas Stainless Steel Plated Trim*	\$ 6,190	\$ 7,120
BACKGUARD OPTIONS See Page 54 for Additional Customization & Accessory Options			
All BlueStar freestanding appliances must be installed with a UL approved backguard. All units ship standard with a UL approved Island Trim unless otherwise specified.			
BG636BSP	6" Backguard	\$ 720	\$ 830
BG3617BSP	17" Backguard	\$ 1,460	\$ 1,680
SDHS36BSP	24" High Shelf	\$ 1,690	\$ 1,945
KNOB OPTIONS: (Total Knobs: 6)			
KN-BLK	Standard Black Knob (<i>Must be ordered with unit</i>)	N/C	N/C
KN-C	Knob: Standard 190 RAL Color	\$ 115 ea	\$ 130 ea
KN-CF	Knob: Spec Finish (Matte RAL, Textured RAL or Prec Metals)	\$ 185 ea	\$ 215 ea
KN-PLT	Knob: Plated Trim (See options below)	\$ 250 ea	\$ 290 ea
PLATED TRIM OPTIONS: (Includes bezels and logo)			
Antique Brass, Brushed Brass, Polished Brass, Brushed Copper & Pewter			

36" Nova (RNB) Rangetop with 12" Griddle

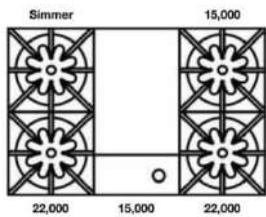

Model	Description (* - Denotes item that must be specified)	UMRP	MSRP
Natural Gas Models: 36" Nova Series Rangetop with 12" Griddle			
RGTNB364GV2	4 Burner 12" Griddle Nat Gas Stainless Steel Standard Trim	\$ 5,795	\$ 6,665
RGTNB364GV2PLT	4 Burner 12" Griddle Nat Gas Stainless Steel Plated Trim*	\$ 6,890	\$ 7,925
LP/Propane Models: 36" Nova Series Rangetop with 12" Griddle			
RGTNB364GV2L	4 Burner 12" Griddle LP Gas Stainless Steel Standard Trim	\$ 5,795	\$ 6,665
RGTNB364GV2LPLT	4 Burner 12" Griddle LP Gas Stainless Steel Plated Trim*	\$ 6,890	\$ 7,925
Customization & Accessory Options: (See page 54) Total Knobs: 5			

36" Nova (RNB) Rangetop with 12" Charbroiler

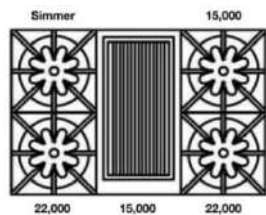

Model	Description (* - Denotes item that must be specified)	UMRP	MSRP
Natural Gas Models: 36" Nova Series Rangetop with 12" Charbroiler			
RGTNB364CBV2	4 Burner 12" Charbroiler Nat Gas Stainless Steel Standard Trim	\$ 5,495	\$ 6,320
RGTNB364CBV2PLT	4 Burner 12" Charbroiler Nat Gas Stainless Steel Plated Trim*	\$ 6,590	\$ 7,580
LP/Propane Models: 36" Nova Series Rangetop with 12" Charbroiler			
RGTNB364CBV2L	4 Burner 12" Charbroiler LP Gas Stainless Steel Standard Trim	\$ 5,495	\$ 6,320
RGTNB364CBV2LPLT	4 Burner 12" Charbroiler LP Gas Stainless Steel Plated Trim*	\$ 6,590	\$ 7,580
Customization & Accessory Options: (See page 54) Total Knobs: 5			

30" NOVA (RGTNB) SERIES | OPEN BURNER RANGETOPS

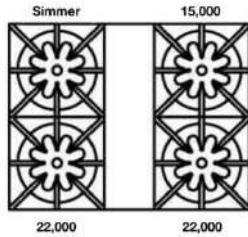

FEATURES:

- 22,000 BTU UltraNova™ burners & 15,000 BTU Nova™ burners
- Precise 130° simmer burner
- Integrated wok cooking
- Customize with 190 color knobs and multiple trim options
- Handcrafted in Pennsylvania since 1880

PRODUCT SPECIFICATIONS:

- Unit Dimensions: 29.875"W x 24"D x 8.625"H
- Top Burner Power: 22,000 BTUs
- Simmer Burner: 9,000 BTUs
- Electrical Reqs: 120V, 60Hz, 15 AMPS, 1PH
- Gas Pressure: NAT: 5.0" WC, LP 10.0" WC
- Gas Line Size: 1/2"
- Unit Weight: 200 lbs.

Model	Description (* Denotes item that must be specified)	UMRP	MSRP
Natural Gas Models: 30" Nova Series Rangetop			
RGTNB304BV2	4 Burners Nat Gas Stainless Steel Std Trim	\$ 4,795	\$ 5,515
RGTNB304BV2PLT	4 Burners Nat Gas Stainless Steel Plated Trim*	\$ 5,590	\$ 6,430
LP/Propane Models: 30" Nova Series Rangetop			
RGTNB304BV2L	4 Burners LP Gas Stainless Steel Std Trim	\$ 4,795	\$ 5,515
RGTNB304BV2LPLT	4 Burners LP Gas Stainless Steel Plated Trim*	\$ 5,590	\$ 6,430
BACKGUARD OPTIONS See Page 54 for Additional Customization & Accessory Options			
All BlueStar freestanding appliances must be installed with a UL approved backguard. All units ship standard with a UL approved Island Trim unless otherwise specified.			
BG630BSP	6" Backguard	\$ 605	\$ 695
BG3017BSP	17" Backguard	\$ 1,120	\$ 1,290
SDHS30BSP	24" High Shelf	\$ 1,460	\$ 1,680
KNOB OPTIONS: (Total Knobs: 4)			
KN-BLK	Standard Black Knob (<i>Must be ordered with unit</i>)	N/C	N/C
KN-C	Knob: Standard 190 RAL Color	\$ 115 ea	\$ 130 ea
KN-CF	Knob: Spec Finish (Matte RAL, Textured RAL or Prec Metals)	\$ 185 ea	\$ 215 ea
KN-PLT	Knob: Plated Trim (See options below)	\$ 250 ea	\$ 290 ea
PLATED TRIM OPTIONS: (Includes bezels and logo)			
Antique Brass, Brushed Brass, Polished Brass, Brushed Copper & Pewter			

24" NOVA (RGTNB) SERIES | OPEN BURNER RANGETOPS



FEATURES:

- 22,000 BTU UltraNova™ burners & 15,000 BTU Nova™ burners
- Precise 130° simmer burner
- Available with all burners or all integrated griddle, charbroiler or French top
- Integrated wok cooking
- Customize with 190 color knobs and multiple trim options

PRODUCT SPECIFICATIONS:

- Unit Dimensions: 23.875"W x 24"D x 8.625"H
- Top Burner Power: 22,000 BTUs
- Simmer Burner: 9,000 BTUs
- Electrical Reqs: 120V, 60Hz, 15 AMPS, 1PH
- Gas Pressure: NAT: 5.0" WC, LP 10.0" WC
- Gas Line Size: 1/2"
- Unit Weight: 185 lbs.

Model	Description (* Denotes item that must be specified)	UMRP	MSRP
Natural Gas Models: 24" Nova Series Rangetop			
RGTNB244BV2	4 Burners Nat Gas Stainless Steel Std Trim	\$ 4,695	\$ 5,400
RGTNB244BV2PLT	4 Burners Nat Gas Stainless Steel Plated Trim*	\$ 5,490	\$ 6,315
LP/Propane Models: 24" Nova Series Rangetop			
RGTNB244BV2L	4 Burners LP Gas Stainless Steel Std Trim	\$ 4,695	\$ 5,400
RGTNB244BV2LPLT	4 Burners LP Gas Stainless Steel Plated Trim*	\$ 5,490	\$ 6,315
BACKGUARD OPTIONS See Page 54 for Additional Customization & Accessory Options			
All BlueStar freestanding appliances must be installed with a UL approved backguard. All units ship standard with a UL approved Island Trim unless otherwise specified.			
BG624BSP	6" Backguard	\$ 605	\$ 695
BG2417BSP	17" Backguard	\$ 1,120	\$ 1,290
SDHS24BSP	24" High Shelf	\$ 1,460	\$ 1,680
KNOB OPTIONS: (Total Knobs: 4)			
KN-BLK	Standard Black Knob (<i>Must be ordered with unit</i>)	N/C	N/C
KN-C	Knob: Standard 190 RAL Color	\$ 115 ea	\$ 130 ea
KN-CF	Knob: Spec Finish (Matte RAL, Textured RAL or Prec Metals)	\$ 185 ea	\$ 215 ea
KN-PLT	Knob: Plated Trim (See options below)	\$ 250 ea	\$ 290 ea
PLATED TRIM OPTIONS: (Includes bezels and logo)			
Antique Brass, Brushed Brass, Polished Brass, Brushed Copper & Pewter			

24" NOVA (RGTNB) SERIES | OPEN BURNER RANGETOPS

**24" Nova (RNB) Rangetop
All Griddle**

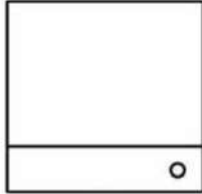

30,000

Model	Description (* Denotes item that must be specified)	UMRP	MSRP
Natural Gas Models: 24" Nova Series Rangetop – All Griddle			
RGTNB24GV2	24" Nova Series 24" Griddle Nat Gas Stainless Steel Standard Trim	\$ 4,695	\$ 5,400
RGTNB24GV2PLT	24" Nova Series 24" Griddle Nat Gas Stainless Steel Plated Trim*	\$ 5,490	\$ 6,315
LP/Propane Models: 24" Nova Series Rangetop – All Griddle			
RGTNB24GV2L	24" Nova Series 24" Griddle LP Gas Stainless Steel Standard Trim	\$ 4,695	\$ 5,400
RGTNB24GV2LPLT	24" Nova Series 24" Griddle LP Gas Stainless Steel Plated Trim*	\$ 5,490	\$ 6,315
Customization & Accessory Options: (See page 54) Total Knobs: 2			

**24" Nova (RNB) Rangetop
All Charbroiler**

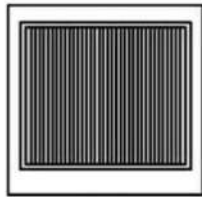

30,000

Model	Description (* Denotes item that must be specified)	UMRP	MSRP
Natural Gas Models: 24" Nova Series Rangetop – All Charbroiler			
RGTNB24CBV2	24" Nova Series 24" Charbroiler Nat Gas Stainless Steel Standard Trim	\$ 4,695	\$ 5,400
RGTNB24CBV2PLT	24" Nova Series 24" Charbroiler Nat Gas Stainless Steel Plated Trim*	\$ 5,490	\$ 6,315
LP/Propane Models: 24" Nova Series Rangetop – All Charbroiler			
RGTNB24CBV2L	24" Nova Series 24" Charbroiler LP Gas Stainless Steel Standard Trim	\$ 4,695	\$ 5,400
RGTNB24CBV2LPLT	24" Nova Series 24" Charbroiler LP Gas Stainless Steel Plated Trim*	\$ 5,490	\$ 6,315
Customization & Accessory Options: (See page 54) Total Knobs: 2			

**24" Nova (RNB) Rangetop
All French Top**

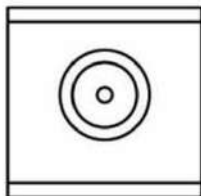

18,000

Model	Description (* Denotes item that must be specified)	UMRP	MSRP
Natural Gas Models: 24" Nova Series Rangetop – All French Top			
RGTNB24FTV2	24" Nova Series 24" French Top Nat Gas Stainless Steel Standard Trim	\$ 4,795	\$ 5,515
RGTNB24FTV2PLT	24" Nova Series 24" French Top Nat Gas Stainless Steel Plated Trim*	\$ 5,590	\$ 6,430
LP/Propane Models: 24" Nova Series Rangetop – All French Top			
RGTNB24FTV2L	24" Nova Series 24" French Top LP Gas Stainless Steel Standard Trim	\$ 4,795	\$ 5,515
RGTNB24FTV2LPLT	24" Nova Series 24" French Top LP Gas Stainless Steel Plated Trim*	\$ 5,590	\$ 6,430
Customization & Accessory Options: (See page 54) Total Knobs: 1			

CUSTOMIZATION & ACCESSORY OPTIONS | RANGETOPS & COOKTOPS

Item	Description	UMRP	MSRP
CONFIGURATION OPTIONS: BURNERS (Available on Platinum & Nova/RNB Series Only)			
BURNER CHG	Add (1) Star Burner – RNB / RGTNB (Simmer, 15K & 22K) BSP (Simmer, 15K, 18K, 22K or 25K) or Swap (2) Star Burners – RNB / RGTNB / BSP	\$ 715	\$ 820
PAINT & PLATING OPTIONS:			
KN-C	Knob: Standard RAL (Semi-Gloss) Knob – Factory Installed . (Excludes Pearl, Luminous & Aluminum)	\$ 115 ea	\$ 130 ea
KN-CF	Knob: Specialty Finish (Matte RAL, Textured RAL or Precious Metals) – Factory Installed .	\$ 185 ea	\$ 215 ea
KN-CC	Knob: Custom Color Knob – Factory Installed. MUST be ordered with 24" – 60" Custom Color appliance.	\$ 200 ea	\$ 230 ea
KN-PLT	Knob: Plated Trim	\$ 250 ea	\$ 290 ea
BZ-PLT	Bezel: Plated Trim	\$ 175 ea	\$ 200 ea
ACCESSORIES:			
IT24BSP	24" Island Trim Backguard for Platinum and Nova (RGTNB) Rangetops	\$ 565	\$ 650
IT30BSP	30" Island Trim Backguard for Platinum and Nova (RGTNB) Rangetops	\$ 565	\$ 650
IT36BSP	36" Island Trim Backguard for Platinum and Nova (RGTNB) Rangetops	\$ 665	\$ 765
IT48BSP	48" Island Trim Backguard for Platinum and Nova (RGTNB) Rangetops	\$ 955	\$ 1,100
IT60BSP	60" Island Trim Backguard for Platinum and Nova (RGTNB) Rangetops	\$ 1,210	\$ 1,390
KN-BLK	Standard Black Knob	\$ 115 ea	\$ 130 ea
KN-SS	Knob: Brushed Stainless Steel	\$ 115 ea	\$ 130 ea
BZ-SS	Bezel: Brushed Stainless Steel	\$ 65 ea	\$ 75 ea
BSPICBG12	Interchangeable Griddle Charbroiler – 4 piece	\$ 1,315	\$ 1,510
138901	Wok Ring	\$ 175	\$ 200



DISHWASHER

Get the Look: 24" Built-In Dishwasher in Green Grey with Brushed Brass Trim

24" BUILT-IN DISHWASHER | DISHWASHER

BlueStar Model Number Guide:

Base Model (BS24DWH1) Dishwasher with Panel Legacy Handle Stainless Steel Finish Standard Trim	Add code below for desired color (C) 190 Standard RAL (Semi-Gloss) Colors (CF) Specialty Finish (190 Matte RAL, Precious Metals & Textures) (CC) Custom Colors	Add (PLT) for Plated Trim Includes plated bezels, door handle, handle end and logo. See available options below.
--	--	---



FEATURES:

- Stunning stainless-steel interior
- 8 Wash Cycle options
- 5 Selectable Functions including Turbo Wash, Fast, Extra Dry, Sanitize, and Delayed Start
- Three full-extension racks, plus cutlery basket
- Active fan-assisted drying system
- Robust spray arms plus turbidity sensor
- Accommodates 16 place settings
- Whisper-quiet washing at 45 decibels
- Panel ready, built-in dishwasher comes standard with panel
- Unmatched customization – choose from 1,000+ colors and multiple trim options

PRODUCT SPECIFICATIONS:

- Unit Dims: 23 9/16"W x 21 5/8"D x 33 7/8" – 35 7/8"H
- Cut-Out Dims: 23 5/8" – 24"W x 24"D x 34" – 35 15/16"H
- Permissible Water Press: 4.35 – 145 psi (0.3 – 10 bars)
- Electrical Connection: 120V, 12 Amps, 60Hz
15 Amp, Dedicated circuit required
- Total Power: 1,400 W
- Heater Power: 1,100 W

Model	Description (* Denotes item that must be specified)	UMRP	MSRP
24" Built-In Dishwasher with Legacy Handle & Handle Ends			
BS24DWH1	Dishwasher w/ Panel Legacy Handle Stainless Steel Std Trim	\$ 1,295	\$ 1,490
BS24DWH1PLT	Dishwasher w/ Panel Legacy Handle Stainless Steel Plated Trim*	\$ 1,890	\$ 2,175
BS24DWH1C	Dishwasher w/ Panel Legacy Handle Std RAL Color* Std Trim	\$ 1,845	\$ 2,120
BS24DWH1CPLT	Dishwasher w/ Panel Legacy Handle Std RAL Color* Plated Trim*	\$ 2,440	\$ 2,805
BS24DWH1CF	Dishwasher w/ Panel Legacy Handle Specialty Finish* Std Trim	\$ 2,090	\$ 2,405
BS24DWH1CFPLT	Dishwasher w/ Panel Legacy Handle Specialty Finish* Plated Trim*	\$ 2,685	\$ 3,090
BS24DWH1CC	Dishwasher w/ Panel Legacy Handle Custom Color* Std Trim	\$ 2,745	\$ 3,155
BS24DWH1CCPLT	Dishwasher w/ Panel Legacy Handle Custom Color* Plated Trim*	\$ 3,340	\$ 3,840
24" Built-In Dishwasher with Platinum Handle & Handle Ends			
BS24DWH2	Dishwasher w/ Panel Plat Handle Stainless Steel Std Trim	\$ 1,295	\$ 1,490
BS24DWH2PLT	Dishwasher w/ Panel Plat Handle Stainless Steel Plated Trim*	\$ 1,890	\$ 2,175
BS24DWH2C	Dishwasher w/ Panel Plat Handle Std RAL Color* Std Trim	\$ 1,845	\$ 2,120
BS24DWH2CPLT	Dishwasher w/ Panel Plat Handle Std RAL Color* Plated Trim*	\$ 2,440	\$ 2,805
BS24DWH2CF	Dishwasher w/ Panel Plat Handle Specialty Finish* Std Trim	\$ 2,090	\$ 2,405
BS24DWH2CFPLT	Dishwasher w/ Panel Plat Handle Specialty Finish* Plated Trim*	\$ 2,685	\$ 3,090
BS24DWH2CC	Dishwasher w/ Panel Plat Handle Custom Color* Std Trim	\$ 2,745	\$ 3,155
BS24DWH2CCPLT	Dishwasher w/ Panel Plat Handle Custom Color* Plated Trim*	\$ 3,340	\$ 3,840
PLATED TRIM OPTIONS: (Includes door handle, handle ends and logo)			
Antique Brass, Brushed Brass, Polished Brass, Brushed Copper & Pewter			

24" DISHWASHER PANEL | DISHWASHER

BlueStar Model Number Guide:		
<p style="text-align: center;">Base Model (DWBS24H1)</p> <p>Panel Only Legacy Handle Stainless Steel Finish Standard Trim</p>	<p style="text-align: center;">Add code below for desired color</p> <p>(C) 190 Standard RAL (Semi-Gloss) Colors (CF) Specialty Finish (190 Matte RAL, Precious Metals & Textures) (CC) Custom Colors</p>	<p style="text-align: center;">Add (PLT) for Plated Trim</p> <p>Includes plated bezels, door handle, handle end and logo. See available options below.</p>



FEATURES:

- Accommodates most major dishwasher brands
- Heavy-duty stainless steel construction
- Unmatched customization – choose from 1,000+ colors and multiple trim options

Model	Description (* Denotes item that must be specified)	UMRP	MSRP
24" Panel Only with Legacy Handle & Handle Ends			
DWBS24H1	Panel Only Legacy Handle Stainless Steel Std Trim	\$ 495	\$ 570
DWBS24H1PLT	Panel Only Legacy Handle Stainless Steel Plated Trim*	\$ 1,090	\$ 1,255
DWBS24H1C	Panel Only Legacy Handle Std RAL Color* Std Trim	\$ 1,045	\$ 1,200
DWBS24H1CPLT	Panel Only Legacy Handle Std RAL Color* Plated Trim*	\$ 2,440	\$ 2,805
DWBS24H1CF	Panel Only Legacy Handle Specialty Finish* Std Trim	\$ 2,090	\$ 2,405
DWBS24H1CFPLT	Panel Only Legacy Handle Specialty Finish* Plated Trim*	\$ 2,685	\$ 3,090
DWBS24H1CC	Panel Only Legacy Handle Custom Color* Std Trim	\$ 2,745	\$ 3,155
DWBS24H1CCPLT	Panel Only Legacy Handle Custom Color* Plated Trim*	\$ 3,340	\$ 3,840
24" Panel Only with Platinum Handle & Handle Ends			
DWBS24H2	Panel Only Plat Handle Stainless Steel Std Trim	\$ 495	\$ 570
DWBS24H2PLT	Panel Only Plat Handle Stainless Steel Plated Trim*	\$ 1,090	\$ 1,255
DWBS24H2C	Panel Only Plat Handle Std RAL Color* Std Trim	\$ 1,045	\$ 1,200
DWBS24H2CPLT	Panel Only Plat Handle Std RAL Color* Plated Trim*	\$ 2,440	\$ 2,805
DWBS24H2CF	Panel Only Plat Handle Specialty Finish* Std Trim	\$ 2,090	\$ 2,405
DWBS24H2CFPLT	Panel Only Plat Handle Specialty Finish* Plated Trim*	\$ 2,685	\$ 3,090
DWBS24H2CC	Panel Only Plat Handle Custom Color* Std Trim	\$ 2,745	\$ 3,155
DWBS24H2CCPLT	Panel Only Plat Handle Custom Color* Plated Trim*	\$ 3,340	\$ 3,840
PLATED TRIM OPTIONS: (Includes door handle, handle ends and logo)			
Antique Brass, Brushed Brass, Polished Brass, Brushed Copper & Pewter			



WALL OVENS

Get the Look: 30" Double Electric Wall Oven in Brushed Stainless Steel

30" DOUBLE ELECTRIC FRENCH DOOR WALL OVEN | WALL OVENS

BlueStar Model Number Guide:		
Base Model (BSDEW030SDV3) French/Drop Door Electric Stainless Steel Finish Standard Trim	Add code below for desired color (C) 190 Standard RAL (Semi-Gloss) Colors (CF) Specialty Finish (190 Matte RAL, Precious Metals & Textures) (CC) Custom Colors	Add (PLT) for Plated Trim Includes plated bezels, door handle, handle end and logo. See available options below.



FEATURES:

- New over-sized, intuitive, full-color touchscreen with unique customization capabilities.
- Extra-large oven capacity, overall capacity of 9.2 cu ft & industry leading usable capacity of 7.1 cu ft.
- Built-in, temperature-controlled bake stone for perfect artisan breads and pizzas.
- Professional-level performance with 9 cooking modes plus temperature probe, delayed start, timed cook, warm and Sabbath features.
- Fits full-size commercial sheet pans & includes a full-extension rack.
- Unmatched customization – choose from 1,000+ colors and multiple trim options
- Easy to clean, 90-minute express cycle.
- Handcrafted in Pennsylvania since 1880.

PRODUCT SPECIFICATIONS:

- Unit Dimensions: 30"W x 25 5/32"D x 49 3/4"H
- Oven Interior: 26.438"W x 20"D x 15"H
- Elec. Reqs: 240V, 60Hz, 50 AMPs, 1 PH
- Unit Weight: 483 lbs.

Model	Description (* Denotes item that must be specified)	UMRP	MSRP
30" Double Electric Wall Oven with French and Drop Door			
BSDEW030SDV3	French/Drop Door Stainless Steel Standard Trim	\$ 10,695	\$ 12,300
BSDEW030SDV3PLT	French/Drop Door Stainless Steel Plated Trim*	\$ 13,090	\$ 15,055
BSDEW030SDV3C	French/Drop Door Std RAL Color* Standard Trim	\$ 12,190	\$ 14,020
BSDEW030SDV3CPLT	French/Drop Door Std RAL Color* Plated Trim*	\$ 14,585	\$ 16,775
BSDEW030SDV3CF	French/Drop Door Specialty Finish* Standard Trim	\$ 13,090	\$ 15,055
BSDEW030SDV3CFPLT	French/Drop Door Specialty Finish* Plated Trim*	\$ 15,485	\$ 17,810
BSDEW030SDV3CC	French/Drop Door Custom Color* Standard Trim	\$ 14,490	\$ 16,665
BSDEW030SDV3CCPLT	French/Drop Door Custom Color* Plated Trim*	\$ 16,885	\$ 19,420
KNOB OPTIONS: (Total Knobs: 2)			
KN-BLK	Standard Black Knob (<i>Must be ordered with unit</i>)	N/C	N/C
KN-C	Knob: Standard 190 RAL Color	\$ 115 ea	\$ 130 ea
KN-CF	Knob: Spec Finish (Matte RAL, Textured RAL or Prec Metals)	\$ 185 ea	\$ 215 ea
KN-PLT	Knob: Plated Trim (See options below)	\$ 250 ea	\$ 290 ea
PLATED TRIM OPTIONS: (Includes bezels, door handle, handle ends and logo)			
Antique Brass, Brushed Brass, Polished Brass, Brushed Copper & Pewter			
See page 66 for additional customization and accessories			

30" DOUBLE ELECTRIC WALL OVEN | WALL OVENS

BlueStar Model Number Guide:

Base Model (BSDEW030DDV3) Drop Door/Drop Door Electric Stainless Steel Finish Standard Trim	Add code below for desired color (C) 190 Standard RAL (Semi-Gloss) Colors (CF) Specialty Finish (190 Matte RAL, Precious Metals & Textures) (CC) Custom Colors	Add (PLT) for Plated Trim Includes plated bezels, door handle, handle end and logo. See available options below.
---	--	---



Model	Description (* Denotes item that must be specified)	UMRP	MSRP
30" Double Electric Wall Oven with Double Drop Doors			
BSDEW030DDV3	Drop Doors Stainless Steel Standard Trim	\$ 10,095	\$ 11,610
BSDEW030DDV3PLT	Drop Doors Stainless Steel Plated Trim*	\$ 12,490	\$ 14,365
BSDEW030DDV3C	Drop Doors Std RAL Color* Standard Trim	\$ 11,590	\$ 13,330
BSDEW030DDV3CPLT	Drop Doors Std RAL Color* Plated Trim*	\$ 13,985	\$ 16,085
BSDEW030DDV3CF	Drop Doors Specialty Finish* Standard Trim	\$ 12,490	\$ 14,365
BSDEW030DDV3CFPLT	Drop Doors Specialty Finish* Plated Trim*	\$ 14,885	\$ 17,120
BSDEW030DDV3CC	Drop Doors Custom Color* Standard Trim	\$ 13,890	\$ 15,975
BSDEW030DDV3CCPLT	Drop Doors Custom Color* Plated Trim*	\$ 16,285	\$ 18,730
KNOB OPTIONS: (Total Knobs: 2)			
KN-BLK	Standard Black Knob (<i>Must be ordered with unit</i>)	N/C	N/C
KN-C	Knob: Standard 190 RAL Color	\$ 115 ea	\$ 130 ea
KN-CF	Knob: Spec Finish (Matte RAL, Textured RAL or Prec Metals)	\$ 185 ea	\$ 215 ea
KN-PLT	Knob: Plated Trim (See options below)	\$ 250 ea	\$ 290 ea
PLATED TRIM OPTIONS: (Includes bezels, door handle, handle ends and logo)			
Antique Brass, Brushed Brass, Polished Brass, Brushed Copper & Pewter			
See page 66 for additional customization and accessories			

FEATURES:

- New over-sized, intuitive, full-color touchscreen with unique customization capabilities.
- Extra-large oven capacity, overall capacity of 9.2 cu ft & industry leading usable capacity of 7.1 cu ft.
- Built-in, temperature-controlled bake stone for perfect artisan breads and pizzas.
- Professional-level performance with 9 cooking modes plus temperature probe, delayed start, timed cook, warm and Sabbath features.
- Fits full-size commercial sheet pans & includes a full-extension rack.
- Unmatched customization – choose from 1,000+ colors and multiple trim options
- Easy to clean, 90-minute express cycle.
- Handcrafted in Pennsylvania since 1880.

PRODUCT SPECIFICATIONS:

- Unit Dimensions: 30"W x 25 5/32"D x 49 3/4"H
- Oven Interior: 26.438"W x 20"D x 15"H
- Elec. Reqs: 240V, 60Hz, 50 AMPs, 1 PH
- Unit Weight: 483 lbs.

30" FRENCH DOOR ELECTRIC WALL OVEN | WALL OVENS

BlueStar Model Number Guide:

Base Model (BSEW030SDV3) French Door Electric Stainless Steel Finish Standard Trim	Add code below for desired color (C) 190 Standard RAL (Semi-Gloss) Colors (CF) Specialty Finish (190 Matte RAL, Precious Metals & Textures) (CC) Custom Colors	Add (PLT) for Plated Trim Includes plated bezels, door handle, handle end and logo. See available options below.
--	--	---



FEATURES:

- New over-sized, intuitive, full-color touchscreen with unique customization capabilities.
- Extra-large oven capacity, overall capacity of 4.6 cu ft & industry leading usable capacity of 3.5 cu ft.
- Built-in, temperature-controlled bake stone for perfect artisan breads and pizzas.
- Professional-level performance with 9 cooking modes plus temperature probe, delayed start, timed cook, warm and Sabbath features.
- Fits full-size commercial sheet pans & includes a full-extension rack.
- Unmatched customization – choose from 1,000+ colors and multiple trim options
- Easy to clean, 90-minute express cycle.
- Handcrafted in Pennsylvania since 1880.

PRODUCT SPECIFICATIONS:

- Unit Dimensions: 30"W x 25.875"D x 27.5"H
- Oven Interior: 26.438"W x 20"D x 15"H
- Elec. Reqs: 208-240 VAC, 24 Amps
- Unit Weight: 304 lbs.

Model	Description (* Denotes item that must be specified)	UMRP	MSRP
30" Electric Wall Oven with French Door			
BSEW030SDV3	French Door Stainless Steel Standard Trim	\$ 7,095	\$ 8,160
BSEW030SDV3PLT	French Door Stainless Steel Plated Trim*	\$ 8,690	\$ 9,995
BSEW030SDV3C	French Door Std RAL Color* Standard Trim	\$ 8,290	\$ 9,535
BSEW030SDV3CPLT	French Door Std RAL Color* Plated Trim*	\$ 9,885	\$ 11,370
BSEW030SDV3CF	French Door Specialty Finish* Standard Trim	\$ 9,290	\$ 10,685
BSEW030SDV3CFPLT	French Door Specialty Finish* Plated Trim*	\$ 10,885	\$ 12,520
BSEW030SDV3CC	French Door Custom Color* Standard Trim	\$ 10,790	\$ 12,410
BSEW030SDV3CCPLT	French Door Custom Color* Plated Trim*	\$ 12,385	\$ 14,245
STACKING KIT:			
EWOSTK-30	Stacking Kit for 30" Electric Wall Ovens	N/C	N/C
KNOB OPTIONS: (Total Knobs: 2)			
KN-BLK	Standard Black Knob (<i>Must be ordered with unit</i>)	N/C	N/C
KN-C	Knob: Standard 190 RAL Color	\$ 115 ea	\$ 130 ea
KN-CF	Knob: Spec Finish (Matte RAL, Textured RAL or Prec Metals)	\$ 185 ea	\$ 215 ea
KN-PLT	Knob: Plated Trim (See options below)	\$ 250 ea	\$ 290 ea
PLATED TRIM OPTIONS: (Includes bezels, door handle, handle ends and logo)			
Antique Brass, Brushed Brass, Polished Brass, Brushed Copper & Pewter			
See page 66 for additional customization and accessories			

30" DROP DOOR ELECTRIC WALL OVEN | WALL OVENS

BlueStar Model Number Guide:

Base Model (BSEW030DDV3) Drop Door Electric Stainless Steel Finish Standard Trim	Add code below for desired color (C) 190 Standard RAL (Semi-Gloss) Colors (CF) Specialty Finish (190 Matte RAL, Precious Metals & Textures) (CC) Custom Colors	Add (PLT) for Plated Trim Includes plated bezels, door handle, handle end and logo. See available options below.
--	--	---



FEATURES:

- New over-sized, intuitive, full-color touchscreen with unique customization capabilities.
- Extra-large oven capacity, overall capacity of 4.6 cu ft & industry leading usable capacity of 3.5 cu ft.
- Built-in, temperature-controlled bake stone for perfect artisan breads and pizzas.
- Professional-level performance with 9 cooking modes plus temperature probe, delayed start, timed cook, warm and Sabbath features.
- Fits full-size commercial sheet pans & includes a full-extension rack.
- Unmatched customization – choose from 1,000+ colors and multiple trim options
- Easy to clean, 90-minute express cycle.
- Handcrafted in Pennsylvania since 1880.

PRODUCT SPECIFICATIONS:

- Unit Dimensions: 30"W x 25.875"D x 27.5"H
- Oven Interior: 26.438"W x 20"D x 15"H
- Elec. Reqs: 208-240 VAC, 24 Amps
- Unit Weight: 304 lbs.

Model	Description (* Denotes item that must be specified)	UMRP	MSRP
30" Electric Wall Oven with Drop Door			
BSEW030DDV3	Drop Door Stainless Steel Standard Trim	\$ 6,495	\$ 7,470
BSEW030DDV3PLT	Drop Door Stainless Steel Plated Trim*	\$ 8,090	\$ 9,305
BSEW030DDV3C	Drop Door Std RAL Color* Standard Trim	\$ 7,690	\$ 8,845
BSEW030DDV3CPLT	Drop Door Std RAL Color* Plated Trim*	\$ 9,285	\$ 10,680
BSEW030DDV3CF	Drop Door Specialty Finish* Standard Trim	\$ 8,690	\$ 9,995
BSEW030DDV3CFPLT	Drop Door Specialty Finish* Plated Trim*	\$ 10,285	\$ 11,830
BSEW030DDV3CC	Drop Door Custom Color* Standard Trim	\$ 10,190	\$ 11,720
BSEW030DDV3CCPLT	Drop Door Custom Color* Plated Trim*	\$ 11,785	\$ 13,555
STACKING KIT:			
EWOSTK-30	Stacking Kit for 30" Electric Wall Ovens	N/C	N/C
KNOB OPTIONS: (Total Knobs: 2)			
KN-BLK	Standard Black Knob (<i>Must be ordered with unit</i>)	N/C	N/C
KN-C	Knob: Standard 190 RAL Color	\$ 115 ea	\$ 130 ea
KN-CF	Knob: Spec Finish (Matte RAL, Textured RAL or Prec Metals)	\$ 185 ea	\$ 215 ea
KN-PLT	Knob: Plated Trim (See options below)	\$ 250 ea	\$ 290 ea
PLATED TRIM OPTIONS: (Includes bezels, door handle, handle ends and logo)			
Antique Brass, Brushed Brass, Polished Brass, Brushed Copper & Pewter			
See page 66 for additional customization and accessories			

BlueStar Model Number Guide:			
Base Model (BW036AGSV2) French Door Natural Gas Stainless Steel Finish Standard Trim	LP Models Add (L) for LP/Propane Gas	Add code below for desired color (C) 190 Standard RAL (Semi-Gloss) Colors (CF) Specialty Finish (190 Matte RAL, Precious Metals & Textures) (CC) Custom Colors	Add (PLT) for Plated Trim Includes plated bezels, door handle, handle end and logo. See available options below.

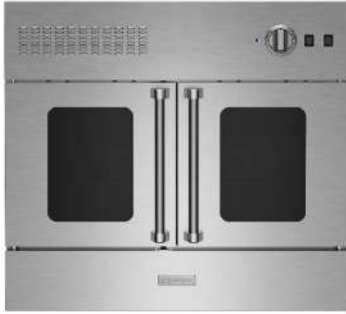

FEATURES:

- Powerful 25,000 BTU burner with 1850° Infrared Broiler
- Extra-large oven that accommodates a full size 18" x 26" commercial baking sheet
- 24" depth for compatibility with standard kitchen cabinetry
- Available as single ovens or two single ovens double stacked
- Unmatched customization – choose from 1,000+ colors and multiple trim options
- Handcrafted in Pennsylvania since 1880

PRODUCT SPECIFICATIONS:

- Unit Dimensions: 36"W x 23"D x 32.75"H
- Oven Interior: 29.25"W x 20"D x 15"H
- Gas Pressure: NAT: 5.0" WC, LP 10.0" WC
- Incoming Gas Line Size: ½"
- Unit Weight: 400 lbs.

Model	Description (* Denotes item that must be specified)	UMRP	MSRP
Natural Gas Models: 36" Built-In Gas Wall Oven			
BW036AGSV2	Nat Gas Stainless Steel Standard Trim	\$ 7,765	\$ 8,930
BW036AGSV2PLT	Nat Gas Stainless Steel Plated Trim*	\$ 9,360	\$ 10,765
BW036AGSV2C	Nat Gas Std RAL Color* Standard Trim	\$ 8,960	\$ 10,305
BW036AGSV2CPLT	Nat Gas Std RAL Color* Plated Trim*	\$ 10,555	\$ 12,140
BW036AGSV2CF	Nat Gas Specialty Finish* Standard Trim	\$ 9,960	\$ 11,455
BW036AGSV2CFPLT	Nat Gas Specialty Finish* Plated Trim*	\$ 11,555	\$ 13,290
BW036AGSV2CC	Nat Gas Custom Color* Standard Trim	\$ 11,460	\$ 13,180
BW036AGSV2CCPLT	Nat Gas Custom Color* Plated Trim*	\$ 13,055	\$ 15,015
LP/Propane Models: 36" Built-In Gas Wall Oven			
BW036AGSV2L	LP Gas Stainless Steel Standard Trim	\$ 7,765	\$ 8,930
BW036AGSV2LPLT	LP Gas Stainless Steel Plated Trim*	\$ 9,360	\$ 10,765
BW036AGSV2LC	LP Gas Std RAL Color* Standard Trim	\$ 8,960	\$ 10,305
BW036AGSV2LCPLT	LP Gas Std RAL Color* Plated Trim*	\$ 10,555	\$ 12,140
BW036AGSV2LCF	LP Gas Specialty Finish* Standard Trim	\$ 9,960	\$ 11,455
BW036AGSV2LCFPLT	LP Gas Specialty Finish* Plated Trim*	\$ 11,555	\$ 13,290
BW036AGSV2LCC	LP Gas Custom Color* Standard Trim	\$ 11,460	\$ 13,180
BW036AGSV2LCCPLT	LP Gas Custom Color* Plated Trim*	\$ 13,055	\$ 15,015
STACKING KIT:			
BWSTK-36	Stacking Kit for 36" Gas Wall Ovens	N/C	N/C
KNOB OPTIONS: (Total Knobs: 1)			
KN-BLK	Standard Black Knob (<i>Must be ordered with unit</i>)	N/C	N/C
KN-C	Knob: Standard 190 RAL Color	\$ 115 ea	\$ 130 ea
KN-CF	Knob: Spec Finish (Matte RAL, Textured RAL or Prec Metals)	\$ 185 ea	\$ 215 ea
KN-PLT	Knob: Plated Trim (See options below)	\$ 250 ea	\$ 290 ea
PLATED TRIM OPTIONS: (Includes bezels, door handle, handle ends and logo)			
Antique Brass, Brushed Brass, Polished Brass, Brushed Copper & Pewter			
See page 66 for additional customization and accessories			

30" GAS WALL OVEN | WALL OVENS

BlueStar Model Number Guide:

Base Model (BW030AGSV2) French Door Natural Gas Stainless Steel Finish Standard Trim	LP Models Add (L) for LP/Propane Gas	Add code below for desired color (C) 190 Standard RAL (Semi-Gloss) Colors (CF) Specialty Finish (190 Matte RAL, Precious Metals & Textures) (CC) Custom Colors	Add (PLT) for Plated Trim Includes plated bezels, door handle, handle end and logo. See available options below.
--	--	--	---



FEATURES:

- Powerful 25,000 BTU burner with 1850° Infrared Broiler
- Extra-large oven that accommodates a full size 18" x 26" commercial baking sheet
- 24" depth for compatibility with standard kitchen cabinetry
- Available as single ovens or two single ovens double stacked
- Unmatched customization – choose from 1,000+ colors and multiple trim options
- Handcrafted in Pennsylvania since 1880

PRODUCT SPECIFICATIONS:

- Unit Dimensions: 30"W x 26"D x 32.75"H
- Oven Interior: 26.438"W x 20"D x 15"H
- Gas Pressure: NAT: 5.0" WC, LP 10.0" WC
- Incoming Gas Line Size: ½"
- Unit Weight: 305 lbs.

Model	Description (* Denotes item that must be specified)	UMRP	MSRP
Natural Gas Models: 30" Built-In Gas Wall Oven			
BW030AGSV2	Nat Gas Stainless Steel Standard Trim	\$ 6,505	\$ 7,480
BW030AGSV2PLT	Nat Gas Stainless Steel Plated Trim*	\$ 8,100	\$ 9,315
BW030AGSV2C	Nat Gas Std RAL Color* Standard Trim	\$ 7,700	\$ 8,855
BW030AGSV2CPLT	Nat Gas Std RAL Color* Plated Trim*	\$ 9,295	\$ 10,690
BW030AGSV2CF	Nat Gas Specialty Finish* Standard Trim	\$ 8,700	\$ 10,005
BW030AGSV2CFPLT	Nat Gas Specialty Finish* Plated Trim*	\$ 10,295	\$ 11,840
BW030AGSV2CC	Nat Gas Custom Color* Standard Trim	\$ 10,200	\$ 11,730
BW030AGSV2CCPLT	Nat Gas Custom Color* Plated Trim*	\$ 11,795	\$ 13,565
LP/Propane Models: 30" Built-In Gas Wall Oven			
BW030AGSV2L	LP Gas Stainless Steel Standard Trim	\$ 6,505	\$ 7,480
BW030AGSV2LPLT	LP Gas Stainless Steel Plated Trim*	\$ 8,100	\$ 9,315
BW030AGSV2LC	LP Gas Std RAL Color* Standard Trim	\$ 7,700	\$ 8,855
BW030AGSV2LCPLT	LP Gas Std RAL Color* Plated Trim*	\$ 9,295	\$ 10,690
BW030AGSV2LCF	LP Gas Specialty Finish* Standard Trim	\$ 8,700	\$ 10,005
BW030AGSV2LCFPLT	LP Gas Specialty Finish* Plated Trim*	\$ 10,295	\$ 11,840
BW030AGSV2LCC	LP Gas Custom Color* Standard Trim	\$ 10,200	\$ 11,730
BW030AGSV2LCCPLT	LP Gas Custom Color* Plated Trim*	\$ 11,795	\$ 13,565
STACKING KIT:			
BWOSTK-30	Stacking Kit for 30" Gas Wall Ovens	N/C	N/C
KNOB OPTIONS: (Total Knobs: 1)			
KN-BLK	Standard Black Knob (<i>Must be ordered with unit</i>)	N/C	N/C
KN-C	Knob: Standard 190 RAL Color	\$ 115 ea	\$ 130 ea
KN-CF	Knob: Spec Finish (Matte RAL, Textured RAL or Prec Metals)	\$ 185 ea	\$ 215 ea
KN-PLT	Knob: Plated Trim (See options below)	\$ 250 ea	\$ 290 ea
PLATED TRIM OPTIONS: (Includes bezels, door handle, handle ends and logo)			
Antique Brass, Brushed Brass, Polished Brass, Brushed Copper & Pewter			
See page 66 for additional customization and accessories			

BlueStar Model Number Guide:			
Base Model (BW024AGSV2) Left Hinge Natural Gas Stainless Steel Finish Standard Trim	LP Models Add (L) for LP/Propane Gas	Add code below for desired color (C) 190 Standard RAL (Semi-Gloss) Colors (CF) Specialty Finish (190 Matte RAL, Precious Metals & Textures) (CC) Custom Colors	Add (PLT) for Plated Trim Includes plated bezels, door handle, handle end and logo. See available options below.



Model Shown: BW024AGS (Left Hinge)
Must notate right or left hinge at time of order

FEATURES:

- Powerful 25,000 BTU burner with 1850° Infrared Broiler
- Extra-large oven that accommodates a half size 18" x 13" commercial baking sheet
- Features swing door design from either left or right side
- 24" depth for compatibility with standard kitchen cabinetry
- Available as single ovens or two single ovens double stacked
- Unmatched customization – choose from 1,000+ colors and multiple trim options
- Handcrafted in Pennsylvania since 1880

PRODUCT SPECIFICATIONS:

- Unit Dimensions: 24"W x 23"D x 32.75"H
- Oven Interior: 20.25"W x 20"D x 15"H
- Gas Pressure: NAT: 5.0" WC, LP 10.0" WC
- Incoming Gas Line Size: ½"
- Unit Weight: 295 lbs.

Model	Description (* Denotes item that must be specified)	UMRP	MSRP
Natural Gas Models: 24" Built-In Gas Wall Oven			
BW024AGSV2	Nat Gas Stainless Steel Standard Trim	\$ 4,930	\$ 5,670
BW024AGSV2PLT	Nat Gas Stainless Steel Plated Trim*	\$ 6,025	\$ 6,930
BW024AGSV2C	Nat Gas Std RAL Color* Standard Trim	\$ 6,125	\$ 7,045
BW024AGSV2CPLT	Nat Gas Std RAL Color* Plated Trim*	\$ 7,220	\$ 8,305
BW024AGSV2CF	Nat Gas Specialty Finish* Standard Trim	\$ 7,125	\$ 8,195
BW024AGSV2CFPLT	Nat Gas Specialty Finish* Plated Trim*	\$ 8,220	\$ 9,455
BW024AGSV2CC	Nat Gas Custom Color* Standard Trim	\$ 8,625	\$ 9,920
BW024AGSV2CCPLT	Nat Gas Custom Color* Plated Trim*	\$ 9,720	\$ 11,180
LP/Propane Models: 24" Built-In Gas Wall Oven			
BW024AGSV2L	LP Gas Stainless Steel Standard Trim	\$ 4,930	\$ 5,670
BW024AGSV2LPLT	LP Gas Stainless Steel Plated Trim*	\$ 6,025	\$ 6,930
BW024AGSV2LC	LP Gas Std RAL Color* Standard Trim	\$ 6,125	\$ 7,045
BW024AGSV2LCPLT	LP Gas Std RAL Color* Plated Trim*	\$ 7,220	\$ 8,305
BW024AGSV2LCF	LP Gas Specialty Finish* Standard Trim	\$ 7,125	\$ 8,195
BW024AGSV2LCFPLT	LP Gas Specialty Finish* Plated Trim*	\$ 8,220	\$ 9,455
BW024AGSV2LCC	LP Gas Custom Color* Standard Trim	\$ 8,625	\$ 9,920
BW024AGSV2LCCPLT	LP Gas Custom Color* Plated Trim*	\$ 9,720	\$ 11,180
STACKING KIT:			
BWOSTK-24	Stacking Kit for 24" Gas Wall Ovens	N/C	N/C
KNOB OPTIONS: (Total Knobs: 1)			
KN-BLK	Standard Black Knob (<i>Must be ordered with unit</i>)	N/C	N/C
KN-C	Knob: Standard 190 RAL Color	\$ 115 ea	\$ 130 ea
KN-CF	Knob: Spec Finish (Matte RAL, Textured RAL or Prec Metals)	\$ 185 ea	\$ 215 ea
KN-PLT	Knob: Plated Trim (See options below)	\$ 250 ea	\$ 290 ea
PLATED TRIM OPTIONS: (Includes bezels, door handle, handle ends and logo)			
Antique Brass, Brushed Brass, Polished Brass, Brushed Copper & Pewter			
See page 66 for additional customization and accessories			

CUSTOMIZATION & ACCESSORY OPTIONS | WALL OVENS

Item	Description	UMRP	MSRP
PAINT & PLATING OPTIONS:			
KN-C	Knob: Standard RAL (Semi-Gloss) Knob – Factory Installed . (Excludes Pearl, Luminous & Aluminum)	\$ 115 ea	\$ 130 ea
KN-CF	Knob: Specialty Finish (Matte RAL, Textured RAL or Precious Metals) – Factory Installed .	\$ 185 ea	\$ 215 ea
KN-CC	Knob: Custom Color Knob – Factory Installed. MUST be ordered with 24” – 60” Custom Color appliance.	\$ 200 ea	\$ 230 ea
KN-PLT	Knob: Plated Trim	\$ 250 ea	\$ 290 ea
BZ-PLT	Bezel: Plated Trim	\$ 175 ea	\$ 200 ea
ACCESSORIES:			
KN-BLK	Standard Black Knob	\$ 115 ea	\$ 130 ea
KN-SS	Knob: Brushed Stainless Steel	\$ 115 ea	\$ 130 ea
BZ-SS	Bezel: Brushed Stainless Steel	\$ 65 ea	\$ 75 ea
CSK-1000002	Full Extension Rack for 24” Freestanding Ranges & Wall Ovens	\$ 550	\$ 635
CSK-1000003	Full Extension Rack for 30” Freestanding Ranges & Wall Ovens	\$ 590	\$ 680
CSK-1000004	Full Extension Rack for 36” Freestanding Ranges & Wall Ovens	\$ 620	\$ 715
704406	Standard Oven Rack for 24” Freestanding Ranges & Wall Ovens	\$ 120	\$ 140
704405	Standard Oven Rack for 30” Freestanding Ranges & Wall Ovens	\$ 155	\$ 180
704402	Standard Oven Rack for 36” Freestanding Ranges & Wall Ovens	\$ 175	\$ 200
799211	30” Electric Wall Oven Baking Stone	\$ 115	\$ 130



REFRIGERATION

Get the Look: Panel Ready 30" Column Refrigerator & 18" Column Freezer

36" PRO BUILT-IN REFRIGERATOR/FREEZER | REFRIGERATION

BlueStar Model Number Guide:

Base Model (BBB36R3) Right Hinge Stainless Steel Finish Standard Trim	Add code below for desired color (C) 190 Standard RAL (Semi-Gloss) Colors (CF) Specialty Finish (190 Matte RAL, Precious Metals & Textures) (CC) Custom Colors	Add (PLT) for Plated Trim Includes plated bezels, door handle, handle end and logo. See available options below.
---	--	---



Model Shown: BBB36R3



Model Shown: BBB36L3

Model	Description (* Denotes item that must be specified)	UMRP	MSRP
36" Pro Built-In Refrigerator/Freezer – RIGHT HINGE			
BBB36R3	Right Hinge Stainless Steel Standard Trim	\$ 11,995	\$ 13,795
BBB36R3PLT	Right Hinge Stainless Steel Plated Trim*	\$ 13,390	\$ 15,400
BBB36R3C	Right Hinge Std RAL Color* Standard Trim	\$ 13,490	\$ 15,515
BBB36R3CPLT	Right Hinge Std RAL Color* Plated Trim*	\$ 14,885	\$ 17,120
BBB36R3CF	Right Hinge Specialty Finish* Standard Trim	\$ 13,990	\$ 16,090
BBB36R3CFPLT	Right Hinge Specialty Finish* Plated Trim*	\$ 15,385	\$ 17,695
BBB36R3CC	Right Hinge Custom Color* Standard Trim	\$ 15,290	\$ 17,585
BBB36R3CCPLT	Right Hinge Custom Color* Plated Trim*	\$ 16,685	\$ 19,190
36" Pro Built-In Refrigerator/Freezer – LEFT HINGE			
BBB36L3	Left Hinge Stainless Steel Standard Trim	\$ 11,995	\$ 13,795
BBB36L3PLT	Left Hinge Stainless Steel Plated Trim*	\$ 13,390	\$ 15,400
BBB36L3C	Left Hinge Std RAL Color* Standard Trim	\$ 13,490	\$ 15,515
BBB36L3CPLT	Left Hinge Std RAL Color* Plated Trim*	\$ 14,885	\$ 17,120
BBB36L3CF	Left Hinge Specialty Finish* Standard Trim	\$ 13,990	\$ 16,090
BBB36L3CFPLT	Left Hinge Specialty Finish* Plated Trim*	\$ 15,385	\$ 17,695
BBB36L3CC	Left Hinge Custom Color* Standard Trim	\$ 15,290	\$ 17,585
BBB36L3CCPLT	Left Hinge Custom Color* Plated Trim*	\$ 16,685	\$ 19,190
ADDITIONAL OPTIONS:			
PAINT REFR GRILL	Painted Top Grill on Built-In Refrigerator	\$ 250	\$ 290
799338 – 36 REFR	90 Degree Pin Stops (*Must be specified on order*)	\$ 40	\$ 45
ACCESSORIES AVAILABLE SEPARATELY:			
799071	Plastic Ice Bin	\$ 125	\$ 145
799627	Ice Scoop	\$ 40	\$ 45
799438	Replacement Water Filter	\$ 95	\$ 110
799700	Replacement Air Filter	\$ 50	\$ 60
RSK-950128	Perimeter Trim	N/C	N/C
PLATED TRIM OPTIONS: (Includes door handle, handle ends and logo)			
Antique Brass, Brushed Brass, Polished Brass, Brushed Copper & Pewter			

FEATURES:

- All Stainless Steel and Glass Interiors
- Dual Compressors
- Oversized Capacity
- Fits Commercial Size Sheet Tray: Refrigerator/Freezer
- Ramp-on LED Lighting
- Unmatched customization – choose from 1,000+ colors and multiple trim options
- Automatic Ice Maker
- Designed and Manufactured in USA
- Iron Clad Warranty: 2 years (full), 5 years (sealed system parts & labor) and 13 years (sealed system parts)
- Unit weight: 783 lbs.

36" PRO BUILT-IN FRENCH DOOR REFRIGERATOR/FREEZER | REFRIGERATION

BlueStar Model Number Guide:

<p>Base Model (BBF361) French Door Stainless Steel Finish Standard Trim</p>	<p>Add code below for desired color (C) 190 Standard RAL (Semi-Gloss) Colors (CF) Specialty Finish (190 Matte RAL, Precious Metals & Textures) (CC) Custom Colors</p>	<p>Add (PLT) for Plated Trim Includes plated bezels, door handle, handle end and logo. See available options below.</p>
--	--	--



FEATURES:

- All Stainless Steel and Glass Interiors
- Dual Compressors
- Oversized 22.4 cu. ft. Capacity
- Fits Commercial Size Sheet Tray: Refrigerator/Freezer
- Heavy Duty Construction
- Ramp-on LED Lighting
- Unmatched customization – choose from 1,000+ colors and multiple trim options
- Automatic Ice Maker
- Designed and Manufactured in USA
- Iron Clad Warranty: 2 years (full), 5 years (sealed system parts & labor) and 13 years (sealed system parts)
- Unit weight: 783 lbs.

Model	Description (* Denotes item that must be specified)	UMRP	MSRP
36" Pro French Door Built-in Refrigerator/Freezer			
BBBF361	French Door Stainless Steel Standard Trim	\$ 12,995	\$ 14,945
BBBF361PLT	French Door Stainless Steel Plated Trim*	\$ 14,590	\$ 16,780
BBBF361C	French Door Std RAL Color* Standard Trim	\$ 14,590	\$ 16,780
BBBF361CPLT	French Door Std RAL Color* Plated Trim*	\$ 16,185	\$ 18,615
BBBF361CF	French Door Specialty Finish* Standard Trim	\$ 15,090	\$ 17,355
BBBF361CFPLT	French Door Specialty Finish* Plated Trim*	\$ 16,685	\$ 19,190
BBBF361CC	French Door Custom Color* Standard Trim	\$ 16,290	\$ 18,735
BBBF361CCPLT	French Door Custom Color* Plated Trim*	\$ 17,885	\$ 20,570
ADDITIONAL OPTIONS:			
PAINT REFR GRILL	Painted Top Grill on Built-In Refrigerator	\$ 250	\$ 290
799338 – 36 REFR FD	90 Degree Pin Stops (*Must be specified on order*)	\$ 70	\$ 80
ACCESSORIES AVAILABLE SEPARATELY:			
799071	Plastic Ice Bin	\$ 125	\$ 145
799627	Ice Scoop	\$ 40	\$ 45
799438	Replacement Water Filter	\$ 95	\$ 110
799700	Replacement Air Filter	\$ 50	\$ 60
RSK-950128	Perimeter Trim	N/C	N/C
PLATED TRIM OPTIONS: (Includes door handle, handle ends and logo)			
Antique Brass, Brushed Brass, Polished Brass, Brushed Copper & Pewter			

30" COLUMN REFRIGERATOR | REFRIGERATION

BlueStar Model Number Guide:

Base Model (BIRP30R0) Right Hinge Panel Ready	Add code below for desired color (C) 190 Standard RAL (Semi-Gloss) Colors (CF) Specialty Finish (190 Matte RAL, Precious Metals & Textures) (CC) Custom Colors	Add (PLT) for Plated Trim Includes plated bezels, door handle, handle end and logo. See available options below.
---	--	---



Model Shown: BIRP30R0 with CP30RH1

FEATURES:

- Industry-leading 17.44 cu. Ft. capacity
- Available in panel-ready, stainless steel or your choice of 1,000+ colors and multiple trim options
- Flush installation
- Advanced temperature control for longer food preservation
- Extra-bright LED lighting
- Fully extending crisper drawers
- Slide-out tray that fits sheet pan
- Touch screen control with Sabbath & Shopping modes
- Iron Clad Warranty: 2 years (full), 5 years (sealed system parts & labor) and 13 years (sealed system parts)
- Unit weight: 445 lbs.

COLUMN JOINING KITS

Joining Kits (#700523) ship automatically with all freezer units. Contains a filler strip to conceal joint between refrigerator and freezer columns. Joining Kits for side by side refrigeration units sold separately.

PLATED TRIM OPTIONS:

(Includes door handle, handle ends and logo)

Antique Brass, Brushed Brass, Polished Brass, Brushed Copper & Pewter

Model	Description (* Denotes item that must be specified)	UMRP	MSRP
30" Column Refrigerator – RIGHT HINGE (See page 75 for Platinum Series Handle/Handled End Trim Options)			
BIRP30R0	Right Hinge Panel Ready	\$ 8,995	\$ 10,345
CP30RH1	Right Door Panel Stainless Steel Legacy Std Trim	\$ 995	\$ 1,145
CP30RH1PLT	Right Door Panel Stainless Steel Legacy Pltd Trim*	\$ 2,190	\$ 2,520
CP30RH1C	Right Door Panel Std RAL Color* Legacy Std Trim	\$ 2,390	\$ 2,750
CP30RH1CPLT	Right Door Panel Std RAL Color* Legacy Pltd Trim*	\$ 3,585	\$ 4,125
CP30RH1CF	Right Door Panel Spec Finish* Legacy Std Trim	\$ 2,990	\$ 3,440
CP30RH1CFPLT	Right Door Panel Spec Finish* Legacy Pltd Trim*	\$ 4,185	\$ 4,815
CP30RH1CC	Right Door Panel Custom Color* Legacy Std Trim	\$ 4,290	\$ 4,935
CP30RH1CCPLT	Right Door Panel Custom Color* Legacy Pltd Trim*	\$ 5,485	\$ 6,310
30" Column Refrigerator – LEFT HINGE (See page 75 for Platinum Series Handle/Handled End Trim Options)			
BIRP30L0	Left Hinge Panel Ready	\$ 8,995	\$ 10,345
CP30LH1	Left Door Panel Stainless Steel Legacy Std Trim	\$ 995	\$ 1,145
CP30LH1PLT	Left Door Panel Stainless Steel Legacy Pltd Trim*	\$ 2,190	\$ 2,520
CP30LH1C	Left Door Panel Std RAL Color* Legacy Std Trim	\$ 2,390	\$ 2,750
CP30LH1CPLT	Left Door Panel Std RAL Color* Legacy Pltd Trim*	\$ 3,585	\$ 4,125
CP30LH1CF	Left Door Panel Spec Finish* Legacy Std Trim	\$ 2,990	\$ 3,440
CP30LH1CFPLT	Left Door Panel Spec Finish* Legacy Pltd Trim*	\$ 4,185	\$ 4,815
CP30LH1CC	Left Door Panel Custom Color* Legacy Std Trim	\$ 4,290	\$ 4,935
CP30LH1CCPLT	Left Door Panel Custom Color* Legacy Pltd Trim*	\$ 5,485	\$ 6,310
Additional Options:			
(**) Painted Toe-Kick Grills Require Painted Column Unit			
798803	Painted Toe-Kick Grill 30" **	\$ 235	\$ 270
950360	60" Continuous Toe Kick –Stainless Clad Column	\$ 910	\$ 1,045
950361	54" Continuous Toe Kick – Stainless Clad Column	\$ 880	\$ 1,010
950362	48" Continuous Toe Kick – Stainless Clad Column	\$ 880	\$ 1,010
950363	42" Continuous Toe Kick – Stainless Clad Column	\$ 855	\$ 985
950360C	60" Continuous Toe Kick – Painted**	\$ 1,145	\$ 1,315
950361C	54" Continuous Toe Kick – Painted **	\$ 1,115	\$ 1,280
950362C	48" Continuous Toe Kick – Painted **	\$ 1,115	\$ 1,280
950363C	42" Continuous Toe Kick – Painted **	\$ 1,090	\$ 1,255
700523	Column Joining Kit (Required for two column units to be joined – ships automatically with all freezer units)	\$ 160	\$ 185
700622	Toe Kick Filler Piece Only (Ships automatically with Column Joining Kit (#700523))	\$ 55	\$ 65
700588	90 Degree Pin Right Door Hinges **	\$ 225 ea	\$ 260 ea
700589	90 Degree Pin Left Door Hinges **	\$ 675 ea	\$ 775 ea
** 90 Degree Pins must be specified at time of order. They can not be added after installation.			

24" COLUMN REFRIGERATOR | REFRIGERATION

BlueStar Model Number Guide:		
Base Model (BIRP24R0) Right Hinge Panel Ready	Add code below for desired color (C) 190 Standard RAL (Semi-Gloss) Colors (CF) Specialty Finish (190 Matte RAL, Precious Metals & Textures) (CC) Custom Colors	Add (PLT) for Plated Trim Includes plated bezels, door handle, handle end and logo. See available options below.



Model Shown: BIRP24R0 with CP24RH1

FEATURES:

- Over-sized 12.99 cu. ft. capacity
- Available in panel-ready, stainless steel or your choice of 1,000+ colors and multiple trim options
- Flush installation
- Advanced temperature control for longer food preservation
- Extra-bright LED lighting
- Fully extending crisper drawers
- Slide-out tray that fits sheet pan
- Touch screen control with Sabbath & Shopping modes
- Iron Clad Warranty: 2 years (full), 5 years (sealed system parts & labor) and 13 years (sealed system parts)
- Unit weight: 364 lbs.

COLUMN JOINING KITS

Joining Kits (#700523) ship automatically with all freezer units. Contains a filler strip to conceal joint between refrigerator and freezer columns. Joining Kits for side by side refrigeration units sold separately.

PLATED TRIM OPTIONS:

(Includes door handle, handle ends and logo)

Antique Brass, Brushed Brass, Polished Brass, Brushed Copper & Pewter

Model	Description (* Denotes item that must be specified)	UMRP	MSRP
24" Column Refrigerator – RIGHT HINGE (See page 75 for Platinum Series Handle/Handled End Trim Options)			
BIRP24R0	Right Hinge Panel Ready	\$ 8,595	\$ 9,885
CP24RH1	Right Door Panel Stainless Steel Legacy Std Trim	\$ 795	\$ 915
CP24RH1PLT	Right Door Panel Stainless Steel Legacy Pltd Trim*	\$ 1,990	\$ 2,290
CP24RH1C	Right Door Panel Std RAL Color* Legacy Std Trim	\$ 1,890	\$ 2,175
CP24RH1CPLT	Right Door Panel Std RAL Color* Legacy Pltd Trim*	\$ 3,085	\$ 3,550
CP24RH1CF	Right Door Panel Spec Finish* Legacy Std Trim	\$ 2,390	\$ 2,750
CP24RH1CFPLT	Right Door Panel Spec Finish* Legacy Pltd Trim*	\$ 3,585	\$ 4,125
CP24RH1CC	Right Door Panel Custom Color* Legacy Std Trim	\$ 3,690	\$ 4,245
CP24RH1CCPLT	Right Door Panel Custom Color* Legacy Pltd Trim*	\$ 4,885	\$ 5,620
24" Column Refrigerator – LEFT HINGE (See page 75 for Platinum Series Handle/Handled End Trim Options)			
BIRP24L0	Left Hinge Panel Ready	\$ 8,595	\$ 9,885
CP24LH1	Left Door Panel Stainless Steel Legacy Std Trim	\$ 795	\$ 915
CP24LH1PLT	Left Door Panel Stainless Steel Legacy Pltd Trim*	\$ 1,990	\$ 2,290
CP24LH1C	Left Door Panel Std RAL Color* Legacy Std Trim	\$ 1,890	\$ 2,175
CP24LH1CPLT	Left Door Panel Std RAL Color* Legacy Pltd Trim*	\$ 3,085	\$ 3,550
CP24LH1CF	Left Door Panel Spec Finish* Legacy Std Trim	\$ 2,390	\$ 2,750
CP24LH1CFPLT	Left Door Panel Spec Finish* Legacy Pltd Trim*	\$ 3,585	\$ 4,125
CP24LH1CC	Left Door Panel Custom Color* Legacy Std Trim	\$ 3,690	\$ 4,245
CP24LHCCPLT	Left Door Panel Custom Color* Legacy Pltd Trim*	\$ 4,885	\$ 5,620
Additional Options:			
798804	Painted Toe-Kick Grill 24" (Note: Requires painted column unit)	\$ 235	\$ 270
950360	60" Continuous Toe Kick – Stainless Clad Column	\$ 910	\$ 1,045
950361	54" Continuous Toe Kick – Stainless Clad Column	\$ 880	\$ 1,010
950362	48" Continuous Toe Kick – Stainless Clad Column	\$ 880	\$ 1,010
950363	42" Continuous Toe Kick – Stainless Clad Column	\$ 855	\$ 985
950360C	60" Continuous Toe Kick – Painted**	\$ 1,145	\$ 1,315
950361C	54" Continuous Toe Kick – Painted **	\$ 1,115	\$ 1,280
950362C	48" Continuous Toe Kick – Painted **	\$ 1,115	\$ 1,280
950363C	42" Continuous Toe Kick – Painted **	\$ 1,090	\$ 1,255
700523	Column Joining Kit (Required for two column units to be joined – ships automatically with all freezer units)	\$ 160	\$ 185
700622	Toe Kick Filler Piece Only (Ships automatically with Column Joining Kit (#700523))	\$ 55	\$ 65
700588	90 Degree Pin Right Door Hinges **	\$ 415	\$ 475
700589	90 Degree Pin Left Door Hinges **	\$ 415	\$ 475
** 90 Degree Pins must be specified at time of order. They can not be added after installation.			

30" COLUMN FREEZER | REFRIGERATION

BlueStar Model Number Guide:

Base Model (BIFP30R0) Right Hinge Panel Ready	Add code below for desired color (C) 190 Standard RAL (Semi-Gloss) Colors (CF) Specialty Finish (190 Matte RAL, Precious Metals & Textures) (CC) Custom Colors	Add (PLT) for Plated Trim Includes plated bezels, door handle, handle end and logo. See available options below.
---	--	---



Model Shown: BIFP30R0 with CP30RH1

FEATURES:

- Industry-leading 16.84 cu. Ft. capacity
- Available in panel-ready, stainless steel or your choice of 1,000+ colors and multiple trim options
- Flush installation
- Automatic ice maker with Super Ice function
- Extra-bright LED lighting
- Full extension drawers
- Easy-to-use touch control panel
- Iron Clad Warranty: 2 years (full), 5 years (sealed system parts & labor) and 13 years (sealed system parts)
- Unit weight: 445 lbs.

COLUMN JOINING KITS

Joining Kits (#700523) ship automatically with all freezer units. Contains a filler strip to conceal joint between refrigerator and freezer columns. Joining Kits for side by side refrigeration units sold separately.

PLATED TRIM OPTIONS:

(Includes door handle, handle ends and logo)

Antique Brass, Brushed Brass, Polished Brass, Brushed Copper & Pewter

Model	Description (* Denotes item that must be specified)	UMRP	MSRP
30" Column Freezer – RIGHT HINGE (See page 75 for Platinum Series Handle/Handled End Trim Options)			
BIFP30R0	Right Hinge Panel Ready	\$ 8,995	\$ 10,345
CP30RH1	Right Door Panel Stainless Steel Legacy Std Trim	\$ 995	\$ 1,145
CP30RH1PLT	Right Door Panel Stainless Steel Legacy Pltd Trim*	\$ 2,190	\$ 2,520
CP30RH1C	Right Door Panel Std RAL Color* Legacy Std Trim	\$ 2,390	\$ 2,750
CP30RH1CPLT	Right Door Panel Std RAL Color* Legacy Pltd Trim*	\$ 3,585	\$ 4,125
CP30RH1CF	Right Door Panel Spec Finish* Legacy Std Trim	\$ 2,990	\$ 3,440
CP30RH1CFPLT	Right Door Panel Spec Finish* Legacy Pltd Trim*	\$ 4,185	\$ 4,815
CP30RH1CC	Right Door Panel Custom Color* Legacy Std Trim	\$ 4,290	\$ 4,935
CP30RH1CCPLT	Right Door Panel Custom Color* Legacy Pltd Trim*	\$ 5,485	\$ 6,310
30" Column Freezer – LEFT HINGE (See page 75 for Platinum Series Handle/Handled End Trim Options)			
BIFP30L0	Left Hinge Panel Ready	\$ 8,995	\$ 10,345
CP30LH1	Left Door Panel Stainless Steel Legacy Std Trim	\$ 995	\$ 1,145
CP30LH1PLT	Left Door Panel Stainless Steel Legacy Pltd Trim*	\$ 2,190	\$ 2,520
CP30LH1C	Left Door Panel Std RAL Color* Legacy Std Trim	\$ 2,390	\$ 2,750
CP30LH1CPLT	Left Door Panel Std RAL Color* Legacy Pltd Trim*	\$ 3,585	\$ 4,125
CP30LH1CF	Left Door Panel Spec Finish* Legacy Std Trim	\$ 2,990	\$ 3,440
CP30LH1CFPLT	Left Door Panel Spec Finish* Legacy Pltd Trim*	\$ 4,185	\$ 4,815
CP30LH1CC	Left Door Panel Custom Color* Legacy Std Trim	\$ 4,290	\$ 4,935
CP30LH1CCPLT	Left Door Panel Custom Color* Legacy Pltd Trim*	\$ 5,485	\$ 6,310
Additional Options:			
798803	Painted Toe-Kick Grill 30" (Note: Requires painted column unit)	\$ 235	\$ 270
950360	60" Continuous Toe Kick –Stainless Clad Column	\$ 910	\$ 1,045
950361	54" Continuous Toe Kick – Stainless Clad Column	\$ 880	\$ 1,010
950362	48" Continuous Toe Kick – Stainless Clad Column	\$ 880	\$ 1,010
950363	42" Continuous Toe Kick – Stainless Clad Column	\$ 855	\$ 985
950360C	60" Continuous Toe Kick – Painted**	\$ 1,145	\$ 1,315
950361C	54" Continuous Toe Kick – Painted **	\$ 1,115	\$ 1,280
950362C	48" Continuous Toe Kick – Painted **	\$ 1,115	\$ 1,280
950363C	42" Continuous Toe Kick – Painted **	\$ 1,090	\$ 1,255
700523	Column Joining Kit (Required for two column units to be joined – ships automatically with all freezer units)	\$ 160	\$ 185
700622	Toe Kick Filler Piece Only (Ships automatically with Column Joining Kit (#700523))	\$ 55	\$ 65
700588	90 Degree Pin Right Door Hinges **	\$ 415	\$ 475
700589	90 Degree Pin Left Door Hinges **	\$ 415	\$ 475
** 90 Degree Pins must be specified at time of order. They can not be added after installation.			

24" COLUMN FREEZER | REFRIGERATION

BlueStar Model Number Guide:		
Base Model (BIFP24R0) Right Hinge Panel Ready	Add code below for desired color (C) 190 Standard RAL (Semi-Gloss) Colors (CF) Specialty Finish (190 Matte RAL, Precious Metals & Textures) (CC) Custom Colors	Add (PLT) for Plated Trim Includes plated bezels, door handle, handle end and logo. See available options below.



Model Shown: BIFP24R0 with CP24RH1

FEATURES:

- Over-sized 12.64 cu. ft. capacity
- Available in panel-ready, stainless steel or your choice of 1,000+ colors and multiple trim options
- Flush installation
- Automatic ice maker with Super Ice function
- Extra-bright LED lighting
- Full extension drawers
- Easy-to-use touch control panel
- Iron Clad Warranty: 2 years (full), 5 years (sealed system parts & labor) and 13 years (sealed system parts)
- Unit weight: 364 lbs.

COLUMN JOINING KITS

Joining Kits (#700523) ship automatically with all freezer units. Contains a filler strip to conceal joint between refrigerator and freezer columns. Joining Kits for side by side refrigeration units sold separately.

PLATED TRIM OPTIONS:

(Includes door handle, handle ends and logo)
 Antique Brass, Brushed Brass, Polished Brass, Brushed Copper & Pewter

Model	Description (* Denotes item that must be specified)	UMRP	MSRP
24" Column Freezer – RIGHT HINGE (See page 75 for Platinum Series Handle/Handled End Trim Options)			
BIFP24R0	Right Hinge Panel Ready	\$ 8,595	\$ 9,885
CP24RH1	Right Door Panel Stainless Steel Legacy Std Trim	\$ 795	\$ 915
CP24RH1PLT	Right Door Panel Stainless Steel Legacy Pltd Trim*	\$ 1,990	\$ 2,290
CP24RH1C	Right Door Panel Std RAL Color* Legacy Std Trim	\$ 1,890	\$ 2,175
CP24RH1CPLT	Right Door Panel Std RAL Color* Legacy Pltd Trim*	\$ 3,085	\$ 3,550
CP24RH1CF	Right Door Panel Spec Finish* Legacy Std Trim	\$ 2,390	\$ 2,750
CP24RH1CFPLT	Right Door Panel Spec Finish* Legacy Pltd Trim*	\$ 3,585	\$ 4,125
CP24RH1CC	Right Door Panel Custom Color* Legacy Std Trim	\$ 3,690	\$ 4,245
CP24RH1CCPLT	Right Door Panel Custom Color* Legacy Pltd Trim*	\$ 4,885	\$ 5,620
24" Column Freezer – LEFT HINGE (See page 75 for Platinum Series Handle/Handled End Trim Options)			
BIFP24L0	Left Hinge Panel Ready	\$ 8,595	\$ 9,885
CP24LH1	Left Door Panel Stainless Steel Legacy Std Trim	\$ 795	\$ 915
CP24LH1PLT	Left Door Panel Stainless Steel Legacy Pltd Trim*	\$ 1,990	\$ 2,290
CP24LH1C	Left Door Panel Std RAL Color* Legacy Std Trim	\$ 1,890	\$ 2,175
CP24LH1CPLT	Left Door Panel Std RAL Color* Legacy Pltd Trim*	\$ 3,085	\$ 3,550
CP24LH1CF	Left Door Panel Spec Finish* Legacy Std Trim	\$ 2,390	\$ 2,750
CP24LH1CFPLT	Left Door Panel Spec Finish* Legacy Pltd Trim*	\$ 3,585	\$ 4,125
CP24LH1CC	Left Door Panel Custom Color* Legacy Std Trim	\$ 3,690	\$ 4,245
CP24LHCCPLT	Left Door Panel Custom Color* Legacy Pltd Trim*	\$ 4,885	\$ 5,620
Additional Options:			
798804	Painted Toe-Kick Grill 24" (Note: Requires painted column unit)	\$ 235	\$ 270
950360	60" Continuous Toe Kick – Stainless Clad Column	\$ 910	\$ 1,045
950361	54" Continuous Toe Kick – Stainless Clad Column	\$ 880	\$ 1,010
950362	48" Continuous Toe Kick – Stainless Clad Column	\$ 880	\$ 1,010
950363	42" Continuous Toe Kick – Stainless Clad Column	\$ 855	\$ 985
950360C	60" Continuous Toe Kick – Painted**	\$ 1,145	\$ 1,315
950361C	54" Continuous Toe Kick – Painted **	\$ 1,115	\$ 1,280
950362C	48" Continuous Toe Kick – Painted **	\$ 1,115	\$ 1,280
950363C	42" Continuous Toe Kick – Painted **	\$ 1,090	\$ 1,255
700523	Column Joining Kit (Required for two column units to be joined – ships automatically with all freezer units)	\$ 160	\$ 185
700622	Toe Kick Filler Piece Only (Ships automatically with Column Joining Kit (#700523))	\$ 55	\$ 65
700588	90 Degree Pin Right Door Hinges **	\$ 415	\$ 475
700589	90 Degree Pin Left Door Hinges **	\$ 415	\$ 475
** 90 Degree Pins must be specified at time of order. They can not be added after installation.			

18" COLUMN FREEZER | REFRIGERATION

BlueStar Model Number Guide:

Base Model (BIFP18R0)
Right Hinge | Panel Ready

Add code below for desired color
(C) 190 Standard RAL (Semi-Gloss) Colors
(CF) Specialty Finish (190 Matte RAL, Precious Metals & Textures)
(CC) Custom Colors

Add (PLT) for Plated Trim
Includes plated bezels, door handle, handle end and logo.
See available options below.



Model Shown: BIFP18R0 with CP18RH1

FEATURES:

- Over-sized 8.22 cu. ft. capacity
- Available in panel-ready, stainless steel or your choice of 1,000+ colors and multiple trim options
- Flush installation
- Automatic ice maker with Super Ice function
- Extra-bright LED lighting
- Full extension drawers
- Easy-to-use touch control panel
- Iron Clad Warranty: 2 years (full), 5 years (sealed system parts & labor) and 13 years (sealed system parts)
- Unit weight: 342 lbs.

COLUMN JOINING KITS

Joining Kits (#700523) ship automatically with all freezer units. Contains a filler strip to conceal joint between refrigerator and freezer columns. Joining Kits for side by side refrigeration units sold separately.

PLATED TRIM OPTIONS:

(Includes door handle, handle ends and logo)

Antique Brass, Brushed Brass, Polished Brass, Brushed Copper & Pewter

Model	Description (* Denotes item that must be specified)	UMRP	MSRP
18" Column Freezer – RIGHT HINGE (See page 75 for Platinum Series Handle/Handled End Trim Options)			
BIFP18R0	Right Hinge Panel Ready	\$ 7,995	\$ 9,195
CP18RH1	Right Door Panel Stainless Steel Legacy Std Trim	\$ 795	\$ 915
CP18RH1PLT	Right Door Panel Stainless Steel Legacy Pltd Trim*	\$ 1,990	\$ 2,290
CP18RH1C	Right Door Panel Std RAL Color* Legacy Std Trim	\$ 1,890	\$ 2,175
CP18RH1CPLT	Right Door Panel Std RAL Color* Legacy Pltd Trim*	\$ 3,085	\$ 3,550
CP18RH1CF	Right Door Panel Spec Finish* Legacy Std Trim	\$ 2,390	\$ 2,750
CP18RH1CFPLT	Right Door Panel Spec Finish* Legacy Pltd Trim*	\$ 3,585	\$ 4,125
CP18RH1CC	Right Door Panel Custom Color* Legacy Std Trim	\$ 3,690	\$ 4,245
CP18RH1CCPLT	Right Door Panel Custom Color* Legacy Pltd Trim*	\$ 4,885	\$ 5,620
18" Column Freezer – LEFT HINGE (See page 75 for Platinum Series Handle/Handled End Trim Options)			
BIFP18L0	Left Hinge Panel Ready	\$ 7,995	\$ 9,195
CP18LH1	Left Door Panel Stainless Steel Legacy Std Trim	\$ 795	\$ 915
CP18LH1PLT	Left Door Panel Stainless Steel Legacy Pltd Trim*	\$ 1,990	\$ 2,290
CP18LH1C	Left Door Panel Std RAL Color* Legacy Std Trim	\$ 1,890	\$ 2,175
CP18LH1CPLT	Left Door Panel Std RAL Color* Legacy Pltd Trim*	\$ 3,085	\$ 3,550
CP18LH1CF	Left Door Panel Spec Finish* Legacy Std Trim	\$ 2,390	\$ 2,750
CP18LH1CFPLT	Left Door Panel Spec Finish* Legacy Pltd Trim*	\$ 3,585	\$ 4,125
CP18LH1CC	Left Door Panel Custom Color* Legacy Std Trim	\$ 3,690	\$ 4,245
CP18LHCCPLT	Left Door Panel Custom Color* Legacy Pltd Trim*	\$ 4,885	\$ 5,620
Additional Options:			
798805	Painted Toe-Kick Grill 18" (Note: Requires painted column unit)	\$ 235	\$ 270
950360	60" Continuous Toe Kick – Stainless Clad Column	\$ 910	\$ 1,045
950361	54" Continuous Toe Kick – Stainless Clad Column	\$ 880	\$ 1,010
950362	48" Continuous Toe Kick – Stainless Clad Column	\$ 880	\$ 1,010
950363	42" Continuous Toe Kick – Stainless Clad Column	\$ 855	\$ 985
950360C	60" Continuous Toe Kick – Painted**	\$ 1,145	\$ 1,315
950361C	54" Continuous Toe Kick – Painted **	\$ 1,115	\$ 1,280
950362C	48" Continuous Toe Kick – Painted **	\$ 1,115	\$ 1,280
950363C	42" Continuous Toe Kick – Painted **	\$ 1,090	\$ 1,255
700523	Column Joining Kit (Required for two column units to be joined – ships automatically with all freezer units)	\$ 160	\$ 185
700622	Toe Kick Filler Piece Only (Ships automatically with Column Joining Kit (#700523))	\$ 55	\$ 65
700588	90 Degree Pin Right Door Hinges**	\$ 415	\$ 475
700589	90 Degree Pin Left Door Hinges**	\$ 415	\$ 475
** 90 Degree Pins must be specified at time of order. They can not be added after installation.			

PLATINUM SERIES TRIM OPTIONS | COLUMN REFRIGERATION/FREEZER

DOOR PANEL RIGHT HINGE PLATINUM SERIES STYLE TRIM (HANDLES/HANDLE ENDS)			
Model	Description (* Denotes item that must be specified)	UMRP	MSRP
30" Column Refrigerator & Freezer – RIGHT HINGE			
CP30RH2	Right Door Panel Stainless Steel Platinum Std	\$ 995	\$ 1,145
CP30RH2PLT	Right Door Panel Stainless Steel Platinum Plttd*	\$ 2,190	\$ 2,520
CP30RH2C	Right Door Panel Std RAL Color* Platinum Std	\$ 2,390	\$ 2,750
CP30RH2CPLT	Right Door Panel Std RAL Color* Platinum Plttd*	\$ 3,585	\$ 4,125
CP30RH2CF	Right Door Panel Spec Finish* Platinum Std	\$ 2,990	\$ 3,440
CP30RH2CFPLT	Right Door Panel Spec Finish* Platinum Plttd*	\$ 4,185	\$ 4,815
CP30RH2CC	Right Door Panel Custom Color* Platinum Std	\$ 4,290	\$ 4,935
CP30RH2CCPLT	Right Door Panel Custom Color* Platinum Plttd *	\$ 5,485	\$ 6,310
24" Column Refrigerator & Freezer – RIGHT HINGE			
CP24RH2	Right Door Panel Stainless Steel Platinum Std	\$ 795	\$ 915
CP24RH2PLT	Right Door Panel Stainless Steel Platinum Plttd*	\$ 1,990	\$ 2,290
CP24RH2C	Right Door Panel Std RAL Color* Platinum Std	\$ 1,890	\$ 2,175
CP24RH2CPLT	Right Door Panel Std RAL Color* Platinum Plttd*	\$ 3,085	\$ 3,550
CP24RH2CF	Right Door Panel Spec Finish* Platinum Std	\$ 2,390	\$ 2,750
CP24RH2CFPLT	Right Door Panel Spec Finish* Platinum Plttd*	\$ 3,585	\$ 4,125
CP24RH2CC	Right Door Panel Custom Color* Platinum Std	\$ 3,690	\$ 4,245
CP24RH2CCPLT	Right Door Panel Custom Color* Platinum Plttd *	\$ 4,885	\$ 5,620
18" Column Freezer – RIGHT HINGE			
CP18RH2	Right Door Panel Stainless Steel Platinum Std	\$ 795	\$ 915
CP18RH2PLT	Right Door Panel Stainless Steel Platinum Plttd*	\$ 1,990	\$ 2,290
CP18RH2C	Right Door Panel Std RAL Color* Platinum Std	\$ 1,890	\$ 2,175
CP18RH2CPLT	Right Door Panel Std RAL Color* Platinum Plttd*	\$ 3,085	\$ 3,550
CP18RH2CF	Right Door Panel Spec Finish* Platinum Std	\$ 2,390	\$ 2,750
CP18RH2CFPLT	Right Door Panel Spec Finish* Platinum Plttd*	\$ 3,585	\$ 4,125
CP18RH2CC	Right Door Panel Custom Color* Platinum Std	\$ 3,690	\$ 4,245
CP18RH2CCPLT	Right Door Panel Custom Color* Platinum Plttd *	\$ 4,885	\$ 5,620

DOOR PANEL LEFT HINGE PLATINUM SERIES STYLE TRIM (HANDLES/HANDLE ENDS)			
Model	Description (* Denotes item that must be specified)	UMRP	MSRP
30" Column Refrigerator & Freezer – LEFT HINGE			
CP30LH2	Left Door Panel Stainless Steel Platinum Std	\$ 995	\$ 1,145
CP30LH2PLT	Left Door Panel Stainless Steel Platinum Plttd*	\$ 2,190	\$ 2,520
CP30LH2C	Left Door Panel Std RAL Color* Platinum Std	\$ 2,390	\$ 2,750
CP30LH2CPLT	Left Door Panel Std RAL Color* Platinum Plttd*	\$ 3,585	\$ 4,125
CP30LH2CF	Left Door Panel Spec Finish* Platinum Std	\$ 2,990	\$ 3,440
CP30LH2CFPLT	Left Door Panel Spec Finish* Platinum Plttd*	\$ 4,185	\$ 4,815
CP30LH2CC	Left Door Panel Custom Color* Platinum Std	\$ 4,290	\$ 4,935
CP30LH2CCPLT	Left Door Panel Custom Color* Platinum Plttd*	\$ 5,485	\$ 6,310
24" Column Refrigerator & Freezer – LEFT HINGE			
CP24LH2	Left Door Panel Stainless Steel Platinum Std	\$ 795	\$ 915
CP24LH2PLT	Left Door Panel Stainless Steel Platinum Plttd*	\$ 1,990	\$ 2,290
CP24LH2C	Left Door Panel Std RAL Color* Platinum Std	\$ 1,890	\$ 2,175
CP24LH2CPLT	Left Door Panel Std RAL Color* Platinum Plttd*	\$ 3,085	\$ 3,550
CP24LH2CF	Left Door Panel Spec Finish* Platinum Std	\$ 2,390	\$ 2,750
CP24LH2CFPLT	Left Door Panel Spec Finish* Platinum Plttd*	\$ 3,585	\$ 4,125
CP24LH2CC	Left Door Panel Custom Color* Platinum Std	\$ 3,690	\$ 4,245
CP24LH2CCPLT	Left Door Panel Custom Color* Platinum Plttd*	\$ 4,885	\$ 5,620
18" Column Freezer – LEFT HINGE			
CP18LH2	Left Door Panel Stainless Steel Platinum Std	\$ 795	\$ 915
CP18LH2PLT	Left Door Panel Stainless Steel Platinum Plttd*	\$ 1,990	\$ 2,290
CP18LH2C	Left Door Panel Std RAL Color* Platinum Std	\$ 1,890	\$ 2,175
CP18LH2CPLT	Left Door Panel Std RAL Color* Platinum Plttd*	\$ 3,085	\$ 3,550
CP18LH2CF	Left Door Panel Spec Finish* Platinum Std	\$ 2,390	\$ 2,750
CP18LH2CFPLT	Left Door Panel Spec Finish* Platinum Plttd*	\$ 3,585	\$ 4,125
CP18LH2CC	Left Door Panel Custom Color* Platinum Std	\$ 3,690	\$ 4,245
CP18LH2CCPLT	Left Door Panel Custom Color* Platinum Plttd*	\$ 4,885	\$ 5,620

36" COUNTER-DEPTH REFRIGERATOR/FREEZER| REFRIGERATION

BlueStar Model Number Guide:

Base Model (FBFD361) French Door Stainless Steel Finish Standard Trim	Add code below for desired color (C) 190 Standard RAL (Semi-Gloss) Colors (CF) Specialty Finish (190 Matte RAL, Precious Metals & Textures) (CC) Custom Colors	Add (PLT) for Plated Trim Includes plated bezels, door handle, handle end and logo. See available options below.
---	--	---



FEATURES:

- Counter depth with 19.9 cu-ft of capacity
- Automatic ice maker
- Large capacity drawers
- Adjustable glass shelving
- LED lighting & digital display
- Internal water dispenser
- Unmatched customization – choose from 1,000+ colors and multiple trim options
- ENERGY STAR certified
- Dual evaporator

SPECIFICATIONS:

- Stainless Dimensions: 35 3/4"W x 26 3/16"D x 69 3/4"H
- Painted Dimensions: 35 3/4"W x 26 7/8"D x 70 1/16"H
- Overall Capacity: 19.86 cu. ft.
- Refrigerator Capacity: 13.30 cu. ft.
- Freezer Capacity: 6.56 cu. ft.
- Electrical Requirements: 120v, 60Hz
- Crispers: 2
- Door Bins: 6
- Unit weight: 355 lbs.

Model	Description (* Denotes item that must be specified)	UMRP	MSRP
36" Freestanding Counter-Depth Refrigerator with Freezer			
FBFD361	Freestanding Stainless Steel Standard Trim	\$ 4,295	\$ 4,940
FBFD361PLT	Freestanding Stainless Steel Plated Trim*	\$ 5,890	\$ 6,775
FBFD361PC	Freestanding Std RAL Color* Standard Trim	\$ 5,890	\$ 6,775
FBFD361PCPLT	Freestanding Std RAL Color* Plated Trim*	\$ 7,485	\$ 8,610
FBFD361PCF	Freestanding Specialty Finish* Standard Trim	\$ 6,390	\$ 7,350
FBFD361PCFPLT	Freestanding Specialty Finish* Plated Trim*	\$ 7,985	\$ 9,185
FBFD361PCC	Freestanding Custom Color* Standard Trim	\$ 7,590	\$ 8,730
FBFD361PCCPLT	Freestanding Custom Color* Plated Trim*	\$ 9,185	\$ 10,565
FBFD361PW	Freestanding Gloss White RAL 9003 Standard Trim	\$ 4,995	\$ 5,745
FBFD361PB	Freestanding Gloss Black RAL 9004 Standard Trim	\$ 4,995	\$ 5,745
FBFD361PMW	Freestanding Matte White Standard Trim	\$ 4,995	\$ 5,745
FBFD361PMB	Freestanding Matte Black Standard Trim	\$ 4,995	\$ 5,745
FBFD361PWPLT	Freestanding Gloss White RAL 9003 Brushed Brass	\$ 5,995	\$ 6,895
FBFD361PBPLT	Freestanding Gloss Black RAL 9004 Brushed Brass	\$ 5,995	\$ 6,895
FBFD361PMWPLT	Freestanding Matte White Brushed Brass	\$ 5,995	\$ 6,895
FBFD361PMBPLT	Freestanding Matte Black Brushed Brass	\$ 5,995	\$ 6,895



VENTILATION | PROFESSIONAL SERIES

Get the Look: 36" Proline Vent Hood



Choosing the Perfect Range Hood

Everything You Need to Know

1. Select a Hood Style

Classic, Modern, Contemporary, Farmhouse, choose a hood style that fits best with your overall kitchen design.

2. Select Hood Width

The hood should be the same width as the cooking appliance below it, or up to 6" wider for maximum capture area.

3. Determine the Total Hood Height

Ventilation hoods should be installed 30" - 36" above the cooktop surface. Duct covers can fill any remaining space that the hood does not. See page 83 to determine if a duct cover is needed based on your ceiling height.

4. Calculate Hood Power Needed

Hood power is based on CFMs. To determine the CFMs needed, add the total BTU's of your cooking appliance (top burners + ovens), then divide by 150.

5. Choose Blower Type

In-hood, In-line and Remote blowers are available from 600 CFMs up to 1,400 CFMs.

6. Determine Blower Location

Your hood needs to exhaust through ducting which may be determined by existing ducting or architectural plans for a new build. First decide if this will occur through the top or rear of the hood. Then, install the correct size ducting for the shortest possible distance with the least 90 degree bends possible.

7. Customize Your Kitchen

Choose from over 1,000+ colors, finishes and designer metals. Accent with unlimited strapping configurations.

DUCT COVER SELECTION GUIDE

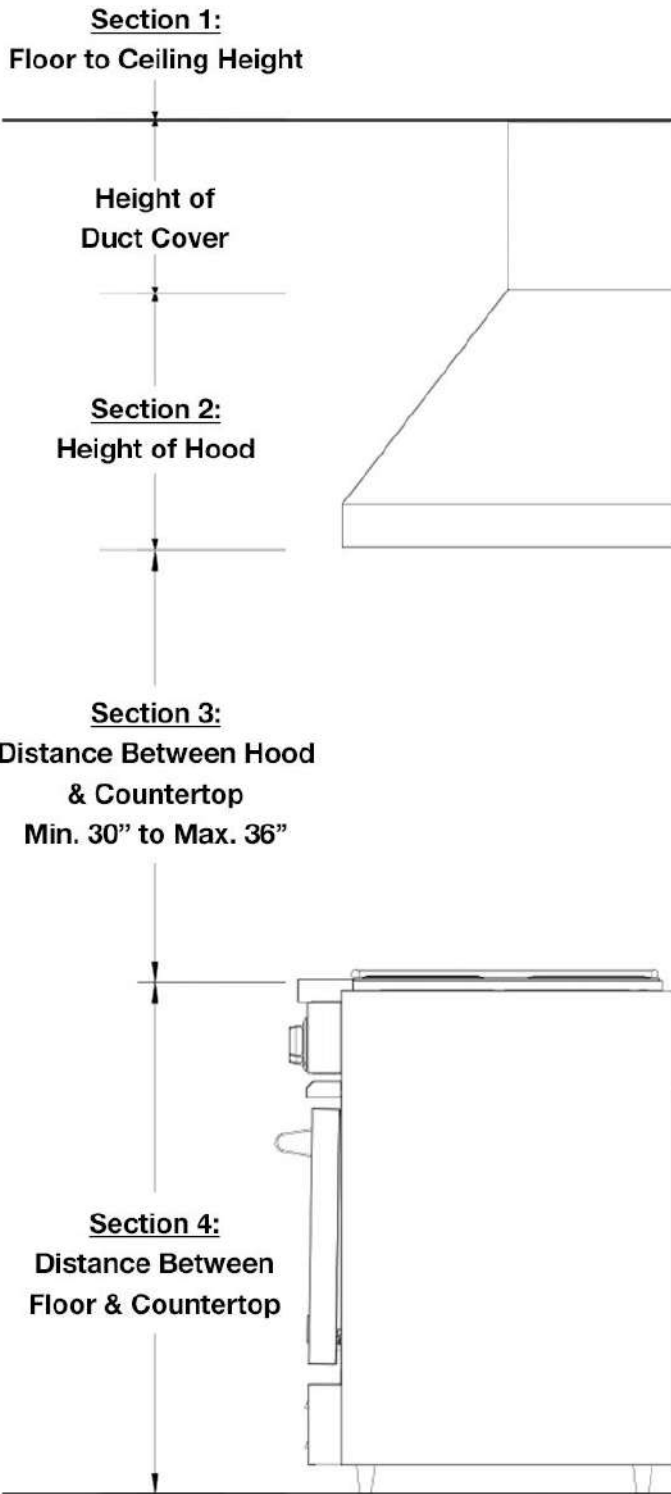

All measurements are to be calculated in inches

Section 1: Floor to Ceiling Height _____

Subtract:

Section 2: Height of Hood _____

Section 3: Distance Between Hood and Countertop _____
(30" min. to 36" max)

Section 4: Distance Between Floor and Countertop _____

Height of Duct Cover Needed: _____

* Ceiling height may be impacted by crown molding and/or soffit above the hood.
Please account for this when calculating available floor to ceiling height

Available Duct Covers:

Page 81 Proline

Page 83 Pyramid

Page 89 Manhattan (Wall Hoods)

Page 94 Bonanza

Page 97 Hampton, Sahara Curved & Ridgeline

Page 100 Wrangler

Page 102 Manhattan (Island Hoods)

PROLINE VENT HOODS | PROFESSIONAL SERIES | WALL HOODS

BlueStar Model Number Guide:

Base Model (PLOXXML) Proline Unit Width Internal Liner Type	Add code below for desired color (C) 190 Standard RAL (Semi-Gloss) Colors, (CF) Specialty Finish (190 Matte RAL, Precious Metals & Textures) or (CC) Custom Colors	Add (PLT) for Metal Strapping Not available on this model
---	--	---



Standard Height: 18" | Standard Depth: 24"

- FEATURES:**
- Professional-grade performance with three exhaust settings and new Boost feature
- Whisper quiet operation
- Heavy duty, commercial grade materials
- Dimmable LED lighting
- Easy-to-use push-button controls
- Innovative, multi-stage grease capture system
- Stainless baffle filters seamlessly remove for easy dishwasher cleaning
- Choose from stainless steel or 1,000+ colors and finishes
- Simple installation
- 30" & 36" models: 600 CFM internal fan included
(Must be included on order)
- Available with top or rear discharge - Discharge is field reversible.
- In-line, in-hood and remote blower compatible
- Note: Features on 24" models may vary

CUSTOMIZATION OPTIONS:

- 1,000+ Colors & Finishes

Model	Description (* Denotes item that must be specified)	UMRP	MSRP
PL030ML	30" Proline Stainless Steel 600 CFM Blower	\$ 2,995	\$ 3,445
PL030MLC	30" Proline Std RAL Color* 600 CFM Blower	\$ 4,090	\$ 4,705
PL030MLCF	30" Proline Specialty Finish* 600 CFM Blower	\$ 5,090	\$ 5,855
PL030MLCC	30" Proline Custom Color* 600 CFM Blower	\$ 6,590	\$ 7,580
PL036ML	36" Proline Stainless Steel 600 CFM Blower	\$ 2,995	\$ 3,445
PL036MLC	36" Proline Std RAL Color* 600 CFM Blower	\$ 4,190	\$ 4,820
PL036MLCF	36" Proline Specialty Finish* 600 CFM Blower	\$ 5,190	\$ 5,970
PL036MLCC	36" Proline Custom Color* 600 CFM Blower	\$ 6,690	\$ 7,695
PL042ML	42" Proline Stainless Steel	\$ 3,095	\$ 3,560
PL042MLC	42" Proline Std RAL Color*	\$ 4,590	\$ 5,280
PL042MLCF	42" Proline Specialty Finish*	\$ 5,690	\$ 6,545
PL042MLCC	42" Proline Custom Color*	\$ 7,090	\$ 8,155
PL048ML	48" Proline Stainless Steel	\$ 3,095	\$ 3,560
PL048MLC	48" Proline Std RAL Color*	\$ 4,690	\$ 5,395
PL048MLCF	48" Proline Specialty Finish*	\$ 5,790	\$ 6,660
PL048MLCC	48" Proline Custom Color*	\$ 7,190	\$ 8,270
PL054ML	54" Proline Stainless Steel	\$ 3,295	\$ 3,790
PL054MLC	54" Proline Std RAL Color*	\$ 4,790	\$ 5,510
PL054MLCF	54" Proline Specialty Finish*	\$ 5,890	\$ 6,775
PL054MLCC	54" Proline Custom Color*	\$ 7,290	\$ 8,385
PL060ML	60" Proline Stainless Steel	\$ 3,595	\$ 4,135
PL060MLC	60" Proline Std RAL Color*	\$ 5,090	\$ 5,855
PL060MLCF	60" Proline Specialty Finish*	\$ 6,190	\$ 7,120
PL060MLCC	60" Proline Custom Color*	\$ 7,590	\$ 8,730
PL066ML	66" Proline Stainless Steel	\$ 3,795	\$ 4,365
PL066MLC	66" Proline Std RAL Color*	\$ 5,290	\$ 6,085
PL066MLCF	66" Proline Specialty Finish*	\$ 6,390	\$ 7,350
PL066MLCC	66" Proline Custom Color*	\$ 7,790	\$ 8,960

VENTILATION HOOD ACCESSORIES:

Refer to page 81 for all Proline hood duct cover options | Refer to page 110 for Ventilation Hood Accessories

BLOWER OPTIONS	IN-HOOD		IN-LINE		REMOTE		DISCHARGE	
	600	1200	800	1200	1000	1400	TOP	REAR
CFM POWER	600	1200	800	1200	1000	1400		
MODEL #	BS-CFM-600-IN06	BS-CFM-1200-IN12	ATEX-0.8	ATEX-1.2	HYEX-1.0-GA	HYEX-1.4-GA		
MSRP	\$ 965	\$ 995	\$ 1,260	\$ 1,510	\$ 1,385	\$ 1,640		
PL030ML	•		•	•	•	•	•	Available at time of order
PL036ML	•	•	•	•	•	•	•	
PL042ML	•	•	•	•	•	•	•	
PL048ML	•	•	•	•	•	•	•	
PL054ML	•	•	•	•	•	•	•	
PL060ML	•	•	•	•	•	•	•	
PL066ML	•	•	•	•	•	•	•	

PROLINE DUCT COVERS | PROFESSIONAL SERIES

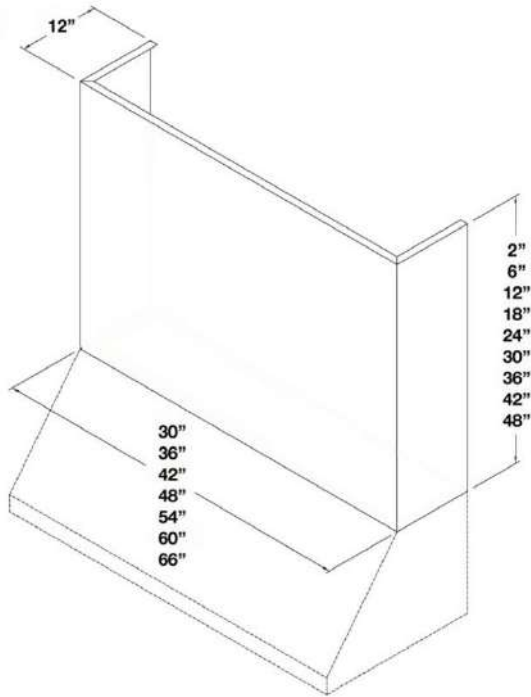

SIZE	MODEL	HEIGHT	UMRP	MSRP
Available Duct Covers for 30" Models	DCSW03002	2"	\$ 550	\$ 635
	DCSW03006	6"		
	DCSW03012	12"		
	DCSW03018	18"		
	DCSW03024	24"		
	DCSW03030	30"		
	DCSW03036	36"		
	DCSW03042	42"		
	DCSW03048	48"		
Available Duct Covers for 36" Models	DCSW03602	2"	\$ 575	\$ 660
	DCSW03606	6"		
	DCSW03612	12"		
	DCSW03618	18"		
	DCSW03624	24"		
	DCSW03630	30"		
	DCSW03636	36"		
Available Duct Covers for 42" Models	DCSW04202	2"	\$ 620	\$ 715
	DCSW04206	6"		
	DCSW04212	12"		
	DCSW04218	18"		

SIZE	MODEL	HEIGHT	UMRP	MSRP
Available Duct Covers for 42" Models	DCSW04224	24"	\$ 620	\$ 715
	DCSW04230	30"		
	DCSW04236	36"		
	DCSW04242	42"		
	DCSW04248	48"		
Available Duct Covers for 48" Models	DCSW04802	2"	\$ 690	\$ 795
	DCSW04806	6"		
	DCSW04812	12"		
	DCSW04818	18"		
	DCSW04824	24"		
	DCSW04830	30"		
	DCSW04836	36"		
	DCSW04842	42"		
DCSW04848	48"			
Available Duct Covers for 54" Models	DCSW05402	2"	\$ 715	\$ 820
	DCSW05406	6"		
	DCSW05412	12"		
	DCSW05418	18"		
	DCSW05424	24"		
	DCSW05430	30"		
	DCSW05436	36"		
Available Duct Covers for 60" Models	DCSW06002	2"	\$ 830	\$ 955
	DCSW06006	6"		
	DCSW06012	12"		
	DCSW06018	18"		
	DCSW06024	24"		
	DCSW06030	30"		
	DCSW06036	36"		
Available Duct Covers for 66" Models	DCSW06602	2"	\$ 855	\$ 985
	DCSW06606	6"		
	DCSW06612	12"		
	DCSW06618	18"		
	DCSW06624	24"		
	DCSW06630	30"		
	DCSW06636	36"		

PYRAMID VENT HOODS | PROFESSIONAL SERIES | WALL HOODS

BlueStar Model Number Guide:

Base Model (PYOXXML) Proline Unit Width Internal Liner Type	Add code below for desired color (C) 190 Standard RAL (Semi-Gloss) Colors, (CF) Specialty Finish (190 Matte RAL, Precious Metals & Textures) or (CC) Custom Colors	Add (PLT) for Metal Strapping Not available on this model
---	--	---



Standard Height without duct: 18" | Standard Depth: 24"

FEATURES:

- Professional-grade performance with three exhaust settings and new Boost feature
- Whisper quiet operation
- Heavy duty, commercial grade materials
- Dimmable LED lighting
- Easy-to-use push-button controls
- Innovative, multi-stage grease capture system
- Stainless baffle filters seamlessly remove for easy dishwasher cleaning
- Available with top or rear discharge - Discharge is field reversible.
- 30" & 36" models: 600 CFM internal fan included
(Must be included on order)
- Telescopic Duct DCTWxxS included.** Additional sizes available (Sold separately)
- In-line, in-hood and remote blower compatible

CUSTOMIZATION OPTIONS:

- 1,000+ Colors & Finishes

DUCT COVER OPTIONS: (Must be included on order)				
Hood	Model	Duct Height Range	UMRP	MSRP
30" Models	DCTW12S	Min 12" – Max 24"	N/C	N/C
	DCTW12M	Min 24" – Max 42"	\$ 895	\$ 1,030
	DCTW12T	Min 42" – Max 60"	\$ 1,495	\$ 1,720
36" – 54" Models	DCTW18S	Min 12" – Max 24"	N/C	N/C
	DCTW18M	Min 24" – Max 42"	\$ 1,095	\$ 1,260
	DCTW18T	Min 42" – Max 60"	\$ 1,595	\$ 1,835
60" – 66" Models	DCTW24S	Min 12" – Max 24"	N/C	N/C
	DCTW24M	Min 24" – Max 42"	\$ 1,250	\$ 1,440
	DCTW24T	Min 42" – Max 60"	\$ 1,695	\$ 1,950

Model	Description (* Denotes item that must be specified)	UMRP	MSRP
PY030ML	30" Pyramid Stainless Steel 600 CFM Blower	\$ 2,795	\$ 3,215
PY030MLC	30" Pyramid Std RAL Color* 600 CFM Blower	\$ 3,990	\$ 4,590
PY030MLCF	30" Pyramid Specialty Finish* 600 CFM Blower	\$ 4,990	\$ 5,740
PY030MLCC	30" Pyramid Custom Color* 600 CFM Blower	\$ 6,490	\$ 7,465
PY036ML	36" Pyramid Stainless Steel 600 CFM Blower	\$ 3,595	\$ 4,135
PY036MLC	36" Pyramid Std RAL Color* 600 CFM Blower	\$ 4,790	\$ 5,510
PY036MLCF	36" Pyramid Specialty Finish* 600 CFM Blower	\$ 5,790	\$ 6,660
PY036MLCC	36" Pyramid Custom Color* 600 CFM Blower	\$ 7,290	\$ 8,385
PY042ML	42" Pyramid Stainless Steel	\$ 3,695	\$ 4,250
PY042MLC	42" Pyramid Std RAL Color*	\$ 5,190	\$ 5,970
PY042MLCF	42" Pyramid Specialty Finish*	\$ 7,785	\$ 8,955
PY042MLCC	42" Pyramid Custom Color*	\$ 11,780	\$ 13,545
PY048ML	48" Pyramid Stainless Steel	\$ 3,795	\$ 4,365
PY048MLC	48" Pyramid Std RAL Color*	\$ 5,290	\$ 6,085
PY048MLCF	48" Pyramid Specialty Finish*	\$ 7,885	\$ 9,070
PY048MLCC	48" Pyramid Custom Color*	\$ 7,790	\$ 8,960
PY054ML	54" Pyramid Stainless Steel	\$ 3,995	\$ 4,595
PY054MLC	54" Pyramid Std RAL Color*	\$ 5,490	\$ 6,315
PY054MLCF	54" Pyramid Specialty Finish*	\$ 6,590	\$ 7,580
PY054MLCC	54" Pyramid Custom Color*	\$ 7,990	\$ 9,190
PY060ML	60" Pyramid Stainless Steel	\$ 4,595	\$ 5,285
PY060MLC	60" Pyramid Std RAL Color*	\$ 6,090	\$ 7,005
PY060MLCF	60" Pyramid Specialty Finish*	\$ 7,190	\$ 8,270
PY060MLCC	60" Pyramid Custom Color*	\$ 8,590	\$ 9,880
PY066ML	66" Pyramid Stainless Steel	\$ 4,995	\$ 5,745
PY066MLC	66" Pyramid Std RAL Color*	\$ 6,490	\$ 7,465
PY066MLCF	66" Pyramid Specialty Finish*	\$ 7,590	\$ 8,730
PY066MLCC	66" Pyramid Custom Color*	\$ 8,990	\$ 10,340

VENTILATION HOOD ACCESSORIES:

Refer to page 83 for all 1-piece Pyramid hood duct cover options | Refer to page 110 for Ventilation Hood Accessories

BLOWER OPTIONS	IN-HOOD		IN-LINE		REMOTE		DISCHARGE	
CFM POWER	600	1200	800	1200	1000	1400	TOP	REAR
MODEL #	BS-CFM-600-IN06	BS-CFM-1200-IN12	ATEX-0.8	ATEX-1.2	HYEX-1.0-GA	HYEX-1.4-GA		
MSRP	\$ 965	\$ 995	\$ 1,260	\$ 1,510	\$ 1,385	\$ 1,640	Available at time of order	
PY030ML	•	•	•	•	•	•		
PY036ML	•	•	•	•	•	•		
PY042ML	•	•	•	•	•	•		
PY048ML	•	•	•	•	•	•		
PY054ML	•	•	•	•	•	•		
PY060ML	•	•	•	•	•	•		
PY066ML	•	•	•	•	•	•		

PYRAMID (ONE-PIECE) DUCT COVERS | PROFESSIONAL SERIES

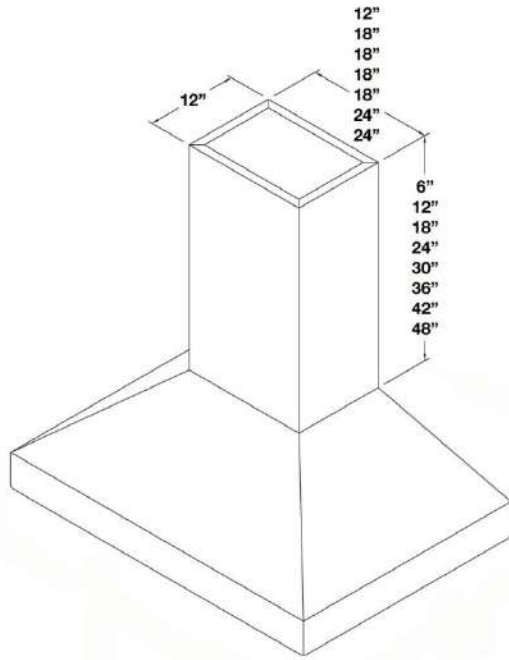

SIZE	MODEL	HEIGHT	UMRP	MSRP
Available Duct Covers for 30" Models	DCCW03006	6"	\$ 885	\$ 1,020
	DCCW03012	12"	\$ 965	\$ 1,110
	DCCW03018	18"	\$ 1,065	\$ 1,225
	DCCW03024	24"	\$ 1,160	\$ 1,335
	DCCW03030	30"	\$ 1,250	\$ 1,440
	DCCW03036	36"	\$ 1,340	\$ 1,540
	DCCW03042	42"	\$ 1,445	\$ 1,660
	DCCW03048	48"	\$ 1,525	\$ 1,755
	Available Duct Covers for 36" Models	DCCW03606	6"	\$ 885
DCCW03612		12"	\$ 965	\$ 1,110
DCCW03618		18"	\$ 1,065	\$ 1,225
DCCW03624		24"	\$ 1,160	\$ 1,335
DCCW03630		30"	\$ 1,250	\$ 1,440
DCCW03636		36"	\$ 1,340	\$ 1,540
DCCW03642		42"	\$ 1,445	\$ 1,660
DCCW03648		48"	\$ 1,525	\$ 1,755
Available Duct Covers for 42" Models		DCCW04206	6"	\$ 885
	DCCW04212	12"	\$ 965	\$ 1,110
	DCCW04218	18"	\$ 1,065	\$ 1,225
	DCCW04224	24"	\$ 1,160	\$ 1,335
	DCCW04230	30"	\$ 1,250	\$ 1,440
	DCCW04236	36"	\$ 1,340	\$ 1,540
	DCCW04242	42"	\$ 1,445	\$ 1,660
	DCCW04248	48"	\$ 1,525	\$ 1,755

SIZE	MODEL	HEIGHT	UMRP	MSRP
Available Duct Covers for 48" Models	DCCW04806	6"	\$ 885	\$ 1,020
	DCCW04812	12"	\$ 965	\$ 1,110
	DCCW04818	18"	\$ 1,065	\$ 1,225
	DCCW04824	24"	\$ 1,160	\$ 1,335
	DCCW04830	30"	\$ 1,250	\$ 1,440
	DCCW04836	36"	\$ 1,340	\$ 1,540
	DCCW04842	42"	\$ 1,445	\$ 1,660
	DCCW04848	48"	\$ 1,525	\$ 1,755
Available Duct Covers for 54" Models	DCCW05406	6"	\$ 885	\$ 1,020
	DCCW05412	12"	\$ 965	\$ 1,110
	DCCW05418	18"	\$ 1,065	\$ 1,225
	DCCW05424	24"	\$ 1,160	\$ 1,335
	DCCW05430	30"	\$ 1,250	\$ 1,440
	DCCW05436	36"	\$ 1,340	\$ 1,540
	DCCW05442	42"	\$ 1,445	\$ 1,660
	DCCW05448	48"	\$ 1,525	\$ 1,755
Available Duct Covers for 60" Models	DCCW06006	6"	\$ 885	\$ 1,020
	DCCW06012	12"	\$ 965	\$ 1,110
	DCCW06018	18"	\$ 1,065	\$ 1,225
	DCCW06024	24"	\$ 1,160	\$ 1,335
	DCCW06030	30"	\$ 1,250	\$ 1,440
	DCCW06036	36"	\$ 1,340	\$ 1,540
	DCCW06042	42"	\$ 1,445	\$ 1,660
	DCCW06048	48"	\$ 1,525	\$ 1,755
	Available Duct Covers for 66" Models	DCCW06606	6"	\$ 885
DCCW06612		12"	\$ 965	\$ 1,110
DCCW06618		18"	\$ 1,065	\$ 1,225
DCCW06624		24"	\$ 1,160	\$ 1,335
DCCW06630		30"	\$ 1,250	\$ 1,440
DCCW06636		36"	\$ 1,340	\$ 1,540
DCCW06642		42"	\$ 1,445	\$ 1,660
DCCW06648		48"	\$ 1,525	\$ 1,755

LOW PROFILE VENT HOODS | PROFESSIONAL SERIES | WALL HOODS

BlueStar Model Number Guide:

Base Model (LPOXXLP) Low Profile Unit Width Internal Liner Type	Add code below for desired color (C) 190 Standard RAL (Semi-Gloss) Colors, (CF) Specialty Finish (190 Matte RAL, Precious Metals & Textures) or (CC) Custom Colors	Add (PLT) for Metal Strapping Not available on this model
---	--	---



Standard Height: 10" | Standard Depth: 24"

FEATURES:

- Commercial grade stainless steel construction
- 600 CFM internal fan included (Only blower option available for this model)
- Welded seamless corners
- Dishwasher safe stainless steel baffles
- 3-speed blower/variable light control

CUSTOMIZATION OPTIONS:

- 1,000+ Colors & Finishes

Model	Description (* Denotes item that must be specified)	UMRP	MSRP
LP030LP	30" Low Profile Stainless Steel 600 CFM Blower	\$ 2,095	\$ 2,410
LP030LPC	30" Low Profile Std RAL Color* 600 CFM Blower	\$ 3,290	\$ 3,785
LP030LPCF	30" Low Profile Specialty Finish* 600 CFM Blower	\$ 4,290	\$ 4,935
LP030LPCC	30" Low Profile Custom Color* 600 CFM Blower	\$ 5,790	\$ 6,660
LP036LP	36" Low Profile Stainless Steel 600 CFM Blower	\$ 2,295	\$ 2,640
LP036LPC	36" Low Profile Std RAL Color* 600 CFM Blower	\$ 3,490	\$ 4,015
LP036LPCF	36" Low Profile Specialty Finish* 600 CFM Blower	\$ 4,490	\$ 5,165
LP036LPCC	36" Low Profile Custom Color* 600 CFM Blower	\$ 5,990	\$ 6,890

METAL LINERS | PROFESSIONAL SERIES | WALL HOODS

BlueStar Model Number Guide:		
Base Model (PYOXXML) Liner Insert Model Unit Width Internal Liner Type	Add code below for desired color Not available on this model	Add (PLT) for Metal Strapping Not available on this model



Model	Description (* Denotes item that must be specified)	UMRP	MSRP
PM028ML	28" Metal Liner 600 CFM Blower 26 5/8" x 22 1/8" x 16 1/4"	\$ 1,650	\$ 1,895
PM034ML	34" Metal Liner 600 CFM Blower 33 5/8" x 22 1/8" x 16 1/4"	\$ 1,650	\$ 1,895
PM040ML	40" Metal Liner 39 5/8" x 22 1/8" x 16 1/4"	\$ 1,650	\$ 1,895
PM046ML	46" Metal Liner 45 7/16" x 22 1/8" x 16 1/4"	\$ 1,850	\$ 2,130
PM052ML	52" Metal Liner 51 7/16" x 22 1/8" x 16 1/4"	\$ 1,850	\$ 2,130
PM058ML	58" Metal Liner 57 1/4" x 22 1/8" x 16 1/4"	\$ 1,850	\$ 2,130
PM064ML	64" Metal Liner 63 1/4" x 22 1/8" x 16 1/4"	\$ 2,095	\$ 2,410
PM070ML	70" Metal Liner 67 1/4" x 22 1/8" x 16 1/4"	\$ 2,395	\$ 2,755

Refer to page 110 for Ventilation Hood Accessories

FEATURES:

- Professional-grade performance with three exhaust settings and new Boost feature
- Whisper quiet operation
- Heavy duty, commercial grade materials
- Dimmable LED lighting
- Easy-to-use push-button controls
- Innovative, multi-stage grease capture system
- Stainless baffle filters seamlessly remove for easy dishwasher cleaning
- Simple installation
- 28" & 34" models: 600 CFM internal fan included
(Must be included on order)
- Available with top or rear discharge - Discharge is field reversible.
- In-line, in-hood and remote blower compatible

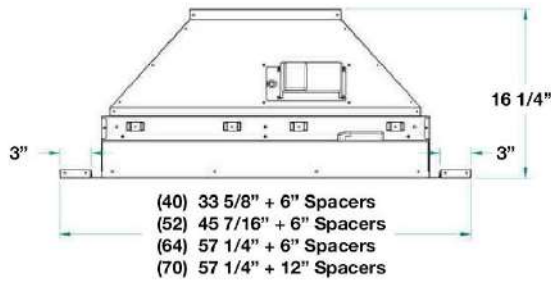
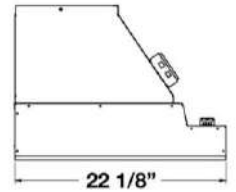
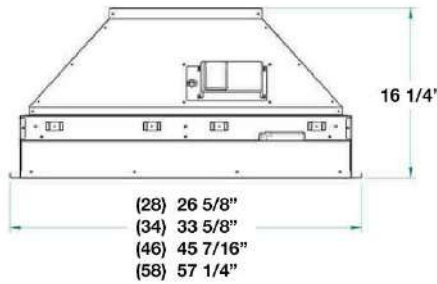

BLOWER OPTIONS	IN-HOOD		IN-LINE		REMOTE		DISCHARGE	
CFM POWER	600	1200	800	1200	1000	1400	TOP	REAR
MODEL #	BS-CFM-600-IN06	BS-CFM-1200-IN12	ATEX-0.8	ATEX-1.2	HYEX-1.0-GA	HYEX-1.4-GA		
UMRP	\$ 965	\$ 995	\$ 1,260	\$ 1,510	\$ 1,385	\$ 1,640	Available at time of order	
28" Liners	•		•	•	•	•		
34" Liners	•	•	•	•	•	•		
40" Liners	•	•	•	•	•	•		
46" Liners	•	•	•	•	•	•		
52" Liners	•	•	•	•	•	•		
58" Liners	•	•	•	•	•	•		
64" Liners	•	•	•	•	•	•		
70" Liners	•	•	•	•	•	•		



VENTILATION | DESIGNER SERIES

Get the Look: 60" Atlas Vent Hood in Matte Black with Brushed Brass Trim

CUSTOMIZATION OPTIONS | DESIGNER SERIES



1,000 + COLORS & FINISHES

BlueStar appliances are available in a painter's palette of colors and finishes. Select from 1,000+ colors plus matte and textured finishes to turn up the heat on discerning kitchen design.

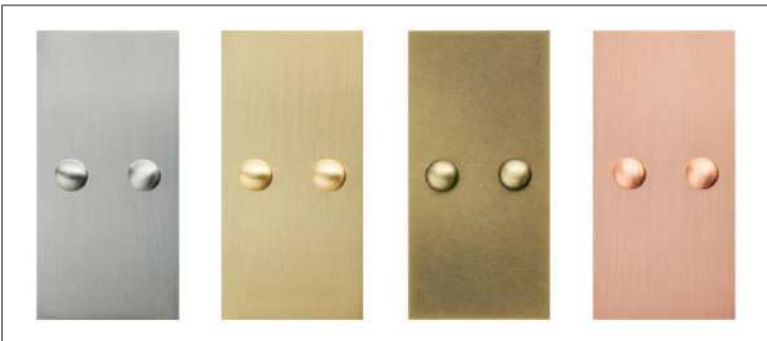

DESIGNER METALS

Outfit your hood in our collection of Designer Metal finishes like brushed brass, polished brass and brushed copper. Add these luxury finishes to create a kitchen hood worthy of your personal signature and style.



CUSTOM STRAPPING & RIVETS

Customize your ventilation hood with one of our standard strapping layouts or choose your own. All strapping is available in the Designer Metals above or painted in one of our standard 190 RAL colors.

Request a quote from our ventilation team at quote@bluestarcooking.com



CUSTOM SIZES

Customize the height or depth of your ventilation hood to accommodate your unique kitchen design. Request a quote from our ventilation team at quote@bluestarcooking.com

BlueStar Model Number Guide:

Base Model (MH0XXMA) Manhattan Unit Width Internal Liner Type	Add code below for desired color (C) 190 Standard RAL (Semi-Gloss) Colors, (CF) Specialty Finish (190 Matte RAL, Precious Metals & Textures) or (CC) Custom Colors	Add (PLT) for Metal Strapping Available through custom quote only at quote@bluestarcooking.com
---	--	---

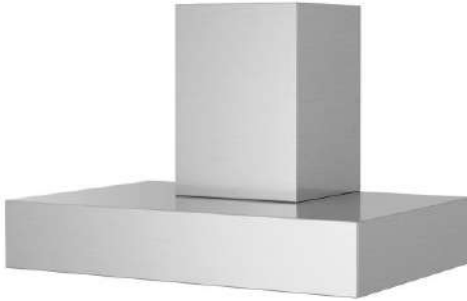

Standard Height: 6 1/4" | Standard Depth: 24"

FEATURES:

- Professional-grade performance with three exhaust settings and new Boost feature
- Whisper quiet operation
- Heavy duty, commercial grade materials
- Dimmable LED lighting
- Easy-to-use push-button controls
- Innovative, multi-stage grease capture system
- Stainless baffle filters seamlessly remove for easy dishwasher cleaning
- Choose from stainless steel or 1,000+ colors and finishes
- Simple installation
- 30" & 36" models: 600 CFM internal fan included *(Must be included on order)*
- Accommodates top discharge only
- Included duct cover heights: 18", 24", 30" & 36" *(Must be specified on order.)*
- In-line, in-hood and remote blower compatible

CUSTOMIZATION OPTIONS:

- 1,000+ Colors & Finishes
- Designer Metals: Brushed Brass, Antique Brass, Polished Brass, Brushed Copper, Pewter & Polished Stainless Steel
- Custom strapping & rivets
- Full custom options

() Trim finishes on Cooking & Refrigeration products are different substrates than the trim finishes on Ventilation hoods. Due to these differing processes and substrates the finishes will coordinate but may not match exactly.*

NOTE: HOOD MUST BE MOUNTED TO CEILING AND CEILING ACCESS MAY BE REQUIRED. PLEASE REFERENCE THE INSTALLATION MANUAL ON BLUESTARCOOKING.COM FOR DETAILS

NOTE: MUST ORDER DUCT COVER FOR BLOWER & MOUNTING PURPOSES. MINIMUM 18" HIGH

Model	Description (* Denotes item that must be specified)	UMRP	MSRP
MH030MA	30" Manhattan Stainless Steel 600 CFM Blower	\$ 2,995	\$ 3,445
MH030MAC	30" Manhattan Std RAL Color* 600 CFM Blower	\$ 4,190	\$ 4,820
MH030MACF	30" Manhattan Specialty Finish* 600 CFM Blower	\$ 5,190	\$ 5,970
MH030MACC	30" Manhattan Custom Color* 600 CFM Blower	\$ 6,690	\$ 7,695
MH036MA	36" Manhattan Stainless Steel 600 CFM Blower	\$ 3,495	\$ 4,020
MH036MAC	36" Manhattan Std RAL Color* 600 CFM Blower	\$ 4,690	\$ 5,395
MH036MACF	36" Manhattan Specialty Finish* 600 CFM Blower	\$ 5,690	\$ 6,545
MH036MACC	36" Manhattan Custom Color* 600 CFM Blower	\$ 7,190	\$ 8,270
MH042MA	42" Manhattan Stainless Steel	\$ 3,795	\$ 4,365
MH042MAC	42" Manhattan Std RAL Color*	\$ 5,290	\$ 6,085
MH042MACF	42" Manhattan Specialty Finish*	\$ 6,390	\$ 7,350
MH042MACC	42" Manhattan Custom Color*	\$ 7,790	\$ 8,960
MH048MA	48" Manhattan Stainless Steel	\$ 3,995	\$ 4,595
MH048MAC	48" Manhattan Std RAL Color*	\$ 5,490	\$ 6,315
MH048MACF	48" Manhattan Specialty Finish*	\$ 6,590	\$ 7,580
MH048MACC	48" Manhattan Custom Color*	\$ 7,990	\$ 9,190
MH054MA	54" Manhattan Stainless Steel	\$ 5,195	\$ 5,975
MH054MAC	54" Manhattan Std RAL Color*	\$ 6,690	\$ 7,695
MH054MACF	54" Manhattan Specialty Finish*	\$ 7,790	\$ 8,960
MH054MACC	54" Manhattan Custom Color*	\$ 9,190	\$ 10,570
MH060MA	60" Manhattan Stainless Steel	\$ 5,595	\$ 6,435
MH060MAC	60" Manhattan Std RAL Color*	\$ 7,090	\$ 8,155
MH060MACF	60" Manhattan Specialty Finish*	\$ 8,190	\$ 9,420
MH060MACC	60" Manhattan Custom Color*	\$ 9,590	\$ 11,030
MH066MA	66" Manhattan Stainless Steel	\$ 5,695	\$ 6,550
MH066MAC	66" Manhattan Std RAL Color*	\$ 7,190	\$ 8,270
MH066MACF	66" Manhattan Specialty Finish*	\$ 8,290	\$ 9,535
MH066MACC	66" Manhattan Custom Color*	\$ 9,690	\$ 11,145

DUCT COVERS FOR MANHATTAN HOODS:

Refer to page 89 for all Manhattan hood duct cover options | Refer to page 110 for Ventilation Hood Accessories
• Included duct cover heights: 18", 24", 30" & 36" | Also available in 42" & 48" for additional charge

BLOWER OPTIONS	IN-HOOD		IN-LINE		REMOTE		DISCHARGE	
	600	1200	800	1200	1000	1400	TOP	REAR
CFM POWER	600	1200	800	1200	1000	1400		
MODEL #	BS-CFM-600-IN06	BS-CFM-1200-IN12	ATEX-0.8	ATEX-1.2	HYEX-1.0-GA	HYEX-1.4-GA		
UMRP	\$ 965	\$ 995	\$ 1,260	\$ 1,510	\$ 1,385	\$ 1,640		
MH030MA	•		•				•	
MH036MA	•		•				•	
MH042MA	•		•				•	
MH048MA	•	•	•	•	•	•	•	•
MH054MA	•	•	•	•	•	•	•	•
MH060MA	•	•	•	•	•	•	•	•
MH066MA	•	•	•	•	•	•	•	•

MANHATTAN WALL DUCT COVERS | DESIGNER SERIES

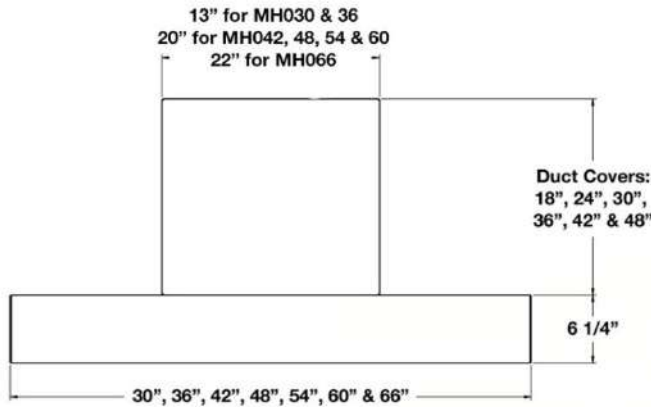

NOTE: 18", 24", 30" & 36" DUCT COVERS INCLUDED WITH HOOD AT NO CHARGE. BELOW PRICING IS IF PURCHASED SEPARATELY.

NOTE: HOOD MUST BE MOUNTED TO CEILING AND CEILING ACCESS MAY BE REQUIRED. PLEASE REFERENCE THE INSTALLATION MANUAL ON BLUESTARCOOKING.COM FOR DETAILS

NOTE: MUST ORDER DUCT COVER FOR BLOWER & MOUNTING PURPOSES. MINIMUM 18" HIGH

SIZE	MODEL	HEIGHT	UMRP	MSRP
Available Duct Covers for 30" Models	DCMW03018	18"	\$ 690	\$ 795
	DCMW03024	24"	\$ 760	\$ 875
	DCMW03030	30"	\$ 830	\$ 955
	DCMW03036	36"	\$ 895	\$ 1,030
	DCMW03042	42"	\$ 965	\$ 1,110
	DCMW03048	48"	\$ 1,035	\$ 1,190
Available Duct Covers for 36" Models	DCMW03618	18"	\$ 690	\$ 795
	DCMW03624	24"	\$ 760	\$ 875
	DCMW03630	30"	\$ 830	\$ 955
	DCMW03636	36"	\$ 895	\$ 1,030
	DCMW03642	42"	\$ 965	\$ 1,110
	DCMW03648	48"	\$ 1,035	\$ 1,190
Available Duct Covers for 42" Models	DCMW04218	18"	\$ 690	\$ 795
	DCMW04224	24"	\$ 760	\$ 875
	DCMW04230	30"	\$ 830	\$ 955
	DCMW04236	36"	\$ 895	\$ 1,030
	DCMW04242	42"	\$ 965	\$ 1,110
	DCMW04248	48"	\$ 1,035	\$ 1,190
Available Duct Covers for 48" Models	DCMW04818	18"	\$ 690	\$ 795
	DCMW04824	24"	\$ 760	\$ 875
	DCMW04830	30"	\$ 830	\$ 955
	DCMW04836	36"	\$ 895	\$ 1,030
	DCMW04842	42"	\$ 965	\$ 1,110
	DCMW04848	48"	\$ 1,035	\$ 1,190
Available Duct Covers for 54" Models	DCMW05418	18"	\$ 690	\$ 795
	DCMW05424	24"	\$ 760	\$ 875
	DCMW05430	30"	\$ 830	\$ 955
	DCMW05436	36"	\$ 895	\$ 1,030
	DCMW05442	42"	\$ 965	\$ 1,110
	DCMW05448	48"	\$ 1,035	\$ 1,190

SIZE	MODEL	HEIGHT	UMRP	MSRP
Available Duct Covers for 60" Models	DCMW06018	18"	\$ 690	\$ 795
	DCMW06024	24"	\$ 760	\$ 875
	DCMW06030	30"	\$ 830	\$ 955
	DCMW06036	36"	\$ 895	\$ 1,030
	DCMW06042	42"	\$ 965	\$ 1,110
	DCMW06048	48"	\$ 1,035	\$ 1,190
Available Duct Covers for 66" Models	DCMW06618	18"	\$ 690	\$ 795
	DCMW06624	24"	\$ 760	\$ 875
	DCMW06630	30"	\$ 830	\$ 955
	DCMW06636	36"	\$ 895	\$ 1,030
	DCMW06642	42"	\$ 965	\$ 1,110
	DCMW06648	48"	\$ 1,035	\$ 1,190

BlueStar Model Number Guide:		
Base Model (HAOXXMLPLT) Hampton Unit Width Internal Liner Type Brushed Stainless Steel Strapping & Rivets	Add code below for desired color (C) 190 Standard RAL (Semi-Gloss) Colors, (CF) Specialty Finish (190 Matte RAL, Precious Metals & Textures) or (CC) Custom Colors	Add (PLT) for Metal Strapping Standard: Brushed Stainless Steel See below for Designer Metal strapping and rivet options



Standard Height: 18" | Standard Depth: 24"

FEATURES:

- Professional-grade performance with three exhaust settings and new Boost feature
- Whisper quiet operation
- Heavy duty, commercial grade materials
- Dimmable LED lighting
- Easy-to-use push-button controls
- Innovative, multi-stage grease capture system
- Stainless baffle filters seamlessly remove for easy dishwasher cleaning
- Choose from stainless steel or 1,000+ colors and finishes
- Simple installation
- 30" & 36" models: 600 CFM internal fan included (*Must be included on order*)
- Included duct cover heights: 6", 12", 18", 24" or 30". Must be specified on order.
- Available with top or rear discharge - Discharge is field reversible.
- In-line, in-hood and remote blower compatible

CUSTOMIZATION OPTIONS:

- 1,000+ Colors & Finishes
- Designer Metals: Brushed Brass, Antique Brass, Polished Brass, Brushed Copper, Pewter & Polished Stainless Steel
- Custom strapping & rivets
- Full custom options

(*) Trim finishes on Cooking & Refrigeration products are different substrates than the trim finishes on Ventilation hoods. Due to these differing processes and substrates the finishes will coordinate but may not match exactly.

Model	Description (*) Denotes item that must be specified	UMRP	MSRP
30" HAMPTON HOODS:			
HA030MLPLT	Body: Stainless Steel Strap/Rivets: Stainless Steel 600 CFM	\$ 3,495	\$ 4,020
HA030MLPLTD	Body: Stainless Steel Strap/Rivets: Des. Metal* 600 CFM	\$ 3,790	\$ 4,390
HA030MLPLTC	Body: Std RAL Color* Strap/Rivets: Stainless Steel 600 CFM	\$ 4,690	\$ 5,395
HA030MLPLTDC	Body: Std RAL Color* Strap/Rivets: Des Metal* 600 CFM	\$ 4,985	\$ 5,735
HA030MLPLTCF	Body: Spec. Finish* Strap/Rivets: Stainless Steel 600 CFM	\$ 5,690	\$ 6,545
HA030MLPLTDCF	Body: Spec. Finish* Strap/Rivets: Des. Metal* 600 CFM	\$ 5,985	\$ 6,885
HA030MLPLTCC	Body: Custom Color* Strap/Rivets: Stainless Steel 600 CFM	\$ 7,190	\$ 8,270
HA030MLPLTDCC	Body: Custom Color* Strap/Rivets: Des. Metal* 600 CFM	\$ 7,485	\$ 8,610
36" HAMPTON HOODS:			
HA036MLPLT	Body: Stainless Steel Strap/Rivets: Stainless Steel 600 CFM	\$ 3,995	\$ 4,595
HA036MLPLTD	Body: Stainless Steel Strap/Rivets: Des. Metal* 600 CFM	\$ 4,390	\$ 5,050
HA036MLPLTC	Body: Std RAL Color* Strap/Rivets: Stainless Steel 600 CFM	\$ 5,190	\$ 5,970
HA036MLPLTDC	Body: Std RAL Color* Strap/Rivets: Des Metal* 600 CFM	\$ 5,585	\$ 6,425
HA036MLPLTCF	Body: Spec. Finish* Strap/Rivets: Stainless Steel 600 CFM	\$ 6,190	\$ 7,120
HA036MLPLTDCF	Body: Spec. Finish* Strap/Rivets: Des. Metal* 600 CFM	\$ 6,585	\$ 7,575
HA036MLPLTCC	Body: Custom Color* Strap/Rivets: Stainless Steel 600 CFM	\$ 7,690	\$ 8,845
HA036MLPLTDCC	Body: Custom Color* Strap/Rivets: Des. Metal* 600 CFM	\$ 8,085	\$ 9,300
DESIGNER METAL OPTIONS FOR STRAPPING & RIVETS:			
Polished Stainless Steel, Brushed Brass, Antique Brass, Polished Brass, Brushed Copper & Pewter			
VENTILATION HOOD ACCESSORIES:			
Refer to page 97 for all Hampton hood duct cover options Refer to page 110 for Ventilation Hood Accessories			

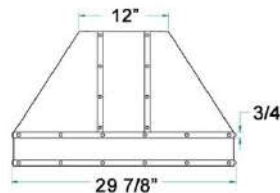

30" Dimensions

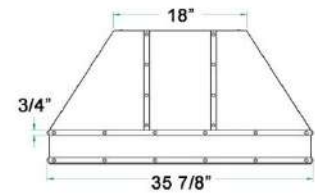

36" Dimensions

BLOWER OPTIONS	IN-HOOD		IN-LINE		REMOTE		DISCHARGE	
	600	1200	800	1200	1000	1400	TOP	REAR
CFM POWER	600	1200	800	1200	1000	1400		
MODEL #	BS-CFM-600-IN06	BS-CFM-1200-IN12	ATEX-0.8	ATEX-1.2	HYEX-1.0-GA	HYEX-1.4-GA		
UMRP	\$ 965	\$ 995	\$ 1,260	\$ 1,510	\$ 1,385	\$ 1,640		
HA030MLPLT	•		•	•	•	•	•	Available at time of order
HA036MLPLT	•	•	•	•	•	•	•	
HA042MLPLT	•	•	•	•	•	•	•	
HA048MLPLT	•	•	•	•	•	•	•	
HA054MLPLT	•	•	•	•	•	•	•	
HA060MLPLT	•	•	•	•	•	•	•	
HA066MLPLT	•	•	•	•	•	•	•	

HAMPTON VENT HOODS | DESIGNER SERIES | WALL HOODS

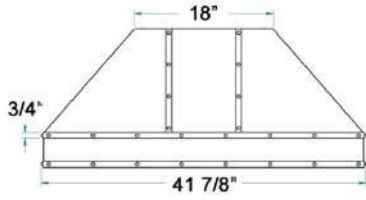

42" Dimensions

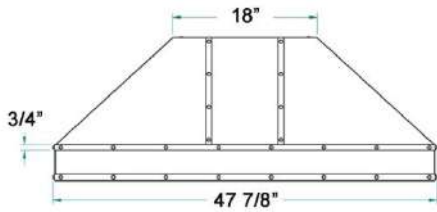

48" Dimensions

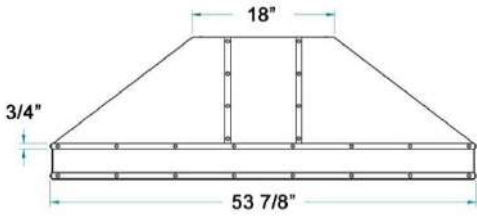

54" Dimensions

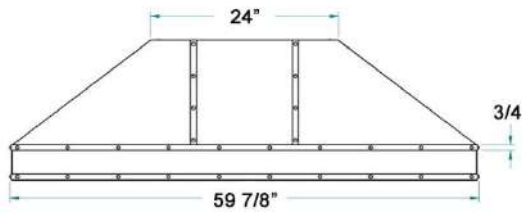

60" Dimensions

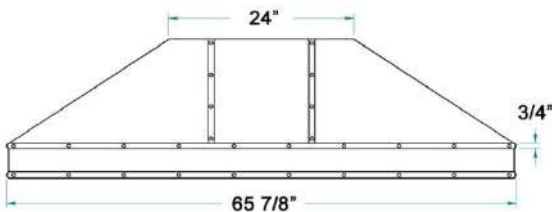

66" Dimensions

42" HAMPTON HOODS		UMRP	MSRP
HA042MLPLT	Body: Stainless Steel Strap/Rivets: Stainless Steel	\$ 4,495	\$ 5,170
HA042MLPLTD	Body: Stainless Steel Strap/Rivets: Des. Metal*	\$ 4,890	\$ 5,625
HA042MLPLTC	Body: Std RAL Color* Strap/Rivets: Stainless Steel	\$ 5,990	\$ 6,890
HA042MLPLTDC	Body: Std RAL Color* Strap/Rivets: Des Metal*	\$ 6,385	\$ 7,345
HA042MLPLTCF	Body: Spec. Finish* Strap/Rivets: Stainless Steel	\$ 7,090	\$ 8,155
HA042MLPLTDCF	Body: Spec. Finish* Strap/Rivets: Des. Metal*	\$ 7,485	\$ 8,610
HA042MLPLTCC	Body: Custom Color* Strap/Rivets: Stainless Steel	\$ 8,490	\$ 9,765
HA042MLPLTDCC	Body: Custom Color* Strap/Rivets: Des. Metal*	\$ 8,885	\$ 10,220
48" HAMPTON HOODS		UMRP	MSRP
HA048MLPLT	Body: Stainless Steel Strap/Rivets: Stainless Steel	\$ 4,795	\$ 5,515
HA048MLPLTD	Body: Stainless Steel Strap/Rivets: Des. Metal*	\$ 5,190	\$ 5,970
HA048MLPLTC	Body: Std RAL Color* Strap/Rivets: Stainless Steel	\$ 6,290	\$ 7,235
HA048MLPLTDC	Body: Std RAL Color* Strap/Rivets: Des Metal*	\$ 6,685	\$ 7,690
HA048MLPLTCF	Body: Spec. Finish* Strap/Rivets: Stainless Steel	\$ 7,390	\$ 8,500
HA048MLPLTDCF	Body: Spec. Finish* Strap/Rivets: Des. Metal*	\$ 7,785	\$ 8,955
HA048MLPLTCC	Body: Custom Color* Strap/Rivets: Stainless Steel	\$ 8,790	\$ 10,110
HA048MLPLTDCC	Body: Custom Color* Strap/Rivets: Des. Metal*	\$ 9,185	\$ 10,565
54" HAMPTON HOODS		UMRP	MSRP
HA054MLPLT	Body: Stainless Steel Strap/Rivets: Stainless Steel	\$ 4,995	\$ 5,745
HA054MLPLTD	Body: Stainless Steel Strap/Rivets: Des. Metal*	\$ 5,390	\$ 6,200
HA054MLPLTC	Body: Std RAL Color* Strap/Rivets: Stainless Steel	\$ 6,490	\$ 7,465
HA054MLPLTDC	Body: Std RAL Color* Strap/Rivets: Des Metal*	\$ 6,885	\$ 7,920
HA054MLPLTCF	Body: Spec. Finish* Strap/Rivets: Stainless Steel	\$ 7,590	\$ 8,730
HA054MLPLTDCF	Body: Spec. Finish* Strap/Rivets: Des. Metal*	\$ 7,985	\$ 9,185
HA054MLPLTCC	Body: Custom Color* Strap/Rivets: Stainless Steel	\$ 8,990	\$ 10,340
HA054MLPLTDCC	Body: Custom Color* Strap/Rivets: Des. Metal*	\$ 9,385	\$ 10,795
60" HAMPTON HOODS		UMRP	MSRP
HA060MLPLT	Body: Stainless Steel Strap/Rivets: Stainless Steel	\$ 5,395	\$ 6,205
HA060MLPLTD	Body: Stainless Steel Strap/Rivets: Des. Metal*	\$ 5,790	\$ 6,660
HA060MLPLTC	Body: Std RAL Color* Strap/Rivets: Stainless Steel	\$ 6,890	\$ 7,925
HA060MLPLTDC	Body: Std RAL Color* Strap/Rivets: Des Metal*	\$ 7,285	\$ 8,380
HA060MLPLTCF	Body: Spec. Finish* Strap/Rivets: Stainless Steel	\$ 7,990	\$ 9,190
HA060MLPLTDCF	Body: Spec. Finish* Strap/Rivets: Des. Metal*	\$ 8,385	\$ 9,645
HA060MLPLTCC	Body: Custom Color* Strap/Rivets: Stainless Steel	\$ 9,390	\$ 10,800
HA060MLPLTDCC	Body: Custom Color* Strap/Rivets: Des. Metal*	\$ 9,785	\$ 11,255
66" HAMPTON HOODS		UMRP	MSRP
HA066MLPLT	Body: Stainless Steel Strap/Rivets: Stainless Steel	\$ 5,595	\$ 6,435
HA066MLPLTD	Body: Stainless Steel Strap/Rivets: Des. Metal*	\$ 5,990	\$ 6,890
HA066MLPLTC	Body: Std RAL Color* Strap/Rivets: Stainless Steel	\$ 7,090	\$ 8,155
HA066MLPLTDC	Body: Std RAL Color* Strap/Rivets: Des Metal*	\$ 7,485	\$ 8,610
HA066MLPLTCF	Body: Spec. Finish* Strap/Rivets: Stainless Steel	\$ 8,190	\$ 9,420
HA066MLPLTDCF	Body: Spec. Finish* Strap/Rivets: Des. Metal*	\$ 8,585	\$ 9,875
HA066MLPLTCC	Body: Custom Color* Strap/Rivets: Stainless Steel	\$ 9,590	\$ 11,030
HA066MLPLTDCC	Body: Custom Color* Strap/Rivets: Des. Metal*	\$ 9,985	\$ 11,485

BlueStar Model Number Guide:		
Base Model (BZ0XXMLPLT) Bonanza Unit Width Internal Liner Type Brushed Stainless Steel Strapping & Rivets	Add code below for desired color (C) 190 Standard RAL (Semi-Gloss) Colors, (CF) Specialty Finish (190 Matte RAL, Precious Metals & Textures) or (CC) Custom Colors	Add (PLT) for Metal Strapping Standard: Brushed Stainless Steel See below for Designer Metal strapping and rivet options

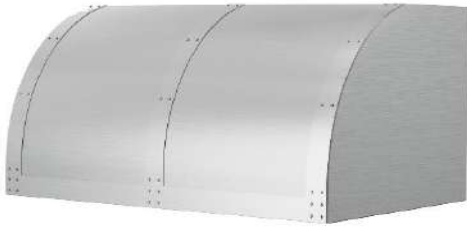

30" & 36" Bonanza Wall Hood
 Standard Height: 18" | Standard Depth: 24"

FEATURES:

- Professional-grade performance with three exhaust settings and new Boost feature
- Whisper quiet operation
- Heavy duty, commercial grade materials
- Dimmable LED lighting
- Easy-to-use push-button controls
- Innovative, multi-stage grease capture system
- Stainless baffle filters seamlessly remove for easy dishwasher cleaning
- Choose from stainless steel or 1,000+ colors and finishes
- Simple installation
- 30" & 36" models: 600 CFM internal fan included (**Must be included on order**)
- Available with top or rear discharge - Discharge is field reversible.
- Install with or without optional duct cover
- In-line, in-hood and remote blower compatible

CUSTOMIZATION OPTIONS:

- 1,000+ Colors & Finishes
- Designer Metals: Brushed Brass, Antique Brass, Polished Brass, Brushed Copper, Pewter & Polished Stainless Steel
- Custom strapping & rivets
- Full custom options

(* Trim finishes on Cooking & Refrigeration products are different substrates than the trim finishes on Ventilation hoods. Due to these differing processes and substrates the finishes will coordinate but may not match exactly.

Model	Description (* Denotes item that must be specified)	UMRP	MSRP
30" BONANZA HOODS: (3 Vertical Straps 1 Horizontal)			
BZ030MLPLT	Body: Stainless Steel Strap/Rivets: Stainless Steel 600 CFM	\$ 4,495	\$ 5,170
BZ030MLPLTD	Body: Stainless Steel Strap/Rivets: Des. Metal* 600 CFM	\$ 4,790	\$ 5,510
BZ030MLPLTC	Body: Std RAL Color* Strap/Rivets: Stainless Steel 600 CFM	\$ 5,690	\$ 6,545
BZ030MLPLTDC	Body: Std RAL Color* Strap/Rivets: Des Metal* 600 CFM	\$ 5,985	\$ 6,885
BZ030MLPLTCF	Body: Spec. Finish* Strap/Rivets: Stainless Steel 600 CFM	\$ 6,690	\$ 7,695
BZ030MLPLTDCF	Body: Spec. Finish* Strap/Rivets: Des. Metal* 600 CFM	\$ 6,985	\$ 8,035
BZ030MLPLTCC	Body: Custom Color* Strap/Rivets: Stainless Steel 600 CFM	\$ 8,190	\$ 9,420
BZ030MLPLTDCC	Body: Custom Color* Strap/Rivets: Des. Metal* 600 CFM	\$ 8,485	\$ 9,760
36" BONANZA HOODS: (3 Vertical Straps 1 Horizontal)			
BZ036MLPLT	Body: Stainless Steel Strap/Rivets: Stainless Steel 600 CFM	\$ 4,825	\$ 5,550
BZ036MLPLTD	Body: Stainless Steel Strap/Rivets: Des. Metal* 600 CFM	\$ 5,220	\$ 6,005
BZ036MLPLTC	Body: Std RAL Color* Strap/Rivets: Stainless Steel 600 CFM	\$ 6,020	\$ 6,925
BZ036MLPLTDC	Body: Std RAL Color* Strap/Rivets: Des Metal* 600 CFM	\$ 6,415	\$ 7,375
BZ036MLPLTCF	Body: Spec. Finish* Strap/Rivets: Stainless Steel 600 CFM	\$ 7,020	\$ 8,075
BZ036MLPLTDCF	Body: Spec. Finish* Strap/Rivets: Des. Metal* 600 CFM	\$ 7,415	\$ 8,525
BZ036MLPLTCC	Body: Custom Color* Strap/Rivets: Stainless Steel 600 CFM	\$ 8,520	\$ 9,800
BZ036MLPLTDCC	Body: Custom Color* Strap/Rivets: Des. Metal* 600 CFM	\$ 8,915	\$ 10,250
DESIGNER METAL OPTIONS FOR STRAPPING & RIVETS:			
Polished Stainless Steel, Brushed Brass, Antique Brass, Polished Brass, Brushed Copper & Pewter			
DUCT COVERS FOR BONANZA HOODS:			
Refer to page 94 for all Bonanza hood duct cover options Refer to page 110 for Ventilation Hood Accessories			
• Available duct cover heights: 2", 6", 12", 18", 24", 30", 36", 42" & 48"			

BLOWER OPTIONS	IN-HOOD		IN-LINE		REMOTE		DISCHARGE	
	600	1200	800	1200	1000	1400	TOP	REAR
MODEL #	BS-CFM-600-IN06	BS-CFM-1200-IN12	ATEX-0.8	ATEX-1.2	HYEX-1.0-GA	HYEX-1.4-GA		
UMRP	\$ 965	\$ 995	\$ 1,260	\$ 1,510	\$ 1,385	\$ 1,640		
BZ030MLPLT	•		•	•	•	•	•	Available at time of order
BZ036MLPLT	•	•	•	•	•	•	•	
BZ042MLPLT	•	•	•	•	•	•	•	
BZ048MLPLT	•	•	•	•	•	•	•	
BZ054MLPLT	•	•	•	•	•	•	•	
BZ060MLPLT	•	•	•	•	•	•	•	
BZ066MLPLT	•	•	•	•	•	•	•	

BONANZA VENT HOODS | DESIGNER SERIES | WALL HOODS



42", 48", 54" & 60" Bonanza Wall Hood

Standard Height: 18" | Standard Depth: 24"



66" Bonanza Wall Hood

Standard Height: 18" | Standard Depth: 24"

42" BONANZA HOODS: (4 Vertical Straps 1 Horizontal)		UMRP	MSRP
BZ042MLPLT	Body: Stainless Steel Strap/Rivets: Stainless Steel	\$ 5,595	\$ 6,435
BZ042MLPLTD	Body: Stainless Steel Strap/Rivets: Des. Metal*	\$ 5,990	\$ 6,890
BZ042MLPLTC	Body: Std RAL Color* Strap/Rivets: Stainless Steel	\$ 7,090	\$ 8,155
BZ042MLPLTDC	Body: Std RAL Color* Strap/Rivets: Des Metal*	\$ 7,485	\$ 8,610
BZ042MLPLTCF	Body: Spec. Finish* Strap/Rivets: Stainless Steel	\$ 8,190	\$ 9,420
BZ042MLPLTDCF	Body: Spec. Finish* Strap/Rivets: Des. Metal*	\$ 8,585	\$ 9,875
BZ042MLPLTCC	Body: Custom Color* Strap/Rivets: Stainless Steel	\$ 9,590	\$ 11,030
BZ042MLPLTDCC	Body: Custom Color* Strap/Rivets: Des. Metal*	\$ 9,985	\$ 11,485
48" BONANZA HOODS: (4 Vertical Straps 1 Horizontal)		UMRP	MSRP
BZ048MLPLT	Body: Stainless Steel Strap/Rivets: Stainless Steel	\$ 6,095	\$ 7,010
BZ048MLPLTD	Body: Stainless Steel Strap/Rivets: Des. Metal*	\$ 6,490	\$ 7,465
BZ048MLPLTC	Body: Std RAL Color* Strap/Rivets: Stainless Steel	\$ 7,590	\$ 8,730
BZ048MLPLTDC	Body: Std RAL Color* Strap/Rivets: Des Metal*	\$ 7,985	\$ 9,185
BZ048MLPLTCF	Body: Spec. Finish* Strap/Rivets: Stainless Steel	\$ 8,690	\$ 9,995
BZ048MLPLTDCF	Body: Spec. Finish* Strap/Rivets: Des. Metal*	\$ 9,085	\$ 10,450
BZ048MLPLTCC	Body: Custom Color* Strap/Rivets: Stainless Steel	\$ 10,090	\$ 11,605
BZ048MLPLTDCC	Body: Custom Color* Strap/Rivets: Des. Metal*	\$ 10,485	\$ 12,060
54" BONANZA HOODS: (4 Vertical Straps 1 Horizontal)		UMRP	MSRP
BZ054MLPLT	Body: Stainless Steel Strap/Rivets: Stainless Steel	\$ 6,195	\$ 7,125
BZ054MLPLTD	Body: Stainless Steel Strap/Rivets: Des. Metal*	\$ 6,590	\$ 7,580
BZ054MLPLTC	Body: Std RAL Color* Strap/Rivets: Stainless Steel	\$ 7,690	\$ 8,845
BZ054MLPLTDC	Body: Std RAL Color* Strap/Rivets: Des Metal*	\$ 8,085	\$ 9,300
BZ054MLPLTCF	Body: Spec. Finish* Strap/Rivets: Stainless Steel	\$ 8,790	\$ 10,110
BZ054MLPLTDCF	Body: Spec. Finish* Strap/Rivets: Des. Metal*	\$ 9,185	\$ 10,565
BZ054MLPLTCC	Body: Custom Color* Strap/Rivets: Stainless Steel	\$ 10,190	\$ 11,720
BZ054MLPLTDCC	Body: Custom Color* Strap/Rivets: Des. Metal*	\$ 10,585	\$ 12,175
60" BONANZA HOODS: (4 Vertical Straps 1 Horizontal)		UMRP	MSRP
BZ060MLPLT	Body: Stainless Steel Strap/Rivets: Stainless Steel	\$ 6,695	\$ 7,700
BZ060MLPLTD	Body: Stainless Steel Strap/Rivets: Des. Metal*	\$ 7,090	\$ 8,155
BZ060MLPLTC	Body: Std RAL Color* Strap/Rivets: Stainless Steel	\$ 8,190	\$ 9,420
BZ060MLPLTDC	Body: Std RAL Color* Strap/Rivets: Des Metal*	\$ 8,585	\$ 9,875
BZ060MLPLTCF	Body: Spec. Finish* Strap/Rivets: Stainless Steel	\$ 9,290	\$ 10,685
BZ060MLPLTDCF	Body: Spec. Finish* Strap/Rivets: Des. Metal*	\$ 9,685	\$ 11,140
BZ060MLPLTCC	Body: Custom Color* Strap/Rivets: Stainless Steel	\$ 10,690	\$ 12,295
BZ060MLPLTDCC	Body: Custom Color* Strap/Rivets: Des. Metal*	\$ 11,085	\$ 12,750
66" BONANZA HOODS: (5 Vertical Straps 1 Horizontal)		UMRP	MSRP
BZ066MLPLT	Body: Stainless Steel Strap/Rivets: Stainless Steel	\$ 6,795	\$ 7,815
BZ066MLPLTD	Body: Stainless Steel Strap/Rivets: Des. Metal*	\$ 7,190	\$ 8,270
BZ066MLPLTC	Body: Std RAL Color* Strap/Rivets: Stainless Steel	\$ 8,290	\$ 9,535
BZ066MLPLTDC	Body: Std RAL Color* Strap/Rivets: Des Metal*	\$ 8,685	\$ 9,990
BZ066MLPLTCF	Body: Spec. Finish* Strap/Rivets: Stainless Steel	\$ 9,390	\$ 10,800
BZ066MLPLTDCF	Body: Spec. Finish* Strap/Rivets: Des. Metal*	\$ 9,785	\$ 11,255
BZ066MLPLTCC	Body: Custom Color* Strap/Rivets: Stainless Steel	\$ 10,790	\$ 12,410
BZ066MLPLTDCC	Body: Custom Color* Strap/Rivets: Des. Metal*	\$ 11,185	\$ 12,865

BONANZA DUCT COVERS | DESIGNER SERIES

NOTE: DUCT COVER MUST BE ORDERED WITH HOOD FOR QUALITY ASSURANCE.

SIZE	MODEL	HEIGHT	UMRP	MSRP
Available Duct Covers for 30" Models	DCBZ03002H	2"	\$ 625	\$ 720
	DCBZ03002	2"	No charge when ordered with Bonanza style hood. Must be ordered with hood for quality assurance.	
	DCBZ03006	6"		
	DCBZ03012	12"		
	DCBZ03018	18"		
	DCBZ03024	24"		
	DCBZ03030	30"		
	DCBZ03036	36"		
	DCBZ03042	42"		
	DCBZ03048	48"		
Available Duct Covers for 36" Models	DCBZ03602H	2"		
	DCBZ03602	2"	No charge when ordered with Bonanza style hood. Must be ordered with hood for quality assurance.	
	DCBZ03606	6"		
	DCBZ03612	12"		
	DCBZ03618	18"		
	DCBZ03624	24"		
	DCBZ03630	30"		
	DCBZ03636	36"		
	DCBZ03642	42"		
	DCBZ03648	48"		
Available Duct Covers for 42" Models	DCBZ04202H	2"		
	DCBZ04202	2"	No charge when ordered with Bonanza style hood. Must be ordered with hood for quality assurance.	
	DCBZ04206	6"		
	DCBZ04212	12"		
	DCBZ042018	18"		
	DCBZ04224	24"		
	DCBZ04230	30"		
	DCBZ04236	36"		
	DCBZ04242	42"		
	DCBZ04248	48"		
Available Duct Covers for 48" Models	DCBZ04802H	2"		
	DCBZ04802	2"	No charge when ordered with Bonanza style hood. Must be ordered with hood for quality assurance.	
	DCBZ04806	6"		
	DCBZ04812	12"		
	DCBZ04818	18"		
	DCBZ04824	24"		
	DCBZ04830	30"		
	DCBZ04836	36"		
	DCBZ04842	42"		
	DCBZ04848	48"		

NOTE: STRAPPING AND RIVETS ON DUCT COVER MUST MATCH HOOD. MUST BE SPECIFIED ON ORDER.

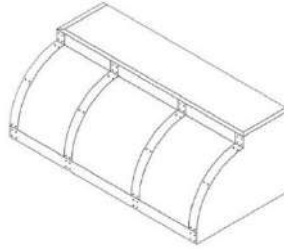

Version: DCBZ0xx2H
Two horizontal straps

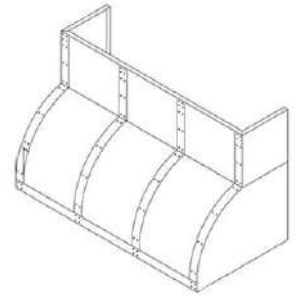

Version: DCBZ0xxxx
One horizontal – All others vertical

SIZE	MODEL	HEIGHT	UMRP	MSRP
Available Duct Covers for 54" Models	DCBZ05402H	2"	\$ 625	\$ 720
	DCBZ05402	2"	No charge when ordered with Bonanza style hood. Must be ordered with hood for quality assurance.	
	DCBZ05406	6"		
	DCBZ05412	12"		
	DCBZ05418	18"		
	DCBZ05424	24"		
	DCBZ05430	30"		
	DCBZ05436	36"		
	DCBZ05442	42"		
	DCBZ05448	48"		
Available Duct Covers for 60" Models	DCBZ06002H	2"		
	DCBZ06002	2"	No charge when ordered with Bonanza style hood. Must be ordered with hood for quality assurance.	
	DCBZ06006	6"		
	DCBZ06012	12"		
	DCBZ06018	18"		
	DCBZ06024	24"		
	DCBZ06030	30"		
	DCBZ06036	36"		
	DCBZ06042	42"		
	DCBZ06048	48"		
Available Duct Covers for 66" Models	DCBZ06602H	2"		
	DCBZ06602	2"	No charge when ordered with Bonanza style hood. Must be ordered with hood for quality assurance.	
	DCBZ06606	6"		
	DCBZ06612	12"		
	DCBZ06618	18"		
	DCBZ06624	24"		
	DCBZ06630	30"		
	DCBZ06636	36"		
	DCBZ06642	42"		
	DCBZ06648	48"		

BlueStar Model Number Guide:		
Base Model (SCOXXMLPLT) Sahara Curved Unit Width Internal Liner Type Brushed Stainless Steel Strapping & Rivets	Add code below for desired color (C) 190 Standard RAL (Semi-Gloss) Colors, (CF) Specialty Finish (190 Matte RAL, Precious Metals & Textures) or (CC) Custom Colors	Add (PLT) for Metal Strapping Standard: Brushed Stainless Steel See below for Designer Metal strapping and rivet options



30" & 36" Sahara Curved Sides Wall Hood
Standard Height: 30" | Standard Depth: 24"

FEATURES:

- Professional-grade performance with three exhaust settings and new Boost feature
- Whisper quiet operation
- Heavy duty, commercial grade materials
- Dimmable LED lighting
- Easy-to-use push-button controls
- Innovative, multi-stage grease capture system
- Stainless baffle filters seamlessly remove for easy dishwasher cleaning
- Choose from stainless steel or 1,000+ colors and finishes
- Simple installation
- 30" & 36" models: 600 CFM internal fan included **(Must be included on order)**
- Available with top or rear discharge - Discharge is field reversible.
- In-line, in-hood and remote blower compatible

CUSTOMIZATION OPTIONS:

- 1,000+ Colors & Finishes
- Designer Metals: Brushed Brass, Antique Brass, Polished Brass, Brushed Copper, Pewter & Polished Stainless Steel
- Custom strapping & rivets
- Full custom options

(* Trim finishes on Cooking & Refrigeration products are different substrates than the trim finishes on Ventilation hoods. Due to these differing processes and substrates the finishes will coordinate but may not match exactly.

Model	Description (* Denotes item that must be specified)	UMRP	MSRP
30" SAHARA CURVED SIDES HOODS:			
SC030MLPLT	Body: Stainless Steel Strap/Rivets: Stainless Steel 600 CFM	\$ 6,495	\$ 7,470
SC030MLPLTD	Body: Stainless Steel Strap/Rivets: Designer Metal* 600 CFM	\$ 6,790	\$ 7,810
SC030MLPLTTC	Body: Std RAL Color* Strap/Rivets: Stainless Steel 600 CFM	\$ 7,690	\$ 8,845
SC030MLPLTDC	Body: Std RAL Color* Strap/Rivets: Designer Metal* 600 CFM	\$ 7,985	\$ 9,185
SC030MLPLTCF	Body: Spec. Finish* Strap/Rivets: Stainless Steel 600 CFM	\$ 8,690	\$ 9,995
SC030MLPLTDCF	Body: Spec. Finish* Strap/Rivets: Designer Metal* 600 CFM	\$ 8,985	\$ 10,335
SC030MLPLTCC	Body: Custom Color* Strap/Rivets: Stainless Steel 600 CFM	\$ 10,190	\$ 11,720
SC030MLPLTDCC	Body: Custom Color* Strap/Rivets: Designer Metal* 600 CFM	\$ 10,485	\$ 12,060
36" SAHARA CURVED SIDES HOODS:			
SC036MLPLT	Body: Stainless Steel Strap/Rivets: Stainless Steel 600 CFM	\$ 6,795	\$ 7,815
SC036MLPLTD	Body: Stainless Steel Strap/Rivets: Designer Metal* 600 CFM	\$ 7,190	\$ 8,270
SC036MLPLTTC	Body: Std RAL Color* Strap/Rivets: Stainless Steel 600 CFM	\$ 7,990	\$ 9,190
SC036MLPLTDC	Body: Std RAL Color* Strap/Rivets: Designer Metal* 600 CFM	\$ 8,385	\$ 9,645
SC036MLPLTCF	Body: Spec. Finish* Strap/Rivets: Stainless Steel 600 CFM	\$ 8,990	\$ 10,340
SC036MLPLTDCF	Body: Spec. Finish* Strap/Rivets: Designer Metal* 600 CFM	\$ 9,385	\$ 10,795
SC036MLPLTCC	Body: Custom Color* Strap/Rivets: Stainless Steel 600 CFM	\$ 10,490	\$ 12,065
SC036MLPLTDCC	Body: Custom Color* Strap/Rivets: Designer Metal** 600 CFM	\$ 10,885	\$ 12,520
DESIGNER METAL OPTIONS FOR STRAPPING & RIVETS:			
Polished Stainless Steel, Brushed Brass, Antique Brass, Polished Brass, Brushed Copper & Pewter			
VENTILATION HOOD ACCESSORIES:			
Refer to page 97 for all Sahara Curved Sides duct cover options Refer to page 110 for Ventilation Hood Accessories			

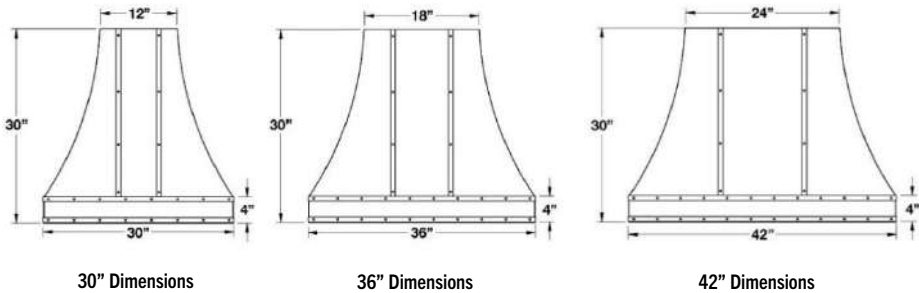

BLOWER OPTIONS	IN-HOOD		IN-LINE		REMOTE		DISCHARGE	
	CFM	POWER	CFM	POWER	CFM	POWER	TOP	REAR
	600	1200	800	1200	1000	1400		
MODEL #	BS-CFM-600-IN06	BS-CFM-1200-IN12	ATEX-0.8	ATEX-1.2	HYEX-1.0-GA	HYEX-1.4-GA		
UMRP	\$ 965	\$ 995	\$ 1,260	\$ 1,510	\$ 1,385	\$ 1,640		
SC030MLPLT	•		•	•	•	•	•	Available at time of order
SC036MLPLT	•	•	•	•	•	•	•	
SC042MLPLT	•	•	•	•	•	•	•	
SC048MLPLT	•	•	•	•	•	•	•	
SC054MLPLT	•	•	•	•	•	•	•	
SC060MLPLT	•	•	•	•	•	•	•	

SAHARA CURVED VENT HOODS | DESIGNER SERIES | WALL HOODS



42" Dimensions

42" SAHARA CURVED SIDES HOODS:		UMRP	MSRP
SC042MLPLT	Body: Stainless Steel Strap/Rivets: Stainless Steel	\$ 7,295	\$ 8,390
SC042MLPLTD	Body: Stainless Steel Strap/Rivets: Designer Metal*	\$ 7,690	\$ 8,845
SC042MLPLTC	Body: Std RAL Color* Strap/Rivets: Stainless Steel	\$ 8,790	\$ 10,110
SC042MLPLTDC	Body: Std RAL Color* Strap/Rivets: Designer Metal*	\$ 9,185	\$ 10,565
SC042MLPLTCF	Body: Spec. Finish* Strap/Rivets: Stainless Steel	\$ 9,890	\$ 11,375
SC042MLPLTDCF	Body: Spec. Finish* Strap/Rivets: Designer Metal*	\$ 10,285	\$ 11,830
SC042MLPLTCC	Body: Custom Color* Strap/Rivets: Stainless Steel	\$ 11,290	\$ 12,985
SC042MLPLTDCC	Body: Custom Color* Strap/Rivets: Designer Metal*	\$ 11,685	\$ 13,440

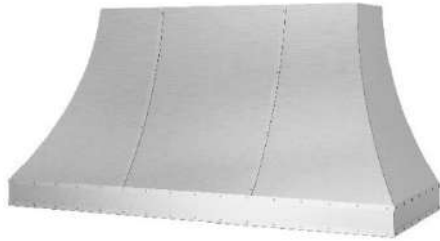

48" Dimensions

48" SAHARA CURVED SIDES HOODS:		UMRP	MSRP
SC048MLPLT	Body: Stainless Steel Strap/Rivets: Stainless Steel	\$ 7,695	\$ 8,850
SC048MLPLTD	Body: Stainless Steel Strap/Rivets: Designer Metal*	\$ 8,090	\$ 9,305
SC048MLPLTC	Body: Std RAL Color* Strap/Rivets: Stainless Steel	\$ 9,190	\$ 10,570
SC048MLPLTDC	Body: Std RAL Color* Strap/Rivets: Designer Metal*	\$ 9,585	\$ 11,025
SC048MLPLTCF	Body: Spec. Finish* Strap/Rivets: Stainless Steel	\$ 10,290	\$ 11,835
SC048MLPLTDCF	Body: Spec. Finish* Strap/Rivets: Designer Metal*	\$ 10,685	\$ 12,290
SC048MLPLTCC	Body: Custom Color* Strap/Rivets: Stainless Steel	\$ 11,690	\$ 13,445
SC048MLPLTDCC	Body: Custom Color* Strap/Rivets: Designer Metal*	\$ 12,085	\$ 13,900

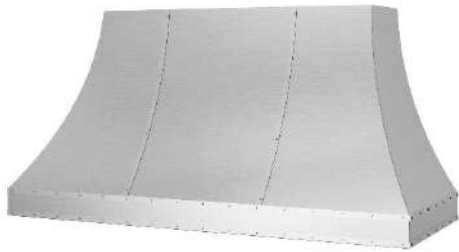

54" Dimensions

54" SAHARA CURVED SIDES HOODS:		UMRP	MSRP
SC054MLPLT	Body: Stainless Steel Strap/Rivets: Stainless Steel	\$ 8,995	\$ 10,345
SC054MLPLTD	Body: Stainless Steel Strap/Rivets: Designer Metal*	\$ 9,390	\$ 10,800
SC054MLPLTC	Body: Std RAL Color* Strap/Rivets: Stainless Steel	\$ 10,490	\$ 12,065
SC054MLPLTDC	Body: Std RAL Color* Strap/Rivets: Designer Metal*	\$ 10,885	\$ 12,520
SC054MLPLTCF	Body: Spec. Finish* Strap/Rivets: Stainless Steel	\$ 11,590	\$ 13,330
SC054MLPLTDCF	Body: Spec. Finish* Strap/Rivets: Designer Metal*	\$ 11,985	\$ 13,785
SC054MLPLTCC	Body: Custom Color* Strap/Rivets: Stainless Steel	\$ 12,990	\$ 14,940
SC054MLPLTDCC	Body: Custom Color* Strap/Rivets: Designer Metal*	\$ 13,385	\$ 15,395

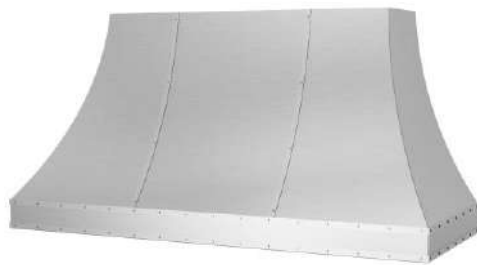

60" Dimensions

60" SAHARA CURVED SIDES HOODS:		UMRP	MSRP
SC060MLPLT	Body: Stainless Steel Strap/Rivets: Stainless Steel	\$ 10,620	\$ 12,215
SC060MLPLTD	Body: Stainless Steel Strap/Rivets: Designer Metal*	\$ 10,990	\$ 12,640
SC060MLPLTC	Body: Std RAL Color* Strap/Rivets: Stainless Steel	\$ 12,090	\$ 13,905
SC060MLPLTDC	Body: Std RAL Color* Strap/Rivets: Designer Metal*	\$ 12,485	\$ 14,360
SC060MLPLTCF	Body: Spec. Finish* Strap/Rivets: Stainless Steel	\$ 13,190	\$ 15,170
SC060MLPLTDCF	Body: Spec. Finish* Strap/Rivets: Designer Metal*	\$ 13,585	\$ 15,625
SC060MLPLTCC	Body: Custom Color* Strap/Rivets: Stainless Steel	\$ 14,590	\$ 16,780
SC060MLPLTDCC	Body: Custom Color* Strap/Rivets: Designer Metal*	\$ 14,985	\$ 17,235

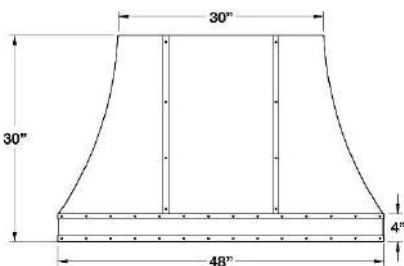

48" Dimensions

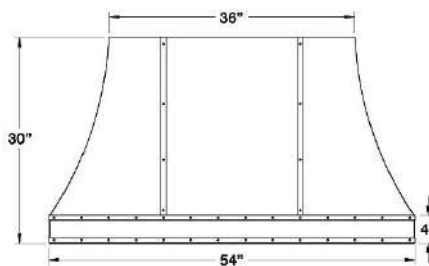

54" Dimensions

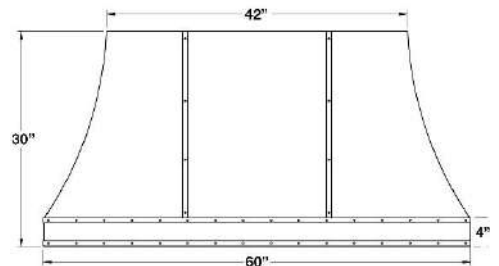

60" Dimensions

SAHARA CURVED, HAMPTON & RIDGELINE DUCT COVERS | DESIGNER SERIES

NOTE: STRAPPING AND RIVETS ON DUCT COVER MUST MATCH HOOD. MUST BE SPECIFIED ON ORDER.

NOTE: DUCT COVER MUST BE ORDERED WITH HOOD FOR QUALITY ASSURANCE.

HAMPTON WALL HOODS

SIZE	MODEL	HEIGHT
Available Duct Covers for 30" Models	DCHW1206	6"
	DCHW1212	12"
	DCHW1218	18"
Duct Width: 12"	DCHW1224	24"
	DCHW1230	30"
No charge when ordered with Hampton style hood.	DCHW1236	36"
	DCHW1242	42"
	DCHW1248	48"

SAHARA CURVED & RIDGELINE WALL HOODS

SIZE	MODEL	HEIGHT	SIZE	MODEL	HEIGHT
Available Duct Covers for 30" Models	DCHW1206	6"	Available Duct Covers for 48" Models	DCHW3006	6"
	DCHW1212	12"		DCHW3012	12"
	DCHW1218	18"		DCHW3018	18"
Duct Width: 12"	DCHW1224	24"	Duct Width: 30"	DCHW3024	24"
	DCHW1230	30"		DCHW3030	30"
No Charge when ordered with Sahara Curved or Ridgeline style hood	DCHW1236	36"	No Charge when ordered with Sahara Curved or Ridgeline style hood	DCHW3036	36"
	DCHW1242	42"		DCHW3042	42"
	DCHW1248	48"		DCHW3048	48"

SIZE	MODEL	HEIGHT
Available Duct Covers for 36", 42", 48" & 54" Models	DCHW1806	6"
	DCHW1812	12"
	DCHW1818	18"
Duct Width: 18"	DCHW1824	24"
	DCHW1830	30"
No charge when ordered with Hampton style hood.	DCHW1836	36"
	DCHW1842	42"
	DCHW1848	48"

SIZE	MODEL	HEIGHT
Available Duct Covers for 36" Models	DCHW1806	6"
	DCHW1812	12"
	DCHW1818	18"
Duct Width: 18"	DCHW1824	24"
	DCHW1830	30"
No Charge when ordered with Sahara Curved or Ridgeline style hood	DCHW1836	36"
	DCHW1842	42"
	DCHW1848	48"

SIZE	MODEL	HEIGHT
Available Duct Covers for 54" Models	DCHW3606	6"
	DCHW3612	12"
	DCHW3618	18"
Duct Width: 36"	DCHW3624	24"
	DCHW3630	30"
No Charge when ordered with Sahara Curved or Ridgeline style hood	DCHW3636	36"
	DCHW3642	42"
	DCHW3648	48"

SIZE	MODEL	HEIGHT
Available Duct Covers for 60" & 66" Models	DCHW2406	6"
	DCHW2412	12"
	DCHW2418	18"
Duct Width: 24"	DCHW2424	24"
	DCHW2430	30"
No charge when ordered with Hampton style hood.	DCHW2436	36"
	DCHW2442	42"
	DCHW2448	48"

SIZE	MODEL	HEIGHT
Available Duct Covers for 42" Models	DCHW2406	6"
	DCHW2412	12"
	DCHW2418	18"
Duct Width: 24"	DCHW2424	24"
	DCHW2430	30"
No Charge when ordered with Sahara Curved or Ridgeline style hood	DCHW2436	36"
	DCHW2442	42"
	DCHW2448	48"

SIZE	MODEL	HEIGHT
Available Duct Covers for 60" Models	DCHW4206	6"
	DCHW4212	12"
	DCHW4218	18"
Duct Width: 42"	DCHW4224	24"
	DCHW4230	30"
No Charge when ordered with Sahara Curved or Ridgeline style hood	DCHW4236	36"
	DCHW4242	42"
	DCHW4248	48"

BlueStar Model Number Guide:		
Base Model (WROXXMLPLT) Wrangler Unit Width Internal Liner Type Brushed Stainless Steel Strapping & Rivets	Add code below for desired color (C) 190 Standard RAL (Semi-Gloss) Colors, (CF) Specialty Finish (190 Matte RAL, Precious Metals & Textures) or (CC) Custom Colors	Add (PLT) for Metal Strapping Standard: Brushed Stainless Steel See below for Designer Metal strapping and rivet options



30" & 36" Wrangler Wall Hood

Standard Height: 20" | Bottom Depth: 24" | Top Depth: 13"

FEATURES:

- Professional-grade performance with three exhaust settings and new Boost feature
- Whisper quiet operation
- Heavy duty, commercial grade materials
- Dimmable LED lighting
- Easy-to-use push-button controls
- Innovative, multi-stage grease capture system
- Stainless baffle filters seamlessly remove for easy dishwasher cleaning
- Choose from stainless steel or 1,000+ colors and finishes
- Simple installation
- 30" & 36" models: 600 CFM internal fan included **(Must be included on order)**
- Included duct cover heights: 10", 16", 22", 28", 34", 40", 46". Must be specified on order.
- Available with top or rear discharge - Discharge is field reversible.
- In-line, in-hood and remote blower compatible

CUSTOMIZATION OPTIONS:

- 1,000+ Colors & Finishes
- Designer Metals: Brushed Brass, Antique Brass, Polished Brass, Brushed Copper, Pewter & Polished Stainless Steel
- Custom strapping & rivets
- Full custom options

(* Trim finishes on Cooking & Refrigeration products are different substrates than the trim finishes on Ventilation hoods. Due to these differing processes and substrates the finishes will coordinate but may not match exactly.

Model	Description (* Denotes item that must be specified)	UMRP	MSRP
30" WRANGLER HOODS:			
WR030MLPLT	Body: Stainless Steel Strap/Rivets: Stainless Steel 600 CFM	\$ 7,695	\$ 8,850
WR030MLPLTD	Body: Stainless Steel Strap/Rivets: Des. Metal* 600 CFM	\$ 7,990	\$ 9,190
WR030MLPLTTC	Body: Std RAL Color* Strap/Rivets: Stainless Steel 600 CFM	\$ 8,890	\$ 10,225
WR030MLPLTDC	Body: Std RAL Color* Strap/Rivets: Des Metal* 600 CFM	\$ 9,185	\$ 10,565
WR030MLPLTCF	Body: Spec. Finish* Strap/Rivets: Stainless Steel 600 CFM	\$ 9,890	\$ 11,375
WR030MLPLTDCF	Body: Spec. Finish* Strap/Rivets: Des. Metal* 600 CFM	\$ 10,185	\$ 11,715
WR030MLPLTCC	Body: Custom Color* Strap/Rivets: Stainless Steel 600 CFM	\$ 11,390	\$ 13,100
WR030MLPLTDCC	Body: Custom Color* Strap/Rivets: Des. Metal* 600 CFM	\$ 11,685	\$ 13,440
36" WRANGLER HOODS:			
WR036MLPLT	Body: Stainless Steel Strap/Rivets: Stainless Steel 600 CFM	\$ 7,895	\$ 9,080
WR036MLPLTD	Body: Stainless Steel Strap/Rivets: Des. Metal* 600 CFM	\$ 8,290	\$ 9,535
WR036MLPLTTC	Body: Std RAL Color* Strap/Rivets: Stainless Steel 600 CFM	\$ 9,090	\$ 10,455
WR036MLPLTDC	Body: Std RAL Color* Strap/Rivets: Des Metal* 600 CFM	\$ 9,485	\$ 10,910
WR036MLPLTCF	Body: Spec. Finish* Strap/Rivets: Stainless Steel 600 CFM	\$ 10,090	\$ 11,605
WR036MLPLTDCF	Body: Spec. Finish* Strap/Rivets: Des. Metal* 600 CFM	\$ 10,485	\$ 12,060
WR036MLPLTCC	Body: Custom Color* Strap/Rivets: Stainless Steel 600 CFM	\$ 11,590	\$ 13,330
WR036MLPLTDCC	Body: Custom Color* Strap/Rivets: Des. Metal* 600 CFM	\$ 11,985	\$ 13,785
DESIGNER METAL OPTIONS FOR STRAPPING & RIVETS:			
Polished Stainless Steel, Brushed Brass, Antique Brass, Polished Brass, Brushed Copper & Pewter			
DUCT COVERS FOR WRANGLER HOODS:			
Refer to page 100 for all Wrangler hood duct cover options Refer to page 110 for Ventilation Hood Accessories			
• Included duct cover heights: 10", 16", 22", 28", 34", 40", 46"			

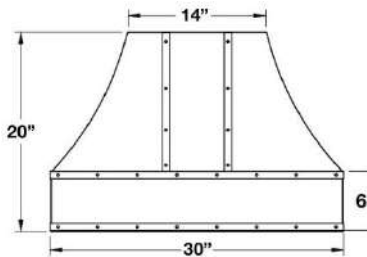

30" Dimensions

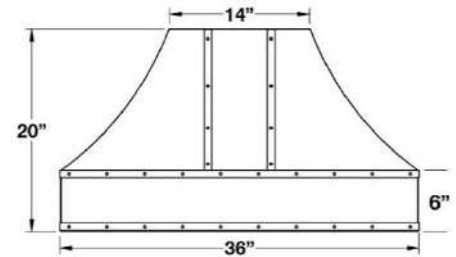

36" Dimensions

BLOWER OPTIONS	IN-HOOD		IN-LINE		REMOTE		DISCHARGE	
	600	1200	800	1200	1000	1400	TOP	REAR
CFM POWER	600	1200	800	1200	1000	1400		
MODEL #	BS-CFM-600-IN06	BS-CFM-1200-IN12	ATEX-0.8	ATEX-1.2	HYEX-1.0-GA	HYEX-1.4-GA		
UMRP	\$ 965	\$ 995	\$ 1,260	\$ 1,510	\$ 1,385	\$ 1,640		
WR030MLPLT	•		•	•	•	•	•	Available at time of order
WR036MLPLT	•	•	•	•	•	•	•	
WR042MLPLT	•	•	•	•	•	•	•	
WR048MLPLT	•	•	•	•	•	•	•	
WR054MLPLT	•	•	•	•	•	•	•	
WR060MLPLT	•	•	•	•	•	•	•	
WR066MLPLT	•	•	•	•	•	•	•	

WRANGLER VENT HOODS | DESIGNER SERIES

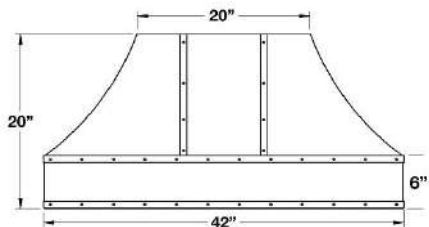

42" Dimensions

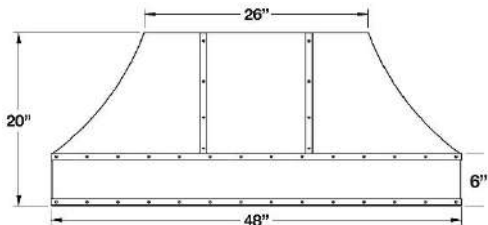

48" Dimensions

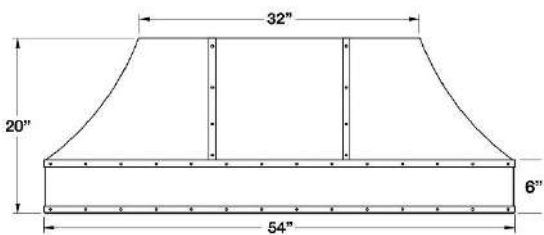

54" Dimensions

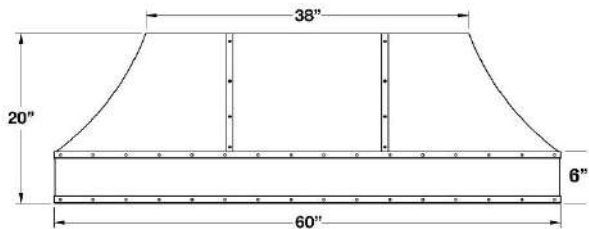

60" Dimensions

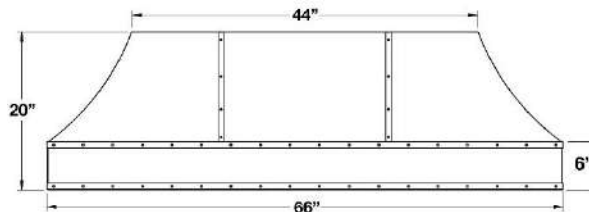

66" Dimensions

42" WRANGLER HOODS		UMRP	MSRP
WR042MLPLT	Body: Stainless Steel Strap/Rivets: Stainless Steel	\$ 7,995	\$ 9,195
WR042MLPLTD	Body: Stainless Steel Strap/Rivets: Des. Metal*	\$ 8,390	\$ 9,650
WR042MLPLTC	Body: Std RAL Color* Strap/Rivets: Stainless Steel	\$ 9,490	\$ 10,915
WR042MLPLTDC	Body: Std RAL Color* Strap/Rivets: Des Metal*	\$ 9,885	\$ 11,370
WR042MLPLTCF	Body: Spec. Finish* Strap/Rivets: Stainless Steel	\$ 10,590	\$ 12,180
WR042MLPLTDCF	Body: Spec. Finish* Strap/Rivets: Des. Metal*	\$ 10,985	\$ 12,635
WR042MLPLTCC	Body: Custom Color* Strap/Rivets: Stainless Steel	\$ 11,990	\$ 13,790
WR042MLPLTDCC	Body: Custom Color* Strap/Rivets: Des. Metal*	\$ 12,385	\$ 14,245
48" WRANGLER HOODS		UMRP	MSRP
WR048MLPLT	Body: Stainless Steel Strap/Rivets: Stainless Steel	\$ 8,195	\$ 9,425
WR048MLPLTD	Body: Stainless Steel Strap/Rivets: Des. Metal*	\$ 8,590	\$ 9,880
WR048MLPLTC	Body: Std RAL Color* Strap/Rivets: Stainless Steel	\$ 9,690	\$ 11,145
WR048MLPLTDC	Body: Std RAL Color* Strap/Rivets: Des Metal*	\$ 10,085	\$ 11,600
WR048MLPLTCF	Body: Spec. Finish* Strap/Rivets: Stainless Steel	\$ 10,790	\$ 12,410
WR048MLPLTDCF	Body: Spec. Finish* Strap/Rivets: Des. Metal*	\$ 11,185	\$ 12,865
WR048MLPLTCC	Body: Custom Color* Strap/Rivets: Stainless Steel	\$ 12,190	\$ 14,020
WR048MLPLTDCC	Body: Custom Color* Strap/Rivets: Des. Metal*	\$ 12,585	\$ 14,475
54" WRANGLER HOODS		UMRP	MSRP
WR054MLPLT	Body: Stainless Steel Strap/Rivets: Stainless Steel	\$ 8,295	\$ 9,540
WR054MLPLTD	Body: Stainless Steel Strap/Rivets: Des. Metal*	\$ 8,690	\$ 9,995
WR054MLPLTC	Body: Std RAL Color* Strap/Rivets: Stainless Steel	\$ 9,790	\$ 11,260
WR054MLPLTDC	Body: Std RAL Color* Strap/Rivets: Des Metal*	\$ 10,185	\$ 11,715
WR054MLPLTCF	Body: Spec. Finish* Strap/Rivets: Stainless Steel	\$ 10,890	\$ 12,525
WR054MLPLTDCF	Body: Spec. Finish* Strap/Rivets: Des. Metal*	\$ 11,285	\$ 12,980
WR054MLPLTCC	Body: Custom Color* Strap/Rivets: Stainless Steel	\$ 12,290	\$ 14,135
WR054MLPLTDCC	Body: Custom Color* Strap/Rivets: Des. Metal*	\$ 12,685	\$ 14,590
60" WRANGLER HOODS		UMRP	MSRP
WR060MLPLT	Body: Stainless Steel Strap/Rivets: Stainless Steel	\$ 8,395	\$ 9,655
WR060MLPLTD	Body: Stainless Steel Strap/Rivets: Des. Metal*	\$ 8,790	\$ 10,110
WR060MLPLTC	Body: Std RAL Color* Strap/Rivets: Stainless Steel	\$ 9,890	\$ 11,375
WR060MLPLTDC	Body: Std RAL Color* Strap/Rivets: Des Metal*	\$ 10,285	\$ 11,830
WR060MLPLTCF	Body: Spec. Finish* Strap/Rivets: Stainless Steel	\$ 10,990	\$ 12,640
WR060MLPLTDCF	Body: Spec. Finish* Strap/Rivets: Des. Metal*	\$ 11,385	\$ 13,095
WR060MLPLTCC	Body: Custom Color* Strap/Rivets: Stainless Steel	\$ 12,390	\$ 14,250
WR060MLPLTDCC	Body: Custom Color* Strap/Rivets: Des. Metal*	\$ 12,785	\$ 14,705
66" WRANGLER HOODS		UMRP	MSRP
WR066MLPLT	Body: Stainless Steel Strap/Rivets: Stainless Steel	\$ 8,495	\$ 9,770
WR066MLPLTD	Body: Stainless Steel Strap/Rivets: Des. Metal*	\$ 8,890	\$ 10,225
WR066MLPLTC	Body: Std RAL Color* Strap/Rivets: Stainless Steel	\$ 9,990	\$ 11,490
WR066MLPLTDC	Body: Std RAL Color* Strap/Rivets: Des Metal*	\$ 10,385	\$ 11,945
WR066MLPLTCF	Body: Spec. Finish* Strap/Rivets: Stainless Steel	\$ 11,090	\$ 12,755
WR066MLPLTDCF	Body: Spec. Finish* Strap/Rivets: Des. Metal*	\$ 11,485	\$ 13,210
WR066MLPLTCC	Body: Custom Color* Strap/Rivets: Stainless Steel	\$ 12,490	\$ 14,365
WR066MLPLTDCC	Body: Custom Color* Strap/Rivets: Des. Metal*	\$ 12,885	\$ 14,820

WRANGLER DUCT COVERS | DESIGNER SERIES

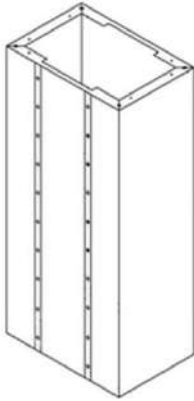

NOTE: STRAPPING AND RIVETS ON DUCT COVER MUST MATCH HOOD. MUST BE SPECIFIED ON ORDER.

NOTE: DUCT COVER MUST BE ORDERED WITH HOOD FOR QUALITY ASSURANCE.

SIZE	MODEL	HEIGHT	UMRP	MSRP
Available Duct Covers for 30" Models Duct Width: 12"	DCWW03010	10"	No charge when ordered with Wrangler style hood.	
	DCWW03016	16"		
	DCWW03022	22"		
	DCWW03028	28"	Must be ordered with hood for quality assurance.	
	DCWW03034	34"		
	DCWW03040	40"		
	DCWW03046	46"		
Available Duct Covers for 36" Models Duct Width: 12"	DCWW03610	10"	No charge when ordered with Wrangler style hood.	
	DCWW03616	16"		
	DCWW03622	22"		
	DCWW03628	28"	Must be ordered with hood for quality assurance.	
	DCWW03634	34"		
	DCWW03640	40"		
	DCWW03646	46"		
Available Duct Covers for 42" Models Duct Width: 18"	DCWW04210	10"	No charge when ordered with Wrangler style hood.	
	DCWW04216	16"		
	DCWW04222	22"		
	DCWW04228	28"	Must be ordered with hood for quality assurance.	
	DCWW04234	34"		
	DCWW04240	40"		
	DCWW04246	46"		

SIZE	MODEL	HEIGHT	UMRP	MSRP
Available Duct Covers for 48" Models Duct Width: 24"	DCWW04810	10"		No charge when ordered with Wrangler style hood. Must be ordered with hood for quality assurance.
	DCWW04816	16"		
	DCWW04822	22"		
	DCWW04828	28"		
	DCWW04834	34"		
	DCWW04840	40"		
	DCWW04846	46"		
Available Duct Covers for 54" Models Duct Width: 30"	DCWW05410	10"		No charge when ordered with Wrangler style hood. Must be ordered with hood for quality assurance.
	DCWW05416	16"		
	DCWW05422	22"		
	DCWW05428	28"		
	DCWW05434	34"		
	DCWW05440	40"		
	DCWW05446	46"		
Available Duct Covers for 60" Models Duct Width: 34"	DCWW06010	10"		No charge when ordered with Wrangler style hood. Must be ordered with hood for quality assurance.
	DCWW06016	16"		
	DCWW06022	22"		
	DCWW06028	28"		
	DCWW06034	34"		
	DCWW06040	40"		
	DCWW06046	46"		
Available Duct Covers for 66" Models Duct Width: 42"	DCWW06610	10"		No charge when ordered with Wrangler style hood. Must be ordered with hood for quality assurance.
	DCWW06616	16"		
	DCWW06622	22"		
	DCWW06628	28"		
	DCWW06634	34"		
	DCWW06640	40"		
	DCWW06646	46"		

BlueStar Model Number Guide:		
Base Model (BS-MANH-I-XX-SS) Manhattan Island Unit Width	Add code below for desired color Reference color pricing below	Add (PLT) for Metal Strapping Available through custom quote only at quote@bluestarcooking.com



Standard Height: 6" | Standard Depth: 34"

FEATURES:

- Commercial grade stainless steel construction
- Welded seamless corners
- Commercial style stainless steel baffle filter system
- 3-speed blower/variable light control
- 36" models: 600 CFM internal fan included
(*Must be included on order*)
- Accommodates top discharge only
- Included duct cover heights: 18", 24", 30" & 36"
(*Must be specified on order.*)
- Remote and In-line fans available

CUSTOMIZATION OPTIONS:

- 1,000+ Colors & Finishes
- Designer Metals: Brushed Brass, Antique Brass, Polished Brass, Brushed Copper, Pewter & Polished Stainless Steel
- Custom strapping & rivets
- Full custom options

(*) Trim finishes on Cooking & Refrigeration products are different substrates than the trim finishes on Ventilation hoods. Due to these differing processes and substrates the finishes will coordinate but may not match exactly.

Model	Description (*) Denotes item that must be specified	UMRP	MSRP
BS-MANH-I-36-SS	36" Manhattan Stainless Steel 600 CFM Blower	\$ 4,295	\$ 4,940
BS-MANH-I-42-SS	42" Manhattan Stainless Steel	\$ 4,795	\$ 5,515
BS-MANH-I-48-SS	48" Manhattan Stainless Steel	\$ 4,995	\$ 5,745
BS-MANH-I-54-SS	54" Manhattan Stainless Steel	\$ 5,095	\$ 5,860
BS-MANH-I-60-SS	60" Manhattan Stainless Steel	\$ 6,495	\$ 7,470
BS-MANH-I-66-SS	66" Manhattan Stainless Steel	\$ 6,695	\$ 7,700
COLOR OPTIONS:			
Std RAL: 36"	Standard 190 RAL Colors: 36" Models	\$ 1,195	
Std RAL: 42" – 66"	Standard 190 RAL Colors: 42" – 66" Models	\$ 1,495	
Spec Finish: 36"	Specialty Finish: 36" Models	\$ 2,195	
Spec Finish: 42" – 66"	Specialty Finish: 42" – 66" Models	\$ 2,595	
Custom Color: 36"	Custom Color: 36" Models	\$ 3,695	
Custom Color: 42" – 66"	Custom Color: 42" – 66" Models	\$ 3,995	
DUCT COVERS FOR MANHATTAN HOODS:			
Refer to page 102 for all Manhattan Island hood duct cover options Refer to page 110 for Ventilation Hood Accessories			
• Included duct cover heights: 18", 24", 30" & 36" Also available in 42" & 48" for additional charge			

NOTE: HOOD MUST BE MOUNTED TO CEILING AND CEILING ACCESS MAY BE REQUIRED. PLEASE REFERENCE THE INSTALLATION MANUAL ON BLUESTARCOOKING.COM FOR DETAILS

NOTE: MUST ORDER DUCT COVER FOR BLOWER & MOUNTING PURPOSES. MINIMUM 18" HIGH

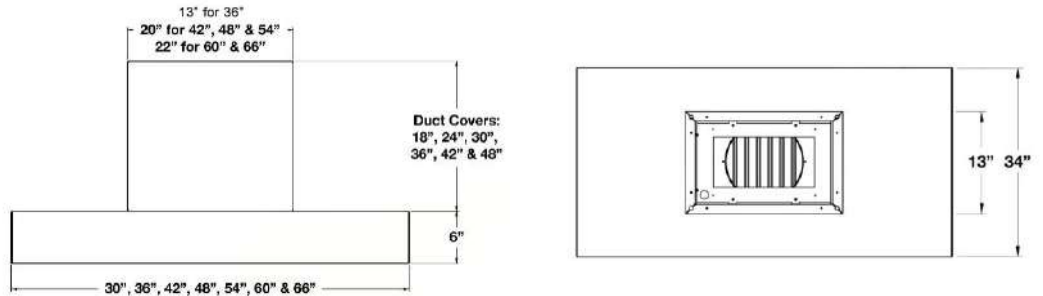

BLOWER OPTIONS	IN-HOOD		IN-LINE		REMOTE		DISCHARGE	
	CFM	POWER	CFM	POWER	CFM	POWER	TOP	REAR
MODEL #	PH-CFM-600	PH-CFM-1200	PH-INLB600	PH-INBL1200	PH-1000CFMR	PH-1400CFMR		
UMRP	\$ 965	\$ 1,385	\$ 1,520	\$ 1,875	\$ 1,890	\$ 2,020		
BS-MANH-I-36-SS	•		•	•	•	•	•	
BS-MANH-I-42-SS	•	•	•	•	•	•	•	
BS-MANH-I-48-SS	•	•	•	•	•	•	•	
BS-MANH-I-54-SS	•	•	•	•	•	•	•	
BS-MANH-I-60-SS	•	•	•	•	•	•	•	
BS-MANH-I-66-SS	•	•	•	•	•	•	•	

Denotes blower compatible with specific ventilation hood size. ATEX In-line and HY-EX Remote designated blowers are not compatible with this ventilation hood.

MANHATTAN ISLAND DUCT COVERS | DESIGNER SERIES

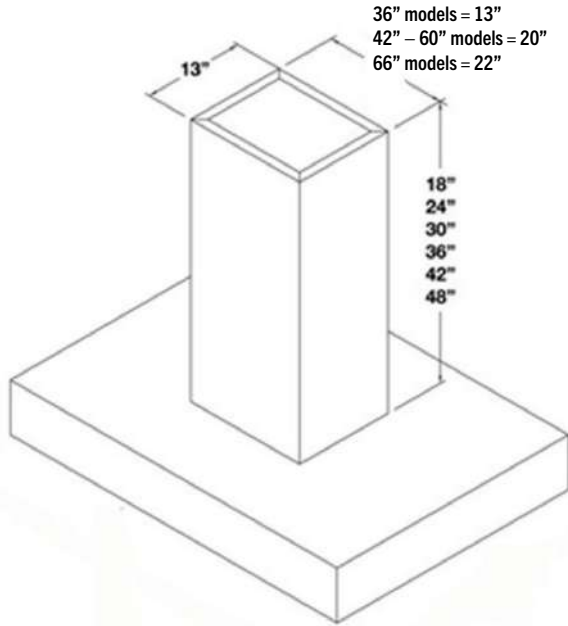

NOTE: 18", 24", 30" & 36" DUCT COVERS INCLUDED WITH HOOD AT NO CHARGE. BELOW PRICING IS IF PURCHASED SEPARATELY.

NOTE: HOOD MUST BE MOUNTED TO CEILING AND CEILING ACCESS MAY BE REQUIRED. PLEASE REFERENCE THE INSTALLATION MANUAL ON BLUESTARCOOKING.COM FOR DETAILS

NOTE: MUST ORDER DUCT COVER FOR BLOWER & MOUNTING PURPOSES. MINIMUM 18" HIGH

SIZE	MODEL	HEIGHT	UMRP	MSRP
Available Duct Covers for 36" Mahattan Island Models 18", 24" 30" & 36" Duct Covers included with Hood at No Charge if Ordered with the Hood. MUST ORDER DUCT COVER FOR BLOWER & MOUNTING PURPOSES - MIN. 18" HIGH	PH-DC18MANH36I	18"	\$ 755	\$ 870
	PH-DC24MANH36I	24"	\$ 830	\$ 955
	PH-DC30MANH36I	30"	\$ 895	\$ 1,030
	PH-DC36MANH36I	36"	\$ 1,035	\$ 1,190
Available Duct Covers for 42", 48", 54" & 60" Models 18", 24" 30" & 36" Duct Covers included with Hood at No Charge if Ordered with the Hood. MUST ORDER DUCT COVER FOR BLOWER & MOUNTING PURPOSES - MIN. 18" HIGH	PH-DC18MANH48I	18"	\$ 755	\$ 870
	PH-DC24MANH48I	24"	\$ 830	\$ 955
	PH-DC30MANH48I	30"	\$ 895	\$ 1,030
	PH-DC36MANH48I	36"	\$ 1,035	\$ 1,190
	PH-DC42MANH48I	42"	\$ 1,100	\$ 1,275
	PH-DC48MANH48I	48"	\$ 1,180	\$ 1,355
Available Duct Covers for 66" Models 18", 24" 30" & 36" Duct Covers included with Hood at No Charge if Ordered with the Hood. MUST ORDER DUCT COVER FOR BLOWER & MOUNTING PURPOSES - MIN. 18" HIGH	PH-DC18MANH66I	18"	\$ 755	\$ 870
	PH-DC24MANH66I	24"	\$ 830	\$ 955
	PH-DC30MANH66I	30"	\$ 895	\$ 1,030
	PH-DC36MANH66I	36"	\$ 1,035	\$ 1,190
	PH-DC42MANH66I	42"	\$ 1,100	\$ 1,275

BlueStar Model Number Guide:		
Base Model (RLOXXMLPLT) Ridgeline Unit Width Internal Liner Type Brushed Stainless Steel Lower Reveal	Add code below for desired color (C) 190 Standard RAL (Semi-Gloss) Colors, (CF) Specialty Finish (190 Matte RAL, Precious Metals & Textures) or (CC) Custom Colors	Add (PLT) for Metal Strapping Standard: Brushed Stainless Steel See below for Designer Metal strapping and rivet options



Standard Height: 36" | Standard Depth: 24"

FEATURES:

- Professional-grade performance with three exhaust settings and new Boost feature
- Whisper quiet operation
- Heavy duty, commercial grade materials
- Dimmable LED lighting
- Easy-to-use push-button controls
- Innovative, multi-stage grease capture system
- Stainless baffle filters seamlessly remove for easy dishwasher cleaning
- Choose from stainless steel or 1,000+ colors and finishes
- Simple installation
- 30" & 36" models: 600 CFM internal fan included (*Must be included on order*)
- Available with top or rear discharge - Discharge is field reversible.
- Install with or without optional duct cover
- In-line, in-hood and remote blower compatible

CUSTOMIZATION OPTIONS:

- 1,000+ Colors & Finishes
- Designer Metals: Brushed Brass, Antique Brass, Polished Brass, Brushed Copper, Pewter & Polished Stainless Steel
- Custom strapping & rivets
- Full custom options

(* Trim finishes on Cooking & Refrigeration products are different substrates than the trim finishes on Ventilation hoods. Due to these differing processes and substrates the finishes will coordinate but may not match exactly.

Model	Description (* Denotes item that must be specified)	UMRP	MSRP
30" RIDGELINE HOODS:			
RL030MLPLT	Body: Stainless Steel Strap/Rivets: Stainless Steel 600 CFM	\$ 6,895	\$ 7,930
RL030MLPLTD	Body: Stainless Steel Strap/Rivets: Des. Metal* 600 CFM	\$ 7,190	\$ 8,270
RL030MLPLTTC	Body: Std RAL Color* Strap/Rivets: Stainless Steel 600 CFM	\$ 8,090	\$ 9,305
RL030MLPLTDC	Body: Std RAL Color* Strap/Rivets: Des Metal* 600 CFM	\$ 8,385	\$ 9,645
RL030MLPLTDCF	Body: Spec. Finish* Strap/Rivets: Stainless Steel 600 CFM	\$ 9,090	\$ 10,455
RL030MLPLTDCFC	Body: Spec. Finish* Strap/Rivets: Des. Metal* 600 CFM	\$ 9,385	\$ 10,795
RL030MLPLTCC	Body: Custom Color* Strap/Rivets: Stainless Steel 600 CFM	\$ 10,590	\$ 12,180
RL030MLPLTDCC	Body: Custom Color* Strap/Rivets: Des. Metal* 600 CFM	\$ 10,885	\$ 12,520
36" RIDGELINE HOODS:			
RL036MLPLT	Body: Stainless Steel Strap/Rivets: Stainless Steel 600 CFM	\$ 7,495	\$ 8,620
RL036MLPLTD	Body: Stainless Steel Strap/Rivets: Des. Metal* 600 CFM	\$ 7,890	\$ 9,075
RL036MLPLTTC	Body: Std RAL Color* Strap/Rivets: Stainless Steel 600 CFM	\$ 8,690	\$ 9,995
RL036MLPLTDC	Body: Std RAL Color* Strap/Rivets: Des Metal* 600 CFM	\$ 9,085	\$ 10,450
RL036MLPLTDCF	Body: Spec. Finish* Strap/Rivets: Stainless Steel 600 CFM	\$ 9,690	\$ 11,145
RL036MLPLTDCFC	Body: Spec. Finish* Strap/Rivets: Des. Metal* 600 CFM	\$ 10,085	\$ 11,600
RL036MLPLTCC	Body: Custom Color* Strap/Rivets: Stainless Steel 600 CFM	\$ 11,190	\$ 12,870
RL036MLPLTDCC	Body: Custom Color* Strap/Rivets: Des. Metal* 600 CFM	\$ 11,585	\$ 13,325
DESIGNER METAL OPTIONS FOR STRAPPING & RIVETS:			
Polished Stainless Steel, Brushed Brass, Antique Brass, Polished Brass, Brushed Copper & Pewter			
DUCT COVERS FOR RIDGELINE HOODS:			
Refer to page 97 for all Ridgeline hood duct cover options Refer to page 110 for Ventilation Hood Accessories			
• Included duct cover heights: 10", 16", 22", 28", 34", 40", 46"			

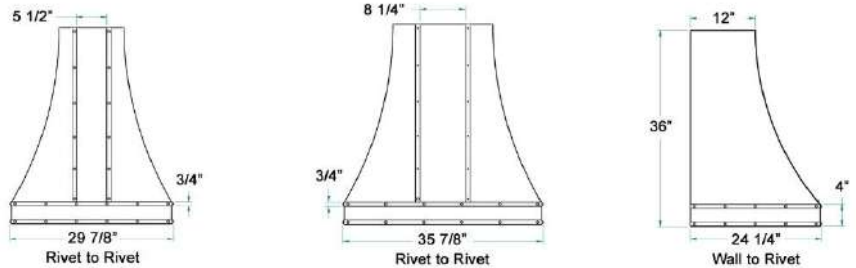

BLOWER OPTIONS	IN-HOOD		IN-LINE		REMOTE		DISCHARGE	
CFM POWER	600	1200	800	1200	1000	1400	TOP	REAR
MODEL #	BS-CFM-600-IN06	BS-CFM-1200-IN12	ATEX-0.8	ATEX-1.2	HYEX-1.0-GA	HYEX-1.4-GA		
UMRP	\$ 965	\$ 995	\$ 1,260	\$ 1,510	\$ 1,385	\$ 1,640	Available at time of order	
RL030MLPLT	•		•	•	•	•		
RL036MLPLT	•	•	•	•	•	•		
RL042MLPLT	•	•	•	•	•	•		
RL048MLPLT	•	•	•	•	•	•		
RL054MLPLT	•	•	•	•	•	•		
RL060MLPLT	•	•	•	•	•	•		

RIDGELINE VENT HOODS | DESIGNER SERIES

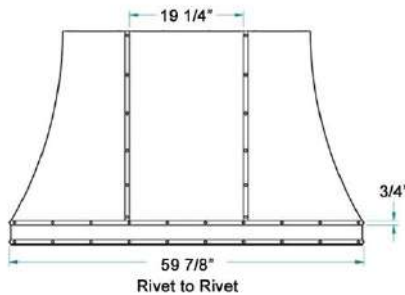
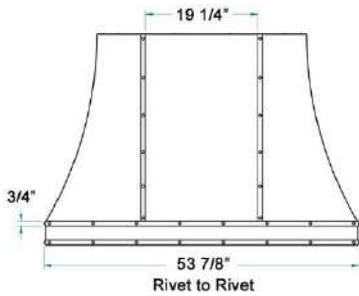
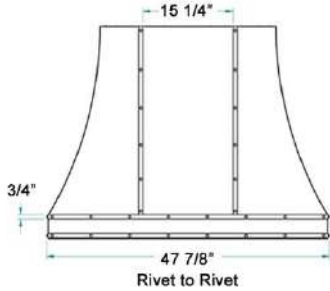
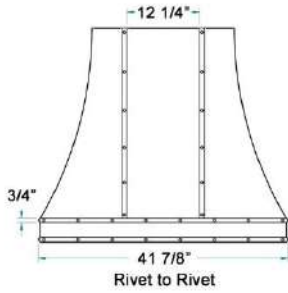

42" RIDGELINE CURVED SIDES HOODS:		UMRP	MSRP
RL042MLPLT	Body: Stainless Steel Strap/Rivets: Stainless Steel	\$ 7,995	\$ 9,195
RL042MLPLTD	Body: Stainless Steel Strap/Rivets: Des. Metal*	\$ 8,390	\$ 9,650
RL042MLPLTC	Body: Std RAL Color* Strap/Rivets: Stainless Steel	\$ 9,490	\$ 10,915
RL042MLPLTDC	Body: Std RAL Color* Strap/Rivets: Des Metal*	\$ 9,885	\$ 11,370
RL042MLPLTCF	Body: Spec. Finish* Strap/Rivets: Stainless Steel	\$ 10,590	\$ 12,180
RL042MLPLTDCF	Body: Spec. Finish* Strap/Rivets: Des. Metal*	\$ 10,985	\$ 12,635
RL042MLPLTCC	Body: Custom Color* Strap/Rivets: Stainless Steel	\$ 11,990	\$ 13,790
RL042MLPLTDCC	Body: Custom Color* Strap/Rivets: Des. Metal*	\$ 12,385	\$ 14,245
48" RIDGELINE CURVED SIDES HOODS:		UMRP	MSRP
RL048MLPLT	Body: Stainless Steel Strap/Rivets: Stainless Steel	\$ 8,495	\$ 9,770
RL048MLPLTD	Body: Stainless Steel Strap/Rivets: Des. Metal*	\$ 8,890	\$ 10,225
RL048MLPLTC	Body: Std RAL Color* Strap/Rivets: Stainless Steel	\$ 9,990	\$ 11,490
RL048MLPLTDC	Body: Std RAL Color* Strap/Rivets: Des Metal*	\$ 10,385	\$ 11,945
RL048MLPLTCF	Body: Spec. Finish* Strap/Rivets: Stainless Steel	\$ 11,090	\$ 12,755
RL048MLPLTDCF	Body: Spec. Finish* Strap/Rivets: Des. Metal*	\$ 11,485	\$ 13,210
RL048MLPLTCC	Body: Custom Color* Strap/Rivets: Stainless Steel	\$ 12,490	\$ 14,365
RL048MLPLTDCC	Body: Custom Color* Strap/Rivets: Des. Metal*	\$ 12,885	\$ 14,820
54" RIDGELINE CURVED SIDES HOODS:		UMRP	MSRP
RL054MLPLT	Body: Stainless Steel Strap/Rivets: Stainless Steel	\$ 9,895	\$ 11,380
RL054MLPLTD	Body: Stainless Steel Strap/Rivets: Des. Metal*	\$ 10,290	\$ 11,835
RL054MLPLTC	Body: Std RAL Color* Strap/Rivets: Stainless Steel	\$ 11,390	\$ 13,100
RL054MLPLTDC	Body: Std RAL Color* Strap/Rivets: Des Metal*	\$ 11,785	\$ 13,555
RL054MLPLTCF	Body: Spec. Finish* Strap/Rivets: Stainless Steel	\$ 12,490	\$ 14,365
RL054MLPLTDCF	Body: Spec. Finish* Strap/Rivets: Des. Metal*	\$ 12,885	\$ 14,820
RL054MLPLTCC	Body: Custom Color* Strap/Rivets: Stainless Steel	\$ 13,890	\$ 15,975
RL054MLPLTDCC	Body: Custom Color* Strap/Rivets: Des. Metal*	\$ 14,285	\$ 16,460
60" RIDGELINE CURVED SIDES HOODS:		UMRP	MSRP
RL060MLPLT	Body: Stainless Steel Strap/Rivets: Stainless Steel	\$ 11,595	\$ 13,335
RL060MLPLTD	Body: Stainless Steel Strap/Rivets: Des. Metal*	\$ 11,990	\$ 13,790
RL060MLPLTC	Body: Std RAL Color* Strap/Rivets: Stainless Steel	\$ 13,090	\$ 15,055
RL060MLPLTDC	Body: Std RAL Color* Strap/Rivets: Des Metal*	\$ 13,485	\$ 15,510
RL060MLPLTCF	Body: Spec. Finish* Strap/Rivets: Stainless Steel	\$ 14,190	\$ 16,320
RL060MLPLTDCF	Body: Spec. Finish* Strap/Rivets: Des. Metal*	\$ 15,585	\$ 16,775
RL060MLPLTCC	Body: Custom Color* Strap/Rivets: Stainless Steel	\$ 15,590	\$ 17,930
RL060MLPLTDCC	Body: Custom Color* Strap/Rivets: Des. Metal*	\$ 15,985	\$ 18,385

BlueStar Model Number Guide:		
Base Model (ATOXXMLPLT) Atlas Unit Width Internal Liner Type Brushed Stainless Steel Strapping & Rivets	Add code below for desired color (C) 190 Standard RAL (Semi-Gloss) Colors, (CF) Specialty Finish (190 Matte RAL, Precious Metals & Textures) or (CC) Custom Colors	Add (PLT) for Metal Strapping Standard: Brushed Stainless Steel See below for Designer Metal strapping and rivet options

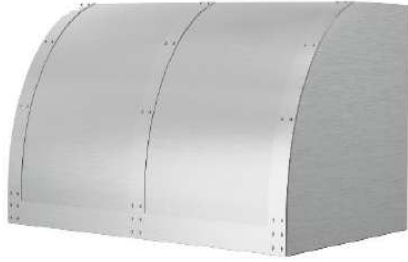

30" & 36" Atlas Wall Hood
 Standard Height: 30" | Standard Depth: 24"

FEATURES:

- Professional-grade performance with three exhaust settings and new Boost feature
- Whisper quiet operation
- Heavy duty, commercial grade materials
- Dimmable LED lighting
- Easy-to-use push-button controls
- Innovative, multi-stage grease capture system
- Stainless baffle filters seamlessly remove for easy dishwasher cleaning
- Choose from stainless steel or 1,000+ colors and finishes
- Simple installation
- 30" & 36" models: 600 CFM internal fan included (*Must be included on order*)
- Available with top or rear discharge - Discharge is field reversible.
- In-line, in-hood and remote blower compatible

CUSTOMIZATION OPTIONS:

- 1,000+ Colors & Finishes
- Designer Metals: Brushed Brass, Antique Brass, Polished Brass, Brushed Copper, Pewter & Polished Stainless Steel
- Custom strapping & rivets
- Full custom options

(* Trim finishes on Cooking & Refrigeration products are different substrates than the trim finishes on Ventilation hoods. Due to these differing processes and substrates the finishes will coordinate but may not match exactly.

Model	Description (* Denotes item that must be specified)	UMRP	MSRP
30" ATLAS HOODS: (3 Vertical Straps 1 Horizontal)			
AT030MLPLT	Body: Stainless Steel Strap/Rivets: Stainless Steel 600 CFM	\$ 5,795	\$ 6,665
AT030MLPLTD	Body: Stainless Steel Strap/Rivets: Des. Metal* 600 CFM	\$ 6,090	\$ 7,005
AT030MLPLTC	Body: Std RAL Color* Strap/Rivets: Stainless Steel 600 CFM	\$ 6,990	\$ 8,040
AT030MLPLTDC	Body: Std RAL Color* Strap/Rivets: Des Metal* 600 CFM	\$ 7,285	\$ 8,380
AT030MLPLTCF	Body: Spec. Finish* Strap/Rivets: Stainless Steel 600 CFM	\$ 7,990	\$ 9,190
AT030MLPLTDCF	Body: Spec. Finish* Strap/Rivets: Des. Metal* 600 CFM	\$ 8,285	\$ 9,530
AT030MLPLTCC	Body: Custom Color* Strap/Rivets: Stainless Steel 600 CFM	\$ 9,490	\$ 10,915
AT030MLPLTDCC	Body: Custom Color* Strap/Rivets: Des. Metal* 600 CFM	\$ 9,785	\$ 11,255
36" ATLAS HOODS: (3 Vertical Straps 1 Horizontal)			
AT036MLPLT	Body: Stainless Steel Strap/Rivets: Stainless Steel 600 CFM	\$ 6,095	\$ 7,010
AT036MLPLTD	Body: Stainless Steel Strap/Rivets: Des. Metal* 600 CFM	\$ 6,490	\$ 7,465
AT036MLPLTC	Body: Std RAL Color* Strap/Rivets: Stainless Steel 600 CFM	\$ 7,290	\$ 8,385
AT036MLPLTDC	Body: Std RAL Color* Strap/Rivets: Des Metal* 600 CFM	\$ 7,685	\$ 8,840
AT036MLPLTCF	Body: Spec. Finish* Strap/Rivets: Stainless Steel 600 CFM	\$ 8,290	\$ 9,535
AT036MLPLTDCF	Body: Spec. Finish* Strap/Rivets: Des. Metal* 600 CFM	\$ 8,685	\$ 9,990
AT036MLPLTCC	Body: Custom Color* Strap/Rivets: Stainless Steel 600 CFM	\$ 9,790	\$ 11,260
AT036MLPLTDCC	Body: Custom Color* Strap/Rivets: Des. Metal* 600 CFM	\$ 10,185	\$ 11,715
DESIGNER METAL OPTIONS FOR STRAPPING & RIVETS:			
Polished Stainless Steel, Brushed Brass, Antique Brass, Polished Brass, Brushed Copper & Pewter			
VENTILATION HOOD ACCESSORIES:			
Refer to page 110 for Ventilation Hood Accessories			

BLOWER OPTIONS-	IN-HOOD		IN-LINE		REMOTE		DISCHARGE	
	600	1200	800	1200	1000	1400	TOP	REAR
CFM POWER	600	1200	800	1200	1000	1400		
MODEL #	BS-CFM-600-IN06	BS-CFM-1200-IN12	ATEX-0.8	ATEX-1.2	HYEX-1.0-GA	HYEX-1.4-GA		
UMRP	\$ 965	\$ 995	\$ 1,260	\$ 1,510	\$ 1,385	\$ 1,640		
AT030MLPLT	•		•	•	•	•	•	Available at time of order
AT036MLPLT	•		•	•	•	•	•	
AT042MLPLT	•	•	•	•	•	•	•	
AT048MLPLT	•	•	•	•	•	•	•	
AT054MLPLT	•	•	•	•	•	•	•	
AT060MLPLT	•	•	•	•	•	•	•	
AT066MLPLT	•	•	•	•	•	•	•	

ATLAS VENT HOODS | DESIGNER SERIES



42", 48", 54" & 60" Atlas Wall Hood

Standard Height: 30" | Standard Depth: 24"



66" Atlas Wall Hood

Standard Height: 30" | Standard Depth: 24"

42" ATLAS HOODS: (4 Vertical Straps 1 Horizontal)		UMRP	MSRP
AT042MLPLT	Body: Stainless Steel Strap/Rivets: Stainless Steel	\$ 6,695	\$ 7,700
AT042MLPLTD	Body: Stainless Steel Strap/Rivets: Des. Metal*	\$ 7,090	\$ 8,155
AT042MLPLTC	Body: Std RAL Color* Strap/Rivets: Stainless Steel	\$ 8,190	\$ 9,420
AT042MLPLTDC	Body: Std RAL Color* Strap/Rivets: Des Metal*	\$ 8,585	\$ 9,875
AT042MLPLTCF	Body: Spec. Finish* Strap/Rivets: Stainless Steel	\$ 9,290	\$ 10,685
AT042MLPLTDCF	Body: Spec. Finish* Strap/Rivets: Des. Metal*	\$ 9,685	\$ 11,140
AT042MLPLTCC	Body: Custom Color* Strap/Rivets: Stainless Steel	\$ 10,690	\$ 12,295
AT042MLPLTDCC	Body: Custom Color* Strap/Rivets: Des. Metal*	\$ 11,085	\$ 12,750
48" ATLAS HOODS: (4 Vertical Straps 1 Horizontal)		UMRP	MSRP
AT048MLPLT	Body: Stainless Steel Strap/Rivets: Stainless Steel	\$ 6,895	\$ 7,930
AT048MLPLTD	Body: Stainless Steel Strap/Rivets: Des. Metal*	\$ 7,290	\$ 8,385
AT048MLPLTC	Body: Std RAL Color* Strap/Rivets: Stainless Steel	\$ 8,390	\$ 9,650
AT048MLPLTDC	Body: Std RAL Color* Strap/Rivets: Des Metal*	\$ 8,785	\$ 10,105
AT048MLPLTCF	Body: Spec. Finish* Strap/Rivets: Stainless Steel	\$ 9,490	\$ 10,915
AT048MLPLTDCF	Body: Spec. Finish* Strap/Rivets: Des. Metal*	\$ 9,885	\$ 11,370
AT048MLPLTCC	Body: Custom Color* Strap/Rivets: Stainless Steel	\$ 10,890	\$ 12,525
AT048MLPLTDCC	Body: Custom Color* Strap/Rivets: Des. Metal*	\$ 11,285	\$ 12,980
54" ATLAS HOODS: (4 Vertical Straps 1 Horizontal)		UMRP	MSRP
AT054MLPLT	Body: Stainless Steel Strap/Rivets: Stainless Steel	\$ 7,195	\$ 8,275
AT054MLPLTD	Body: Stainless Steel Strap/Rivets: Des. Metal*	\$ 7,590	\$ 8,730
AT054MLPLTC	Body: Std RAL Color* Strap/Rivets: Stainless Steel	\$ 8,690	\$ 9,995
AT054MLPLTDC	Body: Std RAL Color* Strap/Rivets: Des Metal*	\$ 9,085	\$ 10,450
AT054MLPLTCF	Body: Spec. Finish* Strap/Rivets: Stainless Steel	\$ 9,790	\$ 11,260
AT054MLPLTDCF	Body: Spec. Finish* Strap/Rivets: Des. Metal*	\$ 10,185	\$ 11,715
AT054MLPLTCC	Body: Custom Color* Strap/Rivets: Stainless Steel	\$ 11,190	\$ 12,870
AT054MLPLTDCC	Body: Custom Color* Strap/Rivets: Des. Metal*	\$ 11,585	\$ 13,325
60" ATLAS HOODS: (4 Vertical Straps 1 Horizontal)		UMRP	MSRP
AT060MLPLT	Body: Stainless Steel Strap/Rivets: Stainless Steel	\$ 7,595	\$ 8,735
AT060MLPLTD	Body: Stainless Steel Strap/Rivets: Des. Metal*	\$ 7,990	\$ 9,190
AT060MLPLTC	Body: Std RAL Color* Strap/Rivets: Stainless Steel	\$ 9,090	\$ 10,455
AT060MLPLTDC	Body: Std RAL Color* Strap/Rivets: Des Metal*	\$ 9,485	\$ 10,910
AT060MLPLTCF	Body: Spec. Finish* Strap/Rivets: Stainless Steel	\$ 10,190	\$ 11,720
AT060MLPLTDCF	Body: Spec. Finish* Strap/Rivets: Des. Metal*	\$ 10,585	\$ 12,175
AT060MLPLTCC	Body: Custom Color* Strap/Rivets: Stainless Steel	\$ 11,590	\$ 13,330
AT060MLPLTDCC	Body: Custom Color* Strap/Rivets: Des. Metal*	\$ 11,985	\$ 13,785
66" ATLAS HOODS: (5 Vertical Straps 1 Horizontal)		UMRP	MSRP
AT066MLPLT	Body: Stainless Steel Strap/Rivets: Stainless Steel	\$ 8,295	\$ 9,540
AT066MLPLTD	Body: Stainless Steel Strap/Rivets: Des. Metal*	\$ 8,690	\$ 9,995
AT066MLPLTC	Body: Std RAL Color* Strap/Rivets: Stainless Steel	\$ 9,790	\$ 11,260
AT066MLPLTDC	Body: Std RAL Color* Strap/Rivets: Des Metal*	\$ 10,185	\$ 11,715
AT066MLPLTCF	Body: Spec. Finish* Strap/Rivets: Stainless Steel	\$ 10,890	\$ 12,525
AT066MLPLTDCF	Body: Spec. Finish* Strap/Rivets: Des. Metal*	\$ 11,285	\$ 12,980
AT066MLPLTCC	Body: Custom Color* Strap/Rivets: Stainless Steel	\$ 12,290	\$ 14,135
AT066MLPLTDCC	Body: Custom Color* Strap/Rivets: Des. Metal*	\$ 12,685	\$ 14,590

BlueStar Model Number Guide:		
Base Model (MEOXXML) Mesa Unit Width Internal Liner Type	Add code below for desired color (C) 190 Standard RAL (Semi-Gloss) Colors, (CF) Specialty Finish (190 Matte RAL, Precious Metals & Textures) or (CC) Custom Colors	Add (PLT) for Metal Strapping Available through custom quote only at quote@bluestarcooking.com



Standard Height: 30" | Standard Depth: 24"

FEATURES:

- Professional-grade performance with three exhaust settings and new Boost feature
- Whisper quiet operation
- Heavy duty, commercial grade materials
- Dimmable LED lighting
- Easy-to-use push-button controls
- Innovative, multi-stage grease capture system
- Stainless baffle filters seamlessly remove for easy dishwasher cleaning
- Choose from stainless steel or 1,000+ colors and finishes
- Simple installation
- 30" & 36" models: 600 CFM internal fan included *(Must be included on order)*
- Available with top or rear discharge - Discharge is field reversible.
- In-line, in-hood and remote blower compatible

CUSTOMIZATION OPTIONS:

- 1,000+ Colors & Finishes
- Designer Metals: Brushed Brass, Antique Brass, Polished Brass, Brushed Copper, Pewter & Polished Stainless Steel
- Custom strapping & rivets
- Full custom options

() Trim finishes on Cooking & Refrigeration products are different substrates than the trim finishes on Ventilation hoods. Due to these differing processes and substrates the finishes will coordinate but may not match exactly.*

Model	Description (* Denotes item that must be specified)	UMRP	MSRP
ME030ML	30" Mesa Stainless Steel 600 CFM Blower	\$ 3,795	\$ 4,365
ME030MLC	30" Mesa Std RAL Color* 600 CFM Blower	\$ 4,990	\$ 5,740
ME030MLCF	30" Mesa Specialty Finish* 600 CFM Blower	\$ 5,990	\$ 6,890
ME030MLCC	30" Mesa Custom Color* 600 CFM Blower	\$ 7,490	\$ 8,615
ME036ML	36" Mesa Stainless Steel 600 CFM Blower	\$ 3,895	\$ 4,480
ME036MLC	36" Mesa Std RAL Color* 600 CFM Blower	\$ 5,090	\$ 5,855
ME036MLCF	36" Mesa Specialty Finish* 600 CFM Blower	\$ 6,090	\$ 7,005
ME036MLCC	36" Mesa Custom Color* 600 CFM Blower	\$ 7,590	\$ 8,730
ME042ML	42" Mesa Stainless Steel	\$ 4,095	\$ 4,710
ME042MLC	42" Mesa Std RAL Color*	\$ 5,590	\$ 6,430
ME042MLCF	42" Mesa Specialty Finish*	\$ 6,690	\$ 7,695
ME042MLCC	42" Mesa Custom Color*	\$ 8,090	\$ 9,305
ME048ML	48" Mesa Stainless Steel	\$ 4,395	\$ 5,055
ME048MLC	48" Mesa Std RAL Color*	\$ 5,890	\$ 6,775
ME048MLCF	48" Mesa Specialty Finish*	\$ 6,990	\$ 8,040
ME048MLCC	48" Mesa Custom Color*	\$ 8,390	\$ 9,650
ME054ML	54" Mesa Stainless Steel	\$ 4,495	\$ 5,170
ME054MLC	54" Mesa Std RAL Color*	\$ 5,990	\$ 6,890
ME054MLCF	54" Mesa Specialty Finish*	\$ 7,090	\$ 8,155
ME054MLCC	54" Mesa Custom Color*	\$ 8,490	\$ 9,765
ME060ML	60" Mesa Stainless Steel	\$ 4,795	\$ 5,515
ME060MLC	60" Mesa Std RAL Color*	\$ 6,290	\$ 7,235
ME060MLCF	60" Mesa Specialty Finish*	\$ 7,390	\$ 8,500
ME060MLCC	60" Mesa Custom Color*	\$ 8,790	\$ 10,110
ME066ML	66" Mesa Stainless Steel	\$ 5,095	\$ 5,860
ME066MLC	66" Mesa Std RAL Color*	\$ 6,590	\$ 7,580
ME066MLCF	66" Mesa Specialty Finish*	\$ 7,690	\$ 8,845
ME066MLCC	66" Mesa Custom Color*	\$ 9,090	\$ 10,455
VENTILATION HOOD ACCESSORIES:			
Refer to page 110 for Ventilation Hood Accessories			

BLOWER OPTIONS	IN-HOOD		IN-LINE		REMOTE		DISCHARGE	
CFM POWER	600	1200	800	1200	1000	1400	TOP	REAR
MODEL #	BS-CFM-600-IN06	BS-CFM-1200-IN12	ATEX-0.8	ATEX-1.2	HYEX-1.0-GA	HYEX-1.4-GA		
UMRP	\$ 965	\$ 995	\$ 1,260	\$ 1,510	\$ 1,385	\$ 1,640	Available at time of order	
ME030ML	•		•	•	•	•		
ME036ML	•	•	•	•	•	•		
ME042ML	•	•	•	•	•	•		
ME048ML	•	•	•	•	•	•		
ME054ML	•	•	•	•	•	•		
ME060ML	•	•	•	•	•	•		
ME066ML	•	•	•	•	•	•		

BlueStar Model Number Guide:

Base Model (NR0XXMLPLT) Normandy Unit Width Internal Liner Type Brushed Stainless Steel Lower Reveal	Add code below for desired color (C) 190 Standard RAL (Semi-Gloss) Colors, (CF) Specialty Finish (190 Matte RAL, Precious Metals & Textures) or (CC) Custom Colors	Add (PLT) for Metal Strapping Available through custom quote only at quote@bluestarcooking.com
---	--	---

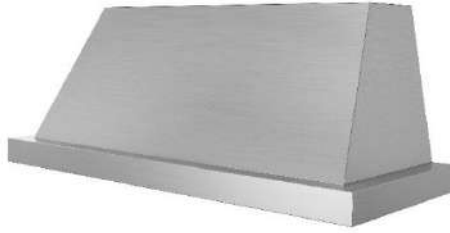

Standard Height: 30" | Standard Depth: 24"

FEATURES:

- Professional-grade performance with three exhaust settings and new Boost feature
- Whisper quiet operation
- Heavy duty, commercial grade materials
- Dimmable LED lighting
- Easy-to-use push-button controls
- Innovative, multi-stage grease capture system
- Stainless baffle filters seamlessly remove for easy dishwasher cleaning
- Choose from stainless steel or 1,000+ colors and finishes
- Simple installation
- 36" models: 600 CFM internal fan included (*Must be included on order*)
- Available with top or rear discharge - Discharge is field reversible.
- In-line, in-hood and remote blower compatible

CUSTOMIZATION OPTIONS:

- 1,000+ Colors & Finishes
- Designer Metals: Brushed Brass, Antique Brass, Polished Brass, Brushed Copper, Pewter & Polished Stainless Steel
- Custom strapping & rivets
- Full custom options

Model	Description (* Denotes item that must be specified)	UMRP	MSRP
All hoods include a brushed stainless steel lower reveal. For a lower reveal in a designer metal finish request a quote at quote@bluestarcooking.com			
NR036ML	36" Normandy Stainless Steel 600 CFM Blower	\$ 6,295	\$ 7,240
NR036MLC	36" Normandy Std RAL Color* 600 CFM Blower	\$ 7,490	\$ 8,615
NR036MLCF	36" Normandy Specialty Finish* 600 CFM Blower	\$ 8,490	\$ 9,765
NR036MLCC	36" Normandy Custom Color* 600 CFM Blower	\$ 9,990	\$ 11,490
NR042ML	42" Normandy Stainless Steel	\$ 6,695	\$ 7,700
NR042MLC	42" Normandy Std RAL Color*	\$ 8,190	\$ 9,420
NR042MLCF	42" Normandy Specialty Finish*	\$ 9,290	\$ 10,685
NR042MLCC	42" Normandy Custom Color*	\$ 10,690	\$ 12,295
NR048ML	48" Normandy Stainless Steel	\$ 8,695	\$ 10,000
NR048MLC	48" Normandy Std RAL Color*	\$ 10,190	\$ 11,720
NR048MLCF	48" Normandy Specialty Finish*	\$ 11,290	\$ 12,985
NR048MLCC	48" Normandy Custom Color*	\$ 12,690	\$ 14,595
VENTILATION HOOD ACCESSORIES:			
Refer to page 110 for Ventilation Hood Accessories			

(* Trim finishes on Cooking & Refrigeration products are different substrates than the trim finishes on Ventilation hoods. Due to these differing processes and substrates the finishes will coordinate but may not match exactly.

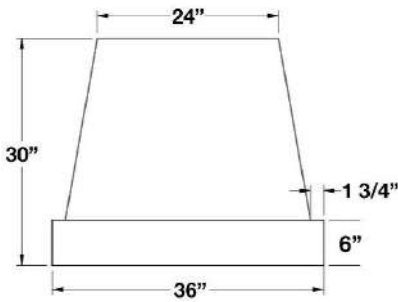

36" Dimensions

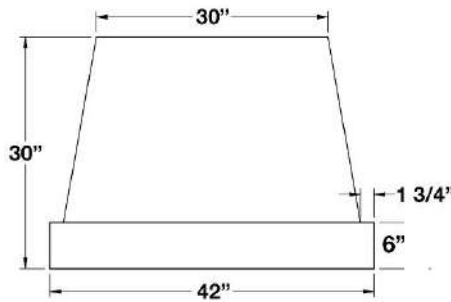

42" Dimensions

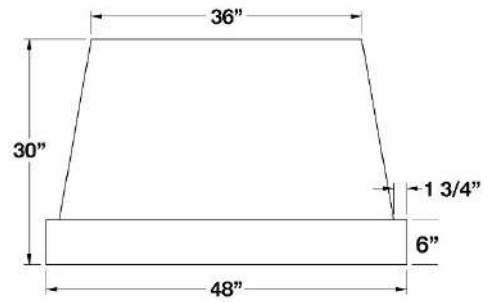

48" Dimensions

BLOWER OPTIONS	IN-HOOD		IN-LINE		REMOTE		DISCHARGE	
CFM POWER	600	1200	800	1200	1000	1400	TOP	REAR
MODEL #	BS-CFM-600-IN06	BS-CFM-1200-IN12	ATEX-0.8	ATEX-1.2	HYEX-1.0-GA	HYEX-1.4-GA		
MSP	\$ 965	\$ 995	\$ 1,260	\$ 1,510	\$ 1,385	\$ 1,640	Available at time of order	
NR036MLPLT	•	•	•	•	•	•		
NR042MLPLT	•	•	•	•	•	•		
NR048MLPLT	•	•	•	•	•	•		
NR054MLPLT	•	•	•	•	•	•		
NR060MLPLT	•	•	•	•	•	•		
NR066MLPLT	•	•	•	•	•	•		

NORMANDY VENT HOODS | DESIGNER SERIES

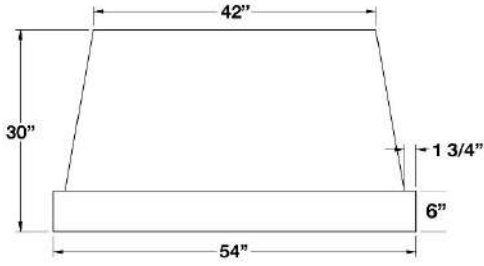

54" Dimensions

54" NORMANDY HOODS		UMRP	MSRP
NR054ML	54" Normandy Stainless Steel	\$ 9,195	\$ 10,575
NR054MLC	54" Normandy Std RAL Color*	\$ 10,690	\$ 12,295
NR054MLCF	54" Normandy Specialty Finish*	\$ 11,790	\$ 13,560
NR054MLCC	54" Normandy Custom Color*	\$ 13,190	\$ 15,170

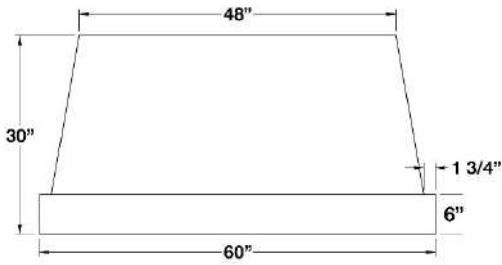

60" Dimensions

60" NORMANDY HOODS		UMRP	MSRP
NR060ML	60" Normandy Stainless Steel	\$ 9,895	\$ 11,380
NR060MLC	60" Normandy Std RAL Color*	\$ 11,390	\$ 13,100
NR060MLCF	60" Normandy Specialty Finish*	\$ 12,490	\$ 14,365
NR060MLCC	60" Normandy Custom Color*	\$ 13,890	\$ 15,975

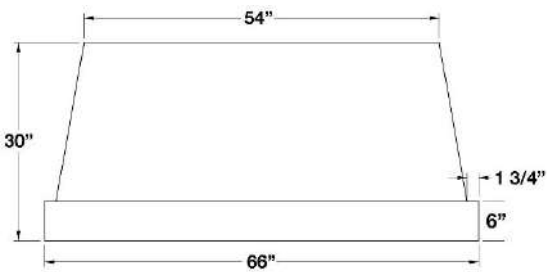

66" Dimensions

66" NORMANDY HOODS		UMRP	MSRP
NR066ML	66" Normandy Stainless Steel	\$ 10,595	\$ 12,185
NR066MLC	66" Normandy Std RAL Color*	\$ 12,090	\$ 13,905
NR066MLCF	66" Normandy Specialty Finish*	\$ 13,190	\$ 15,170
NR066MLCC	66" Normandy Custom Color*	\$ 14,590	\$ 16,780

CUSTOMIZATION & ACCESSORY OPTIONS | VENTILATION

BLOWERS & TRANSITIONS: BLUESTAR PROFESSIONAL & DESIGNER SERIES HOODS			
Model	Description	UMRP	MSRP
BLOWERS AND TRANSITIONS: PL, PY, BZ, HA, MA, SC,WR, RL, AT, ME, NR & PM			
BS-CFM-600-IN06	INTERNAL 3 speed 600 cfm blower	\$ 965	\$ 1,110
BS-CFM-1200-IN12	INTERNAL 3 speed 1200 cfm blower	\$ 995	\$ 1,145
ATEX-0.8	800 CFM IN LINE 8" DUCT	\$ 1,260	\$ 1,450
ATEX-1.2	1200 CFM IN LINE 10" DUCT	\$ 1,510	\$ 1,735
SW-ATEX1.2	Wall Switch for ATEX Series Inline Blowers	\$ 140	\$ 160
HYEX-1.0-GA	1000 CFM 8" DUCT GALVALUME	\$ 1,385	\$ 1,595
HYEX-1.4-GA	1400 CFM 10" DUCT GALVALUME	\$ 1,640	\$ 1,885
781100	Wall Switch for HYEX Series Remote Blowers	\$ 65 ea	\$ 75 ea
SM-10	Muffler & Isolation Clamps - 10" Duct	\$ 620	\$ 715
SM-08	Muffler & Isolation Clamps - 8" Duct	\$ 550	\$ 635

Model	Description	UMRP	MSRP
BLOWERS & TRANSITIONS: MANHATTAN ISLAND & PRE-MAY 2020 VENTILATION HOODS			
PH-CFM-600	INTERNAL 3 speed 600 cfm blower	\$ 965	\$ 1,110
PH-CFM-1200	INTERNAL 3 speed 1200 cfm blower	\$ 1,385	\$ 1,595
PH-CFMR-1000	REMOTE 3 speed 1000 cfm blower	\$ 1,890	\$ 2,175
PH-CFMR-1400	REMOTE 3 speed 1400 cfm blower	\$ 2,020	\$ 2,325
PH-INLB600	INLINE 3 speed 600 cfm INLINE blower	\$ 1,520	\$ 1,750
PH-INLB1200	INLINE 3 speed 1200 cfm INLINE blower	\$ 1,875	\$ 2,155
780038	Transition for top discharge, 6 x 15 to 8" round - 8" h. with damper	\$ 295	\$ 340
780037	Transition for top discharge, 6 x 15 to 10" round - 8" h. with damper	\$ 305	\$ 350
780188	Transition for rear discharge, 6 x 15 to 8" round - 3.5" h. without damper	\$ 295	\$ 340
780189	Transition for rear discharge, 6 x 15 to 10" round - 3.5" h. without damper	\$ 305	\$ 350

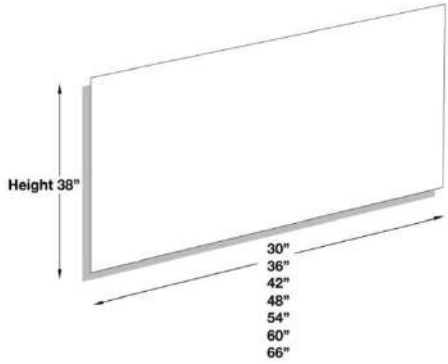
WALL LINERS:				
	Model	Description	UMRP	MSRP
 <p>Height 38"</p> <p>30" 36" 42" 48" 54" 60" 66"</p>	WL-30-SS	Wall Liner: 30"w x 38"h	\$ 485	\$ 560
	WL-36-SS	Wall Liner: 36"w x 38"h	\$ 525	\$ 605
	WL-42-SS	Wall Liner: 42"w x 38"h	\$ 550	\$ 635
	WL-48-SS	Wall Liner: 48"w x 38"h	\$ 575	\$ 660
	WL-54-SS	Wall Liner: 54"w x 38"h	\$ 600	\$ 690
	WL-60-SS	Wall Liner: 60"w x 38"h	\$ 650	\$ 745
	WL-66-SS	Wall Liner: 66"w x 38"h	\$ 675	\$ 775

CUSTOMIZATION SUMMARY GUIDE

COOKING: FREESTANDING RANGES	Product	Standard RAL Paint Paint Semi-Gloss (C)	Custom Finishes Matte & Textures (CF)	Custom Colors Custom Match (CC)	Plated Trim Kit (PLT)
	24" Models	\$ 1,195	\$ 2,195	\$ 3,695	\$ 1,595
	30" Models	\$ 1,195	\$ 2,195	\$ 3,695	\$ 1,595
	36" Models	\$ 1,195	\$ 2,195	\$ 3,695	\$ 1,895
	48" Models	\$ 1,495	\$ 2,595	\$ 3,995	\$ 2,195
	60" Models	\$ 1,495	\$ 2,595	\$ 3,995	\$ 2,495

COOKING: WALL OVENS	Product	Standard RAL Paint Paint Semi-Gloss (C)	Custom Finishes Matte & Textures (CF)	Custom Colors Custom Match (CC)	Plated Trim Kit (PLT)
	30" Double	\$ 1,495	\$ 2,395	\$ 3,795	\$ 2,395
	24" Single	\$ 1,195	\$ 2,195	\$ 3,695	\$ 1,095
	30" Single	\$ 1,195	\$ 2,195	\$ 3,695	\$ 1,595
	36" Single	\$ 1,195	\$ 2,195	\$ 3,695	\$ 1,595

COOKING: RANGETOPS, & COOKTOPS	Product	Standard RAL Paint Paint Semi-Gloss (C)	Custom Finishes Matte & Textures (CF)	Custom Colors Custom Match (CC)	Plated Trim Kit (PLT)
	24" Models	N/C	N/C	N/C	\$ 795
	30" Models	N/C	N/C	N/C	\$ 795
	36" Models	N/C	N/C	N/C	\$ 1,095
	48" Models	N/C	N/C	N/C	\$ 1,495
	60" Models	N/C	N/C	N/C	\$ 1,795

COOKING: KNOBS	Product	Standard RAL Paint Paint Semi-Gloss (C)	Custom Finishes Matte & Textures (CF)	Custom Colors Custom Match (CC)	Plated (PLT)
	Knob Price Each	\$ 115 ea	\$ 185 ea	\$ 200 ea	\$ 250 ea

REFRIGERATION:	Product	Standard RAL Paint Paint Semi-Gloss (C)	Custom Finishes Matte & Textures (CF)	Custom Colors Custom Match (CC)	Plated Trim Kit (PLT)
	36" Built-In (Swing Door)	\$ 1,495	\$ 1,995	\$ 3,295	\$ 1,395
	36" French Door (BIR or Counter-Depth)	\$ 1,595	\$ 2,095	\$ 3,295	\$ 1,595
	Built-In Painted Top Grill	\$ 250	\$ 250	\$ 250	\$ 250
	18" Columns	\$ 1,095	\$ 1,595	\$ 2,895	\$ 1,195
	24" Columns	\$ 1,095	\$ 1,595	\$ 2,895	\$ 1,195
	30" Columns	\$ 1,395	\$ 1,995	\$ 3,295	\$ 1,195

VENTILATION:	Product	Standard RAL Paint Paint Semi-Gloss (C)	Custom Finishes Matte & Textures (CF)	Custom Colors Custom Match (CC)	Plated Trim Kit (PLT)
	30" Models	\$ 1,195	\$ 2,195	\$ 3,695	\$ 295
	36" Models	\$ 1,195	\$ 2,195	\$ 3,695	\$ 395
	42" Models	\$ 1,495	\$ 2,595	\$ 3,995	\$ 395
	48" Models	\$ 1,495	\$ 2,595	\$ 3,995	\$ 395
	54" Models	\$ 1,495	\$ 2,595	\$ 3,995	\$ 395
	60" Models	\$ 1,495	\$ 2,595	\$ 3,995	\$ 395
	66" Models	\$ 1,495	\$ 2,595	\$ 3,995	\$ 395



318 June Avenue, Blandon, PA 19510
(800) 449 - 8691