



Inspired by Scandinavia

ASKO
List Price Book



CAN YOU FIND THE DISHWASHER?

Experience ASKO's perfectly
seamless integration.



PINNACLE
SALES GROUP

ASKO List Price Book
Effective July 1, 2025
www.pinnaclesalesgroup.com
800-292-8374

See Our Current
Price Book



Our Story

The beginning of ASKO was an act of love – no more, no less. In the 1950s, a young farmer in Jung, south of Lidköping in Sweden, saw his mother's predicament: washing by hand is wet, cold, hard and heavy. He wished to ease her burden, and so he invented his own washing machine.

It had superior cleaning performance, with built-in water heating, spinning and a durable stainless steel structure. When others saw his machine, they wanted one too. Pretty soon, production began.

More than 70 years later, ASKO is a global brand that designs and develops premium kitchen and laundry appliances for homes and businesses. We manufacture our products to the highest possible standards and develop our domestic appliances based on professional principles.

Today, ASKO helps people around the world to cook, clean and care for their families while looking after the environment. With a uniquely Scandinavian approach, ASKO combines award-winning design with innovative features and smart solutions. We create products and services that are destined to become a much-loved part of people's homes and lives.



TABLE OF CONTENTS

	Page
Our Story	2
Dishwashers	4
World's Most Advanced Dishwasher	8
Features	10
Item Number Nomenclature Tool	13
Available Models	14
Accessories	19
Gel Dishwasher Detergent	20
Programs	22
Laundry	26
Designs	30
Washing Machine Features	32
Tumble Dryer Features	34
Available Models	36
Hidden Helpers™	44
Liquid Laundry Detergent	48
Programs	50
Drying Cabinets	52
Wine Cabinet	58
Dishwasher Line Drawings	61
ASKO Warranty and Service Information	62



Dishwashers

With our assortment of ASKO dishwashers we give you value for money in every detail. With sturdy flexible racks and among the lowest water and energy consumption on the market, they will meet all your demands when choosing a new dishwasher. Our XXL models have the world's largest loading height and largest loading capacity rack system with space for up to the dinner settings you need for 18 people - which is over 200 items!

Why choose ASKO Dishwashers?



MORE STEEL, LESS PLASTIC

Designed to last for 20 years, ASKO's dishwashers are made of stainless steel; no other dishwashers have so many details in steel instead of plastic. No other material lasts as long as steel. This is why we produce our dishwashers with 8 Steel™; eight of the most important components are made of high-quality steel rather than plastic, such as; container, loading racks, spray pipe, spray arms, strainers, outer base, feet, and inner door. Our machines are built to last longer, and they do.

WORLD'S LARGEST CAPACITY

Our dishwashers offer loading capacity for up to 18 place settings and room for larger plates and taller glasses. The interior loading tub measures between 23 15/64 inches high for our XL dishwashers and 24 51/64 inches high for our XXL dishwashers allowing you to load up to 40% more dishes compared to other dishwashers.

Depending on the model, ASKO offers the possibility of loading on three or four levels.

Our dishwashers offer the largest amount of internal height while maintaining standard external dimensions. They fit in a space of 34-36 in (XXL) or 32-34.5 in (XL).

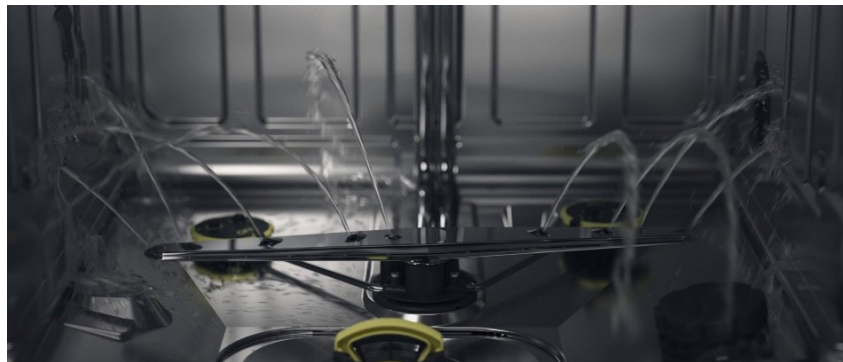

SUPERIOR CLEANING SYSTEM

The Super Cleaning System+™ thoroughly cleans the tub and spray system to improve both washing performance and the machine's longevity.

AUTO DOSE

Select dishwashers come equipped with Auto Dose, eliminating the need to add detergent before every load. Use ASKO's Gel Detergent or your favorite brand. Adjusts the dosage of detergent to the soiling level depending on program, water hardness level and program type to an optimal level to avoid overdosing and a minimizing the environmental footprint.



QUIET AND POWERFUL

Your ASKO dishwasher is so silent, down to 39 dB(A) (37 dB(A) with Night mode), that we had to design a convenient feature: the Status Light™. Blue signifies when you can still open the door to load more items, red signifies when it's too late to do so and green signifies when the dishes are ready.

For all of us who let the dishwasher work while we sleep, we have created night mode. With this mode the water pressure in the spray arms is lowered, reducing the noise level by as much as 2 dB(A). This mode is also perfect for open floor plans with seamless kitchen and living spaces.

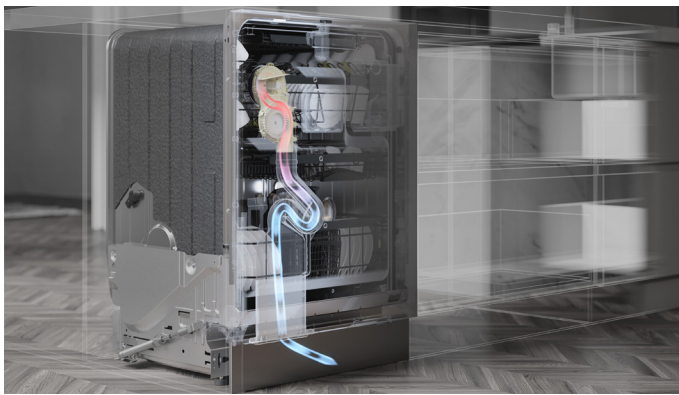

TURBO COMBI DRYING™

No one wants to spend time drying dishes by hand before they go back into cabinets. That's the dishwasher's job, and ASKO has perfected their technology to keep consumers from having to do this extra task. Available in select models, Turbo Combi Drying™ combines fan-assisted drying and sensor controlled automatic door open drying to get a perfect drying result also for plastic to minimize moisture and shorten the program time to use the minimum amount of energy possible.

UV CLEANSE MODE

With regard to hygiene, one of the most remarkable new functions is UV Cleanse™, which uses UV light to help eliminate 99.99999% of the bacteria that can make its way into a load of dishes. Additionally, a special Hygiene program with an additional disinfecting effect can be used on loads that require extra-special care – like baby bottles.

During the final rinse, the water is sanitised with UV light and heat to kill microorganisms. The result is a market leading reduction of bacteria and other microbes. UV Cleanse mode in combination with Intensive or Sanitize programs eliminates up to 99.99999% of bacteria, fungi and viruses.

Available on 60+ Models

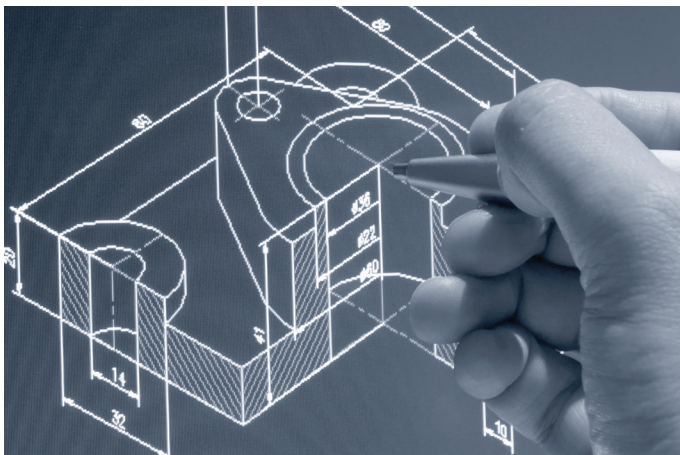

SCANDINAVIAN DESIGN

Beyond the logic and the interfaces, we want ASKO appliances to express our Scandinavian design values – through premium materials and minimalistic design they refine your home, without taking over. We design our products to make sure they support and enhance their environment. We want your kitchen experience to be less cluttered and more relaxing and enjoyable.

But to us, design is more than just appearance. It is also about user friendliness, function, quality and the environment. By developing long lasting products, we contribute to a reduced environmental footprint and a low life cycle cost for our customers. Since our products last longer, we also incorporate a timeless design in order to last aesthetically.

All New Features

- Turbo Combi Drying™ with Sensor Controlled Automatic Door Opening
- Basket Accent Color
- Brushless DC Motors
- Wine glass Holders
- Adjustable Power Zones
- WiFi Capability
- Baskets that Slide on Ball Bearings
- Anti-Odor Function
- Interior Light with 3 times stronger luminous flux
- Adaptable Water Pressure
- Adaptive Green Mode
- Quick Pro Program
- Auto Dose
- Touch Control with TFT color display
- 39dB(A) (37 dB(A) with Night mode)
- Push to Open Door
- UV Cleanse Mode
- 4 Baskets
- 18 Place Settings
- 10 Spray
- Sliding door model





THE WORLD'S MOST ADVANCED DISHWASHER!

Responsibility means a lot of different things. Today, there's a strong connection to sustainability, for example. The definition of sustainability is to make sure that things are kept in a state of equilibrium, or improved, rather than made worse.

The new ASKO dishwashers are designed to shoulder these responsibilities. In it, innovative and efficient features meet the most demanding standards of hygiene, efficiency, safety, and performance.



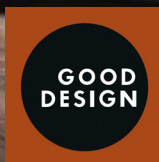

Long-lasting appliances are sustainable: and they need to be reliable, too, fulfilling their household responsibilities for a long time. As a result, this dishwasher is constructed with more steel than plastic and tested for the equivalent of 20 years' worth of use. So not only will it provide care, it will also act as a long-lasting companion – taking care of you and your household for longer.

With all this in mind – and all of these responsibilities considered, approached and met – **we feel confident in saying that this is the world's most advanced dishwasher.**



Dishwasher Features



Features	40 Series	50 Series	60/60+ Series
Tub Type	XL/XXL Tub	XL/XXL Tub	XL/XXL Tub
LED Interior Lights	—	2	4
Status Light	Yes	Yes	Yes
Place Setting Capacity	16	16	17 (60) / 18 (60+)
dB(A)	42 (40 dB(A) with Night mode)	40 (38 dB(A) with Night mode)	39 (37 dB(A) with Night mode)
Energy Star			60  / 60+ 
Cutlery Tray <small>*All models include a Cutlery Basket</small>	Top tray w/ Instant Lift™	Top tray w/ Instant Lift™ and ball bearings	Top tray w/ Instant Lift™ and ball bearings (60+)
Upper Rack	Premium upper rack (height adjustable)	Exclusive upper rack (height adjustable)	Exclusive upper rack (height adjustable)
Middle Rack	—	—	Exclusive middle rack with removable inserts
Lower Rack	Premium lower rack	Exclusive lower rack	Exclusive lower rack
Auto Dose	—	—	Yes
UV Cleanse Mode	—	—	Yes (60+)
WiFi Capability	—	Yes	Yes
Turbo Combi Drying™	Yes	Yes	Yes



Auto Dose

Through years of research, we have identified the exact amount of detergent needed to deliver consistently perfect cleaning results. That's our job. Of course, we don't expect you to spend time thinking about this. That's why we designed Auto Dose. The auto dosing compartment in our dishwashers stores up to 30 days' worth of detergent. This means you only need to fill it once a month. Just load your dishes, choose your program, and you're ready to go. Hassle-free, as it should be.

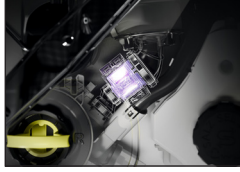

UV Cleanse Mode

With regard to hygiene, one of the most remarkable new functions is UV Cleanse™, which uses UV light to help eliminate 99.9999% of the bacteria that can make its way into a load of dishes. A special Hygiene program with an additional disinfecting effect can be used on loads that require extra-special care – like baby bottles. Additionally, This ASKO dishwasher keeps itself spotless with a dedicated Self-cleaning program which deep-cleans the entire tank and circulation system.

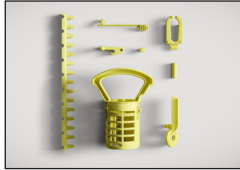

Accent Colors

Inspired by the lichens on our Scandinavian seashore rocks and the bursting sprouts at spring time, our accent color helps you find the spots inside our dishwasher that needs extra attention. Parts which allow interaction is color coded for improved visibility and guidance.



WiFi Capability

The ConnectLife app lets you control and monitor your ASKO dishwasher remotely via your smartphone or tablet. You can look up the online user manual, change settings, check the machine's status and more. You can even start, stop and pause programs on the move. The app includes a step-by-step guide to help you find the best programs for you depending on what you're washing and how you prefer to wash it.

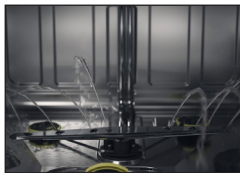

Super Cleaning System+™

Our Super Cleaning System+™ (SCS+) will save you time, electricity, water and effort, by eliminating the handwashing step for consumers. This patented system cleans the fine filter and all the interior surfaces after pre-wash, and before running the main wash.



Turbo Combi Drying™

Get every load completely dry. After the final rinse, the moist air inside the dishwasher is mixed with the dry air outside and sensor controlled automatic door opening of the dishwasher which dries dishes, glassware, and cutlery completely this system.



World Class Loading Capacity

Our dishwashers have world class loading capacity with room for larger plates and taller glasses, 16-18 place settings (depending on model). It also means that you can load 40% more compared to a standard dishwasher.



Beautiful, Timeless, Elegant and Efficient

Our current 40, 50, 60 and 60+ series dishwashers have earned the Most Efficient energy label. Equipped with reliable, brushless motors, making the engine motors quieter, down to 39 dB(A) (37 dB(A) with Night mode). Enhance your favorite dishwashing program with modes that reduce cycle time, noise, water consumption and energy consumption.



8 Steel™

No other material lasts as long as steel. And no other dishwashers have as many details made from steel instead of plastic as ASKO dishwashers. In fact, eight of the most important components in our dishwashers are made of high-quality steel rather than plastic.

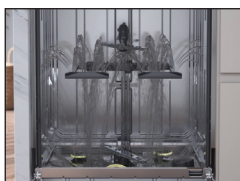

10 Spray™

ASKO's spray system consists of up to 10 highly effective spray zones which ensure that the whole load gets totally clean, two of them are adjustable Power Zones™. The two Power Zones™ are located under the lower rack, making the washing performance perfect even for the dirtiest pots and pans, or vases/baby bottles.

Sliding door opening system

The sliding door system ensures easy installation and a seamless, integrated look in your kitchen. The decorative door of the dishwasher slides up when the dishwasher is open and slides down when it's closed, which means there is only a two-millimeter gap between the bottom of the dishwasher door and the baseboard or drawer located below it.

Practical and pleasing to the eye, the sliding door system can remove the need to cut baseboards and ensures easier installation at height. It also ensures that the dishwasher works in perfect harmony with your kitchen – no matter what design you desire.

Perfect for elevated installation, long doors, and when the socket is flush with the door.

* Model DSD565 on Page 15

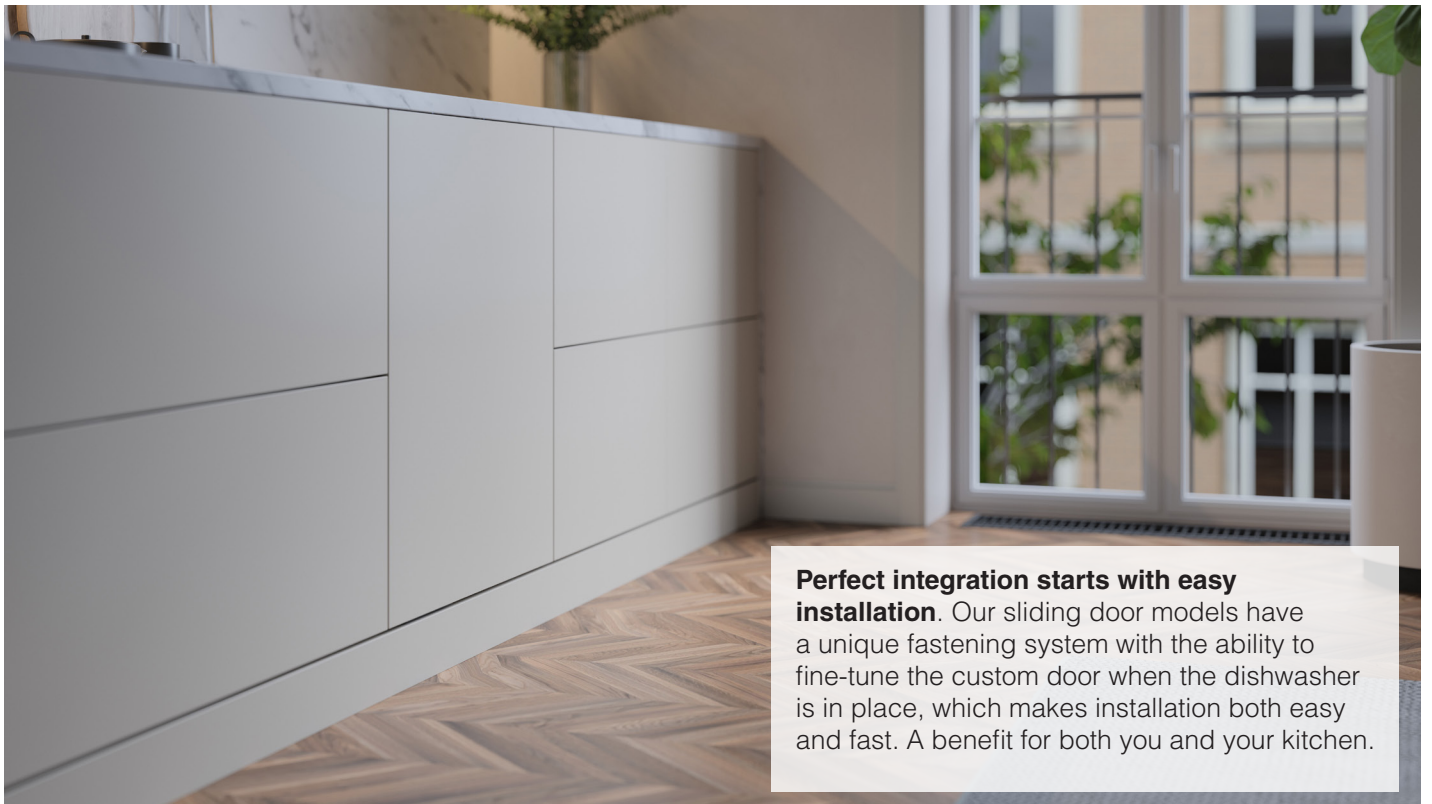

Door slides down when closing



Door slides up when opening



Door slides up when opening



DISHWASHER MODEL NUMBER NOMENCLATURE

D	BI	7	7	6	I	XXL	S	SOF
1	2	3	4	5	6	7	8	9

Nomenclature Position	Description	Options
1st	Type	D - Dishwasher
2nd	Installation Type	BI - Built-In FI - Panel Ready SD - Panel Ready Sliding door (including automatic door opening) OD - Outdoor
3rd	Interface	3 - Classic gen 1 5 - Logic gen 1 7 - Style gen 1
4th	Labeled capacity	6 - 16 places 7 - 17 places 8 - 18 places
5th	Sound level	1 - 48 dB 2 - 46 dB 3 - 44 dB 4 - 42 dB 5 - 40 dB 6 - 39 dB
6th	Exterior handle	(no letters for FI) I - Pocket Handle T - ASKO T-bar TH - Tubular PH - Pro handle P - ASKO Pro Handle
7th	Size	(no letters for XL) XXL
8th	Color	(no letters for FI) S - Stainless steel
9th	Softener	(no letter for models without softener) SOF - softener

40 SERIES DISHWASHERS



DBI564IS

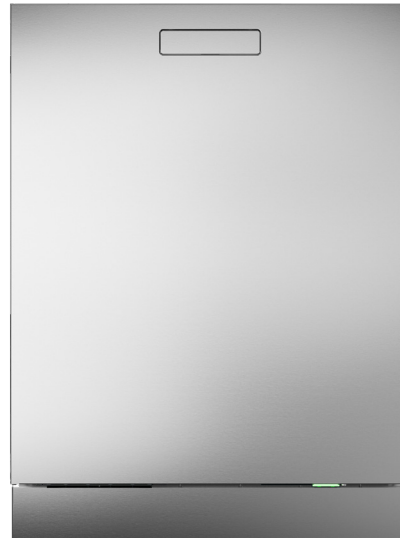

Shown with Pocket Handle

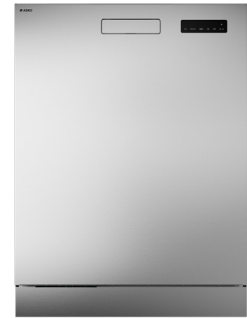

Pocket Handle with Front Control



Features

- 16 Place Settings
- 42 (40 dB(A) with Night Mode)
- Energy Star Most Efficient
- 9 Spray Zones including 2 Adjustable Power Zones™
- 8 Steel™
- Designed for 20 Years of Use
- Aqua Safe™
- Status Light
- Super Cleaning System+™
- Turbo Combi Drying™
- TouchProof™ Coating
- Sabbath Mode
- XL Tub - ADA Height Compliant
- XXL Tub - Largest Interior Height on the Market

Baskets/Flexiracks™

- Height adjustable top tray
- Premium upper rack
- Premium lower rack
- Cutlery basket

MODEL NUMBER	DESCRIPTION	HANDLE	FINISH	TUB TYPE	2025 PROMO UMRP	UMRP	MSRP
DBI564IS	24" Dishwasher, 40 Series	Pocket	Stainless	XL	\$ 1,149	\$ 1,299	\$ 1,399
DBI364IS	24" Dishwasher, 40 Series	Pocket	Stainless	XL		\$ 1,299	\$ 1,399
DFI564	24" Dishwasher, 40 Series	N/A	Panel Ready	XL		\$ 1,299	\$ 1,399
DBI564ISSOF	24" Dishwasher, 40 Series, Water Softener	Pocket	Stainless	XL		\$ 1,349	\$ 1,449
DBI564TS	24" Dishwasher, 40 Series	ASKO T-Bar	Stainless	XL		\$ 1,399	\$ 1,499
DFI564XXL	24" Dishwasher, 40 Series, XXL Tub	N/A	Panel Ready	XXL		\$ 1,399	\$ 1,499
DBI564IXXLS	24" Dishwasher, 40 Series, XXL Tub	Pocket	Stainless	XXL		\$ 1,399	\$ 1,499
DBI564PS	24" Dishwasher, 40 Series	ASKO Pro	Stainless	XL		\$ 1,499	\$ 1,599

* See Page 19 for available accessories and line drawings on Page 61



Panel Ready



Pocket Handle



ASKO T-Bar Handle



ASKO Pro Handle

Inventory levels are subject to change, check stock via Dealer Login on www.pinnaclesalesgroup.com

STOCK ITEMS ARE LISTED IN RED



50 SERIES DISHWASHERS



Special Promotional UMRP on Select Models through Dec. 31, 2025



Features

DBI565TXXLS

Shown with T-Bar Handle

- 16 Place Settings
- **40 (38 dB(A) with Night mode)**
- Energy Star Most Efficient
- **WiFi Enabled via ConnectLife App**
- 9 Spray Zones including 2 Adjustable Power Zones™
- 8 Steel™ Designed for 20 Years of Use
- Aqua Safe™
- Super Cleaning System+™

- **Sensor Controlled Turbo Combi Drying™**
- Status Light™
- **2 LED Interior Lights**
- TouchProof™ Coating
- Sabbath Mode
- Auto Program
- XL Tub - ADA Height Compliant
- XXL Tub - Largest Interior Height on the Market

Baskets/Flexiracks™

- **Height adjustable top tray with telescopic ball bearing rails**
- **Exclusive height adjustable upper rack**
- **Exclusive lower rack**
- Cutlery basket



MODEL NUMBER	DESCRIPTION	HANDLE	FINISH	TUB TYPE	2025 PROMO UMRP	UMRP	MSRP
DFI565	24" Dishwasher, 50 Series	N/A	Panel Ready	XL		\$ 1,749	\$ 1,849
DSD565	24" Dishwasher, 50 Series, Sliding Door	N/A	Panel Ready	XL		\$ 1,849	\$ 1,949
DBI565IXXLS	24" Dishwasher, 50 Series, XXL Tub	Pocket	Stainless	XXL	\$ 1,649	\$ 1,849	\$ 1,949
DFI565XXL	24" Dishwasher, 50 Series, XXL Tub	N/A	Panel Ready	XXL	\$ 1,649	\$ 1,849	\$ 1,949
DFI565XXLSOF	24" Dishwasher, 50 Series, XXL Tub, Water Softener	N/A	Panel Ready	XXL		\$ 1,899	\$ 1,999
DBI565TXXLS	24" Dishwasher, 50 Series, XXL Tub	ASKO T-Bar	Stainless	XXL	\$ 1,749	\$ 1,949	\$ 2,049
DBI565THXXLS	24" Dishwasher, 50 Series, XXL Tub	Tubular	Stainless	XXL	\$ 1,599	\$ 1,799	\$ 1,899
DBI565PHXXLS	24" Dishwasher, 50 Series, XXL Tub	Pro	Stainless	XXL	\$ 1,649	\$ 1,849	\$ 1,949
DBI565PXXLS	24" Dishwasher, 50 Series, XXL Tub	ASKO Pro	Stainless	XXL	\$ 1,849	\$ 2,049	\$ 2,149

* See Page 19 for available accessories and line drawings on Page 61



Panel Ready



Pocket Handle



Tubular Handle



ASKO T-Bar Handle



Pro Handle



ASKO Pro Handle

Inventory levels are subject to change, check stock via Dealer Login on www.pinnaclesalesgroup.com



DBI776IXLSSOF

60 SERIES DISHWASHER

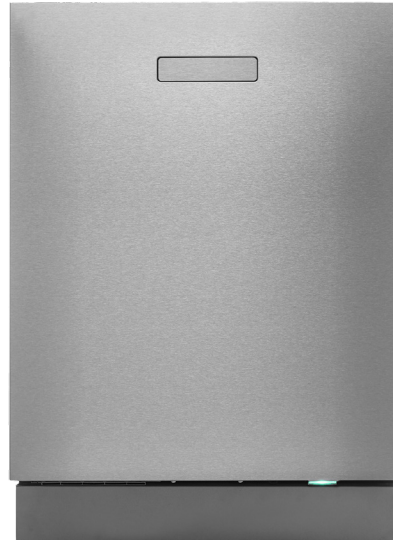

Shown with Pocket Handle

ConnectLife



Features

- **17 Place Settings**
- **39 (37 dB(A) with Night mode)**
- Energy Star Most Efficient
- WiFi Enabled via ConnectLife App
- **Extra wide and easy-to-read high-definition TFT display**
- 9 Spray Zones including 2 Adjustable Power Zones™
- 8 Steel™ Designed for 20 Years of Use
- Aqua Safe™
- Super Cleaning System+™
- Sensor Controlled Turbo Combi Drying™
- Status Light™
- **4 LED Interior Lights**
- TouchProof™ Coating
- Sabbath Mode
- Auto Program
- **Auto Dose**
- **Push to Open Door (Panel Ready)**

Baskets/Flexiracks™

- Exclusive height adjustable upper rack
- **Exclusive middle rack with removable inserts**
- Exclusive lower rack
- Cutlery basket



MODEL NUMBER	DESCRIPTION	HANDLE	FINISH	TUB TYPE	UMRP	MSRP
DBI776IXLSSOF	24" Dishwasher, 60 Series, XXL Tub, Water Softener	Pocket	Stainless	XXL	\$ 2,299	\$ 2,499
DFI776XXLSOF	24" Dishwasher, 60 Series, XXL Tub, Water Softener	N/A	Panel Ready	XXL	\$ 2,299	\$ 2,499

* See Page 19 for additional stainless steel door options or available accessories and line drawings on Page 61



Panel Ready



Pocket Handle

Inventory levels are subject to change, check stock via Dealer Login on www.pinnaclesalesgroup.com

STOCK ITEMS ARE LISTED IN RED



DFI786XXLSOF

60+ SERIES DISHWASHER



Shown in Panel Ready



Features

- **18 Place Settings**
- 39 (37 dB(A) with Night mode)
- Energy Star
- WiFi Enabled via ConnectLife App
- Extra wide and easy-to-read high-definition TFT display
- **10 Spray Zones including 2 Adjustable Power Zones™**
- 8 Steel™
Designed for 20 Years of Use
- Aqua Safe™

- Super Cleaning System+™
- Sensor Controlled Turbo Combi Drying™
- Status Light™
- 4 LED Interior Lights
- TouchProof™ Coating
- Sabbath Mode
- Auto Program
- Auto Dose
- **UV Cleanse Mode**
- Push to Open Door (Panel Ready)

Baskets/Flexiracks™

- **Easy height adjustment top tray with telescopic ball bearing rails**
- Exclusive height adjustable upper rack
- Exclusive middle rack with removable inserts
- Exclusive lower rack
- Cutlery basket



MODEL NUMBER	DESCRIPTION	HANDLE	FINISH	TUB TYPE	UMRP	MSRP
DBI786IXLSSOF	24" Dishwasher, 60+ Series, XXL Tub, Water Softener	Pocket	Stainless	XXL	\$ 2,699	\$ 2,899
DFI786XXLSOF	24" Dishwasher, 60+ Series, XXL Tub, Water Softener	N/A	Panel Ready	XXL	\$ 2,699	\$ 2,899

* See Page 19 for additional stainless steel door options or available accessories and line drawings on Page 61



Panel Ready



Pocket Handle

Inventory levels are subject to change, check stock via Dealer Login on www.pinnaclesalesgroup.com

OUTDOOR DISHWASHER



DOD561TXXLS



Features

- **OUTDOOR RATED**
Only available UL certified
Outdoor dishwasher
- 16 Place Settings
- 48 dB(A)
- Energy Star®
- Auto Door Open Drying™
- 7 Spray Zones
- 8 Steel™
Designed for 20 Years of Use
- Aqua Safe™
- Super Cleaning System+™
- TouchProof™ Coating
- **Freestanding with Stainless Steel Housing**

Baskets/Flexiracks™

- Height adjustable top tray
- Premium Upper Rack
- Premium Lower Rack
- Cutlery Basket

MODEL NUMBER	DESCRIPTION	HANDLE	FINISH	TUB TYPE	UMRP	MSRP
DOD561TXXLS	24" Outdoor Dishwasher, XXL Tub	T-Bar	Stainless	XXL	\$ 3,899	\$ 4,099

* See Page 19 for available accessories and line drawings on Page 61

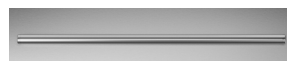

ASKO T-Bar Handle

Inventory levels are subject to change, check stock via Dealer Login on www.pinnaclesalesgroup.com

STOCK ITEMS ARE LISTED IN RED

DISHWASHER ACCESSORIES



Stainless door without handle (for 60/60+ panel ready with push to open)



Tubular Handle



ASKO Pro Handle



ASKO T-Bar Handle



Pro Handle



Small Cutlery Basket

MODEL NUMBER	DESCRIPTION	FINISH	UMRP	MSRP
450087	23 5/8" Individual Door, ASKO T-Bar Handle, Stainless Steel	Stainless	\$ 259	\$ 269
902622	24" Individual Door, ASKO Pro Handle, Stainless Steel	Stainless	\$ 319	\$ 329
902607	24" Individual Door, No Handle, Stainless Steel	Stainless	\$ 229	\$ 239
450089	24" Individual Door, ASKO T-Bar Handle, Stainless Steel	Stainless	\$ 259	\$ 269
602908	Small Cutlery Basket		\$ 24	\$ 29
886703	Pro Handle Kit		\$ 144	\$ 154
886704	Tubular Handle Kit		\$ 109	\$ 119
886705	ASKO T-Bar Handle Kit		\$ 99	\$ 109
903881	ASKO Pro Handle Kit		\$ 119	\$ 129



Stainless door w/o handle



Tubular Handle



ASKO Pro Handle



ASKO T-Bar Handle



Pro Handle

Inventory levels are subject to change, check stock via Dealer Login on www.pinnaclesalesgroup.com

GEL DISHWASHER DETERGENT



Dishwasher Gel Detergent

Benefits

- 99% Natural Ingredients
- Nordic Asthma & Allergy and Swan Ecolabel
- Designed for Auto Dose System
- Fragrance Free
- Color Free
- 3-in-1 Formula Contains Salt and Rinse Aid
- Easy Fill Flip Cap
- Effective for Short Washing Cycles



MODEL NUMBER	DESCRIPTION	UMRP	MSRP
LD10	Dishwasher Gel Detergent, 1L	\$ 23.99	\$ 24.99

Inventory levels are subject to change, check stock via Dealer Login on www.pinnaclesalesgroup.com

AVAILABLE DOOR OPTIONS

40 SERIES DISHWASHERS

Panel Ready	Pocket Handle	ASKO T-Bar Handle	ASKO Pro Handle
			
DFI564 DFI564XXL	DBI364IS DBI564IS DBI564ISSOF DBI564IXXLS	DBI564TS	DBI564PS

50 SERIES DISHWASHERS

Panel Ready	Pocket Handle	Tubular Handle	ASKO T-Bar Handle	Pro Handle	ASKO Pro Handle
					
DFI565 DSD565 DFI565XXL DFI565XXLSOF	DBI565IXXLS	DBI565THXXLS	DBI565TXXLS	DBI565PHXXLS	DBI565PXXLS

60 SERIES DISHWASHERS

Panel Ready	Pocket Handle
	
DFI776SOF DFI776XXLSOF	DBI776IXXLSSOF

60+ SERIES DISHWASHERS

Panel Ready	Pocket Handle
	
DFI786XXLSOF	DBI786IXXLSSOF

Intuitive and effective programs

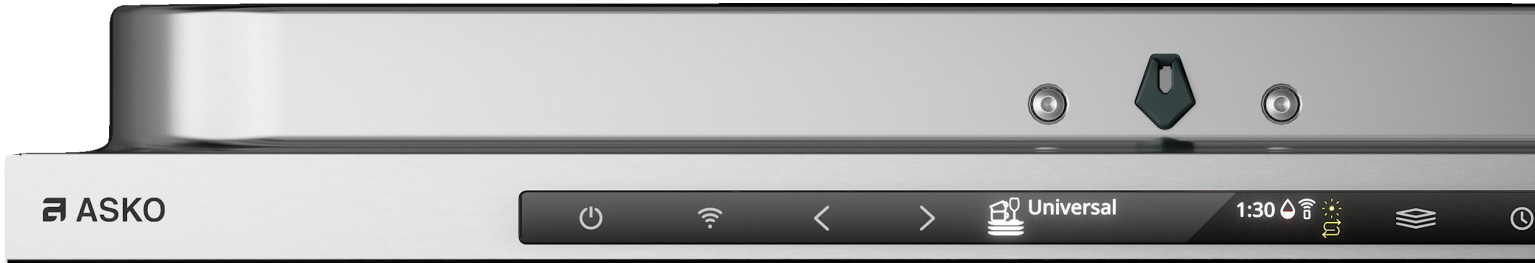

DISHWASHER PROGRAMS

Normal

A powerful program for daily use when you want to clean plates, cutlery and glasses after the evening dinner. It removes dried leftovers from your dishes and also cleans pots and pans.

Eco

This program is ideal for cleaning regularly soiled dishes and is the most effective in terms of combined energy and water consumption.

Auto

This program measures how dirty the dishes are and automatically adjusts program parameters, water consumption and temperature accordingly. When newly installed, the program must be run five times before it is fully adapted and can provide optimal results.

Light

A powerful program for daily use that is shorter than the Normal program. Removes dried food, but is not intended for burnt food, such as oven dishes. This program provides maximum rinse effect.

Quick Pro

A program with highest rating according to EU label standard for cleaning performance, still very short – 59 minutes. Only on models with adaptable water pressure.

Time program

This program adapts to the specified running time or finish time. When using this program, it is important to select a time that suits how soiled the dishes are.

Rinse and hold

With this program you can rinse dishes while waiting for the dishwasher to become fully loaded.

Plastic

This program has an extra-long drying phase and is ideal for washing plastic items that are dishwasher safe. It is also suitable for porcelain and glasses.

Sanitize

This program is perfect for times when hygiene demands are extra high, for example, when cleaning baby bottles and cutting boards. The temperature is high in both the main wash and in the final rinse

Intensive

A program with a high temperature to dissolve grease on very dirty dishes, such as pans, casserole dishes and oven dishes.



Crystal

A gentle low-temperature program ideal for cleaning fragile items like fine wine glasses and crystal. This program can also be used to clean recently used porcelain providing it is free of dried leftovers.

Self-cleaning

The self-cleaning program is designed to clean the dishwasher itself and ensures that the dishwasher tub, spray arms and spray pipes are cleaned to the highest hygienic standards.

Upper half wash

This program is used when you only want to clean cups and glasses loaded in the upper basket. You also have the option of loading slightly soiled dishes in the lower basket, where they will be cleaned.

Lower half wash

This program is used when you only want to clean plates and cutlery loaded in the lower basket. You also have the option of loading slightly soiled dishes in the upper basket, where they will be cleaned.

Anti-Odor

This function will activate the door fan which is normally used for evacuating moist air during the drying cycle.

* See Page 24 for availability of these programs per different dishwasher series.

DISHWASHER MODES

Normal Mode

A dishwasher mode designed for daily use, powerful enough to clean your dinner plates, pots and pans after a delicious evening.

Heat Boost Mode

A high-temperature program designed to dissolve grease on extremely soiled dishes such as pans, casserole dishes and oven dishes. If these dishes do not completely fill the dishwasher, you can safely add plates and other dishes.

Green Adaptive Mode

Green mode saves both water and energy. The temperature is lowered and each stage of the cycle is extended to save water and achieve the same perfect cleaning results as a normal program. Models featured with AUTO program will have a water consumption level down to 2 gallons including two fresh water rinses depending on soil level.

Speed Mode

If you want your dishes cleaner faster, select speed mode to reduce the program running time by 50%. To achieve the best possible washing results in the time available, more water and energy are used.

Night Mode

For those who like to let the dishwasher clean while they sleep, we have created night mode. With this mode the water pressure in the spray arms is lowered, reducing the noise level by as much as 2 dB(A). This quieter mode is also perfect for open floor plan living spaces.

UV Cleanse Mode

The water in the final rinse is sanitized with the UV light and by the heat from the last rinse to kill microorganisms. The dishwasher uses more energy, and the program time is extended.

DISHWASHER PROGRAMS

Programs	40 Series	50 Series	60 Series	60+ Series	Outdoor Model
ECO wash	—	—	X	X	—
Intensive	X	X	X	X	X
Normal wash	X	X	X	X	X
Auto wash	—	X	X	X	—
Quick	X	—	—	—	X
Quick Pro	—	X	X	X	—
Time program	X	X	X	X	X
Upper half wash	—	—	X	X	—
Lower half wash	—	—	X	X	—
Sanitize wash	X	X	X	X	X
Rinse & hold	X	X	X	X	X
Crystal glass	—	—	X	X	—
Self-cleaning	X	X	X	X	X
Plastic wash	—	—	X	X	—
Light program	X	—	X	X	X
Anti-Odor	X	X	X	X	X

DISHWASHER MODES

Modes	40 Series	50 Series	60 Series	60+ Series	Outdoor Model
Normal	X	X	X	X	X
Adaptive Green	—	—	X	X	—
Speed	X	X	X	X	X
Night	X	X	X	X	X
UV	—	—	—	X	—
Heat Boost	—	—	X	X	—





Laundry

Despite our over 70 years in the industry, we do not rest on our laurels, we always strive to understand how we can make our products even better. This time around we have done our best to learn from real people, finding out what they think are the biggest problems in the laundry room.

We combined these insights with our years of experience in both residential and commercial laundry to create a generation of attractive, user-friendly, innovative and long-lasting washing machines and tumble dryers.

Why choose ASKO Laundry?



MORE STEEL, LESS PLASTIC

A fully steel tub reduces bad smells inside the washing machine – and therefore, on your clothes. It helps eliminate the films of bacteria and fungi that create nasty odors in the washing machine that can be transferred to your laundry. ASKO washing machines also have double stainless steel drums – in which the outer drums are also made from stainless steel, instead of plastic.

BUILT LIKE A PROFESSIONAL

ASKO washing machines and dryers have a long-lasting and exclusive design along with innovative functionalities designed to make your everyday life easier. Our domestic washers and dryers are based on our Professional platform. They are manufactured with high-quality steel parts that can withstand the test of time. ASKO follows the most recent quality management standards (ISO 9001) and complies with the most rigorous environmental standards (ISO 14001, EMAS). ASKO is a Scandinavian brand that is globally recognized for its design and performance.



SCANDINAVIAN DESIGN

The combination of everyday functionality, environmental concern and clean, pleasant lines is the principal hallmark of Scandinavian design – and that of ASKO. The fundamental idea is that carefully designed products should improve people's quality of life. To distinguish ourselves in a market of cluttered, complex and voluptuous designs, we aim for a soft, humanistic minimalism based on the principle of quiet being the new loud. The key elements of Scandinavian design – understated elegance, high-quality craftsmanship and natural materials – are reflected in ASKO's design language. Much emphasis is also placed on functionality. We strive to make life easier by offering truly user-friendly interfaces, integration of practical functions and trouble-free, durable products that please people for a long time.



QUATTRO CONSTRUCTION™

All our washing machines have the unique Quattro Construction™. Noise level and vibration control are becoming increasingly important as it becomes more common to live in apartments with the laundry room close to living areas. Our contribution to better living conditions for people living next door to the washer is called Quattro Construction™. This is a unique yet simple system consisting of a stainless steel inner and outer drum, cast iron counter weights and four shock absorbers that transfer the vibrational energy from the outer drum to the bottom plate of the machine. In fact, the entire construction stands inside the casing and spins at maximum rpm, achieving virtually no vibrations. The Quattro Construction™ system is extremely durable and prolongs the life of the entire machine.

HYGIENIC STEEL SEAL™

A better alternative to the traditional rubber seal is the hygienic and maintenance-free Steel Seal™ solution that you find on all ASKO washing machines. There is simply no place for dirt to gather. Unlike other front load washing machines, ASKO's Steel Seal™ eliminates the presence of smell and mold.



BUTTERFLY DRYING™

This smart tumble dryer feature is our own invention. It saves both the motor and your ironing board. The unique paddles inside the drum tumble the clothes in a figure eight motion to prevent the clothes from bundling. This leads to a reduced need to reverse the drum rotation. This is an intelligent function which saves the motor and the belt from any unnecessary strain and your clothes from creasing.

Designs



Classic

Our Classic models have a program for every living situation and with the four run modes, you can quickly adjust the programs to make them either more environmentally friendly or wash more intensively. The interface is easy to understand and straightforward to use with a selection knob for program selection and buttons for each option. The front plate, panel and controls have the same timeless, discreet and elegant white design that will last forever.



Logic

For the Logic models we focused on a minimalistic appearance with sleek lines and a balanced color scheme between the front plate, panel and display. Harmony is key here and the Logic models are suited to all types of integration where appearance is important. This is the logical choice for everyone and caters to the need for both design and function.



Style

The Style models have a full-size front made from a single piece of solid steel that surrounds the stylish horizontally brushed aluminium panel. The front, panel, display and other visible components boast a perfect fit and finish and the full-color high-definition TFT display provides the best possible overview of the available functions, modes, and status. We have not compromised on any material, which is why all the knobs and buttons are made of carefully polished metal and designed to offer the best feel and response when used.

Classic



Logic



Style



Washing Machine Features





Steel Seal™ door for better hygiene

A common feature of all commercial washing machines, whether they are used in hotels, beauty salons or retirement homes, is that they have no rubber seal. And there's good reason. Eliminating a rubber door seal that can degrade over time and trap dirt and grime ensures a more hygienic wash. You will also find loading and unloading easier with the Steel Seal™ door solution. All ASKO washers have this long lasting door solution.



Quattro Construction™ for long-life operation

Our contribution to better living conditions for people living next door to the washer is called Quattro Construction™. This is a unique yet simple system consisting of a stainless steel inner and outer drum, cast iron counter weights and four shock absorbers that transfer the vibrational energy from the outer drum to the bottom plate of the machine.



Auto Dose system – dosing with precision

With the Auto Dosing system, the only thing you need to do is select the soil level of the load and then leave the rest of the decision making to the clever algorithms that control the Auto Dose system. In addition to always delivering exactly the right amount of detergent, the Auto Dose system ensures that the water and detergent are well mixed before reaching the clothes in the drum.



Active Drum™

The hourglass-shaped lifters guide the load to the gentler center area of the drum. The load is better balanced in the drum reducing wear and tear on drive belt and motor. All lifters are removable for easy cleaning.



Long-life brushless motor

Our washing machines are fitted with brushless motors to ensure that the machine can cope with the highest spin speeds while reducing noise levels and increasing the life of the machine. High efficiency ensures reduced energy consumption and the motor also allows for speed control, enabling the further development of washing programs.



ASKO Pro Wash™ provides extra washing power

Instead of just relying on the water at the bottom of the drum, the ASKO Pro Wash™ system actively circulates the water and detergent mix from the bottom of the drum to the top. On the top of the drum there are two nozzles that spray the mix over the inner drum efficiently soaking the entire load. This means the load is soaked faster, which enables superb washing and rinsing performance even with very short washing cycles.

Features	Classic	Logic	Style
Drum Volume	2.1 Cu. Ft.	2.8 Cu. Ft.	2.8 Cu. Ft.
Clothing Capacity	17.6 lbs	24.3 lbs	26.5 lbs
Washing Programs	15	22	25
Modes	4	5	6
Energy Star		—	—
Display	High Quality LCD display	High Quality LCD display	Full graphic color display (TFT)
Auto Dosing	—	—	Yes
ASKO Pro Wash™	—	—	Yes
Steel Seal™	Yes	Yes	Yes
Colors Available	White	White / Titanium	White

Tumble Dryer Features





Butterfly Drying™

This smart feature is our own invention. It saves both the motor and your ironing board. The unique paddles inside the drum tumble the clothes in a figure eight motion to prevent the clothes from bundling. This leads to a reduced need to reverse the drum rotation. This is an intelligent function which saves the motor and the belt from any unnecessary strain and your clothes from creasing.



Steam refresh program

With the steam function, our heat pump dryers offer you a product that takes caring for your clothes to a new level. Steam is a highly effective and gentle means to care for your shirts, jackets and trousers. It is an easy way of getting your favorite shirts creaseless, but can also be used for refreshing clothes that don't need washing.



Stainless steel Active Drum™

At ASKO, we believe not only that stainless steel will outlast plastic, but also that quality materials will always look better in years to come. Eventually, galvanized steel rusts, so we decided to make our drums out of stainless steel. That's why our tumble dryers really do last longer.



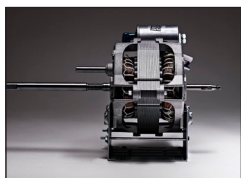

Soft Drum™ and Air Lift™ paddles

Soft Drum™ is a solution developed to enhance air flow around the load, thereby increasing the drying effect. The circular indentations with beveled edges also have a cushioning effect reducing wear and tear on fabrics. The design allows for even and gentle drying with both small and large loads. We also feature a new paddle design in the shape of the Air lift™ paddles, designed to lift the load as high as possible for increased time in the air to enhance the drying effect and shorten the drying time.



Brushless motor

The motor in your new ASKO tumble dryer will not break down. Want to know the secret? It's because we have fitted our tumble dryers with strong and very long-lasting brushless motors, which are also quieter and more energy efficient. The key word here is "brushless", because brushes wear out and without them that's one less part that can break.

Features	Classic	Logic	Style
Drum Volume	4.1 Cu. Ft.	5.1 Cu. Ft.	5.1 Cu. Ft.
Clothing Capacity	17.6 lbs	24.3 lbs	24.3 lbs
Drying Programs	9 (Condenser / Vented) 10 (Heat Pump)	13 (Vented) 16 (Heat Pump)	15 (Vented)
Display	High Quality LCD display	High Quality LCD display	Full graphic color display (TFT)
Interior LED light	—	Yes	Yes
Steam refresh	—	Yes (Heat Pump)	—
Colors Available	White	White Titanium (Vented)	White
Stacking Kit	Included	Included	Included
Energy Star	 (Heat Pump)	 Most Efficient 2024 (Heat Pump)	—

CLASSIC SERIES WASHING MACHINE White



W2084W

Washing Machine Features

- Drum volume: 2.1 cu. ft.
- Load weight: 17.6 lbs
- Full steel design concept
- 1400 rpm spin speed
- 15 programs
- Steel Seal™ hygienic door sealing
- Cold water connection
- Super Rinse™
- 4 run modes
- Quattro™ construction
- Active Drum™
- Inner and outer drums in stainless steel
- High Quality LCD display
- Brushless motor
- Pedestal Drawer with Shelf (Optional)



Washing machine and tumble dryer sets are stackable and pair great with select hidden helpers to maximize the space in your laundry room. Add a drying cabinet for the ultimate laundry care package.
(Excludes single laundry care shelf)

MODEL NUMBER	DESCRIPTION	FINISH	UMRP	MSRP
W2084W	24" Washer, Classic, White	White	\$ 1,699	\$ 1,799
HPS5323W	Pedestal Drawer with Shelf, White	White	\$ 749	\$ 779

* See Page 46 for Available Hidden Helpers and accessories

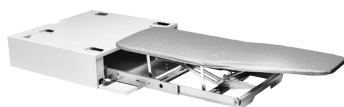

Inventory levels are subject to change, check stock via Dealer Login on www.pinnaclesalesgroup.com

STOCK ITEMS ARE LISTED IN RED

CLASSIC SERIES TUMBLE DRYER White

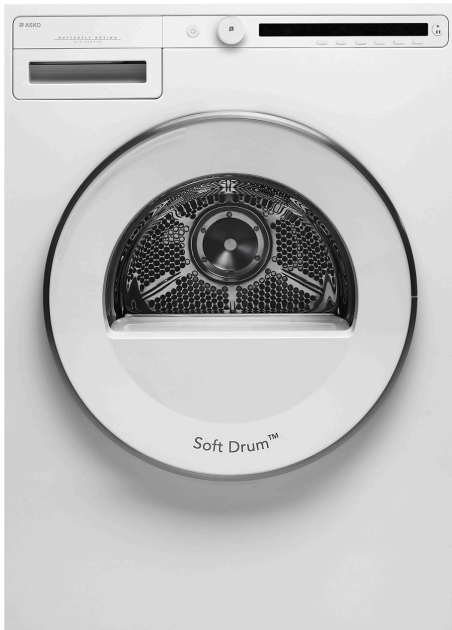

T208VW



T208CW



T208HW



* Heat pump model only

Tumble Dryer Features

- Drum volume: 4.1 cu. ft.
- Load weight: 17.6 lbs
- Full steel design concept
- Soft Drum™
- Air Lift™ Paddles
- Butterfly Drying™
- Brushless motor
- 9 programs (10 on heat pump model)
- Energy Star (heat pump model)
- High Quality LCD display
- SensiDry
- Pedestal Drawer with Shelf (Optional)

MODEL NUMBER	DESCRIPTION	FINISH	TYPE	UMRP	MSRP
T208VW	24" Vented Dryer, Classic, White	White	Vented	\$ 1,299	\$ 1,399
T208CW	24" Condenser Dryer, Classic, White	White	Condenser	\$ 1,599	\$ 1,699
T208HW	24" Heat Pump Dryer, Classic, White	White	Heat Pump	\$ 1,699	\$ 1,799
HPS5323W	Pedestal Drawer with Shelf, White	White		\$ 749	\$ 779



Inventory levels are subject to change, check stock via Dealer Login on www.pinnaclesalesgroup.com

LOGIC SERIES WASHING MACHINE White / Titanium

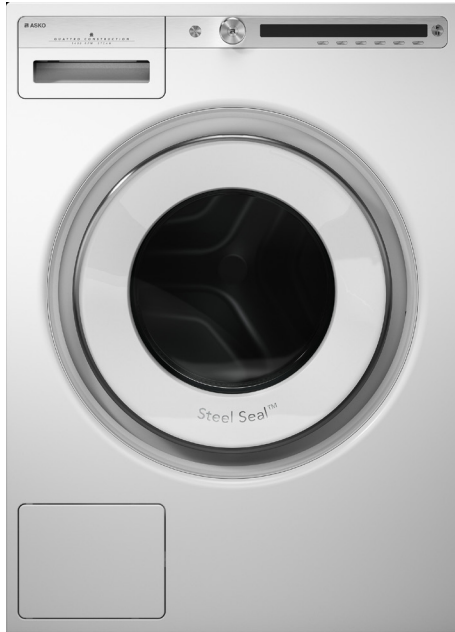

W4114CW



W4114CT



Washing machine and tumble dryer sets are stackable and pair great with select hidden helpers to maximize the space in your laundry room. Add a drying cabinet for the ultimate laundry care package.
(Excludes single laundry care shelf)

Washing Machine Features

- Drum volume: 2.8 cu. ft.
- Load weight: 24.3 lbs
- Full steel design concept
- 1400 rpm spin speed
- 21 programs
- Steel Seal™ hygienic door sealing
- Cold water connection
- Super Rinse™
- 5 run modes
- Quattro™ construction
- Active Drum™
- Inner and outer drums in stainless steel
- High Quality LCD display
- Brushless motor
- Steam
- Cast iron counter weights
- Build Your Laundry Pair with any Combination of Logic or Style Products



MODEL NUMBER	DESCRIPTION	FINISH	UMRP	MSRP
W4114CW	24" Washer, Logic, White	White	\$ 2,299	\$ 2,499
W4114CT	24" Washer, Logic, Titanium	Titanium	\$ 2,399	\$ 2,599
HPS6324W	Logic & Style Pedestal Riser, White	White	\$ 499	\$ 529

* See Page 46 for Available Hidden Helpers and accessories

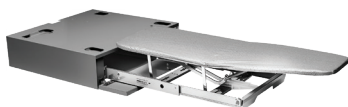

Inventory levels are subject to change, check stock via Dealer Login on www.pinnaclesalesgroup.com

STOCK ITEMS ARE LISTED IN RED

LOGIC SERIES TUMBLE DRYER White / Titanium

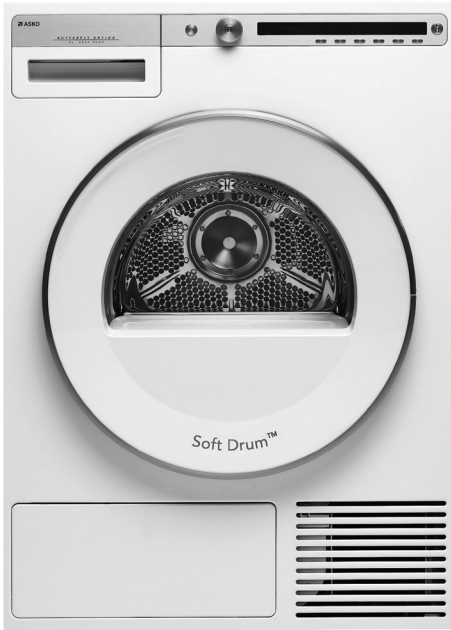

T411HSW



T411VDT



T411VDW



* Heat pump model only

Tumble Dryer Features

- Drum volume: 5.1 cu. ft.
- Load weight: 24.3 lbs
- Full steel design concept
- Soft Drum™
- Air Lift™ Paddles
- Butterfly Drying™
- Brushless motor
- 13 programs (16 on heat pump model)
- Energy Star most efficient (heat pump model)
- High Quality LCD display
- SensiDry
- Interior LED light
- Steam (heat pump model)
- Build Your Laundry Pair with any Combination of Logic or Style Products



MODEL NUMBER	DESCRIPTION	FINISH	TYPE	UMRP	MSRP
T411VDW	24" Vented Dryer, Logic, White	White	Vented	\$ 1,599	\$ 1,699
T411VDT	24" Vented Dryer, Logic, Titanium	Titanium	Vented	\$ 1,699	\$ 1,799
T411HSW	24" Heat Pump Dryer, Logic, White	White	Heat Pump	\$ 2,499	\$ 2,699
HPS6324W	Logic & Style Pedestal Riser, White	White		\$ 499	\$ 529

Inventory levels are subject to change, check stock via Dealer Login on www.pinnaclesalesgroup.com

STYLE SERIES WASHING MACHINE

White



W6124XW

Washing Machine Features

- Drum volume: 2.8 cu. ft.
- Load weight: 26.5 lbs
- Full steel design concept
- 1400 rpm spin speed
- 25 programs
- Steel Seal™ hygienic door sealing
- Cold and hot water connection
- Super Rinse™
- 6 run modes
- Quattro™ construction
- Active Drum™
- Inner and outer drums in stainless steel
- Full graphic color display (TFT)
- Brushless motor
- Steam
- Cast iron counter weights
- Auto dosing
- Load Light™
- Stain program
- Pro-wash
- Build Your Laundry Pair with any Combination of Logic or Style Products

MODEL NUMBER	DESCRIPTION	FINISH	UMRP	MSRP
W6124XW	24" Washer, Style, White	White	\$ 2,899	\$ 3,099
HPS6324W	Logic & Style Pedestal Riser, White	White	\$ 499	\$ 529

* See Page 46 for Available Hidden Helpers and accessories



Inventory levels are subject to change, check stock via Dealer Login on www.pinnaclesalesgroup.com

STOCK ITEMS ARE LISTED IN RED

STYLE SERIES TUMBLE DRYER

White



Washing machine and tumble dryer sets are stackable and pair great with select hidden helpers to maximize the space in your laundry room. Add a drying cabinet for the ultimate laundry care package.

(Excludes single laundry care shelf)

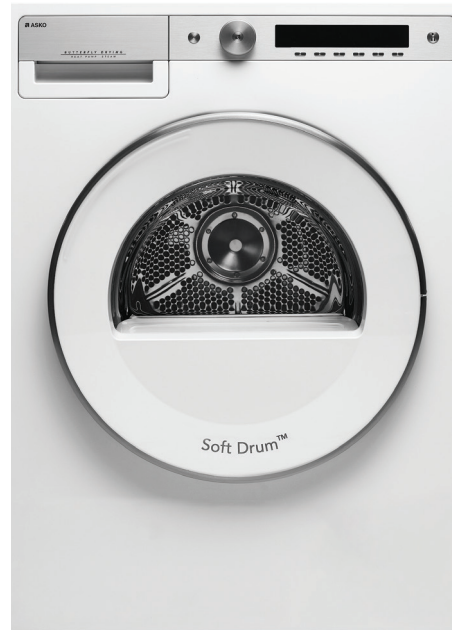

T611VUW

Tumble Dryer Features

- Drum volume: 5.1 cu. ft.
- Load weight: 24.3 lbs
- Full steel design concept
- Soft Drum™
- Air Lift™ Paddles
- Butterfly Drying™
- Brushless motor
- 15 programs
- Full graphic color display (TFT)
- SensiDry
- Interior LED light
- Build Your Laundry Pair with any Combination of Logic or Style Products

MODEL NUMBER	DESCRIPTION	FINISH	TYPE	UMRP	MSRP
T611VUW	24" Vented Dryer, Style, White	White	Vented	\$ 1,999	\$ 2,199
HPS6324W	Logic & Style Pedestal Riser, White	White		\$ 499	\$ 529

Inventory levels are subject to change, check stock via Dealer Login on www.pinnaclesalesgroup.com

There's always room for a heat pump dryer



ASKO's heat pump dryers are closed systems in which the processed air constantly circulates inside the tumble dryer, making it possible to install them in confined spaces, with little incoming air. Easy to integrate and install.

Dry with more air and less heat

To dry clothes quickly and gently, you must use the air that circulates in the drum as efficiently as possible. Our two lifters have a high and a low side placed on opposite sides of the drum. The clothes will thus fall irregularly in the drum which prevents them from bundling, allowing better air circulation through the clothes.

How can a heat pump be gentle on your clothes?

The air is dehumidified with the help of an evaporator instead of heat only, which means that lower temperatures can be used in the drying process. This, in turn, makes the drying gentler on fabrics without any loss in drying capacity or effectiveness. As well as gentler drying, the heat pump dryer also reduces the risk of clothes shrinking and even very sensitive fabrics can be dried.



A Soft Drum™ made of stainless steel

Soft Drum™ is a solution developed to enhance air flow around the load, thereby increasing the drying effect. The circular indentations with bevelled edges also have a cushioning effect that reduces wear and tear on fabrics. The new drum design allows for even and gentle drying with both small and large loads.

The heat pump process

ASKO's heat pump dryers are closed systems in which the processed air constantly circulates inside the tumble dryer, in contrast to condenser and vented dryers that consumes and release over 7000 cubic ft. of air per program cycle, which places great demands on the supply air and ventilation. Our heat pump dryers are designed so that, in principle, no air needs to be added.

- 1** The compressor drives the refrigerant through the evaporator and the condenser.
- 2** When the refrigerant is pushed from the larger pipes in the evaporator to the smaller pipes in the condenser it transforms from a cold liquid into a warm gas which heats the air.
- 3** The warm air absorbs the moisture from the damp clothes.
- 4** The moist air is transported via a duct, where it finally reaches the cold part of the evaporator where it is condensed into water.

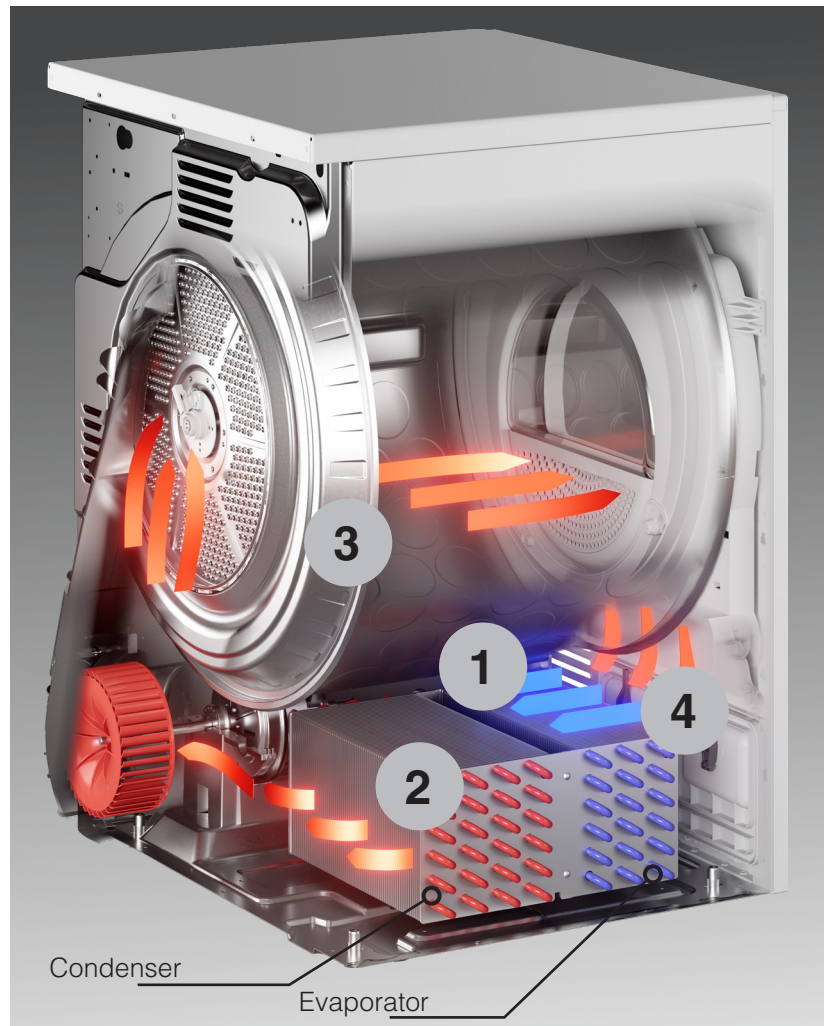

Refrigerant

The fluid used in the heat pump process. It undergoes phase transition from a liquid to a gas and back again.

Evaporator

In this device the liquid refrigerant is evaporated into gas form. In this case the evaporator also works as a dehumidifier of the moist warm air from the wet clothes.

Condenser

This device has smaller pipes that increases pressure and density of the gas resulting in heat.

Save energy!

Our heat pump dryers consume only 1.77 kWh per program for a 15lb load.

Heat pump dryers are easy to install

Our heat pump dryers can be installed in rooms with a lower level of ventilation and unlike ordinary tumble dryers, they can also be installed in confined spaces. Large air gaps are not required around our heat pump dryers and the drying process is not negatively affected by a warm or humid climate, unlike ordinary tumble dryers. Thanks to the closed system, the air around the dryer is not heated, which leads to energy gains in buildings with climate control/air conditioning.

Condensed water evacuation

The water generated during drying is collected in a large water tank that is easy to remove and empty. All our dryers can also be connected to drains, which means that you do not have to worry about emptying the water tank. This is an ASKO-unique feature.

Your laundry room just got bigger!

Do you have problems finding space for your ironing board? Have you looked between the washer and the dryer? We have! Right there is a simple yet obvious and well-conceived solution that is always on hand when you need to iron your clothes, but safely and invisibly stored away when not in use.



Shown with Hidden Helper Ironing Board



HIDDEN HELPER BASKET

Removable rack

A pull-out basket that is easily accessible from the dryer, and has a push-pull door opening with a large removable rack. This is a solution that is useful for removing laundry and carrying it to the closet for ironing and folding.



HIDDEN HELPER PEDESTAL

Storage and improved ergonomics

A useful storage drawer with a height of approximately 12 inches. Ideal for storing your detergent, softener, coat hangers, pegs, user manuals and other useful items in the laundry area. Place it beneath your washer and dryer and you'll have a better working height when loading and unloading. The drawer also comes with a shelf for more easily loading and unloading of your laundry.



HIDDEN HELPER DOUBLE

Keep it simple with a shelf and a handy basket

The wire basket and pull-out shelf can be used as an additional surface space when folding clothes and sorting socks - or for storage. The basket can be used to carry your clothes to the closet. Now that's practical!

HIDDEN HELPER IRONING BOARD

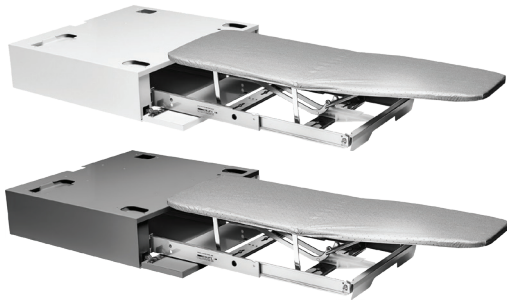

A simple yet obvious and well-conceived solution that is always on hand when you need to iron your clothes, but safely and invisibly stored away when not in use.

MODEL NUMBER	DESCRIPTION	SERIES	FINISH	MAP	MSRP
HI1153W	Ironing Board, White	All	White	\$ 699	\$ 729
HI1153T	Ironing Board, Titanium	All	Titanium	\$ 699	\$ 729

HIDDEN HELPER DOUBLE SHELF AND BASKET

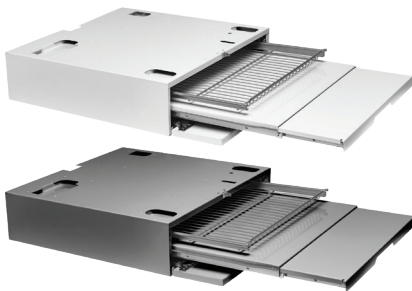

Comes with a wire basket and telescopic pull-out shelf. Useful for removing laundry and carrying it to the wardrobe or workbench for ironing and folding.

MODEL NUMBER	DESCRIPTION	SERIES	FINISH	MAP	MSRP
HDB1153W	Double Laundry Care Shelf, White	All	White	\$ 699	\$ 729
HDB1153T	Double Laundry Care Shelf, Titanium	All	Titanium	\$ 699	\$ 729

HIDDEN HELPER SINGLE LAUNDRY CARE SHELF



Makes loading and unloading your laundry so much easier.

MODEL NUMBER	DESCRIPTION	SERIES	FINISH	MAP	MSRP
HSS1053W	Single Laundry Care Shelf, White	All	White	\$ 329	\$ 349
HSS1053T	Single Laundry Care Shelf, Titanium	All	Titanium	\$ 329	\$ 349

Inventory levels are subject to change, check stock via Dealer Login on www.pinnaclesalesgroup.com

STOCK ITEMS ARE LISTED IN RED

HIDDEN HELPER PULL-OUT LAUNDRY CARE BASKET



A push- pull door opening with a deep removable rack. This solution is useful for removing the laundry and carrying it to the wardrobe or workbench for ironing and folding.

MODEL NUMBER	DESCRIPTION	SERIES	FINISH	MAP	MSRP
HB1153W	Pull-Out Laundry Care Basket, White	All	White	\$ 449	\$ 479

PEDESTAL DRAWER WITH SHELF



A spacious pedestal drawer for storing detergent, coat hangers, pegs, user manuals and other accessories in the Classic Series. The drawer also comes with a shelf for loading and unloading.

(Only fits Classic Series models)

MODEL NUMBER	DESCRIPTION	SERIES	FINISH	MAP	MSRP
HPS5323W	Pedestal Drawer with Shelf, White	Classic Only	White	\$ 749	\$ 779



PEDESTAL RISER

MODEL NUMBER	DESCRIPTION	SERIES	FINISH	MAP	MSRP
HPS6324W	Pedestal Riser	Logic and Style	White	\$ 499	\$ 529

LAUNDRY ACCESSORIES

MODEL NUMBER	DESCRIPTION	MAP	MSRP
452468	Stacking Kit Classic Dryer w/ Logic/Style Washer	\$ 44	\$ 49

Inventory levels are subject to change, check stock via Dealer Login on www.pinnaclesalesgroup.com

LIQUID LAUNDRY DETERGENT



Liquid white detergent



Liquid color detergent



Liquid fabric care

Benefits

- 99% natural ingredients
- Proven to be effective
- With 6 enzymes for extra washing power
- Tough against stains
- With odor-neutralizing technology
- Free from colorants, parabens and animal-derived ingredients
- Effective from 86°F
- Antipilling effect on cotton/polyester blends
- Color-safe formula
- Transparent bottle – nothing to hide
- Bottle made from 100% recycled plastic
- Forest fragrance



MODEL NUMBER	DESCRIPTION	UMRP	MSRP
LF11	Fabric Care Fabric Softener, 1L	\$ 8.99	\$ 9.49
LC11	Color Liquid Detergent, 1L	\$ 13.99	\$ 14.99
LW11	White Liquid Detergent, 1L	\$ 13.99	\$ 14.99

Inventory levels are subject to change, check stock via Dealer Login on www.pinnaclesalesgroup.com



Washing Programs



In conjunction with the launch of our new generation of washing machines, we are also introducing several new programs. See further down this page for descriptions of the new programs. Other programs are: Standard cotton, Mix/synthetic, Quick, Heavy, Rinse, Spin, Drain, and Easy care.

Wool / Hand Wash

The wool program is gentle to maintain the structure and shape of the garment.

Auto

Just fill the machine, select Auto wash, and start. This convenient program is used for both white and colored washes. It adapts the amount of water, number of rinses and washing time to the weight of the laundry.

Drum Cleaning

Clean the drum, hoses, detergent compartment and drain pump. Use a little detergent and vinegar that effectively removes detergent residues. Do not load the washing machine with any laundry.

Time

Choose a cycle time from 20 minutes up to 3 hours. The washing machine optimizes the program to ensure the wash is as effective as possible for the time you have chosen.

Everyday (Universal)

Designed to handle those day to day situations with a variety of different lightly to moderately soiled clothes that need to be washed.

Bedding

For washing large items such as bed sheets, duvets and pillows. This program uses extra water and additional rinses.

Dark Wash

Treat your dark wash as you treat your white wash: with a dedicated program and detergent for black fabrics. The program washes at low temperatures, with gentle tumbling and lower spinning rate.

Stain

The smart stain program is a fast way to choose the right treatment for both the type of stain and type of fabric. Select from: Red wine, Blood, Grass, Blueberries, Butter/Grease, Chocolate, Coffee/Tea, Egg, Dairy, Kids, Baby.

* See table of programs on Page 56

Drying Programs



Our new generation of tumble dryers have up to sixteen different programs to choose from, with eight of them being introduced along with our new generation tumble dryers. Other programs available are: Synthetic, Jeans, Terry, Sports Wear, Conditioning, and Airing.

Auto

For drying thicker non-sensitive cotton laundry. All auto programs stop automatically when the clothes are dry.

Bedding

For drying large items such as double sheets and duvet covers. This program uses a low temperature, more time and reverse drum movements to prevent the laundry from bundling.

Quick Pro

With this program you can get your wash completely dry in less than an hour.

Steam refresh

Ideal for freshening up garments such as suit jackets, wool sweaters and other items that would normally be dry cleaned or otherwise treated. Steam is very effective at removing odors from cigarette smoke to fire smoke. (Available on Logic Heat Pump models)

Steam wrinkle care

Repetitive steam injections and heat treatment to eliminate creases in the fabric. Low heat is used to also cater for sensitive fabrics. Steam care can be used with up to six shirts at a time.

Shirts

A program for shirts and blouses that dries at a low temperature with reverse drum movements. The program runs until the fabric is almost dry, with just a small amount of moisture remaining to prevent creasing.

Timed

Use this program for non-sensitive laundry that is still slightly moist and has to be thoroughly dried. In the time program, remaining moisture is not detected automatically.

Silk & Wool

This program uses a low temperature and stops just before the fabric is completely dry for maximum gentleness for sensitive fabrics such as silk and wool.

* See table of programs on Page 57

Drying Cabinet

Drying cabinets are common in Scandinavia, where the climate often requires that you can dry all types of clothes quickly, even coarse outerwear and shoes. A drying cabinet is practical but also gentle on your most sensitive fabrics since it uses no mechanical action that can wear your clothes, the air stream transports residual moisture and it's almost like drying outdoors.





Drying with extra care

Check the labels on your clothes and you'll see that many garments and materials need very careful treatment. Silk, velvet and satin, for example, need to be handled with care. That's when a drying cabinet comes in handy.

All garments unsuitable for a tumble dryer find a perfect solution in a drying cabinet, eliminating the need for air-drying or adding clutter to your home.

Less mess

With a drying cabinet, you can dry your family's sweaters, shirts, coats, shoes, gloves and more in a neat, organized way. It's a brilliant way of taking care of your family's clothes while keeping the house neat and tidy.



Also for shoe care

It's not just rubber boots that can be dried in a drying cabinet. All leather shoes need to rest between each use to allow moisture to escape. If you use them before they have dried, the seams will eventually break and they will lose their fit. Put them in the drying cabinet when you get home from work and they are ready for your evening walk an hour later.

24" DRYING CABINET



Features

- Super gentle drying of all kinds of fabrics and clothes
- Easy loading and unloading with pull-out hangers which are also foldable
- Special hangers for gloves, socks and linens.
- Special rack for effective drying of shoes
- Energy and time-saving automatic drying programs
- Loading capacity: approximately 9 lbs
- Dewatering capacity: 17 g/min
- Total drying length: 16 min
- Fan capacity: 180 m3/h
- Heating element effect: 1500 W
- Overheat cut-out
- Easy to clean surfaces and control panel



Pairs great with a stacked laundry pair and select hidden helper accessories (Excludes Single Laundry Care Shelf)

MODEL NUMBER	DESCRIPTION	TYPE	FINISH	UMRP	MSRP
DC7784VW	72"H x 24"W Drying Cabinet, Vented, White	Vented	White	\$ 2,599	\$ 2,799

Inventory levels are subject to change, check stock via Dealer Login on www.pinnaclesalesgroup.com



WASHING MACHINE PROGRAMS

Programs	Style	Logic	Classic
Everyday wash	X	X	X
Standard cotton	X	X	X
Mix / Synthetic	X	X	X
Wool / Hand wash	X	X	X
Time program	X	X	X
Auto	X	X	X
Quick	X	X	X
Heavy	X	X	X
Rinse	X	X	X
Spin	X	X	X
Drain	X	X	X
Easy Care	X	X	X
Stain program	X	—	—
Drum cleaning	X	X	X
Jeans	X	X	—
Shirts	X	X	—
Hygiene	X	X	—
Sports wear	X	—	—
Conditioning	X	—	—
Bedding	X	X	—
Quick Pro	X	X	X
Dark wash	X	X	X
Allergy Cotton	X	X	—
Allergy Synthetics	X	X	—
Stain	X	—	—

WASHING MACHINE MODES

Modes	Style	Logic	Classic
Normal	X	X	X
Green	X	X	X
Allergy	X	X	—
Speed	X	X	X
Intensive	X	X	X
Night	X	—	—

TUMBLE DRYER PROGRAMS

Programs	Style	Logic	Classic
Auto extra dry	X	X	X
Auto dry	X	X	X
Auto normal dry	X	X	X
Auto iron dry	X	X	X
Jeans	X	X	—
Synthetic	X	X	X
Terry	X	X	—
Down	X	X	—
Bedding	X	X	X
Silk & wool	—	Heat Pump Only	Heat Pump Only
Shirts	X	X	—
Sports Wear	X	—	—
Conditioning	X	—	—
Steam wrinkle care	—	Heat Pump Only	—
Steam refresh	—	Heat Pump Only	—
Quick Pro	X	X	X
Time	X	X	X
Airing	X	X	X



INTERIOR DESIGN

Shown with Three Zone unit on left and One Zone unit on the right
Finalist in the Best New Product Award Category by Interior Design 2023

27 1/2" FREESTANDING WINE CABINETS

27 1/2" Three Zone Wine Climate Cabinet Features



- 3 layers of glass with UV filter for extra protection of the wine
- 3 individually controlled temperature zones
- Holds up to 190 bottles
- LED illumination in all zones
- Charcoal filter in each zone for reducing pollutants
- Heavy duty hinges with soft close function
- Multi Air Flow keeps constant movement of the air and unified temperature in each zone
- Humidity, temperature and vibration sensors with warnings on the display and in ConnectLife app.
- Full Touch TFT display with camera for scanning wine labels
- Serving area with serving tray, bottle holder and wine accessory drawer
- Chalkboard name tags on each rack
- Fully extendable wooden racks with soft closing function
- RGB light for perfect setting of ambient light
- Powered by Vivino: Scan the label with your mobile or with UI camera and access more information about your wine
- ConnectLife app: Check/change settings, inventory list, humidity, temperature
- Inventory system: See location of your wine, storage time and serving temperature

MODEL NUMBER	DESCRIPTION	INSTALLATION	FINISH	UMRP	MSRP
WCN311942G	27 1/2" Three Zone Wine Climate Cabinet	Freestanding	Matte Black	\$ 9,999	\$ 10,499

Inventory levels are subject to change, check stock via Dealer Login on www.pinnaclesalesgroup.com

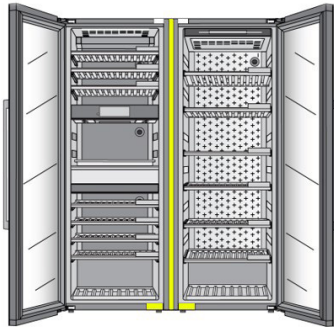

SIDE BY SIDE MOUNTING KIT

To be able to place the WCC side by side ASKO created a mounting/anti-condensation kit. The condensation kit is necessary to prevent creating moisture between the appliances, especially in humid climates.

MODEL NUMBER	DESCRIPTION	UMRP	MSRP
903337	Side by Side Mounting Kit	\$ 349	\$ 359



CHARCOAL FILTER

MODEL NUMBER	DESCRIPTION	UMRP	MSRP
873069	Charcoal Filter, Set of 3	\$ 49	\$ 54



CLAY HUMIDITY BOX

In case extra Humidity Boxes are needed there is an option to order them, for instance if you need two extra for the three-zone WCC.

MODEL NUMBER	DESCRIPTION	UMRP	MSRP
881964	Humidity Box Clay	\$ 139	\$ 149



SHELF SET

To be able to replace the serving-zone of the three-zone WCC you can replace the serving-zone interior for drawers like in the upper- and bottom-zone.

It consists of two regular shelves and one multi layout shelf and two sets of sliders including screws. (one slider is already present in the WCC)

MODEL NUMBER	DESCRIPTION	UMRP	MSRP
881963	Shelf Set (2 Regular Shelves, 1 Multi-Layout Shelf, 2 Slider Shelves)	\$ 359	\$ 369

Inventory levels are subject to change, check stock via Dealer Login on www.pinnaclesalesgroup.com

DISHWASHER DIMENSIONS

XL Tub Type Models

40 Series

- DBI364IS
- DBI564IS
- DFI564
- DBI564ISSOF
- DBI564TS
- DBI564PS

50 Series

- DFI565
- DSD565

60 Series

- DFI776SOF

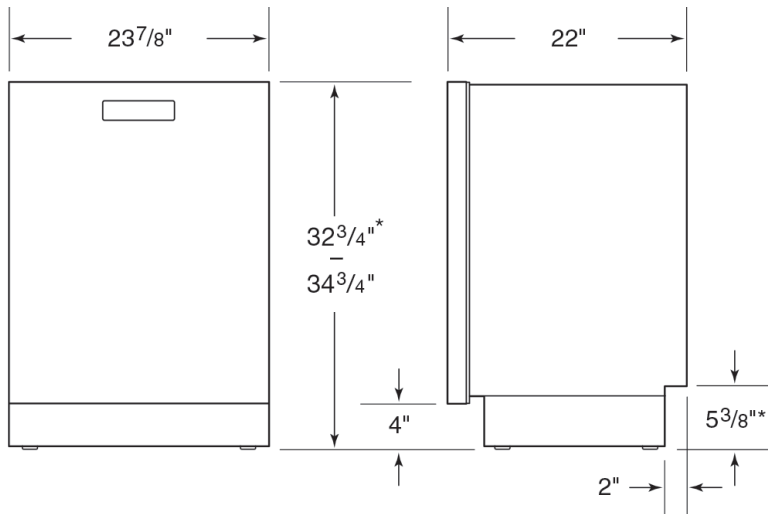

*Height can be reduced to 32 1/4" by removing top trim and lowering side trim.

XXL Tub Type Models

40 Series

- DBI564IXXLS
- DFI564XXL

50 Series

- DBI565IXXLS
- DFI565XXL
- DFI565XXLSOF
- DBI565TXXLS
- DBI565THXXLS
- DBI565PHXXLS
- DBI565PXXLS

60/60+ Series

- DBI776IXXLSSOF
- DFI776XXLSOF
- DBI786XXLSSOF
- DFI786XXLSOF

XXL Tub Type Models

Outdoor Series

- DOD561TXXLS

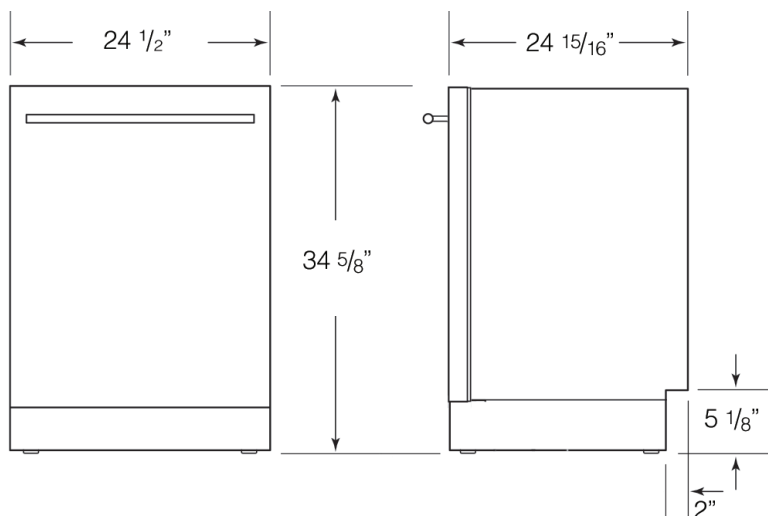
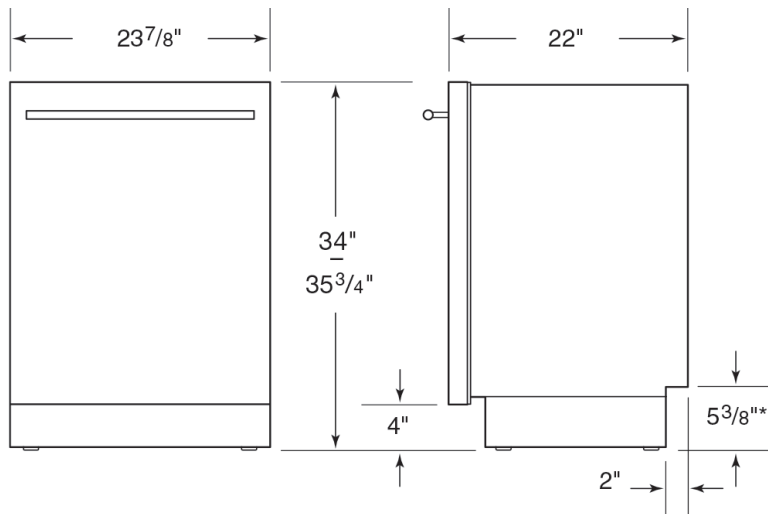

LIMITED WARRANTY – RESIDENTIAL APPLIANCES

ASKO warrants to the original purchaser (the “ASKO Customer”) of the ASKO product (the “ASKO Product”), who purchased the ASKO Product from a distributor, dealer, manufacturer’s representative or other seller who has been authorized by ASKO, that this ASKO Product is free of defects in materials and/or workmanship, subject to the terms and conditions set forth herein. This Limited Warranty covers parts and labor, except as set forth in this Limited Warranty. Service must be provided by an authorized ASKO service company. **YOUR SOLE AND EXCLUSIVE REMEDY UNDER THIS LIMITED WARRANTY SHALL BE PRODUCT REPAIR AS PROVIDED HEREIN.** This Limited Warranty is valid only when the ASKO Product is used in the country in which it was purchased. Proof of original purchase date is required to obtain service under this Limited Warranty. This Warranty only applies to the original purchaser and is non-transferable.

Residential ASKO Products Used Exclusively for Household/Personal Purposes:

Two (2) Years limited Warranty – Any warranty service claims for residential ASKO Products must be filed with ASKO within two (2) years from date of purchase. Service will be provided during normal business hours.

Residential ASKO Products Not Used Exclusively for Household/Personal Purposes or used Commercially or used in Marine, Mobile or Aeronautical Applications:

One (1) Year limited Warranty – Any warranty service claims for ASKO Products not used exclusively for household and personal use, or used commercially or used in marine, mobile, or aeronautical applications must be filed with ASKO within one (1) year from date of purchase. Service will be provided during normal business hours.

ITEMS EXCLUDED FROM WARRANTY

This Limited Warranty does not cover:

1. Replacement parts or repair labor if the ASKO Product is used in a manner that is inconsistent with published user or operator instructions and/or installation instructions.
2. Service calls to correct the installation of the ASKO Product, to instruct you on how to use the ASKO Product, to replace or repair house fuses, or to correct house wiring or plumbing.]
3. Consumable items and parts, such as filters.
4. Damage resulting from accident, alteration, misuse, abuse, negligence, fire, flood, acts of God, improper use, improper installation, installation not in accordance with electrical or plumbing codes, or use of products not approved by ASKO, as well as any attempted repair by other than authorized ASKO service companies.
5. Cosmetic damage, including scratches, dents, chips or other damage to the finish of the ASKO Product, unless such damage results from defects in materials or workmanship and is reported to ASKO within 5 days from date of purchase.
6. Pickup and delivery. The ASKO Product is intended to be repaired in your home.
7. Repairs to parts or systems resulting from unauthorized modifications made to the ASKO Product.
8. Expenses for travel and transportation for product service if the ASKO Product is located in a remote area where service by an authorized ASKO service company is not available.
9. The removal and reinstallation of the ASKO Product if it is installed in an inaccessible location or is not installed in accordance with ASKO’s published installation instructions.
10. Replacement parts or repair labor on ASKO Products with original model/serial numbers that have been removed, altered or cannot be easily determined.

DISCLAIMER

YOUR SOLE AND EXCLUSIVE REMEDY UNDER THIS LIMITED WARRANTY SHALL BE PRODUCT REPAIR AS PROVIDED HEREIN. EXPRESSLY DISCLAIMED ARE ALL OTHER EXPRESS AND IMPLIED WARRANTIES, INCLUDING ANY IMPLIED WARRANTIES OF MERCHANTABILITY AND FITNESS FOR A PARTICULAR PURPOSE. Some jurisdictions do not allow exclusion or limitations regarding warranty rights. This Limited Warranty gives you specific legal rights and you may have other rights that vary from jurisdiction to jurisdiction. Attempted repair by any person other than an authorized ASKO service company will void this Limited Warranty.

LIMITATION OF LIABILITY

IN NO EVENT SHALL ASKO OR THE MANUFACTURER AND THEIR RESPECTIVE PARENTS, SUBSIDIARIES AND AFFILIATES BE LIABLE FOR CONSEQUENTIAL, INCIDENTAL, EXEMPLARY, PUNITIVE OR SPECIAL DAMAGES. IN NO EVENT SHALL ASKO OR THE MANUFACTURER AND THEIR RESPECTIVE PARENTS, SUBSIDIARIES AND AFFILIATES BE LIABLE FOR DAMAGES OTHER THAN ACTUAL DAMAGES AND IN NO EVENT FOR DAMAGES IN EXCESS OF THE PRICE PAID FOR THE ASKO PRODUCT AS TO WHICH A CLAIM IS MADE. Some jurisdictions do not allow the exclusion or limitation of incidental, consequential or other damages, so these limitations and exclusions may not apply to you. This Limited Warranty gives you specific legal rights. You also may have other rights that vary from jurisdiction to jurisdiction.

TROUBLESHOOTING & ASKO CUSTOMER CARE

If you think you need repair service, first see the “Troubleshooting” section of the Use & Care Guide. If you are unable to resolve the problem after checking “Troubleshooting,” then additional help can be obtained by calling ASKO Customer Care at 1-800-898-1879. Read the “Troubleshooting” chapter before contacting the Customer Care Center. Make a note of the details on the rating plate (see illustration below) positioned. Make a note of the (1) service number, (2) item number and (3) serial number.

SERVICE AFTER EXPIRATION OF LIMITED WARRANTY

For information about obtaining parts and labor after expiration of this Limited Warranty or arising outside the scope of this Limited Warranty, please contact ASKO Customer Care at 1-800-898-1879. After your purchase and prior to first use of the ASKO Product, register your ASKO Product with ASKO by utilizing the address information below. Should you need further assistance as well, contact us at the address information below:

Orders: All orders and any subsequent change orders must be submitted in writing and delivered to Pinnacle Express, Inc. dba Pinnacle Sales Group by mail, fax, EDI, website or e-mail. No telephone orders will be accepted. Special Order items are Non-Cancellable.

Prices: All prices are subject to change without notice and are exclusive of any sales or use taxes, shipping, delivery, special packaging, or handling charges that may apply to each customer or to each order.

Minimum Advertised Pricing: All sales are subject to Pinnacle Express, Inc. dba Pinnacle Sales Group or Manufacturer minimum advertised prices. Failure to comply with minimum advertised prices will result in cancellation of any agreement and violators will not be entitled to purchase further products.

Minimum Sale Price: All sales are subject to Pinnacle Express, Inc. dba Pinnacle Sales Group or Manufacturer minimum sale prices. Failure to comply with minimum sale prices will result in cancellation of any agreement and violators will not be entitled to purchase further products.

Freight and Handling: Pinnacle Express, Inc. dba Pinnacle Sales Group reserves the right to ship products by its choice of carrier. All shipments are F.O.B. from place of shipment, and risk of loss shall pass to the Buyer upon delivery to the carrier at the point of shipment. Additional charges may apply for special handling and packaging.

Deliveries: Pinnacle Express, Inc. dba Pinnacle Sales Group shall not be liable for failure to deliver or for delays in delivery or performance due to: (1) causes beyond its reasonable control; (2) acts of God, acts of Buyer, acts of civil or military authority, governmental allocations or controls, fires, strikes or other labor difficulties, riots or other civil disturbances, delays in its usual source of supply, delays in transportation; (3) any other commercial impracticability. In the event of such delay, the date of delivery or performance shall be extended for a period equal to the time lost by reason of the delay.

Claims: All claims for non-conforming delivery of Products must be made within thirty (30) days of receipt of shipment.

Damage or Loss: Any claim for damage or loss in shipment should be made to the carrier immediately by the customer. Products become the responsibility of the Buyer when accepted by the carrier in good condition from Pinnacle Express, Inc. dba Pinnacle Sales Group and we are not able to process shipping damage claims.

Returns: Only Items marked in this Price List as "Stock Item" are subject to return. All other items are considered Special Order Items and are NOT RETURNABLE. No Products may be returned without a Pinnacle Express, Inc. dba Pinnacle Sales Group Return Goods Authorization (RGA) Number issued prior to the return of Product. Any product returned without an RGA will be refused and returned to the sender. RGA's are valid for thirty (30) days only. All returns are subject to inspection before being approved for credit - products must be in salable condition to be considered for return or replacement. A 20% restocking charge will apply to all returns.

Payment: Unless otherwise noted, payment terms are Net Due on Receipt. Balances owed on invoices over 30 days old are subject to a 1.5% per month charge. Payments made by credit card are subject to a 3% processing fee. Each shipment or delivery shall be deemed to have been sold under a separate and or independent contract and payment thereof shall be made in accordance with the terms of this agreement and of the invoice rendered by Pinnacle Express, Inc. dba Pinnacle Sales Group Buyer agrees that title to the personal property described herein shall not vest in Buyer until paid in full. In the event of insolvency or the filing of bankruptcy by the Buyer, Buyer agrees to return all merchandise to Pinnacle Express, Inc. dba Pinnacle Sales Group

Warranties: Products distributed by Pinnacle Express, Inc. dba Pinnacle Sales Group are the products of reputable manufacturers sold under their respective brand or trade names. Pinnacle Express, Inc. dba Pinnacle Sales Group shall use its best efforts to obtain from each manufacturer, in accordance with the manufacturer's warranty or customary practice, the repair or replacement of products that may prove defective in material or workmanship. The foregoing shall constitute the exclusive remedy of the Buyer and the sole obligation of Pinnacle Express, Inc. dba Pinnacle Sales Group Except as to Title, THERE ARE NO WARRANTIES, EITHER WRITTEN, ORAL, IMPLIED, OR STATUTORY relating to the described products which shall extend beyond that described in this paragraph. NO WARRANTY OF MERCHANTABILITY OR OF FITNESS FOR PURPOSE SHALL APPLY.

Limitation of Liability: Pinnacle Express, Inc. dba Pinnacle Sales Group's liability on any claims for loss or damage arising out of this contract or from the performance or breach thereof or connected with the supplying of products hereunder, or its sale, resale, operation or use, whether based on warranty, contract, negligence or other grounds shall not exceed the price allowable for such products or parts thereof involved in the claim. Pinnacle Express, Inc. dba Pinnacle Sales Group shall not, under any circumstances, be liable for any labor charges unless agreed upon in advance and in writing by Pinnacle Express, Inc. dba Pinnacle Sales Group and the manufacturer of the products involved. Pinnacle Express, Inc. dba Pinnacle Sales Group shall not in any event be liable for special or consequential damages, including, but not limited to, loss of profits or revenue, loss of use of the product or any associated product, cost of capital, cost of substitute products, facilities or services, downtime costs, or claims of customers of the Buyer for such damages.

General: The possession of this Price List by anyone is not to be considered as an offer to sell any of the Products contained herein. This Price List supercedes all previous price lists or memorandums. Pinnacle Express, Inc. dba Pinnacle Sales Group's existing Trade Terms and Conditions remain in effect. The above Terms and Conditions shall be a part of all Orders accepted by Pinnacle Express, Inc. dba Pinnacle Sales Group and shall supercede any conflicting provisions of our customer's purchase orders. These terms and conditions are subject to change without notice.



ASKO
Inspired by Scandinavia
us.asko.com/

AS-PB-0725