



 **BLUESTAR<sup>®</sup>**

**2024 PRICE LIST**  
**EFFECTIVE APRIL 25, 2023**

# TABLE OF CONTENTS

## COOKING: FREESTANDING RANGES

5	Dual Fuel Series
13	Platinum Serie – Induction
14	Platinum Series – All Gas
19	Nova (RNB) Series
33	Culinary Series – Open Burner
35	Culinary Series – Sealed Burner
39	Culinary Series – Induction
40	Freestanding Range Customization & Accessories

## COOKING: RANGETOPS & COOKTOP

42	Platinum Series
44	Induction Cooktop
45	Nova (RNB) Series
52	Dishwasher Panel
52	Rangetop & Cooktop Customization & Accessories

## COOKING: WALL OVENS & SALAMANDER BROILER

54	Electric Wall Ovens
56	Gas Wall Ovens
59	Wall Oven Customization & Accessories
60	Salamander Broiler

## REFRIGERATION

62	PRO Built-In Refrigerators
64	Column Refrigerators
66	Column Freezers
69	Additional Trim Options: Column Refrigeration
70	Freestanding Refrigerator

## VENTILATION

72	Hood Selection Guide
73	Duct Selection Guide
74	Professional Series Wall Hoods
78	Liners
81	Designer Series Wall Hoods
94	Designer Series Island Hoods
96	Abbaka Series
103	Ventilation Accessories & Wall Liners
105	Customization Summary Guide

## To Place and/or Check Order Status

Phone: (800) 449 – 8691 or (610) 376 – 7479

Submit orders to: [sales@bluestarcooking.com](mailto:sales@bluestarcooking.com)

**When ordering specify LP or Natural Gas, Elevation, etc.**

**Inspect all deliveries immediately upon receipt and prior to signing for items in good condition. Note any damage to the box and/or items and contact BlueStar customer service by email to report damage same day. All shipments are FOB origin. Consignee is responsible for repair/replacement charges and for filing freight claims.**

- BlueStar will ship dealer orders to their designated store or warehouse location
- Orders of \$20,000 or more shipped as one shipment qualify for pre-paid freight
- Freight charges for non-qualifying orders will be subject to the following cost schedule

Ranges, Cooktops, Rangetops, Wall Ovens, Salamander Broiler, Indoor Charbroiler and Ventilation Hoods (Wall or Island with Blower)	\$125
--	-------

Refrigerators	\$200
---------------	-------

- Deliveries requiring Liftgate service will incur a \$50 flat fee per delivery
- Will-Call orders are subject to a \$25 Will-Call charge per order
- The freight program does not apply to small package orders/shipments that would typically be shipped via UPS or FedEx, such as color samples and backguards not shipped with a major unit.
- All freight charges for small package orders/shipments, except for warranty parts, will be invoiced to the dealer.



# FREESTANDING RANGES

Get the Look: 48" Dual Fuel Range in Black Blue with Brushed Brass Trim

# FREESTANDING RANGE COMPARISON

Dual Fuel Series

Platinum™ Series

Nova (RNB) Series

Culinary (RCS) Series Open

Culinary (RCS) Series Sealed



Feature

Feature	Dual Fuel Series	Platinum™ Series	Nova (RNB) Series	Culinary (RCS) Series Open	Culinary (RCS) Series Sealed
Available Sizes	30", 36", 48" & 60"	24", 30", 36", 48" & 60"	24", 30", 36", 48" & 60"	30" & 36"	24", 30", 36" & 48"
25,000 BTU to 500 BTU X-8™ Sealed Burners	■				
25,000 BTU Open Burners		■			
22,000 BTU Open Burners		■	■		
21,000 BTU Sealed Burners					■
18,000 BTU to 500 BTU X8™ Sealed Burners	■				
18,000 BTU Open Burner		■			
15,000 BTU Open Burner		■	■	■	
130° Simmer Open Burner		■	■	■	
Precise True Convection Electric Oven	■				
Extra-large gas convection oven with Infrared Broiler		■	■	■	■
Integrated Wok Cooking		■	■	■	
Interchangeable Griddle & Charbroiler		■			
PowR™ Oven Technology		■			
1,000+ Colors	■	■	■	■	■
10 Metal Trim Finishes	■	■	■	■	■
Painted Knobs	■	■	■	■	■
Swing Doors			■		
Griddle or Charbroiler or French Top	■		■		
Backguard Options	■	■	■	■	■

## FREESTANDING RANGES: DUAL FUEL SERIES

### Model Number Color & Customization Guide:

(C) 190 Standard RAL (Semi-Gloss) Colors	(CF) Specialty Finish (190 Matte RAL, Precious Metals & Textures)	(CC) Custom Color Match	(PLT) Plated Trim
--	---	-------------------------	-------------------

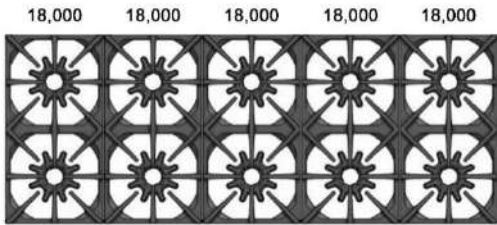

(\* ) 4% less output when configured for LP/Propane

#### FEATURES:

- Exclusive X-8™ star-shaped burner offers unmatched versatility and control on EVERY burner
- Go from extra-high sear – up to 25,000 BTUs – to an ultra-low warm of 500 BTUs on all burners
- Oversized True Convection electric oven offers even and consistent multi-rack cooking
- Fits commercial-size 18" x 26" baking sheets
- 8 cooking modes including Bake, Convection Bake, Roast, Convection Roast, Convection, Broil, Proof & Dehydrate, plus Sabbath setting and temperature probe
- Intuitive 7" touchscreen control with Quick Start™ cooking in 3 easy touches
- Environmentally friendly, gentle 90-minute express cleaning mode + Continu Clean™ technology
- Unmatched customization – choose from 1,000+ colors and 10 metal trim finishes
- Handcrafted in Pennsylvania since 1880

#### PRODUCT SPECIFICATIONS:

- Overall Dimensions: 59 7/8"W x 26 1/2"D x 36"H
- Oven Interior: 26 1/4"W x 20"D x 16 5/8"H
- Bake Element Rating: 3500W (2500W Inner/ 1000W Outer)
- Broiler Rating: 5000W (2500 Inner / 2500W Outer)
- Large Oven Convection Element Rating: 2800W
- Top Burner Rating (Front): Nat: 25,000 BTUs | LP: 24,000 BTUs
- Top Burner Rating (Rear): 18,000 BTUs
- Simmer Burner Rating: 500 BTUs
- Electrical Requirements: 240VAC, 60Hz, 50 AMPs, 1 PH (Unit must be on a Non-GFI, dedicated outlet)
- Operating Gas Pressure: Nat: 5" WC | LP: 10" WC
- Gas Line Size: 3/4"
- Installation Clearance (Below Counter): 0" side cabinet | 0" back wall
- Installation Clearance (Above Counter): 6" side cabinet
- Door Clearance: 20" from front of door
- Shipping Weight: 750 lbs

Model	Description (* ) Denotes item that must be specified	UMRP	MSRP
<b>Natural Gas Models: 60" Dual Fuel All Burner Range</b>			
BSDF6010B	10 Burner   Nat Gas   Stainless Steel   Std Trim	\$ 20,495	\$ 23,570
BSDF6010BPLT	10 Burner   Nat Gas   Stainless Steel   Plated Trim*	\$ 22,990	\$ 26,440
BSDF6010BC	10 Burner   Nat Gas   Std RAL Color*   Std Trim	\$ 21,990	\$ 25,290
BSDF6010BCPLT	10 Burner   Nat Gas   Std RAL Color*   Plated Trim*	\$ 24,485	\$ 28,160
BSDF6010BCF	10 Burner   Nat Gas   Spec Finish*   Std Trim	\$ 23,090	\$ 26,555
BSDF6010BCFPLT	10 Burner   Nat Gas   Spec Finish*   Plated Trim*	\$ 25,585	\$ 29,425
BSDF6010BCC	10 Burner   Nat Gas   Custom Color*   Std Trim	\$ 24,490	\$ 28,165
BSDF6010BCCPLT	10 Burner   Nat Gas   Custom Color*   Plated Trim*	\$ 26,985	\$ 31,035
<b>LP/Propane Models: 60" Dual Fuel All Burner Range</b>			
BSDF6010BL	10 Burner   LP Gas   Stainless Steel   Std Trim	\$ 20,495	\$ 23,570
BSDF6010BLPLT	10 Burner   LP Gas   Stainless Steel   Plated Trim*	\$ 22,990	\$ 26,440
BSDF6010BLC	10 Burner   LP Gas   Std RAL Color*   Std Trim	\$ 21,990	\$ 25,290
BSDF6010BLCPLT	10 Burner   LP Gas   Std RAL Color*   Plated Trim*	\$ 24,485	\$ 28,160
BSDF6010BLCF	10 Burner   LP Gas   Spec Finish*   Std Trim	\$ 23,090	\$ 26,555
BSDF6010BLCFPLT	10 Burner   LP Gas   Spec Finish*   Plated Trim*	\$ 25,585	\$ 29,425
BSDF6010BLCC	10 Burner   LP Gas   Custom Color*   Std Trim	\$ 24,490	\$ 28,165
BSDF6010BLCCPLT	10 Burner   LP Gas   Custom Color*   Plated Trim*	\$ 26,985	\$ 31,035
<b>BACKGUARD OPTIONS:</b>			
<b>All BlueStar freestanding appliances must be installed with a UL approved backguard. All units ship standard with a UL approved Island Trim unless otherwise specified.</b>			
IT60DF	Island Trim Backguard (If purchased separately)	\$ 1,210	\$ 1,390
BG60DF	6" Backguard for 60" Dual Fuel Series	\$ 1,530	\$ 1,760
SDHS60DF	24" High Shelf for 60" Dual Fuel Series	\$ 2,900	\$ 3,335
<b>KNOB &amp; PAINTED BODY SIDE OPTIONS: (Total Knobs: 10)</b>			
SIDES-C	Add Painted Sides (All colors)	\$ 765	\$ 880
KN-BLK	Standard Black Knob (Must be ordered with unit)	N/C	N/C
KN-C	Knob: Standard 190 RAL Color	\$ 115 ea	\$ 130 ea
BZ-C	Bezel: Standard 190 RAL Color	\$ 70 ea	\$ 80 ea
KN-CF	Knob: Spec Finish (Matte RAL, Textured RAL or Prec Metals)	\$ 185 ea	\$ 215 ea
KN-PLT	Knob: Plated Trim (See options below)	\$ 250 ea	\$ 290 ea
<b>PLATED TRIM OPTIONS: (Includes bezels, door handle, handle ends and logo)</b>			
Antique Brass, Brushed Brass, Polished Brass, Antique Copper, Brushed Copper, Polished Copper, Chrome, Oil Rubbed Bronze & Pewter			

## FREESTANDING RANGES: DUAL FUEL SERIES

Model Number Color & Customization Guide:			
(C) 190 Standard RAL (Semi-Gloss) Colors	(CF) Specialty Finish (190 Matte RAL, Precious Metals & Textures)	(CC) Custom Color Match	(PLT) Plated Trim

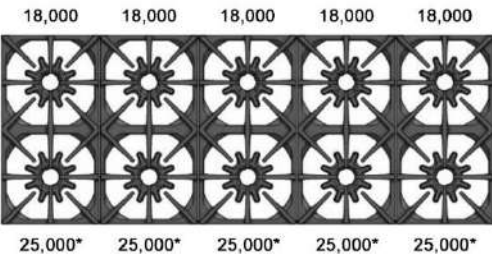

(\*) 4% less output when configured for LP/Propane

### FEATURES:

- Exclusive X-8™ star-shaped burner offers unmatched versatility and control on EVERY burner
- Go from extra-high sear – up to 25,000 BTUs – to an ultra-low warm of 500 BTUs on all burners
- Oversized True Convection electric oven offers even and consistent multi-rack cooking
- Fits commercial-size 18" x 26" baking sheets
- 8 cooking modes including Bake, Convection Bake, Roast, Convection Roast, Convection, Broil, Proof & Dehydrate, plus Sabbath setting and temperature probe
- Intuitive 7" touchscreen control with Quick Start™ cooking in 3 easy touches
- Environmentally friendly, gentle 90-minute express cleaning mode + Continu Clean™ technology
- Unmatched customization – choose from 1,000+ colors and 10 metal trim finishes
- Handcrafted in Pennsylvania since 1880

### PRODUCT SPECIFICATIONS:

- Overall Dimensions: 59 7/8"W x 26 1/2"D x 36"H
- Oven Interior: 26 1/4"W x 20"D x 16 5/8"H
- Bake Element Rating: 3500W (2500W Inner/ 1000W Outer)
- Broiler Rating: 5000W (2500 Inner / 2500W Outer)
- Large Oven Convection Element Rating: 2800W
- Top Burner Rating (Front): Nat: 25,000 BTUs | LP: 24,000 BTUs
- Top Burner Rating (Rear): 18,000 BTUs
- Simmer Burner Rating: 500 BTUs
- Griddle Rating: 15,000 BTUs
- Electrical Requirements: 240VAC, 60Hz, 50 AMPs, 1 PH (Unit must be on a Non-GFI, dedicated outlet)
- Operating Gas Pressure: Nat: 5" WC | LP: 10" WC
- Gas Line Size: 3/4"
- Installation Clearance (Below Counter): 0" side cabinet | 0" back wall
- Installation Clearance (Above Counter): 6" side cabinet
- Door Clearance: 20" from front of door
- Shipping Weight: 750 lbs

Model	Description (* ) Denotes item that must be specified	UMRP	MSRP
<b>Natural Gas Models: 60" Dual Fuel Range with 24" Griddle</b>			
BSDF606G	6 Burner   24" Griddle   Nat Gas   Stainless Steel   Std Trim	\$ 21,495	\$ 24,720
BSDF606GPLT	6 Burner   24" Griddle   Nat Gas   Stainless Steel   Pld Trim*	\$ 23,990	\$ 27,590
BSDF606GC	6 Burner   24" Griddle   Nat Gas   Std RAL Paint*   Std Trim	\$ 22,990	\$ 26,440
BSDF606GCPLT	6 Burner   24" Griddle   Nat Gas   Std RAL Paint*   Pld Trim*	\$ 25,485	\$ 29,310
BSDF606GCF	6 Burner   24" Griddle   Nat Gas   Spec Finish*   Std Trim	\$ 24,090	\$ 27,705
BSDF606GCFPLT	6 Burner   24" Griddle   Nat Gas   Spec Finish*   Pld Trim*	\$ 26,585	\$ 30,575
BSDF606GCC	6 Burner   24" Griddle   Nat Gas   Custom Color*   Std Trim	\$ 25,490	\$ 29,315
BSDF606GCCPLT	6 Burner   24" Griddle   Nat Gas   Custom Color*   Pld Trim*	\$ 27,985	\$ 32,185
<b>LP/Propane Models: 60" Dual Fuel Range with 24" Griddle</b>			
BSDF606GL	6 Burner   24" Griddle   LP Gas   Stainless Steel   Std Trim	\$ 21,495	\$ 24,720
BSDF606GLPLT	6 Burner   24" Griddle   LP Gas   Stainless Steel   Pld Trim*	\$ 23,990	\$ 27,590
BSDF606GLC	6 Burner   24" Griddle   LP Gas   Std RAL Paint*   Std Trim	\$ 22,990	\$ 26,440
BSDF606GLCPLT	6 Burner   24" Griddle   LP Gas   Std RAL Paint*   Pld Trim*	\$ 25,485	\$ 29,310
BSDF606GLCF	6 Burner   24" Griddle   LP Gas   Spec Finish*   Std Trim	\$ 24,090	\$ 27,705
BSDF606GLCFPLT	6 Burner   24" Griddle   LP Gas   Spec Finish*   Pld Trim*	\$ 26,585	\$ 30,575
BSDF606GLCC	6 Burner   24" Griddle   LP Gas   Custom Color*   Std Trim	\$ 25,490	\$ 29,315
BSDF606GLCCPLT	6 Burner   24" Griddle   LP Gas   Custom Color*   Pld Trim*	\$ 27,985	\$ 32,185
<b>BACKGUARD OPTIONS:</b>			
<b>All BlueStar freestanding appliances must be installed with a UL approved backguard. All units ship standard with a UL approved Island Trim unless otherwise specified.</b>			
IT60DF	Island Trim Backguard (If purchased separately)	\$ 1,210	\$ 1,390
BG60DF	6" Backguard for 60" Dual Fuel Series	\$ 1,530	\$ 1,760
SDHS60DF	24" High Shelf for 60" Dual Fuel Series	\$ 2,900	\$ 3,335
<b>KNOB &amp; PAINTED BODY SIDE OPTIONS: (Total Knobs: 8)</b>			
SIDES-C	Add Painted Sides (All colors)	\$ 765	\$ 880
KN-BLK	Standard Black Knob (Must be ordered with unit)	N/C	N/C
KN-C	Knob: Standard 190 RAL Color	\$ 115 ea	\$ 130 ea
BZ-C	Bezel: Standard 190 RAL Color	\$ 70 ea	\$ 80 ea
KN-CF	Knob: Spec Finish (Matte RAL, Textured RAL or Prec Metals)	\$ 185 ea	\$ 215 ea
KN-PLT	Knob: Plated Trim (See options below)	\$ 250 ea	\$ 290 ea
<b>PLATED TRIM OPTIONS: (Includes bezels, door handle, handle ends and logo)</b>			
Antique Brass, Brushed Brass, Polished Brass, Antique Copper, Brushed Copper, Polished Copper, Chrome, Oil Rubbed Bronze & Pewter			

# FREESTANDING RANGES: DUAL FUEL SERIES

Model Number Color & Customization Guide:			
(C) 190 Standard RAL (Semi-Gloss) Colors	(CF) Specialty Finish (190 Matte RAL, Precious Metals & Textures)	(CC) Custom Color Match	(PLT) Plated Trim

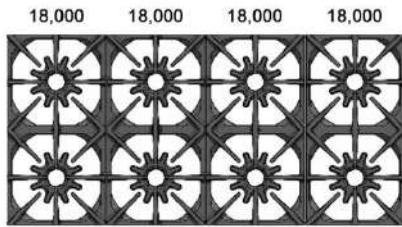

(\* ) 4% less output when configured for LP/Propane

## FEATURES:

- Exclusive X-8™ star-shaped burner offers unmatched versatility and control on EVERY burner
- Go from extra-high sear – up to 25,000 BTUs – to an ultra-low warm of 500 BTUs on all burners
- Oversized True Convection electric oven offers even and consistent multi-rack cooking
- Fits commercial-size 18" x 26" baking sheets
- 8 cooking modes including Bake, Convection Bake, Roast, Convection Roast, Convection, Broil, Proof & Dehydrate, plus Sabbath setting and temperature probe
- Intuitive 7" touchscreen control with Quick Start™ cooking in 3 easy touches
- Environmentally friendly, gentle 90-minute express cleaning mode + Continu Clean™ technology
- Unmatched customization – choose from 1,000+ colors and 10 metal trim finishes
- Handcrafted in Pennsylvania since 1880

## PRODUCT SPECIFICATIONS:

- Overall Dimensions: 47 7/8"W x 26 1/2"D x 36"H
- Large Oven Interior: 26 1/4"W x 20"D x 16 5/8"H
- Bake Element Rating: 3500W (2500W Inner/ 1000W Outer)
- Broiler Rating: 5000W (2500 Inner / 2500W Outer)
- Large Oven Convection Element Rating: 2800W
- Small Oven Interior: 14 1/8"W x 20"D x 16 5/8"H
- Bake Element Rating: 2100W
- Small Oven Convection Element Rating: 2800W
- Top Burner Rating (Front): Nat: 25,000 BTUs | LP: 24,000 BTUS
- Top Burner Rating (Rear): 18,000 BTUs
- Simmer Burner Rating: 500 BTUs
- Electrical Requirements: 240VAC, 60Hz, 50 AMPs, 1 PH (Unit must be on a Non-GFI, dedicated outlet)
- Operating Gas Pressure: Nat: 5" WC | LP: 10" WC
- Gas Line Size: 3/4"
- Installation Clearance (Below Counter): 0" side cabinet | 0" back wall
- Installation Clearance (Above Counter): 6" side cabinet
- Door Clearance: 20" from front of door
- Shipping Weight: 640 lbs

Model	Description (* ) Denotes item that must be specified	UMRP	MSRP
<b>Natural Gas Models: 48" Dual Fuel All Burner Range</b>			
BSDF488B	8 Burner   Nat Gas   Stainless Steel   Std Trim	\$ 15,995	\$ 18,395
BSDF488BPLT	8 Burner   Nat Gas   Stainless Steel   Plated Trim*	\$ 18,190	\$ 20,920
BSDF488BC	8 Burner   Nat Gas   Std RAL Color*   Std Trim	\$ 17,490	\$ 20,115
BSDF488BCPLT	8 Burner   Nat Gas   Std RAL Color*   Plated Trim*	\$ 19,685	\$ 22,640
BSDF488BCF	8 Burner   Nat Gas   Spec Finish*   Std Trim	\$ 18,590	\$ 21,380
BSDF488BCFPLT	8 Burner   Nat Gas   Spec Finish*   Plated Trim*	\$ 20,785	\$ 23,905
BSDF488BCC	8 Burner   Nat Gas   Custom Color*   Std Trim	\$ 19,990	\$ 22,990
BSDF488BCCPLT	8 Burner   Nat Gas   Custom Color*   Plated Trim*	\$ 22,185	\$ 25,515
<b>LP/Propane Models: 48" Dual Fuel All Burner Range</b>			
BSDF488BL	8 Burner   LP Gas   Stainless Steel   Std Trim	\$ 15,995	\$ 18,395
BSDF488BLPLT	8 Burner   LP Gas   Stainless Steel   Plated Trim*	\$ 18,190	\$ 20,120
BSDF488BLC	8 Burner   LP Gas   Std RAL Color*   Std Trim	\$ 17,490	\$ 20,115
BSDF488BLCPLT	8 Burner   LP Gas   Std RAL Color*   Plated Trim*	\$ 19,685	\$ 22,640
BSDF488BLCF	8 Burner   LP Gas   Spec Finish*   Std Trim	\$ 19,685	\$ 22,640
BSDF488BLCFPLT	8 Burner   LP Gas   Spec Finish*   Plated Trim*	\$ 20,785	\$ 23,905
BSDF488BLCC	8 Burner   LP Gas   Custom Color*   Std Trim	\$ 19,990	\$ 22,990
BSDF488BLCCPLT	8 Burner   LP Gas   Custom Color*   Plated Trim*	\$ 22,185	\$ 25,515
<b>BACKGUARD OPTIONS:</b>			
<b>All BlueStar freestanding appliances must be installed with a UL approved backguard. All units ship standard with a UL approved Island Trim unless otherwise specified.</b>			
IT48DF	Island Trim Backguard (If purchased separately)	\$ 955	\$ 1,100
BG648DF	6" Backguard for 48" Dual Fuel Series	\$ 1,040	\$ 1,195
SDHS48DF	24" High Shelf for 48" Dual Fuel Series	\$ 2,340	\$ 2,690
<b>KNOB &amp; PAINTED BODY SIDE OPTIONS: (Total Knobs: 8)</b>			
SIDES-C	Add Painted Sides (All colors)	\$ 765	\$ 880
KN-BLK	Standard Black Knob (Must be ordered with unit)	N/C	N/C
KN-C	Knob: Standard 190 RAL Color	\$ 115 ea	\$ 130 ea
BZ-C	Bezel: Standard 190 RAL Color	\$ 70 ea	\$ 80 ea
KN-CF	Knob: Spec Finish (Matte RAL, Textured RAL or Prec Metals)	\$ 185 ea	\$ 215 ea
KN-PLT	Knob: Plated Trim (See options below)	\$ 250 ea	\$ 290 ea
<b>PLATED TRIM OPTIONS: (Includes bezels, door handle, handle ends and logo)</b>			
Antique Brass, Brushed Brass, Polished Brass, Antique Copper, Brushed Copper, Polished Copper, Chrome, Oil Rubbed Bronze & Pewter			

## FREESTANDING RANGES: DUAL FUEL SERIES

Model Number Color & Customization Guide:			
(C) 190 Standard RAL (Semi-Gloss) Colors	(CF) Specialty Finish (190 Matte RAL, Precious Metals & Textures)	(CC) Custom Color Match	(PLT) Plated Trim

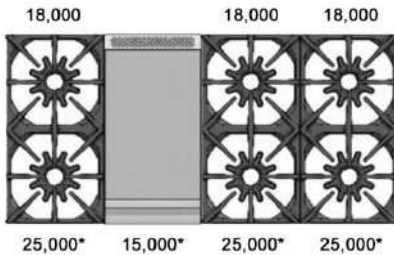

(\*) 4% less output when configured for LP/Propane

### FEATURES:

- Exclusive X-8™ star-shaped burner offers unmatched versatility and control on EVERY burner
- Go from extra-high sear – up to 25,000 BTUs – to an ultra-low warm of 500 BTUs on all burners
- Commercial-grade steel griddle with precise temperature control
- Oversized True Convection electric oven offers even and consistent multi-rack cooking
- Fits commercial-size 18" x 26" baking sheets
- 8 cooking modes including Bake, Convection Bake, Roast, Convection Roast, Convection, Broil, Proof & Dehydrate, plus Sabbath setting and temperature probe
- Intuitive 7" touchscreen control with Quick Start™ cooking in 3 easy touches
- Environmentally friendly, gentle 90-minute express cleaning mode + Continuum Clean™ technology
- Unmatched customization – choose from 1,000+ colors and 10 metal trim finishes
- Handcrafted in Pennsylvania since 1880

### PRODUCT SPECIFICATIONS:

- Overall Dimensions: 47 7/8"W x 26 1/2"D x 36"H
- Large Oven Interior: 26 1/4"W x 20"D x 16 5/8"H
- Bake Element Rating: 3500W (2500W Inner/ 1000W Outer)
- Broiler Rating: 5000W (2500 Inner / 2500W Outer)
- Large Oven Convection Element Rating: 2800W
- Small Oven Interior: 14 1/8"W x 20"D x 16 5/8"H
- Bake Element Rating: 2100W
- Small Oven Convection Element Rating: 2800W
- Top Burner Rating (Front): Nat: 25,000 BTUs | LP: 24,000 BTUs
- Top Burner Rating (Rear): 18,000 BTUs
- Simmer Burner Rating: 500 BTUs
- 12" Griddle Rating: 15,000 BTUs
- Electrical Requirements: 240VAC, 60Hz, 50 AMPs, 1 PH (Unit must be on a Non-GFI, dedicated outlet)
- Operating Gas Pressure: Nat: 5" WC | LP: 10" WC
- Gas Line Size: 3/4"

Model	Description (* Denotes item that must be specified)	UMRP	MSRP
<b>Natural Gas Models: 48" Dual Fuel Range with 12" Griddle</b>			
BSDF486G	6 Burner   12" Griddle   Nat Gas   Stainless Steel   Std Trim	\$ 16,995	\$ 19,545
BSDF486GPLT	6 Burner   12" Griddle   Nat Gas   Stainless Steel   Pld Trim*	\$ 19,190	\$ 22,070
BSDF486GC	6 Burner   12" Griddle   Nat Gas   Std RAL Color*   Std Trim	\$ 18,490	\$ 21,265
BSDF486GCPLT	6 Burner   12" Griddle   Nat Gas   Std RAL Color*   Pld Trim*	\$ 20,685	\$ 23,790
BSDF486GCF	6 Burner   12" Griddle   Nat Gas   Spec Finish*   Std Trim	\$ 19,590	\$ 22,530
BSDF486GCFPLT	6 Burner   12" Griddle   Nat Gas   Spec Finish*   Pld Trim*	\$ 21,785	\$ 25,055
BSDF486GCC	6 Burner   12" Griddle   Nat Gas   Custom Color*   Std Trim	\$ 20,990	\$ 24,140
BSDF486GCCPLT	6 Burner   12" Griddle   Nat Gas   Custom Color*   Pld Trim*	\$ 23,185	\$ 26,665
<b>LP/Propane Models: 48" Dual Fuel Range with 12" Griddle</b>			
BSDF486GL	6 Burner   12" Griddle   LP Gas   Stainless Steel   Std Trim	\$ 16,995	\$ 19,545
BSDF486GLPLT	6 Burner   12" Griddle   LP Gas   Stainless Steel   Pld Trim*	\$ 19,190	\$ 22,070
BSDF486GLC	6 Burner   12" Griddle   LP Gas   Std RAL Color*   Std Trim	\$ 18,490	\$ 21,265
BSDF486GLCPLT	6 Burner   12" Griddle   LP Gas   Std RAL Color*   Pld Trim*	\$ 20,685	\$ 23,790
BSDF486GLCF	6 Burner   12" Griddle   LP Gas   Spec Finish*   Std Trim	\$ 19,590	\$ 22,530
BSDF486GLCFPLT	6 Burner   12" Griddle   LP Gas   Spec Finish*   Pld Trim*	\$ 21,785	\$ 25,055
BSDF486GLCC	6 Burner   12" Griddle   LP Gas   Custom Color*   Std Trim	\$ 20,990	\$ 24,140
BSDF486GLCCPLT	6 Burner   12" Griddle   LP Gas   Custom Color*   Pld Trim*	\$ 23,185	\$ 26,665
<b>BACKGUARD OPTIONS:</b>			
<b>All BlueStar freestanding appliances must be installed with a UL approved backguard. All units ship standard with a UL approved Island Trim unless otherwise specified.</b>			
IT48DF	Island Trim Backguard (If purchased separately)	\$ 955	\$ 1,100
BG648DF	6" Backguard for 48" Dual Fuel Series	\$ 1,040	\$ 1,195
SDHS48DF	24" High Shelf for 48" Dual Fuel Series	\$ 2,340	\$ 2,690
<b>KNOB &amp; PAINTED BODY SIDE OPTIONS: (Total Knobs: 7)</b>			
SIDES-C	Add Painted Sides (All colors)	\$ 765	\$ 880
KN-BLK	Standard Black Knob (Must be ordered with unit)	N/C	N/C
KN-C	Knob: Standard 190 RAL Color	\$ 115 ea	\$ 130 ea
BZ-C	Bezel: Standard 190 RAL Color	\$ 70 ea	\$ 80 ea
KN-CF	Knob: Spec Finish (Matte RAL, Textured RAL or Prec Metals)	\$ 185 ea	\$ 215 ea
KN-PLT	Knob: Plated Trim (See options below)	\$ 250 ea	\$ 290 ea
<b>PLATED TRIM OPTIONS: (Includes bezels, door handle, handle ends and logo)</b>			
Antique Brass, Brushed Brass, Polished Brass, Antique Copper, Brushed Copper, Polished Copper, Chrome, Oil Rubbed Bronze & Pewter			

- Installation Clearance (Below Counter): 0" side cabinet | 0" back wall
- Installation Clearance (Above Counter): 6" side cabinet
- Door Clearance: 20" from front of door
- Shipping Weight: 665 lbs

## FREESTANDING RANGES: DUAL FUEL SERIES

Model Number Color & Customization Guide:			
(C) 190 Standard RAL (Semi-Gloss) Colors	(CF) Specialty Finish (190 Matte RAL, Precious Metals & Textures)	(CC) Custom Color Match	(PLT) Plated Trim

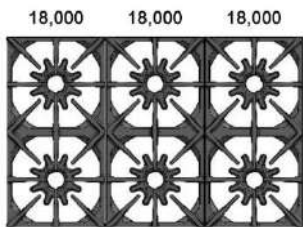

(\*) 4% less output when configured for LP/Propane

### FEATURES:

- Exclusive X-8™ star-shaped burner offers unmatched versatility and control on EVERY burner
- Go from extra-high sear – up to 25,000 BTUs – to an ultra-low warm of 500 BTUs on all burners
- Oversized True Convection electric oven offers even and consistent multi-rack cooking
- Fits commercial-size 18" x 26" baking sheets
- 8 cooking modes including Bake, Convection Bake, Roast, Convection Roast, Convection, Broil, Proof & Dehydrate, plus Sabbath setting and temperature probe
- Intuitive 7" touchscreen control with Quick Start™ cooking in 3 easy touches
- Environmentally friendly, gentle 90-minute express cleaning mode + Continu Clean™ technology
- Unmatched customization – choose from 1,000+ colors and 10 metal trim finishes
- Handcrafted in Pennsylvania since 1880

### PRODUCT SPECIFICATIONS:

- Overall Dimensions: 35 7/8"W x 26 1/2"D x 36"H
- Large Oven Interior: 29"W x 20"D x 16 5/8"H
- Bake Element Rating: 3500W (2500W Inner/ 1000W Outer)
- Broiler Rating: 5000W (2500 Inner / 2500W Outer)
- Large Oven Convection Element Rating: 2800W
- Top Burner Rating (Front): Nat: 25,000 BTUs | LP: 24,000 BTUS
- Top Burner Rating (Rear): 18,000 BTUs
- Simmer Burner Rating: 500 BTUs
- Electrical Requirements: 240VAC, 60Hz, 40 AMPs, 1 PH (Unit must be on a Non-GFI, dedicated outlet)
- Operating Gas Pressure: Nat: 5" WC | LP: 10" WC
- Gas Line Size: 3/4"
- Installation Clearance (Below Counter): 0" side cabinet | 0" back wall
- Installation Clearance (Above Counter): 6" side cabinet
- Door Clearance: 20" from front of door
- Shipping Weight: 425 lbs

Model	Description (* Denotes item that must be specified)	UMRP	MSRP
<b>Natural Gas Models: 36" Dual Fuel All Burner Range</b>			
BSDF366B	6 Burner   Nat Gas   Stainless Steel   Std Trim	\$ 11,995	\$ 13,795
BSDF366BPLT	6 Burner   Nat Gas   Stainless Steel   Plated Trim*	\$ 13,890	\$ 15,975
BSDF366BC	6 Burner   Nat Gas   Std RAL Color*   Std Trim	\$ 13,190	\$ 15,170
BSDF366BCPLT	6 Burner   Nat Gas   Std RAL Color*   Plated Trim*	\$ 15,085	\$ 17,350
BSDF366BCF	6 Burner   Nat Gas   Spec Finish*   Std Trim	\$ 14,190	\$ 16,320
BSDF366BCFPLT	6 Burner   Nat Gas   Spec Finish*   Plated Trim*	\$ 16,085	\$ 18,500
BSDF366BCC	6 Burner   Nat Gas   Custom Color*   Std Trim	\$ 15,690	\$ 18,045
BSDF366BCCPLT	6 Burner   Nat Gas   Custom Color*   Plated Trim*	\$ 17,585	\$ 20,225
<b>LP/Propane Models: 36" Dual Fuel All Burner Range</b>			
BSDF366BL	6 Burner   LP Gas   Stainless Steel   Std Trim	\$ 11,995	\$ 13,795
BSDF366BLPLT	6 Burner   LP Gas   Stainless Steel   Plated Trim*	\$ 13,890	\$ 15,975
BSDF366BLC	6 Burner   LP Gas   Std RAL Color*   Std Trim	\$ 13,190	\$ 15,170
BSDF366BLCPLT	6 Burner   LP Gas   Std RAL Color*   Plated Trim*	\$ 15,085	\$ 17,350
BSDF366BLCF	6 Burner   LP Gas   Spec Finish*   Std Trim	\$ 14,190	\$ 16,320
BSDF366BLCFPLT	6 Burner   LP Gas   Spec Finish*   Plated Trim*	\$ 16,085	\$ 18,500
BSDF366BLCC	6 Burner   LP Gas   Custom Color*   Std Trim	\$ 15,690	\$ 18,045
BSDF366BLCCPLT	6 Burner   LP Gas   Custom Color*   Plated Trim*	\$ 17,585	\$ 20,225
<b>BACKGUARD OPTIONS:</b>			
<b>All BlueStar freestanding appliances must be installed with a UL approved backguard. All units ship standard with a UL approved Island Trim unless otherwise specified.</b>			
IT36DF	Island Trim Backguard (If purchased separately)	\$ 665	\$ 765
BG636DF	6" Backguard for 36" Dual Fuel Series	\$ 720	\$ 830
SDHS36DF	24" High Shelf for 36" Dual Fuel Series	\$ 1,690	\$ 1,945
<b>KNOB &amp; PAINTED BODY SIDE OPTIONS: (Total Knobs 6)</b>			
SIDES-C	Add Painted Sides (All colors)	\$ 765	\$ 880
KN-BLK	Standard Black Knob (Must be ordered with unit)	N/C	N/C
KN-C	Knob: Standard 190 RAL Color	\$ 115 ea	\$ 130 ea
BZ-C	Bezel: Standard 190 RAL Color	\$ 70 ea	\$ 80 ea
KN-CF	Knob: Spec Finish (Matte RAL, Textured RAL or Prec Metals)	\$ 185 ea	\$ 215 ea
KN-PLT	Knob: Plated Trim (See options below)	\$ 250 ea	\$ 290 ea
<b>PLATED TRIM OPTIONS: (Includes bezels, door handle, handle ends and logo)</b>			
Antique Brass, Brushed Brass, Polished Brass, Antique Copper, Brushed Copper, Polished Copper, Chrome, Oil Rubbed Bronze & Pewter			

## FREESTANDING RANGES: DUAL FUEL SERIES

Model Number Color & Customization Guide:			
(C) 190 Standard RAL (Semi-Gloss) Colors	(CF) Specialty Finish (190 Matte RAL, Precious Metals & Textures)	(CC) Custom Color Match	(PLT) Plated Trim

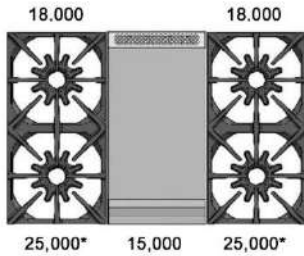

(\*) 4% less output when configured for LP/Propane

### FEATURES:

- Exclusive X-8™ star-shaped burner offers unmatched versatility and control on EVERY burner
- Go from extra-high sear – up to 25,000 BTUs – to an ultra-low warm of 500 BTUs on all burners
- Commercial-grade steel griddle with precise temperature control
- Oversized True Convection electric oven offers even and consistent multi-rack cooking
- Fits commercial-size 18" x 26" baking sheets
- 8 cooking modes including Bake, Convection Bake, Roast, Convection Roast, Convection Broil, Proof & Dehydrate, plus Sabbath setting and temperature probe
- Intuitive 7" touchscreen control with Quick Start™ cooking in 3 easy touches
- Environmentally friendly, gentle 90-minute express cleaning mode + Continuum Clean™ technology
- Unmatched customization – choose from 1,000+ colors and 10 metal trim finishes
- Handcrafted in Pennsylvania since 1880

### PRODUCT SPECIFICATIONS:

- Overall Dimensions: 35 7/8"W x 26 1/2"D x 36"H
- Large Oven Interior: 29"W x 20"D x 16 5/8"H
- Bake Element Rating: 3500W (2500W Inner/ 1000W Outer)
- Broiler Rating: 5000W (2500 Inner / 2500W Outer)
- Large Oven Convection Element Rating: 2800W
- Top Burner Rating (Front): Nat: 25,000 BTUs | LP: 24,000 BTUS
- Top Burner Rating (Rear): 18,000 BTUs
- Simmer Burner Rating: 500 BTUs
- 12" Griddle Rating: 15,000 BTUs
- Electrical Requirements: 240VAC, 60Hz, 40 AMPs, 1 PH (Unit must be on a Non-GFI, dedicated outlet)
- Operating Gas Pressure: Nat: 5" WC | LP: 10" WC
- Gas Line Size: 3/4"
- Installation Clearance (Below Counter): 0" side cabinet | 0" back wall
- Installation Clearance (Above Counter): 6" side cabinet
- Door Clearance: 20" from front of door
- Shipping Weight: 450 lbs

Model	Description (* Denotes item that must be specified)	UMRP	MSRP
<b>Natural Gas Models: 36" Dual Fuel Range with 12" Griddle</b>			
BSDF364G	4 Burner   12" Griddle   Nat Gas   Stainless Steel   Std Trim	\$ 12,995	\$ 14,945
BSDF364GPLT	4 Burner   12" Griddle   Nat Gas   Stainless Steel   Plated Trim*	\$ 14,890	\$ 17,125
BSDF364GC	4 Burner   12" Griddle   Nat Gas   Std RAL Color*   Std Trim	\$ 14,190	\$ 16,320
BSDF364GCPLT	4 Burner   12" Griddle   Nat Gas   Std RAL Color*   Plated Trim*	\$ 16,085	\$ 18,500
BSDF364GCF	4 Burner   12" Griddle   Nat Gas   Spec Finish*   Std Trim	\$ 15,190	\$ 17,470
BSDF364GCFPLT	4 Burner   12" Griddle   Nat Gas   Spec Finish*   Plated Trim*	\$ 17,085	\$ 19,650
BSDF364GCC	4 Burner   12" Griddle   Nat Gas   Custom Color*   Std Trim	\$ 16,690	\$ 19,195
BSDF364GCCPLT	4 Burner   12" Griddle   Nat Gas   Custom Color*   Plated Trim*	\$ 18,585	\$ 21,375
<b>LP/Propane Models: 36" Dual Fuel Range with 12" Griddle</b>			
BSDF364GL	4 Burner   12" Griddle   LP Gas   Stainless Steel   Std Trim	\$ 12,995	\$ 14,945
BSDF364GLPLT	4 Burner   12" Griddle   LP Gas   Stainless Steel   Plated Trim*	\$ 14,890	\$ 17,125
BSDF364GLC	4 Burner   12" Griddle   LP Gas   Std RAL Color*   Std Trim	\$ 14,190	\$ 16,320
BSDF364GLCPLT	4 Burner   12" Griddle   LP Gas   Std RAL Color*   Plated Trim*	\$ 16,085	\$ 18,500
BSDF364GLCF	4 Burner   12" Griddle   LP Gas   Spec Finish*   Std Trim	\$ 15,190	\$ 17,470
BSDF364GLCFPLT	4 Burner   12" Griddle   LP Gas   Spec Finish*   Plated Trim*	\$ 17,085	\$ 19,650
BSDF364GLCC	4 Burner   12" Griddle   LP Gas   Custom Color*   Std Trim	\$ 16,690	\$ 19,195
BSDF364GLCCPLT	4 Burner   12" Griddle   LP Gas   Custom Color*   Plated Trim*	\$ 18,585	\$ 21,375
<b>BACKGUARD OPTIONS:</b>			
<b>All BlueStar freestanding appliances must be installed with a UL approved backguard. All units ship standard with a UL approved Island Trim unless otherwise specified.</b>			
IT36DF	Island Trim Backguard (If purchased separately)	\$ 665	\$ 765
BG636DF	6" Backguard for 36" Dual Fuel Series	\$ 720	\$ 830
SDHS36DF	24" High Shelf for 36" Dual Fuel Series	\$ 1,690	\$ 1,945
<b>KNOB &amp; PAINTED BODY SIDE OPTIONS: (Total Knobs: 5)</b>			
SIDES-C	Add Painted Sides (All colors)	\$ 765	\$ 880
KN-BLK	Standard Black Knob (Must be ordered with unit)	N/C	N/C
KN-C	Knob: Standard 190 RAL Color	\$ 115 ea	\$ 130 ea
BZ-C	Bezel: Standard 190 RAL Color	\$ 70 ea	\$ 80 ea
KN-CF	Knob: Spec Finish (Matte RAL, Textured RAL or Prec Metals)	\$ 185 ea	\$ 215 ea
KN-PLT	Knob: Plated Trim (See options below)	\$ 250 ea	\$ 290 ea
<b>PLATED TRIM OPTIONS: (Includes bezels, door handle, handle ends and logo)</b>			
Antique Brass, Brushed Brass, Polished Brass, Antique Copper, Brushed Copper, Polished Copper, Chrome, Oil Rubbed Bronze & Pewter			

## FREESTANDING RANGES: DUAL FUEL SERIES

Model Number Color & Customization Guide:			
(C) 190 Standard RAL (Semi-Gloss) Colors	(CF) Specialty Finish (190 Matte RAL, Precious Metals & Textures)	(CC) Custom Color Match	(PLT) Plated Trim

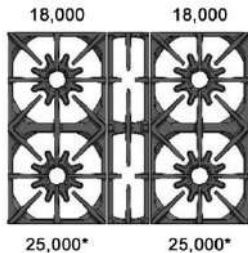

(\*) 4% less output when configured for LP/Propane

### FEATURES:

- Exclusive X-8™ star-shaped burner offers unmatched versatility and control on EVERY burner
- Go from extra-high sear – up to 25,000 BTUs – to an ultra-low warm of 500 BTUs on all burners
- Commercial-grade steel griddle with precise temperature control
- Oversized True Convection electric oven offers even and consistent multi-rack cooking
- Fits commercial-size 18" x 26" baking sheets
- 8 cooking modes including Bake, Convection Bake, Roast, Convection Roast, Convection Broil, Proof & Dehydrate, plus Sabbath setting and temperature probe
- Intuitive 7" touchscreen control with Quick Start™ cooking in 3 easy touches
- Environmentally friendly, gentle 90-minute express cleaning mode + Continu Clean™ technology
- Unmatched customization – choose from 1,000+ colors and 10 metal trim finishes
- Handcrafted in Pennsylvania since 1880

### PRODUCT SPECIFICATIONS:

- Overall Dimensions: 29 7/8"W x 26 1/2"D x 36"H
- Large Oven Interior: 26 1/4"W x 20"D x 16 5/8"H
- Bake Element Rating: 3500W (2500W Inner/ 1000W Outer)
- Broiler Rating: 5000W (2500 Inner / 2500W Outer)
- Large Oven Convection Element Rating: 2800W
- Top Burner Rating (Front): Nat: 25,000 BTUs | LP: 24,000 BTUS
- Top Burner Rating (Rear): 18,000 BTUs
- Simmer Burner Rating: 500 BTUs
- Electrical Requirements: 240VAC, 60Hz, 40 AMPs, 1 PH (Unit must be on a Non-GFI, dedicated outlet)
- Operating Gas Pressure: Nat: 5" WC | LP: 10" WC
- Gas Line Size: 1/2"
- Installation Clearance (Below Counter): 0" side cabinet | 0" back wall
- Installation Clearance (Above Counter): 6" side cabinet
- Door Clearance: 20" from front of door
- Shipping Weight: 375 lbs

Model	Description (* Denotes item that must be specified)	UMRP	MSRP
<b>Natural Gas Models: 30" Dual Fuel All Burner Range</b>			
BSDF304B	4 Burner   Nat Gas   Stainless Steel   Std Trim	\$ 8,295	\$ 9,540
BSDF304BPLT	4 Burner   Nat Gas   Stainless Steel   Plated Trim*	\$ 9,890	\$ 11,375
BSDF304BC	4 Burner   Nat Gas   Std RAL Color*   Std Trim	\$ 9,490	\$ 10,915
BSDF304BCPLT	4 Burner   Nat Gas   Std RAL Color*   Plated Trim*	\$ 11,085	\$ 12,750
BSDF304BCF	4 Burner   Nat Gas   Spec Finish*   Std Trim	\$ 10,490	\$ 12,065
BSDF304BCFPLT	4 Burner   Nat Gas   Spec Finish*   Plated Trim*	\$ 12,085	\$ 13,900
BSDF304BCC	4 Burner   Nat Gas   Custom Color*   Std Trim	\$ 11,990	\$ 13,790
BSDF304BCCPLT	4 Burner   Nat Gas   Custom Color*   Plated Trim*	\$ 13,585	\$ 15,625
<b>LP/Propane Models: 30" Dual Fuel All Burner Range</b>			
BSDF304BL	4 Burner   LP Gas   Stainless Steel   Std Trim	\$ 8,295	\$ 9,540
BSDF304BLPLT	4 Burner   LP Gas   Stainless Steel   Plated Trim*	\$ 9,890	\$ 11,375
BSDF304BLC	4 Burner   LP Gas   Std RAL Color*   Std Trim	\$ 9,490	\$ 10,915
BSDF304BLCPLT	4 Burner   LP Gas   Std RAL Color*   Plated Trim*	\$ 11,085	\$ 12,750
BSDF304BLCF	4 Burner   LP Gas   Spec Finish*   Std Trim	\$ 10,490	\$ 12,065
BSDF304BLCFPLT	4 Burner   LP Gas   Spec Finish*   Plated Trim*	\$ 12,085	\$ 13,900
BSDF304BLCC	4 Burner   LP Gas   Custom Color*   Std Trim	\$ 11,990	\$ 13,790
BSDF304BLCCPLT	4 Burner   LP Gas   Custom Color*   Plated Trim*	\$ 13,585	\$ 15,625
<b>BACKGUARD OPTIONS:</b>			
<b>All BlueStar freestanding appliances must be installed with a UL approved backguard. All units ship standard with a UL approved Island Trim unless otherwise specified.</b>			
IT30DF	Island Trim Backguard (If purchased separately)	\$ 565	\$ 650
BG630DF	6" Backguard for 30" Dual Fuel Series	\$ 605	\$ 695
SDHS30DF	24" High Shelf for 30" Dual Fuel Series	\$ 1,460	\$ 1,680
<b>KNOB &amp; PAINTED BODY SIDE OPTIONS: (Total Knobs: 5)</b>			
SIDES-C	Add Painted Sides (All colors)	\$ 765	\$ 880
KN-BLK	Standard Black Knob (Must be ordered with unit)	N/C	N/C
KN-C	Knob: Standard 190 RAL Color	\$ 115 ea	\$ 130 ea
BZ-C	Bezel: Standard 190 RAL Color	\$ 70 ea	\$ 80 ea
KN-CF	Knob: Spec Finish (Matte RAL, Textured RAL or Prec Metals)	\$ 185 ea	\$ 215 ea
KN-PLT	Knob: Plated Trim (See options below)	\$ 250 ea	\$ 290 ea
<b>PLATED TRIM OPTIONS: (Includes bezels, door handle, handle ends and logo)</b>			
Antique Brass, Brushed Brass, Polished Brass, Antique Copper, Brushed Copper, Polished Copper, Chrome, Oil Rubbed Bronze & Pewter			



# REVOLUTIONIZING THE ELECTRIC KITCHEN

---

## NEW 48" INDUCTION RANGE



- LARGEST INDUCTION COOKING SURFACE
- SIX OVER-SIZED INDEPENDENT COOKING ZONES THAT DELIVER BOTH PRECISION AND POWER
- MOST POWERFUL 7,400 WATT COOKING ZONES
- PATENT-PENDING POWER INDICATOR LIGHTING ON EACH BURNER
- VERSATILE COOKING SURFACE WITH TWO BRIDGES
- INTUITIVE 7" FULL-COLOR TOUCHSCREEN
- UNMATCHED CUSTOMIZATION OPTIONS

# FREESTANDING RANGES: 48" PLATINUM SERIES INDUCTION

## Model Number Color & Customization Guide:

(C) 190 Standard RAL (Semi-Gloss) Colors	(CF) Specialty Finish (190 Matte RAL, Precious Metals & Textures)	(CC) Custom Color Match	(PLT) Plated Trim
--	---	-------------------------	-------------------



### FEATURES:

- Largest surface cooking capacity, including two 11" zones
- Industry first – matte finish durable scratch and stain resistant cooking surface
- Most powerful cooking zone available at 7,400-Watts
- Versatile and efficient cooking surface with six individual, oversized cooking zones
- Two bridge functions creating dual power zones for oversized cookware like roasting pans and griddles
- Patent-pending, power-level indicator light for each zone
- Instant response and precise control on each cooking zone with nine levels of heat, plus simmer & keep warm options
- Power Optimization System for uninterrupted cooking
- Extra-Large True Convection oven offers even and consistent multi-rack cooking
- Fits commercial-size 18" x 26" baking sheets
- 8 cooking modes including Bake, Convection Bake, Roast, Convection Roast, Convection, Broil, Proof & Dehydrate, plus Sabbath setting and temperature probe
- Intuitive 7" touchscreen control with Quick Start™ cooking in 3 easy touches
- Environmentally friendly, gentle 90-minute express cleaning mode + Continuum Clean™ technology
- Unmatched customization – choose from 1,000+ colors and 10 metal trim finishes
- Handcrafted in Pennsylvania since 1880

Model	Description (* Denotes item that must be specified)	UMRP	MSRP
<b>INDUCTION: 48" PLATINUM SERIES</b>			
BSP1R486Z	6 Zone   Induction   Stainless Steel   Standard Trim	\$ 15,995	\$ 18,395
BSP1R486ZPLT	6 Zone   Induction   Stainless Steel   Plated Trim*	\$ 18,190	\$ 20,920
BSP1R486ZC	6 Zone   Induction   Std RAL Color*   Standard Trim	\$ 17,490	\$ 20,115
BSP1R486ZCPLT	6 Zone   Induction   Std RAL Color*   Plated Trim*	\$ 19,685	\$ 22,640
BSP1R486ZCF	6 Zone   Induction   Spec Finish*   Standard Trim	\$ 18,590	\$ 21,380
BSP1R486ZCFPLT	6 Zone   Induction   Spec Finish*   Plated Trim*	\$ 20,785	\$ 23,905
BSP1R486ZCC	6 Zone   Induction   Custom Color*   Standard Trim	\$ 19,990	\$ 22,990
BSP1R486ZCCPLT	6 Zone   Induction   Custom Color*   Plated Trim*	\$ 22,185	\$ 25,515
<b>BACKGUARD OPTIONS:</b>			
All BlueStar freestanding appliances must be installed with a UL approved backguard. All units ship standard with a UL approved Island Trim. No other backguard options available for this model.			
<b>KNOB &amp; PAINTED BODY SIDE OPTIONS: (Total Knobs: 6)</b>			
SIDES-C	Add Painted Sides (All colors)	\$ 765	\$ 880
KN-BLK	Standard Black Knob ( <i>Must be ordered with unit</i> )	N/C	N/C
KN-C	Knob: Standard 190 RAL Color	\$ 115 ea	\$ 130 ea
BZ-C	Bezel: Standard 190 RAL Color	\$ 70 ea	\$ 80 ea
KN-CF	Knob: Spec Finish (Matte RAL, Textured RAL or Prec Metals)	\$ 185 ea	\$ 215 ea
KN-PLT	Knob: Plated Trim (See options below)	\$ 250 ea	\$ 290 ea
<b>PLATED TRIM OPTIONS: (Includes bezels, door handle, handle ends and logo)</b>			
Antique Brass, Brushed Brass, Polished Brass, Antique Copper, Brushed Copper, Polished Copper, Chrome, Oil Rubbed Bronze & Pewter			
See page 40 for additional customization and accessories for Freestanding Ranges			

### PRODUCT SPECIFICATIONS:

- Unit Dimensions: 47 7/8"W x 26 1/2"D x 35 3/4" – 36 1/2"H
- Top Burner Boost Rating: 3,700 W
- Top Burner Rating: 2,100 W
- Left Bridge: 7,400 W
- Right Bridge: 3,700 W
- Large Oven Interior: 26 1/4"W x 20"D x 16 5/8"H
- Bake Element Rating: 3,500 W (2,500 W Inner / 1,000 W Outer)
- Broiler Element Rating: 5,000 W (2,500 W Inner / 2,500 W Outer)
- Convection Element Rating: 2,800 W
- Small Oven Interior: 14 1/8"W x 20"D x 16 5/8"H
- Small Oven Bake Element Rating: 2,100 W
- Small Oven Convection Element Rating: 2,800 W
- Electrical Requirements: 240/208 VAC, 60Hz, 50 AMPS
- Unit Weight: 750 lbs.
- Unit must be on a Non-GFI dedicated outlet

## FREESTANDING RANGES: 60" PLATINUM SERIES

Model Number Color & Customization Guide:			
(C) 190 Standard RAL (Semi-Gloss) Colors	(CF) Specialty Finish (190 Matte RAL, Precious Metals & Textures)	(CC) Custom Color Match	(PLT) Plated Trim



Simmer 15,000 18,000 15,000 18,000

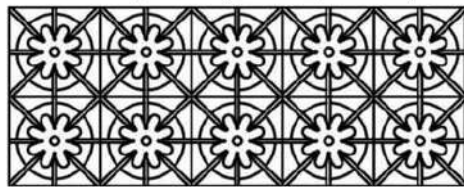

22,000 25,000 22,000 25,000 22,000

### FEATURES:

- 25,000 BTU PrimaNova™ burners
- All burners, plus Interchangeable Griddle and Charbroiler accessory
- The PowR Oven™ provides 40% faster preheating and 30% increase in oven efficiency
- Precise 130° simmer burner
- Integrated wok cooking
- Extra-large oven with True European Convection and 1850° infrared broiler
- Accommodates a full-size commercial 18" x 26" baking sheet
- Includes full extension rack
- Available in 1,000+ colors and finishes
- Handcrafted in Pennsylvania since 1880

### PRODUCT SPECIFICATIONS:

- Unit Dimensions: 59.875"W x 24"D x 36.75"H
- Oven Interior: 26.438"W x 20"D x 15"H
- Top Burner Power: 25,000 BTUs
- Simmer Burner: 9,000 BTUs
- Electrical Reqs: 120V, 60Hz, 15 AMPS, 1PH
- Gas Pressure: NAT: 5.0" WC, LP 10.0" WC
- Gas Line Size: 3/4"
- Unit Weight: 930 lbs.

Model	Description (* Denotes item that must be specified)	UMRP	MSRP
<b>Natural Gas Models: 60" Platinum Series</b>			
BSP6010B	10 Burner   Nat Gas   Stainless Steel   Standard Trim	\$ 18,995	\$ 21,845
BSP6010BPLT	10 Burner   Nat Gas   Stainless Steel   Plated Trim*	\$ 21,490	\$ 24,715
BSP6010BC	10 Burner   Nat Gas   Std RAL Color*   Standard Trim	\$ 20,490	\$ 23,565
BSP6010BCPLT	10 Burner   Nat Gas   Std RAL Color*   Plated Trim*	\$ 22,985	\$ 26,435
BSP6010BCF	10 Burner   Nat Gas   Specialty Finish*   Standard Trim	\$ 21,590	\$ 24,830
BSP6010BCFPLT	10 Burner   Nat Gas   Specialty Finish*   Plated Trim*	\$ 24,085	\$ 27,700
BSP6010BCC	10 Burner   Nat Gas   Custom Color*   Standard Trim	\$ 22,990	\$ 26,440
BSP6010BCCPLT	10 Burner   Nat Gas   Custom Color*   Plated Trim*	\$ 25,485	\$ 29,310
<b>LP/Propane Models: 60" Platinum Series</b>			
BSP6010BL	10 Burner   LP Gas   Stainless Steel   Standard Trim	\$ 18,995	\$ 21,845
BSP6010BLPLT	10 Burner   LP Gas   Stainless Steel   Plated Trim*	\$ 21,490	\$ 24,715
BSP6010BLC	10 Burner   LP Gas   Std RAL Color*   Standard Trim	\$ 20,490	\$ 23,565
BSP6010BLCPLT	10 Burner   LP Gas   Std RAL Color*   Plated Trim*	\$ 22,985	\$ 26,435
BSP6010BLCF	10 Burner   LP Gas   Specialty Finish*   Standard Trim	\$ 21,590	\$ 24,830
BSP6010BLCFPLT	10 Burner   LP Gas   Specialty Finish*   Plated Trim*	\$ 24,085	\$ 27,700
BSP6010BLCC	10 Burner   LP Gas   Custom Color*   Standard Trim	\$ 22,990	\$ 26,440
BSP6010BLCCPLT	10 Burner   LP Gas   Custom Color*   Plated Trim*	\$ 25,485	\$ 29,310
<b>BACKGUARD OPTIONS:</b>			
<b>All BlueStar freestanding appliances must be installed with a UL approved backguard. All units ship standard with a UL approved Island Trim unless otherwise specified.</b>			
BG660BSP	6" Backguard	\$ 1,530	\$ 1,760
BG6017BSP	17" Backguard	\$ 2,480	\$ 2,850
SDHS60BSP	24" High Shelf	\$ 2,900	\$ 3,335
<b>KNOB &amp; PAINTED BODY SIDE OPTIONS: (Total Knobs: 12)</b>			
SIDES-C	Add Painted Sides (All colors)	\$ 765	\$ 880
KN-BLK	Standard Black Knob (Must be ordered with unit)	N/C	N/C
KN-C	Knob: Standard 190 RAL Color	\$ 115 ea	\$ 130 ea
BZ-C	Bezel: Standard 190 RAL Color	\$ 70 ea	\$ 80 ea
KN-CF	Knob: Spec Finish (Matte RAL, Textured RAL or Prec Metals)	\$ 185 ea	\$ 215 ea
KN-PLT	Knob: Plated Trim (See options below)	\$ 250 ea	\$ 290 ea
<b>PLATED TRIM OPTIONS: (Includes bezels, door handle, handle ends and logo)</b>			
Antique Brass, Brushed Brass, Polished Brass, Antique Copper, Brushed Copper, Polished Copper, Chrome, Oil Rubbed Bronze & Pewter			
See page 40 for additional customization and accessories for Freestanding Ranges			

## FREESTANDING RANGES: 48" PLATINUM SERIES

### Model Number Color & Customization Guide:

(C) 190 Standard RAL (Semi-Gloss) Colors	(CF) Specialty Finish (190 Matte RAL, Precious Metals & Textures)	(CC) Custom Color Match	(PLT) Plated Trim
--	---	-------------------------	-------------------

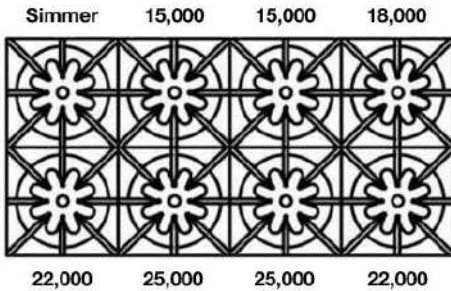

#### FEATURES:

- 25,000 BTU PrimaNova™ burners
- All burners, plus Interchangeable Griddle and Charbroiler accessory
- The PowR Oven™ provides 40% faster preheating and 30% increase in oven efficiency
- Precise 130° simmer burner
- Integrated wok cooking
- Extra-large oven with True European Convection and 1850° infrared broiler
- Accommodates a full-size commercial 18" x 26" baking sheet
- Includes full extension rack
- Available in 1,000+ colors and finishes
- Handcrafted in Pennsylvania since 1880

#### PRODUCT SPECIFICATIONS:

- Unit Dimensions: 47.875"W x 24"D x 36.75"H
- Large Oven Intr: 26.438"W x 20"D x 15"H
- Small Oven Intr: 13.578"W x 20"D x 15"H
- Top Burner Power: 25,000 BTUs
- Simmer Burner: 9,000 BTUs
- Electrical Reqs: 120V, 60Hz, 15 AMPS, 1PH
- Gas Pressure: NAT: 5.0" WC, LP 10.0" WC
- Gas Line Size: ¾"
- Unit Weight: 750 lbs.

Model	Description (* Denotes item that must be specified)	UMRP	MSRP
<b>Natural Gas Models: 48" Platinum Series</b>			
BSP488B	8 Burner   Nat Gas   Stainless Steel   Standard Trim	\$ 14,295	\$ 16,440
BSP488BPLT	8 Burner   Nat Gas   Stainless Steel   Plated Trim*	\$ 16,490	\$ 18,965
BSP488BC	8 Burner   Nat Gas   Std RAL Color*   Standard Trim	\$ 15,790	\$ 18,160
BSP488BCPLT	8 Burner   Nat Gas   Std RAL Color*   Plated Trim*	\$ 17,985	\$ 20,685
BSP488BCF	8 Burner   Nat Gas   Specialty Finish*   Standard Trim	\$ 16,890	\$ 19,425
BSP488BCFPLT	8 Burner   Nat Gas   Specialty Finish*   Plated Trim*	\$ 19,085	\$ 21,950
BSP488BCC	8 Burner   Nat Gas   Custom Color*   Standard Trim	\$ 18,290	\$ 21,035
BSP488BCCPLT	8 Burner   Nat Gas   Custom Color*   Plated Trim*	\$ 20,485	\$ 23,560
<b>LP/Propane Models: 48" Platinum Series</b>			
BSP488BL	8 Burner   LP Gas   Stainless Steel   Standard Trim	\$ 14,295	\$ 16,440
BSP488BLPLT	8 Burner   LP Gas   Stainless Steel   Plated Trim*	\$ 16,490	\$ 18,965
BSP488BLC	8 Burner   LP Gas   Std RAL Color*   Standard Trim	\$ 15,790	\$ 18,160
BSP488BLCPLT	8 Burner   LP Gas   Std RAL Color*   Plated Trim*	\$ 17,985	\$ 20,685
BSP488BLCF	8 Burner   LP Gas   Specialty Finish*   Standard Trim	\$ 16,890	\$ 19,425
BSP488BLCFPLT	8 Burner   LP Gas   Specialty Finish*   Plated Trim*	\$ 19,085	\$ 21,950
BSP488BLCC	8 Burner   LP Gas   Custom Color*   Standard Trim	\$ 18,290	\$ 21,035
BSP488BLCCPLT	8 Burner   LP Gas   Custom Color*   Plated Trim*	\$ 20,485	\$ 23,560
<b>BACKGUARD OPTIONS:</b>			
<b>All BlueStar freestanding appliances must be installed with a UL approved backguard. All units ship standard with a UL approved Island Trim unless otherwise specified.</b>			
BG648BSP	6" Backguard	\$ 1,040	\$ 1,095
BG4817BSP	17" Backguard	\$ 2,180	\$ 2,505
SDHS48BSP	24" High Shelf	\$ 2,340	\$ 2,690
<b>KNOB &amp; PAINTED BODY SIDE OPTIONS: (Total Knobs: 10)</b>			
SIDES-C	Add Painted Sides (All colors)	\$ 765	\$ 880
KN-BLK	Standard Black Knob (Must be ordered with unit)	N/C	N/C
KN-C	Knob: Standard 190 RAL Color	\$ 115 ea	\$ 130 ea
BZ-C	Bezel: Standard 190 RAL Color	\$ 70 ea	\$ 80 ea
KN-CF	Knob: Spec Finish (Matte RAL, Textured RAL or Prec Metals)	\$ 185 ea	\$ 215 ea
KN-PLT	Knob: Plated Trim (See options below)	\$ 250 ea	\$ 290 ea
<b>PLATED TRIM OPTIONS: (Includes bezels, door handle, handle ends and logo)</b>			
Antique Brass, Brushed Brass, Polished Brass, Antique Copper, Brushed Copper, Polished Copper, Chrome, Oil Rubbed Bronze & Pewter			
See page 40 for additional customization and accessories for Freestanding Ranges			

## FREESTANDING RANGES: 36" PLATINUM SERIES

Model Number Color & Customization Guide:			
(C) 190 Standard RAL (Semi-Gloss) Colors	(CF) Specialty Finish (190 Matte RAL, Precious Metals & Textures)	(CC) Custom Color Match	(PLT) Plated Trim

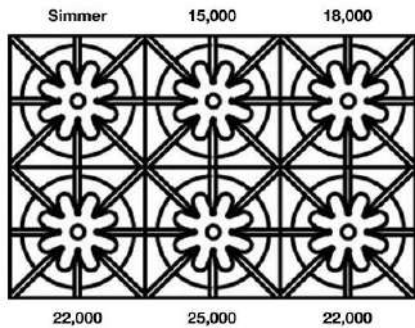

### FEATURES:

- 25,000 BTU PrimaNova™ burners
- All burners, plus Interchangeable Griddle and Charbroiler accessory
- The PowR Oven™ provides 40% faster preheating and 30% increase in oven efficiency
- Precise 130° simmer burner
- Integrated wok cooking
- Extra-large oven with True European Convection and 1850° infrared broiler
- Accommodates a full-size commercial 18" x 26" baking sheet
- Includes full extension rack
- Available in 1,000+ colors and finishes
- Handcrafted in Pennsylvania since 1880

### PRODUCT SPECIFICATIONS:

- Unit Dimensions: 35.875"W x 24"D x 36.75"H
- Oven Interior: 29.25"W x 20"D x 15"H
- Top Burner Power: 25,000 BTUs
- Simmer Burner: 9,000 BTUs
- Electrical Reqs: 120V, 60Hz, 15 AMPS, 1PH
- Gas Pressure: NAT: 5.0" WC, LP 10.0" WC
- Gas Line Size: ½
- Unit Weight: 555 lbs.

Model	Description (* Denotes item that must be specified)	UMRP	MSRP
<b>Natural Gas Models: 36" Platinum Series</b>			
BSP366B	6 Burner   Nat Gas   Stainless Steel   Standard Trim	\$ 10,495	\$ 12,070
BSP366BPLT	6 Burner   Nat Gas   Stainless Steel   Plated Trim*	\$ 12,390	\$ 14,250
BSP366BC	6 Burner   Nat Gas   Std RAL Color*   Standard Trim	\$ 11,690	\$ 13,445
BSP366BCPLT	6 Burner   Nat Gas   Std RAL Color*   Plated Trim*	\$ 13,585	\$ 15,625
BSP366BCF	6 Burner   Nat Gas   Specialty Finish*   Standard Trim	\$ 12,690	\$ 14,595
BSP366BCFPLT	6 Burner   Nat Gas   Specialty Finish*   Plated Trim*	\$ 14,585	\$ 16,775
BSP366BCC	6 Burner   Nat Gas   Custom Color*   Standard Trim	\$ 14,190	\$ 16,320
BSP366BCCPLT	6 Burner   Nat Gas   Custom Color*   Plated Trim*	\$ 16,085	\$ 18,500
<b>LP/Propane Models: 36" Platinum Series</b>			
BSP366BL	6 Burner   LP Gas   Stainless Steel   Standard Trim	\$ 10,495	\$ 12,070
BSP366BLPLT	6 Burner   LP Gas   Stainless Steel   Plated Trim*	\$ 12,390	\$ 14,250
BSP366BLC	6 Burner   LP Gas   Std RAL Color*   Standard Trim	\$ 11,690	\$ 13,445
BSP366BLCLPT	6 Burner   LP Gas   Std RAL Color*   Plated Trim*	\$ 13,585	\$ 15,625
BSP366BLCF	6 Burner   LP Gas   Specialty Finish*   Standard Trim	\$ 12,690	\$ 14,595
BSP366BLCFPLT	6 Burner   LP Gas   Specialty Finish*   Plated Trim*	\$ 14,585	\$ 16,775
BSP366BLCC	6 Burner   LP Gas   Custom Color*   Standard Trim	\$ 14,190	\$ 16,320
BSP366BLCCPLT	6 Burner   LP Gas   Custom Color*   Plated Trim*	\$ 16,085	\$ 18,500
<b>BACKGUARD OPTIONS:</b>			
<b>All BlueStar freestanding appliances must be installed with a UL approved backguard. All units ship standard with a UL approved Island Trim unless otherwise specified.</b>			
BG636BSP	6" Backguard	\$ 720	\$ 830
BG3617BSP	17" Backguard	\$ 1,460	\$ 1,680
SDHS36BSP	24" High Shelf	\$ 1,690	\$ 1,945
<b>KNOB &amp; PAINTED BODY SIDE OPTIONS: (Total Knobs: 7)</b>			
SIDES-C	Add Painted Sides (All colors)	\$ 765	\$ 880
KN-BLK	Standard Black Knob (Must be ordered with unit)	N/C	N/C
KN-C	Knob: Standard 190 RAL Color	\$ 115 ea	\$ 130 ea
BZ-C	Bezel: Standard 190 RAL Color	\$ 70 ea	\$ 80 ea
KN-CF	Knob: Spec Finish (Matte RAL, Textured RAL or Prec Metals)	\$ 185 ea	\$ 215 ea
KN-PLT	Knob: Plated Trim (See options below)	\$ 250 ea	\$ 290 ea
<b>PLATED TRIM OPTIONS: (Includes bezels, door handle, handle ends and logo)</b>			
Antique Brass, Brushed Brass, Polished Brass, Antique Copper, Brushed Copper, Polished Copper, Chrome, Oil Rubbed Bronze & Pewter			
See page 40 for additional customization and accessories for Freestanding Ranges			

## FREESTANDING RANGES: 30" PLATINUM SERIES

Model Number Color & Customization Guide:			
(C) 190 Standard RAL (Semi-Gloss) Colors	(CF) Specialty Finish (190 Matte RAL, Precious Metals & Textures)	(CC) Custom Color Match	(PLT) Plated Trim

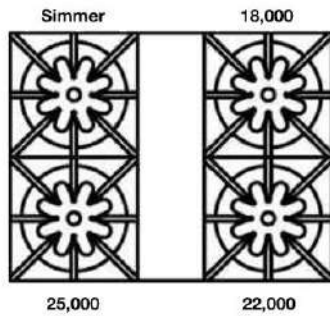

### FEATURES:

- 25,000 BTU PrimaNova™ burners
- All burners, plus Interchangeable Griddle and Charbroiler accessory
- The PowR Oven™ provides 40% faster preheating and 30% increase in oven efficiency
- Precise 130° simmer burner
- Integrated wok cooking
- Extra-large oven with True European Convection and 1850° infrared broiler
- Accommodates a full-size commercial 18" x 26" baking sheet
- Available in 1,000+ colors and finishes
- Includes full extension rack
- Handcrafted in Pennsylvania since 1880

### PRODUCT SPECIFICATIONS:

- Unit Dimensions: 29.875W x 24"D x 36.75"H
- Oven Interior: 26.438"W x 20"D x 15"H
- Top Burner Power: 25,000 BTUs
- Simmer Burner: 9,000 BTUs
- Electrical Reqs: 120V, 60Hz, 15 AMPS, 1PH
- Gas Pressure: NAT: 5.0" WC, LP 10.0" WC
- Gas Line Size: ½
- Unit Weight: 480 lbs.

Model	Description (* Denotes item that must be specified)	UMRP	MSRP
<b>Natural Gas Models: 30" Platinum Series</b>			
BSP304B	4 Burner   Nat Gas   Stainless Steel   Standard Trim	\$ 7,795	\$ 8,965
BSP304BPLT	4 Burner   Nat Gas   Stainless Steel   Plated Trim*	\$ 9,390	\$ 10,800
BSP304BC	4 Burner   Nat Gas   Std RAL Color*   Standard Trim	\$ 8,990	\$ 10,340
BSP304BCPLT	4 Burner   Nat Gas   Std RAL Color*   Plated Trim*	\$ 10,585	\$ 12,175
BSP304BCF	4 Burner   Nat Gas   Specialty Finish*   Standard Trim	\$ 9,990	\$ 11,490
BSP304CFPLT	4 Burner   Nat Gas   Specialty Finish*   Plated Trim*	\$ 11,585	\$ 13,325
BSP304BCC	4 Burner   Nat Gas   Custom Color*   Standard Trim	\$ 11,490	\$ 13,215
BSP304BCCPLT	4 Burner   Nat Gas   Custom Color*   Plated Trim*	\$ 13,085	\$ 15,050
<b>LP/Propane Models: 30" Platinum Series</b>			
BSP304BL	4 Burner   LP Gas   Stainless Steel   Standard Trim	\$ 7,795	\$ 8,965
BSP304BLPLT	4 Burner   LP Gas   Stainless Steel   Plated Trim*	\$ 9,390	\$ 10,800
BSP304BLC	4 Burner   LP Gas   Std RAL Color*   Standard Trim	\$ 8,990	\$ 10,340
BSP304BLCPLT	4 Burner   LP Gas   Std RAL Color*   Plated Trim*	\$ 10,585	\$ 12,175
BSP304BLCF	4 Burner   LP Gas   Specialty Finish*   Standard Trim	\$ 9,990	\$ 11,490
BSP304BLCFPLT	4 Burner   LP Gas   Specialty Finish*   Plated Trim*	\$ 11,585	\$ 13,325
BSP304BLCC	4 Burner   LP Gas   Custom Color*   Standard Trim	\$ 11,490	\$ 13,215
BSP304BLCCPLT	4 Burner   LP Gas   Custom Color*   Plated Trim*	\$ 13,085	\$ 15,050
<b>BACKGUARD OPTIONS:</b>			
<b>All BlueStar freestanding appliances must be installed with a UL approved backguard. All units ship standard with a UL approved Island Trim unless otherwise specified.</b>			
BG630BSP	6" Backguard	\$ 605	\$ 695
BG3017BSP	17" Backguard	\$ 1,120	\$ 1,290
SDHS30BSP	24" High Shelf	\$ 1,460	\$ 1,680
<b>KNOB &amp; PAINTED BODY SIDE OPTIONS: (Total Knobs: 5)</b>			
SIDES-C	Add Painted Sides (All colors)	\$ 765	\$ 880
KN-BLK	Standard Black Knob (Must be ordered with unit)	N/C	N/C
KN-C	Knob: Standard 190 RAL Color	\$ 115 ea	\$ 130 ea
BZ-C	Bezel: Standard 190 RAL Color	\$ 70 ea	\$ 80 ea
KN-CF	Knob: Spec Finish (Matte RAL, Textured RAL or Prec Metals)	\$ 185 ea	\$ 215 ea
KN-PLT	Knob: Plated Trim (See options below)	\$ 250 ea	\$ 290 ea
<b>PLATED TRIM OPTIONS: (Includes bezels, door handle, handle ends and logo)</b>			
Antique Brass, Brushed Brass, Polished Brass, Antique Copper, Brushed Copper, Polished Copper, Chrome, Oil Rubbed Bronze & Pewter			
See page 40 for additional customization and accessories for Freestanding Ranges			

## FREESTANDING RANGES: 24" PLATINUM SERIES

### Model Number Color & Customization Guide:

(C) 190 Standard RAL (Semi-Gloss) Colors	(CF) Specialty Finish (190 Matte RAL, Precious Metals & Textures)	(CC) Custom Color Match	(PLT) Plated Trim
--	---	-------------------------	-------------------

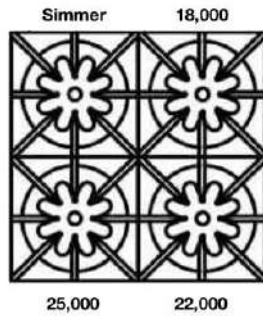

#### FEATURES:

- 25,000 BTU PrimaNova™ burners
- All burners, plus Interchangeable Griddle and Charbroiler accessory
- The PowR Oven™ provides 40% faster preheating and 30% increase in oven efficiency
- Precise 130° simmer burner
- Integrated wok cooking
- Extra-large oven with True European Convection and 1850° infrared broiler
- Accommodates a half-size commercial 18" x 13" baking sheet
- Includes full extension rack
- Available in 1,000+ colors and finishes
- Handcrafted in Pennsylvania since 1880

#### PRODUCT SPECIFICATIONS:

- Unit Dimensions: 23.875"W x 24"D x 36.75"H
- Oven Interior: 20.25"W x 20"D x 15"H
- Top Burner Power: 25,000 BTUs
- Simmer Burner: 9,000 BTUs
- Electrical Reqs: 120V, 60Hz, 15 AMPS, 1PH
- Gas Pressure: NAT: 5.0" WC, LP 10.0" WC
- Gas Line Size: ½
- Unit Weight: 435 lbs.

Model	Description (* Denotes item that must be specified)	UMRP	MSRP
<b>Natural Gas Models: 24" Platinum Series</b>			
BSP244B	4 Burner   Nat Gas   Stainless Steel   Standard Trim	\$ 7,095	\$ 8,160
BSP244BPLT	4 Burner   Nat Gas   Stainless Steel   Plated Trim*	\$ 8,690	\$ 9,995
BSP244BC	4 Burner   Nat Gas   Std RAL Color*   Standard Trim	\$ 8,290	\$ 9,535
BSP244BCPLT	4 Burner   Nat Gas   Std RAL Color*   Plated Trim*	\$ 9,885	\$ 11,370
BSP244BCF	4 Burner   Nat Gas   Specialty Finish*   Standard Trim	\$ 9,290	\$ 10,685
BSP244BCFPLT	4 Burner   Nat Gas   Specialty Finish*   Plated Trim*	\$ 10,885	\$ 12,520
BSP244BCC	4 Burner   Nat Gas   Custom Color*   Standard Trim	\$ 10,790	\$ 12,410
BSP244BCCPLT	4 Burner   Nat Gas   Custom Color*   Plated Trim*	\$ 12,385	\$ 14,245
<b>LP/Propane Models: 24" Platinum Series</b>			
BSP244BL	4 Burner   LP Gas   Stainless Steel   Standard Trim	\$ 7,095	\$ 8,160
BSP244BLPLT	4 Burner   LP Gas   Stainless Steel   Plated Trim*	\$ 8,690	\$ 9,995
BSP244BLC	4 Burner   LP Gas   Std RAL Color*   Standard Trim	\$ 8,290	\$ 9,535
BSP244BLCPLT	4 Burner   LP Gas   Std RAL Color*   Plated Trim*	\$ 9,885	\$ 11,370
BSP244BLCF	4 Burner   LP Gas   Specialty Finish*   Standard Trim	\$ 9,290	\$ 10,685
BSP244BLCFPLT	4 Burner   LP Gas   Specialty Finish*   Plated Trim*	\$ 10,885	\$ 12,520
BSP244BLCC	4 Burner   LP Gas   Custom Color*   Standard Trim	\$ 10,790	\$ 12,410
BSP244BLCCPLT	4 Burner   LP Gas   Custom Color*   Plated Trim*	\$ 12,385	\$ 14,245
<b>BACKGUARD OPTIONS:</b>			
<b>All BlueStar freestanding appliances must be installed with a UL approved backguard. All units ship standard with a UL approved Island Trim unless otherwise specified.</b>			
BG624BSP	6" Backguard	\$ 605	\$ 695
BG2417BSP	17" Backguard	\$ 1,120	\$ 1,290
SDHS24BSP	24" High Shelf	\$ 1,460	\$ 1,680
<b>ADDITIONAL PAINT, KNOB AND CUSTOMIZATION OPTIONS: (Total Knobs: 5)</b>			
SIDES-C	Add Painted Sides (All colors)	\$ 765	\$ 880
KN-BLK	Standard Black Knob (Must be ordered with unit)	N/C	N/C
KN-C	Knob: Standard 190 RAL Color	\$ 115 ea	\$ 130 ea
BZ-C	Bezel: Standard 190 RAL Color	\$ 70 ea	\$ 80 ea
KN-CF	Knob: Spec Finish (Matte RAL, Textured RAL or Prec Metals)	\$ 185 ea	\$ 215 ea
KN-PLT	Knob: Plated Trim (See options below)	\$ 250 ea	\$ 290 ea
<b>PLATED TRIM OPTIONS: (Includes bezels, door handle, handle ends and logo)</b>			
Antique Brass, Brushed Brass, Polished Brass, Antique Copper, Brushed Copper, Polished Copper, Chrome, Oil Rubbed Bronze & Pewter			
See page 40 for additional customization and accessories for Freestanding Ranges			

## FREESTANDING RANGES: 60" NOVA (RNB) SERIES

### Model Number Color & Customization Guide:

(C) 190 Standard RAL (Semi-Gloss) Colors	(CF) Specialty Finish (190 Matte RAL, Precious Metals & Textures)	(CC) Custom Color Match	(PLT) Plated Trim
--	---	-------------------------	-------------------



Simmer 15,000 15,000 15,000 15,000

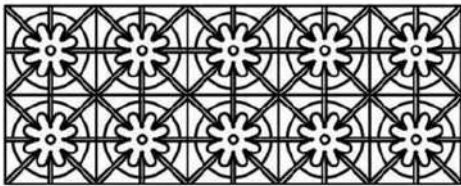

22,000 15,000 15,000 15,000 22,000

#### FEATURES:

- 22,000 BTU UltraNova™ burners & 15,000 BTU Nova™ burners
- Available with all burners or add integrated griddle, charbroiler or French top
- Extra-large convection oven with 1850° infrared broiler that accommodates a full size 18" x 26" commercial baking sheet
- Available with swing doors
- Available in 1,000+ colors & finishes plus additional customization options
- Handcrafted in Pennsylvania since 1880

#### PRODUCT SPECIFICATIONS:

- Unit Dimensions: 59.875"W x 24"D x 36.75"H
- Oven Interior: 26.438"W x 20"D x 15"H
- Top Burner Power: 22,000 BTUs
- Simmer Burner: 9,000 BTUs
- Electrical Reqs: 120V, 60Hz, 15 AMPS, 1PH
- Gas Pressure: NAT: 5.0" WC, LP 10.0" WC
- Gas Line Size: ¾"
- Unit Weight: 800 lbs.

Model	Description (* Denotes item that must be specified)	UMRP	MSRP
<b>Natural Gas Models: 60" Nova (RNB) Series</b>			
RNB6010BV2	10 Burner   Nat Gas   Stainless Steel   Standard Trim	\$ 18,795	\$ 21,615
RNB6010BV2PLT	10 Burner   Nat Gas   Stainless Steel   Plated Trim*	\$ 21,290	\$ 24,485
RNB6010BV2C	10 Burner   Nat Gas   Std RAL Color*   Standard Trim	\$ 20,290	\$ 23,335
RNB6010BV2CPLT	10 Burner   Nat Gas   Std RAL Color*   Plated Trim*	\$ 22,785	\$ 26,205
RNB6010BV2CF	10 Burner   Nat Gas   Specialty Finish*   Standard Trim	\$ 21,390	\$ 24,600
RNB6010BV2CFPLT	10 Burner   Nat Gas   Specialty Finish*   Plated Trim*	\$ 23,885	\$ 27,470
RNB6010BV2CC	10 Burner   Nat Gas   Custom Color*   Standard Trim	\$ 22,790	\$ 26,210
RNB6010BV2CCPLT	10 Burner   Nat Gas   Custom Color*   Plated Trim*	\$ 25,285	\$ 29,080
<b>LP/Propane Models: 60" Nova (RNB) Series</b>			
RNB6010BV2L	10 Burner   LP Gas   Stainless Steel   Standard Trim	\$ 18,795	\$ 21,615
RNB6010BV2LPLT	10 Burner   LP Gas   Stainless Steel   Plated Trim*	\$ 21,290	\$ 24,485
RNB6010BV2LC	10 Burner   LP Gas   Std RAL Color*   Standard Trim	\$ 20,290	\$ 23,335
RNB6010BV2LCPLT	10 Burner   LP Gas   Std RAL Color*   Plated Trim*	\$ 22,785	\$ 26,205
RNB6010BV2LCF	10 Burner   LP Gas   Specialty Finish*   Standard Trim	\$ 21,390	\$ 24,600
RNB6010BV2LCFPLT	10 Burner   LP Gas   Specialty Finish*   Plated Trim*	\$ 23,885	\$ 27,470
RNB6010BV2LCC	10 Burner   LP Gas   Custom Color*   Standard Trim	\$ 22,790	\$ 26,210
RNB6010BV2LCCPLT	10 Burner   LP Gas   Custom Color*   Plated Trim*	\$ 25,285	\$ 29,080
<b>BACKGUARD OPTIONS:</b>			
<b>All BlueStar freestanding appliances must be installed with a UL approved backguard. All units ship standard with a UL approved Island Trim unless otherwise specified.</b>			
BG660BSP	6" Backguard	\$ 1,530	\$ 1,760
BG6017BSP	17" Backguard	\$ 2,480	\$ 2,850
SDHS60BSP	24" High Shelf	\$ 2,900	\$ 3,335
<b>KNOB &amp; PAINTED BODY SIDE OPTIONS: (Total Knobs: 12)</b>			
SIDES-C	Add Painted Sides (All colors)	\$ 765	\$ 880
KN-BLK	Standard Black Knob (Must be ordered with unit)	N/C	N/C
KN-C	Knob: Standard 190 RAL Color	\$ 115 ea	\$ 130 ea
BZ-C	Bezel: Standard 190 RAL Color	\$ 70 ea	\$ 80 ea
KN-CF	Knob: Spec Finish (Matte RAL, Textured RAL or Prec Metals)	\$ 185 ea	\$ 215 ea
KN-PLT	Knob: Plated Trim (See options below)	\$ 250 ea	\$ 290 ea
<b>SWING DOOR OPTIONS:</b>			
SWING DOOR – LH	Swing Door – Left Hinge for Nova (RNB) Series	\$ 1,530	\$ 1,760
SWING DOOR – RH	Swing Door – Right Hinge for Nova (RNB) Series	\$ 1,530	\$ 1,760
<b>PLATED TRIM OPTIONS: (Includes bezels, door handle, handle ends and logo)</b>			
Antique Brass, Brushed Brass, Polished Brass, Antique Copper, Brushed Copper, Polished Copper, Chrome, Oil Rubbed Bronze & Pewter			
See page 40 for additional customization and accessories for Freestanding Ranges			

## FREESTANDING RANGES: 60" NOVA (RNB) SERIES

**60" Nova (RNB) Series  
with 12" Charbroiler**

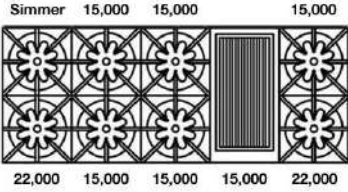

Model	Description (* Denotes item that must be specified)	UMRP	MSRP
<b>Natural Gas Models: 60" Nova Series with 12" Charbroiler</b>			
RNB608CBV2	8 Burner   12" Charbroiler   Nat Gas   Stainless Steel   Standard Trim	\$ 17,995	\$ 20,695
RNB608CBV2PLT	8 Burner   12" Charbroiler   Nat Gas   Stainless Steel   Plated Trim*	\$ 20,490	\$ 23,565
RNB608CBV2C	8 Burner   12" Charbroiler   Nat Gas   Std RAL Paint*   Standard Trim	\$ 19,490	\$ 22,415
RNB608CBV2CPLT	8 Burner   12" Charbroiler   Nat Gas   Std RAL Paint*   Plated Trim*	\$ 21,985	\$ 25,285
RNB608CBV2CF	8 Burner   12" Charbroiler   Nat Gas   Specialty Finish*   Standard Trim	\$ 20,590	\$ 23,680
RNB608CBV2CFPLT	8 Burner   12" Charbroiler   Nat Gas   Specialty Finish*   Plated Trim*	\$ 23,085	\$ 26,550
RNB608CBV2CC	8 Burner   12" Charbroiler   Nat Gas   Custom Color*   Standard Trim	\$ 21,990	\$ 25,290
RNB608CBV2CCPLT	8 Burner   12" Charbroiler   Nat Gas   Custom Color*   Plated Trim*	\$ 24,485	\$ 28,160
<b>LP/Propane Models: 60" Nova Series with 12" Charbroiler</b>			
RNB608CBV2L	8 Burner   12" Charbroiler   LP Gas   Stainless Steel   Standard Trim	\$ 17,995	\$ 20,695
RNB608CBV2LPLT	8 Burner   12" Charbroiler   LP Gas   Stainless Steel   Plated Trim*	\$ 20,490	\$ 23,565
RNB608CBV2LC	8 Burner   12" Charbroiler   LP Gas   Std RAL Paint*   Standard Trim	\$ 19,490	\$ 22,415
RNB608CBV2LCPLT	8 Burner   12" Charbroiler   LP Gas   Std RAL Paint*   Plated Trim*	\$ 21,985	\$ 25,285
RNB608CBV2LCF	8 Burner   12" Charbroiler   LP Gas   Specialty Finish*   Standard Trim	\$ 20,590	\$ 23,680
RNB608CBV2LCFPLT	8 Burner   12" Charbroiler   LP Gas   Specialty Finish*   Plated Trim*	\$ 23,085	\$ 26,550
RNB608CBV2LCC	8 Burner   12" Charbroiler   LP Gas   Custom Color*   Standard Trim	\$ 21,990	\$ 25,290
RNB608CBV2LCCPLT	8 Burner   12" Charbroiler   LP Gas   Custom Color*   Plated Trim*	\$ 24,485	\$ 28,160
<b>Customization &amp; Accessory Options: (See page 19)   Total Knobs: 11</b>			

**60" Nova (RNB) Series  
with 24" Charbroiler**

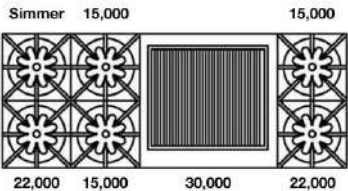

Model	Description (* Denotes item that must be specified)	UMRP	MSRP
<b>Natural Gas Models: 60" Nova Series with 24" Charbroiler</b>			
RNB606CBV2	6 Burner   24" Charbroiler   Nat Gas   Stainless Steel   Standard Trim	\$ 18,495	\$ 21,270
RNB606CBV2PLT	6 Burner   24" Charbroiler   Nat Gas   Stainless Steel   Plated Trim*	\$ 20,990	\$ 24,140
RNB606CBV2C	6 Burner   24" Charbroiler   Nat Gas   Std RAL Paint*   Standard Trim	\$ 19,990	\$ 22,990
RNB606CBV2CPLT	6 Burner   24" Charbroiler   Nat Gas   Std RAL Paint*   Plated Trim*	\$ 22,485	\$ 25,860
RNB606CBV2CF	6 Burner   24" Charbroiler   Nat Gas   Specialty Finish*   Standard Trim	\$ 21,090	\$ 24,255
RNB606CBV2CFPLT	6 Burner   24" Charbroiler   Nat Gas   Specialty Finish*   Plated Trim*	\$ 23,585	\$ 27,125
RNB606CBV2CC	6 Burner   24" Charbroiler   Nat Gas   Custom Color*   Standard Trim	\$ 22,490	\$ 25,865
RNB606CBV2CCPLT	6 Burner   24" Charbroiler   Nat Gas   Custom Color*   Plated Trim*	\$ 24,985	\$ 28,735
<b>LP/Propane Models: 60" Nova Series with 24" Charbroiler</b>			
RNB606CBV2L	6 Burner   24" Charbroiler   LP Gas   Stainless Steel   Standard Trim	\$ 18,495	\$ 21,270
RNB606CBV2LPLT	6 Burner   24" Charbroiler   LP Gas   Stainless Steel   Plated Trim*	\$ 20,990	\$ 24,140
RNB606CBV2LC	6 Burner   24" Charbroiler   LP Gas   Std RAL Paint*   Standard Trim	\$ 19,990	\$ 22,990
RNB606CBV2LCPLT	6 Burner   24" Charbroiler   LP Gas   Std RAL Paint*   Plated Trim*	\$ 22,485	\$ 25,860
RNB606CBV2LCF	6 Burner   24" Charbroiler   LP Gas   Specialty Finish*   Standard Trim	\$ 21,090	\$ 24,255
RNB606CBV2LCFPLT	6 Burner   24" Charbroiler   LP Gas   Specialty Finish*   Plated Trim*	\$ 23,585	\$ 27,125
RNB606CBV2LCC	6 Burner   24" Charbroiler   LP Gas   Custom Color*   Standard Trim	\$ 22,490	\$ 25,865
RNB606CBV2LCCPLT	6 Burner   24" Charbroiler   LP Gas   Custom Color*   Plated Trim*	\$ 24,985	\$ 28,735
<b>Customization &amp; Accessory Options: (See page 19)   Total Knobs: 10</b>			

## FREESTANDING RANGES: 60" NOVA (RNB) SERIES

**60" Nova (RNB) Series  
with 12" Griddle**

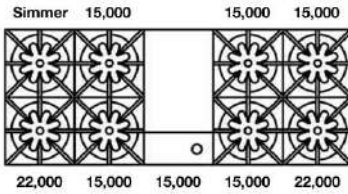

Model	Description (* Denotes item that must be specified)	UMRP	MSRP
<b>Natural Gas Models: 60" Nova Series with 12" Griddle</b>			
RNB608GV2	8 Burner   12" Griddle   Nat Gas   Stainless Steel   Standard Trim	\$ 17,995	\$ 20,695
RNB608GV2PLT	8 Burner   12" Griddle   Nat Gas   Stainless Steel   Plated Trim*	\$ 20,490	\$ 23,565
RNB608GV2C	8 Burner   12" Griddle   Nat Gas   Std RAL Paint*   Standard Trim	\$ 19,490	\$ 22,415
RNB608GV2CPLT	8 Burner   12" Griddle   Nat Gas   Std RAL Paint*   Plated Trim*	\$ 21,985	\$ 25,285
RNB608GV2CF	8 Burner   12" Griddle   Nat Gas   Specialty Finish*   Standard Trim	\$ 20,590	\$ 23,680
RNB608GV2CFPLT	8 Burner   12" Griddle   Nat Gas   Specialty Finish*   Plated Trim*	\$ 23,085	\$ 26,550
RNB608GV2CC	8 Burner   12" Griddle   Nat Gas   Custom Color*   Standard Trim	\$ 21,990	\$ 25,290
RNB608GV2CCPLT	8 Burner   12" Griddle   Nat Gas   Custom Color*   Plated Trim*	\$ 24,485	\$ 28,160
<b>LP/Propane Models: 60" Nova Series with 12" Griddle</b>			
RNB608GV2L	8 Burner   12" Griddle   LP Gas   Stainless Steel   Standard Trim	\$ 17,995	\$ 20,695
RNB608GV2LPLT	8 Burner   12" Griddle   LP Gas   Stainless Steel   Plated Trim*	\$ 20,490	\$ 23,565
RNB608GV2LC	8 Burner   12" Griddle   LP Gas   Std RAL Paint*   Standard Trim	\$ 19,490	\$ 22,415
RNB608GV2LCPLT	8 Burner   12" Griddle   LP Gas   Std RAL Paint*   Plated Trim*	\$ 21,985	\$ 25,285
RNB608GV2LCF	8 Burner   12" Griddle   LP Gas   Specialty Finish*   Standard Trim	\$ 20,590	\$ 23,680
RNB608GV2LCFPLT	8 Burner   12" Griddle   LP Gas   Specialty Finish*   Plated Trim*	\$ 23,085	\$ 26,550
RNB608GV2LCC	8 Burner   12" Griddle   LP Gas   Custom Color*   Standard Trim	\$ 21,990	\$ 25,290
RNB608GV2LCCPLT	8 Burner   12" Griddle   LP Gas   Custom Color*   Plated Trim*	\$ 24,485	\$ 28,160
<b>Customization &amp; Accessory Options: (See page 19)   Total Knobs: 11</b>			

**60" Nova (RNB) Series  
with 24" Griddle**

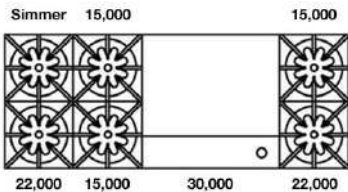

Model	Description (* Denotes item that must be specified)	UMRP	MSRP
<b>Natural Gas Models: 60" Nova Series with 24" Griddle</b>			
RNB606GV2	6 Burner   24" Griddle   Nat Gas   Stainless Steel   Standard Trim	\$ 18,695	\$ 21,500
RNB606GV2PLT	6 Burner   24" Griddle   Nat Gas   Stainless Steel   Plated Trim*	\$ 21,190	\$ 24,370
RNB606GV2C	6 Burner   24" Griddle   Nat Gas   Std RAL Paint*   Standard Trim	\$ 20,190	\$ 23,220
RNB606GV2CPLT	6 Burner   24" Griddle   Nat Gas   Std RAL Paint*   Plated Trim*	\$ 22,685	\$ 26,090
RNB606GV2CF	6 Burner   24" Griddle   Nat Gas   Specialty Finish*   Standard Trim	\$ 21,290	\$ 24,485
RNB606GV2CFPLT	6 Burner   24" Griddle   Nat Gas   Specialty Finish*   Plated Trim*	\$ 23,785	\$ 27,355
RNB606GV2CC	6 Burner   24" Griddle   Nat Gas   Custom Color*   Standard Trim	\$ 22,690	\$ 26,095
RNB606GV2CCPLT	6 Burner   24" Griddle   Nat Gas   Custom Color*   Plated Trim*	\$ 25,185	\$ 28,965
<b>LP/Propane Models: 60" Nova Series with 24" Griddle</b>			
RNB606GV2L	6 Burner   24" Griddle   LP Gas   Stainless Steel   Standard Trim	\$ 18,695	\$ 21,500
RNB606GV2LPLT	6 Burner   24" Griddle   LP Gas   Stainless Steel   Plated Trim*	\$ 21,190	\$ 24,370
RNB606GV2LC	6 Burner   24" Griddle   LP Gas   Std RAL Paint*   Standard Trim	\$ 20,190	\$ 23,220
RNB606GV2LCPLT	6 Burner   24" Griddle   LP Gas   Std RAL Paint*   Plated Trim*	\$ 22,685	\$ 26,090
RNB606GV2LCF	6 Burner   24" Griddle   LP Gas   Specialty Finish*   Standard Trim	\$ 21,290	\$ 24,485
RNB606GV2LCFPLT	6 Burner   24" Griddle   LP Gas   Specialty Finish*   Plated Trim*	\$ 23,785	\$ 27,355
RNB606GV2LCC	6 Burner   24" Griddle   LP Gas   Custom Color*   Standard Trim	\$ 22,690	\$ 26,095
RNB606GV2LCCPLT	6 Burner   24" Griddle   LP Gas   Custom Color*   Plated Trim*	\$ 25,185	\$ 28,965
<b>Customization &amp; Accessory Options: (See page 19)   Total Knobs: 10</b>			

## FREESTANDING RANGES: 60" NOVA (RNB) SERIES

**60" Nova (RNB) Series  
with 12" Griddle & Charbroiler**

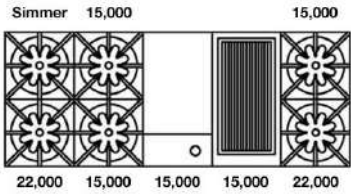

Model	Description (* Denotes item that must be specified)	UMRP	MSRP
<b>Natural Gas Models: 60" Nova Series with 12" Griddle &amp; Charbroiler</b>			
RNB606GCBV2	6 Burner   12" Griddle & Char Br.   Nat Gas   Stainless Steel   Standard Trim	\$ 18,895	\$ 21,730
RNB606GCBV2PLT	6 Burner   12" Griddle & Char Br.   Nat Gas   Stainless Steel   Plated Trim*	\$ 21,390	\$ 24,600
RNB606GCBV2C	6 Burner   12" Griddle & Char Br.   Nat Gas   Std RAL Paint*   Standard Trim	\$ 20,390	\$ 23,450
RNB606GCBV2CPLT	6 Burner   12" Griddle & Char Br.   Nat Gas   Std RAL Paint*   Plated Trim*	\$ 22,885	\$ 26,320
RNB606GCBV2CF	6 Burner   12" Griddle & Char Br.   Nat Gas   Specialty Finish*   Standard Trim	\$ 21,490	\$ 24,715
RNB606GCBV2CFPLT	6 Burner   12" Griddle & Char Br.   Nat Gas   Specialty Finish*   Plated Trim*	\$ 23,985	\$ 27,585
RNB606GCBV2CC	6 Burner   12" Griddle & Char Br.   Nat Gas   Custom Color*   Standard Trim	\$ 22,890	\$ 26,325
RNB606GCBV2CCPLT	6 Burner   12" Griddle & Char Br.   Nat Gas   Custom Color*   Plated Trim*	\$ 25,385	\$ 29,195
<b>LP/Propane Models: 60" Nova Series with 12" Griddle &amp; Charbroiler</b>			
RNB606GCBV2L	6 Burner   12" Griddle & Char Br.   LP Gas   Stainless Steel   Standard Trim	\$ 18,895	\$ 21,730
RNB606GCBV2LPLT	6 Burner   12" Griddle & Char Br.   LP Gas   Stainless Steel   Plated Trim*	\$ 21,390	\$ 24,600
RNB606GCBV2LC	6 Burner   12" Griddle & Char Br.   LP Gas   Std RAL Paint*   Standard Trim	\$ 20,390	\$ 23,450
RNB606GCBV2LCPLT	6 Burner   12" Griddle & Char Br.   LP Gas   Std RAL Paint*   Plated Trim*	\$ 22,885	\$ 26,320
RNB606GCBV2LCF	6 Burner   12" Griddle & Char Br.   LP Gas   Specialty Finish*   Standard Trim	\$ 21,490	\$ 24,715
RNB606GCBV2LCFPLT	6 Burner   12" Griddle & Char Br.   LP Gas   Specialty Finish*   Plated Trim*	\$ 23,985	\$ 27,585
RNB606GCBV2LCC	6 Burner   12" Griddle & Char Br.   LP Gas   Custom Color*   Standard Trim	\$ 22,890	\$ 26,325
RNB606GCBV2LCCPLT	6 Burner   12" Griddle & Char Br.   LP Gas   Custom Color*   Plated Trim*	\$ 25,385	\$ 29,195
<b>Customization &amp; Accessory Options: (See page 19)   Total Knobs: 10</b>			

**60" Nova (RNB) Series  
with 24" French Top**

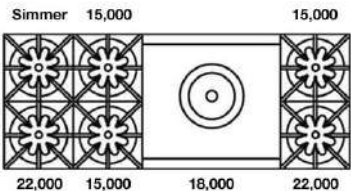

Model	Description (* Denotes item that must be specified)	UMRP	MSRP
<b>Natural Gas Models: 60" Nova Series with 24" French Top</b>			
RNB606FTV2	6 Burner   24" French Top   Nat Gas   Stainless Steel   Standard Trim	\$ 19,995	\$ 22,995
RNB606FTV2PLT	6 Burner   24" French Top   Nat Gas   Stainless Steel   Plated Trim*	\$ 22,490	\$ 25,865
RNB606FTV2C	6 Burner   24" French Top   Nat Gas   Std RAL Paint*   Standard Trim	\$ 21,490	\$ 24,715
RNB606FTV2CPLT	6 Burner   24" French Top   Nat Gas   Std RAL Paint*   Plated Trim*	\$ 23,985	\$ 27,585
RNB606FTV2CF	6 Burner   24" French Top   Nat Gas   Specialty Finish*   Standard Trim	\$ 22,590	\$ 25,980
RNB606FTV2CFPLT	6 Burner   24" French Top   Nat Gas   Specialty Finish*   Plated Trim*	\$ 25,085	\$ 28,850
RNB606FTV2CC	6 Burner   24" French Top   Nat Gas   Custom Color*   Standard Trim	\$ 23,990	\$ 27,590
RNB606FTV2CCPLT	6 Burner   24" French Top   Nat Gas   Custom Color*   Plated Trim*	\$ 26,485	\$ 30,460
<b>LP/Propane Models: 60" Nova Series with 24" French Top</b>			
RNB606FTV2L	6 Burner   24" French Top   LP Gas   Stainless Steel   Standard Trim	\$ 19,995	\$ 22,995
RNB606FTV2LPLT	6 Burner   24" French Top   LP Gas   Stainless Steel   Plated Trim*	\$ 22,490	\$ 25,865
RNB606FTV2LC	6 Burner   24" French Top   LP Gas   Std RAL Paint*   Standard Trim	\$ 21,490	\$ 24,715
RNB606FTV2LCPLT	6 Burner   24" French Top   LP Gas   Std RAL Paint*   Plated Trim*	\$ 23,985	\$ 27,585
RNB606FTV2LCF	6 Burner   24" French Top   LP Gas   Specialty Finish*   Standard Trim	\$ 22,590	\$ 25,980
RNB606FTV2LCFPLT	6 Burner   24" French Top   LP Gas   Specialty Finish*   Plated Trim*	\$ 25,085	\$ 28,850
RNB606FTV2LCC	6 Burner   24" French Top   LP Gas   Custom Color*   Standard Trim	\$ 23,990	\$ 27,590
RNB606FTV2LCCPLT	6 Burner   24" French Top   LP Gas   Custom Color*   Plated Trim*	\$ 26,485	\$ 30,460
<b>Customization &amp; Accessory Options: (See page 19)   Total Knobs: 9</b>			

## FREESTANDING RANGES: 48" NOVA (RNB) SERIES

### Model Number Color & Customization Guide:

(C) 190 Standard RAL (Semi-Gloss) Colors	(CF) Specialty Finish (190 Matte RAL, Precious Metals & Textures)	(CC) Custom Color Match	(PLT) Plated Trim
--	---	-------------------------	-------------------



Simmer    15,000    15,000    15,000



22,000    15,000    15,000    22,000

#### FEATURES:

- 22,000 BTU UltraNova™ burners & 15,000 BTU Nova™ burners
- Available with all burners or add integrated griddle, charbroiler or French top
- Extra-large convection oven with 1850° infrared broiler that accommodates a full size 18" x 26" commercial baking sheet
- Integrated wok cooking
- Available in 1,000+ colors & finishes plus additional customization options
- Handcrafted in Pennsylvania since 1880

#### PRODUCT SPECIFICATIONS:

- Unit Dimensions: 47.875"W x 24"D x 36.75"H
- Large Oven Intr: 26.438"W x 20"D x 15"H
- Small Oven Intr: 13.578"W x 20"D x 15"H
- Top Burner Power: 22,000 BTUs
- Simmer Burner: 9,000 BTUs
- Electrical Reqs: 120V, 60Hz, 15 AMPS, 1PH
- Gas Pressure: NAT: 5.0" WC, LP 10.0" WC
- Gas Line Size: ¾"
- Unit Weight: 645 lbs.

Model	Description (* Denotes item that must be specified)	UMRP	MSRP
<b>Natural Gas Models: 48" Nova (RNB) Series</b>			
RNB488BV2	8 Burner   Nat Gas   Stainless Steel   Standard Trim	\$ 11,495	\$ 13,220
RNB488BV2PLT	8 Burner   Nat Gas   Stainless Steel   Plated Trim*	\$ 13,690	\$ 15,745
RNB488BV2C	8 Burner   Nat Gas   Std RAL Color*   Standard Trim	\$ 12,990	\$ 14,940
RNB488BV2CPLT	8 Burner   Nat Gas   Std RAL Color*   Plated Trim*	\$ 15,185	\$ 17,465
RNB488BV2CF	8 Burner   Nat Gas   Specialty Finish*   Standard Trim	\$ 14,090	\$ 16,205
RNB488BV2CFPLT	8 Burner   Nat Gas   Specialty Finish*   Plated Trim*	\$ 16,285	\$ 18,730
RNB488BV2CC	8 Burner   Nat Gas   Custom Color*   Standard Trim	\$ 15,490	\$ 17,815
RNB488BV2CCPLT	8 Burner   Nat Gas   Custom Color*   Plated Trim*	\$ 17,685	\$ 20,340
<b>LP/Propane Models: 48" Nova (RNB) Series</b>			
RNB488BV2L	8 Burner   LP Gas   Stainless Steel   Standard Trim	\$ 11,495	\$ 13,220
RNB488BV2LPLT	8 Burner   LP Gas   Stainless Steel   Plated Trim*	\$ 13,690	\$ 15,745
RNB488BV2LC	8 Burner   LP Gas   Std RAL Color*   Standard Trim	\$ 12,990	\$ 14,940
RNB488BV2LCPLT	8 Burner   LP Gas   Std RAL Color*   Plated Trim*	\$ 15,185	\$ 17,465
RNB488BV2LCF	8 Burner   LP Gas   Specialty Finish*   Standard Trim	\$ 14,090	\$ 16,205
RNB488BV2LCFPLT	8 Burner   LP Gas   Specialty Finish*   Plated Trim*	\$ 16,285	\$ 18,730
RNB488BV2LCC	8 Burner   LP Gas   Custom Color*   Standard Trim	\$ 15,490	\$ 17,815
RNB488BV2LCCPLT	8 Burner   LP Gas   Custom Color*   Plated Trim*	\$ 17,685	\$ 20,340
<b>BACKGUARD OPTIONS:</b>			
<b>All BlueStar freestanding appliances must be installed with a UL approved backguard. All units ship standard with a UL approved Island Trim unless otherwise specified.</b>			
BG648BSP	6" Backguard	\$ 1,040	\$ 1,195
BG4817BSP	17" Backguard	\$ 2,180	\$ 2,505
SDHS48BSP	24" High Shelf	\$ 2,340	\$ 2,690
<b>KNOB &amp; PAINTED BODY SIDE OPTIONS: (Total Knobs: 10)</b>			
SIDES-C	Add Painted Sides (All colors)	\$ 765	\$ 880
KN-BLK	Standard Black Knob ( <i>Must be ordered with unit</i> )	N/C	N/C
KN-C	Knob: Standard 190 RAL Color	\$ 115 ea	\$ 130 ea
BZ-C	Bezel: Standard 190 RAL Color	\$ 70 ea	\$ 80 ea
KN-CF	Knob: Spec Finish (Matte RAL, Textured RAL or Prec Metals)	\$ 185 ea	\$ 215 ea
KN-PLT	Knob: Plated Trim (See options below)	\$ 250 ea	\$ 290 ea
<b>SWING DOOR OPTIONS:</b>			
SWING DOOR – LH	Swing Door – Left Hinge for Nova (RNB) Series	\$ 1,530	\$ 1,760
SWING DOOR – RH	Swing Door – Right Hinge for Nova (RNB) Series	\$ 1,530	\$ 1,760
<b>PLATED TRIM OPTIONS: (Includes bezels, door handle, handle ends and logo)</b>			
Antique Brass, Brushed Brass, Polished Brass, Antique Copper, Brushed Copper, Polished Copper, Chrome, Oil Rubbed Bronze & Pewter			
See page 40 for additional customization and accessories for Freestanding Ranges			

## FREESTANDING RANGES: 48" NOVA (RNB) SERIES

### 48" Nova (RNB) Series with 12" Griddle

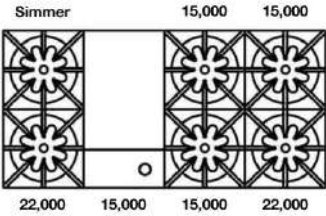

Model	Description (* Denotes item that must be specified)	UMRP	MSRP
<b>Natural Gas Models: 48" Nova (RNB) Series with 12" Griddle</b>			
RNB486GV2	6 Burner   12" Griddle   Nat Gas   Stainless Steel   Standard Trim	\$ 12,495	\$ 14,370
RNB486GV2PLT	6 Burner   12" Griddle   Nat Gas   Stainless Steel   Plated Trim*	\$ 14,690	\$ 16,895
RNB486GV2C	6 Burner   12" Griddle   Nat Gas   Std RAL Paint*   Standard Trim	\$ 13,990	\$ 16,090
RNB486GV2CPLT	6 Burner   12" Griddle   Nat Gas   Std RAL Paint*   Plated Trim*	\$ 16,185	\$ 18,615
RNB486GV2CF	6 Burner   12" Griddle   Nat Gas   Specialty Finish*   Standard Trim	\$ 15,090	\$ 17,355
RNB486GV2CFPLT	6 Burner   12" Griddle   Nat Gas   Specialty Finish*   Plated Trim*	\$ 17,285	\$ 19,880
RNB486GV2CC	6 Burner   12" Griddle   Nat Gas   Custom Color*   Standard Trim	\$ 16,490	\$ 18,965
RNB486GV2CCPLT	6 Burner   12" Griddle   Nat Gas   Custom Color*   Plated Trim*	\$ 18,685	\$ 21,490
<b>LP/Propane Models: 48" Nova (RNB) Series with 12" Griddle</b>			
RNB486GV2L	6 Burner   12" Griddle   LP Gas   Stainless Steel   Standard Trim	\$ 12,495	\$ 14,370
RNB486GV2LPLT	6 Burner   12" Griddle   LP Gas   Stainless Steel   Plated Trim*	\$ 14,690	\$ 16,895
RNB486GV2LC	6 Burner   12" Griddle   LP Gas   Std RAL Paint*   Standard Trim	\$ 13,990	\$ 16,090
RNB486GV2LCPLT	6 Burner   12" Griddle   LP Gas   Std RAL Paint*   Plated Trim*	\$ 16,185	\$ 18,615
RNB486GV2LCF	6 Burner   12" Griddle   LP Gas   Specialty Finish*   Standard Trim	\$ 15,090	\$ 17,355
RNB486GV2LCFPLT	6 Burner   12" Griddle   LP Gas   Specialty Finish*   Plated Trim*	\$ 17,285	\$ 19,880
RNB486GV2LCC	6 Burner   12" Griddle   LP Gas   Custom Color*   Standard Trim	\$ 16,490	\$ 18,965
RNB486GV2LCCPLT	6 Burner   12" Griddle   LP Gas   Custom Color*   Plated Trim*	\$ 18,685	\$ 21,490
<b>Customization &amp; Accessory Options: (See page 23)   Total Knobs: 9</b>			

### 48" Nova (RNB) Series with 12" Charbroiler

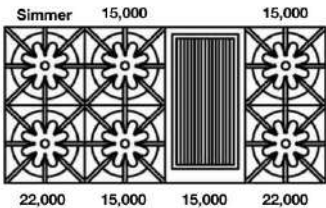

Model	Description (* Denotes item that must be specified)	UMRP	MSRP
<b>Natural Gas Models: 48" Nova (RNB) Series with 12" Charbroiler</b>			
RNB486CBV2	6 Burner   12" Charbroiler   Nat Gas   Stainless Steel   Standard Trim	\$ 12,495	\$ 14,370
RNB486CBV2PLT	6 Burner   12" Charbroiler   Nat Gas   Stainless Steel   Plated Trim*	\$ 14,690	\$ 16,895
RNB486CBV2C	6 Burner   12" Charbroiler   Nat Gas   Std RAL Paint*   Standard Trim	\$ 13,990	\$ 16,090
RNB486CBV2CPLT	6 Burner   12" Charbroiler   Nat Gas   Std RAL Paint*   Plated Trim*	\$ 16,185	\$ 18,615
RNB486CBV2CF	6 Burner   12" Charbroiler   Nat Gas   Specialty Finish*   Standard Trim	\$ 15,090	\$ 17,355
RNB486CBV2CFPLT	6 Burner   12" Charbroiler   Nat Gas   Specialty Finish*   Plated Trim*	\$ 17,285	\$ 19,880
RNB486CBV2CC	6 Burner   12" Charbroiler   Nat Gas   Custom Color*   Standard Trim	\$ 16,490	\$ 18,965
RNB486CBV2CCPLT	6 Burner   12" Charbroiler   Nat Gas   Custom Color*   Plated Trim*	\$ 18,685	\$ 21,490
<b>LP/Propane Models: 48" Nova (RNB) Series with 12" Charbroiler</b>			
RNB486CBV2L	6 Burner   12" Charbroiler   LP Gas   Stainless Steel   Standard Trim	\$ 12,495	\$ 14,370
RNB486CBV2LPLT	6 Burner   12" Charbroiler   LP Gas   Stainless Steel   Plated Trim*	\$ 14,690	\$ 16,895
RNB486CBV2LC	6 Burner   12" Charbroiler   LP Gas   Std RAL Paint*   Standard Trim	\$ 13,990	\$ 16,090
RNB486CBV2LCPLT	6 Burner   12" Charbroiler   LP Gas   Std RAL Paint*   Plated Trim*	\$ 16,185	\$ 18,615
RNB486CBV2LCF	6 Burner   12" Charbroiler   LP Gas   Specialty Finish*   Standard Trim	\$ 15,090	\$ 17,355
RNB486CBV2LCFPLT	6 Burner   12" Charbroiler   LP Gas   Specialty Finish*   Plated Trim*	\$ 17,285	\$ 19,880
RNB486CBV2LCC	6 Burner   12" Charbroiler   LP Gas   Custom Color*   Standard Trim	\$ 16,490	\$ 18,965
RNB486CBV2LCCPLT	6 Burner   12" Charbroiler   LP Gas   Custom Color*   Plated Trim*	\$ 18,685	\$ 21,490
<b>Customization &amp; Accessory Options: (See page 23)   Total Knobs: 9</b>			

## FREESTANDING RANGES: 48" NOVA (RNB) SERIES

### 48" Nova (RNB) Series with 24" Griddle

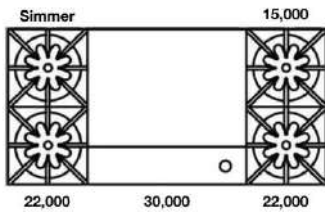

Model	Description (* Denotes item that must be specified)	UMRP	MSRP
<b>Natural Gas Models: 48" Nova (RNB) Series with 24" Griddle</b>			
RNB484GV2	4 Burner   24" Griddle   Nat Gas   Stainless Steel   Standard Trim	\$ 13,395	\$ 15,405
RNB484GV2PLT	4 Burner   24" Griddle   Nat Gas   Stainless Steel   Plated Trim*	\$ 15,590	\$ 17,930
RNB484GV2C	4 Burner   24" Griddle   Nat Gas   Std RAL Paint*   Standard Trim	\$ 14,890	\$ 17,125
RNB484GV2CPLT	4 Burner   24" Griddle   Nat Gas   Std RAL Paint*   Plated Trim*	\$ 17,085	\$ 19,650
RNB484GV2CF	4 Burner   24" Griddle   Nat Gas   Specialty Finish*   Standard Trim	\$ 15,990	\$ 18,390
RNB484GV2CFPLT	4 Burner   24" Griddle   Nat Gas   Specialty Finish*   Plated Trim*	\$ 18,185	\$ 20,915
RNB484GV2CC	4 Burner   24" Griddle   Nat Gas   Custom Color*   Standard Trim	\$ 17,390	\$ 20,000
RNB484GV2CCPLT	4 Burner   24" Griddle   Nat Gas   Custom Color*   Plated Trim*	\$ 19,585	\$ 22,525
<b>LP/Propane Models: 48" Nova (RNB) Series with 24" Griddle</b>			
RNB484GV2L	4 Burner   24" Griddle   LP Gas   Stainless Steel   Standard Trim	\$ 13,395	\$ 15,405
RNB484GV2LPLT	4 Burner   24" Griddle   LP Gas   Stainless Steel   Plated Trim*	\$ 15,590	\$ 17,930
RNB484GV2LC	4 Burner   24" Griddle   LP Gas   Std RAL Paint*   Standard Trim	\$ 14,890	\$ 17,125
RNB484GV2LCPLT	4 Burner   24" Griddle   LP Gas   Std RAL Paint*   Plated Trim*	\$ 17,085	\$ 19,650
RNB484GV2LCF	4 Burner   24" Griddle   LP Gas   Specialty Finish*   Standard Trim	\$ 15,990	\$ 18,390
RNB484GV2LCFPLT	4 Burner   24" Griddle   LP Gas   Specialty Finish*   Plated Trim*	\$ 18,185	\$ 20,915
RNB484GV2LCC	4 Burner   24" Griddle   LP Gas   Custom Color*   Standard Trim	\$ 17,390	\$ 20,000
RNB484GV2LCCPLT	4 Burner   24" Griddle   LP Gas   Custom Color*   Plated Trim*	\$ 19,585	\$ 22,525
<b>Customization &amp; Accessory Options: (See page 23)   Total Knobs: 8</b>			

### 48" Nova (RNB) Series with 24" Charbroiler

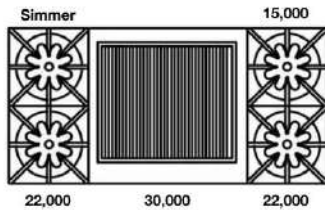

<b>Natural Gas Models: 48" Nova (RNB) Series with 24" Charbroiler</b>			
RNB484CBV2	4 Burner   24" Charbroiler   Nat Gas   Stainless Steel   Standard Trim	\$ 13,395	\$ 15,405
RNB484CBV2PLT	4 Burner   24" Charbroiler   Nat Gas   Stainless Steel   Plated Trim*	\$ 15,590	\$ 17,930
RNB484CBV2C	4 Burner   24" Charbroiler   Nat Gas   Std RAL Paint*   Standard Trim	\$ 14,890	\$ 17,125
RNB484CBV2CPLT	4 Burner   24" Charbroiler   Nat Gas   Std RAL Paint*   Plated Trim*	\$ 17,085	\$ 19,650
RNB484CBV2CF	4 Burner   24" Charbroiler   Nat Gas   Specialty Finish*   Standard Trim	\$ 15,990	\$ 18,390
RNB484CBV2CFPLT	4 Burner   24" Charbroiler   Nat Gas   Specialty Finish*   Plated Trim*	\$ 18,185	\$ 20,915
RNB484CBV2CC	4 Burner   24" Charbroiler   Nat Gas   Custom Color*   Standard Trim	\$ 17,390	\$ 20,000
RNB484CBV2CCPLT	4 Burner   24" Charbroiler   Nat Gas   Custom Color*   Plated Trim*	\$ 19,585	\$ 22,525
<b>LP/Propane Models: 48" Nova (RNB) Series with 12" Charbroiler</b>			
RNB484CBV2L	4 Burner   24" Charbroiler   LP Gas   Stainless Steel   Standard Trim	\$ 13,395	\$ 15,405
RNB484CBV2LPLT	4 Burner   24" Charbroiler   LP Gas   Stainless Steel   Plated Trim*	\$ 15,590	\$ 17,930
RNB484CBV2LC	4 Burner   24" Charbroiler   LP Gas   Std RAL Paint*   Standard Trim	\$ 14,890	\$ 17,125
RNB484CBV2LCPLT	4 Burner   24" Charbroiler   LP Gas   Std RAL Paint*   Plated Trim*	\$ 17,085	\$ 19,650
RNB484CBV2LCF	4 Burner   24" Charbroiler   LP Gas   Specialty Finish*   Standard Trim	\$ 15,990	\$ 18,390
RNB484CBV2LCFPLT	4 Burner   24" Charbroiler   LP Gas   Specialty Finish*   Plated Trim*	\$ 18,185	\$ 20,915
RNB484CBV2LCC	4 Burner   24" Charbroiler   LP Gas   Custom Color*   Standard Trim	\$ 17,390	\$ 20,000
RNB484CBV2LCCPLT	4 Burner   24" Charbroiler   LP Gas   Custom Color*   Plated Trim*	\$ 19,585	\$ 22,525
<b>Customization &amp; Accessory Options: (See page 23)   Total Knobs: 8</b>			

## FREESTANDING RANGES: 48" NOVA (RNB) SERIES

**48" Nova (RNB) Series  
with 12" Griddle & Charbroiler**

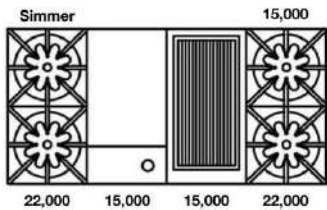

Model	Description (* Denotes item that must be specified)	UMRP	MSRP
<b>Natural Gas Models: 48" Nova (RNB) Series with 12" Griddle &amp; Charbroiler</b>			
RNB484GCBV2	4 Burner   12" Griddle & Char Br.   Nat Gas   Stainless Steel   Standard Trim	\$ 13,995	\$ 16,095
RNB484GCBV2PLT	4 Burner   12" Griddle & Char Br.   Nat Gas   Stainless Steel   Plated Trim*	\$ 16,190	\$ 18,620
RNB484GCBV2C	4 Burner   12" Griddle & Char Br.   Nat Gas   Std RAL Paint*   Standard Trim	\$ 15,490	\$ 17,815
RNB484GCBV2CPLT	4 Burner   12" Griddle & Char Br.   Nat Gas   Std RAL Paint*   Plated Trim*	\$ 17,685	\$ 20,340
RNB484GCBV2CF	4 Burner   12" Griddle & Char Br.   Nat Gas   Specialty Finish*   Standard Trim	\$ 16,590	\$ 19,080
RNB484GCBV2CFPLT	4 Burner   12" Griddle & Char Br.   Nat Gas   Specialty Finish*   Plated Trim*	\$ 18,785	\$ 21,605
RNB484GCBV2CC	4 Burner   12" Griddle & Char Br.   Nat Gas   Custom Color*   Standard Trim	\$ 17,990	\$ 20,690
RNB484GCBV2CCPLT	4 Burner   12" Griddle & Char Br.   Nat Gas   Custom Color*   Plated Trim*	\$ 20,185	\$ 23,215
<b>LP/Propane Models: 48" Nova (RNB) Series with 12" Griddle &amp; Charbroiler</b>			
RNB484GCBV2L	4 Burner   12" Griddle & Char Br   LP Gas   Stainless Steel   Standard Trim	\$ 13,995	\$ 16,095
RNB484GCBV2LPLT	4 Burner   12" Griddle & Char Br   LP Gas   Stainless Steel   Plated Trim*	\$ 16,190	\$ 18,620
RNB484GCBV2LC	4 Burner   12" Griddle & Char Br   LP Gas   Std RAL Paint*   Standard Trim	\$ 15,490	\$ 17,815
RNB484GCBV2LCPLT	4 Burner   12" Griddle & Char Br   LP Gas   Std RAL Paint*   Plated Trim*	\$ 17,685	\$ 20,340
RNB484GCBV2LCF	4 Burner   12" Griddle & Char Br   LP Gas   Specialty Finish*   Standard Trim	\$ 16,590	\$ 19,080
RNB484GCBV2LCFPLT	4 Burner   12" Griddle & Char Br   LP Gas   Specialty Finish*   Plated Trim*	\$ 18,785	\$ 21,605
RNB484GCBV2LCC	4 Burner   12" Griddle & Char Br   LP Gas   Custom Color*   Standard Trim	\$ 17,990	\$ 20,690
RNB484GCBV2LCCPLT	4 Burner   12" Griddle & Char Br   LP Gas   Custom Color*   Plated Trim*	\$ 20,185	\$ 23,215
<b>Customization &amp; Accessory Options: (See page 23)   Total Knobs: 8</b>			

**48" Nova (RNB) Series  
with 24" French Top**

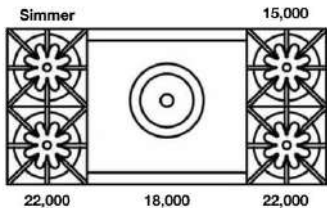

Model	Description (* Denotes item that must be specified)	UMRP	MSRP
<b>Natural Gas Models: 48" Nova (RNB) Series with 24" French Top</b>			
RNB484FTBV2	4 Burner   24" French Top   Nat Gas   Stainless Steel   Standard Trim	\$ 14,295	\$ 16,440
RNB484FTBV2PLT	4 Burner   24" French Top   Nat Gas   Stainless Steel   Plated Trim*	\$ 16,490	\$ 18,965
RNB484FTBV2C	4 Burner   24" French Top   Nat Gas   Std RAL Paint*   Standard Trim	\$ 15,790	\$ 18,160
RNB484FTBV2CPLT	4 Burner   24" French Top   Nat Gas   Std RAL Paint*   Plated Trim*	\$ 17,985	\$ 20,685
RNB484FTBV2CF	4 Burner   24" French Top   Nat Gas   Specialty Finish*   Standard Trim	\$ 16,890	\$ 19,425
RNB484FTBV2CFPLT	4 Burner   24" French Top   Nat Gas   Specialty Finish*   Plated Trim*	\$ 19,085	\$ 21,950
RNB484FTBV2CC	4 Burner   24" French Top   Nat Gas   Custom Color*   Standard Trim	\$ 18,290	\$ 21,035
RNB484FTBV2CCPLT	4 Burner   24" French Top   Nat Gas   Custom Color*   Plated Trim*	\$ 20,485	\$ 23,560
<b>LP/Propane Models: 48" Nova (RNB) Series with 24" French Top</b>			
RNB484FTBV2L	4 Burner   24" French Top   LP Gas   Stainless Steel   Standard Trim	\$ 14,295	\$ 16,440
RNB484FTBV2LPLT	4 Burner   24" French Top   LP Gas   Stainless Steel   Plated Trim*	\$ 16,490	\$ 18,965
RNB484FTBV2LC	4 Burner   24" French Top   LP Gas   Std RAL Paint*   Standard Trim	\$ 15,790	\$ 18,160
RNB484FTBV2LCPLT	4 Burner   24" French Top   LP Gas   Std RAL Paint*   Plated Trim*	\$ 17,985	\$ 20,685
RNB484FTBV2LCF	4 Burner   24" French Top   LP Gas   Specialty Finish*   Standard Trim	\$ 16,890	\$ 19,425
RNB484FTBV2LCFPLT	4 Burner   24" French Top   LP Gas   Specialty Finish*   Plated Trim*	\$ 19,085	\$ 21,950
RNB484FTBV2LCC	4 Burner   24" French Top   LP Gas   Custom Color*   Standard Trim	\$ 18,290	\$ 21,035
RNB484FTBV2LCCPLT	4 Burner   24" French Top   LP Gas   Custom Color*   Plated Trim*	\$ 20,485	\$ 23,560
<b>Customization &amp; Accessory Options: (See page 23)   Total Knobs: 7</b>			

## FREESTANDING RANGES: 36" NOVA (RNB) SERIES

### Model Number Color & Customization Guide:

(C) 190 Standard RAL (Semi-Gloss) Colors	(CF) Specialty Finish (190 Matte RAL, Precious Metals & Textures)	(CC) Custom Color Match	(PLT) Plated Trim
--	---	-------------------------	-------------------

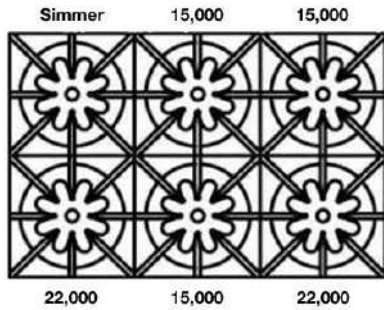

#### FEATURES:

- 22,000 BTU UltraNova™ burners & 15,000 BTU Nova™ burners
- Precise 130° simmer burner
- Available with all burners or add integrated griddle, charbroiler or French top
- Extra-large convection oven with 1850° infrared broiler that accommodates a full size 18" x 26" commercial baking sheet
- Includes full extension rack
- Integrated wok cooking
- Available with swing doors
- Available in 1,000+ colors & finishes plus additional customization options
- Handcrafted in Pennsylvania since 1880

#### PRODUCT SPECIFICATIONS:

- Unit Dimensions: 35.875"W x 24"D x 36.75"H
- Oven Interior: 29.25"W x 20"D x 15"H
- Top Burner Power: 22,000 BTUs
- Simmer Burner: 9,000 BTUs
- Electrical Reqs: 120V, 60Hz, 15 AMPS, 1PH
- Gas Pressure: NAT: 5.0" WC, LP 10.0" WC
- Gas Line Size: ½
- Unit Weight: 470 lbs.

Model	Description (* Denotes item that must be specified)	UMRP	MSRP
<b>Natural Gas Models: 36" Nova (RNB) Series</b>			
RNB366BV2	6 Burner   Nat Gas   Stainless Steel   Standard Trim	\$ 7,495	\$ 8,620
RNB366BV2PLT	6 Burner   Nat Gas   Stainless Steel   Plated Trim*	\$ 9,390	\$ 10,800
RNB366BV2C	6 Burner   Nat Gas   Std RAL Color*   Standard Trim	\$ 8,690	\$ 9,995
RNB366BV2CPLT	6 Burner   Nat Gas   Std RAL Color*   Plated Trim*	\$ 10,585	\$ 12,175
RNB366BV2CF	6 Burner   Nat Gas   Specialty Finish*   Standard Trim	\$ 9,690	\$ 11,145
RNB366BV2CFPLT	6 Burner   Nat Gas   Specialty Finish*   Plated Trim*	\$ 11,585	\$ 13,325
RNB366BV2CC	6 Burner   Nat Gas   Custom Color*   Standard Trim	\$ 11,190	\$ 12,870
RNB366BV2CCPLT	6 Burner   Nat Gas   Custom Color*   Plated Trim*	\$ 13,085	\$ 15,050
<b>LP/Propane Models: 36" Nova (RNB) Series</b>			
RNB366BV2L	6 Burner   LP Gas   Stainless Steel   Standard Trim	\$ 7,495	\$ 8,620
RNB366BV2LPLT	6 Burner   LP Gas   Stainless Steel   Plated Trim*	\$ 9,390	\$ 10,800
RNB366BV2LC	6 Burner   LP Gas   Std RAL Color*   Standard Trim	\$ 8,690	\$ 9,995
RNB366BV2LCPLT	6 Burner   LP Gas   Std RAL Color*   Plated Trim*	\$ 10,585	\$ 12,175
RNB366BV2LCF	6 Burner   LP Gas   Specialty Finish*   Standard Trim	\$ 9,690	\$ 11,145
RNB366BV2LCFPLT	6 Burner   LP Gas   Specialty Finish*   Plated Trim*	\$ 11,585	\$ 13,325
RNB366BV2LCC	6 Burner   LP Gas   Custom Color*   Standard Trim	\$ 11,190	\$ 12,870
RNB366BV2LCCPLT	6 Burner   LP Gas   Custom Color*   Plated Trim*	\$ 13,085	\$ 15,050
<b>BACKGUARD OPTIONS:</b>			
<b>All BlueStar freestanding appliances must be installed with a UL approved backguard. All units ship standard with a UL approved Island Trim unless otherwise specified.</b>			
BG636BSP	6" Backguard	\$ 720	\$ 830
BG3617BSP	17" Backguard	\$ 1,430	\$ 1,680
SDHS36BSP	24" High Shelf	\$ 1,690	\$ 1,945
<b>KNOB &amp; PAINTED BODY SIDE OPTIONS: (Total Knobs: 7)</b>			
SIDES-C	Add Painted Sides (All colors)	\$ 765	\$ 880
KN-BLK	Standard Black Knob (Must be ordered with unit)	N/C	N/C
KN-C	Knob: Standard 190 RAL Color	\$ 115 ea	\$ 130 ea
BZ-C	Bezel: Standard 190 RAL Color	\$ 70 ea	\$ 80 ea
KN-CF	Knob: Spec Finish (Matte RAL, Textured RAL or Prec Metals)	\$ 185 ea	\$ 215 ea
KN-PLT	Knob: Plated Trim (See options below)	\$ 250 ea	\$ 290 ea
<b>SWING DOOR OPTIONS:</b>			
SWING DOOR – LH	Swing Door – Left Hinge for Nova (RNB) Series	\$ 1,530	\$ 1,760
SWING DOOR – RH	Swing Door – Right Hinge for Nova (RNB) Series	\$ 1,530	\$ 1,760
<b>PLATED TRIM OPTIONS: (Includes bezels, door handle, handle ends and logo)</b>			
Antique Brass, Brushed Brass, Polished Brass, Antique Copper, Brushed Copper, Polished Copper, Chrome, Oil Rubbed Bronze & Pewter			
See page 40 for additional customization and accessories for Freestanding Ranges			

## FREESTANDING RANGES: 36" NOVA (RNB) SERIES

**36" Nova (RNB) Series  
with 12" Griddle**

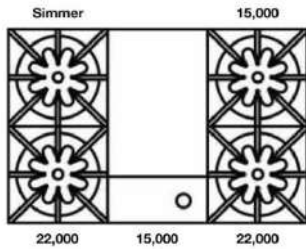

Model	Description (* Denotes item that must be specified)	UMRP	MSRP
<b>Natural Gas Models: 36" Nova (RNB) Series with 12" Griddle</b>			
RNB364GV2	4 Burner   12" Griddle   Nat Gas   Stainless Steel   Standard Trim	\$ 8,495	\$ 9,770
RNB364GV2PLT	4 Burner   12" Griddle   Nat Gas   Stainless Steel   Plated Trim*	\$ 10,390	\$ 11,950
RNB364GV2C	4 Burner   12" Griddle   Nat Gas   Std RAL Paint*   Standard Trim	\$ 9,690	\$ 11,145
RNB364GV2CPLT	4 Burner   12" Griddle   Nat Gas   Std RAL Paint*   Plated Trim*	\$ 11,585	\$ 13,325
RNB364GV2CF	4 Burner   12" Griddle   Nat Gas   Specialty Finish*   Standard Trim	\$ 10,690	\$ 12,295
RNB364GV2CFPLT	4 Burner   12" Griddle   Nat Gas   Specialty Finish*   Plated Trim*	\$ 12,585	\$ 14,475
RNB364GV2CC	4 Burner   12" Griddle   Nat Gas   Custom Color*   Standard Trim	\$ 12,190	\$ 14,020
RNB364GV2CCPLT	4 Burner   12" Griddle   Nat Gas   Custom Color*   Plated Trim*	\$ 14,085	\$ 16,200
<b>LP/Propane Models: 36" Nova (RNB) Series with 12" Griddle</b>			
RNB364GV2L	4 Burner   12" Griddle   LP Gas   Stainless Steel   Standard Trim	\$ 8,495	\$ 9,770
RNB364GV2LPLT	4 Burner   12" Griddle   LP Gas   Stainless Steel   Plated Trim*	\$ 10,390	\$ 11,950
RNB364GV2LC	4 Burner   12" Griddle   LP Gas   Std RAL Paint*   Standard Trim	\$ 9,690	\$ 11,145
RNB364GV2LCPLT	4 Burner   12" Griddle   LP Gas   Std RAL Paint*   Plated Trim*	\$ 11,585	\$ 13,325
RNB364GV2LCF	4 Burner   12" Griddle   LP Gas   Specialty Finish*   Standard Trim	\$ 10,690	\$ 12,295
RNB364GV2LCFPLT	4 Burner   12" Griddle   LP Gas   Specialty Finish*   Plated Trim*	\$ 12,585	\$ 14,475
RNB364GV2LCC	4 Burner   12" Griddle   LP Gas   Custom Color*   Standard Trim	\$ 12,190	\$ 14,020
RNB364GV2LCCPLT	4 Burner   12" Griddle   LP Gas   Custom Color*   Plated Trim*	\$ 14,085	\$ 16,200
<b>Customization &amp; Accessory Options: (See page 27)   Total Knobs: 6</b>			

**36" Nova (RNB) Series  
with 12" Charbroiler**

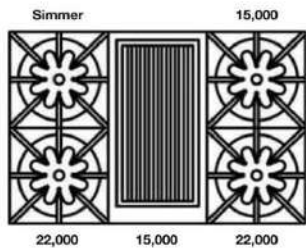

Model	Description (* Denotes item that must be specified)	UMRP	MSRP
<b>Natural Gas Models: 36" Nova (RNB) Series with 12" Charbroiler</b>			
RNB364CBV2	4 Burner   12" Charbroiler   Nat Gas   Stainless Steel   Standard Trim	\$ 8,495	\$ 9,770
RNB364CBV2PLT	4 Burner   12" Charbroiler   Nat Gas   Stainless Steel   Plated Trim*	\$ 10,390	\$ 11,950
RNB364CBV2C	4 Burner   12" Charbroiler   Nat Gas   Std RAL Paint*   Standard Trim	\$ 9,690	\$ 11,145
RNB364CBV2CPLT	4 Burner   12" Charbroiler   Nat Gas   Std RAL Paint*   Plated Trim*	\$ 11,585	\$ 13,325
RNB364CBV2CF	4 Burner   12" Charbroiler   Nat Gas   Specialty Finish*   Standard Trim	\$ 10,690	\$ 12,295
RNB364CBV2CFPLT	4 Burner   12" Charbroiler   Nat Gas   Specialty Finish*   Plated Trim*	\$ 12,585	\$ 14,475
RNB364CBV2CC	4 Burner   12" Charbroiler   Nat Gas   Custom Color*   Standard Trim	\$ 12,190	\$ 14,020
RNB364CBV2CCPLT	4 Burner   12" Charbroiler   Nat Gas   Custom Color*   Plated Trim*	\$ 14,085	\$ 16,200
<b>LP/Propane Models: 36" Nova (RNB) Series with 12" Charbroiler</b>			
RNB364CBV2L	4 Burner   12" Charbroiler   LP Gas   Stainless Steel   Standard Trim	\$ 8,495	\$ 9,770
RNB364CBV2LPLT	4 Burner   12" Charbroiler   LP Gas   Stainless Steel   Plated Trim*	\$ 10,390	\$ 11,950
RNB364CBV2LC	4 Burner   12" Charbroiler   LP Gas   Std RAL Paint*   Standard Trim	\$ 9,690	\$ 11,145
RNB364CBV2LCPLT	4 Burner   12" Charbroiler   LP Gas   Std RAL Paint*   Plated Trim*	\$ 11,585	\$ 13,325
RNB364CBV2LCF	4 Burner   12" Charbroiler   LP Gas   Specialty Finish*   Standard Trim	\$ 10,690	\$ 12,295
RNB364CBV2LCFPLT	4 Burner   12" Charbroiler   LP Gas   Specialty Finish*   Plated Trim*	\$ 12,585	\$ 14,475
RNB364CBV2LCC	4 Burner   12" Charbroiler   LP Gas   Custom Color*   Standard Trim	\$ 12,190	\$ 14,020
RNB364CBV2LCCPLT	4 Burner   12" Charbroiler   LP Gas   Custom Color*   Plated Trim*	\$ 14,085	\$ 16,200
<b>Customization &amp; Accessory Options: (See page 27)   Total Knobs: 6</b>			

## FREESTANDING RANGES: 30" NOVA (RNB) SERIES

### Model Number Color & Customization Guide:

(C) 190 Standard RAL (Semi-Gloss) Colors	(CF) Specialty Finish (190 Matte RAL, Precious Metals & Textures)	(CC) Custom Color Match	(PLT) Plated Trim
--	---	-------------------------	-------------------

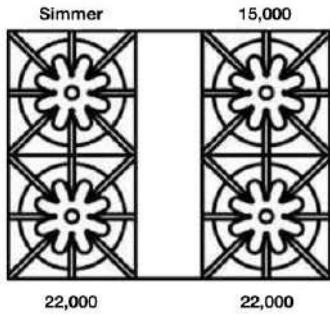

#### FEATURES:

- 22,000 BTU UltraNova™ burners & 15,000 BTU Nova™ burners
- Precise 130° simmer burner
- Extra-large convection oven with 1850° infrared broiler that accommodates a full size 18" x 26" commercial baking sheet
- Includes full extension rack
- Integrated wok cooking
- Available with swing doors
- Available in 1,000+ colors & finishes plus additional customization options
- Handcrafted in Pennsylvania since 1880

#### PRODUCT SPECIFICATIONS:

- Unit Dimensions: 29.875W x 24"D x 36.75"H
- Oven Interior: 26.438"W x 20"D x 15"H
- Top Burner Power: 22,000 BTUs
- Simmer Burner: 9,000 BTUs
- Electrical Reqs: 120V, 60Hz, 15 AMPS, 1PH
- Gas Pressure: NAT: 5.0" WC, LP 10.0" WC
- Gas Line Size: ½
- Unit Weight: 420 lbs.

Model	Description (* Denotes item that must be specified)	UMRP	MSRP
<b>Natural Gas Models: 30" Nova (RNB) Series</b>			
RNB304BV2	4 Burner   Nat Gas   Stainless Steel   Standard Trim	\$ 5,795	\$ 6,665
RNB304BV2PLT	4 Burner   Nat Gas   Stainless Steel   Plated Trim*	\$ 7,390	\$ 8,500
RNB304BV2C	4 Burner   Nat Gas   Std RAL Color*   Standard Trim	\$ 6,990	\$ 8,040
RNB304BV2CPLT	4 Burner   Nat Gas   Std RAL Color*   Plated Trim*	\$ 8,585	\$ 9,875
RNB304BV2CF	4 Burner   Nat Gas   Specialty Finish*   Standard Trim	\$ 7,990	\$ 9,190
RNB304BV2CFPLT	4 Burner   Nat Gas   Specialty Finish*   Plated Trim*	\$ 9,585	\$ 11,025
RNB304BV2CC	4 Burner   Nat Gas   Custom Color*   Standard Trim	\$ 9,490	\$ 10,915
RNB304BV2CCPLT	4 Burner   Nat Gas   Custom Color*   Plated Trim*	\$ 11,085	\$ 12,750
<b>LP/Propane Models: 30" Nova (RNB) Series</b>			
RNB304BV2L	4 Burner   LP Gas   Stainless Steel   Standard Trim	\$ 5,795	\$ 6,665
RNB304BV2LPLT	4 Burner   LP Gas   Stainless Steel   Plated Trim*	\$ 7,390	\$ 8,500
RNB304BV2LC	4 Burner   LP Gas   Std RAL Color*   Standard Trim	\$ 6,990	\$ 8,040
RNB304BV2LCPLT	4 Burner   LP Gas   Std RAL Color*   Plated Trim*	\$ 8,585	\$ 9,875
RNB304BV2LDCF	4 Burner   LP Gas   Specialty Finish*   Standard Trim	\$ 7,990	\$ 9,190
RNB304BV2LDCFPLT	4 Burner   LP Gas   Specialty Finish*   Plated Trim*	\$ 9,585	\$ 11,025
RNB304BV2LCC	4 Burner   LP Gas   Custom Color*   Standard Trim	\$ 9,490	\$ 10,915
RNB304BV2LCCPLT	4 Burner   LP Gas   Custom Color*   Plated Trim*	\$ 11,085	\$ 12,750
<b>BACKGUARD OPTIONS:</b>			
<b>All BlueStar freestanding appliances must be installed with a UL approved backguard. All units ship standard with a UL approved Island Trim unless otherwise specified.</b>			
BG630BSP	6" Backguard	\$ 605	\$ 695
BG3017BSP	17" Backguard	\$ 1,120	\$ 1,290
SDHS30BSP	24" High Shelf	\$ 1,460	\$ 1,680
<b>KNOB &amp; PAINTED BODY SIDE OPTIONS: (Total Knobs: 5)</b>			
SIDES-C	Add Painted Sides (All colors)	\$ 765	\$ 880
KN-BLK	Standard Black Knob (Must be ordered with unit)	N/C	N/C
KN-C	Knob: Standard 190 RAL Color	\$ 115 ea	\$ 130 ea
BZ-C	Bezel: Standard 190 RAL Color	\$ 70 ea	\$ 80 ea
KN-CF	Knob: Spec Finish (Matte RAL, Textured RAL or Prec Metals)	\$ 185 ea	\$ 215 ea
KN-PLT	Knob: Plated Trim (See options below)	\$ 250 ea	\$ 290 ea
<b>SWING DOOR OPTIONS:</b>			
SWING DOOR – LH	Swing Door – Left Hinge for Nova (RNB) Series	\$ 1,530	\$ 1,760
SWING DOOR – RH	Swing Door – Right Hinge for Nova (RNB) Series	\$ 1,530	\$ 1,760
<b>PLATED TRIM OPTIONS: (Includes bezels, door handle, handle ends and logo)</b>			
Antique Brass, Brushed Brass, Polished Brass, Antique Copper, Brushed Copper, Polished Copper, Chrome, Oil Rubbed Bronze & Pewter			
See page 40 for additional customization and accessories for Freestanding Ranges			

## FREESTANDING RANGES: 24" NOVA (RNB) SERIES

### Model Number Color & Customization Guide:

(C) 190 Standard RAL (Semi-Gloss) Colors	(CF) Specialty Finish (190 Matte RAL, Precious Metals & Textures)	(CC) Custom Color Match	(PLT) Plated Trim
--	---	-------------------------	-------------------

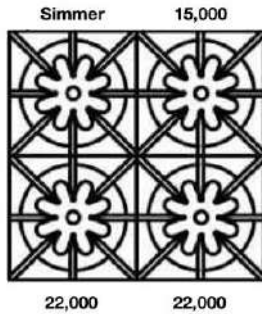

#### FEATURES:

- 22,000 BTU UltraNova™ burners & 15,000 BTU Nova™ burners
- Precise 130° simmer burner
- Available with all burners or all integrated griddle, charbroiler or French top
- Extra-large convection oven with 1850° infrared broiler that accommodates a half size 18" x 13" commercial baking sheet
- Includes full extension rack
- Integrated wok cooking
- Available with swing doors
- Available in 1,000+ colors & finishes plus additional customization options
- Handcrafted in Pennsylvania since 1880

#### PRODUCT SPECIFICATIONS:

- Unit Dimensions: 23.875"W x 24"D x 36.75"H
- Oven Interior: 20.25"W x 20"D x 15"H
- Top Burner Power: 22,000 BTUs
- Simmer Burner: 9,000 BTUs
- Electrical Reqs: 120V, 60Hz, 15 AMPS, 1PH
- Gas Pressure: NAT: 5.0" WC, LP 10.0" WC
- Gas Line Size: ½
- Unit Weight: 365 lbs.

Model	Description (* Denotes item that must be specified)	UMRP	MSRP
<b>Natural Gas Models: 24" Nova (RNB) Series</b>			
RNB244BV2	4 Burner   Nat Gas   Stainless Steel   Standard Trim	\$ 5,495	\$ 6,320
RNB244BV2PLT	4 Burner   Nat Gas   Stainless Steel   Plated Trim*	\$ 7,090	\$ 8,155
RNB244BV2C	4 Burner   Nat Gas   Std RAL Color*   Standard Trim	\$ 6,690	\$ 7,695
RNB244BV2CPLT	4 Burner   Nat Gas   Std RAL Color*   Plated Trim*	\$ 8,285	\$ 9,530
RNB244BV2CF	4 Burner   Nat Gas   Specialty Finish*   Standard Trim	\$ 7,690	\$ 8,845
RNB244BV2CFPLT	4 Burner   Nat Gas   Specialty Finish*   Plated Trim*	\$ 9,285	\$ 10,680
RNB244BV2CC	4 Burner   Nat Gas   Custom Color*   Standard Trim	\$ 9,190	\$ 10,570
RNB244BV2CCPLT	4 Burner   Nat Gas   Custom Color*   Plated Trim*	\$ 10,785	\$ 12,405
<b>LP/Propane Models: 24" Nova (RNB) Series</b>			
RNB244BV2L	4 Burner   LP Gas   Stainless Steel   Standard Trim	\$ 5,495	\$ 6,320
RNB244BV2LPLT	4 Burner   LP Gas   Stainless Steel   Plated Trim*	\$ 7,090	\$ 8,155
RNB244BV2LC	4 Burner   LP Gas   Std RAL Color*   Standard Trim	\$ 6,690	\$ 7,695
RNB244BV2LCPLT	4 Burner   LP Gas   Std RAL Color*   Plated Trim*	\$ 8,285	\$ 9,530
RNB244BV2LCF	4 Burner   LP Gas   Specialty Finish*   Standard Trim	\$ 7,690	\$ 8,845
RNB244BV2LCFPLT	4 Burner   LP Gas   Specialty Finish*   Plated Trim*	\$ 9,285	\$ 10,680
RNB244BV2LCC	4 Burner   LP Gas   Custom Color*   Standard Trim	\$ 9,190	\$ 10,570
RNB244BV2LCCPLT	4 Burner   LP Gas   Custom Color*   Plated Trim*	\$ 10,785	\$ 12,405
<b>BACKGUARD OPTIONS:</b>			
<b>All BlueStar freestanding appliances must be installed with a UL approved backguard. All units ship standard with a UL approved Island Trim unless otherwise specified.</b>			
BG624BSP	6" Backguard	\$ 605	\$ 695
BG2417BSP	17" Backguard	\$ 1,120	\$ 1,290
SDHS24BSP	24" High Shelf	\$ 1,460	\$ 1,680
<b>KNOB &amp; PAINTED BODY SIDE OPTIONS: (Total Knobs: 5)</b>			
SIDES-C	Add Painted Sides (All colors)	\$ 765	\$ 880
KN-BLK	Standard Black Knob (Must be ordered with unit)	N/C	N/C
KN-C	Knob: Standard 190 RAL Color	\$ 115 ea	\$ 130 ea
BZ-C	Bezel: Standard 190 RAL Color	\$ 70 ea	\$ 80 ea
KN-CF	Knob: Spec Finish (Matte RAL, Textured RAL or Prec Metals)	\$ 185 ea	\$ 215 ea
KN-PLT	Knob: Plated Trim (See options below)	\$ 250 ea	\$ 290 ea
<b>SWING DOOR OPTIONS:</b>			
SWING DOOR – LH	Swing Door – Left Hinge for Nova (RNB) Series	\$ 1,530	\$ 1,760
SWING DOOR – RH	Swing Door – Right Hinge for Nova (RNB) Series	\$ 1,530	\$ 1,760
<b>PLATED TRIM OPTIONS: (Includes bezels, door handle, handle ends and logo)</b>			
Antique Brass, Brushed Brass, Polished Brass, Antique Copper, Brushed Copper, Polished Copper, Chrome, Oil Rubbed Bronze & Pewter			
See page 40 for additional customization and accessories for Freestanding Ranges			

## FREESTANDING RANGES: 24" NOVA (RNB) SERIES

### 24" Nova (RNB) Series - All Griddle

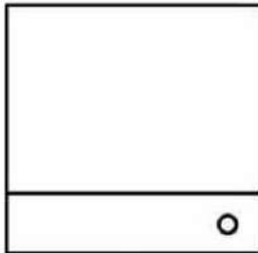

30,000

Model	Description (* Denotes item that must be specified)	UMRP	MSRP
<b>Natural Gas Models: 24" Nova Series – All Griddle</b>			
RNB24GV2	24" Nova Series   24" Griddle   Nat Gas   Stainless Steel   Standard Trim	\$ 5,995	\$ 6,895
RNB24GV2PLT	24" Nova Series   24" Griddle   Nat Gas   Stainless Steel   Plated Trim*	\$ 7,590	\$ 8,730
RNB24GV2C	24" Nova Series   24" Griddle   Nat Gas   Std RAL Paint*   Standard Trim	\$ 7,190	\$ 8,270
RNB24GV2CPLT	24" Nova Series   24" Griddle   Nat Gas   Std RAL Paint*   Plated Trim*	\$ 8,785	\$ 10,105
RNB24GV2CF	24" Nova Series   24" Griddle   Nat Gas   Specialty Finish*   Standard Trim	\$ 8,190	\$ 9,420
RNB24GV2CFPLT	24" Nova Series   24" Griddle   Nat Gas   Specialty Finish*   Plated Trim*	\$ 9,785	\$ 11,255
RNB24GV2CC	24" Nova Series   24" Griddle   Nat Gas   Custom Color*   Standard Trim	\$ 9,690	\$ 11,145
RNB24GV2CCPLT	24" Nova Series   24" Griddle   Nat Gas   Custom Color*   Plated Trim*	\$ 11,285	\$ 12,980
<b>LP/Propane Models: 24" Nova Series – All Griddle</b>			
RNB24GV2L	24" Nova Series   24" Griddle   LP Gas   Stainless Steel   Standard Trim	\$ 5,995	\$ 6,895
RNB24GV2LPLT	24" Nova Series   24" Griddle   LP Gas   Stainless Steel   Plated Trim*	\$ 7,590	\$ 8,730
RNB24GV2LC	24" Nova Series   24" Griddle   LP Gas   Std RAL Paint*   Standard Trim	\$ 7,190	\$ 8,270
RNB24GV2LCPLT	24" Nova Series   24" Griddle   LP Gas   Std RAL Paint*   Plated Trim*	\$ 8,785	\$ 10,105
RNB24GV2LCF	24" Nova Series   24" Griddle   LP Gas   Specialty Finish*   Standard Trim	\$ 8,190	\$ 9,420
RNB24GV2LCFPLT	24" Nova Series   24" Griddle   LP Gas   Specialty Finish*   Plated Trim*	\$ 9,785	\$ 11,255
RNB24GV2LCC	24" Nova Series   24" Griddle   LP Gas   Custom Color*   Standard Trim	\$ 9,690	\$ 11,145
RNB24GV2LCCPLT	24" Nova Series   24" Griddle   LP Gas   Custom Color*   Plated Trim*	\$ 11,285	\$ 12,980
<b>Customization &amp; Accessory Options: (See page 30)   Total Knobs: 3</b>			

### 24" Nova (RNB) Series - All Charbroiler

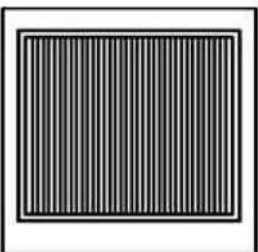

30,000

Model	Description (* Denotes item that must be specified)	UMRP	MSRP
<b>Natural Gas Models: 24" Nova Series – All Charbroiler</b>			
RNB24CBV2	24" Nova Series   24" Charbroiler   Nat Gas   Stainless Steel   Standard Trim	\$ 5,995	\$ 6,895
RNB24CBV2PLT	24" Nova Series   24" Charbroiler   Nat Gas   Stainless Steel   Plated Trim*	\$ 7,590	\$ 8,730
RNB24CBV2C	24" Nova Series   24" Charbroiler   Nat Gas   Std RAL Paint*   Standard Trim	\$ 7,190	\$ 8,270
RNB24CBV2CPLT	24" Nova Series   24" Charbroiler   Nat Gas   Std RAL Paint*   Plated Trim*	\$ 8,785	\$ 10,105
RNB24CBV2CF	24" Nova Series   24" Charbroiler   Nat Gas   Specialty Finish*   Standard Trim	\$ 8,190	\$ 9,420
RNB24CBV2CFPLT	24" Nova Series   24" Charbroiler   Nat Gas   Specialty Finish*   Plated Trim*	\$ 9,785	\$ 11,255
RNB24CBV2CC	24" Nova Series   24" Charbroiler   Nat Gas   Custom Color*   Standard Trim	\$ 9,690	\$ 11,145
RNB24CBV2CCPLT	24" Nova Series   24" Charbroiler   Nat Gas   Custom Color*   Plated Trim*	\$ 11,285	\$ 12,980
<b>LP/Propane Models: 24" Nova Series – Charbroiler</b>			
RNB24CBV2L	24" Nova Series   24" Charbroiler   LP Gas   Stainless Steel   Standard Trim	\$ 5,995	\$ 6,895
RNB24CBV2LPLT	24" Nova Series   24" Charbroiler   LP Gas   Stainless Steel   Plated Trim*	\$ 7,590	\$ 8,730
RNB24CBV2LC	24" Nova Series   24" Charbroiler   LP Gas   Std RAL Paint*   Standard Trim	\$ 7,190	\$ 8,270
RNB24CBV2LCPLT	24" Nova Series   24" Charbroiler   LP Gas   Std RAL Paint*   Plated Trim*	\$ 8,785	\$ 10,105
RNB24CBV2LCF	24" Nova Series   24" Charbroiler   LP Gas   Specialty Finish*   Standard Trim	\$ 8,190	\$ 9,420
RNB24CBV2LCFPLT	24" Nova Series   24" Charbroiler   LP Gas   Specialty Finish*   Plated Trim*	\$ 9,785	\$ 11,255
RNB24CBV2LCC	24" Nova Series   24" Charbroiler   LP Gas   Custom Color*   Standard Trim	\$ 9,690	\$ 11,145
RNB24CBV2LCCPLT	24" Nova Series   24" Charbroiler   LP Gas   Custom Color*   Plated Trim*	\$ 11,285	\$ 12,980
<b>Customization &amp; Accessory Options: (See page 30)   Total Knobs: 3</b>			

## FREESTANDING RANGES: 24" NOVA (RNB) SERIES

### 24" Nova (RNB) Series - All French Top

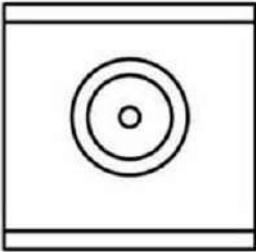

18,000

Model	Description (* Denotes item that must be specified)	UMRP	MSRP
<b>Natural Gas Models: 24" Nova Series – All French Top</b>			
RNB24FTV2	24" Nova Series   24" French Top   Nat Gas   Stainless Steel   Standard Trim	\$ 6,495	\$ 7,470
RNB24FTV2PLT	24" Nova Series   24" French Top   Nat Gas   Stainless Steel   Plated Trim*	\$ 8,090	\$ 9,305
RNB24FTV2C	24" Nova Series   24" French Top   Nat Gas   Std RAL Paint*   Standard Trim	\$ 7,690	\$ 8,845
RNB24FTV2CPLT	24" Nova Series   24" French Top   Nat Gas   Std RAL Paint*   Plated Trim*	\$ 9,285	\$ 10,680
RNB24FTV2CF	24" Nova Series   24" French Top   Nat Gas   Specialty Finish*   Standard Trim	\$ 8,690	\$ 9,995
RNB24FTV2CFPLT	24" Nova Series   24" French Top   Nat Gas   Specialty Finish*   Plated Trim*	\$ 10,285	\$ 11,830
RNB24FTV2CC	24" Nova Series   24" French Top   Nat Gas   Custom Color*   Standard Trim	\$ 10,190	\$ 11,720
RNB24FTV2CCPLT	24" Nova Series   24" French Top   Nat Gas   Custom Color*   Plated Trim*	\$ 11,785	\$ 13,555
<b>LP/Propane Models: 24" Nova Series – All French Top</b>			
RNB24FTV2L	24" Nova Series   24" French Top   LP Gas   Stainless Steel   Standard Trim	\$ 6,495	\$ 7,470
RNB24FTV2LPLT	24" Nova Series   24" French Top   LP Gas   Stainless Steel   Plated Trim*	\$ 8,090	\$ 9,305
RNB24FTV2LC	24" Nova Series   24" French Top   LP Gas   Std RAL Paint*   Standard Trim	\$ 7,690	\$ 8,845
RNB24FTV2LCPLT	24" Nova Series   24" French Top   LP Gas   Std RAL Paint*   Plated Trim*	\$ 9,285	\$ 10,680
RNB24FTV2LCF	24" Nova Series   24" French Top   LP Gas   Specialty Finish*   Standard Trim	\$ 8,690	\$ 9,995
RNB24FTV2LCFPLT	24" Nova Series   24" French Top   LP Gas   Specialty Finish*   Plated Trim*	\$ 10,285	\$ 11,830
RNB24FTV2LCC	24" Nova Series   24" French Top   LP Gas   Custom Color*   Standard Trim	\$ 10,190	\$ 11,720
RNB24FTV2LCCPLT	24" Nova Series   24" French Top   LP Gas   Custom Color*   Plated Trim*	\$ 11,785	\$ 13,555
<b>Customization &amp; Accessory Options: (See page 30)   Total Knobs: 2</b>			

## FREESTANDING RANGES: 36" CULINARY SERIES – OPEN BURNER

### Model Number Color & Customization Guide:

(C) 190 Standard RAL (Semi-Gloss) Colors	(CF) Specialty Finish (190 Matte RAL, Precious Metals & Textures)	(CC) Custom Color Match	(PLT) Plated Trim
--	---	-------------------------	-------------------

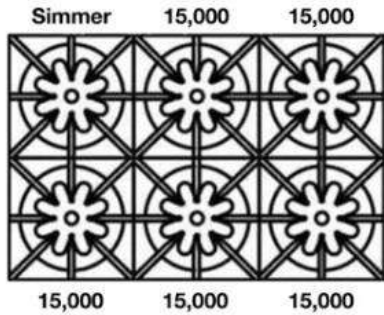

#### FEATURES:

- Restaurant-style 15,000 BTU open burners
- Precise 130° simmer burner
- Integrated wok cooking – no wok ring required
- Oversized convection oven accommodates full size 18" x 26" baking sheet
- 1850° infrared broiler
- Available in 1,000+ colors and 10 metal trim finishes
- Handcrafted in Pennsylvania
- Includes standard island trim backguard
- Available in Natural or LP gas

#### PRODUCT SPECIFICATIONS:

- Unit Dimensions: 35.875"W x 24"D x 36.75"H
- Oven Interior: 29.25"W x 20"D x 15"H
- Top Burner Power: 15,000 BTUs
- Simmer Burner: 9,000 BTUs
- Electrical Reqs: 120V, 60Hz, 15 AMPS, 1PH
- Gas Pressure: NAT: 5.0" WC, LP 10.0" WC
- Gas Line Size: ½
- 36" Unit Weight: 470 lbs.

Model	Description (* Denotes item that must be specified)	UMRP	MSRP
<b>Natural Gas Models: 36" Culinary Series – Open Burner</b>			
RCS366BV2	6 Burner   Nat Gas   Stainless Steel   Standard Trim	\$ 4,995	\$ 5,875
RCS366BV2PLT	6 Burner   Nat Gas   Stainless Steel   Plated Trim*	\$ 6,890	\$ 8,105
RCS366BV2C	6 Burner   Nat Gas   Std RAL Color*   Standard Trim	\$ 6,190	\$ 7,280
RCS366BV2CPLT	6 Burner   Nat Gas   Std RAL Color*   Plated Trim*	\$ 8,085	\$ 9,510
RCS366BV2CF	6 Burner   Nat Gas   Specialty Finish*   Standard Trim	\$ 7,190	\$ 8,460
RCS366BV2CFPLT	6 Burner   Nat Gas   Specialty Finish*   Plated Trim*	\$ 9,085	\$ 10,690
RCS366BV2CC	6 Burner   Nat Gas   Custom Color*   Standard Trim	\$ 8,690	\$ 10,225
RCS366BV2CCPLT	6 Burner   Nat Gas   Custom Color*   Plated Trim*	\$ 10,585	\$ 12,455
<b>LP/Propane Models: 36" Culinary Series – Open Burner</b>			
RCS366BV2L	6 Burner   LP Gas   Stainless Steel   Standard Trim	\$ 4,995	\$ 5,875
RCS366BV2LPLT	6 Burner   LP Gas   Stainless Steel   Plated Trim*	\$ 6,890	\$ 8,105
RCS366BV2LC	6 Burner   LP Gas   Std RAL Color*   Standard Trim	\$ 6,190	\$ 7,280
RCS366BV2LCPLT	6 Burner   LP Gas   Std RAL Color*   Plated Trim*	\$ 8,085	\$ 9,510
RCS366BV2LCF	6 Burner   LP Gas   Specialty Finish*   Standard Trim	\$ 7,190	\$ 8,460
RCS366BV2LCFPLT	6 Burner   LP Gas   Specialty Finish*   Plated Trim*	\$ 9,085	\$ 10,690
RCS366BV2LCC	6 Burner   LP Gas   Custom Color*   Standard Trim	\$ 8,690	\$ 10,225
RCS366BV2LCCPLT	6 Burner   LP Gas   Custom Color*   Plated Trim*	\$ 10,585	\$ 12,455
<b>BACKGUARD OPTIONS:</b>			
<b>All BlueStar freestanding appliances must be installed with a UL approved backguard. All units ship standard with a UL approved Island Trim unless otherwise specified.</b>			
BG636BSP	6" Backguard for 36" RCS Range	\$ 720	\$ 830
BG3617BSP	17" Backguard for 36" RCS Range	\$ 1,460	\$ 1,680
SDHS36BSP	24" High Shelf for 36" RCS Range	\$ 1,690	\$ 1,945
<b>KNOB OPTIONS: (Total Knobs: 7)</b>			
SIDES-C	Add Painted Sides (All colors)	\$ 765	\$ 880
KN-BLK	Standard Black Knob (Must be ordered with unit)	N/C	N/C
KN-C	Knob: Standard 190 RAL Color	\$ 115 ea	\$ 130 ea
BZ-C	Bezel: Standard 190 RAL Color	\$ 70 ea	\$ 80 ea
KN-CF	Knob: Spec Finish (Matte RAL, Textured RAL or Prec Metals)	\$ 185 ea	\$ 215 ea
KN-PLT	Knob: Plated Trim (See options below)	\$ 250 ea	\$ 290 ea
Antique Brass, Brushed Brass, Polished Brass, Antique Copper, Brushed Copper, Polished Copper, Chrome, Oil Rubbed Bronze & Pewter			
See page 40 for additional customization and accessories for Freestanding Ranges			

## FREESTANDING RANGES: 30" CULINARY SERIES – OPEN BURNER

### Model Number Color & Customization Guide:

(C) 190 Standard RAL (Semi-Gloss) Colors	(CF) Specialty Finish (190 Matte RAL, Precious Metals & Textures)	(CC) Custom Color Match	(PLT) Plated Trim
--	---	-------------------------	-------------------

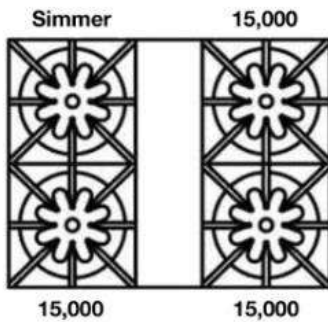

#### FEATURES:

- Restaurant-style 15,000 BTU open burners
- Precise 130° simmer burner
- Integrated wok cooking – no wok ring required
- Oversized convection oven accommodates full size 18" x 26" baking sheet
- 1850° infrared broiler
- Available in 1,000+ colors and 10 metal trim finishes
- Handcrafted in Pennsylvania
- Includes standard island trim backguard
- Available in Natural or LP gas

#### PRODUCT SPECIFICATIONS:

- Unit Dimensions: 29.875W x 24"D x 36.75"H
- Oven Interior: 26.438"W x 20"D x 15"H
- Top Burner Power: 15,000 BTUs
- Simmer Burner: 9,000 BTUs
- Electrical Reqs: 120V, 60Hz, 15 AMPS, 1PH
- Gas Pressure: NAT: 5.0" WC, LP 10.0" WC
- Gas Line Size: ½
- 30" Unit Weight: 420 lbs.

Model	Description (* Denotes item that must be specified)	UMRP	MSRP
<b>Natural Gas Models: 30" Culinary Series – Open Burner</b>			
RCS304BV2	4 Burner   Nat Gas   Stainless Steel   Standard Trim	\$ 3,995	\$ 4,700
RCS304BV2PLT	4 Burner   Nat Gas   Stainless Steel   Plated Trim*	\$ 5,590	\$ 6,575
RCS304BV2C	4 Burner   Nat Gas   Std RAL Color*   Standard Trim	\$ 5,190	\$ 6,105
RCS304BV2CPLT	4 Burner   Nat Gas   Std RAL Color*   Plated Trim*	\$ 6,785	\$ 7,980
RCS304BV2CF	4 Burner   Nat Gas   Specialty Finish*   Standard Trim	\$ 6,190	\$ 7,280
RCS304BV2CFPLT	4 Burner   Nat Gas   Specialty Finish*   Plated Trim*	\$ 7,785	\$ 9,160
RCS304BV2CC	4 Burner   Nat Gas   Custom Color*   Standard Trim	\$ 7,690	\$ 9,045
RCS304BV2CCPLT	4 Burner   Nat Gas   Custom Color*   Plated Trim*	\$ 9,285	\$ 10,925
<b>LP/Propane Models: 30" Culinary Series – Open Burner</b>			
RCS304BV2L	4 Burner   LP Gas   Stainless Steel   Standard Trim	\$ 3,995	\$ 4,700
RCS304BV2LPLT	4 Burner   LP Gas   Stainless Steel   Plated Trim*	\$ 5,590	\$ 6,575
RCS304BV2LC	4 Burner   LP Gas   Std RAL Color*   Standard Trim	\$ 5,190	\$ 6,105
RCS304BV2LCPLT	4 Burner   LP Gas   Std RAL Color*   Plated Trim*	\$ 6,785	\$ 7,980
RCS304BV2LCF	4 Burner   LP Gas   Specialty Finish*   Standard Trim	\$ 6,190	\$ 7,280
RCS304BV2LCFPLT	4 Burner   LP Gas   Specialty Finish*   Plated Trim*	\$ 7,785	\$ 9,160
RCS304BV2LCC	4 Burner   LP Gas   Custom Color*   Standard Trim	\$ 7,690	\$ 9,045
RCS304BV2LCCPLT	4 Burner   LP Gas   Custom Color*   Plated Trim*	\$ 9,285	\$ 10,925
<b>BACKGUARD OPTIONS:</b>			
<b>All BlueStar freestanding appliances must be installed with a UL approved backguard. All units ship standard with a UL approved Island Trim unless otherwise specified.</b>			
BG630BSP	6" Backguard for 30" RCS Range	\$ 605	\$ 695
BG3017BSP	17" Backguard for 30" RCS Range	\$ 1,120	\$ 1,290
SDHS30BSP	24" High Shelf for 30" RCS Range	\$ 1,460	\$ 1,680
<b>KNOB OPTIONS: (Total Knobs: 5)</b>			
SIDES-C	Add Painted Sides (All colors)	\$ 765	\$ 880
KN-BLK	Standard Black Knob (Must be ordered with unit)	N/C	N/C
KN-C	Knob: Standard 190 RAL Color	\$ 115 ea	\$ 130 ea
BZ-C	Bezel: Standard 190 RAL Color	\$ 70 ea	\$ 80 ea
KN-CF	Knob: Spec Finish (Matte RAL, Textured RAL or Prec Metals)	\$ 185 ea	\$ 215 ea
KN-PLT	Knob: Plated Trim (See options below)	\$ 250 ea	\$ 290 ea
Antique Brass, Brushed Brass, Polished Brass, Antique Copper, Brushed Copper, Polished Copper, Chrome, Oil Rubbed Bronze & Pewter			
See page 40 for additional customization and accessories for Freestanding Ranges			

# FREESTANDING RANGES: 48" CULINARY SERIES – SEALED BURNER BURNER

## Model Number Color & Customization Guide:

(C) 190 Standard RAL (Semi-Gloss) Colors	(CF) Specialty Finish (190 Matte RAL, Precious Metals & Textures)	(CC) Custom Color Match	(PLT) Plated Trim
--	---	-------------------------	-------------------

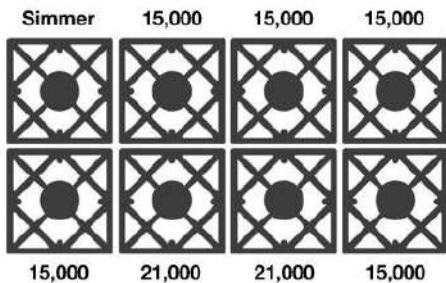

### FEATURES:

- Sealed burner design with up to 21,000 BTUs of power (18,000 BTUs on LP/Propane models)
- Precise simmer burner
- Extra-large convection oven with 1850° infrared broiler that accommodates a full size 18" x 26" commercial baking sheet.
- 24" depth for compatibility with standard kitchen cabinetry
- Available in 1,000+ colors and finishes
- Handcrafted in Pennsylvania since 1880

### PRODUCT SPECIFICATIONS:

- Unit Dimensions: 47.875"W x 24"D x 36.75"H
- Large Oven Intr: 26.438"W x 20"D x 15"H
- Small Oven Intr: 13.578"W x 20"D x 15"H
- Top Burner Power: NAT: 21,000 BTUs / LP: 18,000 BTUs
- Simmer Burner: 5,000 BTUs
- Electrical Reqs: 120V, 60Hz, 15 AMPS, 1PH
- Gas Pressure: NAT: 5.0" WC, LP 10.0" WC
- Gas Line Size: 3/4"
- Unit Weight: 645 lbs.

Model	Description (* Denotes item that must be specified)	UMRP	MSRP
<b>Natural Gas Models: 48" Culinary Series – Sealed Burner</b>			
RCS48SBV2	8 Burner   Nat Gas   Stainless Steel   Standard Trim	\$ 9,295	\$ 10,690
RCS48SBV2PLT	8 Burner   Nat Gas   Stainless Steel   Plated Trim*	\$ 11,490	\$ 13,215
RCS48SBV2C	8 Burner   Nat Gas   Std RAL Color*   Standard Trim	\$ 10,790	\$ 12,410
RCS48SBV2CPLT	8 Burner   Nat Gas   Std RAL Color*   Plated Trim*	\$ 12,985	\$ 14,935
RCS48SBV2CF	8 Burner   Nat Gas   Specialty Finish*   Standard Trim	\$ 11,890	\$ 13,675
RCS48SBV2CFPLT	8 Burner   Nat Gas   Specialty Finish*   Plated Trim*	\$ 14,085	\$ 16,200
RCS48SBV2CC	8 Burner   Nat Gas   Custom Color*   Standard Trim	\$ 13,290	\$ 15,285
RCS48SBV2CCPLT	8 Burner   Nat Gas   Custom Color*   Plated Trim*	\$ 15,485	\$ 17,810
<b>LP/Propane Models: 48" Culinary Series – Sealed Burner</b>			
RCS48SBV2L	8 Burner   LP Gas   Stainless Steel   Standard Trim	\$ 9,295	\$ 10,690
RCS48SBV2LPLT	8 Burner   LP Gas   Stainless Steel   Plated Trim*	\$ 11,490	\$ 13,215
RCS48SBV2LC	8 Burner   LP Gas   Std RAL Color*   Standard Trim	\$ 10,790	\$ 12,410
RCS48SBV2LCPLT	8 Burner   LP Gas   Std RAL Color*   Plated Trim*	\$ 12,985	\$ 14,935
RCS48SBV2LCF	8 Burner   LP Gas   Specialty Finish*   Standard Trim	\$ 11,890	\$ 13,675
RCS48SBV2LCFPLT	8 Burner   LP Gas   Specialty Finish*   Plated Trim*	\$ 14,085	\$ 16,200
RCS48SBV2LCC	8 Burner   LP Gas   Custom Color*   Standard Trim	\$ 13,290	\$ 15,285
RCS48SBV2LCCPLT	8 Burner   LP Gas   Custom Color*   Plated Trim*	\$ 15,485	\$ 17,810
<b>BACKGUARD OPTIONS:</b>			
<b>All BlueStar freestanding appliances must be installed with a UL approved backguard. All units ship standard with a UL approved Island Trim unless otherwise specified.</b>			
BG648SB	6" Backguard	\$ 1,040	\$ 1,195
<b>KNOB &amp; PAINTED BODY SIDE OPTIONS: (Total Knobs: 10)</b>			
SIDES-C	Add Painted Sides (All colors)	\$ 765	\$ 880
KN-BLK	Standard Black Knob ( <i>Must be ordered with unit</i> )	N/C	N/C
KN-C	Knob: Standard 190 RAL Color	\$ 115 ea	\$ 130 ea
BZ-C	Bezel: Standard 190 RAL Color	\$ 70 ea	\$ 80 ea
KN-CF	Knob: Spec Finish (Matte RAL, Textured RAL or Prec Metals)	\$ 185 ea	\$ 215 ea
KN-PLT	Knob: Plated Trim (See options below)	\$ 250 ea	\$ 290 ea
<b>PLATED TRIM OPTIONS: (Includes bezels, door handle, handle ends and logo)</b>			
Antique Brass, Brushed Brass, Polished Brass, Antique Copper, Brushed Copper, Polished Copper, Chrome, Oil Rubbed Bronze & Pewter			
See page 40 for additional customization and accessories for Freestanding Ranges			

# FREESTANDING RANGES: 36" CULINARY SERIES – SEALED BURNER BURNER

## Model Number Color & Customization Guide:

(C) 190 Standard RAL (Semi-Gloss) Colors	(CF) Specialty Finish (190 Matte RAL, Precious Metals & Textures)	(CC) Custom Color Match	(PLT) Plated Trim
--	---	-------------------------	-------------------

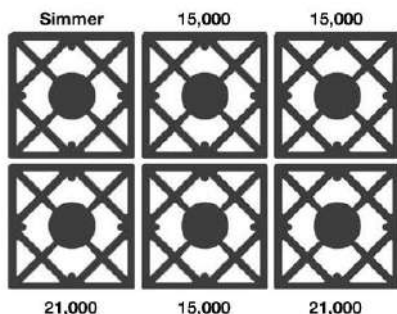

### FEATURES:

- Sealed burner design with up to 21,000 BTUs of power (18,000 BTUs on LP/Propane models)
- Precise simmer burner
- Extra-large convection oven with 1850° infrared broiler that accommodates a full size 18" x 26" commercial baking sheet.
- 24" depth for compatibility with standard kitchen cabinetry
- Available in 1,000+ colors and finishes
- Handcrafted in Pennsylvania since 1880

### PRODUCT SPECIFICATIONS:

- Unit Dimensions: 35.875"W x 24"D x 36.75"H
- Oven Interior: 29.25"W x 20"D x 15"H
- Top Burner Power: 21,000 BTUs / 18,000 BTUs
- Simmer Burner: 5,000 BTUs
- Electrical Reqs: 120V, 60Hz, 15 AMPS, 1PH
- Gas Pressure: NAT: 5.0" WC, LP 10.0" WC
- Gas Line Size: ½"
- Unit Weight: 420 lbs.

Model	Description (* Denotes item that must be specified)	UMRP	MSRP
<b>Natural Gas Models: 36" Culinary Series – Sealed Burner</b>			
RCS36SBV2	6 Burner   Nat Gas   Stainless Steel   Standard Trim	\$ 4,995	\$ 5,875
RCS36SBV2PLT	6 Burner   Nat Gas   Stainless Steel   Plated Trim*	\$ 6,890	\$ 8,105
RCS36SBV2C	6 Burner   Nat Gas   Std RAL Color*   Standard Trim	\$ 6,190	\$ 7,280
RCS36SBV2CPLT	6 Burner   Nat Gas   Std RAL Color*   Plated Trim*	\$ 8,085	\$ 9,510
RCS36SBV2CF	6 Burner   Nat Gas   Specialty Finish*   Standard Trim	\$ 7,190	\$ 8,460
RCS36SBV2CFPLT	6 Burner   Nat Gas   Specialty Finish*   Plated Trim*	\$ 9,085	\$ 10,690
RCS36SBV2CC	6 Burner   Nat Gas   Custom Color*   Standard Trim	\$ 8,690	\$ 10,225
RCS36SBV2CCPLT	6 Burner   Nat Gas   Custom Color*   Plated Trim*	\$ 10,585	\$ 12,455
<b>LP/Propane Models: 36" Culinary Series – Sealed Burner</b>			
RCS36SBV2L	6 Burner   LP Gas   Stainless Steel   Standard Trim	\$ 4,995	\$ 5,875
RCS36SBV2LPLT	6 Burner   LP Gas   Stainless Steel   Plated Trim*	\$ 6,890	\$ 8,105
RCS36SBV2LC	6 Burner   LP Gas   Std RAL Color*   Standard Trim	\$ 6,190	\$ 7,280
RCS36SBV2LCPLT	6 Burner   LP Gas   Std RAL Color*   Plated Trim*	\$ 8,085	\$ 9,510
RCS36SBV2LCF	6 Burner   LP Gas   Specialty Finish*   Standard Trim	\$ 7,190	\$ 8,460
RCS36SBV2LCFPLT	6 Burner   LP Gas   Specialty Finish*   Plated Trim*	\$ 9,085	\$ 10,690
RCS36SBV2LCC	6 Burner   LP Gas   Custom Color*   Standard Trim	\$ 8,690	\$ 10,225
RCS36SBV2LCCPLT	6 Burner   LP Gas   Custom Color*   Plated Trim*	\$ 10,585	\$ 12,455
<b>BACKGUARD OPTIONS:</b>			
<b>All BlueStar freestanding appliances must be installed with a UL approved backguard. All units ship standard with a UL approved Island Trim unless otherwise specified.</b>			
BG636SB	6" Backguard	\$ 720	\$ 830
BG3617SB	17" Backguard	\$ 1,460	\$ 1,680
SDHS36SB	24" High Shelf	\$ 1,690	\$ 1,945
<b>KNOB &amp; PAINTED BODY SIDE OPTIONS: (Total Knobs: 7)</b>			
SIDES-C	Add Painted Sides (All colors)	\$ 765	\$ 880
KN-BLK	Standard Black Knob (Must be ordered with unit)	N/C	N/C
KN-C	Knob: Standard 190 RAL Color	\$ 115 ea	\$ 130 ea
BZ-C	Bezel: Standard 190 RAL Color	\$ 70 ea	\$ 80 ea
KN-CF	Knob: Spec Finish (Matte RAL, Textured RAL or Prec Metals)	\$ 185 ea	\$ 215 ea
KN-PLT	Knob: Plated Trim (See options below)	\$ 250 ea	\$ 290 ea
<b>PLATED TRIM OPTIONS: (Includes bezels, door handle, handle ends and logo)</b>			
Antique Brass, Brushed Brass, Polished Brass, Antique Copper, Brushed Copper, Polished Copper, Chrome, Oil Rubbed Bronze & Pewter			
See page 40 for additional customization and accessories for Freestanding Ranges			

# FREESTANDING RANGES: 30" CULINARY SERIES – SEALED BURNER BURNER

Model Number Color & Customization Guide:			
(C) 190 Standard RAL (Semi-Gloss) Colors	(CF) Specialty Finish (190 Matte RAL, Precious Metals & Textures)	(CC) Custom Color Match	(PLT) Plated Trim

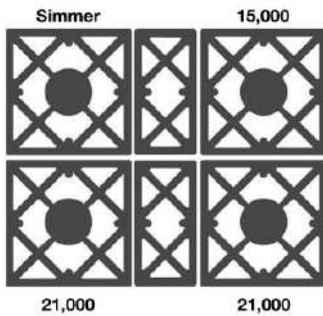

### FEATURES:

- Sealed burner design with up to 21,000 BTUs of power (18,000 BTUs on LP/Propane models)
- Precise simmer burner
- Extra-large convection oven with 1850° infrared broiler that accommodates a full size 18" x 26" commercial baking sheet. 24" model accommodates half size baking sheet.
- 24" depth for compatibility with standard kitchen cabinetry
- Available in 1,000+ colors and finishes
- Handcrafted in Pennsylvania since 1880

### PRODUCT SPECIFICATIONS:

- Unit Dimensions: 29.875"W x 24"D x 36.75"H
- Oven Interior: 26.438"W x 20"D x 15"H
- Top Burner Power: 21,000 BTUs / 18,000 BTUs
- Simmer Burner: 5,000 BTUs
- Electrical Reqs: 120V, 60Hz, 15 AMPS, 1PH
- Gas Pressure: NAT: 5.0" WC, LP 10.0" WC
- Gas Line Size: ½"
- Unit Weight: 380 lbs.

Model	Description (* Denotes item that must be specified)	UMRP	MSRP
<b>Natural Gas Models: 30" Culinary Series – Sealed Burner</b>			
RCS30SBV2	4 Burner   Nat Gas   Stainless Steel   Standard Trim	\$ 3,995	\$ 4,700
RCS30SBV2PLT	4 Burner   Nat Gas   Stainless Steel   Plated Trim*	\$ 5,590	\$ 6,575
RCS30SBV2C	4 Burner   Nat Gas   Std RAL Color*   Standard Trim	\$ 5,190	\$ 6,105
RCS30SBV2CPLT	4 Burner   Nat Gas   Std RAL Color*   Plated Trim*	\$ 6,785	\$ 7,980
RCS30SBV2CF	4 Burner   Nat Gas   Specialty Finish*   Standard Trim	\$ 6,190	\$ 7,280
RCS30SBV2CFPLT	4 Burner   Nat Gas   Specialty Finish*   Plated Trim*	\$ 7,785	\$ 9,160
RCS30SBV2CC	4 Burner   Nat Gas   Custom Color*   Standard Trim	\$ 7,690	\$ 9,045
RCS30SBV2CCPLT	4 Burner   Nat Gas   Custom Color*   Plated Trim*	\$ 9,285	\$ 10,925
<b>LP/Propane Models: 30" Culinary Series – Sealed Burner</b>			
RCS30SBV2L	4 Burner   LP Gas   Stainless Steel   Standard Trim	\$ 3,995	\$ 4,700
RCS30SBV2LPLT	4 Burner   LP Gas   Stainless Steel   Plated Trim*	\$ 5,590	\$ 6,575
RCS30SBV2LC	4 Burner   LP Gas   Std RAL Color*   Standard Trim	\$ 5,190	\$ 6,105
RCS30SBV2LCPLT	4 Burner   LP Gas   Std RAL Color*   Plated Trim*	\$ 6,785	\$ 7,980
RCS30SBV2LCF	4 Burner   LP Gas   Specialty Finish*   Standard Trim	\$ 6,190	\$ 7,280
RCS30SBV2LCFPLT	4 Burner   LP Gas   Specialty Finish*   Plated Trim*	\$ 7,785	\$ 9,160
RCS30SBV2LCC	4 Burner   LP Gas   Custom Color*   Standard Trim	\$ 7,690	\$ 9,045
RCS30SBV2LCCPLT	4 Burner   LP Gas   Custom Color*   Plated Trim*	\$ 9,285	\$ 10,925
<b>BACKGUARD OPTIONS:</b>			
<b>All BlueStar freestanding appliances must be installed with a UL approved backguard. All units ship standard with a UL approved Island Trim unless otherwise specified.</b>			
BG630SB	6" Backguard	\$ 605	\$ 695
BG3017SB	17" Backguard	\$ 1,120	\$ 1,290
SDHS30SB	24" High Shelf	\$ 1,460	\$ 1,680
<b>KNOB &amp; PAINTED BODY SIDE OPTIONS: (Total Knobs: 5)</b>			
SIDES-C	Add Painted Sides (All colors)	\$ 765	\$ 880
KN-BLK	Standard Black Knob (Must be ordered with unit)	N/C	N/C
KN-SS	Knob: Brushed Stainless Steel	\$ 115 ea	\$ 130 ea
KN-C	Knob: Standard 190 RAL Color	\$ 115 ea	\$ 130 ea
BZ-C	Bezel: Standard 190 RAL Color	\$ 70 ea	\$ 80 ea
KN-CF	Knob: Spec Finish (Matte RAL, Textured RAL or Prec Metals)	\$ 185 ea	\$ 215 ea
KN-PLT	Knob: Plated Trim (See options below)	\$ 250 ea	\$ 290 ea
<b>PLATED TRIM OPTIONS: (Includes bezels, door handle, handle ends and logo)</b>			
Antique Brass, Brushed Brass, Polished Brass, Antique Copper, Brushed Copper, Polished Copper, Chrome, Oil Rubbed Bronze & Pewter			
See page 40 for additional customization and accessories for Freestanding Ranges			

# FREESTANDING RANGES: 24" CULINARY SERIES – SEALED BURNER BURNER

## Model Number Color & Customization Guide:

(C) 190 Standard RAL (Semi-Gloss) Colors	(CF) Specialty Finish (190 Matte RAL, Precious Metals & Textures)	(CC) Custom Color Match	(PLT) Plated Trim
--	---	-------------------------	-------------------

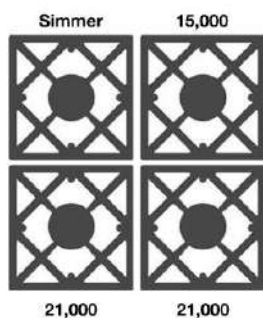

### FEATURES:

- Sealed burner design with up to 21,000 BTUs of power (18,000 BTUs on LP/Propane models)
- Precise simmer burner
- Extra-large convection oven with 1850° infrared broiler that accommodates a half size 18" x 13" commercial baking sheet.
- 24" depth for compatibility with standard kitchen cabinetry
- Available in 1,000+ colors and finishes
- Handcrafted in Pennsylvania since 1880

### PRODUCT SPECIFICATIONS:

- Unit Dimensions: 23.875"W x 24"D x 36.75"H
- Oven Interior: 20.25"W x 20"D x 15"H
- Top Burner Power: 21,000 BTUs / 18,000 BTUs
- Simmer Burner: 5,000 BTUs
- Electrical Reqs: 120V, 60Hz, 15 AMPS, 1PH
- Gas Pressure: NAT: 5.0" WC, LP 10.0" WC
- Gas Line Size: ½"
- Unit Weight: 365 lbs

Model	Description (* Denotes item that must be specified)	UMRP	MSRP
<b>Natural Gas Models: 24" Culinary Series – Sealed Burner</b>			
RCS24SBV2	4 Burner   Nat Gas   Stainless Steel   Standard Trim	\$ 4,195	\$ 4,825
RCS24SBV2PLT	4 Burner   Nat Gas   Stainless Steel   Plated Trim*	\$ 5,790	\$ 6,660
RCS24SBV2C	4 Burner   Nat Gas   Std RAL Color*   Standard Trim	\$ 5,390	\$ 6,200
RCS24SBV2CPLT	4 Burner   Nat Gas   Std RAL Color*   Plated Trim*	\$ 6,985	\$ 8,035
RCS24SBV2CF	4 Burner   Nat Gas   Specialty Finish*   Standard Trim	\$ 6,390	\$ 7,350
RCS24SBV2CFPLT	4 Burner   Nat Gas   Specialty Finish*   Plated Trim*	\$ 7,985	\$ 9,185
RCS24SBV2CC	4 Burner   Nat Gas   Custom Color*   Standard Trim	\$ 7,890	\$ 9,075
RCS24SBV2CCPLT	4 Burner   Nat Gas   Custom Color*   Plated Trim*	\$ 9,485	\$ 10,910
<b>LP/Propane Models: 24" Culinary Series – Sealed Burner</b>			
RCS24SBV2L	4 Burner   LP Gas   Stainless Steel   Standard Trim	\$ 4,195	\$ 4,825
RCS24SBV2LPLT	4 Burner   LP Gas   Stainless Steel   Plated Trim*	\$ 5,790	\$ 6,660
RCS24SBV2LC	4 Burner   LP Gas   Std RAL Color*   Standard Trim	\$ 5,390	\$ 6,200
RCS24SBV2LCPLT	4 Burner   LP Gas   Std RAL Color*   Plated Trim*	\$ 6,985	\$ 8,035
RCS24SBV2LCF	4 Burner   LP Gas   Specialty Finish*   Standard Trim	\$ 6,390	\$ 7,350
RCS24SBV2LCFPLT	4 Burner   LP Gas   Specialty Finish*   Plated Trim*	\$ 7,985	\$ 9,185
RCS24SBV2LCC	4 Burner   LP Gas   Custom Color*   Standard Trim	\$ 7,890	\$ 9,075
RCS24SBV2LCCPLT	4 Burner   LP Gas   Custom Color*   Plated Trim*	\$ 9,485	\$ 10,910
<b>BACKGUARD OPTIONS:</b>			
<b>All BlueStar freestanding appliances must be installed with a UL approved backguard. All units ship standard with a UL approved Island Trim unless otherwise specified.</b>			
BG624SB	6" Backguard	\$ 605	\$ 695
BG2417SB	17" Backguard	\$ 1,120	\$ 1,290
SDHS24SB	24" High Shelf	\$ 1,460	\$ 1,680
<b>KNOB &amp; PAINTED BODY SIDE OPTIONS: (Total Knobs: 5)</b>			
SIDES-C	Add Painted Sides (All colors)	\$ 765	\$ 880
KN-BLK	Standard Black Knob (Must be ordered with unit)	N/C	N/C
KN-SS	Knob: Brushed Stainless Steel	\$ 115 ea	\$ 130 ea
KN-C	Knob: Standard 190 RAL Color	\$ 115 ea	\$ 130 ea
BZ-C	Bezel: Standard 190 RAL Color	\$ 70 ea	\$ 80 ea
KN-CF	Knob: Spec Finish (Matte RAL, Textured RAL or Prec Metals)	\$ 185 ea	\$ 215 ea
KN-PLT	Knob: Plated Trim (See options below)	\$ 250 ea	\$ 290 ea
<b>PLATED TRIM OPTIONS: (Includes bezels, door handle, handle ends and logo)</b>			
Antique Brass, Brushed Brass, Polished Brass, Antique Copper, Brushed Copper, Polished Copper, Chrome, Oil Rubbed Bronze & Pewter			
See page 40 for additional customization and accessories for Freestanding Ranges			

# FREESTANDING RANGES: 30" INDUCTION

## Model Number Color & Customization Guide:

(C) 190 Standard RAL (Semi-Gloss) Colors	(CF) Specialty Finish (190 Matte RAL, Precious Metals & Textures)	(CC) Custom Color Match	(PLT) Plated Trim
--	---	-------------------------	-------------------



7 7/8" Diameter  
1,850 W  
3,000 W Boost

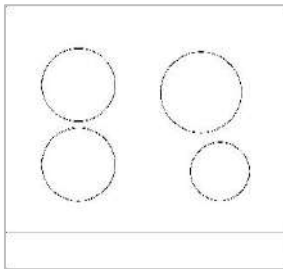

8 5/8" Diameter  
2,300 W  
3,700 W Boost

7 7/8" Diameter  
1,850 W  
3,000 W Boost

6 1/4" Diameter  
1,400 W  
2,200 W Boost

### FEATURES:

- Four round cooking zones automatically adjust to the size of your cookware
- Nine heat levels on each zone for exceptional control
- Power Booster boils a gallon of water in less than 5 minutes
- Heat Accelerator kickstarts cooking on all zones
- Keep Warm allows two levels of even, low temperatures
- Hot-surface light indicates when safe to touch
- Oversized, electric convection oven accommodates a full size 18" x 26" commercial baking sheet
- Five selectable cooking modes: Bake, Convection Bake, Fast Preheat, Broil & Convection Broil
- Powerful 2500 watt top and bottom heating elements
- Lock function enables knobs to be electronically locked
- Available in 1,000+ colors and finishes
- Handcrafted in Pennsylvania since 1880

### PRODUCT SPECIFICATIONS:

- Unit Dimensions: 29.875"W x 24"D x 36.75"H
- Oven Interior: 26.438"W x 20"D x 15"H
- Front Left Burner: 3,000 watts
- Front Right Burner: 2,200 watts
- Back Left Burner: 3,000 watts
- Back Right Burner: 3,700 watts
- Broiler Element: 2,500 watts
- Bake Element: 2,500 watts
- Elec. Req: 240 volt, 60 Hertz, 50 Amp, Single phase

Model	Description (* Denotes item that must be specified)	UMRP	MSRP
<b>Induction: 30" Induction Range</b>			
BSIR30	4 Zone   Induction   Stainless Steel   Standard Trim	\$ 6,995	\$ 8,045
BSIR30PLT	4 Zone   Induction   Stainless Steel   Plated Trim*	\$ 8,590	\$ 9,880
BSIR30C	4 Zone   Induction   Std RAL Color*   Standard Trim	\$ 8,190	\$ 9,420
BSIR30CPLT	4 Zone   Induction   Std RAL Color*   Plated Trim*	\$ 9,785	\$ 11,255
BSIR30CF	4 Zone   Induction   Spec Finish*   Standard Trim	\$ 9,190	\$ 10,570
BSIR30CFPLT	4 Zone   Induction   Spec Finish*   Plated Trim*	\$ 10,785	\$ 12,405
BSIR30CC	4 Zone   Induction   Custom Color*   Standard Trim	\$ 10,690	\$ 12,295
BSIR30CCPLT	4 Zone   Induction   Custom Color*   Plated Trim*	\$ 12,285	\$ 14,130
<b>KNOB &amp; PAINTED BODY SIDE OPTIONS: (Total Knobs: 5)</b>			
SIDES-C	Add Painted Sides (All colors)	\$ 765	\$ 880
KN-BLK	Standard Black Knob ( <i>Must be ordered with unit</i> )	N/C	N/C
KN-SS	Knob: Brushed Stainless Steel	\$ 115 ea	\$ 130 ea
KN-C	Knob: Standard 190 RAL Color	\$ 115 ea	\$ 130 ea
BZ-C	Bezel: Standard 190 RAL Color	\$ 70 ea	\$ 80 ea
KN-CF	Knob: Spec Finish (Matte RAL, Textured RAL or Prec Metals)	\$ 185 ea	\$ 215 ea
KN-PLT	Knob: Plated Trim (See options below)	\$ 250 ea	\$ 290 ea
<b>PLATED TRIM OPTIONS: (Includes bezels, door handle, handle ends and logo)</b>			
Antique Brass, Brushed Brass, Polished Brass, Antique Copper, Brushed Copper, Polished Copper, Chrome, Oil Rubbed Bronze & Pewter			
See page 40 for additional customization and accessories for Freestanding Ranges			

## FREESTANDING RANGES: CUSTOMIZATION & ACCESSORY OPTIONS

Item	Description	UMRP	MSRP
<b>CONFIGURATION OPTIONS: (Available on Platinum &amp; Nova/RNB Series Only)</b>			
BURNER CHG	Add (1) Star Burner – RNB / RGTNB (Simmer, 15K & 22K)   BSP (Simmer, 15K, 18K, 22K or 25K) or Swap (2) Star Burners – RNB / RGTNB / BSP	\$ 715	\$ 820
SWING DOOR – LH	Swing Door – Left Hinge – 24”, 30”, 36”, 48” (Left Oven) & 60” (Left Oven) (RNB Series Only)	\$ 1,530	\$ 1,760
SWING DOOR – RH	Swing Door – Right Hinge – 24”, 30”, 36”, 48” (Right Oven) & 60” (Right Oven) (RNB Series Only)	\$ 1,530	\$ 1,760
<b>PAINT OPTIONS: (Available on Platinum, Nova/RNB &amp; Culinary Series – Sealed Burner Series Only)</b>			
SIDES-C	Body Sides: Standard RAL (Semi-Gloss) (2) Body sides – RNB/Platinum Excludes Pearl, Luminous & Aluminum) Must be ordered with painted range	\$ 765	\$ 880
KN-C	Knob: Standard RAL (Semi-Gloss) Knob – Factory Installed . (Excludes Pearl, Luminous & Aluminum)	\$ 115 ea	\$ 130 ea
BZ-C	Bezel: Standard RAL (Semi-Gloss) Knob – Factory Installed . (Excludes Pearl, Luminous & Aluminum)	\$ 70 ea	\$ 80 ea
SIDES-CF	Body Sides: Specialty Finish (Matte RAL, Textured RAL or Precious Metals) (2) Body Sides – Nova/RNB , Platinum or Culinary Series – Sealed Burner. (Excludes Pearl, Luminous & Aluminum)	\$ 765	\$ 880
KN-CF	Knob: Specialty Finish (Matte RAL, Textured RAL or Precious Metals) – Factory Installed .	\$ 185 ea	\$ 215 ea
SIDES-CC	Body Sides: Custom Color (2) Body Sides. MUST be ordered with 24” – 60” Custom Color appliance.	\$ 765	\$ 880
KN-CC	Knob: Custom Color Knob – Factory Installed. MUST be ordered with 24” – 60” Custom Color appliance.	\$ 200 ea	\$ 230 ea
<b>PLATING OPTIONS:</b>			
KN-PLT	Knob: Plated Trim	\$ 250 ea	\$ 290 ea
BZ-PLT	Bezel: Plated Trim	\$ 175 ea	\$ 200 ea
<b>ACCESSORIES:</b>			
IT24BSP	24” Island Trim Backguard for Platinum, Nova (RNB) and RCS Open Burner Ranges	\$ 565	\$ 650
IT30BSP	30” Island Trim Backguard for Platinum, Nova (RNB) and RCS Open Burner Ranges	\$ 565	\$ 650
IT36BSP	36” Island Trim Backguard for Platinum, Nova (RNB) and RCS Open Burner Ranges	\$ 665	\$ 765
IT48BSP	48” Island Trim Backguard for Platinum, Nova (RNB) and RCS Open Burner Ranges	\$ 955	\$ 1,100
IT60BSP	60” Island Trim Backguard for Platinum, Nova (RNB) and RCS Open Burner Ranges	\$ 1,210	\$ 1,390
IT24SB	24” Island Trim Backguard for RCS Sealed Burner Ranges	\$ 565	\$ 650
IT30SB	30” Island Trim Backguard for RCS Sealed Burner Ranges	\$ 565	\$ 650
IT36SB	36” Island Trim Backguard for RCS Sealed Burner Ranges	\$ 665	\$ 765
IT48SB	48” Island Trim Backguard for RCS Sealed Burner Ranges	\$ 955	\$ 1,100
KN-SS	Knob: Brushed Stainless Steel	\$ 115 ea	\$ 130 ea
KN-BLK	Standard Black Knob	\$ 115 ea	\$ 130 ea
BZ-SS	Bezel: Brushed Stainless Steel	\$ 65 ea	\$ 75 ea
EXTN RACK 24	Full Extension Rack for 24” Freestanding Ranges & Wall Ovens	\$ 550	\$ 635
EXTN RACK 30	Full Extension Rack for 30” Freestanding Ranges & Wall Ovens	\$ 590	\$ 680
EXTN RACK 36	Full Extension Rack for 36” Freestanding Ranges & Wall Ovens	\$ 620	\$ 715
704406	Standard Oven Rack for 24” Freestanding Ranges & Wall Ovens	\$ 120	\$ 140
704405	Standard Oven Rack for 30” Freestanding Ranges & Wall Ovens	\$ 155	\$ 180
704402	Standard Oven Rack for 36” Freestanding Ranges & Wall Ovens	\$ 175	\$ 200
704407	Standard Oven Rack for 48” Freestanding Range Small Oven	\$ 115	\$ 130
731202	Rotating Caster (w/o Brake – Not Installed) 24” – 36” units require 2 ea   48” – 60” units require 3 ea.	\$ 145 ea	\$ 165 ea
731201	Locking Caster (w/ Brake – Not Installed) 24” – 36” units require 2 ea   48” – 60” units require 3 ea.	\$ 160 ea	\$ 185 ea
723101	Standard Leg 2.5” Tall (Not Installed) 24” – 36” units require 4 ea   48” – 60” units require 6 ea.	\$ 200 ea	\$ 230 ea
723102	High Leg 5.5” Tall (Not Installed) 24” – 36” units require 4 ea   48” – 60” units require 6 ea.	\$ 220 ea	\$ 255 ea
BSPICBG12	Interchangeable Griddle Charbroiler – 4 piece	\$ 1,315	\$ 1,510
WOK RING	Wok Ring (Sealed Burner & Drop-in Cooktops)	\$ 175	\$ 200



# RANGETOPS & INDUCTION COOKTOP

Get the Look: 48" Nova Series Rangetop with 12" Griddle

## RANGETOPS: PLATINUM SERIES



Simmer 15,000 18,000 15,000 18,000

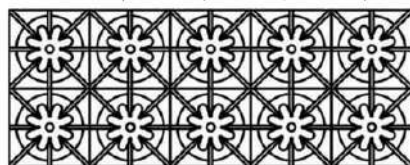

22,000 25,000 22,000 25,000 22,000

### FEATURES:

- 25,000 BTU PrimaNova™ burners
- All burners, plus Interchangeable Griddle and Charbroiler accessory
- Precise 130° simmer burner
- Integrated wok cooking
- Handcrafted in Pennsylvania since 1880

### PRODUCT SPECIFICATIONS:

- Unit Dimensions: 59.875"W x 24"D x 8.625"H
- Top Burner Power: 25,000 BTUs
- Simmer Burner: 9,000 BTUs
- Electrical Reqs: 120V, 60Hz, 15 AMPS, 1PH
- Gas Pressure: NAT: 5.0" WC, LP 10.0" WC
- Gas Line Size: ¾"
- Unit Weight: 410 lbs.

Model	Description (* Denotes item that must be specified)	UMRP	MSRP
<b>Natural Gas Models: 60" Platinum Series Rangetop</b>			
BSPRT6010B	10 Burners   Nat Gas   Stainless Steel   Std Trim	\$ 10,895	\$ 12,530
BSPRT6010BPLT	10 Burners   Nat Gas   Stainless Steel   Plated Trim*	\$ 12,690	\$ 14,595
<b>LP/Propane Models: 60" Platinum Series Rangetop</b>			
BSPRT6010BL	10 Burners   LP Gas   Stainless Steel   Std Trim	\$ 10,895	\$ 12,530
BSPRT6010BLPLT	10 Burners   LP Gas   Stainless Steel   Plated Trim*	\$ 12,690	\$ 14,595
<b>BACKGUARD OPTIONS   See Page 50 for Additional Customization &amp; Accessory Options</b>			
<b>All BlueStar freestanding appliances must be installed with a UL approved backguard. All units ship standard with a UL approved Island Trim unless otherwise specified.</b>			
BG660BSP	6" Backguard	\$ 1,530	\$ 1,760
BG6017BSP	17" Backguard	\$ 2,480	\$ 2,850
SDHS60BSP	24" High Shelf	\$ 2,900	\$ 3,335
<b>KNOB OPTIONS: (Total Knobs: 10)</b>			
KN-BLK	Standard Black Knob <i>(Must be ordered with unit)</i>	N/C	N/C
KN-C	Knob: Standard 190 RAL Color	\$ 115 ea	\$ 130 ea
BZ-C	Bezel: Standard 190 RAL Color	\$ 70 ea	\$ 80 ea
KN-CF	Knob: Spec Finish (Matte RAL, Textured RAL or Prec Metals)	\$ 185 ea	\$ 215 ea
KN-PLT	Knob: Plated Trim (See options below)	\$ 250 ea	\$ 290 ea
<b>PLATED TRIM OPTIONS: (Includes bezels and logo)</b>			
Antique Brass, Brushed Brass, Polished Brass, Antique Copper, Brushed Copper, Polished Copper, Chrome, Oil Rubbed Bronze & Pewter			



Simmer 15,000 15,000 18,000

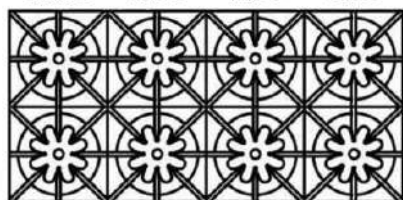

22,000 25,000 25,000 22,000

### FEATURES:

- 25,000 BTU PrimaNova™ burners
- All burners, plus Interchangeable Griddle and Charbroiler accessory
- Precise 130° simmer burner
- Integrated wok cooking
- Handcrafted in Pennsylvania since 1880

### PRODUCT SPECIFICATIONS:

- Unit Dimensions: 47.875"W x 24"D x 8.625"H
- Top Burner Power: 25,000 BTUs
- Simmer Burner: 9,000 BTUs
- Electrical Reqs: 120V, 60Hz, 15 AMPS, 1PH
- Gas Pressure: NAT: 5.0" WC, LP 10.0" WC
- Gas Line Size: ¾"
- Unit Weight: 345 lbs.

Model	Description (* Denotes item that must be specified)	UMRP	MSRP
<b>Natural Gas Models: 48" Platinum Series Rangetop</b>			
BSPRT488B	8 Burners   Nat Gas   Stainless Steel   Std Trim	\$ 7,595	\$ 8,735
BSPRT488BPLT	8 Burners   Nat Gas   Stainless Steel   Plated Trim*	\$ 9,090	\$ 10,455
<b>LP/Propane Models: 48" Platinum Series Rangetop,</b>			
BSPRT488BL	8 Burners   LP Gas   Stainless Steel   Std Trim	\$ 7,595	\$ 8,735
BSPRT488BLPLT	8 Burners   LP Gas   Stainless Steel   Plated Trim*	\$ 9,090	\$ 10,455
<b>BACKGUARD OPTIONS   See Page 50 for Additional Customization &amp; Accessory Options</b>			
<b>All BlueStar freestanding appliances must be installed with a UL approved backguard. All units ship standard with a UL approved Island Trim unless otherwise specified.</b>			
BG648BSP	6" Backguard	\$ 1,040	\$ 1,195
BG4817BSP	17" Backguard	\$ 2,180	\$ 2,505
SDHS48BSP	24" High Shelf	\$ 2,340	\$ 2,690
<b>KNOB OPTIONS: (Total Knobs: 8)</b>			
KN-BLK	Standard Black Knob <i>(Must be ordered with unit)</i>	N/C	N/C
KN-C	Knob: Standard 190 RAL Color	\$ 115 ea	\$ 130 ea
BZ-C	Bezel: Standard 190 RAL Color	\$ 70 ea	\$ 80 ea
KN-CF	Knob: Spec Finish (Matte RAL, Textured RAL or Prec Metals)	\$ 185 ea	\$ 215 ea
KN-PLT	Knob: Plated Trim (See options below)	\$ 250 ea	\$ 290 ea
<b>PLATED TRIM OPTIONS: (Includes bezels and logo)</b>			
Antique Brass, Brushed Brass, Polished Brass, Antique Copper, Brushed Copper, Polished Copper, Chrome, Oil Rubbed Bronze & Pewter			

## RANGETOPS: PLATINUM SERIES

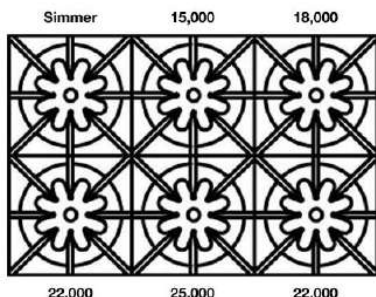

### FEATURES:

- 25,000 BTU PrimaNova™ burners
- All burners, plus Interchangeable Griddle and Charbroiler accessory
- Precise 130° simmer burner
- Integrated wok cooking
- Handcrafted in Pennsylvania since 1880

### PRODUCT SPECIFICATIONS:

- Unit Dimensions: 35.875" W x 24" D x 8.625" H
- Top Burner Power: 25,000 BTUs
- Simmer Burner: 9,000 BTUs
- Electrical Reqs: 120V, 60Hz, 15 AMPS, 1PH
- Gas Pressure: NAT: 5.0" WC, LP 10.0" WC
- Gas Line Size: ½"
- Unit Weight: 285 lbs.

Model	Description (* Denotes item that must be specified)	UMRP	MSRP
<b>Natural Gas Models: 36" Platinum Series Rangetop</b>			
BSPRT366B	6 Burners   Nat Gas   Stainless Steel   Std Trim	\$ 6,395	\$ 7,355
BSPRT366BPLT	6 Burners   Nat Gas   Stainless Steel   Plated Trim*	\$ 7,490	\$ 8,615
<b>LP/Propane Models: 36" Platinum Series Rangetop</b>			
BSPRT366BL	6 Burners   LP Gas   Stainless Steel   Std Trim	\$ 6,395	\$ 7,355
BSPRT366BLPLT	6 Burners   LP Gas   Stainless Steel   Plated Trim*	\$ 7,490	\$ 8,615
<b>BACKGUARD OPTIONS   See Page 50 for Additional Customization &amp; Accessory Options</b>			
<b>All BlueStar freestanding appliances must be installed with a UL approved backguard. All units ship standard with a UL approved Island Trim unless otherwise specified.</b>			
BG636BSP	6" Backguard	\$ 720	\$ 830
BG3617BSP	17" Backguard	\$ 1,460	\$ 1,680
SDHS36BSP	24" High Shelf	\$ 1,690	\$ 1,945
<b>KNOB OPTIONS: (Total Knobs: 6)</b>			
KN-BLK	Standard Black Knob ( <i>Must be ordered with unit</i> )	N/C	N/C
KN-C	Knob: Standard 190 RAL Color	\$ 115 ea	\$ 130 ea
BZ-C	Bezel: Standard 190 RAL Color	\$ 70 ea	\$ 80 ea
KN-CF	Knob: Spec Finish (Matte RAL, Textured RAL or Prec Metals)	\$ 185 ea	\$ 215 ea
KN-PLT	Knob: Plated Trim (See options below)	\$ 250 ea	\$ 290 ea
<b>PLATED TRIM OPTIONS: (Includes bezels and logo)</b>			
Antique Brass, Brushed Brass, Polished Brass, Antique Copper, Brushed Copper, Polished Copper, Chrome, Oil Rubbed Bronze & Pewter			

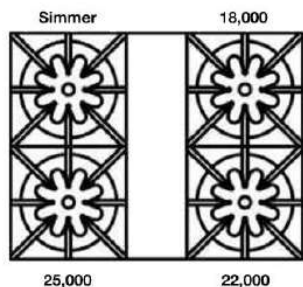

### FEATURES:

- 25,000 BTU PrimaNova™ burners
- All burners, plus Interchangeable Griddle and Charbroiler accessory
- Precise 130° simmer burner
- Integrated wok cooking
- Handcrafted in Pennsylvania since 1880

### PRODUCT SPECIFICATIONS:

- Unit Dimensions: 29.875" W x 24" D x 8.625" H
- Top Burner Power: 25,000 BTUs
- Simmer Burner: 9,000 BTUs
- Electrical Reqs: 120V, 60Hz, 15 AMPS, 1PH
- Gas Pressure: NAT: 5.0" WC, LP 10.0" WC
- Gas Line Size: ½"
- Unit Weight: 235 lbs.

Model	Description (* Denotes item that must be specified)	UMRP	MSRP
<b>Natural Gas Models: 30" Platinum Series Rangetop</b>			
BSPRT304B	4 Burners   Nat Gas   Stainless Steel   Std Trim	\$ 5,795	\$ 6,665
BSPRT304BPLT	4 Burners   Nat Gas   Stainless Steel   Plated Trim*	\$ 6,590	\$ 7,580
<b>LP/Propane Models: 30" Platinum Series Rangetop</b>			
BSPRT304BL	4 Burners   LP Gas   Stainless Steel   Std Trim	\$ 5,795	\$ 6,665
BSPRT304BLPLT	4 Burners   LP Gas   Stainless Steel   Plated Trim*	\$ 6,590	\$ 7,580
<b>BACKGUARD OPTIONS   See Page 50 for Additional Customization &amp; Accessory Options</b>			
<b>All BlueStar freestanding appliances must be installed with a UL approved backguard. All units ship standard with a UL approved Island Trim unless otherwise specified.</b>			
BG630BSP	6" Backguard	\$ 605	\$ 695
BG3017BSP	17" Backguard	\$ 1,120	\$ 1,290
SDHS30BSP	24" High Shelf	\$ 1,460	\$ 1,680
<b>KNOB OPTIONS: (Total Knobs: 4)</b>			
KN-BLK	Standard Black Knob ( <i>Must be ordered with unit</i> )	N/C	N/C
KN-C	Knob: Standard 190 RAL Color	\$ 115 ea	\$ 130 ea
BZ-C	Bezel: Standard 190 RAL Color	\$ 70 ea	\$ 80 ea
KN-CF	Knob: Spec Finish (Matte RAL, Textured RAL or Prec Metals)	\$ 185 ea	\$ 215 ea
KN-PLT	Knob: Plated Trim (See options below)	\$ 250 ea	\$ 290 ea
<b>PLATED TRIM OPTIONS: (Includes bezels and logo)</b>			
Antique Brass, Brushed Brass, Polished Brass, Antique Copper, Brushed Copper, Polished Copper, Chrome, Oil Rubbed Bronze & Pewter			

## RANGETOPS: PLATINUM SERIES & INDUCTION

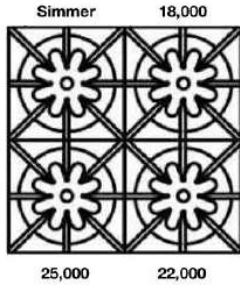

### FEATURES:

- 25,000 BTU PrimaNova™ burners
- All burners, plus Interchangeable Griddle and Charbroiler accessory
- Precise 130° simmer burner
- Integrated wok cooking
- Handcrafted in Pennsylvania since 1880

### PRODUCT SPECIFICATIONS:

- Unit Dimensions: 23.875"W x 24"D x 8.625"H
- Top Burner Power: 25,000 BTUs
- Simmer Burner: 9,000 BTUs
- Electrical Reqs: 120V, 60Hz, 15 AMPS, 1PH
- Gas Pressure: NAT: 5.0" WC, LP 10.0" WC
- Gas Line Size: ½"
- Unit Weight: 220 lbs.

Model	Description (* Denotes item that must be specified)	UMRP	MSRP
<b>Natural Gas Models: 24" Platinum Series Rangetop</b>			
BSPRT244B	4 Burners   Nat Gas   Stainless Steel   Std Trim	\$ 5,495	\$ 6,320
BSPRT244BPLT	4 Burners   Nat Gas   Stainless Steel   Plated Trim*	\$ 6,290	\$ 7,235
<b>LP/Propane Models: 24" Platinum Series Rangetop</b>			
BSPRT244BL	4 Burners   LP Gas   Stainless Steel   Std Trim	\$ 5,495	\$ 6,320
BSPRT244BLPLT	4 Burners   LP Gas   Stainless Steel   Plated Trim*	\$ 6,290	\$ 7,235
<b>BACKGUARD OPTIONS   See Page 50 for Additional Customization &amp; Accessory Options</b>			
<b>All BlueStar freestanding appliances must be installed with a UL approved backguard. All units ship standard with a UL approved Island Trim unless otherwise specified.</b>			
BG624BSP	6" Backguard	\$ 605	\$ 695
BG2417BSP	17" Backguard	\$ 1,120	\$ 1,290
SDHS24BSP	24" High Shelf	\$ 1,460	\$ 1,680
<b>KNOB OPTIONS: (Total Knobs: 4)</b>			
KN-BLK	Standard Black Knob (Must be ordered with unit)	N/C	N/C
KN-C	Knob: Standard 190 RAL Color	\$ 115 ea	\$ 130 ea
BZ-C	Bezel: Standard 190 RAL Color	\$ 70 ea	\$ 80 ea
KN-CF	Knob: Spec Finish (Matte RAL, Textured RAL or Prec Metals)	\$ 185 ea	\$ 215 ea
KN-PLT	Knob: Plated Trim (See options below)	\$ 250 ea	\$ 290 ea
<b>PLATED TRIM OPTIONS: (Includes bezels and logo)</b>			
Antique Brass, Brushed Brass, Polished Brass, Antique Copper, Brushed Copper, Polished Copper, Chrome, Oil Rubbed Bronze & Pewter			



### FEATURES:

- Features a searing 5,500 Watt burner
- Rapid "Heat Accelerator" technology for no-wait cooking, heats 50% faster than gas
- Exceptional temperature control with 12 cooking settings
- Maximum cooking surface fits up to 5 pots or pans
- Seamless 2-burner bridging technology, perfect for grilling or searing
- Gentle simmer capabilities, down to 200 degrees
- Perfect "Keep Warm" (150 degrees) feature for entertaining ease
- Intuitive design with sleek push-to-turn knobs and easy-to-clean, scratch resistant, non-staining glass top
- Safety knob lock feature & no-touch hot surface indicator light
- Customize with 190 color knobs and 10 metal finishes

Model	Description (* Denotes item that must be specified)	UMRP	MSRP
<b>Natural Gas Models: 30" Drop-In Cooktop</b>			
BSP36INDCKT	5 Burner   Induction   Std Trim	\$ 4,395	\$ 5,055
BSP36INDCKTPLT	5 Burner   Induction   Plated Trim*	\$ 5,490	\$ 6,315
<b>KNOB OPTIONS: (Total Knobs: 5)</b>			
KN-C	Knob: Standard 190 RAL Color	\$ 115 ea	\$ 130 ea
BZ-C	Bezel: Standard 190 RAL Color	\$ 70 ea	\$ 80 ea
KN-CF	Knob: Spec Finish (Matte RAL, Textured RAL or Prec Metals)	\$ 185 ea	\$ 215 ea
KN-PLT	Knob: Plated Trim (See options below)	\$ 250 ea	\$ 290 ea
<b>PLATED TRIM OPTIONS: (Includes bezels and logo)</b>			
Antique Brass, Brushed Brass, Polished Brass, Antique Copper, Brushed Copper, Polished Copper, Chrome, Oil Rubbed Bronze & Pewter			

### PRODUCT SPECIFICATIONS:

- Unit Dims: 36 1/16"W x 21 1/8"D x 3 7/8"H
- 31/64" from counter to top of glass
- Electrical: 230V, 50 amp, 50/60Hz
- Connection: 2 Phases
- Diameter: 3 x 10 AWG (Provided)

## RANGETOPS: 60" NOVA (RNB) SERIES



Simmer 15,000 15,000 15,000 15,000

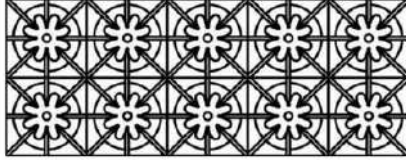

22,000 15,000 15,000 15,000 22,000

### FEATURES:

- 22,000 BTU UltraNova™ burners & 15,000 BTU Nova™ burners
- Precise 130° simmer burner
- Available with all burners or add integrated griddle, charbroiler or French top
- Integrated wok cooking
- Handcrafted in Pennsylvania since 1880

### PRODUCT SPECIFICATIONS:

- Unit Dimensions: 59.875"W x 24"D x 8.625"H
- Top Burner Power: 22,000 BTUs
- Simmer Burner: 9,000 BTUs
- Electrical Reqs: 120V, 60Hz, 15 AMPS, 1PH
- Gas Pressure: NAT: 5.0" WC, LP 10.0" WC
- Gas Line Size: 3/4"
- Unit Weight: 330 lbs.

Model	Description (* Denotes item that must be specified)	UMRP	MSRP
<b>Natural Gas Models: 60" Nova Series Rangetop</b>			
RGTNB6010BV2	10 Burners   Nat Gas   Stainless Steel   Std Trim	\$ 10,195	\$ 11,725
RGTNB6010BV2PLT	10 Burners   Nat Gas   Stainless Steel   Plated Trim*	\$ 11,990	\$ 13,790
<b>LP/Propane Models: 60" Nova Series Rangetop</b>			
RGTNB6010BV2L	10 Burners   LP Gas   Stainless Steel   Std Trim	\$ 10,195	\$ 11,725
RGTNB6010BV2LPLT	10 Burners   LP Gas   Stainless Steel   Plated Trim*	\$ 11,990	\$ 13,790
<b>BACKGUARD OPTIONS   See Page 50 for Additional Customization &amp; Accessory Options</b>			
<b>All BlueStar freestanding appliances must be installed with a UL approved backguard. All units ship standard with a UL approved Island Trim unless otherwise specified.</b>			
BG660BSP	6" Backguard	\$ 1,530	\$ 1,760
BG6017BSP	17" Backguard	\$ 2,480	\$ 2,850
SDHS60BSP	24" High Shelf	\$ 2,900	\$ 3,335
<b>KNOB OPTIONS: (Total Knobs: 10)</b>			
KN-BLK	Standard Black Knob <i>(Must be ordered with unit)</i>	N/C	N/C
KN-C	Knob: Standard 190 RAL Color	\$ 115 ea	\$ 130 ea
BZ-C	Bezel: Standard 190 RAL Color	\$ 70 ea	\$ 80 ea
KN-CF	Knob: Spec Finish (Matte RAL, Textured RAL or Prec Metals)	\$ 185 ea	\$ 215 ea
KN-PLT	Knob: Plated Trim (See options below)	\$ 250 ea	\$ 290 ea
<b>PLATED TRIM OPTIONS: (Includes bezels and logo)</b>			
Antique Brass, Brushed Brass, Polished Brass, Antique Copper, Brushed Copper, Polished Copper, Chrome, Oil Rubbed Bronze & Pewter			

### 60" Nova (RNB) Rangetop with 12" Griddle



Simmer 15,000 15,000 15,000

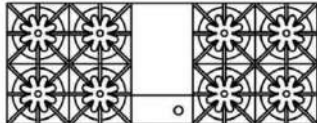

22,000 15,000 15,000 15,000 22,000

Model	Description (* - Denotes item that must be specified)	UMRP	MSRP
<b>Natural Gas Models: 60" Nova Series Rangetop</b>			
RGTNB608GV2	8 Burner   12" Griddle   Nat Gas   Stainless Steel   Standard Trim	\$ 9,985	\$ 11,380
RGTNB608GV2PLT	8 Burner   12" Griddle   Nat Gas   Stainless Steel   Plated Trim*	\$ 11,690	\$ 13,445
<b>LP/Propane Models: 60" Nova Series Rangetop</b>			
RGTNB608GV2L	8 Burner   12" Griddle   LP Gas   Stainless Steel   Standard Trim	\$ 9,985	\$ 11,380
RGTNB608GV2LPLT	8 Burner   12" Griddle   LP Gas   Stainless Steel   Plated Trim*	\$ 11,690	\$ 13,445
<b>Customization &amp; Accessory Options: (See page 43)   Total Knobs: 9</b>			

### 60" Nova (RNB) Rangetop with 12" Charbroiler



Simmer 15,000 15,000 15,000

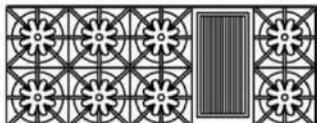

22,000 15,000 15,000 15,000 22,000

Model	Description (* - Denotes item that must be specified)	UMRP	MSRP
<b>Natural Gas Models: 60" Nova Series Rangetop with 12" Charbroiler</b>			
RGTNB608CBV2	8 Burner   12" Charbroiler   Nat Gas   Stainless Steel   Standard Trim	\$ 9,985	\$ 11,380
RGTNB608CBV2PLT	8 Burner   12" Charbroiler   Nat Gas   Stainless Steel   Plated Trim*	\$ 11,690	\$ 13,445
<b>LP/Propane Models: 60" Nova Series Rangetop with 12" Charbroiler</b>			
RGTNB608CBV2L	8 Burner   12" Charbroiler   LP Gas   Stainless Steel   Standard Trim	\$ 9,985	\$ 11,380
RGTNB608CBV2LPLT	8 Burner   12" Charbroiler   LP Gas   Stainless Steel   Plated Trim*	\$ 11,690	\$ 13,445
<b>Customization &amp; Accessory Options: (See page 43)   Total Knobs: 9</b>			

## RANGETOPS: 60" NOVA (RNB) SERIES

**60" Nova (RNB) Rangetop  
with 24" Griddle**

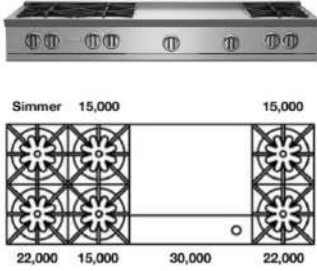

Model	Description (* - Denotes item that must be specified)	UMRP	MSRP
<b>Natural Gas Models: 60" Nova Series Rangetop with 24" Griddle</b>			
RGTNB606GV2	6 Burner   24" Griddle   Nat Gas   Stainless Steel   Standard Trim	\$ 10,195	\$ 11,725
RGTNB606GV2PLT	6 Burner   24" Griddle   Nat Gas   Stainless Steel   Plated Trim*	\$ 11,990	\$ 13,790
<b>LP/Propane Models: 60" Nova Series Rangetop with 24" Griddle</b>			
RGTNB606GV2L	6 Burner   24" Griddle   LP Gas   Stainless Steel   Standard Trim	\$ 10,195	\$ 11,725
RGTNB606GV2LPLT	6 Burner   24" Griddle   LP Gas   Stainless Steel   Plated Trim*	\$ 11,990	\$ 13,790
<b>Customization &amp; Accessory Options: (See page 43)   Total Knobs: 8</b>			

**60" Nova (RNB) Rangetop  
with 24" Charbroiler**

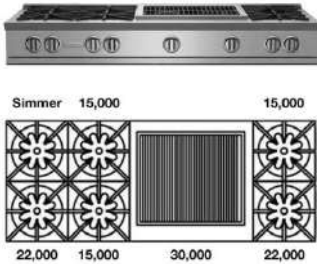

Model	Description (* - Denotes item that must be specified)	UMRP	MSRP
<b>Natural Gas Models: 60" Nova Series Rangetop with 24" Charbroiler</b>			
RGTNB606CBV2	6 Burner   24" Charbroiler   Nat Gas   Stainless Steel   Standard Trim	\$ 10,195	\$ 11,725
RGTNB606CBV2PLT	6 Burner   24" Charbroiler   Nat Gas   Stainless Steel   Plated Trim*	\$ 11,990	\$ 13,790
<b>Natural Gas Models: 60" Nova Series Rangetop with 24" Charbroiler</b>			
RGTNB606CBV2L	6 Burner   24" Charbroiler   LP Gas   Stainless Steel   Standard Trim	\$ 10,195	\$ 11,725
RGTNB606CBV2LPLT	6 Burner   24" Charbroiler   LP Gas   Stainless Steel   Plated Trim*	\$ 11,990	\$ 13,790
<b>Customization &amp; Accessory Options: (See page 43)   Total Knobs: 8</b>			

**60" Nova (RNB) Rangetop  
with 12" Griddle & Charbroiler**

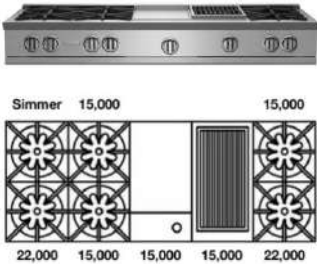

Model	Description (* - Denotes item that must be specified)	UMRP	MSRP
<b>Natural Gas Models: 60" Nova Series Rangetop with 12" Griddle &amp; Charbroiler</b>			
RGTNB4606GCBV2	6 Burner   12" Griddle & Char Br.   Nat Gas   Stainless Steel   Standard Trim	\$ 10,695	\$ 12,300
RGTNB606GCBV2PLT	6 Burner   12" Griddle & Char Br.   Nat Gas   Stainless Steel   Plated Trim*	\$ 12,490	\$ 14,365
<b>LP/Propane Models: 60" Nova Series Rangetop with 12" Griddle &amp; Charbroiler</b>			
RGTNB606GCBV2L	6 Burner   24" Griddle   LP Gas   Stainless Steel   Standard Trim	\$ 10,195	\$ 11,725
RGTNB606GCBV2LPLT	6 Burner   24" Griddle   LP Gas   Stainless Steel   Plated Trim*	\$ 11,990	\$ 13,790
<b>Customization &amp; Accessory Options: (See page 43)   Total Knobs: 8</b>			

**60" Nova (RNB) Rangetop  
with 24" French Top**

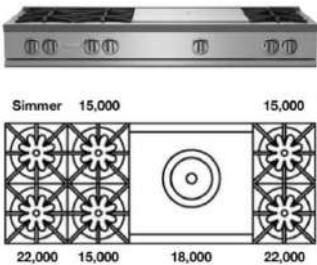

Model	Description (* - Denotes item that must be specified)	UMRP	MSRP
<b>Natural Gas Models: 60" Nova Series Rangetop with 24" French Top</b>			
RGTNB606FTV2	6 Burner   24" French Top   Nat Gas   Stainless Steel   Standard Trim	\$ 10,995	\$ 12,645
RGTNB606FTV2PLT	6 Burner   24" French Top   Nat Gas   Stainless Steel   Plated Trim*	\$ 12,790	\$ 14,710
<b>LP/Propane Models: 60" Nova Series Rangetop with 24" French Top</b>			
RGTNB606FTV2L	6 Burner   24" French Top   LP Gas   Stainless Steel   Standard Trim	\$ 10,995	\$ 12,645
RGTNB606FTV2LPLT	6 Burner   24" French Top   LP Gas   Stainless Steel   Plated Trim*	\$ 12,790	\$ 14,710
<b>Customization &amp; Accessory Options: (See page 50)   Total Knobs: 7</b>			

## RANGETOPS: 48" NOVA (RNB) SERIES



Simmer 15,000 15,000 15,000

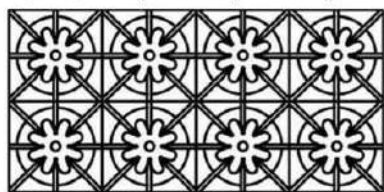

22,000 15,000 15,000 22,000

### FEATURES:

- 22,000 BTU UltraNova™ burners & 15,000 BTU Nova™ burners
- Precise 130° simmer burner
- Available with all burners or add integrated griddle, charbroiler or French top
- Integrated wok cooking
- Handcrafted in Pennsylvania since 1880

### PRODUCT SPECIFICATIONS:

- Unit Dimensions: 47.875"W x 24"D x 8.625"H
- Top Burner Power: 22,000 BTUs
- Simmer Burner: 9,000 BTUs
- Electrical Reqs: 120V, 60Hz, 15 AMPS, 1PH
- Gas Pressure: NAT: 5.0" WC, LP 10.0" WC
- Gas Line Size: 3/4"
- Unit Weight: 295 lbs.

Model	Description (* Denotes item that must be specified)	UMRP	MSRP
<b>Natural Gas Models: 48" Nova Series Rangetop</b>			
RGTNB488BV2	8 Burners   Nat Gas   Stainless Steel   Std Trim	\$ 6,395	\$ 7,355
RGTNB488BV2PLT	8 Burners   Nat Gas   Stainless Steel   Plated Trim*	\$ 7,890	\$ 9,075
<b>LP/Propane Models: 48" Nova Series Rangetop</b>			
RGTNB488BV2L	8 Burners   LP Gas   Stainless Steel   Std Trim	\$ 6,395	\$ 7,355
RGTNB488BV2LPLT	8 Burners   LP Gas   Stainless Steel   Plated Trim*	\$ 7,890	\$ 9,075
<b>BACKGUARD OPTIONS   See Page 50 for Additional Customization &amp; Accessory Options</b>			
<b>All BlueStar freestanding appliances must be installed with a UL approved backguard. All units ship standard with a UL approved Island Trim unless otherwise specified.</b>			
BG648BSP	6" Backguard	\$ 1,040	\$ 1,195
BG4817BSP	17" Backguard	\$ 2,180	\$ 2,505
SDHS48BSP	24" High Shelf	\$ 2,340	\$ 2,690
<b>KNOB OPTIONS: (Total Knobs: 8)</b>			
KN-BLK	Standard Black Knob ( <i>Must be ordered with unit</i> )	N/C	N/C
KN-C	Knob: Standard 190 RAL Color	\$ 115 ea	\$ 130 ea
BZ-C	Bezel: Standard 190 RAL Color	\$ 70 ea	\$ 80 ea
KN-CF	Knob: Spec Finish (Matte RAL, Textured RAL or Prec Metals)	\$ 185 ea	\$ 215 ea
KN-PLT	Knob: Plated Trim (See options below)	\$ 250 ea	\$ 290 ea
<b>PLATED TRIM OPTIONS: (Includes bezels and logo)</b>			
Antique Brass, Brushed Brass, Polished Brass, Antique Copper, Brushed Copper, Polished Copper, Chrome, Oil Rubbed Bronze & Pewter			

### 48" Nova (RNB) Rangetop with 12" Griddle



Simmer 15,000 15,000

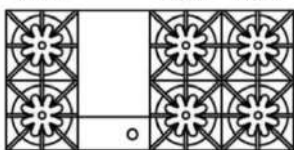

22,000 15,000 15,000 22,000

Model	Description (* - Denotes item that must be specified)	UMRP	MSRP
<b>Natural Gas Models: 48" Nova Series Rangetop with 12" Griddle</b>			
RGTNB486GV2	6 Burner   12" Griddle   Nat Gas   Stainless Steel   Standard Trim	\$ 6,595	\$ 7,585
RGTNB486GV2PLT	6 Burner   12" Griddle   Nat Gas   Stainless Steel   Plated Trim*	\$ 8,090	\$ 9,305
<b>LP/Propane Models: 48" Nova Series Rangetop with 12" Griddle</b>			
RGTNB486GV2L	6 Burner   12" Griddle   LP Gas   Stainless Steel   Standard Trim	\$ 6,595	\$ 7,585
RGTNB486GV2LPLT	6 Burner   12" Griddle   LP Gas   Stainless Steel   Plated Trim*	\$ 8,090	\$ 9,305
<b>Customization &amp; Accessory Options: (See page 45)   Total Knobs: 7</b>			

### 48" Nova (RNB) Rangetop with 12" Charbroiler



Simmer 15,000 15,000

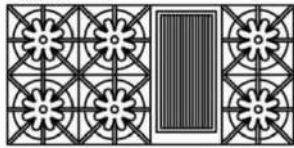

22,000 15,000 15,000 22,000

Model	Description (* - Denotes item that must be specified)	UMRP	MSRP
<b>Natural Gas Models: 48" Nova Series Rangetop with 12" Charbroiler</b>			
RGTNB486CBV2	6 Burner   12" Charbroiler   Nat Gas   Stainless Steel   Standard Trim	\$ 6,595	\$ 7,585
RGTNB486CBV2PLT	6 Burner   12" Charbroiler   Nat Gas   Stainless Steel   Plated Trim*	\$ 8,090	\$ 9,305
<b>LP/Propane Models: 48" Nova Series Rangetop with 12" Charbroiler</b>			
RGTNB486CBV2L	6 Burner   12" Charbroiler   LP Gas   Stainless Steel   Standard Trim	\$ 6,595	\$ 7,585
RGTNB486CBV2LPLT	6 Burner   12" Charbroiler   LP Gas   Stainless Steel   Plated Trim*	\$ 8,090	\$ 9,305
<b>Customization &amp; Accessory Options: (See page 45)   Total Knobs: 7</b>			

## RANGETOPS: 48" NOVA (RNB) SERIES

### 48" Nova (RNB) Rangetop with 24" Griddle

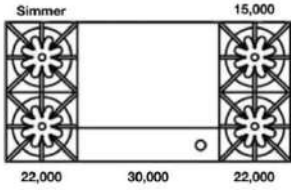

Model	Description (* - Denotes item that must be specified)	UMRP	MSRP
<b>Natural Gas Models: 48" Nova Series Rangetop with 24" Griddle</b>			
RGTNB484GV2	6 Burner   24" Griddle   Nat Gas   Stainless Steel   Standard Trim	\$ 7,195	\$ 8,275
RGTNB484GV2PLT	6 Burner   24" Griddle   Nat Gas   Stainless Steel   Plated Trim*	\$ 8,690	\$ 9,995
<b>LP/Propane Models: 48" Nova Series Rangetop with 24" Griddle</b>			
RGTNB484GV2L	6 Burner   24" Griddle   LP Gas   Stainless Steel   Standard Trim	\$ 7,195	\$ 8,275
RGTNB484GV2LPLT	6 Burner   24" Griddle   LP Gas   Stainless Steel   Plated Trim*	\$ 8,690	\$ 9,995
<b>Customization &amp; Accessory Options: (See page 45)   Total Knobs: 6</b>			

### 48" Nova (RNB) Rangetop with 24" Charbroiler

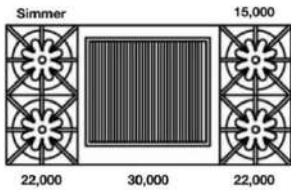

Model	Description (* - Denotes item that must be specified)	UMRP	MSRP
<b>Natural Gas Models: 48" Nova Series Rangetop with 24" Charbroiler</b>			
RGTNB484CBV2	4 Burner   24" Charbroiler   Nat Gas   Stainless Steel   Standard Trim	\$ 7,195	\$ 8,275
RGTNB484CBV2PLT	4 Burner   24" Charbroiler   Nat Gas   Stainless Steel   Plated Trim*	\$ 8,690	\$ 9,995
<b>LP/Propane Models: 48" Nova Series Rangetop with 24" Charbroiler</b>			
RGTNB484CBV2L	4 Burner   24" Charbroiler   LP Gas   Stainless Steel   Standard Trim	\$ 7,195	\$ 8,275
RGTNB484CBV2LPLT	4 Burner   24" Charbroiler   LP Gas   Stainless Steel   Plated Trim*	\$ 8,690	\$ 9,995
<b>Customization &amp; Accessory Options: (See page 45)   Total Knobs: 6</b>			

### 48" Nova (RNB) Rangetop with 12" Griddle & Charbroiler

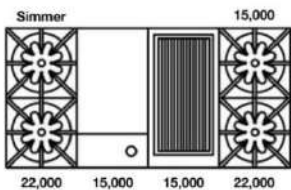

Model	Description (* - Denotes item that must be specified)	UMRP	Model
<b>Natural Gas Models: 48" Nova Series Rangetop with 12" Griddle &amp; Charbroiler</b>			
RGTNB484GCBV2	4 Burner   12" Griddle & Char Br.   Nat Gas   Stainless Steel   Standard Trim	\$ 7,395	\$ 8,505
RGTNB484GCBV2PLT	4 Burner   12" Griddle & Char Br.   Nat Gas   Stainless Steel   Plated Trim*	\$ 8,890	\$ 10,225
<b>LP/Propane Models: 48" Nova Series Rangetop with 12" Griddle &amp; Charbroiler</b>			
RGTNB484GCBV2L	4 Burner   12" Griddle & Char Br.   LP Gas   Stainless Steel   Standard Trim	\$ 7,395	\$ 8,505
RGTNB484GCBV2LPLT	4 Burner   12" Griddle & Char Br.   LP Gas   Stainless Steel   Plated Trim*	\$ 8,890	\$ 10,225
<b>Customization &amp; Accessory Options: (See page 45)   Total Knobs: 6</b>			

### 48" Nova (RNB) Rangetop with 24" French Top

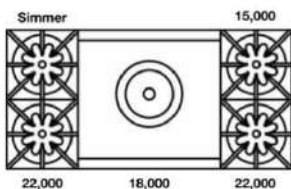

Model	Description (* - Denotes item that must be specified)	UMRP	Model
<b>Natural Gas Models: 48" Nova Series Rangetop with 24" French Top</b>			
RGTNB484FTBV2	4 Burner   24" French Top   Nat Gas   Stainless Steel   Standard Trim	\$ 7,925	\$ 9,115
RGTNB484FTBV2PLT	4 Burner   24" French Top   Nat Gas   Stainless Steel   Plated Trim*	\$ 9,420	\$ 10,835
<b>LP/Propane Models: 48" Nova Series Rangetop with 24" French Top</b>			
RGTNB484FTBV2L	4 Burner   24" French Top   LP Gas   Stainless Steel   Standard Trim	\$ 7,925	\$ 9,115
RGTNB484FTBV2LPLT	4 Burner   24" French Top   LP Gas   Stainless Steel   Plated Trim*	\$ 9,420	\$ 10,835
<b>Customization &amp; Accessory Options: (See page 45)   Total Knobs: 5</b>			

## RANGETOPS: 36" NOVA (RNB) SERIES

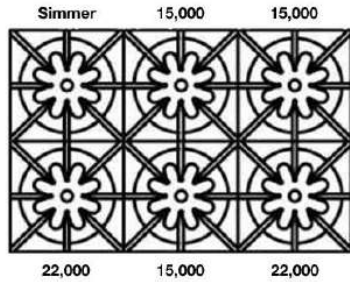

### FEATURES:

- 22,000 BTU UltraNova™ burners & 15,000 BTU Nova™ burners
- Precise 130° simmer burner
- Available with all burners or add integrated griddle, charbroiler or French top
- Integrated wok cooking
- Handcrafted in Pennsylvania since 1880

### PRODUCT SPECIFICATIONS:

- Unit Dimensions: 35.875"W x 24"D x 8.625"H
- Top Burner Power: 22,000 BTUs
- Simmer Burner: 9,000 BTUs
- Electrical Reqs: 120V, 60Hz, 15 AMPS, 1PH
- Gas Pressure: NAT: 5.0" WC, LP 10.0" WC
- Gas Line Size: ½"
- Unit Weight: 220 lbs.

Model	Description (* Denotes item that must be specified)	UMRP	MSRP
<b>Natural Gas Models: 36" Nova Series Rangetop</b>			
RGTNB366BV2	6 Burners   Nat Gas   Stainless Steel   Std Trim	\$ 5,095	\$ 5,860
RGTNB366BV2PLT	6 Burners   Nat Gas   Stainless Steel   Plated Trim*	\$ 6,190	\$ 7,120
<b>LP/Propane Models: 36" Nova Series Rangetop</b>			
RGTNB366BV2L	6 Burners   LP Gas   Stainless Steel   Std Trim	\$ 5,095	\$ 5,860
RGTNB366BV2LPLT	6 Burners   LP Gas   Stainless Steel   Plated Trim*	\$ 6,190	\$ 7,120
<b>BACKGUARD OPTIONS   See Page 50 for Additional Customization &amp; Accessory Options</b>			
<b>All BlueStar freestanding appliances must be installed with a UL approved backguard. All units ship standard with a UL approved Island Trim unless otherwise specified.</b>			
BG636BSP	6" Backguard	\$ 720	\$ 830
BG3617BSP	17" Backguard	\$ 1,460	\$ 1,680
SDHS36BSP	24" High Shelf	\$ 1,690	\$ 1,945
<b>KNOB OPTIONS: (Total Knobs: 6)</b>			
KN-BLK	Standard Black Knob ( <i>Must be ordered with unit</i> )	N/C	N/C
KN-C	Knob: Standard 190 RAL Color	\$ 115 ea	\$ 130 ea
BZ-C	Bezel: Standard 190 RAL Color	\$ 70 ea	\$ 80 ea
KN-CF	Knob: Spec Finish (Matte RAL, Textured RAL or Prec Metals)	\$ 185 ea	\$ 215 ea
KN-PLT	Knob: Plated Trim (See options below)	\$ 250 ea	\$ 290 ea
<b>PLATED TRIM OPTIONS: (Includes bezels and logo)</b>			
Antique Brass, Brushed Brass, Polished Brass, Antique Copper, Brushed Copper, Polished Copper, Chrome, Oil Rubbed Bronze & Pewter			

### 36" Nova (RNB) Rangetop with 12" Griddle

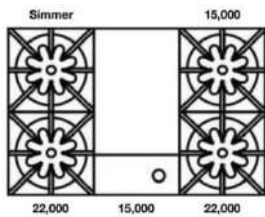

Model	Description (* - Denotes item that must be specified)	UMRP	MSRP
<b>Natural Gas Models: 36" Nova Series Rangetop with 12" Griddle</b>			
RGTNB364GV2	4 Burner   12" Griddle   Nat Gas   Stainless Steel   Standard Trim	\$ 5,795	\$ 6,665
RGTNB364GV2PLT	4 Burner   12" Griddle   Nat Gas   Stainless Steel   Plated Trim*	\$ 6,890	\$ 7,925
<b>LP/Propane Models: 36" Nova Series Rangetop with 12" Griddle</b>			
RGTNB364GV2L	4 Burner   12" Griddle   LP Gas   Stainless Steel   Standard Trim	\$ 5,795	\$ 6,665
RGTNB364GV2LPLT	4 Burner   12" Griddle   LP Gas   Stainless Steel   Plated Trim*	\$ 6,890	\$ 7,925
<b>Customization &amp; Accessory Options: (See page 47)   Total Knobs: 5</b>			

### 36" Nova (RNB) Rangetop with 12" Charbroiler

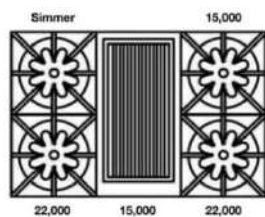

Model	Description (* - Denotes item that must be specified)	UMRP	MSRP
<b>Natural Gas Models: 36" Nova Series Rangetop with 12" Charbroiler</b>			
RGTNB364CBV2	4 Burner   12" Charbroiler   Nat Gas   Stainless Steel   Standard Trim	\$ 5,495	\$ 6,320
RGTNB364CBV2PLT	4 Burner   12" Charbroiler   Nat Gas   Stainless Steel   Plated Trim*	\$ 6,590	\$ 7,580
<b>LP/Propane Models: 36" Nova Series Rangetop with 12" Charbroiler</b>			
RGTNB364CBV2L	4 Burner   12" Charbroiler   LP Gas   Stainless Steel   Standard Trim	\$ 5,495	\$ 6,320
RGTNB364CBV2LPLT	4 Burner   12" Charbroiler   LP Gas   Stainless Steel   Plated Trim*	\$ 6,590	\$ 7,580
<b>Customization &amp; Accessory Options: (See page 47)   Total Knobs: 5</b>			

## RANGETOPS: 30" & 24" NOVA (RNB) SERIES

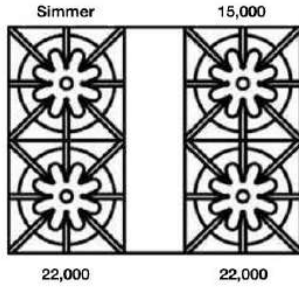

### FEATURES:

- 22,000 BTU UltraNova™ burners & 15,000 BTU Nova™ burners
- Precise 130° simmer burner
- Integrated wok cooking
- Handcrafted in Pennsylvania since 1880

### PRODUCT SPECIFICATIONS:

- Unit Dimensions: 29.875"W x 24"D x 8.625"H
- Top Burner Power: 22,000 BTUs
- Simmer Burner: 9,000 BTUs
- Electrical Reqs: 120V, 60Hz, 15 AMPS, 1PH
- Gas Pressure: NAT: 5.0" WC, LP 10.0" WC
- Gas Line Size: ½"
- Unit Weight: 200 lbs.

Model	Description (* Denotes item that must be specified)	UMRP	MSRP
<b>Natural Gas Models: 30" Nova Series Rangetop</b>			
RGTNB304BV2	4 Burners   Nat Gas   Stainless Steel   Std Trim	\$ 4,795	\$ 5,515
RGTNB304BV2PLT	4 Burners   Nat Gas   Stainless Steel   Plated Trim*	\$ 5,590	\$ 6,430
<b>LP/Propane Models: 30" Nova Series Rangetop</b>			
RGTNB304BV2L	4 Burners   LP Gas   Stainless Steel   Std Trim	\$ 4,795	\$ 5,515
RGTNB304BV2LPLT	4 Burners   LP Gas   Stainless Steel   Plated Trim*	\$ 5,590	\$ 6,430
<b>BACKGUARD OPTIONS   See Page 50 for Additional Customization &amp; Accessory Options</b>			
<b>All BlueStar freestanding appliances must be installed with a UL approved backguard. All units ship standard with a UL approved Island Trim unless otherwise specified.</b>			
BG630BSP	6" Backguard	\$ 605	\$ 695
BG3017BSP	17" Backguard	\$ 1,120	\$ 1,290
SDHS30BSP	24" High Shelf	\$ 1,460	\$ 1,680
<b>KNOB OPTIONS: (Total Knobs: 4)</b>			
KN-BLK	Standard Black Knob <i>(Must be ordered with unit)</i>	N/C	N/C
KN-C	Knob: Standard 190 RAL Color	\$ 115 ea	\$ 130 ea
BZ-C	Bezel: Standard 190 RAL Color	\$ 70 ea	\$ 80 ea
KN-CF	Knob: Spec Finish (Matte RAL, Textured RAL or Prec Metals)	\$ 185 ea	\$ 215 ea
KN-PLT	Knob: Plated Trim (See options below)	\$ 250 ea	\$ 290 ea
<b>PLATED TRIM OPTIONS: (Includes bezels and logo)</b>			
Antique Brass, Brushed Brass, Polished Brass, Antique Copper, Brushed Copper, Polished Copper, Chrome, Oil Rubbed Bronze & Pewter			

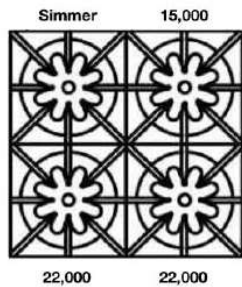

### FEATURES:

- 22,000 BTU UltraNova™ burners & 15,000 BTU Nova™ burners
- Precise 130° simmer burner
- Available with all burners or all integrated griddle, charbroiler or French top
- Integrated wok cooking

### PRODUCT SPECIFICATIONS:

- Unit Dimensions: 23.875"W x 24"D x 8.625"H
- Top Burner Power: 22,000 BTUs
- Simmer Burner: 9,000 BTUs
- Electrical Reqs: 120V, 60Hz, 15 AMPS, 1PH
- Gas Pressure: NAT: 5.0" WC, LP 10.0" WC
- Gas Line Size: ½"
- Unit Weight: 185 lbs.

Model	Description (* Denotes item that must be specified)	UMRP	MSRP
<b>Natural Gas Models: 24" Nova Series Rangetop</b>			
RGTNB244BV2	4 Burners   Nat Gas   Stainless Steel   Std Trim	\$ 4,695	\$ 5,400
RGTNB244BV2PLT	4 Burners   Nat Gas   Stainless Steel   Plated Trim*	\$ 5,490	\$ 6,315
<b>LP/Propane Models: 24" Nova Series Rangetop</b>			
RGTNB244BV2L	4 Burners   LP Gas   Stainless Steel   Std Trim	\$ 4,695	\$ 5,400
RGTNB244BV2LPLT	4 Burners   LP Gas   Stainless Steel   Plated Trim*	\$ 5,490	\$ 6,315
<b>BACKGUARD OPTIONS   See Page 50 for Additional Customization &amp; Accessory Options</b>			
<b>All BlueStar freestanding appliances must be installed with a UL approved backguard. All units ship standard with a UL approved Island Trim unless otherwise specified.</b>			
BG624BSP	6" Backguard	\$ 605	\$ 695
BG2417BSP	17" Backguard	\$ 1,120	\$ 1,290
SDHS24BSP	24" High Shelf	\$ 1,460	\$ 1,680
<b>KNOB OPTIONS: (Total Knobs: 4)</b>			
KN-BLK	Standard Black Knob <i>(Must be ordered with unit)</i>	N/C	N/C
KN-C	Knob: Standard 190 RAL Color	\$ 115 ea	\$ 130 ea
BZ-C	Bezel: Standard 190 RAL Color	\$ 70 ea	\$ 80 ea
KN-CF	Knob: Spec Finish (Matte RAL, Textured RAL or Prec Metals)	\$ 185 ea	\$ 215 ea
KN-PLT	Knob: Plated Trim (See options below)	\$ 250 ea	\$ 290 ea
<b>PLATED TRIM OPTIONS: (Includes bezels and logo)</b>			
Antique Brass, Brushed Brass, Polished Brass, Antique Copper, Brushed Copper, Polished Copper, Chrome, Oil Rubbed Bronze & Pewter			

## RANGETOPS: 24" NOVA (RNB) SERIES

### 24" Nova (RNB) Rangetop All Griddle

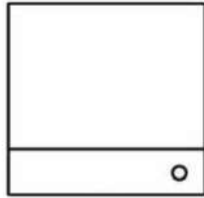

30,000

Model	Description (* Denotes item that must be specified)	UMRP	MSRP
<b>Natural Gas Models: 24" Nova Series Rangetop – All Griddle</b>			
RGTNB24GV2	24" Nova Series   24" Griddle   Nat Gas   Stainless Steel   Standard Trim	\$ 4,695	\$ 5,400
RGTNB24GV2PLT	24" Nova Series   24" Griddle   Nat Gas   Stainless Steel   Plated Trim*	\$ 5,490	\$ 6,315
<b>LP/Propane Models: 24" Nova Series Rangetop – All Griddle</b>			
RGTNB24GV2L	24" Nova Series   24" Griddle   LP Gas   Stainless Steel   Standard Trim	\$ 4,695	\$ 5,400
RGTNB24GV2LPLT	24" Nova Series   24" Griddle   LP Gas   Stainless Steel   Plated Trim*	\$ 5,490	\$ 6,315
<b>Customization &amp; Accessory Options: (See page 48)   Total Knobs: 2</b>			

### 24" Nova (RNB) Rangetop All Charbroiler

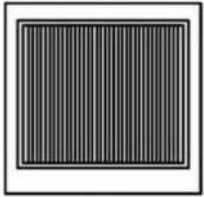

30,000

<b>Natural Gas Models: 24" Nova Series Rangetop – All Charbroiler</b>			
RGTNB24CBV2	24" Nova Series   24" Charbroiler   Nat Gas   Stainless Steel   Standard Trim	\$ 4,695	\$ 5,400
RGTNB24CBV2PLT	24" Nova Series   24" Charbroiler   Nat Gas   Stainless Steel   Plated Trim*	\$ 5,490	\$ 6,315
<b>LP/Propane Models: 24" Nova Series Rangetop – All Charbroiler</b>			
RGTNB24CBV2L	24" Nova Series   24" Charbroiler   LP Gas   Stainless Steel   Standard Trim	\$ 4,695	\$ 5,400
RGTNB24CBV2LPLT	24" Nova Series   24" Charbroiler   LP Gas   Stainless Steel   Plated Trim*	\$ 5,490	\$ 6,315
<b>Customization &amp; Accessory Options: (See page 48)   Total Knobs: 2</b>			

### 24" Nova (RNB) Rangetop All French Top

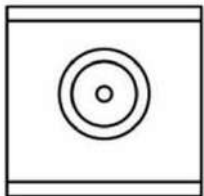

18,000

<b>Natural Gas Models: 24" Nova Series Rangetop – All French Top</b>			
RGTNB24FTV2	24" Nova Series   24" French Top   Nat Gas   Stainless Steel   Standard Trim	\$ 4,795	\$ 5,515
RGTNB24FTV2PLT	24" Nova Series   24" French Top   Nat Gas   Stainless Steel   Plated Trim*	\$ 5,590	\$ 6,430
<b>LP/Propane Models: 24" Nova Series Rangetop – All French Top</b>			
RGTNB24FTV2L	24" Nova Series   24" French Top   LP Gas   Stainless Steel   Standard Trim	\$ 4,795	\$ 5,515
RGTNB24FTV2LPLT	24" Nova Series   24" French Top   LP Gas   Stainless Steel   Plated Trim*	\$ 5,590	\$ 6,430
<b>Customization &amp; Accessory Options: (See page 48)   Total Knobs: 1</b>			

## RANGETOPS: CUSTOMIZATION & ACCESSORY OPTIONS

Item	Description	UMRP	MSRP
<b>CONFIGURATION OPTIONS: BURNERS (Available on Platinum &amp; Nova/RNB Series Only)</b>			
BURNER CHG	Add (1) Star Burner – RNB / RGTNB (Simmer, 15K & 22K)   BSP (Simmer, 15K, 18K, 22K or 25K) or Swap (2) Star Burners – RNB / RGTNB / BSP	\$ 715	\$ 820
<b>PAINT &amp; PLATING OPTIONS:</b>			
KN-C	Knob: Standard RAL (Semi-Gloss) Knob – Factory Installed . (Excludes Pearl, Luminous & Aluminum)	\$ 115 ea	\$ 130 ea
BZ-C	Bezel: Standard RAL (Semi-Gloss) Knob – Factory Installed . (Excludes Pearl, Luminous & Aluminum)	\$ 70 ea	\$ 80 ea
KN-CF	Knob: Specialty Finish (Matte RAL, Textured RAL or Precious Metals) – Factory Installed .	\$ 185 ea	\$ 215 ea
KN-CC	Knob: Custom Color Knob – Factory Installed. MUST be ordered with 24" – 60" Custom Color appliance.	\$ 200 ea	\$ 230 ea
KN-PLT	Knob: Plated Trim	\$ 250 ea	\$ 290 ea
BZ-PLT	Bezel: Plated Trim	\$ 175 ea	\$ 200 ea
<b>ACCESSORIES:</b>			
IT24BSP	24" Island Trim Backguard for Platinum and Nova (RGTNB) Rangetops	\$ 565	\$ 650
IT30BSP	30" Island Trim Backguard for Platinum and Nova (RGTNB) Rangetops	\$ 565	\$ 650
IT36BSP	36" Island Trim Backguard for Platinum and Nova (RGTNB) Rangetops	\$ 665	\$ 765
IT48BSP	48" Island Trim Backguard for Platinum and Nova (RGTNB) Rangetops	\$ 955	\$ 1,100
IT60BSP	60" Island Trim Backguard for Platinum and Nova (RGTNB) Rangetops	\$ 1,210	\$ 1,390
KN-SS	Knob: Brushed Stainless Steel	\$ 115 ea	\$ 130 ea
KN-BLK	Standard Black Knob	\$ 115 ea	\$ 130 ea
BZ-SS	Bezel: Brushed Stainless Steel	\$ 65 ea	\$ 75 ea
BSPICBG12	Interchangeable Griddle Charbroiler – 4 piece	\$ 1,315	\$ 1,510
138901	Wok Ring	\$ 175	\$ 200

## DISHWASHER PANEL: 24" DISHWASHER PANEL

Model Number Color & Customization Guide:			
<b>(C)</b> 190 Standard RAL (Semi-Gloss) Colors	<b>(CF)</b> Specialty Finish (190 Matte RAL, Precious Metals & Textures)	<b>(CC)</b> Custom Color Match	<b>(PLT)</b> Plated Trim



Model	Description (* Denotes item that must be specified)	UMRP	MSRP
<b>24" Dishwasher Panel</b>			
DWBS24	Stainless Steel   Standard Trim	\$ 910	\$ 1,045
DWBS24PLT	Stainless Steel   Plated Trim*	\$ 1,600	\$ 1,840
DWBS24C	Std RAL Color*   Standard Trim	\$ 1,405	\$ 1,615
DWBS24CPLT	Std RAL Color*   Plated Trim*	\$ 2,100	\$ 2,415
DWBS24CF	Specialty Finish*   Standard Trim	\$ 1,670	\$ 1,920
DWBS24CFPLT	Specialty Finish*   Plated Trim*	\$ 2,365	\$ 2,720
DWBS24CC	Custom Color*   Standard Trim	\$ 1,980	\$ 2,275
DWBS24CCPLT	Custom Color*   Plated Trim*	\$ 2,670	\$ 3,070
<b>PLATED TRIM OPTIONS: (Includes bezels, door handle, handle ends and logo)</b>			
Antique Brass, Brushed Brass, Polished Brass, Antique Copper, Brushed Copper, Polished Copper, Chrome, Oil Rubbed Bronze & Pewter			
<b>Accessories:</b>			
DSK-1000008	Handle Assembly Stainless Steel   RCS/RNB Handle Style	\$ 150 ea	\$ 175 ea
DSK-1000008PLT	Handle Assembly Plated *   RCS/RNB Handle Style	\$ 450 ea	\$ 520 ea
DSK-1000009	Handle Assembly Stainless Steel   BSP Handle Style	\$ 150 ea	\$ 175 ea
DSL-1000009PLT	Handle Assembly Plated *   BSP Handle Style	\$ 450 ea	\$ 520 ea

### FEATURES:

- Accommodates most major dishwasher brands
- Heavy-duty stainless steel construction
- Available in 1,000+ colors and finishes
- Plated trim options available



## WALL OVENS

Get the Look: 30" Double Electric Wall Oven in Brushed Stainless Steel

## ELECTRIC WALL OVENS: 30" DOUBLE WALL OVENS

Model Number Color & Customization Guide:			
(C) 190 Standard RAL (Semi-Gloss) Colors	(CF) Specialty Finish (190 Matte RAL, Precious Metals & Textures)	(CC) Custom Color Match	(PLT) Plated Trim



Model Shown: BSDEWO30SDV3



Model Shown: BSDEWO30DDV3

Model	Description (* Denotes item that must be specified)	UMRP	MSRP
<b>30" Double Electric Wall Oven with French and Drop Door</b>			
BSDEWO30SDV3	French/Drop Door   Stainless Steel   Standard Trim	\$ 10,695	\$ 12,300
BSDEWO30SDV3PLT	French/Drop Door   Stainless Steel   Plated Trim*	\$ 13,090	\$ 15,055
BSDEWO30SDV3C	French/Drop Door   Std RAL Color*   Standard Trim	\$ 12,190	\$ 14,020
BSDEWO30SDV3CPLT	French/Drop Door   Std RAL Color*   Plated Trim*	\$ 14,585	\$ 16,775
BSDEWO30SDV3CF	French/Drop Door   Specialty Finish*   Standard Trim	\$ 13,090	\$ 15,055
BSDEWO30SDV3CFPLT	French/Drop Door   Specialty Finish*   Plated Trim*	\$ 15,485	\$ 17,810
BSDEWO30SDV3CC	French/Drop Door   Custom Color*   Standard Trim	\$ 14,490	\$ 16,665
BSDEWO30SDV3CCPLT	French/Drop Door   Custom Color*   Plated Trim*	\$ 16,885	\$ 19,420
<b>30" Double Electric Wall Oven with Double Drop Doors</b>			
BSDEWO30DDV3	Drop Doors   Stainless Steel   Standard Trim	\$ 10,095	\$ 11,610
BSDEWO30DDV3PLT	Drop Doors   Stainless Steel   Plated Trim*	\$ 12,490	\$ 14,365
BSDEWO30DDV3C	Drop Doors   Std RAL Color*   Standard Trim	\$ 11,590	\$ 13,330
BSDEWO30DDV3CPLT	Drop Doors   Std RAL Color*   Plated Trim*	\$ 13,985	\$ 16,085
BSDEWO30DDV3CF	Drop Doors   Specialty Finish*   Standard Trim	\$ 12,490	\$ 14,365
BSDEWO30DDV3CFPLT	Drop Doors   Specialty Finish*   Plated Trim*	\$ 14,885	\$ 17,120
BSDEWO30DDV3CC	Drop Doors   Custom Color*   Standard Trim	\$ 13,890	\$ 15,975
BSDEWO30DDV3CCPLT	Drop Doors   Custom Color*   Plated Trim*	\$ 16,285	\$ 18,730
<b>KNOB OPTIONS: (Total Knobs: 2)   See Page 57 for Additional Customization &amp; Accessory Options</b>			
KN-BLK	Standard Black Knob	\$ 115 ea	\$ 130 ea
KN-C	Knob: Standard 190 RAL Color	\$ 115 ea	\$ 130 ea
KN-CF	Knob: Spec Finish (Matte RAL, Textured RAL or Prec Metals)	\$ 185 ea	\$ 215 ea
KN-PLT	Knob: Plated Trim (See options below)	\$ 250 ea	\$ 290 ea
BZ-C	Bezel: Standard 190 RAL Color	\$ 70 ea	\$ 80 ea
<b>PLATED TRIM OPTIONS: (Includes bezels, door handle, handle ends and logo)</b>			
Antique Brass, Brushed Brass, Polished Brass, Antique Copper, Brushed Copper, Polished Copper, Chrome, Oil Rubbed Bronze & Pewter			

### FEATURES:

- New over-sized, intuitive, full-color touchscreen with unique customization capabilities.
- Extra-large oven capacity, overall capacity of 9.2 cu ft & industry leading usable capacity of 7.1 cu ft.
- Built-in, temperature-controlled bake stone for perfect artisan breads and pizzas.
- Professional-level performance with 9 cooking modes plus temperature probe, delayed start, timed cook, warm and Sabbath features.
- Fits full-size commercial sheet pans & includes a full-extension rack.
- Unmatched customization: choose from 1,000+ colors and 10 metal finishes or custom colors.
- Easy to clean, 90-minute express cycle.
- Handcrafted in Pennsylvania since 1880.

### PRODUCT SPECIFICATIONS FOR BSDEWO30SDV3 & BSDEWO30DDV3:

- Unit Dimensions: 30"W x 25 5/32"D x 49 3/4"H
- Oven Interior: 26.438"W x 20"D x 15"H
- Elec. Reqs: 240V, 60Hz, 50 AMPs, 1 PH
- Unit Weight: 483 lbs.

# ELECTRIC WALL OVENS: 30" SINGLE WALL OVENS

Model Number Color & Customization Guide:			
(C) 190 Standard RAL (Semi-Gloss) Colors	(CF) Specialty Finish (190 Matte RAL, Precious Metals & Textures)	(CC) Custom Color Match	(PLT) Plated Trim



Model Shown: BSEWO30SDV3



Model Shown: BSEWO30DDV3

### FEATURES:

- New over-sized, intuitive, full-color touchscreen with unique customization capabilities.
- Extra-large oven capacity, overall capacity of 4.6 cu ft & industry leading usable capacity of 3.5 cu ft.
- Built-in, temperature-controlled bake stone for perfect artisan breads and pizzas.
- Professional-level performance with 9 cooking modes plus temperature probe, delayed start, timed cook, warm and Sabbath features.
- Fits full-size commercial sheet pans & includes a full-extension rack.
- Unmatched customization: choose from 1,000+ colors and 10 metal finishes or custom colors.
- Easy to clean, 90-minute express cycle.
- Handcrafted in Pennsylvania since 1880.

### PRODUCT SPECIFICATIONS FOR BSEWO30SDV3 & BSEWO30DDV3:

- Unit Dimensions: 30"W x 25.875"D x 27.5"H
- Oven Interior: 26.438"W x 20"D x 15"H
- Elec. Reqs: 208-240 VAC, 24 Amps
- Unit Weight: 304 lbs.

Model	Description (* Denotes item that must be specified)	UMRP	MSRP
<b>30" Electric Wall Oven with French Door</b>			
BSEWO30SDV3	French Door   Stainless Steel   Standard Trim	\$ 7,095	\$ 8,160
BSEWO30SDV3PLT	French Door   Stainless Steel   Plated Trim*	\$ 8,690	\$ 9,995
BSEWO30SDV3C	French Door   Std RAL Color*   Standard Trim	\$ 8,290	\$ 9,535
BSEWO30SDV3CPLT	French Door   Std RAL Color*   Plated Trim*	\$ 9,885	\$ 11,370
BSEWO30SDV3CF	French Door   Specialty Finish*   Standard Trim	\$ 9,290	\$ 10,865
BSEWO30SDV3CFPLT	French Door   Specialty Finish*   Plated Trim*	\$ 10,885	\$ 12,520
BSEWO30SDV3CC	French Door   Custom Color*   Standard Trim	\$ 10,790	\$ 12,410
BSEWO30SDV3CCPLT	French Door   Custom Color*   Plated Trim*	\$ 12,385	\$ 14,245
<b>30" Electric Wall Oven with Drop Door</b>			
BSEWO30DDV3	Drop Door   Stainless Steel   Standard Trim	\$ 6,495	\$ 7,470
BSEWO30DDV3PLT	Drop Door   Stainless Steel   Plated Trim*	\$ 8,090	\$ 9,305
BSEWO30DDV3C	Drop Door   Std RAL Color*   Standard Trim	\$ 7,690	\$ 8,845
BSEWO30DDV3CPLT	Drop Door   Std RAL Color*   Plated Trim*	\$ 9,285	\$ 10,680
BSEWO30DDV3CF	Drop Door   Specialty Finish*   Standard Trim	\$ 8,690	\$ 9,995
BSEWO30DDV3CFPLT	Drop Door   Specialty Finish*   Plated Trim*	\$ 10,285	\$ 11,380
BSEWO30DDV3CC	Drop Door   Custom Color*   Standard Trim	\$ 10,190	\$ 11,720
BSEWO30DDV3CCPLT	Drop Door   Custom Color*   Plated Trim*	\$ 11,785	\$ 13,555
<b>STACKING KIT:</b>			
EWOSTK-30	Stacking Kit for 30" Electric Wall Ovens	N/C	N/C
<b>KNOB OPTIONS: (Total Knobs: 2)   See Page 57 for Additional Customization &amp; Accessory Options</b>			
KN-BLK	Standard Black Knob	\$ 115 ea	\$ 130 ea
KN-C	Knob: Standard 190 RAL Color	\$ 115 ea	\$ 130 ea
KN-CF	Knob: Spec Finish (Matte RAL, Textured RAL or Prec Metals)	\$ 185 ea	\$ 215 ea
KN-PLT	Knob: Plated Trim (See options below)	\$ 250 ea	\$ 290 ea
BZ-C	Bezel: Standard 190 RAL Color	\$ 70 ea	\$ 80 ea
<b>PLATED TRIM OPTIONS: (Includes bezels, door handle, handle ends and logo)</b>			
Antique Brass, Brushed Brass, Polished Brass, Antique Copper, Brushed Copper, Polished Copper, Chrome, Oil Rubbed Bronze & Pewter			

## GAS WALL OVENS: 36" BUILT-IN

### Model Number Color & Customization Guide:

(C) 190 Standard RAL (Semi-Gloss) Colors	(CF) Specialty Finish (190 Matte RAL, Precious Metals & Textures)	(CC) Custom Color Match	(PLT) Plated Trim
--	---	-------------------------	-------------------

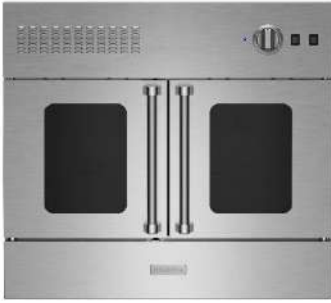

#### FEATURES:

- Powerful 25,000 BTU burner with 1850° Infrared Broiler
- Extra-large oven that accommodates a full size 18" x 26" commercial baking sheet
- 24" depth for compatibility with standard kitchen cabinetry
- Available as single ovens or two single ovens double stacked
- Available in 1,000+ colors & finishes
- Handcrafted in Pennsylvania since 1880

#### PRODUCT SPECIFICATIONS:

- Unit Dimensions: 36"W x 23"D x 32.75"H
- Oven Interior: 29.25"W x 20"D x 15"H
- Gas Pressure: NAT: 5.0" WC, LP 10.0" WC
- Gas Line Size: ½"
- Unit Weight: 400 lbs.

Model	Description (* Denotes item that must be specified)	UMRP	MSRP
<b>Natural Gas Models: 36" Built-In Gas Wall Oven</b>			
BWO36AGSV2	Nat Gas   Stainless Steel   Standard Trim	\$ 7,765	\$ 8,930
BWO36AGSV2PLT	Nat Gas   Stainless Steel   Plated Trim*	\$ 9,360	\$ 10,765
BWO36AGSV2C	Nat Gas   Std RAL Color*   Standard Trim	\$ 8,960	\$ 10,305
BWO36AGSV2CPLT	Nat Gas   Std RAL Color*   Plated Trim*	\$ 10,555	\$ 12,140
BWO36AGSV2CF	Nat Gas   Specialty Finish*   Standard Trim	\$ 9,960	\$ 11,455
BWO36AGSV2CFPLT	Nat Gas   Specialty Finish*   Plated Trim*	\$ 11,555	\$ 13,290
BWO36AGSV2CC	Nat Gas   Custom Color*   Standard Trim	\$ 11,460	\$ 13,180
BWO36AGSV2CCPLT	Nat Gas   Custom Color*   Plated Trim*	\$ 13,055	\$ 15,015
<b>LP/Propane Models: 36" Built-In Gas Wall Oven</b>			
BWO36AGSV2L	LP Gas   Stainless Steel   Standard Trim	\$ 7,765	\$ 8,930
BWO36AGSV2LPLT	LP Gas   Stainless Steel   Plated Trim*	\$ 9,360	\$ 10,765
BWO36AGSV2LC	LP Gas   Std RAL Color*   Standard Trim	\$ 8,960	\$ 10,305
BWO36AGSV2LCPLT	LP Gas   Std RAL Color*   Plated Trim*	\$ 10,555	\$ 12,140
BWO36AGSV2LCF	LP Gas   Specialty Finish*   Standard Trim	\$ 9,960	\$ 11,455
BWO36AGSV2LCFPLT	LP Gas   Specialty Finish*   Plated Trim*	\$ 11,555	\$ 13,290
BWO36AGSV2LCC	LP Gas   Custom Color*   Standard Trim	\$ 11,460	\$ 13,180
BWO36AGSV2LCCPLT	LP Gas   Custom Color*   Plated Trim*	\$ 13,055	\$ 15,015
<b>STACKING KIT:</b>			
BWOSTK-36	Stacking Kit for 36" Gas Wall Ovens	N/C	N/C
<b>KNOB OPTIONS: (Total Knobs: 1)   See Page 57 for Additional Customization &amp; Accessory Options</b>			
KN-BLK	Standard Black Knob	\$ 115 ea	\$ 130 ea
KN-C	Knob: Standard 190 RAL Color	\$ 115 ea	\$ 130 ea
KN-CF	Knob: Spec Finish (Matte RAL, Textured RAL or Prec Metals)	\$ 185 ea	\$ 215 ea
KN-PLT	Knob: Plated Trim (See options below)	\$ 250 ea	\$ 290 ea
BZ-C	Bezel: Standard 190 RAL Color	\$ 70 ea	\$ 80 ea
<b>PLATED TRIM OPTIONS: (Includes bezels, door handle, handle ends and logo)</b>			
Antique Brass, Brushed Brass, Polished Brass, Antique Copper, Brushed Copper, Polished Copper, Chrome, Oil Rubbed Bronze & Pewter			

## GAS WALL OVENS: 30" BUILT-IN

### Model Number Color & Customization Guide:

(C) 190 Standard RAL (Semi-Gloss) Colors	(CF) Specialty Finish (190 Matte RAL, Precious Metals & Textures)	(CC) Custom Color Match	(PLT) Plated Trim
--	---	-------------------------	-------------------



#### FEATURES:

- Powerful 25,000 BTU burner with 1850° Infrared Broiler
- Extra-large oven that accommodates a full size 18" x 26" commercial baking sheet
- 24" depth for compatibility with standard kitchen cabinetry
- Available as single ovens or two single ovens double stacked
- Available in 1,000+ colors & finishes
- Handcrafted in Pennsylvania since 1880

#### PRODUCT SPECIFICATIONS:

- Unit Dimensions: 30"W x 26"D x 32.75"H
- Oven Interior: 26.438"W x 20"D x 15"H
- Gas Pressure: NAT: 5.0" WC, LP 10.0" WC
- Gas Line Size: ½"
- Unit Weight: 305 lbs.

Model	Description (* Denotes item that must be specified)	UMRP	MSRP
<b>Natural Gas Models: 30" Built-In Gas Wall Oven</b>			
BWO30AGSV2	Nat Gas   Stainless Steel   Standard Trim	\$ 6,505	\$ 7,480
BWO30AGSV2PLT	Nat Gas   Stainless Steel   Plated Trim*	\$ 8,100	\$ 9,315
BWO30AGSV2C	Nat Gas   Std RAL Color*   Standard Trim	\$ 7,700	\$ 8,855
BWO30AGSV2CPLT	Nat Gas   Std RAL Color*   Plated Trim*	\$ 9,295	\$ 10,960
BWO30AGSV2CF	Nat Gas   Specialty Finish*   Standard Trim	\$ 8,700	\$ 10,005
BWO30AGSV2CFPLT	Nat Gas   Specialty Finish*   Plated Trim*	\$ 10,295	\$ 11,480
BWO30AGSV2CC	Nat Gas   Custom Color*   Standard Trim	\$ 10,200	\$ 11,730
BWO30AGSV2CCPLT	Nat Gas   Custom Color*   Plated Trim*	\$ 11,795	\$ 13,565
<b>LP/Propane Models: 30" Built-In Gas Wall Oven</b>			
BWO30AGSV2L	LP Gas   Stainless Steel   Standard Trim	\$ 6,505	\$ 7,480
BWO30AGSV2LPLT	LP Gas   Stainless Steel   Plated Trim*	\$ 8,100	\$ 9,315
BWO30AGSV2LC	LP Gas   Std RAL Color*   Standard Trim	\$ 7,700	\$ 8,855
BWO30AGSV2LCPLT	LP Gas   Std RAL Color*   Plated Trim*	\$ 9,295	\$ 10,960
BWO30AGSV2LCF	LP Gas   Specialty Finish*   Standard Trim	\$ 8,700	\$ 10,005
BWO30AGSV2LCFPLT	LP Gas   Specialty Finish*   Plated Trim*	\$ 10,295	\$ 11,480
BWO30AGSV2LCC	LP Gas   Custom Color*   Standard Trim	\$ 10,200	\$ 11,730
BWO30AGSV2LCCPLT	LP Gas   Custom Color*   Plated Trim*	\$ 11,795	\$ 13,565
<b>STACKING KIT:</b>			
BWOSTK-30	Stacking Kit for 30" Gas Wall Ovens	N/C	N/C
<b>KNOB OPTIONS: (Total Knobs: 1)   See Page 57 for Additional Customization &amp; Accessory Options</b>			
KN-BLK	Standard Black Knob	\$ 115 ea	\$ 130 ea
KN-C	Knob: Standard 190 RAL Color	\$ 115 ea	\$ 130 ea
KN-CF	Knob: Spec Finish (Matte RAL, Textured RAL or Prec Metals)	\$ 185 ea	\$ 215 ea
KN-PLT	Knob: Plated Trim (See options below)	\$ 250 ea	\$ 290 ea
BZ-C	Bezel: Standard 190 RAL Color	\$ 70 ea	\$ 80 ea
<b>PLATED TRIM OPTIONS: (Includes bezels, door handle, handle ends and logo)</b>			
Antique Brass, Brushed Brass, Polished Brass, Antique Copper, Brushed Copper, Polished Copper, Chrome, Oil Rubbed Bronze & Pewter			

## GAS WALL OVENS: 24" BUILT-IN

### Model Number Color & Customization Guide:

(C) 190 Standard RAL (Semi-Gloss) Colors	(CF) Specialty Finish (190 Matte RAL, Precious Metals & Textures)	(CC) Custom Color Match	(PLT) Plated Trim
--	---	-------------------------	-------------------



Model Shown: BWO24AGS (Left Hinge)  
Must notate right or left hinge at time of order

#### FEATURES:

- Powerful 25,000 BTU burner with 1850° Infrared Broiler
- Extra-large oven that accommodates a half size 18" x 13" commercial baking sheet
- Features swing door design from either left or right side
- 24" depth for compatibility with standard kitchen cabinetry
- Available as single ovens or two single ovens double stacked
- Available in 1,000+ colors & finishes
- Handcrafted in Pennsylvania since 1880

#### PRODUCT SPECIFICATIONS:

- Unit Dimensions: 24"W x 23"D x 32.75"H
- Oven Interior: 20.25"W x 20"D x 15"H
- Gas Pressure: NAT: 5.0" WC, LP 10.0" WC
- Gas Line Size: ½"
- Unit Weight: 295 lbs.

Model	Description (* Denotes item that must be specified)	UMRP	MSRP
<b>Natural Gas Models: 24" Built-In Gas Wall Oven</b>			
BWO24AGSV2	Nat Gas   Stainless Steel   Standard Trim	\$ 4,930	\$ 5,670
BWO24AGSV2PLT	Nat Gas   Stainless Steel   Plated Trim*	\$ 6,025	\$ 6,930
BWO24AGSV2C	Nat Gas   Std RAL Color*   Standard Trim	\$ 6,125	\$ 7,045
BWO24AGSV2CPLT	Nat Gas   Std RAL Color*   Plated Trim*	\$ 7,220	\$ 8,305
BWO24AGSV2CF	Nat Gas   Specialty Finish*   Standard Trim	\$ 7,125	\$ 8,195
BWO24AGSV2CFPLT	Nat Gas   Specialty Finish*   Plated Trim*	\$ 8,220	\$ 9,455
BWO24AGSV2CC	Nat Gas   Custom Color*   Standard Trim	\$ 8,625	\$ 9,920
BWO24AGSV2CCPLT	Nat Gas   Custom Color*   Plated Trim*	\$ 9,720	\$ 11,180
<b>LP/Propane Models: 24" Built-In Gas Wall Oven</b>			
BWO24AGSV2L	LP Gas   Stainless Steel   Standard Trim	\$ 4,930	\$ 5,670
BWO24AGSV2LPLT	LP Gas   Stainless Steel   Plated Trim*	\$ 6,025	\$ 6,930
BWO24AGSV2LC	LP Gas   Std RAL Color*   Standard Trim	\$ 6,125	\$ 7,045
BWO24AGSV2LCPLT	LP Gas   Std RAL Color*   Plated Trim*	\$ 7,220	\$ 8,305
BWO24AGSV2LCF	LP Gas   Specialty Finish*   Standard Trim	\$ 7,125	\$ 8,195
BWO24AGSV2LCFPLT	LP Gas   Specialty Finish*   Plated Trim*	\$ 8,220	\$ 9,455
BWO24AGSV2LCC	LP Gas   Custom Color*   Standard Trim	\$ 8,625	\$ 9,920
BWO24AGSV2LCCPLT	LP Gas   Custom Color*   Plated Trim*	\$ 9,720	\$ 11,180
<b>STACKING KIT:</b>			
BWOSTK-24	Stacking Kit for 24" Gas Wall Ovens	N/C	N/C
<b>KNOB OPTIONS: (Total Knobs: 1)   See Page 57 for Additional Customization &amp; Accessory Options</b>			
KN-BLK	Standard Black Knob	\$ 115 ea	\$ 130 ea
KN-C	Knob: Standard 190 RAL Color	\$ 115 ea	\$ 130 ea
KN-CF	Knob: Spec Finish (Matte RAL, Textured RAL or Prec Metals)	\$ 185 ea	\$ 215 ea
KN-PLT	Knob: Plated Trim (See options below)	\$ 250 ea	\$ 290 ea
BZ-C	Bezel: Standard 190 RAL Color	\$ 70 ea	\$ 80 ea
<b>PLATED TRIM OPTIONS: (Includes bezels, door handle, handle ends and logo)</b>			
Antique Brass, Brushed Brass, Polished Brass, Antique Copper, Brushed Copper, Polished Copper, Chrome, Oil Rubbed Bronze & Pewter			

## GAS & ELECTRIC WALL OVENS: CUSTOMIZATION & ACCESSORY OPTIONS

Item	Description	UMRP	MSRP
<b>PAINT &amp; PLATING OPTIONS:</b>			
KN-C	Knob: Standard RAL (Semi-Gloss) Knob – Factory Installed . (Excludes Pearl, Luminous & Aluminum)	\$ 115 ea	\$ 130 ea
KN-CF	Knob: Specialty Finish (Matte RAL, Textured RAL or Precious Metals) – Factory Installed .	\$ 185 ea	\$ 215 ea
KN-CC	Knob: Custom Color Knob – Factory Installed. MUST be ordered with 24” – 60” Custom Color appliance.	\$ 200 ea	\$ 230 ea
KN-PLT	Knob: Plated Trim	\$ 250 ea	\$ 290 ea
BZ-C	Bezel: Standard RAL (Semi-Gloss) Knob – Factory Installed . (Excludes Pearl, Luminous & Aluminum)	\$ 70 ea	\$ 80 ea
BZ-PLT	Bezel: Plated Trim	\$ 175 ea	\$ 200 ea
<b>ACCESSORIES:</b>			
KN-SS	Knob: Brushed Stainless Steel	\$ 115 ea	\$ 130 ea
BZ-SS	Bezel: Brushed Stainless Steel	\$ 65 ea	\$ 75 ea
EXTN RACK 24	Full Extension Rack for 24” Freestanding Ranges & Wall Ovens	\$ 550	\$ 635
EXTN RACK 30	Full Extension Rack for 30” Freestanding Ranges & Wall Ovens	\$ 590	\$ 680
EXTN RACK 36	Full Extension Rack for 36” Freestanding Ranges & Wall Ovens	\$ 620	\$ 715
704406	Standard Oven Rack for 24” Freestanding Ranges & Wall Ovens	\$ 120	\$ 140
704405	Standard Oven Rack for 30” Freestanding Ranges & Wall Ovens	\$ 155	\$ 180
704402	Standard Oven Rack for 36” Freestanding Ranges & Wall Ovens	\$ 175	\$ 200
799211	30” Electric Wall Oven Baking Stone	\$ 415	\$ 475

## BROILERS: SALAMANDER BROILER



**FEATURES:**

- Heavy duty, commercial stainless steel construction
- Two independently controlled infrared ceramic burners
- Powerful 18,500 BTUs
- 215 square inches of cooking space
- Large removable heavy-duty grilling rack
- Automatic electronic ignition and re-ignition system

**PRODUCT SPECIFICATIONS:**

- Front Burner Power: 11,000 BTUs
- Rear Burner Power: 7,500 BTUs

Model	Description (* Denotes item that must be specified)	UMRP	MSRP
<b>Natural Gas Models: 24" Salamander Broiler</b>			
PRZSAL24V2	Nat Gas   Stainless Steel   Standard Trim	\$ 5,770	\$ 6,635
PRZSAL24V2PLT	Nat Gas   Stainless Steel   Plated Trim*	\$ 6,865	\$ 7,895
<b>LP/Propane Models: 24" Salamander Broiler</b>			
PRZSAL24V2L	LP Gas   Stainless Steel   Standard Trim	\$ 5,770	\$ 6,625
PRZSAL24V2LPLT	LP Gas   Stainless Steel   Plated Trim*	\$ 6,865	\$ 7,895
<b>WALL MOUNTS: (Sold separately – Salamander NOT included)</b>			
PRZSALWMM	24" Wall Mount (No Shelf) – Salamander Not Included	\$ 1,370	\$ 1,575
PRZSAL36WMM	36" Wall Mount w/ Shelf – Salamander Not Included	\$ 2,745	\$ 3,155
PRZSAL48WMM	48" Wall Mount w/ Shelf – Salamander Not Included	\$ 3,700	\$ 4,255
PRZSAL60WMM	60" Wall Mount w/ Shelf – Salamander Not Included	\$ 4,115	\$ 4,730
<b>KNOB OPTIONS: (Total Knobs: 2)</b>			
KN-C	Knob: Standard 190 RAL Color	\$ 115 ea	\$ 130 ea
KN-CF	Knob: Spec Finish (Matte RAL, Textured RAL or Prec Metals)	\$ 185 ea	\$ 215 ea
KN-CC	Knob: Custom Color (Must be ordered with Custom Color Match Range, Refrigerator or Ventilation Hood)	\$ 200 ea	\$ 230 ea
KN-PLT	Knob: Plated Trim (See options below)	\$ 250 ea	\$ 290 ea
BZ-C	Bezel: Standard 190 RAL Color	\$ 70 ea	\$ 80 ea
<b>PLATED TRIM OPTIONS: (Includes bezels, drawer handle, handle ends and logo)</b>			
Antique Brass, Brushed Brass, Polished Brass, Antique Copper, Brushed Copper, Polished Copper, Chrome, Oil Rubbed Bronze & Pewter			

**WALL MOUNT SPECIFICATIONS:**

**24" Wall Mount (No Shelf)**

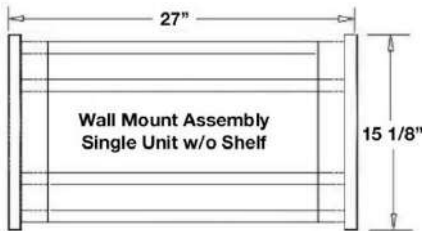

**36", 48" & 60" Wall Mount with Shelf**

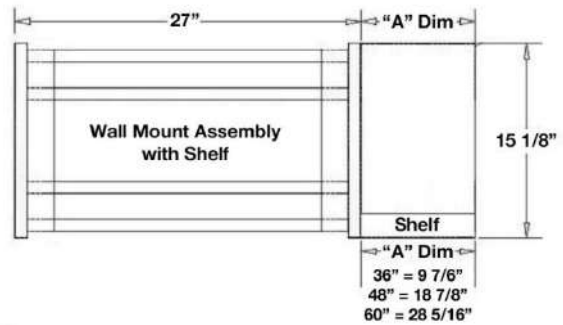

**Note: Wall Mount can only be mounted on left side of assembly.**



## REFRIGERATION

Get the Look: Panel Ready 30" Column Refrigerator & 18" Column Freezer

## REFRIGERATION: 36" PRO BUILT-IN REFRIGERATOR

Model Number Color & Customization Guide:			
(C) 190 Standard RAL (Semi-Gloss) Colors	(CF) Specialty Finish (190 Matte RAL, Precious Metals & Textures)	(CC) Custom Color Match	(PLT) Plated Trim



Model Shown: BBB36R3



Model Shown: BBB36L3

Model	Description (* Denotes item that must be specified)	UMRP	MSRP
<b>36" Pro Built-In Refrigerator/Freezer – RIGHT HINGE</b>			
BBB36R3	Right Hinge   Stainless Steel   Standard Trim	\$ 13,495	\$ 15,520
BBB36R3PLT	Right Hinge   Stainless Steel   Plated Trim*	\$ 14,890	\$ 17,125
BBB36R3C	Right Hinge   Std RAL Color*   Standard Trim	\$ 14,990	\$ 17,240
BBB36R3CPLT	Right Hinge   Std RAL Color*   Plated Trim*	\$ 16,385	\$ 18,845
BBB36R3CF	Right Hinge   Specialty Finish*   Standard Trim	\$ 15,490	\$ 17,815
BBB36R3CFPLT	Right Hinge   Specialty Finish*   Plated Trim*	\$ 16,885	\$ 19,420
BBB36R3CC	Right Hinge   Custom Color*   Standard Trim	\$ 16,790	\$ 19,310
BBB36R3CCPLT	Right Hinge   Custom Color*   Plated Trim*	\$ 18,185	\$ 20,915
<b>36" Pro Built-In Refrigerator/Freezer – LEFT HINGE</b>			
BBB36L3	Left Hinge   Stainless Steel   Standard Trim	\$ 13,495	\$ 15,520
BBB36L3PLT	Left Hinge   Stainless Steel   Plated Trim*	\$ 14,890	\$ 17,125
BBB36L3C	Left Hinge   Std RAL Color*   Standard Trim	\$ 14,990	\$ 17,240
BBB36L3CPLT	Left Hinge   Std RAL Color*   Plated Trim*	\$ 16,385	\$ 18,845
BBB36L3CF	Left Hinge   Specialty Finish*   Standard Trim	\$ 15,490	\$ 17,815
BBB36L3CFPLT	Left Hinge   Specialty Finish*   Plated Trim*	\$ 16,885	\$ 19,420
BBB36L3CC	Left Hinge   Custom Color*   Standard Trim	\$ 16,790	\$ 19,310
BBB36L3CCPLT	Left Hinge   Custom Color*   Plated Trim*	\$ 18,185	\$ 20,915
<b>ADDITIONAL OPTIONS:</b>			
PAINT REFR GRILL	Painted Top Grill on Built-In Refrigerator	\$ 250	\$ 290
799338 – 36 REFR	90 Degree Pin Stops (*Must be specified on order*)	\$ 35	\$ 40
<b>ACCESSORIES AVAILABLE SEPARATELY:</b>			
799071	Plastic Ice Bin	\$ 125 ea	\$ 145 ea
799627	Ice Scoop	\$ 40 ea	\$ 45 ea
799438	Replacement Water Filter	\$ 95 ea	\$ 110 ea
799700	Replacement Air Filter	\$ 50 ea	\$ 60 ea
RSK-950128	Perimeter Trim	N/C	N/C
RSK-950034	42" Refrigerator Handle Assembly, Stainless Steel	\$ 185	\$ 215
RSK-950034PLT	42" Refrigerator Handle Assembly, Plated *	\$ 385	\$ 445
RSK-950035	32" Freezer Handle Assembly, Stainless Steel	\$ 185	\$ 215
RSK-950035PLT	32" Freezer Handle Assembly, Plated *	\$ 385	\$ 445
<b>PLATED TRIM OPTIONS: (Includes door handle, handle ends and logo)</b>			
Antique Brass, Brushed Brass, Polished Brass, Antique Copper, Brushed Copper, Polished Copper, Chrome, Oil Rubbed Bronze & Pewter			

**FEATURES:**

- All Stainless Steel and Glass Interiors
- Dual Compressors
- Oversized Capacity
- Fits Commercial Size Sheet Tray: Refrigerator/Freezer
- Ramp-on LED Lighting
- 1,000+ Color Options
- Automatic Ice Maker
- Designed and Manufactured in USA
- Iron Clad Warranty: 2 years (full), 5 years (sealed system parts & labor) and 13 years (sealed system parts)
- Unit weight: 783 lbs.

## REFRIGERATION: 36" PRO BUILT-IN FRENCH DOOR REFRIGERATOR/FREEZER

### Model Number Color & Customization Guide:

(C) 190 Standard RAL (Semi-Gloss) Colors	(CF) Specialty Finish (190 Matte RAL, Precious Metals & Textures)	(CC) Custom Color Match	(PLT) Plated Trim
--	---	-------------------------	-------------------



#### FEATURES:

- All Stainless Steel and Glass Interiors
- Dual Compressors
- Oversized 22.4 cu. ft. Capacity
- Fits Commercial Size Sheet Tray: Refrigerator/Freezer
- Heavy Duty Construction
- Ramp-on LED Lighting
- 1,000+ Color Options
- Automatic Ice Maker
- Designed and Manufactured in USA
- Iron Clad Warranty: 2 years (full), 5 years (sealed system parts & labor) and 13 years (sealed system parts)
- Unit weight: 783 lbs.

Model	Description (* Denotes item that must be specified)	UMRP	MSRP
<b>36" Pro French Door Built-in Refrigerator/Freezer</b>			
BBBF361	French Door   Stainless Steel   Standard Trim	\$ 13,995	\$ 16,095
BBBF361PLT	French Door   Stainless Steel   Plated Trim*	\$ 15,590	\$ 17,930
BBBF361C	French Door   Std RAL Color*   Standard Trim	\$ 15,590	\$ 17,930
BBBF361CPLT	French Door   Std RAL Color*   Plated Trim*	\$ 17,185	\$ 19,765
BBBF361CF	French Door   Specialty Finish*   Standard Trim	\$ 16,090	\$ 18,505
BBBF361CFPLT	French Door   Specialty Finish*   Plated Trim*	\$ 17,685	\$ 20,340
BBBF361CC	French Door   Custom Color*   Standard Trim	\$ 17,290	\$ 19,885
BBBF361CCPLT	French Door   Custom Color*   Plated Trim*	\$ 18,885	\$ 21,720
<b>ADDITIONAL OPTIONS:</b>			
PAINT REFR GRILL	Painted Top Grill on Built-In Refrigerator	\$ 250	\$ 290
799338 – 36 REFR FD	90 Degree Pin Stops (*Must be specified on order*)	\$ 35	\$ 40
<b>ACCESSORIES AVAILABLE SEPARATELY:</b>			
799071	Plastic Ice Bin	\$ 125 ea	\$ 145 ea
799627	Ice Scoop	\$ 40 ea	\$ 45 ea
799438	Replacement Water Filter	\$ 95 ea	\$ 110 ea
799700	Replacement Air Filter	\$ 50 ea	\$ 60 ea
RSK-950128	Perimeter Trim	N/C	N/C
RSK-950034	42" Refrigerator Handle Assembly, Stainless Steel	\$ 185	\$ 215
RSK-950034PLT	42" Refrigerator Handle Assembly, Plated *	\$ 385	\$ 445
RSK-950035	32" Freezer Handle Assembly, Stainless Steel	\$ 185	\$ 215
RSK-950035PLT	32" Freezer Handle Assembly, Plated *	\$ 385	\$ 445
<b>PLATED TRIM OPTIONS: (Includes door handle, handle ends and logo)</b>			
Antique Brass, Brushed Brass, Polished Brass, Antique Copper, Brushed Copper, Polished Copper, Chrome, Oil Rubbed Bronze & Pewter			

# REFRIGERATOR: 30" COLUMN REFRIGERATOR

Model Number Color & Customization Guide:			
(C) 190 Standard RAL (Semi-Gloss) Colors	(CF) Specialty Finish (190 Matte RAL, Precious Metals & Textures)	(CC) Custom Color Match	(PLT) Plated Trim



**FEATURES:**

- Industry-leading 17.44 cu. Ft. capacity
- Available in panel-ready, stainless steel or your choice of 1,000+ colors and 10 metal trims
- Flush installation
- Advanced temperature control for longer food preservation
- Extra-bright LED lighting
- Fully extending crisper drawers
- Slide-out tray that fits sheet pan
- Touch screen control with Sabbath & Shopping modes
- Iron Clad Warranty: 2 years (full), 5 years (sealed system parts & labor) and 13 years (sealed system parts)
- Unit weight: 445 lbs.

**COLUMN JOINING KITS**

Joining Kits (#700523) ship automatically with all freezer units. Contains a filler strip to conceal joint between refrigerator and freezer columns. Joining Kits for side by side refrigeration units sold separately.

**PLATED TRIM OPTIONS:**

**(Includes door handle, handle ends and logo)**  
 Antique Brass, Brushed Brass, Polished Brass, Antique Copper, Brushed Copper, Polished Copper, Chrome, Oil Rubbed Bronze & Pewter

Model	Description (* Denotes item that must be specified)	UMRP	MSRP
<b>30" Column Refrigerator – RIGHT HINGE (See page 79 for Dual Fuel Trim Options)</b>			
BIRP30R0	Right Hinge   Panel Ready	\$ 8,995	\$ 10,345
CP30RH1	Right Door Panel   Stainless Steel   Legacy Std Trim	\$ 995	\$ 1,145
CP30RH1PLT	Right Door Panel   Stainless Steel   Legacy Pltd Trim*	\$ 2,190	\$ 2,520
CP30RH1C	Right Door Panel   Std RAL Color*   Legacy Std Trim	\$ 2,390	\$ 2,750
CP30RH1CPLT	Right Door Panel   Std RAL Color*   Legacy Pltd Trim*	\$ 3,585	\$ 4,125
CP30RH1CF	Right Door Panel   Spec Finish*   Legacy Std Trim	\$ 2,990	\$ 3,440
CP30RH1CFPLT	Right Door Panel   Spec Finish*   Legacy Pltd Trim*	\$ 4,185	\$ 4,815
CP30RH1CC	Right Door Panel   Custom Color*   Legacy Std Trim	\$ 4,290	\$ 4,935
CP30RH1CCPLT	Right Door Panel   Custom Color*   Legacy Pltd Trim*	\$ 5,485	\$ 6,310
<b>30" Column Refrigerator – LEFT HINGE (See page 79 for Dual Fuel Trim Options)</b>			
BIRP30L0	Left Hinge   Panel Ready	\$ 8,995	\$ 10,345
CP30LH1	Left Door Panel   Stainless Steel   Legacy Std Trim	\$ 995	\$ 1,145
CP30LH1PLT	Left Door Panel   Stainless Steel   Legacy Pltd Trim*	\$ 2,190	\$ 2,520
CP30LH1C	Left Door Panel   Std RAL Color*   Legacy Std Trim	\$ 2,390	\$ 2,750
CP30LH1CPLT	Left Door Panel   Std RAL Color*   Legacy Pltd Trim*	\$ 3,585	\$ 4,125
CP30LH1CF	Left Door Panel   Spec Finish*   Legacy Std Trim	\$ 2,990	\$ 3,440
CP30LH1CFPLT	Left Door Panel   Spec Finish*   Legacy Pltd Trim*	\$ 4,185	\$ 4,815
CP30LH1CC	Left Door Panel   Custom Color*   Legacy Std Trim	\$ 4,290	\$ 4,935
CP30LH1CCPLT	Left Door Panel   Custom Color*   Legacy Pltd Trim*	\$ 5,485	\$ 6,310
<b>Additional Options: (**) Painted Toe-Kick Grills Require Painted Column Unit</b>			
798803	Painted Toe-Kick Grill 30" **	\$ 235	\$ 270
950360	60" Toe Kick Grill – Panel Ready Stainless Steel	\$ 910	\$ 1,045
950361	54" Toe Kick Grill – Panel Ready Stainless Steel	\$ 880	\$ 1,010
950362	48" Toe Kick Grill – Panel Ready Stainless Steel	\$ 880	\$ 1,010
950363	42" Toe Kick Grill – Panel Ready Stainless Steel	\$ 855	\$ 985
950360C	60" Toe Kick Grill – Panel Ready Painted **	\$ 1,145	\$ 1,315
950361C	54" Toe Kick Grill – Panel Ready Painted **	\$ 1,115	\$ 1,280
950362C	48" Toe Kick Grill – Panel Ready Painted **	\$ 1,115	\$ 1,280
950363C	42" Toe Kick Grill – Panel Ready Painted **	\$ 1,090	\$ 1,255
700523	Column Joining Kit (Required for two column units to be joined – ships automatically with all freezer units)	\$ 160	\$ 185
700622	Toe Kick Filler Piece Only (Ships automatically with Column Joining Kit (#700523))	\$ 55	\$ 65
RSK-1000083	36" Column Handle Assembly, Brushed Stainless Steel	\$ 225 ea	\$ 260 ea
RSK-1000083PLT	36" Column Handle Assembly, Plated *	\$ 675 ea	\$ 775 ea
700588	90 Degree Pin   Right Door Hinges ***	\$ 415	\$ 475
700589	90 Degree Pin   Left Door Hinges ***	\$ 415	\$ 475
<b>*** 90 Degree Pins must be specified at time of order. They can not be added after installation.</b>			

# REFRIGERATOR: 24" COLUMN REFRIGERATOR

## Model Number Color & Customization Guide:

(C) 190 Standard RAL (Semi-Gloss) Colors	(CF) Specialty Finish (190 Matte RAL, Precious Metals & Textures)	(CC) Custom Color Match	(PLT) Plated Trim
--	---	-------------------------	-------------------



### FEATURES:

- Over-sized 12.99 cu. ft. capacity
- Available in panel-ready, stainless steel or your choice of 1,000+ colors and 10 metal trims
- Flush installation
- Advanced temperature control for longer food preservation
- Extra-bright LED lighting
- Fully extending crisper drawers
- Slide-out tray that fits sheet pan
- Touch screen control with Sabbath & Shopping modes
- Iron Clad Warranty: 2 years (full), 5 years (sealed system parts & labor) and 13 years (sealed system parts)
- Unit weight: 364 lbs.

### COLUMN JOINING KITS

Joining Kits (#700523) ship automatically with all freezer units. Contains a filler strip to conceal joint between refrigerator and freezer columns. Joining Kits for side by side refrigeration units sold separately.

### PLATED TRIM OPTIONS:

**(Includes door handle, handle ends and logo)**  
 Antique Brass, Brushed Brass, Polished Brass, Antique Copper, Brushed Copper, Polished Copper, Chrome, Oil Rubbed Bronze & Pewter

Model	Description (* Denotes item that must be specified)	UMRP	MSRP
<b>24" Column Refrigerator – RIGHT HINGE (See page 79 for Dual Fuel Trim Options)</b>			
BIRP24R0	Right Hinge   Panel Ready	\$ 8,595	\$ 9,885
CP24RH1	Right Door Panel   Stainless Steel   Legacy Std Trim	\$ 795	\$ 915
CP24RH1PLT	Right Door Panel   Stainless Steel   Legacy Pltd Trim*	\$ 1,990	\$ 2,290
CP24RH1C	Right Door Panel   Std RAL Color*   Legacy Std Trim	\$ 1,890	\$ 2,175
CP24RH1CPLT	Right Door Panel   Std RAL Color*   Legacy Pltd Trim*	\$ 3,085	\$ 3,550
CP24RH1CF	Right Door Panel   Spec Finish*   Legacy Std Trim	\$ 2,390	\$ 2,750
CP24RH1CFPLT	Right Door Panel   Spec Finish*   Legacy Pltd Trim*	\$ 3,585	\$ 4,125
CP24RH1CC	Right Door Panel   Custom Color*   Legacy Std Trim	\$ 3,690	\$ 4,245
CP24RH1CCPLT	Right Door Panel   Custom Color*   Legacy Pltd Trim*	\$ 4,885	\$ 5,620
<b>24" Column Refrigerator – LEFT HINGE (See page 79 for Dual Fuel Trim Options)</b>			
BIRP24L0	Left Hinge   Panel Ready	\$ 8,595	\$ 9885
CP24LH1	Left Door Panel   Stainless Steel   Legacy Std Trim	\$ 795	\$ 915
CP24LH1PLT	Left Door Panel   Stainless Steel   Legacy Pltd Trim*	\$ 1,990	\$ 2,290
CP24LH1C	Left Door Panel   Std RAL Color*   Legacy Std Trim	\$ 1,890	\$ 2,175
CP24LH1CPLT	Left Door Panel   Std RAL Color*   Legacy Pltd Trim*	\$ 3,085	\$ 3,550
CP24LH1CF	Left Door Panel   Spec Finish*   Legacy Std Trim	\$ 2,390	\$ 2,750
CP24LH1CFPLT	Left Door Panel   Spec Finish*   Legacy Pltd Trim*	\$ 3,585	\$ 4,125
CP24LH1CC	Left Door Panel   Custom Color*   Legacy Std Trim	\$ 3,690	\$ 4,245
CP24LHCCPLT	Left Door Panel   Custom Color*   Legacy Pltd Trim*	\$ 4,885	\$ 5,620
<b>Additional Options:</b>			
798804	Painted Toe-Kick Grill 24" (Note: Requires painted column unit)	\$ 235	\$270
950360	60" Toe Kick Grill – Panel Ready Stainless Steel	\$ 910	\$ 1,045
950361	54" Toe Kick Grill – Panel Ready Stainless Steel	\$ 880	\$ 1,010
950362	48" Toe Kick Grill – Panel Ready Stainless Steel	\$ 880	\$ 1,010
950363	42" Toe Kick Grill – Panel Ready Stainless Steel	\$ 855	\$ 985
950360C	60" Toe Kick Grill – Panel Ready Painted **	\$ 1,145	\$ 1,315
950361C	54" Toe Kick Grill – Panel Ready Painted **	\$ 1,115	\$ 1,280
950362C	48" Toe Kick Grill – Panel Ready Painted **	\$ 1,115	\$ 1,280
950363C	42" Toe Kick Grill – Panel Ready Painted **	\$ 1,090	\$ 1,255
700523	Column Joining Kit (Required for two column units to be joined – ships automatically with all freezer units)	\$ 160	\$ 185
700622	Toe Kick Filler Piece Only (Ships automatically with Column Joining Kit (#700523))	\$ 55	\$ 65
RSK-1000083	36" Column Handle Assembly, Brushed Stainless Steel	\$ 225 ea	\$ 260 ea
RSK-1000083PLT	36" Column Handle Assembly, Plated *	\$ 675 ea	\$ 775 ea
700588	90 Degree Pin   Right Door Hinges ***	\$ 415	\$ 475
700589	90 Degree Pin   Left Door Hinges ***	\$ 415	\$ 475
<b>*** 90 Degree Pins must be specified at time of order. They can not be added after installation.</b>			

# REFRIGERATION : 30" COLUMN FREEZER

## Model Number Color & Customization Guide:

(C) 190 Standard RAL (Semi-Gloss) Colors	(CF) Specialty Finish (190 Matte RAL, Precious Metals & Textures)	(CC) Custom Color Match	(PLT) Plated Trim
--	---	-------------------------	-------------------



### FEATURES:

- Industry-leading 16.84 cu. Ft. capacity
- Available in panel-ready, stainless steel or your choice of 1,000+ colors and 10 metal trims
- Flush installation
- Automatic ice maker with Super Ice function
- Extra-bright LED lighting
- Full extension drawers
- Easy-to-use touch control panel
- Iron Clad Warranty: 2 years (full), 5 years (sealed system parts & labor) and 13 years (sealed system parts)
- Unit weight: 445 lbs.

### COLUMN JOINING KITS

Joining Kits (#700523) ship automatically with all freezer units. Contains a filler strip to conceal joint between refrigerator and freezer columns. Joining Kits for side by side refrigeration units sold separately.

### PLATED TRIM OPTIONS:

**(Includes door handle, handle ends and logo)**  
 Antique Brass, Brushed Brass, Polished Brass, Antique Copper, Brushed Copper, Polished Copper, Chrome, Oil Rubbed Bronze & Pewter

Model	Description (* Denotes item that must be specified)	UMRP	MSRP
<b>30" Column Freezer – RIGHT HINGE (See page 79 for Dual Fuel Trim Options)</b>			
BIFP30R0	Right Hinge   Panel Ready	\$ 8,995	\$ 10,345
CP30RH1	Right Door Panel   Stainless Steel   Legacy Std Trim	\$ 995	\$ 1,145
CP30RH1PLT	Right Door Panel   Stainless Steel   Legacy Pltd Trim*	\$ 2,190	\$ 2,520
CP30RH1C	Right Door Panel   Std RAL Color*   Legacy Std Trim	\$ 2,390	\$ 2,750
CP30RH1CPLT	Right Door Panel   Std RAL Color*   Legacy Pltd Trim*	\$ 3,585	\$ 4,125
CP30RH1CF	Right Door Panel   Spec Finish*   Legacy Std Trim	\$ 2,990	\$ 3,440
CP30RH1CFPLT	Right Door Panel   Spec Finish*   Legacy Pltd Trim*	\$ 4,185	\$ 4,815
CP30RH1CC	Right Door Panel   Custom Color*   Legacy Std Trim	\$ 4,290	\$ 4,935
CP30RH1CCPLT	Right Door Panel   Custom Color*   Legacy Pltd Trim*	\$ 5,485	\$ 6,310
<b>30" Column Freezer – LEFT HINGE (See page 79 for Dual Fuel Trim Options)</b>			
BIFP30L0	Left Hinge   Panel Ready	\$ 8,995	\$ 10,345
CP30LH1	Left Door Panel   Stainless Steel   Legacy Std Trim	\$ 995	\$ 1,145
CP30LH1PLT	Left Door Panel   Stainless Steel   Legacy Pltd Trim*	\$ 2,190	\$ 2,520
CP30LH1C	Left Door Panel   Std RAL Color*   Legacy Std Trim	\$ 2,390	\$ 2,750
CP30LH1CPLT	Left Door Panel   Std RAL Color*   Legacy Pltd Trim*	\$ 3,585	\$ 4,125
CP30LH1CF	Left Door Panel   Spec Finish*   Legacy Std Trim	\$ 2,990	\$ 3,440
CP30LH1CFPLT	Left Door Panel   Spec Finish*   Legacy Pltd Trim*	\$ 4,185	\$ 4,815
CP30LH1CC	Left Door Panel   Custom Color*   Legacy Std Trim	\$ 4,290	\$ 4,935
CP30LH1CCPLT	Left Door Panel   Custom Color*   Legacy Pltd Trim*	\$ 5,485	\$ 6,310
<b>Additional Options:</b>			
798803	Painted Toe-Kick Grill 30" (Note: Requires painted column unit)	\$ 235	\$ 270
950360	60" Toe Kick Grill – Panel Ready Stainless Steel	\$ 910	\$ 1,045
950361	54" Toe Kick Grill – Panel Ready Stainless Steel	\$ 880	\$ 1,010
950362	48" Toe Kick Grill – Panel Ready Stainless Steel	\$ 880	\$ 1,010
950363	42" Toe Kick Grill – Panel Ready Stainless Steel	\$ 855	\$ 985
950360C	60" Toe Kick Grill – Panel Ready Painted **	\$ 1,145	\$ 1,315
950361C	54" Toe Kick Grill – Panel Ready Painted **	\$ 1,115	\$ 1,280
950362C	48" Toe Kick Grill – Panel Ready Painted **	\$ 1,115	\$ 1,280
950363C	42" Toe Kick Grill – Panel Ready Painted **	\$ 1,090	\$ 1,255
700523	Column Joining Kit (Required for two column units to be joined – ships automatically with all freezer units)	\$ 160	\$ 185
700622	Toe Kick Filler Piece Only (Ships automatically with Column Joining Kit (#700523))	\$ 55	\$ 65
RSK-1000083	36" Column Handle Assembly, Brushed Stainless Steel	\$ 225 ea	\$ 260 ea
RSK-1000083PLT	36" Column Handle Assembly, Plated *	\$ 675 ea	\$ 775 ea
700588	90 Degree Pin   Right Door Hinges ***	\$ 415	\$ 475
700589	90 Degree Pin   Left Door Hinges ***	\$ 415	\$ 475
<b>*** 90 Degree Pins must be specified at time of order. They can not be added after installation.</b>			

# REFRIGERATION : 24" COLUMN FREEZER

Model Number Color & Customization Guide:			
(C) 190 Standard RAL (Semi-Gloss) Colors	(CF) Specialty Finish (190 Matte RAL, Precious Metals & Textures)	(CC) Custom Color Match	(PLT) Plated Trim



**FEATURES:**

- Over-sized 12.64 cu. ft. capacity
- Available in panel-ready, stainless steel or your choice of 1,000+ colors and 10 metal trims
- Flush installation
- Automatic ice maker with Super Ice function
- Extra-bright LED lighting
- Full extension drawers
- Easy-to-use touch control panel
- Iron Clad Warranty: 2 years (full), 5 years (sealed system parts & labor) and 13 years (sealed system parts)
- Unit weight: 364 lbs.

**COLUMN JOINING KITS**

Joining Kits (#700523) ship automatically with all freezer units. Contains a filler strip to conceal joint between refrigerator and freezer columns. Joining Kits for side by side refrigeration units sold separately.

**PLATED TRIM OPTIONS:**

**(Includes door handle, handle ends and logo)**  
 Antique Brass, Brushed Brass, Polished Brass, Antique Copper, Brushed Copper, Polished Copper, Chrome, Oil Rubbed Bronze & Pewter

Model	Description (* Denotes item that must be specified)	UMRP	MSRP
<b>24" Column Freezer – RIGHT HINGE (See page 79 for Dual Fuel Trim Options)</b>			
BIFP24R0	Right Hinge   Panel Ready	\$ 8,595	\$ 9,885
CP24RH1	Right Door Panel   Stainless Steel   Legacy Std Trim	\$ 795	\$ 915
CP24RH1PLT	Right Door Panel   Stainless Steel   Legacy Pltd Trim*	\$ 1,990	\$ 2,290
CP24RH1C	Right Door Panel   Std RAL Color*   Legacy Std Trim	\$ 1,890	\$ 2,175
CP24RH1CPLT	Right Door Panel   Std RAL Color*   Legacy Pltd Trim*	\$ 3,085	\$ 3,550
CP24RH1CF	Right Door Panel   Spec Finish*   Legacy Std Trim	\$ 2,390	\$ 2,750
CP24RH1CFPLT	Right Door Panel   Spec Finish*   Legacy Pltd Trim*	\$ 3,585	\$ 4,125
CP24RH1CC	Right Door Panel   Custom Color*   Legacy Std Trim	\$ 3,690	\$ 4,245
CP24RH1CCPLT	Right Door Panel   Custom Color*   Legacy Pltd Trim*	\$ 4,885	\$ 5,620
<b>24" Column Freezer – LEFT HINGE (See page 79 for Dual Fuel Trim Options)</b>			
BIFP24L0	Left Hinge   Panel Ready	\$ 8,595	\$ 9,885
CP24LH1	Left Door Panel   Stainless Steel   Legacy Std Trim	\$ 795	\$ 915
CP24LH1PLT	Left Door Panel   Stainless Steel   Legacy Pltd Trim*	\$ 1,990	\$ 2,290
CP24LH1C	Left Door Panel   Std RAL Color*   Legacy Std Trim	\$ 1,890	\$ 2,175
CP24LH1CPLT	Left Door Panel   Std RAL Color*   Legacy Pltd Trim*	\$ 3,085	\$ 3,550
CP24LH1CF	Left Door Panel   Spec Finish*   Legacy Std Trim	\$ 2,390	\$ 2,750
CP24LH1CFPLT	Left Door Panel   Spec Finish*   Legacy Pltd Trim*	\$ 3,585	\$ 4,125
CP24LH1CC	Left Door Panel   Custom Color*   Legacy Std Trim	\$ 3,690	\$ 4,245
CP24LHCCPLT	Left Door Panel   Custom Color*   Legacy Pltd Trim*	\$ 4,885	\$ 5,620
<b>Additional Options:</b>			
798804	Painted Toe-Kick Grill 24" (Note: Requires painted column unit)	\$ 235	\$ 270
950360	60" Toe Kick Grill – Panel Ready Stainless Steel	\$ 910	\$ 1,045
950361	54" Toe Kick Grill – Panel Ready Stainless Steel	\$ 880	\$ 1,010
950362	48" Toe Kick Grill – Panel Ready Stainless Steel	\$ 880	\$ 1,010
950363	42" Toe Kick Grill – Panel Ready Stainless Steel	\$ 855	\$ 985
950360C	60" Toe Kick Grill – Panel Ready Painted **	\$ 1,145	\$ 1,315
950361C	54" Toe Kick Grill – Panel Ready Painted **	\$ 1,115	\$ 1,280
950362C	48" Toe Kick Grill – Panel Ready Painted **	\$ 1,115	\$ 1,280
950363C	42" Toe Kick Grill – Panel Ready Painted **	\$ 1,090	\$ 1,255
700523	Column Joining Kit (Required for two column units to be joined – ships automatically with all freezer units)	\$ 160	\$ 185
700622	Toe Kick Filler Piece Only (Ships automatically with Column Joining Kit (#700523))	\$ 55	\$ 65
RSK-1000083	36" Column Handle Assembly, Brushed Stainless Steel	\$ 225 ea	\$ 260 ea
RSK-1000083PLT	36" Column Handle Assembly, Plated *	\$ 675 ea	\$ 775 ea
700588	90 Degree Pin   Right Door Hinges ***	\$ 415	\$ 475
700589	90 Degree Pin   Left Door Hinges ***	\$ 415	\$ 475
<b>*** 90 Degree Pins must be specified at time of order. They can not be added after installation.</b>			

# REFRIGERATION : 18" COLUMN FREEZER

Model Number Color & Customization Guide:			
(C) 190 Standard RAL (Semi-Gloss) Colors	(CF) Specialty Finish (190 Matte RAL, Precious Metals & Textures)	(CC) Custom Color Match	(PLT) Plated Trim



**FEATURES:**

- Over-sized 8.22 cu. ft. capacity
- Available in panel-ready, stainless steel or your choice of 1,000+ colors and 10 metal trims
- Flush installation
- Automatic ice maker with Super Ice function
- Extra-bright LED lighting
- Full extension drawers
- Easy-to-use touch control panel
- Iron Clad Warranty: 2 years (full), 5 years (sealed system parts & labor) and 13 years (sealed system parts)
- Unit weight: 342 lbs.

**COLUMN JOINING KITS**

Joining Kits (#700523) ship automatically with all freezer units. Contains a filler strip to conceal joint between refrigerator and freezer columns. Joining Kits for side by side refrigeration units sold separately.

**PLATED TRIM OPTIONS:**

**(Includes door handle, handle ends and logo)**  
 Antique Brass, Brushed Brass, Polished Brass, Antique Copper, Brushed Copper, Polished Copper, Chrome, Oil Rubbed Bronze & Pewter

Model	Description (* Denotes item that must be specified)	UMRP	MSRP
<b>18" Column Freezer – RIGHT HINGE (See page 79 for Dual Fuel Trim Options)</b>			
BIFP18R0	Right Hinge   Panel Ready	\$ 7,995	\$ 9,195
CP18RH1	Right Door Panel   Stainless Steel   Legacy Std Trim	\$ 795	\$ 915
CP18RH1PLT	Right Door Panel   Stainless Steel   Legacy Pltd Trim*	\$ 1,990	\$ 2,290
CP18RH1C	Right Door Panel   Std RAL Color*   Legacy Std Trim	\$ 1,890	\$ 2,175
CP18RH1CPLT	Right Door Panel   Std RAL Color*   Legacy Pltd Trim*	\$ 3,085	\$ 3,550
CP18RH1CF	Right Door Panel   Spec Finish*   Legacy Std Trim	\$ 2,390	\$ 2,750
CP18RH1CFPLT	Right Door Panel   Spec Finish*   Legacy Pltd Trim*	\$ 3,585	\$ 4,125
CP18RH1CC	Right Door Panel   Custom Color*   Legacy Std Trim	\$ 3,690	\$ 4,245
CP18RH1CCPLT	Right Door Panel   Custom Color*   Legacy Pltd Trim*	\$ 4,885	\$ 5,620
<b>18" Column Freezer – LEFT HINGE (See page 79 for Dual Fuel Trim Options)</b>			
BIFP18L0	Left Hinge   Panel Ready	\$ 7,995	\$ 9,195
CP18LH1	Left Door Panel   Stainless Steel   Legacy Std Trim	\$ 795	\$ 915
CP18LH1PLT	Left Door Panel   Stainless Steel   Legacy Pltd Trim*	\$ 1,990	\$ 2,290
CP18LH1C	Left Door Panel   Std RAL Color*   Legacy Std Trim	\$ 1,890	\$ 2,175
CP18LH1CPLT	Left Door Panel   Std RAL Color*   Legacy Pltd Trim*	\$ 3,085	\$ 3,550
CP18LH1CF	Left Door Panel   Spec Finish*   Legacy Std Trim	\$ 2,390	\$ 2,750
CP18LH1CFPLT	Left Door Panel   Spec Finish*   Legacy Pltd Trim*	\$ 3,585	\$ 4,125
CP18LH1CC	Left Door Panel   Custom Color*   Legacy Std Trim	\$ 3,690	\$ 4,245
CP18LHCCPLT	Left Door Panel   Custom Color*   Legacy Pltd Trim*	\$ 4,885	\$ 5,620
<b>Additional Options:</b>			
798805	Painted Toe-Kick Grill 18" (Note: Requires painted column unit)	\$ 235	\$ 270
950360	60" Toe Kick Grill – Panel Ready Stainless Steel	\$ 910	\$ 1,045
950361	54" Toe Kick Grill – Panel Ready Stainless Steel	\$ 880	\$ 1,010
950362	48" Toe Kick Grill – Panel Ready Stainless Steel	\$ 880	\$ 1,010
950363	42" Toe Kick Grill – Panel Ready Stainless Steel	\$ 855	\$ 985
950360C	60" Toe Kick Grill – Panel Ready Painted **	\$ 1,145	\$ 1,315
950361C	54" Toe Kick Grill – Panel Ready Painted **	\$ 1,115	\$ 1,280
950362C	48" Toe Kick Grill – Panel Ready Painted **	\$ 1,115	\$ 1,280
950363C	42" Toe Kick Grill – Panel Ready Painted **	\$ 1,090	\$ 1,255
700523	Column Joining Kit (Required for two column units to be joined – ships automatically with all freezer units)	\$ 160	\$ 185
700622	Toe Kick Filler Piece Only (Ships automatically with Column Joining Kit (#700523))	\$ 55	\$ 65
RSK-1000083	36" Column Handle Assembly, Brushed Stainless Steel	\$ 225 ea	\$ 260 ea
RSK-1000083PLT	36" Column Handle Assembly, Plated *	\$ 675 ea	\$ 775 ea
700588	90 Degree Pin   Right Door Hinges ***	\$ 415	\$ 475
700589	90 Degree Pin   Left Door Hinges ***	\$ 415	\$ 475
<b>*** 90 Degree Pins must be specified at time of order. They can not be added after installation.</b>			

## ACCESSORIES: COLUMN REFRIGERATION | DUAL FUEL TRIM OPTIONS (HANDLES/HANDLE ENDS)

DOOR PANEL   RIGHT HINGE   DUAL FUEL STYLE TRIM (HANDLES/HANDLE ENDS)				
Model	Description (* Denotes item that must be specified)	UMRP	MSRP	
<b>30" Column Refrigerator &amp; Freezer – RIGHT HINGE</b>				
CP30RH2	Right Door Panel   Stainless Steel   Dual Fuel Std	\$ 995	\$ 1,145	
CP30RH2PLT	Right Door Panel   Stainless Steel   Dual Fuel Pltd*	\$ 2,190	\$ 2,520	
CP30RH2C	Right Door Panel   Std RAL Color*   Dual Fuel Std	\$ 2,390	\$ 2,750	
CP30RH2CPLT	Right Door Panel   Std RAL Color*   Dual Fuel Pltd*	\$ 3,585	\$ 4,125	
CP30RH2CF	Right Door Panel   Spec Finish*   Dual Fuel Std	\$ 2,990	\$ 3,440	
CP30RH2CFPLT	Right Door Panel   Spec Finish*   Dual Fuel Pltd*	\$ 4,185	\$ 4,815	
CP30RH2CC	Right Door Panel   Custom Color*   Dual Fuel Std	\$ 4,290	\$ 4,935	
CP30RH2CCPLT	Right Door Panel   Custom Color*   Dual Fuel Pltd *	\$ 5,485	\$ 6,310	
<b>24" Column Refrigerator &amp; Freezer – RIGHT HINGE</b>				
CP24RH2	Right Door Panel   Stainless Steel   Dual Fuel Std	\$ 795	\$ 915	
CP24RH2PLT	Right Door Panel   Stainless Steel   Dual Fuel Pltd*	\$ 1,990	\$ 2,290	
CP24RH2C	Right Door Panel   Std RAL Color*   Dual Fuel Std	\$ 1,890	\$ 2,175	
CP24RH2CPLT	Right Door Panel   Std RAL Color*   Dual Fuel Pltd*	\$ 3,085	\$ 3,550	
CP24RH2CF	Right Door Panel   Spec Finish*   Dual Fuel Std	\$ 2,390	\$ 2,750	
CP24RH2CFPLT	Right Door Panel   Spec Finish*   Dual Fuel Pltd*	\$ 3,585	\$ 4,125	
CP24RH2CC	Right Door Panel   Custom Color*   Dual Fuel Std	\$ 3,690	\$ 4,245	
CP24RH2CCPLT	Right Door Panel   Custom Color*   Dual Fuel Pltd *	\$ 4,885	\$ 5,620	
<b>18" Column Freezer – RIGHT HINGE</b>				
CP18RH2	Right Door Panel   Stainless Steel   Dual Fuel Std	\$ 795	\$ 915	
CP18RH2PLT	Right Door Panel   Stainless Steel   Dual Fuel Pltd*	\$ 1,990	\$ 2,290	
CP18RH2C	Right Door Panel   Std RAL Color*   Dual Fuel Std	\$ 1,890	\$ 2,175	
CP18RH2CPLT	Right Door Panel   Std RAL Color*   Dual Fuel Pltd*	\$ 3,085	\$ 3,550	
CP18RH2CF	Right Door Panel   Spec Finish*   Dual Fuel Std	\$ 2,390	\$ 2,750	
CP18RH2CFPLT	Right Door Panel   Spec Finish*   Dual Fuel Pltd*	\$ 3,585	\$ 4,125	
CP18RH2CC	Right Door Panel   Custom Color*   Dual Fuel Std	\$ 3,690	\$ 4,245	
CP18RH2CCPLT	Right Door Panel   Custom Color*   Dual Fuel Pltd *	\$ 4,885	\$ 5,620	

DOOR PANEL   LEFT HINGE   DUAL FUEL STYLE TRIM (HANDLES/HANDLE ENDS)				
Model	Description (* Denotes item that must be specified)	UMRP	MSRP	
<b>30" Column Refrigerator &amp; Freezer – LEFT HINGE</b>				
CP30LH2	Left Door Panel   Stainless Steel   Dual Fuel Std	\$ 995	\$ 1,145	
CP30LH2PLT	Left Door Panel   Stainless Steel   Dual Fuel Pltd*	\$ 2,190	\$ 2,520	
CP30LH2C	Left Door Panel   Std RAL Color*   Dual Fuel Std	\$ 2,390	\$ 2,750	
CP30LH2CPLT	Left Door Panel   Std RAL Color*   Dual Fuel Pltd*	\$ 3,585	\$ 4,125	
CP30LH2CF	Left Door Panel   Spec Finish*   Dual Fuel Std	\$ 2,990	\$ 3,440	
CP30LH2CFPLT	Left Door Panel   Spec Finish*   Dual Fuel Pltd*	\$ 4,185	\$ 4,815	
CP30LH2CC	Left Door Panel   Custom Color*   Dual Fuel Std	\$ 4,290	\$ 4,935	
CP30LH2CCPLT	Left Door Panel   Custom Color*   Dual Fuel Pltd*	\$ 5,485	\$ 6,310	
<b>24" Column Refrigerator &amp; Freezer – LEFT HINGE</b>				
CP24LH2	Left Door Panel   Stainless Steel   Dual Fuel Std	\$ 795	\$ 915	
CP24LH2PLT	Left Door Panel   Stainless Steel   Dual Fuel Pltd*	\$ 1,990	\$ 2,290	
CP24LH2C	Left Door Panel   Std RAL Color*   Dual Fuel Std	\$ 1,890	\$ 2,175	
CP24LH2CPLT	Left Door Panel   Std RAL Color*   Dual Fuel Pltd*	\$ 3,085	\$ 3,550	
CP24LH2CF	Left Door Panel   Spec Finish*   Dual Fuel Std	\$ 2,390	\$ 2,750	
CP24LH2CFPLT	Left Door Panel   Spec Finish*   Dual Fuel Pltd*	\$ 3,585	\$ 4,125	
CP24LH2CC	Left Door Panel   Custom Color*   Dual Fuel Std	\$ 3,690	\$ 4,245	
CP24LH2CCPLT	Left Door Panel   Custom Color*   Dual Fuel Pltd*	\$ 4,885	\$ 5,620	
<b>18" Column Freezer – LEFT HINGE</b>				
CP18LH2	Left Door Panel   Stainless Steel   Dual Fuel Std	\$ 795	\$ 915	
CP18LH2PLT	Left Door Panel   Stainless Steel   Dual Fuel Pltd*	\$ 1,990	\$ 2,290	
CP18LH2C	Left Door Panel   Std RAL Color*   Dual Fuel Std	\$ 1,890	\$ 2,175	
CP18LH2CPLT	Left Door Panel   Std RAL Color*   Dual Fuel Pltd*	\$ 3,085	\$ 3,550	
CP18LH2CF	Left Door Panel   Spec Finish*   Dual Fuel Std	\$ 2,390	\$ 2,750	
CP18LH2CFPLT	Left Door Panel   Spec Finish*   Dual Fuel Pltd*	\$ 3,585	\$ 4,125	
CP18LH2CC	Left Door Panel   Custom Color*   Dual Fuel Std	\$ 3,690	\$ 4,245	
CP18LH2CCPLT	Left Door Panel   Custom Color*   Dual Fuel Pltd*	\$ 4,885	\$ 5,620	

# REFRIGERATION: 36" FREESTANDING COUNTER-DEPTH REFRIGERATOR WITH FREEZER

## Model Number Color & Customization Guide:

(C) 190 Standard RAL (Semi-Gloss) Colors	(CF) Specialty Finish (190 Matte RAL, Precious Metals & Textures)	(CC) Custom Color Match	(PLT) Plated Trim
--	---	-------------------------	-------------------



Model	Description (* Denotes item that must be specified)	UMRP	MSRP
<b>36" Freestanding Counter-Depth Refrigerator with Freezer</b>			
FBFD361	Freestanding   Stainless Steel   Standard Trim	\$ 4,295	\$ 4,940
FBFD361PLT	Freestanding   Stainless Steel   Plated Trim*	\$ 5,890	\$ 6,775
FBFD361PC	Freestanding   Std RAL Color*   Standard Trim	\$ 5,890	\$ 6,775
FBFD361PCPLT	Freestanding   Std RAL Color*   Plated Trim*	\$ 7,485	\$ 8,610
FBFD361PCF	Freestanding   Specialty Finish*   Standard Trim	\$ 6,390	\$ 7,350
FBFD361PCFPLT	Freestanding   Specialty Finish*   Plated Trim*	\$ 7,985	\$ 9,185
FBFD361PCC	Freestanding   Custom Color*   Standard Trim	\$ 7,590	\$ 8,730
FBFD361PCCPLT	Freestanding   Custom Color*   Plated Trim*	\$ 9,185	\$ 10,565
FBFD361PW	Freestanding   Gloss White RAL 9003   Standard Trim	\$ 4,995	\$ 5,745
FBFD361PB	Freestanding   Gloss Black RAL 9004   Standard Trim	\$ 4,995	\$ 5,745
FBFD361PMW	Freestanding   Matte White   Standard Trim	\$ 4,995	\$ 5,745
FBFD361PMB	Freestanding   Matte Black   Standard Trim	\$ 4,995	\$ 5,745
FBFD361PWPLT	Freestanding   Gloss White RAL 9003   Brushed Brass	\$ 5,995	\$ 6,895
FBFD361PBPLT	Freestanding   Gloss Black RAL 9004   Brushed Brass	\$ 5,995	\$ 6,895
FBFD361PMWPLT	Freestanding   Matte White   Brushed Brass	\$ 5,995	\$ 6,895
FBFD361PMBPLT	Freestanding   Matte Black   Brushed Brass	\$ 5,995	\$ 6,895

### FEATURES:

- Counter depth with 19.9 cu-ft of capacity
- Automatic ice maker
- Internal water dispenser
- 1,000+ Color Options
- Electronic control
- Dual evaporator
- Unit weight: 355 lbs.

### SPECIFICATIONS:

- 19.9 cu. ft. capacity
- Advanced cooling technology for optimal food preservation
- Bottom mount freezer with automatic ice maker
- Large capacity drawers
- Adjustable glass shelving
- LED lighting & digital display
- Internal water dispenser
- ENERGY STAR certified
- 1,000+ color options & 10 metal trims



# PROFESSIONAL SERIES

Get the Look: 36" Proline Vent Hood



# Choosing the Perfect Range Hood

## Everything You Need to Know

### 1. Select a Hood Style

Classic, Modern, Contemporary, Farmhouse, choose a hood style that fits best with your overall kitchen design.

### 2. Select Hood Width

The hood should be the same width as the cooking appliance below it, or up to 6" wider for maximum capture area.

### 3. Determine the Total Hood Height

Ventilation hoods should be installed 30" - 36" above the cooktop surface. Duct covers can fill any remaining space that the hood does not. See page 83 to determine if a duct cover is needed based on your ceiling height.

### 4. Calculate Hood Power Needed

Hood power is based on CFMs. To determine the CFMs needed, add the total BTU's of your cooking appliance (top burners + ovens), then divide by 150.

### 5. Choose Blower Type

In-hood, In-line and Remote blowers are available from 600 CFMs up to 1,400 CFMs.

### 6. Determine Blower Location

Your hood needs to exhaust through ducting which may be determined by existing ducting or architectural plans for a new build. First decide if this will occur through the top or rear of the hood. Then, install the correct size ducting for the shortest possible distance with the least 90 degree bends possible.

### 7. Customize Your Kitchen

Choose from over 1,000+ colors, finishes and designer metals. Accent with unlimited strapping configurations.

## DUCT COVER SELECTION GUIDE

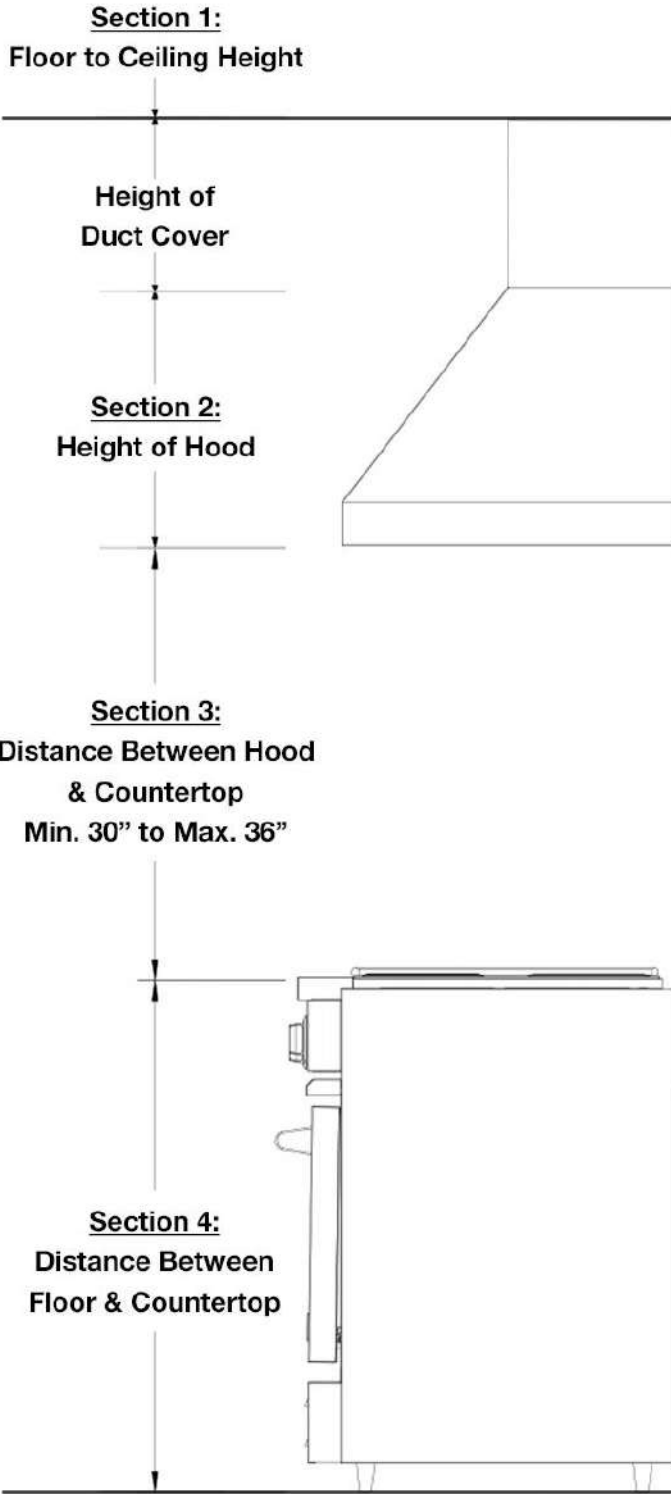

**All measurements are to be calculated in inches**

**Section 1: Floor to Ceiling Height** \_\_\_\_\_

**Subtract:**

**Section 2: Height of Hood** \_\_\_\_\_

**Section 3: Distance Between Hood and Countertop** \_\_\_\_\_  
(30" min. to 36" max)

**Section 4: Distance Between Floor and Countertop** \_\_\_\_\_

**Height of Duct Cover Needed:** \_\_\_\_\_

\* Ceiling height may be impacted by crown molding and/or soffit above the hood. Please account for this when calculating available floor to ceiling height

**Available Duct Covers:**

Page 75 Proline

Page 77 Pyramid

Page 82 Manhattan (Wall Hoods)

Page 87 Bonanza & Atlas

Page 90 Hampton, Sahara Curved & Ridgeline

Page 93 Wrangler

Page 95 Manhattan (Island Hoods)

# PROFESSIONAL SERIES: PROLINE WALL HOOD

Model Number Color & Customization Guide:			
(C) 190 Standard RAL (Semi-Gloss) Colors	(CF) Specialty Finish (190 Matte RAL, Precious Metals & Textures)	(CC) Custom Color Match	(PLT) Plated Trim



Standard Height: 18" | Bottom Depth: 24" | Top Depth: 12"

- **FEATURES:**
- Professional-grade performance with three exhaust settings and new Boost feature
- Whisper quiet operation
- Heavy duty, commercial grade materials
- Dimmable LED lighting
- Easy-to-use push-button controls
- Innovative, multi-stage grease capture system
- Stainless baffle filters seamlessly remove for easy dishwasher cleaning
- Choose from stainless steel or 1,000+ colors and finishes
- Simple installation
- 30" & 36" models: 600 CFM internal fan included **(Must be included on order)**
- Available with top or rear discharge - Discharge is field reversible.
- In-line, in-hood and remote blower compatible
- Note: Features on 24" models may vary

**CUSTOMIZATION OPTIONS:**  
1,000+ Colors & Finishes

Model	Description (* Denotes item that must be specified)	UMRP	MSRP
PL030ML	30" Proline   Stainless Steel   600 CFM Blower	\$ 2,995	\$ 3,445
PL030MLC	30" Proline   Std RAL Color*   600 CFM Blower	\$ 4,090	\$ 4,705
PL030MLCF	30" Proline   Specialty Finish*   600 CFM Blower	\$ 5,090	\$ 5,855
PL030MLCC	30" Proline   Custom Color*   600 CFM Blower	\$ 6,590	\$ 7,580
PL036ML	36" Proline   Stainless Steel   600 CFM Blower	\$ 2,995	\$ 3,445
PL036MLC	36" Proline   Std RAL Color*   600 CFM Blower	\$ 4,190	\$ 4,820
PL036MLCF	36" Proline   Specialty Finish*   600 CFM Blower	\$ 5,190	\$ 5,970
PL036MLCC	36" Proline   Custom Color*   600 CFM Blower	\$ 6,690	\$ 7,695
PL042ML	42" Proline   Stainless Steel	\$ 3,095	\$ 3,560
PL042MLC	42" Proline   Std RAL Color*	\$ 4,590	\$ 5,280
PL042MLCF	42" Proline   Specialty Finish*	\$ 5,690	\$ 6,545
PL042MLCC	42" Proline   Custom Color*	\$ 7,090	\$ 8,155
PL048ML	48" Proline   Stainless Steel	\$ 3,095	\$ 3,560
PL048MLC	48" Proline   Std RAL Color*	\$ 4,690	\$ 5,395
PL048MLCF	48" Proline   Specialty Finish*	\$ 5,790	\$ 6,660
PL048MLCC	48" Proline   Custom Color*	\$ 7,190	\$ 8,270
PL054ML	54" Proline   Stainless Steel	\$ 3,295	\$ 3,790
PL054MLC	54" Proline   Std RAL Color*	\$ 4,790	\$ 5,510
PL054MLCF	54" Proline   Specialty Finish*	\$ 5,890	\$ 6,775
PL054MLCC	54" Proline   Custom Color*	\$ 7,290	\$ 8,385
PL060ML	60" Proline   Stainless Steel	\$ 3,595	\$ 4,135
PL060MLC	60" Proline   Std RAL Color*	\$ 5,090	\$ 5,855
PL060MLCF	60" Proline   Specialty Finish*	\$ 6,190	\$ 7,120
PL060MLCC	60" Proline   Custom Color*	\$ 7,590	\$ 8,730
PL066ML	66" Proline   Stainless Steel	\$ 3,795	\$ 4,365
PL066MLC	66" Proline   Std RAL Color*	\$ 5,290	\$ 6,085
PL066MLCF	66" Proline   Specialty Finish*	\$ 6,390	\$ 7,350
PL066MLCC	66" Proline   Custom Color*	\$ 7,790	\$ 8,960
VENTILATION HOOD ACCESSORIES:			
Refer to page 75 for all Proline hood duct cover options			
Refer to page 103 for Ventilation Hood Accessories			

BLOWER OPTIONS	IN-HOOD		IN-LINE		REMOTE		DISCHARGE	
CFM POWER	600	1200	800	1200	1000	1400	TOP	REAR
MODEL #	BS-CFM-600-IN06	BS-CFM-1200-IN12	ATEX-0.8	ATEX-1.2	HYEX-1.0-GA	HYEX-1.4-GA		
UMRP	\$ 965	\$ 995	\$ 1,260	\$ 1,510	\$ 1,385	\$ 1,640		
PL030ML	•		•	•	•	•	•	Available at time of order
PL036ML	•	•	•	•	•	•	•	
PL042ML	•	•	•	•	•	•	•	
PL048ML	•	•	•	•	•	•	•	
PL054ML	•	•	•	•	•	•	•	
PL060ML	•	•	•	•	•	•	•	
PL066ML	•	•	•	•	•	•	•	

## DUCT COVERS: PROLINE WALL HOODS

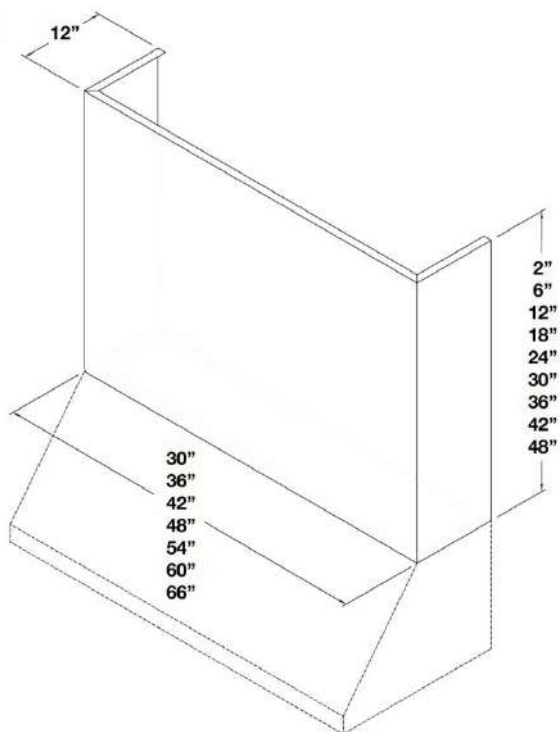

SIZE	MODEL	HEIGHT	UMRP	MSRP
Available Duct Covers for 30" Models	DCSW03002	2"	\$ 550	\$ 635
	DCSW03006	6"		
	DCSW03012	12"		
	DCSW03018	18"		
	DCSW03024	24"		
	DCSW03030	30"		
	DCSW03036	36"		
	DCSW03042	42"		
Available Duct Covers for 36" Models	DCSW03602	2"	\$ 575	\$ 660
	DCSW03606	6"		
	DCSW03612	12"		
	DCSW03618	18"		
	DCSW03624	24"		
	DCSW03630	30"		
	DCSW03636	36"		
	DCSW03642	42"		
Available Duct Covers for 42" Models	DCSW04202	2"	\$ 620	\$ 715
	DCSW04206	6"		
	DCSW04212	12"		
	DCSW04218	18"		

SIZE	MODEL	HEIGHT	UMRP	MSRP
Available Duct Covers for 42" Models	DCSW04224	24"	\$ 620	\$ 715
	DCSW04230	30"		
	DCSW04236	36"		
	DCSW04242	42"		
	DCSW04248	48"		
Available Duct Covers for 48" Models	DCSW04802	2"	\$ 690	\$ 795
	DCSW04806	6"		
	DCSW04812	12"		
	DCSW04818	18"		
	DCSW04824	24"		
	DCSW04830	30"		
	DCSW04836	36"		
	DCSW04842	42"		
DCSW04848	48"			
Available Duct Covers for 54" Models	DCSW05402	2"	\$ 715	\$ 820
	DCSW05406	6"		
	DCSW05412	12"		
	DCSW05418	18"		
	DCSW05424	24"		
	DCSW05430	30"		
Available Duct Covers for 60" Models	DCSW06002	2"	\$ 830	\$ 955
	DCSW06006	6"		
	DCSW06012	12"		
	DCSW06018	18"		
	DCSW06024	24"		
	DCSW06030	30"		
Available Duct Covers for 66" Models	DCSW06602	2"	\$ 855	\$ 985
	DCSW06606	6"		
	DCSW06612	12"		
	DCSW06618	18"		
	DCSW06624	24"		
	DCSW06630	30"		
	DCSW06636	36"		
	DCSW06642	42"		
DCSW06648	48"			

# PROFESSIONAL SERIES: PYRAMID WALL HOOD

Model Number Color & Customization Guide:			
(C) 190 Standard RAL (Semi-Gloss) Colors	(CF) Specialty Finish (190 Matte RAL, Precious Metals & Textures)	(CC) Custom Color Match	(PLT) Plated Trim



Standard Height: 18" | Bottom Depth: 24" | Top Depth: 12"

**FEATURES:**

- Professional-grade performance with three exhaust settings and new Boost feature
- Whisper quiet operation
- Heavy duty, commercial grade materials
- Dimmable LED lighting
- Easy-to-use push-button controls
- Innovative, multi-stage grease capture system
- Stainless baffle filters seamlessly remove for easy dishwasher cleaning
- Available with top or rear discharge - Discharge is field reversible.
- 30" & 36" models: 600 CFM internal fan included **(Must be included on order)**
- **Telescopic Duct DCTWxxS included.** Additional sizes available (Sold separately)
- In-line, in-hood and remote blower compatible

**CUSTOMIZATION OPTIONS:**

1,000+ Colors & Finishes

Model	Description (* Denotes item that must be specified)	UMRP	MSRP
PY030ML	30" Pyramid   Stainless Steel   600 CFM Blower	\$ 2,795	\$ 3,215
PY030MLC	30" Pyramid   Std RAL Color*   600 CFM Blower	\$ 3,990	\$ 4,590
PY030MLCF	30" Pyramid   Specialty Finish*   600 CFM Blower	\$ 4,990	\$ 5,740
PY030MLCC	30" Pyramid   Custom Color*   600 CFM Blower	\$ 6,490	\$ 7,465
PY036ML	36" Pyramid   Stainless Steel   600 CFM Blower	\$ 3,595	\$ 4,135
PY036MLC	36" Pyramid   Std RAL Color*   600 CFM Blower	\$ 4,790	\$ 5,510
PY036MLCF	36" Pyramid   Specialty Finish*   600 CFM Blower	\$ 5,790	\$ 6,660
PY036MLCC	36" Pyramid   Custom Color*   600 CFM Blower	\$ 7,290	\$ 8,385
PY042ML	42" Pyramid   Stainless Steel	\$ 3,695	\$ 4,250
PY042MLC	42" Pyramid   Std RAL Color*	\$ 5,190	\$ 5,970
PY042MLCF	42" Pyramid   Specialty Finish*	\$ 7,785	\$ 8,955
PY042MLCC	42" Pyramid   Custom Color*	\$ 11,780	\$ 13,545
PY048ML	48" Pyramid   Stainless Steel	\$ 3,795	\$ 4,365
PY048MLC	48" Pyramid   Std RAL Color*	\$ 5,290	\$ 6,085
PY048MLCF	48" Pyramid   Specialty Finish*	\$ 7,885	\$ 9,070
PY048MLCC	48" Pyramid   Custom Color*	\$ 7,790	\$ 8,960
PY054ML	54" Pyramid   Stainless Steel	\$ 3,995	\$ 4,595
PY054MLC	54" Pyramid   Std RAL Color*	\$ 5,490	\$ 6,315
PY054MLCF	54" Pyramid   Specialty Finish*	\$ 6,590	\$ 7,580
PY054MLCC	54" Pyramid   Custom Color*	\$ 7,990	\$ 9,190
PY060ML	60" Pyramid   Stainless Steel	\$ 4,595	\$ 5,285
PY060MLC	60" Pyramid   Std RAL Color*	\$ 6,090	\$ 7,005
PY060MLCF	60" Pyramid   Specialty Finish*	\$ 7,190	\$ 8,270
PY060MLCC	60" Pyramid   Custom Color*	\$ 8,590	\$ 9,880
PY066ML	66" Pyramid   Stainless Steel	\$ 4,995	\$ 5,745
PY066MLC	66" Pyramid   Std RAL Color*	\$ 6,490	\$ 7,465
PY066MLCF	66" Pyramid   Specialty Finish*	\$ 7,590	\$ 8,730
PY066MLCC	66" Pyramid   Custom Color*	\$ 8,990	\$ 10,340
VENTILATION HOOD ACCESSORIES:			
Refer to page 77 for all 1-piece Pyramid hood duct cover options			
Refer to page 103 for Ventilation Hood Accessories			

DUCT COVER OPTIONS: (Must be included on order)				
Hood	Model	Duct Height Range	UMRP	MSRP
<b>30" Models</b>	DCTW12S	Min 12" – Max 24"	N/C	N/C
	DCTW12M	Min 24" – Max 42"	\$ 895	\$ 1,030
	DCTW12T	Min 42" – Max 60"	\$ 1,495	\$ 1,720
<b>36" – 54" Models</b>	DCTW18S	Min 12" – Max 24"	N/C	N/C
	DCTW18M	Min 24" – Max 42"	\$ 1,095	\$ 1,260
	DCTW18T	Min 42" – Max 60"	\$ 1,595	\$ 1,835
<b>60" – 66" Models</b>	DCTW24S	Min 12" – Max 24"	N/C	N/C
	DCTW24M	Min 24" – Max 42"	\$ 1,250	\$ 1,440
	DCTW24T	Min 42" – Max 60"	\$ 1,695	\$ 1,950

BLOWER OPTIONS	IN-HOOD		IN-LINE		REMOTE		DISCHARGE	
CFM POWER	600	1200	800	1200	1000	1400	TOP	REAR
MODEL #	BS-CFM-600-IN06	BS-CFM-1200-IN12	ATEX-0.8	ATEX-1.2	HYEX-1.0-GA	HYEX-1.4-GA		
UMRP	\$ 965	\$ 995	\$ 1,260	\$ 1,510	\$ 1,385	\$ 1,640		
PY030ML	•	•	•	•	•	•	Available at time of order	
PY036ML	•	•	•	•	•	•		
PY042ML	•	•	•	•	•	•		
PY048ML	•	•	•	•	•	•		
PY054ML	•	•	•	•	•	•		
PY060ML	•	•	•	•	•	•		
PY066ML	•	•	•	•	•	•		

## DUCT COVERS (ONE-PIECE): PYRAMID WALL HOODS

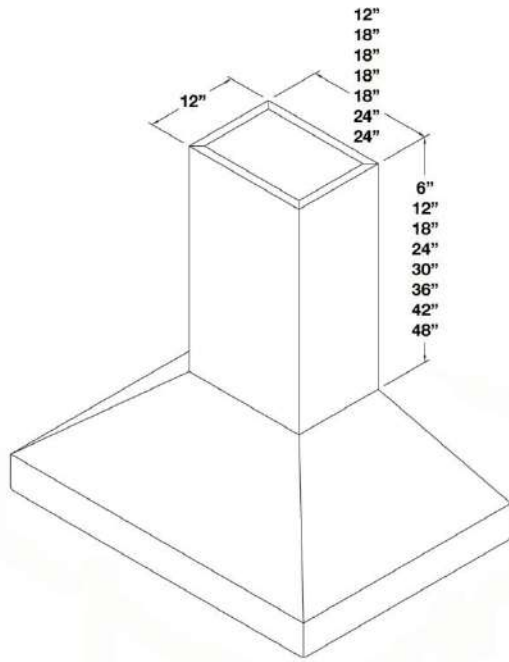

SIZE	MODEL	HEIGHT	UMRP	MSRP
Available Duct Covers for 30" Models	DCCW03006	6"	\$ 885	\$ 1,020
	DCCW03012	12"	\$ 965	\$ 1,110
	DCCW03018	18"	\$ 1,065	\$ 1,225
	DCCW03024	24"	\$ 1,160	\$ 1,335
	DCCW03030	30"	\$ 1,250	\$ 1,440
	DCCW03036	36"	\$ 1,340	\$ 1,540
	DCCW03042	42"	\$ 1,445	\$ 1,660
	DCCW03048	48"	\$ 1,525	\$ 1,755
Available Duct Covers for 36" Models	DCCW03606	6"	\$ 885	\$ 1,020
	DCCW03612	12"	\$ 965	\$ 1,110
	DCCW03618	18"	\$ 1,065	\$ 1,225
	DCCW03624	24"	\$ 1,160	\$ 1,335
	DCCW03630	30"	\$ 1,250	\$ 1,440
	DCCW03636	36"	\$ 1,340	\$ 1,540
	DCCW03642	42"	\$ 1,445	\$ 1,660
	DCCW03648	48"	\$ 1,525	\$ 1,755
Available Duct Covers for 42" Models	DCCW04206	6"	\$ 885	\$ 1,020
	DCCW04212	12"	\$ 965	\$ 1,110
	DCCW04218	18"	\$ 1,065	\$ 1,225
	DCCW04224	24"	\$ 1,160	\$ 1,335
	DCCW04230	30"	\$ 1,250	\$ 1,440
	DCCW04236	36"	\$ 1,340	\$ 1,540
	DCCW04242	42"	\$ 1,445	\$ 1,660
	DCCW04248	48"	\$ 1,525	\$ 1,755

SIZE	MODEL	HEIGHT	UMRP	MSRP
Available Duct Covers for 48" Models	DCCW04806	6"	\$ 885	\$ 1,020
	DCCW04812	12"	\$ 965	\$ 1,110
	DCCW04818	18"	\$ 1,065	\$ 1,225
	DCCW04824	24"	\$ 1,160	\$ 1,335
	DCCW04830	30"	\$ 1,250	\$ 1,440
	DCCW04836	36"	\$ 1,340	\$ 1,540
	DCCW04842	42"	\$ 1,445	\$ 1,660
DCCW04848	48"	\$ 1,525	\$ 1,755	
Available Duct Covers for 54" Models	DCCW05406	6"	\$ 885	\$ 1,020
	DCCW05412	12"	\$ 965	\$ 1,110
	DCCW05418	18"	\$ 1,065	\$ 1,225
	DCCW05424	24"	\$ 1,160	\$ 1,335
	DCCW05430	30"	\$ 1,250	\$ 1,440
	DCCW05436	36"	\$ 1,340	\$ 1,540
	DCCW05442	42"	\$ 1,445	\$ 1,660
DCCW05448	48"	\$ 1,525	\$ 1,755	
Available Duct Covers for 60" Models	DCCW06006	6"	\$ 885	\$ 1,020
	DCCW06012	12"	\$ 965	\$ 1,110
	DCCW06018	18"	\$ 1,065	\$ 1,225
	DCCW06024	24"	\$ 1,160	\$ 1,335
	DCCW06030	30"	\$ 1,250	\$ 1,440
	DCCW06036	36"	\$ 1,340	\$ 1,540
	DCCW06042	42"	\$ 1,445	\$ 1,660
DCCW06048	48"	\$ 1,525	\$ 1,755	
Available Duct Covers for 66" Models	DCCW06606	6"	\$ 885	\$ 1,020
	DCCW06612	12"	\$ 965	\$ 1,110
	DCCW06618	18"	\$ 1,065	\$ 1,225
	DCCW06624	24"	\$ 1,160	\$ 1,335
	DCCW06630	30"	\$ 1,250	\$ 1,440
	DCCW06636	36"	\$ 1,340	\$ 1,540
	DCCW06642	42"	\$ 1,445	\$ 1,660
DCCW06648	48"	\$ 1,525	\$ 1,755	

# PROFESSIONAL SERIES: LOW PROFILE WALL HOOD & METAL LINERS

Model Number Color & Customization Guide:			
(C) 190 Standard RAL (Semi-Gloss) Colors	(CF) Specialty Finish (190 Matte RAL, Precious Metals & Textures)	(CC) Custom Color Match	(PLT) Plated Trim



Standard Height: 10" | Bottom Depth: 24" | Top Depth: 12"

### FEATURES:

- Commercial grade stainless steel construction
- 600 CFM internal fan included (Only blower option available for this model)
- Welded seamless corners
- Dishwasher safe stainless steel baffles
- 3-speed blower/variable light control

### CUSTOMIZATION OPTIONS:

- 1,000+ Colors & Finishes

Model	Description (* Denotes item that must be specified)	UMRP	MSRP
LP030LP	30" Low Profile   Stainless Steel   600 CFM Blower	\$ 2,095	\$ 2,410
LP030LPC	30" Low Profile   Std RAL Color*   600 CFM Blower	\$ 3,290	\$ 3,785
LP030LPCF	30" Low Profile   Specialty Finish*   600 CFM Blower	\$ 4,290	\$ 4,935
LP030LPCC	30" Low Profile   Custom Color*   600 CFM Blower	\$ 5,790	\$ 6,660
LP036LP	36" Low Profile   Stainless Steel   600 CFM Blower	\$ 2,295	\$ 2,640
LP036LPC	36" Low Profile   Std RAL Color*   600 CFM Blower	\$ 3,490	\$ 4,015
LP036LPCF	36" Low Profile   Specialty Finish*   600 CFM Blower	\$ 4,490	\$ 5,165
LP036LPCC	36" Low Profile   Custom Color*   600 CFM Blower	\$ 5,990	\$ 6,890



### FEATURES:

- Professional-grade performance with three exhaust settings and new Boost feature
- Whisper quiet operation
- Heavy duty, commercial grade materials
- Dimmable LED lighting
- Easy-to-use push-button controls
- Innovative, multi-stage grease capture system
- Stainless baffle filters seamlessly remove for easy dishwasher cleaning
- Simple installation
- 28" & 34" models: 600 CFM internal fan included (**Must be included on order**)
- Available with top or rear discharge - Discharge is field reversible.
- In-line, in-hood and remote blower compatible

Model	Description (* Denotes item that must be specified)	UMRP	MSRP
PM028ML	28" Metal Liner   600 CFM Blower   26 5/8" x 22 1/8" x 16 1/4"	\$ 1,650	\$ 1,895
PM034ML	34" Metal Liner   600 CFM Blower   33 5/8" x 22 1/8" x 16 1/4"	\$ 1,650	\$ 1,895
PM040ML	40" Metal Liner   39 5/8" x 22 1/8" x 16 1/4"	\$ 1,650	\$ 1,895
PM046ML	46" Metal Liner   45 7/16" x 22 1/8" x 16 1/4"	\$ 1,850	\$ 2,130
PM052ML	52" Metal Liner   51 7/16" x 22 1/8" x 16 1/4"	\$ 1,850	\$ 2,130
PM058ML	58" Metal Liner   57 1/4" x 22 1/8" x 16 1/4"	\$ 1,850	\$ 2,130
PM064ML	64" Metal Liner   63 1/4" x 22 1/8" x 16 1/4"	\$ 2,095	\$ 2,410
PM070ML	70" Metal Liner   67 1/4" x 22 1/8" x 16 1/4"	\$ 2,395	\$ 2,755

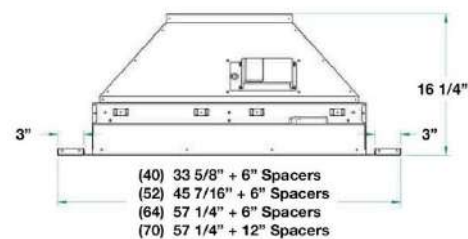

BLOWER OPTIONS	IN-HOOD		IN-LINE		REMOTE		DISCHARGE	
CFM POWER	600	1200	800	1200	1000	1400	TOP	REAR
MODEL #	BS-CFM-600-IN06	BS-CFM-1200-IN12	ATEX-0.8	ATEX-1.2	HYEX-1.0-GA	HYEX-1.4-GA		
UMRP	\$ 965	\$ 995	\$ 1,260	\$ 1,510	\$ 1,385	\$ 1,640	Available at time of order	
28" Liners	•	•	•	•	•	•		
34" Liners	•	•	•	•	•	•		
40" Liners	•	•	•	•	•	•		
46" Liners	•	•	•	•	•	•		
52" Liners	•	•	•	•	•	•		
58" Liners	•	•	•	•	•	•		
64" Liners	•	•	•	•	•	•		
70" Liners	•	•	•	•	•	•		



## DESIGNER SERIES

Get the Look: 60" Atlas Vent Hood in Matte Black with Brushed Brass Trim

## DESIGNER SERIES: CUSTOMIZATION OPTIONS



### 1,000 + COLORS & FINISHES

BlueStar appliances are available in a painter's palette of colors and finishes. Select from 1,000+ colors plus matte and textured finishes to turn up the heat on discerning kitchen design.



### DESIGNER METALS

Outfit your hood in our collection of Designer Metal finishes like brushed brass, polished brass and copper. Add these luxury finishes to create a kitchen hood worthy of your personal signature and style.



### CUSTOM STRAPPING & RIVETS

Customize your ventilation hood with one of our standard strapping layouts or choose your own. All strapping is available in the Designer Metals above or painted in one of our standard 190 RAL colors. Request a quote from our ventilation team at [quote@bluestarcooking.com](mailto:quote@bluestarcooking.com)



### CUSTOM SIZES

Customize the height or depth of your ventilation hood to accommodate your unique kitchen design. Request a quote from our ventilation team at [quote@bluestarcooking.com](mailto:quote@bluestarcooking.com)

# DESIGNER SERIES: MANHATTAN WALL HOODS

**Model Number Color & Customization Guide:**

<b>(C)</b> 190 Standard RAL (Semi-Gloss) Colors	<b>(CF)</b> Specialty Finish (190 Matte RAL, Precious Metals & Textures)	<b>(CC)</b> Custom Color Match	<b>(PLT)</b> Custom Only
---	--	--------------------------------	--------------------------



Standard Height: 6 1/4" | Standard Depth: 24"

**FEATURES:**

- Professional-grade performance with three exhaust settings and new Boost feature
- Whisper quiet operation
- Heavy duty, commercial grade materials
- Dimmable LED lighting
- Easy-to-use push-button controls
- Innovative, multi-stage grease capture system
- Stainless baffle filters seamlessly remove for easy dishwasher cleaning
- Choose from stainless steel or 1,000+ colors and finishes
- Simple installation
- 30" & 36" models: 600 CFM internal fan included **(Must be included on order)**
- Accommodates top discharge only
- Included duct cover heights: 18", 24", 30" & 36" **(Must be specified on order.)**
- In-line, in-hood and remote blower compatible

**CUSTOMIZATION OPTIONS:**

- 1,000+ Colors & Finishes
- Designer Metals like brass & copper
- Custom strapping & rivets
- Full custom options

*(\*) Trim finishes on Cooking & Refrigeration products are different substrates than the trim finishes on Ventilation hoods. Due to these differing processes and substrates the finishes will coordinate but may not match exactly.*

**NOTE: HOOD MUST BE MOUNTED TO CEILING AND CEILING ACCESS MAY BE REQUIRED. PLEASE REFERENCE THE INSTALLATION MANUAL ON BLUESTARCOOKING.COM FOR DETAILS**

**NOTE: MUST ORDER DUCT COVER FOR BLOWER & MOUNTING PURPOSES. MINIMUM 18" HIGH**

Model	Description (* Denotes item that must be specified)	UMRP	MSRP
MH030MA	30" Manhattan   Stainless Steel   600 CFM Blower	\$ 2,995	\$ 3,445
MH030MAC	30" Manhattan   Std RAL Color*   600 CFM Blower	\$ 4,190	\$ 4,820
MH030MACF	30" Manhattan   Specialty Finish*   600 CFM Blower	\$ 5,190	\$ 5,970
MH030MACC	30" Manhattan   Custom Color*   600 CFM Blower	\$ 6,690	\$ 7,695
MH036MA	36" Manhattan   Stainless Steel   600 CFM Blower	\$ 3,495	\$ 4,020
MH036MAC	36" Manhattan   Std RAL Color*   600 CFM Blower	\$ 4,690	\$ 5,395
MH036MACF	36" Manhattan   Specialty Finish*   600 CFM Blower	\$ 5,690	\$ 6,545
MH036MACC	36" Manhattan   Custom Color*   600 CFM Blower	\$ 7,190	\$ 8,270
MH042MA	42" Manhattan   Stainless Steel	\$ 3,795	\$ 4,365
MH042MAC	42" Manhattan   Std RAL Color*	\$ 5,290	\$ 6,085
MH042MACF	42" Manhattan   Specialty Finish*	\$ 6,390	\$ 7,350
MH042MACC	42" Manhattan   Custom Color*	\$ 7,790	\$ 8,960
MH048MA	48" Manhattan   Stainless Steel	\$ 3,995	\$ 4,595
MH048MAC	48" Manhattan   Std RAL Color*	\$ 5,490	\$ 6,315
MH048MACF	48" Manhattan   Specialty Finish*	\$ 6,590	\$ 7,580
MH048MACC	48" Manhattan   Custom Color*	\$ 7,990	\$ 9,190
MH054MA	54" Manhattan   Stainless Steel	\$ 5,195	\$ 5,975
MH054MAC	54" Manhattan   Std RAL Color*	\$ 6,690	\$ 7,695
MH054MACF	54" Manhattan   Specialty Finish*	\$ 7,790	\$ 8,960
MH054MACC	54" Manhattan   Custom Color*	\$ 9,190	\$ 10,570
MH060MA	60" Manhattan   Stainless Steel	\$ 5,595	\$ 6,435
MH060MAC	60" Manhattan   Std RAL Color*	\$ 7,090	\$ 8,155
MH060MACF	60" Manhattan   Specialty Finish*	\$ 8,190	\$ 9,420
MH060MACC	60" Manhattan   Custom Color*	\$ 9,590	\$ 11,030
MH066MA	66" Manhattan   Stainless Steel	\$ 5,695	\$ 6,550
MH066MAC	66" Manhattan   Std RAL Color*	\$ 7,190	\$ 8,270
MH066MACF	66" Manhattan   Specialty Finish*	\$ 8,290	\$ 9,535
MH066MACC	66" Manhattan   Custom Color*	\$ 9,690	\$ 11,145

**DUCT COVERS FOR MANHATTAN HOODS:**

Refer to page 82 for all Manhattan hood duct cover options  
 • Included duct cover heights: 18", 24", 30" & 36" | Also available in 42" & 48" for additional charge

Refer to page 103 for Ventilation Hood Accessories

BLOWER OPTIONS	IN-HOOD		IN-LINE		REMOTE		DISCHARGE	
CFM POWER	600	1200	800	1200	1000	1400	TOP	REAR
MODEL #	BS-CFM-600-IN06	BS-CFM-1200-IN12	ATEX-0.8	ATEX-1.2	HYEX-1.0-GA	HYEX-1.4-GA		
UMRP	\$ 965	\$ 995	\$ 1,260	\$ 1,510	\$ 1,385	\$ 1,640		
MH030MA	•		•				•	
MH036MA	•		•				•	
MH042MA	•		•				•	
MH048MA	•	•	•	•	•	•	•	
MH054MA	•	•	•	•	•	•	•	
MH060MA	•	•	•	•	•	•	•	
MH066MA	•	•	•	•	•	•	•	

## DUCT COVERS: MANHATTAN WALL HOODS

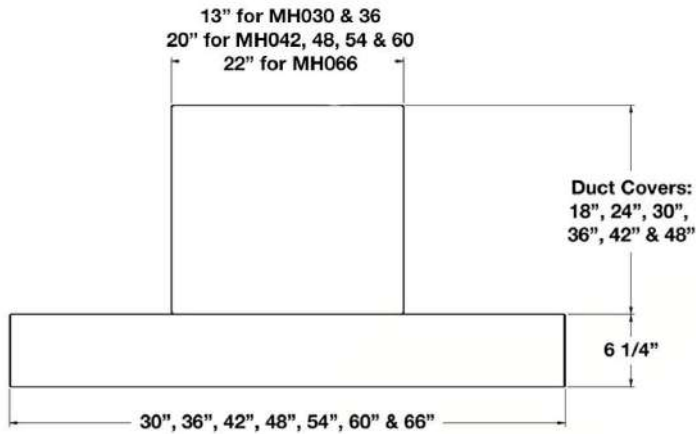

**NOTE: 18", 24", 30" & 36" DUCT COVERS INCLUDED WITH HOOD AT NO CHARGE. BELOW PRICING IS IF PURCHASED SEPARATELY.**

**NOTE: HOOD MUST BE MOUNTED TO CEILING AND CEILING ACCESS MAY BE REQUIRED. PLEASE REFERENCE THE INSTALLATION MANUAL ON BLUESTARCOOKING.COM FOR DETAILS**

**NOTE: MUST ORDER DUCT COVER FOR BLOWER & MOUNTING PURPOSES. MINIMUM 18" HIGH**

SIZE	MODEL	HEIGHT	UMRP	MSRP
<b>Available Duct Covers for 30" Models</b>	DCMW03018	18"	\$ 690	\$ 795
	DCMW03024	24"	\$ 760	\$ 875
	DCMW03030	30"	\$ 830	\$ 955
	DCMW03036	36"	\$ 895	\$ 1,030
	DCMW03042	42"	\$ 965	\$ 1,110
	DCMW03048	48"	\$ 1,035	\$ 1,190
<b>Available Duct Covers for 36" Models</b>	DCMW03618	18"	\$ 690	\$ 795
	DCMW03624	24"	\$ 760	\$ 875
	DCMW03630	30"	\$ 830	\$ 955
	DCMW03636	36"	\$ 895	\$ 1,030
	DCMW03642	42"	\$ 965	\$ 1,110
	DCMW03648	48"	\$ 1,035	\$ 1,190
<b>Available Duct Covers for 42" Models</b>	DCMW04218	18"	\$ 690	\$ 795
	DCMW04224	24"	\$ 760	\$ 875
	DCMW04230	30"	\$ 830	\$ 955
	DCMW04236	36"	\$ 895	\$ 1,030
	DCMW04242	42"	\$ 965	\$ 1,110
	DCMW04248	48"	\$ 1,035	\$ 1,190
<b>Available Duct Covers for 48" Models</b>	DCMW04818	18"	\$ 690	\$ 795
	DCMW04824	24"	\$ 760	\$ 875
	DCMW04830	30"	\$ 830	\$ 955
	DCMW04836	36"	\$ 895	\$ 1,030
	DCMW04842	42"	\$ 965	\$ 1,110
	DCMW04848	48"	\$ 1,035	\$ 1,190

SIZE	MODEL	HEIGHT	UMRP	MSRP
<b>Available Duct Covers for 54" Models</b>	DCMW05418	18"	\$ 690	\$ 795
	DCMW05424	24"	\$ 760	\$ 875
	DCMW05430	30"	\$ 830	\$ 955
	DCMW05436	36"	\$ 895	\$ 1,030
	DCMW05442	42"	\$ 965	\$ 1,110
	DCMW05448	48"	\$ 1,035	\$ 1,190
<b>Available Duct Covers for 60" Models</b>	DCMW06018	18"	\$ 690	\$ 795
	DCMW06024	24"	\$ 760	\$ 875
	DCMW06030	30"	\$ 830	\$ 955
	DCMW06036	36"	\$ 895	\$ 1,030
	DCMW06042	42"	\$ 965	\$ 1,110
<b>Available Duct Covers for 66" Models</b>	DCMW06048	48"	\$ 1,035	\$ 1,190
	DCMW06618	18"	\$ 690	\$ 795
	DCMW06624	24"	\$ 760	\$ 875
	DCMW06630	30"	\$ 830	\$ 955
	DCMW06636	36"	\$ 895	\$ 1,030
<b>Available Duct Covers for 66" Models</b>	DCMW06642	42"	\$ 965	\$ 1,110
	DCMW06648	48"	\$ 1,035	\$ 1,190

## DESIGNER SERIES: HAMPTON WALL HOODS

Model Number Color & Customization Guide:				
(C) 190 Standard RAL (Semi-Gloss) Colors	(CF) Specialty Finish (190 Matte RAL, Precious Metals & Textures)	(CC) Custom Color Match	(PLT) Stainless Steel Straps & Rivets	(D) Designer Metal Straps & Rivets



Standard Height: 18" | Bottom Depth: 24 1/4" | Top Depth: 12"

### FEATURES:

- Professional-grade performance with three exhaust settings and new Boost feature
- Whisper quiet operation
- Heavy duty, commercial grade materials
- Dimmable LED lighting
- Easy-to-use push-button controls
- Innovative, multi-stage grease capture system
- Stainless baffle filters seamlessly remove for easy dishwasher cleaning
- Choose from stainless steel or 1,000+ colors and finishes
- Simple installation
- 30" & 36" models: 600 CFM internal fan included **(Must be included on order)**
- Included duct cover heights: 6", 12", 18", 24" or 30". Must be specified on order.
- Available with top or rear discharge - Discharge is field reversible.
- In-line, in-hood and remote blower compatible

### CUSTOMIZATION OPTIONS:

- 1,000+ Colors & Finishes
- Designer Metals like brass & copper
- Custom strapping & rivets
- Full custom options

(\*) Trim finishes on Cooking & Refrigeration products are different substrates than the trim finishes on Ventilation hoods. Due to these differing processes and substrates the finishes will coordinate but may not match exactly.

Model	Description (* Denotes item that must be specified)	UMRP	MSRP	
<b>30" HAMPTON HOODS:</b>				
HA030MLPLT	Body: Stainless Steel   Strap/Rivets: Stainless Steel   600 CFM	\$ 3,495	\$ 4,020	
HA030MLPLTD	Body: Stainless Steel   Strap/Rivets: Des. Metal*   600 CFM	\$ 3,790	\$ 4,390	
HA030MLPLTLC	Body: Std RAL Color*   Strap/Rivets: Stainless Steel   600 CFM	\$ 4,690	\$ 5,395	
HA030MLPLTDC	Body: Std RAL Color*   Strap/Rivets: Des Metal*   600 CFM	\$ 4,985	\$ 5,735	
HA030MLPLTCF	Body: Spec. Finish*   Strap/Rivets: Stainless Steel   600 CFM	\$ 5,690	\$ 6,545	
HA030MLPLTDCF	Body: Spec. Finish*   Strap/Rivets: Des. Metal*   600 CFM	\$ 5,985	\$ 6,885	
HA030MLPLTCC	Body: Custom Color*   Strap/Rivets: Stainless Steel   600 CFM	\$ 7,190	\$ 8,270	
HA030MLPLTDCC	Body: Custom Color*   Strap/Rivets: Des. Metal*   600 CFM	\$ 7,485	\$ 8,610	
<b>36" HAMPTON HOODS:</b>				
HA036MLPLT	Body: Stainless Steel   Strap/Rivets: Stainless Steel   600 CFM	\$ 3,995	\$ 4,595	
HA036MLPLTD	Body: Stainless Steel   Strap/Rivets: Des. Metal*   600 CFM	\$ 4,390	\$ 5,050	
HA036MLPLTLC	Body: Std RAL Color*   Strap/Rivets: Stainless Steel   600 CFM	\$ 5,190	\$ 5,970	
HA036MLPLTDC	Body: Std RAL Color*   Strap/Rivets: Des Metal*   600 CFM	\$ 5,585	\$ 6,425	
HA036MLPLTCF	Body: Spec. Finish*   Strap/Rivets: Stainless Steel   600 CFM	\$ 6,190	\$ 7,120	
HA036MLPLTDCF	Body: Spec. Finish*   Strap/Rivets: Des. Metal*   600 CFM	\$ 6,585	\$ 7,575	
HA036MLPLTCC	Body: Custom Color*   Strap/Rivets: Stainless Steel   600 CFM	\$ 7,690	\$ 8,845	
HA036MLPLTDCC	Body: Custom Color*   Strap/Rivets: Des. Metal*   600 CFM	\$ 8,085	\$ 9,300	
<b>DESIGNER METAL OPTIONS FOR STRAPPING &amp; RIVETS:</b>				
Brushed Stainless	Polished Stainless	Antique Brass	Brushed Brass	Polished Brass
Antique Copper	Brushed Copper	Polished Copper	Oil Rubbed Bronze	Pewter
<b>VENTILATION HOOD ACCESSORIES:</b>				
Refer to page 90 for all Hampton hood duct cover options				
Refer to page 103 for Ventilation Hood Accessories				

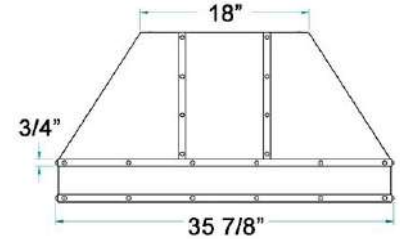
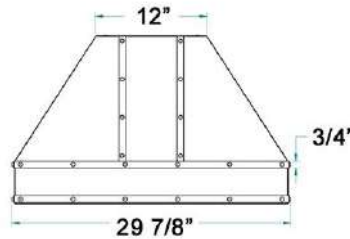

BLOWER OPTIONS	IN-HOOD		IN-LINE		REMOTE		DISCHARGE	
CFM POWER	600	1200	800	1200	1000	1400	TOP	REAR
MODEL #	BS-CFM-600-IN06	BS-CFM-1200-IN12	ATEX-0.8	ATEX-1.2	HYEX-1.0-GA	HYEX-1.4-GA		
UMRP	\$ 965	\$ 995	\$ 1,260	\$ 1,510	\$ 1,385	\$ 1,640	Available at time of order	
HA030MLPLT	•		•	•	•	•		
HA036MLPLT	•	•	•	•	•	•		
HA042MLPLT	•	•	•	•	•	•		
HA048MLPLT	•	•	•	•	•	•		
HA054MLPLT	•	•	•	•	•	•		
HA060MLPLT	•	•	•	•	•	•		
HA066MLPLT	•	•	•	•	•	•		

## DESIGNER SERIES: 42", 48", 54" & 60" HAMPTON WALL HOODS

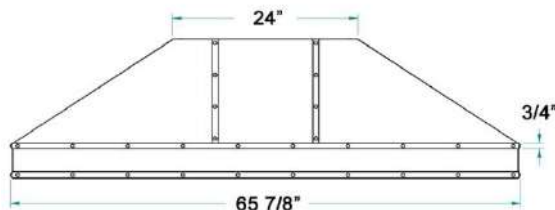
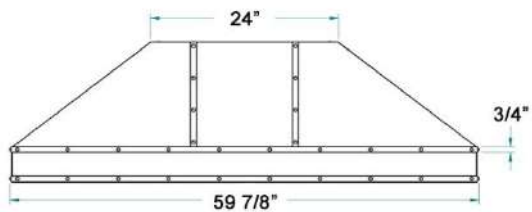
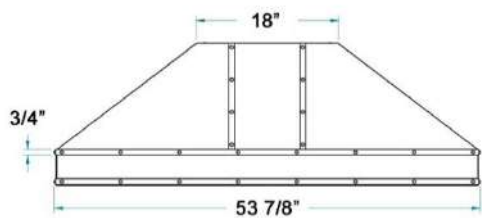
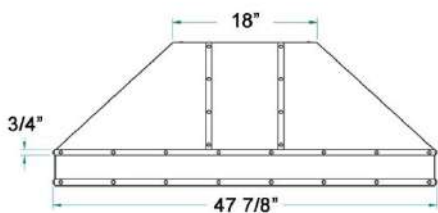
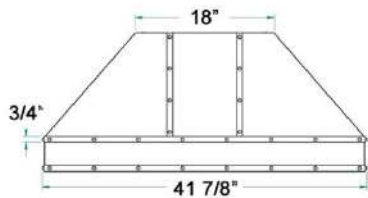

42" HAMPTON HOODS		UMRP	MSRP
HA042MLPLT	Body: Stainless Steel   Strap/Rivets: Stainless Steel	\$ 4,495	\$ 5,170
HA042MLPLTD	Body: Stainless Steel   Strap/Rivets: Des. Metal*	\$ 4,890	\$ 5,625
HA042MLPLTC	Body: Std RAL Color*   Strap/Rivets: Stainless Steel	\$ 5,990	\$ 6,890
HA042MLPLTDC	Body: Std RAL Color*   Strap/Rivets: Des Metal*	\$ 6,385	\$ 7,345
HA042MLPLTCF	Body: Spec. Finish*   Strap/Rivets: Stainless Steel	\$ 7,090	\$ 8,155
HA042MLPLTDCF	Body: Spec. Finish*   Strap/Rivets: Des. Metal*	\$ 7,485	\$ 8,610
HA042MLPLTCC	Body: Custom Color*   Strap/Rivets: Stainless Steel	\$ 8,490	\$ 9,765
HA042MLPLTDCC	Body: Custom Color*   Strap/Rivets: Des. Metal*	\$ 8,885	\$ 10,220
48" HAMPTON HOODS		UMRP	MSRP
HA048MLPLT	Body: Stainless Steel   Strap/Rivets: Stainless Steel	\$ 4,795	\$ 5,515
HA048MLPLTD	Body: Stainless Steel   Strap/Rivets: Des. Metal*	\$ 5,190	\$ 5,970
HA048MLPLTC	Body: Std RAL Color*   Strap/Rivets: Stainless Steel	\$ 6,290	\$ 7,235
HA048MLPLTDC	Body: Std RAL Color*   Strap/Rivets: Des Metal*	\$ 6,685	\$ 7,690
HA048MLPLTCF	Body: Spec. Finish*   Strap/Rivets: Stainless Steel	\$ 7,390	\$ 8,500
HA048MLPLTDCF	Body: Spec. Finish*   Strap/Rivets: Des. Metal*	\$ 7,785	\$ 8,955
HA048MLPLTCC	Body: Custom Color*   Strap/Rivets: Stainless Steel	\$ 8,790	\$ 10,110
HA048MLPLTDCC	Body: Custom Color*   Strap/Rivets: Des. Metal*	\$ 9,185	\$ 10,565
54" HAMPTON HOODS		UMRP	MSRP
HA054MLPLT	Body: Stainless Steel   Strap/Rivets: Stainless Steel	\$ 4,995	\$ 5,745
HA054MLPLTD	Body: Stainless Steel   Strap/Rivets: Des. Metal*	\$ 5,390	\$ 6,200
HA054MLPLTC	Body: Std RAL Color*   Strap/Rivets: Stainless Steel	\$ 6,490	\$ 7,465
HA054MLPLTDC	Body: Std RAL Color*   Strap/Rivets: Des Metal*	\$ 6,885	\$ 7,920
HA054MLPLTCF	Body: Spec. Finish*   Strap/Rivets: Stainless Steel	\$ 7,590	\$ 8,730
HA054MLPLTDCF	Body: Spec. Finish*   Strap/Rivets: Des. Metal*	\$ 7,985	\$ 9,185
HA054MLPLTCC	Body: Custom Color*   Strap/Rivets: Stainless Steel	\$ 8,990	\$ 10,340
HA054MLPLTDCC	Body: Custom Color*   Strap/Rivets: Des. Metal*	\$ 9,385	\$ 10,795
60" HAMPTON HOODS		UMRP	MSRP
HA060MLPLT	Body: Stainless Steel   Strap/Rivets: Stainless Steel	\$ 5,395	\$ 6,205
HA060MLPLTD	Body: Stainless Steel   Strap/Rivets: Des. Metal*	\$ 5,790	\$ 6,660
HA060MLPLTC	Body: Std RAL Color*   Strap/Rivets: Stainless Steel	\$ 6,890	\$ 7,925
HA060MLPLTDC	Body: Std RAL Color*   Strap/Rivets: Des Metal*	\$ 7,285	\$ 8,380
HA060MLPLTCF	Body: Spec. Finish*   Strap/Rivets: Stainless Steel	\$ 7,990	\$ 9,190
HA060MLPLTDCF	Body: Spec. Finish*   Strap/Rivets: Des. Metal*	\$ 8,385	\$ 9,645
HA060MLPLTCC	Body: Custom Color*   Strap/Rivets: Stainless Steel	\$ 9,390	\$ 10,800
HA060MLPLTDCC	Body: Custom Color*   Strap/Rivets: Des. Metal*	\$ 9,785	\$ 11,255
66" HAMPTON HOODS		UMRP	MSRP
HA066MLPLT	Body: Stainless Steel   Strap/Rivets: Stainless Steel	\$ 5,595	\$ 6,435
HA066MLPLTD	Body: Stainless Steel   Strap/Rivets: Des. Metal*	\$ 5,990	\$ 6,890
HA066MLPLTC	Body: Std RAL Color*   Strap/Rivets: Stainless Steel	\$ 7,090	\$ 8,155
HA066MLPLTDC	Body: Std RAL Color*   Strap/Rivets: Des Metal*	\$ 7,485	\$ 8,610
HA066MLPLTCF	Body: Spec. Finish*   Strap/Rivets: Stainless Steel	\$ 8,190	\$ 9,420
HA066MLPLTDCF	Body: Spec. Finish*   Strap/Rivets: Des. Metal*	\$ 8,585	\$ 9,875
HA066MLPLTCC	Body: Custom Color*   Strap/Rivets: Stainless Steel	\$ 9,590	\$ 11,030
HA066MLPLTDCC	Body: Custom Color*   Strap/Rivets: Des. Metal*	\$ 9,985	\$ 11,485

## DESIGNER SERIES: 30" & 36" BONANZA WALL HOODS

Model Number Color & Customization Guide:				
(C) 190 Standard RAL (Semi-Gloss) Colors	(CF) Specialty Finish (190 Matte RAL, Precious Metals & Textures)	(CC) Custom Color Match	(PLT) Stainless Steel Straps & Rivets	(D) Designer Metal Straps & Rivets

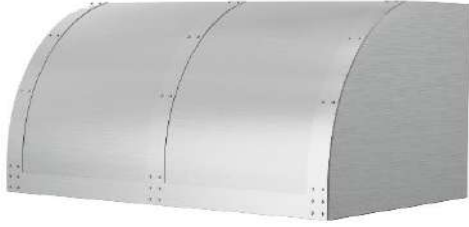

30" & 36" Bonanza Wall Hood

Standard Height: 18" | Bottom Depth: 24 1/4" | Top Depth: 12"

### FEATURES:

- Professional-grade performance with three exhaust settings and new Boost feature
- Whisper quiet operation
- Heavy duty, commercial grade materials
- Dimmable LED lighting
- Easy-to-use push-button controls
- Innovative, multi-stage grease capture system
- Stainless baffle filters seamlessly remove for easy dishwasher cleaning
- Choose from stainless steel or 1,000+ colors and finishes
- Simple installation
- 30" & 36" models: 600 CFM internal fan included **(Must be included on order)**
- Available with top or rear discharge - Discharge is field reversible.
- Install with or without optional duct cover
- In-line, in-hood and remote blower compatible

### CUSTOMIZATION OPTIONS:

- 1,000+ Colors & Finishes
- Designer Metals like brass & copper
- Custom strapping & rivets
- Full custom options

(\* ) Trim finishes on Cooking & Refrigeration products are different substrates than the trim finishes on Ventilation hoods. Due to these differing processes and substrates the finishes will coordinate but may not match exactly.

Model	Description (* ) Denotes item that must be specified	UMRP	MSRP	
<b>30" BONANZA HOODS: (3 Vertical Straps   1 Horizontal)</b>				
BZ030MLPLT	Body: Stainless Steel   Strap/Rivets: Stainless Steel   600 CFM	\$ 4,495	\$ 5,170	
BZ030MLPLTD	Body: Stainless Steel   Strap/Rivets: Des. Metal*   600 CFM	\$ 4,790	\$ 5,510	
BZ030MLPLTC	Body: Std RAL Color*   Strap/Rivets: Stainless Steel   600 CFM	\$ 5,690	\$ 6,545	
BZ030MLPLTDC	Body: Std RAL Color*   Strap/Rivets: Des Metal*   600 CFM	\$ 5,985	\$ 6,885	
BZ030MLPLTCF	Body: Spec. Finish*   Strap/Rivets: Stainless Steel   600 CFM	\$ 6,690	\$ 7,695	
BZ030MLPLTDCF	Body: Spec. Finish*   Strap/Rivets: Des. Metal*   600 CFM	\$ 6,985	\$ 8,035	
BZ030MLPLTCC	Body: Custom Color*   Strap/Rivets: Stainless Steel   600 CFM	\$ 8,190	\$ 9,420	
BZ030MLPLTDCC	Body: Custom Color*   Strap/Rivets: Des. Metal*   600 CFM	\$ 8,485	\$ 9,760	
<b>36" BONANZA HOODS: (3 Vertical Straps   1 Horizontal)</b>				
BZ036MLPLT	Body: Stainless Steel   Strap/Rivets: Stainless Steel   600 CFM	\$ 4,825	\$ 5,550	
BZ036MLPLTD	Body: Stainless Steel   Strap/Rivets: Des. Metal*   600 CFM	\$ 5,220	\$ 6,005	
BZ036MLPLTC	Body: Std RAL Color*   Strap/Rivets: Stainless Steel   600 CFM	\$ 6,020	\$ 6,925	
BZ036MLPLTDC	Body: Std RAL Color*   Strap/Rivets: Des Metal*   600 CFM	\$ 6,415	\$ 7,375	
BZ036MLPLTCF	Body: Spec. Finish*   Strap/Rivets: Stainless Steel   600 CFM	\$ 7,020	\$ 8,075	
BZ036MLPLTDCF	Body: Spec. Finish*   Strap/Rivets: Des. Metal*   600 CFM	\$ 7,415	\$ 8,525	
BZ036MLPLTCC	Body: Custom Color*   Strap/Rivets: Stainless Steel   600 CFM	\$ 8,520	\$ 9,800	
BZ036MLPLTDCC	Body: Custom Color*   Strap/Rivets: Des. Metal*   600 CFM	\$ 8,915	\$ 10,250	
<b>DESIGNER METAL OPTIONS FOR STRAPPING &amp; RIVETS:</b>				
Brushed Stainless	Polished Stainless	Antique Brass	Brushed Brass	Polished Brass
Antique Copper	Brushed Copper	Polished Copper	Oil Rubbed Bronze	Pewter
<b>DUCT COVERS FOR BONANZA HOODS:</b>				
Refer to page 87 for all Bonanza hood duct cover options				
• Available duct cover heights: 2", 6", 12", 18", 24", 30", 36", 42" & 48"				
Refer to page 103 for Ventilation Hood Accessories				

BLOWER OPTIONS	IN-HOOD		IN-LINE		REMOTE		DISCHARGE	
CFM POWER	600	1200	800	1200	1000	1400	TOP	REAR
MODEL #	BS-CFM-600-IN06	BS-CFM-1200-IN12	ATEX-0.8	ATEX-1.2	HYEX-1.0-GA	HYEX-1.4-GA		
UMRP	\$ 965	\$ 995	\$ 1,260	\$ 1,510	\$ 1,385	\$ 1,640		
BZ030MLPLT	•		•	•	•	•	•	Available at time of order
BZ036MLPLT	•	•	•	•	•	•	•	
BZ042MLPLT	•	•	•	•	•	•	•	
BZ048MLPLT	•	•	•	•	•	•	•	
BZ054MLPLT	•	•	•	•	•	•	•	
BZ060MLPLT	•	•	•	•	•	•	•	
BZ066MLPLT	•	•	•	•	•	•	•	

## DESIGNER SERIES: 42", 48", 54", 60" & 66" BONANZA WALL HOODS



42", 48", 54" & 60" Bonanza Wall Hood

Standard Height: 18" | Bottom Depth: 24 1/4" | Top Depth: 12"



66" Bonanza Wall Hood

Standard Height: 18" | Bottom Depth: 24 1/4" | Top Depth: 12"

42" BONANZA HOODS: (4 Vertical Straps   1 Horizontal)		UMRP	MSRP
BZ042MLPLT	Body: Stainless Steel   Strap/Rivets: Stainless Steel	\$ 5,595	\$ 6,435
BZ042MLPLTD	Body: Stainless Steel   Strap/Rivets: Des. Metal*	\$ 5,990	\$ 6,890
BZ042MLPLTC	Body: Std RAL Color*   Strap/Rivets: Stainless Steel	\$ 7,090	\$ 8,155
BZ042MLPLTDC	Body: Std RAL Color*   Strap/Rivets: Des Metal*	\$ 7,485	\$ 8,610
BZ042MLPLTCF	Body: Spec. Finish*   Strap/Rivets: Stainless Steel	\$ 8,190	\$ 9,420
BZ042MLPLTDCF	Body: Spec. Finish*   Strap/Rivets: Des. Metal*	\$ 8,585	\$ 9,875
BZ042MLPLTCC	Body: Custom Color*   Strap/Rivets: Stainless Steel	\$ 9,590	\$ 11,030
BZ042MLPLTDCC	Body: Custom Color*   Strap/Rivets: Des. Metal*	\$ 9,985	\$ 11,485
48" BONANZA HOODS: (4 Vertical Straps   1 Horizontal)		UMRP	MSRP
BZ048MLPLT	Body: Stainless Steel   Strap/Rivets: Stainless Steel	\$ 6,095	\$ 7,010
BZ048MLPLTD	Body: Stainless Steel   Strap/Rivets: Des. Metal*	\$ 6,490	\$ 7,465
BZ048MLPLTC	Body: Std RAL Color*   Strap/Rivets: Stainless Steel	\$ 7,590	\$ 8,730
BZ048MLPLTDC	Body: Std RAL Color*   Strap/Rivets: Des Metal*	\$ 7,985	\$ 9,185
BZ048MLPLTCF	Body: Spec. Finish*   Strap/Rivets: Stainless Steel	\$ 8,690	\$ 9,995
BZ048MLPLTDCF	Body: Spec. Finish*   Strap/Rivets: Des. Metal*	\$ 9,085	\$ 10,450
BZ048MLPLTCC	Body: Custom Color*   Strap/Rivets: Stainless Steel	\$ 10,090	\$ 11,605
BZ048MLPLTDCC	Body: Custom Color*   Strap/Rivets: Des. Metal*	\$ 10,485	\$ 12,060
54" BONANZA HOODS: (4 Vertical Straps   1 Horizontal)		UMRP	MSRP
BZ054MLPLT	Body: Stainless Steel   Strap/Rivets: Stainless Steel	\$ 6,195	\$ 7,125
BZ054MLPLTD	Body: Stainless Steel   Strap/Rivets: Des. Metal*	\$ 6,590	\$ 7,580
BZ054MLPLTC	Body: Std RAL Color*   Strap/Rivets: Stainless Steel	\$ 7,690	\$ 8,845
BZ054MLPLTDC	Body: Std RAL Color*   Strap/Rivets: Des Metal*	\$ 8,085	\$ 9,300
BZ054MLPLTCF	Body: Spec. Finish*   Strap/Rivets: Stainless Steel	\$ 8,790	\$ 10,110
BZ054MLPLTDCF	Body: Spec. Finish*   Strap/Rivets: Des. Metal*	\$ 9,185	\$ 10,565
BZ054MLPLTCC	Body: Custom Color*   Strap/Rivets: Stainless Steel	\$ 10,190	\$ 11,720
BZ054MLPLTDCC	Body: Custom Color*   Strap/Rivets: Des. Metal*	\$ 10,585	\$ 12,175
60" BONANZA HOODS: (4 Vertical Straps   1 Horizontal)		UMRP	MSRP
BZ060MLPLT	Body: Stainless Steel   Strap/Rivets: Stainless Steel	\$ 6,695	\$ 7,700
BZ060MLPLTD	Body: Stainless Steel   Strap/Rivets: Des. Metal*	\$ 7,090	\$ 8,155
BZ060MLPLTC	Body: Std RAL Color*   Strap/Rivets: Stainless Steel	\$ 8,190	\$ 9,420
BZ060MLPLTDC	Body: Std RAL Color*   Strap/Rivets: Des Metal*	\$ 8,585	\$ 9,875
BZ060MLPLTCF	Body: Spec. Finish*   Strap/Rivets: Stainless Steel	\$ 9,290	\$ 10,685
BZ060MLPLTDCF	Body: Spec. Finish*   Strap/Rivets: Des. Metal*	\$ 9,685	\$ 11,140
BZ060MLPLTCC	Body: Custom Color*   Strap/Rivets: Stainless Steel	\$ 10,690	\$ 12,295
BZ060MLPLTDCC	Body: Custom Color*   Strap/Rivets: Des. Metal*	\$ 11,085	\$ 12,750
66" BONANZA HOODS: (5 Vertical Straps   1 Horizontal)		UMRP	MSRP
BZ066MLPLT	Body: Stainless Steel   Strap/Rivets: Stainless Steel	\$ 6,795	\$ 7,815
BZ066MLPLTD	Body: Stainless Steel   Strap/Rivets: Des. Metal*	\$ 7,190	\$ 8,270
BZ066MLPLTC	Body: Std RAL Color*   Strap/Rivets: Stainless Steel	\$ 8,290	\$ 9,535
BZ066MLPLTDC	Body: Std RAL Color*   Strap/Rivets: Des Metal*	\$ 8,685	\$ 9,990
BZ066MLPLTCF	Body: Spec. Finish*   Strap/Rivets: Stainless Steel	\$ 9,390	\$ 10,800
BZ066MLPLTDCF	Body: Spec. Finish*   Strap/Rivets: Des. Metal*	\$ 9,785	\$ 11,255
BZ066MLPLTCC	Body: Custom Color*   Strap/Rivets: Stainless Steel	\$ 10,790	\$ 12,410
BZ066MLPLTDCC	Body: Custom Color*   Strap/Rivets: Des. Metal*	\$ 11,185	\$ 12,865

## DUCT COVERS: BONANZA WALL HOODS

**NOTE: DUCT COVER MUST BE ORDERED WITH HOOD FOR QUALITY ASSURANCE.**

**NOTE: STRAPPING AND RIVETS ON DUCT COVER MUST MATCH HOOD. MUST BE SPECIFIED ON ORDER.**

SIZE	MODEL	HEIGHT	UMRP	MSRP
Available Duct Covers for 30" Models	DCBZ03002H	2"	\$ 625	\$ 720
	DCBZ03002	2"	No charge when ordered with Bonanza style hood.  Must be ordered with hood for quality assurance.	
	DCBZ03006	6"		
	DCBZ03012	12"		
	DCBZ03018	18"		
	DCBZ03024	24"		
	DCBZ03030	30"		
	DCBZ03036	36"		
	DCBZ03042	42"		
DCBZ03048	48"			
Available Duct Covers for 36" Models	DCBZ03602H	2"	\$ 625	\$ 720
	DCBZ03602	2"	No charge when ordered with Bonanza style hood.  Must be ordered with hood for quality assurance.	
	DCBZ03606	6"		
	DCBZ03612	12"		
	DCBZ03618	18"		
	DCBZ03624	24"		
	DCBZ03630	30"		
	DCBZ03636	36"		
	DCBZ03642	42"		
DCBZ03648	48"			
Available Duct Covers for 42" Models	DCBZ04202H	2"	\$ 625	\$ 720
	DCBZ04202	2"	No charge when ordered with Bonanza style hood.  Must be ordered with hood for quality assurance.	
	DCBZ04206	6"		
	DCBZ04212	12"		
	DCBZ042018	18"		
	DCBZ04224	24"		
	DCBZ04230	30"		
	DCBZ04236	36"		
	DCBZ04242	42"		
DCBZ04248	48"			
Available Duct Covers for 48" Models	DCBZ04802H	2"	\$ 625	\$ 720
	DCBZ04802	2"	No charge when ordered with Bonanza style hood.  Must be ordered with hood for quality assurance.	
	DCBZ04806	6"		
	DCBZ04812	12"		
	DCBZ04818	18"		
	DCBZ04824	24"		
	DCBZ04830	30"		
	DCBZ04836	36"		
	DCBZ04842	42"		
DCBZ04848	48"			

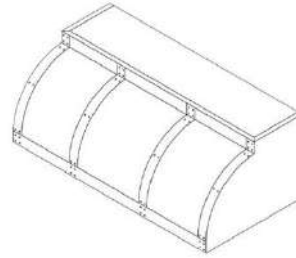

**Version: DCBZ0xx2H**  
Two horizontal straps

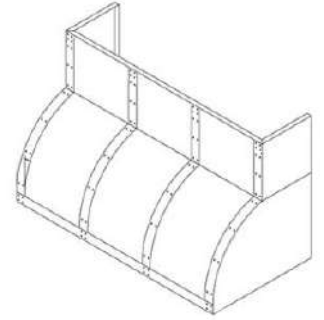

**Version: DCBZ0xxxx**  
One horizontal – All others vertical

SIZE	MODEL	HEIGHT	UMRP	MSRP
Available Duct Covers for 54" Models	DCBZ05402H	2"	\$ 625	\$ 720
	DCBZ05402	2"	No charge when ordered with Bonanza style hood.  Must be ordered with hood for quality assurance.	
	DCBZ05406	6"		
	DCBZ05412	12"		
	DCBZ05418	18"		
	DCBZ05424	24"		
	DCBZ05430	30"		
	DCBZ05436	36"		
	DCBZ05442	42"		
DCBZ05448	48"			
Available Duct Covers for 60" Models	DCBZ06002H	2"	\$ 625	\$ 720
	DCBZ06002	2"	No charge when ordered with Bonanza style hood.  Must be ordered with hood for quality assurance.	
	DCBZ06006	6"		
	DCBZ06012	12"		
	DCBZ06018	18"		
	DCBZ06024	24"		
	DCBZ06030	30"		
	DCBZ06036	36"		
	DCBZ06042	42"		
DCBZ06048	48"			
Available Duct Covers for 66" Models	DCBZ06602H	2"	\$ 625	\$ 720
	DCBZ06602	2"	No charge when ordered with Bonanza style hood.  Must be ordered with hood for quality assurance.	
	DCBZ06606	6"		
	DCBZ06612	12"		
	DCBZ06618	18"		
	DCBZ06624	24"		
	DCBZ06630	30"		
	DCBZ06636	36"		
	DCBZ06642	42"		
DCBZ06648	48"			

# DESIGNER SERIES: 30" & 36" SAHARA CURVED SIDES WALL HOODS

REQUEST A QUOTE  
QUOTE@BLUESTARCOOKING.COM

Model Number Color & Customization Guide:				
(C) 190 Standard RAL (Semi-Gloss) Colors	(CF) Specialty Finish (190 Matte RAL, Precious Metals & Textures)	(CC) Custom Color Match	(PLT) Stainless Steel Straps & Rivets	(D) Designer Metal Straps & Rivets



30" & 36" Sahara Curved Sides Wall Hood

Standard Height: 18" | Bottom Depth: 24 1/4" | Top Depth: 12"

### FEATURES:

- Professional-grade performance with three exhaust settings and new Boost feature
- Whisper quiet operation
- Heavy duty, commercial grade materials
- Dimmable LED lighting
- Easy-to-use push-button controls
- Innovative, multi-stage grease capture system
- Stainless baffle filters seamlessly remove for easy dishwasher cleaning
- Choose from stainless steel or 1,000+ colors and finishes
- Simple installation
- 30" & 36" models: 600 CFM internal fan included **(Must be included on order)**
- Available with top or rear discharge - Discharge is field reversible.
- In-line, in-hood and remote blower compatible

### CUSTOMIZATION OPTIONS:

- 1,000+ Colors & Finishes
- Designer Metals like brass & copper
- Custom strapping & rivets
- Full custom options

Model	Description (* Denotes item that must be specified)	UMRP	MSRP	
<b>30" SAHARA CURVED SIDES HOODS:</b>				
SC030MLPLT	Body: Stainless Steel   Strap/Rivets: Stainless Steel   600 CFM	\$ 6,495	\$ 7,470	
SC030MLPLTD	Body: Stainless Steel   Strap/Rivets: Des. Metal*   600 CFM	\$ 6,790	\$ 7,810	
SC030MLPLTC	Body: Std RAL Color*   Strap/Rivets: Stainless Steel   600 CFM	\$ 7,690	\$ 8,845	
SC030MLPLTDC	Body: Std RAL Color*   Strap/Rivets: Des Metal*   600 CFM	\$ 7,985	\$ 9,185	
SC030MLPLTCF	Body: Spec. Finish*   Strap/Rivets: Stainless Steel   600 CFM	\$ 8,690	\$ 9,995	
SC030MLPLTDCF	Body: Spec. Finish*   Strap/Rivets: Des. Metal*   600 CFM	\$ 8,985	\$ 10,335	
SC030MLPLTCC	Body: Custom Color*   Strap/Rivets: Stainless Steel   600 CFM	\$ 10,190	\$ 11,720	
SC030MLPLTDCC	Body: Custom Color*   Strap/Rivets: Des. Metal*   600 CFM	\$ 10,485	\$ 12,060	
<b>36" SAHARA CURVED SIDES HOODS:</b>				
SC036MLPLT	Body: Stainless Steel   Strap/Rivets: Stainless Steel   600 CFM	\$ 6,795	\$ 7,815	
SC036MLPLTD	Body: Stainless Steel   Strap/Rivets: Des. Metal*   600 CFM	\$ 7,190	\$ 8,270	
SC036MLPLTC	Body: Std RAL Color*   Strap/Rivets: Stainless Steel   600 CFM	\$ 7,990	\$ 9,190	
SC036MLPLTDC	Body: Std RAL Color*   Strap/Rivets: Des Metal*   600 CFM	\$ 8,385	\$ 9,645	
SC036MLPLTCF	Body: Spec. Finish*   Strap/Rivets: Stainless Steel   600 CFM	\$ 8,990	\$ 10,340	
SC036MLPLTDCF	Body: Spec. Finish*   Strap/Rivets: Des. Metal*   600 CFM	\$ 9,385	\$ 10,795	
SC036MLPLTCC	Body: Custom Color*   Strap/Rivets: Stainless Steel   600 CFM	\$ 10,490	\$ 12,065	
SC036MLPLTDCC	Body: Custom Color*   Strap/Rivets: Des. Metal*   600 CFM	\$ 10,885	\$ 12,520	
<b>DESIGNER METAL OPTIONS FOR STRAPPING &amp; RIVETS:</b>				
Brushed Stainless	Polished Stainless	Antique Brass	Brushed Brass	Polished Brass
Antique Copper	Brushed Copper	Polished Copper	Oil Rubbed Bronze	Pewter
<b>VENTILATION HOOD ACCESSORIES:</b>				
Refer to page 90 for all Sahara Curved Sides duct cover options				
Refer to page 103 for Ventilation Hood Accessories				

(\* Trim finishes on Cooking & Refrigeration products are different substrates than the trim finishes on Ventilation hoods. Due to these differing processes and substrates the finishes will coordinate but may not match exactly.

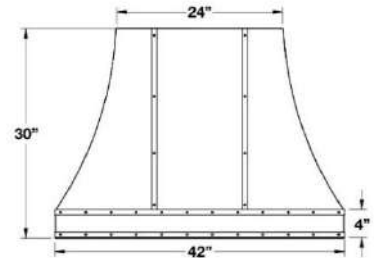
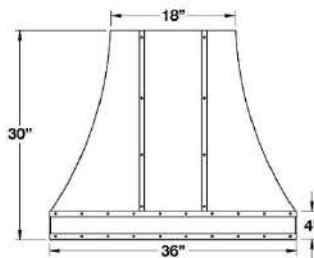
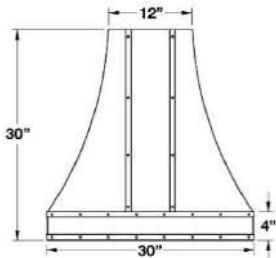

BLOWER OPTIONS	IN-HOOD		IN-LINE		REMOTE		DISCHARGE	
CFM POWER	600	1200	800	1200	1000	1400	TOP	REAR
MODEL #	BS-CFM-600-IN06	BS-CFM-1200-IN12	ATEX-0.8	ATEX-1.2	HYEX-1.0-GA	HYEX-1.4-GA		
UMRP	\$ 965	\$ 995	\$ 1,260	\$ 1,510	\$ 1,385	\$ 1,640	Available at time of order	
SC030MLPLT	•	•	•	•	•	•		
SC036MLPLT	•	•	•	•	•	•		
SC042MLPLT	•	•	•	•	•	•		
SC048MLPLT	•	•	•	•	•	•		
SC054MLPLT	•	•	•	•	•	•		
SC060MLPLT	•	•	•	•	•	•		

## DESIGNER SERIES: 42", 48", 54" & 60" SAHARA CURVED SIDES WALL HOODS



42" SAHARA CURVED SIDES HOODS:		UMRP	MSRP
SC042MLPLT	<b>Body:</b> Stainless Steel   <b>Strap/Rivets:</b> Stainless Steel	\$ 7,295	\$ 8,390
SC042MLPLTD	<b>Body:</b> Stainless Steel   <b>Strap/Rivets:</b> Des. Metal*	\$ 7,690	\$ 8,845
SC042MLPLTC	<b>Body:</b> Std RAL Color*   <b>Strap/Rivets:</b> Stainless Steel	\$ 8,790	\$ 10,110
SC042MLPLTDC	<b>Body:</b> Std RAL Color*   <b>Strap/Rivets:</b> Des Metal*	\$ 9,185	\$ 10,565
SC042MLPLTCF	<b>Body:</b> Spec. Finish*   <b>Strap/Rivets:</b> Stainless Steel	\$ 9,890	\$ 11,375
SC042MLPLTDCF	<b>Body:</b> Spec. Finish*   <b>Strap/Rivets:</b> Des. Metal*	\$ 10,285	\$ 11,830
SC042MLPLTCC	<b>Body:</b> Custom Color*   <b>Strap/Rivets:</b> Stainless Steel	\$ 11,290	\$ 12,985
SC042MLPLTDCC	<b>Body:</b> Custom Color*   <b>Strap/Rivets:</b> Des. Metal*	\$ 11,685	\$ 13,440

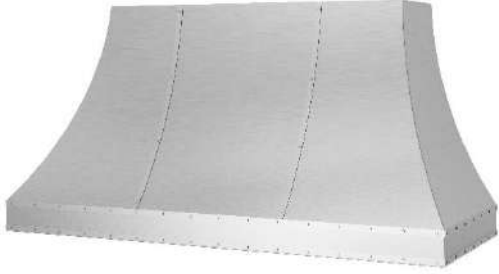

48" SAHARA CURVED SIDES HOODS:		UMRP	MSRP
SC048MLPLT	<b>Body:</b> Stainless Steel   <b>Strap/Rivets:</b> Stainless Steel	\$ 7,695	\$ 8,850
SC048MLPLTD	<b>Body:</b> Stainless Steel   <b>Strap/Rivets:</b> Des. Metal*	\$ 8,090	\$ 9,305
SC048MLPLTC	<b>Body:</b> Std RAL Color*   <b>Strap/Rivets:</b> Stainless Steel	\$ 9,190	\$ 10,570
SC048MLPLTDC	<b>Body:</b> Std RAL Color*   <b>Strap/Rivets:</b> Des Metal*	\$ 9,585	\$ 11,025
SC048MLPLTCF	<b>Body:</b> Spec. Finish*   <b>Strap/Rivets:</b> Stainless Steel	\$ 10,290	\$ 11,835
SC048MLPLTDCF	<b>Body:</b> Spec. Finish*   <b>Strap/Rivets:</b> Des. Metal*	\$ 10,685	\$ 12,290
SC048MLPLTCC	<b>Body:</b> Custom Color*   <b>Strap/Rivets:</b> Stainless Steel	\$ 11,690	\$ 13,445
SC048MLPLTDCC	<b>Body:</b> Custom Color*   <b>Strap/Rivets:</b> Des. Metal*	\$ 12,085	\$ 13,900

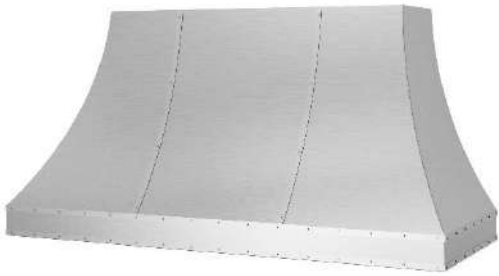

54" SAHARA CURVED SIDES HOODS:		UMRP	MSRP
SC054MLPLT	<b>Body:</b> Stainless Steel   <b>Strap/Rivets:</b> Stainless Steel	\$ 8,995	\$ 10,345
SC054MLPLTD	<b>Body:</b> Stainless Steel   <b>Strap/Rivets:</b> Des. Metal*	\$ 9,390	\$ 10,800
SC054MLPLTC	<b>Body:</b> Std RAL Color*   <b>Strap/Rivets:</b> Stainless Steel	\$ 10,490	\$ 12,065
SC054MLPLTDC	<b>Body:</b> Std RAL Color*   <b>Strap/Rivets:</b> Des Metal*	\$ 10,885	\$ 12,520
SC054MLPLTCF	<b>Body:</b> Spec. Finish*   <b>Strap/Rivets:</b> Stainless Steel	\$ 11,590	\$ 13,330
SC054MLPLTDCF	<b>Body:</b> Spec. Finish*   <b>Strap/Rivets:</b> Des. Metal*	\$ 11,985	\$ 13,785
SC054MLPLTCC	<b>Body:</b> Custom Color*   <b>Strap/Rivets:</b> Stainless Steel	\$ 12,990	\$ 14,940
SC054MLPLTDCC	<b>Body:</b> Custom Color*   <b>Strap/Rivets:</b> Des. Metal*	\$ 13,385	\$ 15,395

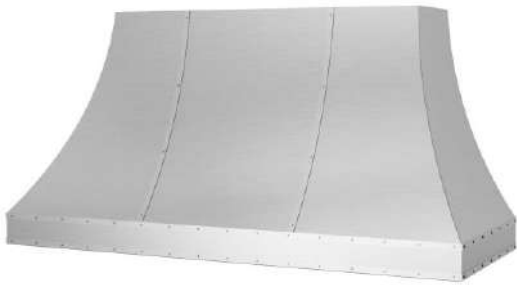

60" SAHARA CURVED SIDES HOODS:		UMRP	MSRP
SC060MLPLT	<b>Body:</b> Stainless Steel   <b>Strap/Rivets:</b> Stainless Steel	\$ 10,620	\$ 12,215
SC060MLPLTD	<b>Body:</b> Stainless Steel   <b>Strap/Rivets:</b> Des. Metal*	\$ 10,990	\$ 12,640
SC060MLPLTC	<b>Body:</b> Std RAL Color*   <b>Strap/Rivets:</b> Stainless Steel	\$ 12,090	\$ 13,905
SC060MLPLTDC	<b>Body:</b> Std RAL Color*   <b>Strap/Rivets:</b> Des Metal*	\$ 12,485	\$ 14,360
SC060MLPLTCF	<b>Body:</b> Spec. Finish*   <b>Strap/Rivets:</b> Stainless Steel	\$ 13,190	\$ 15,170
SC060MLPLTDCF	<b>Body:</b> Spec. Finish*   <b>Strap/Rivets:</b> Des. Metal*	\$ 13,585	\$ 15,625
SC060MLPLTCC	<b>Body:</b> Custom Color*   <b>Strap/Rivets:</b> Stainless Steel	\$ 14,590	\$ 16,780
SC060MLPLTDCC	<b>Body:</b> Custom Color*   <b>Strap/Rivets:</b> Des. Metal*	\$ 14,985	\$ 17,235

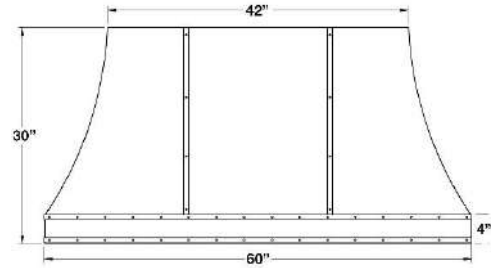
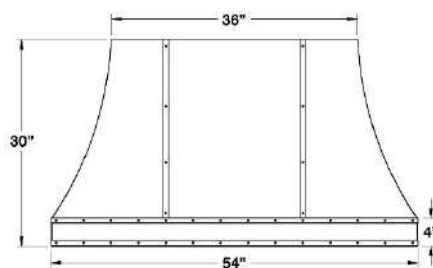
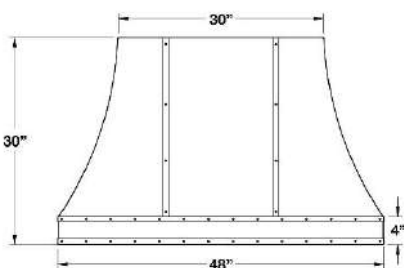

## DUCT COVERS: HAMPTON, SAHARA CURVED SIDES & RIDGELINE WALL HOODS

**NOTE: STRAPPING AND RIVETS ON DUCT COVER MUST MATCH HOOD. MUST BE SPECIFIED ON ORDER.**

**NOTE: DUCT COVER MUST BE ORDERED WITH HOOD FOR QUALITY ASSURANCE.**

### HAMPTON WALL HOODS

SIZE	MODEL	HEIGHT
Available Duct Covers for 30" Models	DCHW1206	6"
	DCHW1212	12"
	DCHW1218	18"
Duct Width: 12"	DCHW1224	24"
	DCHW1230	30"
No charge when ordered with Hampton style hood.	DCHW1236	36"
	DCHW1242	42"
	DCHW1248	48"

### SAHARA CURVED & RIDGELINE WALL HOODS

SIZE	MODEL	HEIGHT	SIZE	MODEL	HEIGHT
Available Duct Covers for 30" Models	DCHW1206	6"	Available Duct Covers for 48" Models	DCHW3006	6"
	DCHW1212	12"		DCHW3012	12"
	DCHW1218	18"		DCHW3018	18"
Duct Width: 12"	DCHW1224	24"	Duct Width: 30"	DCHW3024	24"
	DCHW1230	30"		DCHW3030	30"
No Charge when ordered with Sahara Curved or Ridgeline style hood	DCHW1236	36"	No Charge when ordered with Sahara Curved or Ridgeline style hood	DCHW3036	36"
	DCHW1242	42"		DCHW3042	42"
	DCHW1248	48"		DCHW3048	48"

SIZE	MODEL	HEIGHT
Available Duct Covers for 36", 42", 48" & 54" Models	DCHW1806	6"
	DCHW1812	12"
	DCHW1818	18"
Duct Width: 18"	DCHW1824	24"
	DCHW1830	30"
No charge when ordered with Hampton style hood.	DCHW1836	36"
	DCHW1842	42"
	DCHW1848	48"

SIZE	MODEL	HEIGHT
Available Duct Covers for 36" Models	DCHW1806	6"
	DCHW1812	12"
	DCHW1818	18"
Duct Width: 18"	DCHW1824	24"
	DCHW1830	30"
No Charge when ordered with Sahara Curved or Ridgeline style hood	DCHW1836	36"
	DCHW1842	42"
	DCHW1848	48"

SIZE	MODEL	HEIGHT
Available Duct Covers for 54" Models	DCHW3606	6"
	DCHW3612	12"
	DCHW3618	18"
Duct Width: 36"	DCHW3624	24"
	DCHW3630	30"
No Charge when ordered with Sahara Curved or Ridgeline style hood	DCHW3636	36"
	DCHW3642	42"
	DCHW3648	48"

SIZE	MODEL	HEIGHT
Available Duct Covers for 60" & 66" Models	DCHW2406	6"
	DCHW2412	12"
	DCHW2418	18"
Duct Width: 24"	DCHW2424	24"
	DCHW2430	30"
No charge when ordered with Hampton style hood.	DCHW2436	36"
	DCHW2442	42"
	DCHW2448	48"

SIZE	MODEL	HEIGHT
Available Duct Covers for 42" Models	DCHW2406	6"
	DCHW2412	12"
	DCHW2418	18"
Duct Width: 24"	DCHW2424	24"
	DCHW2430	30"
No Charge when ordered with Sahara Curved or Ridgeline style hood	DCHW2436	36"
	DCHW2442	42"
	DCHW2448	48"

SIZE	MODEL	HEIGHT
Available Duct Covers for 60" Models	DCHW4206	6"
	DCHW4212	12"
	DCHW4218	18"
Duct Width: 42"	DCHW4224	24"
	DCHW4230	30"
No Charge when ordered with Sahara Curved or Ridgeline style hood	DCHW4236	36"
	DCHW4242	42"
	DCHW4248	48"

# DESIGNER SERIES: 30" & 36" WRANGLER WALL HOODS

Model Number Color & Customization Guide:				
(C) 190 Standard RAL (Semi-Gloss) Colors	(CF) Specialty Finish (190 Matte RAL, Precious Metals & Textures)	(CC) Custom Color Match	(PLT) Stainless Steel Straps & Rivets	(D) Designer Metal Straps & Rivets

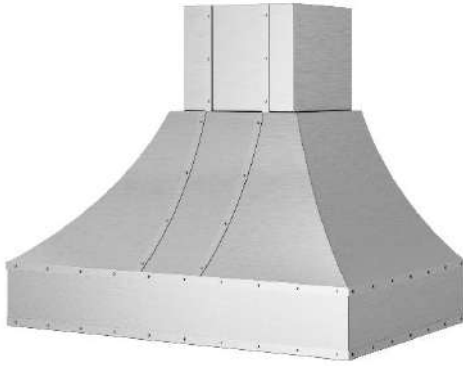

30" & 36" Wrangler Wall Hood

Standard Height: 20" | Bottom Depth: 24 1/4" | Top Depth: 13"

**FEATURES:**

- Professional-grade performance with three exhaust settings and new Boost feature
- Whisper quiet operation
- Heavy duty, commercial grade materials
- Dimmable LED lighting
- Easy-to-use push-button controls
- Innovative, multi-stage grease capture system
- Stainless baffle filters seamlessly remove for easy dishwasher cleaning
- Choose from stainless steel or 1,000+ colors and finishes
- Simple installation
- 30" & 36" models: 600 CFM internal fan included **(Must be included on order)**
- Included duct cover heights: 10", 16", 22", 28", 34", 40", 46". Must be specified on order.
- Available with top or rear discharge - Discharge is field reversible.
- In-line, in-hood and remote blower compatible

**CUSTOMIZATION OPTIONS:**

- 1,000+ Colors & Finishes
- Designer Metals like brass & copper
- Custom strapping & rivets
- Full custom options

(\* Trim finishes on Cooking & Refrigeration products are different substrates than the trim finishes on Ventilation hoods. Due to these differing processes and substrates the finishes will coordinate but may not match exactly.

Model	Description (* Denotes item that must be specified)	UMRP	MSRP	
<b>30" WRANGLER HOODS:</b>				
WR030MLPLT	Body: Stainless Steel   Strap/Rivets: Stainless Steel   600 CFM	\$ 7,695	\$ 8,850	
WR030MLPLTD	Body: Stainless Steel   Strap/Rivets: Des. Metal*   600 CFM	\$ 7,990	\$ 9,190	
WR030MLPLTC	Body: Std RAL Color*   Strap/Rivets: Stainless Steel   600 CFM	\$ 8,890	\$ 10,225	
WR030MLPLTDC	Body: Std RAL Color*   Strap/Rivets: Des Metal*   600 CFM	\$ 9,185	\$ 10,565	
WR030MLPLTCF	Body: Spec. Finish*   Strap/Rivets: Stainless Steel   600 CFM	\$ 9,890	\$ 11,375	
WR030MLPLTDCF	Body: Spec. Finish*   Strap/Rivets: Des. Metal*   600 CFM	\$ 10,185	\$ 11,715	
WR030MLPLTCC	Body: Custom Color*   Strap/Rivets: Stainless Steel   600 CFM	\$ 11,390	\$ 13,100	
WR030MLPLTDCC	Body: Custom Color*   Strap/Rivets: Des. Metal*   600 CFM	\$ 11,685	\$ 13,440	
<b>36" WRANGLER HOODS:</b>				
WR036MLPLT	Body: Stainless Steel   Strap/Rivets: Stainless Steel   600 CFM	\$ 7,895	\$ 9,080	
WR036MLPLTD	Body: Stainless Steel   Strap/Rivets: Des. Metal*   600 CFM	\$ 8,290	\$ 9,535	
WR036MLPLTC	Body: Std RAL Color*   Strap/Rivets: Stainless Steel   600 CFM	\$ 9,090	\$ 10,455	
WR036MLPLTDC	Body: Std RAL Color*   Strap/Rivets: Des Metal*   600 CFM	\$ 9,485	\$ 10,910	
WR036MLPLTCF	Body: Spec. Finish*   Strap/Rivets: Stainless Steel   600 CFM	\$ 10,090	\$ 11,605	
WR036MLPLTDCF	Body: Spec. Finish*   Strap/Rivets: Des. Metal*   600 CFM	\$ 10,485	\$ 12,060	
WR036MLPLTCC	Body: Custom Color*   Strap/Rivets: Stainless Steel   600 CFM	\$ 11,590	\$ 13,330	
WR036MLPLTDCC	Body: Custom Color*   Strap/Rivets: Des. Metal*   600 CFM	\$ 11,985	\$ 13,785	
<b>DESIGNER METAL OPTIONS FOR STRAPPING &amp; RIVETS:</b>				
Brushed Stainless	Polished Stainless	Antique Brass	Brushed Brass	Polished Brass
Antique Copper	Brushed Copper	Polished Copper	Oil Rubbed Bronze	Pewter
<b>DUCT COVERS FOR WRANGLER HOODS:</b>				
Refer to page 93 for all Wrangler hood duct cover options				
• Included duct cover heights: 10", 16", 22", 28", 34", 40", 46"				
Refer to page 103 for Ventilation Hood Accessories				

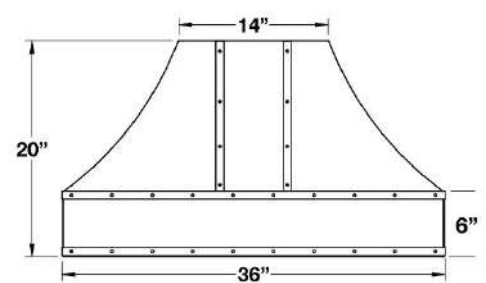
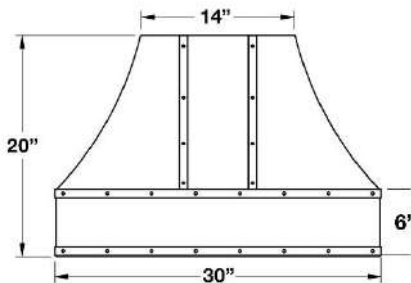

BLOWER OPTIONS	IN-HOOD		IN-LINE		REMOTE		DISCHARGE	
	600	1200	800	1200	1000	1400	TOP	REAR
CFM POWER	600	1200	800	1200	1000	1400		
MODEL #	BS-CFM-600-IN06	BS-CFM-1200-IN12	ATEX-0.8	ATEX-1.2	HYEX-1.0-GA	HYEX-1.4-GA		
UMRP	\$ 965	\$ 995	\$ 1,260	\$ 1,510	\$ 1,385	\$ 1,640		
WR030MLPLT	•		•	•	•	•	•	Available at time of order
WR036MLPLT	•	•	•	•	•	•	•	
WR042MLPLT	•	•	•	•	•	•	•	
WR048MLPLT	•	•	•	•	•	•	•	
WR054MLPLT	•	•	•	•	•	•	•	
WR060MLPLT	•	•	•	•	•	•	•	
WR066MLPLT	•	•	•	•	•	•	•	

## DESIGNER SERIES: 42", 48", 54", 60" & 66" WRANGLER WALL HOODS

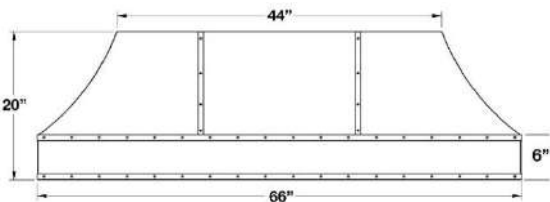
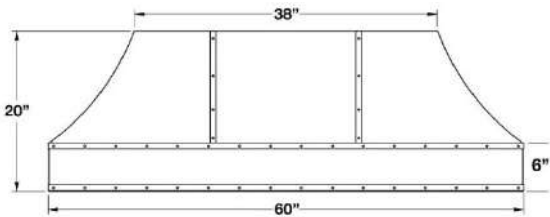
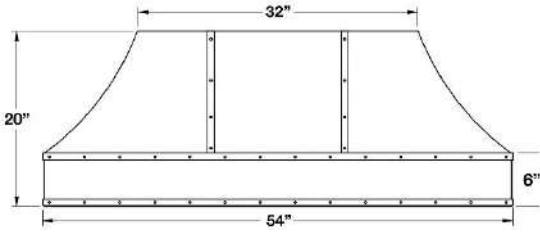
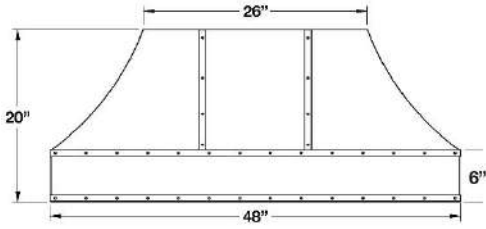
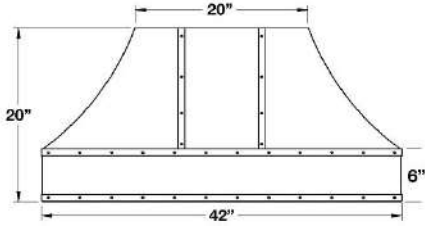

42" WRANGLER HOODS		UMRP	MSRP
WR042MLPLT	Body: Stainless Steel   Strap/Rivets: Stainless Steel	\$ 7,995	\$ 9,195
WR042MLPLTD	Body: Stainless Steel   Strap/Rivets: Des. Metal*	\$ 8,390	\$ 9,650
WR042MLPLTC	Body: Std RAL Color*   Strap/Rivets: Stainless Steel	\$ 9,490	\$ 10,915
WR042MLPLTDC	Body: Std RAL Color*   Strap/Rivets: Des Metal*	\$ 9,885	\$ 11,370
WR042MLPLTCF	Body: Spec. Finish*   Strap/Rivets: Stainless Steel	\$ 10,590	\$ 12,180
WR042MLPLTDCF	Body: Spec. Finish*   Strap/Rivets: Des. Metal*	\$ 10,985	\$ 12,635
WR042MLPLTCC	Body: Custom Color*   Strap/Rivets: Stainless Steel	\$ 11,990	\$ 13,790
WR042MLPLTDCC	Body: Custom Color*   Strap/Rivets: Des. Metal*	\$ 12,385	\$ 14,245
48" WRANGLER HOODS		UMRP	MSRP
WR048MLPLT	Body: Stainless Steel   Strap/Rivets: Stainless Steel	\$ 8,195	\$ 9,425
WR048MLPLTD	Body: Stainless Steel   Strap/Rivets: Des. Metal*	\$ 8,590	\$ 9,880
WR048MLPLTC	Body: Std RAL Color*   Strap/Rivets: Stainless Steel	\$ 9,690	\$ 11,145
WR048MLPLTDC	Body: Std RAL Color*   Strap/Rivets: Des Metal*	\$ 10,085	\$ 11,600
WR048MLPLTCF	Body: Spec. Finish*   Strap/Rivets: Stainless Steel	\$ 10,790	\$ 12,410
WR048MLPLTDCF	Body: Spec. Finish*   Strap/Rivets: Des. Metal*	\$ 11,185	\$ 12,865
WR048MLPLTCC	Body: Custom Color*   Strap/Rivets: Stainless Steel	\$ 12,190	\$ 14,020
WR048MLPLTDCC	Body: Custom Color*   Strap/Rivets: Des. Metal*	\$ 12,585	\$ 14,475
54" WRANGLER HOODS		UMRP	MSRP
WR054MLPLT	Body: Stainless Steel   Strap/Rivets: Stainless Steel	\$ 8,295	\$ 9,540
WR054MLPLTD	Body: Stainless Steel   Strap/Rivets: Des. Metal*	\$ 8,690	\$ 9,995
WR054MLPLTC	Body: Std RAL Color*   Strap/Rivets: Stainless Steel	\$ 9,790	\$ 11,260
WR054MLPLTDC	Body: Std RAL Color*   Strap/Rivets: Des Metal*	\$ 10,185	\$ 11,715
WR054MLPLTCF	Body: Spec. Finish*   Strap/Rivets: Stainless Steel	\$ 10,890	\$ 12,525
WR054MLPLTDCF	Body: Spec. Finish*   Strap/Rivets: Des. Metal*	\$ 11,285	\$ 12,980
WR054MLPLTCC	Body: Custom Color*   Strap/Rivets: Stainless Steel	\$ 12,290	\$ 14,135
WR054MLPLTDCC	Body: Custom Color*   Strap/Rivets: Des. Metal*	\$ 12,685	\$ 14,590
60" WRANGLER HOODS		UMRP	MSRP
WR060MLPLT	Body: Stainless Steel   Strap/Rivets: Stainless Steel	\$ 8,395	\$ 9,655
WR060MLPLTD	Body: Stainless Steel   Strap/Rivets: Des. Metal*	\$ 8,790	\$ 10,110
WR060MLPLTC	Body: Std RAL Color*   Strap/Rivets: Stainless Steel	\$ 9,890	\$ 11,375
WR060MLPLTDC	Body: Std RAL Color*   Strap/Rivets: Des Metal*	\$ 10,285	\$ 11,830
WR060MLPLTCF	Body: Spec. Finish*   Strap/Rivets: Stainless Steel	\$ 10,990	\$ 12,640
WR060MLPLTDCF	Body: Spec. Finish*   Strap/Rivets: Des. Metal*	\$ 11,385	\$ 13,095
WR060MLPLTCC	Body: Custom Color*   Strap/Rivets: Stainless Steel	\$ 12,390	\$ 14,250
WR060MLPLTDCC	Body: Custom Color*   Strap/Rivets: Des. Metal*	\$ 12,785	\$ 14,705
66" WRANGLER HOODS		UMRP	MSRP
WR066MLPLT	Body: Stainless Steel   Strap/Rivets: Stainless Steel	\$ 8,495	\$ 9,770
WR066MLPLTD	Body: Stainless Steel   Strap/Rivets: Des. Metal*	\$ 8,890	\$ 10,225
WR066MLPLTC	Body: Std RAL Color*   Strap/Rivets: Stainless Steel	\$ 9,990	\$ 11,490
WR066MLPLTDC	Body: Std RAL Color*   Strap/Rivets: Des Metal*	\$ 10,385	\$ 11,945
WR066MLPLTCF	Body: Spec. Finish*   Strap/Rivets: Stainless Steel	\$ 11,090	\$ 12,755
WR066MLPLTDCF	Body: Spec. Finish*   Strap/Rivets: Des. Metal*	\$ 11,485	\$ 13,210
WR066MLPLTCC	Body: Custom Color*   Strap/Rivets: Stainless Steel	\$ 12,490	\$ 14,365
WR066MLPLTDCC	Body: Custom Color*   Strap/Rivets: Des. Metal*	\$ 12,885	\$ 14,820

## DUCT COVERS: WRANGLER WALL HOODS

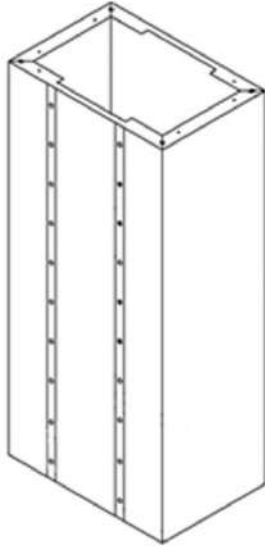

**NOTE: STRAPPING AND RIVETS ON DUCT COVER MUST MATCH HOOD. MUST BE SPECIFIED ON ORDER.**

**NOTE: DUCT COVER MUST BE ORDERED WITH HOOD FOR QUALITY ASSURANCE.**

SIZE	MODEL	HEIGHT	UMRP	MSRP
<b>Available Duct Covers for 30" Models</b>  <b>Duct Width: 12"</b>	DCWW03010	10"	No charge when ordered with Wrangler style hood.  Must be ordered with hood for quality assurance.	
	DCWW03016	16"		
	DCWW03022	22"		
	DCWW03028	28"		
	DCWW03034	34"		
	DCWW03040	40"		
	DCWW03046	46"		
<b>Available Duct Covers for 36" Models</b>  <b>Duct Width: 12"</b>	DCWW03610	10"	No charge when ordered with Wrangler style hood.  Must be ordered with hood for quality assurance.	
	DCWW03616	16"		
	DCWW03622	22"		
	DCWW03628	28"		
	DCWW03634	34"		
	DCWW03640	40"		
	DCWW03646	46"		
<b>Available Duct Covers for 42" Models</b>  <b>Duct Width: 18"</b>	DCWW04210	10"	No charge when ordered with Wrangler style hood.  Must be ordered with hood for quality assurance.	
	DCWW04216	16"		
	DCWW04222	22"		
	DCWW04228	28"		
	DCWW04234	34"		
	DCWW04240	40"		
	DCWW04246	46"		

SIZE	MODEL	HEIGHT	UMRP	MSRP
<b>Available Duct Covers for 48" Models</b>  <b>Duct Width: 24"</b>	DCWW04810	10"	No charge when ordered with Wrangler style hood.  Must be ordered with hood for quality assurance.	
	DCWW04816	16"		
	DCWW04822	22"		
	DCWW04828	28"		
	DCWW04834	34"		
	DCWW04840	40"		
	DCWW04846	46"		
<b>Available Duct Covers for 54" Models</b>  <b>Duct Width: 30"</b>	DCWW05410	10"	No charge when ordered with Wrangler style hood.  Must be ordered with hood for quality assurance.	
	DCWW05416	16"		
	DCWW05422	22"		
	DCWW05428	28"		
	DCWW05434	34"		
	DCWW05440	40"		
<b>Available Duct Covers for 60" Models</b>  <b>Duct Width: 34"</b>	DCWW06010	10"	No charge when ordered with Wrangler style hood.  Must be ordered with hood for quality assurance.	
	DCWW06016	16"		
	DCWW06022	22"		
	DCWW06028	28"		
	DCWW06034	34"		
	DCWW06040	40"		
<b>Available Duct Covers for 66" Models</b>  <b>Duct Width: 42"</b>	DCWW06610	10"	No charge when ordered with Wrangler style hood.  Must be ordered with hood for quality assurance.	
	DCWW06616	16"		
	DCWW06622	22"		
	DCWW06628	28"		
	DCWW06634	34"		
	DCWW06640	40"		
	DCWW06646	46"		

Model Number Color & Customization Guide:			
(C) 190 Standard RAL (Semi-Gloss) Colors	(CF) Specialty Finish (190 Matte RAL, Precious Metals & Textures)	(CC) Custom Color Match	(PLT) Custom Only



Standard Height: 6" | Standard Depth: 34"

**FEATURES:**

- Commercial grade stainless steel construction
- Welded seamless corners
- Commercial style stainless steel baffle filter system
- 3-speed blower/variable light control
- 36" models: 600 CFM internal fan included **(Must be included on order)**
- Accommodates top discharge only
- Included duct cover heights: 18", 24", 30" & 36"
- **(Must be specified on order.)**
- Remote and In-line fans available

**CUSTOMIZATION OPTIONS:**

- 1,000+ Colors & Finishes
- Designer Metals like brass & copper
- Custom strapping & rivets
- Full custom options

(\* ) Trim finishes on Cooking & Refrigeration products are different substrates than the trim finishes on Ventilation hoods. Due to these differing processes and substrates the finishes will coordinate but may not match exactly.

Model	Description (* ) Denotes item that must be specified	UMRP	MSRP
BS-MANH-I-36-SS	36" Manhattan   Stainless Steel   600 CFM Blower	\$ 4,295	\$ 4,940
BS-MANH-I-42-SS	42" Manhattan   Stainless Steel	\$ 4,795	\$ 5,515
BS-MANH-I-48-SS	48" Manhattan   Stainless Steel	\$ 4,995	\$ 5,745
BS-MANH-I-54-SS	54" Manhattan   Stainless Steel	\$ 5,095	\$ 5,860
BS-MANH-I-60-SS	60" Manhattan   Stainless Steel	\$ 6,495	\$ 7,470
BS-MANH-I-66-SS	66" Manhattan   Stainless Steel	\$ 6,695	\$ 7,700

**COLOR OPTIONS:**

Std RAL: 36"	Standard 190 RAL Colors: 36" Models	\$ 1,195
Std RAL: 42" – 66"	Standard 190 RAL Colors: 42" – 66" Models	\$ 1,495
Spec Finish: 36"	Specialty Finish: 36" Models	\$ 2,195
Spec Finish: 42" – 66"	Specialty Finish: 42" – 66" Models	\$ 2,595
Custom Color: 36"	Custom Color: 36" Models	\$ 3,695
Custom Color: 42" – 66"	Custom Color: 42" – 66" Models	\$ 3,995

**DUCT COVERS FOR MANHATTAN HOODS:**

Refer to page 95 for all Manhattan Island hood duct cover options

- Included duct cover heights: 18", 24", 30" & 36" | Also available in 42" & 48" for additional charge

Refer to page 103 for Ventilation Hood Accessories

**NOTE: HOOD MUST BE MOUNTED TO CEILING AND CEILING ACCESS MAY BE REQUIRED. PLEASE REFERENCE THE INSTALLATION MANUAL ON BLUESTARCOOKING.COM FOR DETAILS**

**NOTE: MUST ORDER DUCT COVER FOR BLOWER & MOUNTING PURPOSES. MINIMUM 18" HIGH**

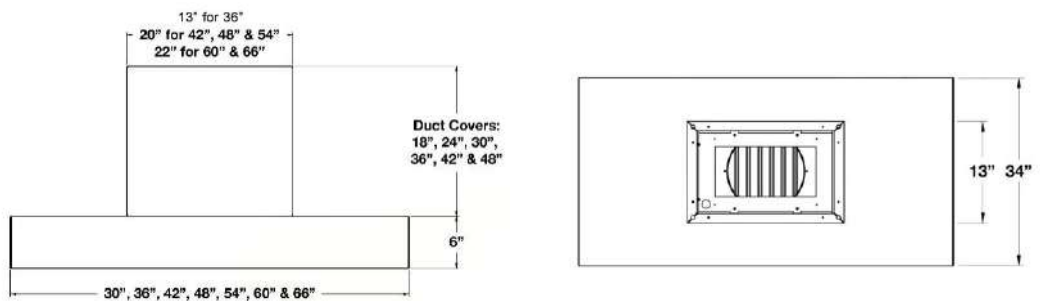

BLOWER OPTIONS	IN-HOOD		IN-LINE		REMOTE		DISCHARGE	
	CFM	POWER	CFM	POWER	CFM	POWER	TOP	REAR
MODEL #	PH-CFM-600	PH-CFM-1200	PH-INLB600	PH-INLB1200	PH-1000CFMR	PH-1400CFMR		
UMRP	\$ 965	\$ 1,385	\$ 1,520	\$ 1,875	\$ 1,890	\$ 2,020		
BS-MANH-I-36-SS	•		•	•	•	•	•	•
BS-MANH-I-42-SS	•	•	•	•	•	•	•	•
BS-MANH-I-48-SS	•	•	•	•	•	•	•	•
BS-MANH-I-54-SS	•	•	•	•	•	•	•	•
BS-MANH-I-60-SS	•	•	•	•	•	•	•	•
BS-MANH-I-66-SS	•	•	•	•	•	•	•	•

Denotes blower compatible with specific ventilation hood size. ATEX In-line and HY-EX Remote designated blowers are not compatible with this ventilation hood.

## DUCT COVERS: MANHATTAN ISLAND HOODS

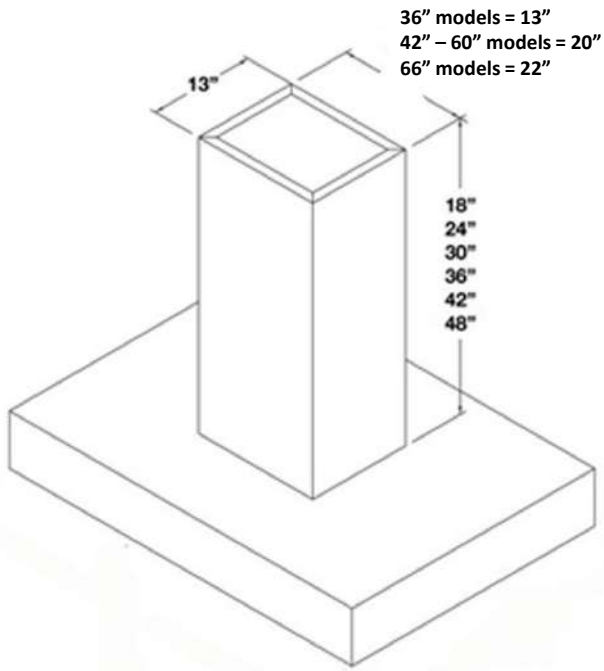

**NOTE: 18", 24", 30" & 36" DUCT COVERS INCLUDED WITH HOOD AT NO CHARGE. BELOW PRICING IS IF PURCHASED SEPARATELY.**

**NOTE: HOOD MUST BE MOUNTED TO CEILING AND CEILING ACCESS MAY BE REQUIRED. PLEASE REFERENCE THE INSTALLATION MANUAL ON [BLUESTARCOOKING.COM](http://BLUESTARCOOKING.COM) FOR DETAILS**

**NOTE: MUST ORDER DUCT COVER FOR BLOWER & MOUNTING PURPOSES. MINIMUM 18" HIGH**

SIZE	MODEL	HEIGHT	UMRP	MSRP
<p style="text-align: center;">Available Duct Covers for 36" Mahattan Island Models</p> <p>18", 24" 30" &amp; 36" Duct Covers included with Hood at No Charge if Ordered with the Hood. <b>MUST ORDER DUCT COVER FOR BLOWER &amp; MOUNTING PURPOSES - MIN. 18" HIGH</b></p>	PH-DC18MANH36I	18"	\$ 755	\$ 870
	PH-DC24MANH36I	24"	\$ 830	\$ 955
	PH-DC30MANH36I	30"	\$ 895	\$ 1,030
	PH-DC36MANH36I	36"	\$ 1,035	\$ 1,190
<p style="text-align: center;">Available Duct Covers for 42", 48", 54" &amp; 60" Models</p> <p>18", 24" 30" &amp; 36" Duct Covers included with Hood at No Charge if Ordered with the Hood. <b>MUST ORDER DUCT COVER FOR BLOWER &amp; MOUNTING PURPOSES - MIN. 18" HIGH</b></p>	PH-DC18MANH48I	18"	\$ 755	\$ 870
	PH-DC24MANH48I	24"	\$ 830	\$ 955
	PH-DC30MANH48I	30"	\$ 895	\$ 1,030
	PH-DC36MANH48I	36"	\$ 1,035	\$ 1,190
	PH-DC42MANH48I	42"	\$ 1,100	\$ 1,275
	PH-DC48MANH48I	48"	\$ 1,180	\$ 1,355
<p style="text-align: center;">Available Duct Covers for 66" Models</p> <p>18", 24" 30" &amp; 36" Duct Covers included with Hood at No Charge if Ordered with the Hood. <b>MUST ORDER DUCT COVER FOR BLOWER &amp; MOUNTING PURPOSES - MIN. 18" HIGH</b></p>	PH-DC18MANH66I	18"	\$ 755	\$ 870
	PH-DC24MANH66I	24"	\$ 830	\$ 955
	PH-DC30MANH66I	30"	\$ 895	\$ 1,030
	PH-DC36MANH66I	36"	\$ 1,035	\$ 1,190
	PH-DC42MANH66I	42"	\$ 1,100	\$ 1,275

# ABBAKA SERIES: 30" & 36" RIDGELINE WALL HOODS

REQUEST A QUOTE  
QUOTE@BLUESTARCOOKING.COM

Model Number Color & Customization Guide:				
(C) 190 Standard RAL (Semi-Gloss) Colors	(CF) Specialty Finish (190 Matte RAL, Precious Metals & Textures)	(CC) Custom Color Match	(PLT) Stainless Steel Straps & Rivets	(D) Designer Metal Straps & Rivets



Standard Height: 18" | Bottom Depth: 24 1/4" | Top Depth: 12"

### FEATURES:

- Professional-grade performance with three exhaust settings and new Boost feature
- Whisper quiet operation
- Heavy duty, commercial grade materials
- Dimmable LED lighting
- Easy-to-use push-button controls
- Innovative, multi-stage grease capture system
- Stainless baffle filters seamlessly remove for easy dishwasher cleaning
- Choose from stainless steel or 1,000+ colors and finishes
- Simple installation
- 30" & 36" models: 600 CFM internal fan included **(Must be included on order)**
- Available with top or rear discharge - Discharge is field reversible.
- Install with or without optional duct cover
- In-line, in-hood and remote blower compatible

### CUSTOMIZATION OPTIONS:

- 1,000+ Colors & Finishes
- Designer Metals like brass & copper
- Custom strapping & rivets
- Full custom options

(\* Trim finishes on Cooking & Refrigeration products are different substrates than the trim finishes on Ventilation hoods. Due to these differing processes and substrates the finishes will coordinate but may not match exactly.

Model	Description (* Denotes item that must be specified)	UMRP	MSRP	
<b>30" RIDGELINE HOODS:</b>				
RL030MLPLT	Body: Stainless Steel   Strap/Rivets: Stainless Steel   600 CFM	\$ 6,895	\$ 7,930	
RL030MLPLTD	Body: Stainless Steel   Strap/Rivets: Des. Metal*   600 CFM	\$ 7,190	\$ 8,270	
RL030MLPLTC	Body: Std RAL Color*   Strap/Rivets: Stainless Steel   600 CFM	\$ 8,090	\$ 9,305	
RL030MLPLTDC	Body: Std RAL Color*   Strap/Rivets: Des Metal*   600 CFM	\$ 8,385	\$ 9,645	
RL030MLPLTCF	Body: Spec. Finish*   Strap/Rivets: Stainless Steel   600 CFM	\$ 9,090	\$ 10,455	
RL030MLPLTDCF	Body: Spec. Finish*   Strap/Rivets: Des. Metal*   600 CFM	\$ 9,385	\$ 10,795	
RL030MLPLTCC	Body: Custom Color*   Strap/Rivets: Stainless Steel   600 CFM	\$ 10,590	\$ 12,180	
RL030MLPLTDCC	Body: Custom Color*   Strap/Rivets: Des. Metal*   600 CFM	\$ 10,885	\$ 12,520	
<b>36" RIDGELINE HOODS:</b>				
RL036MLPLT	Body: Stainless Steel   Strap/Rivets: Stainless Steel   600 CFM	\$ 7,495	\$ 8,620	
RL036MLPLTD	Body: Stainless Steel   Strap/Rivets: Des. Metal*   600 CFM	\$ 7,890	\$ 9,075	
RL036MLPLTC	Body: Std RAL Color*   Strap/Rivets: Stainless Steel   600 CFM	\$ 8,690	\$ 9,995	
RL036MLPLTDC	Body: Std RAL Color*   Strap/Rivets: Des Metal*   600 CFM	\$ 9,085	\$ 10,450	
RL036MLPLTCF	Body: Spec. Finish*   Strap/Rivets: Stainless Steel   600 CFM	\$ 9,690	\$ 11,145	
RL036MLPLTDCF	Body: Spec. Finish*   Strap/Rivets: Des. Metal*   600 CFM	\$ 10,085	\$ 11,600	
RL036MLPLTCC	Body: Custom Color*   Strap/Rivets: Stainless Steel   600 CFM	\$ 11,190	\$ 12,870	
RL036MLPLTDCC	Body: Custom Color*   Strap/Rivets: Des. Metal*   600 CFM	\$ 11,585	\$ 13,325	
<b>DESIGNER METAL OPTIONS FOR STRAPPING &amp; RIVETS:</b>				
Brushed Stainless	Polished Stainless	Antique Brass	Brushed Brass	Polished Brass
Antique Copper	Brushed Copper	Polished Copper	Oil Rubbed Bronze	Pewter
<b>DUCT COVERS FOR RIDGELINE HOODS:</b>				
Refer to page 90 for all Ridgeline hood duct cover options				
• Included duct cover heights: 6", 12", 18", 24", 30", 36", 42" & 48"				
Refer to page 103 for Ventilation Hood Accessories				

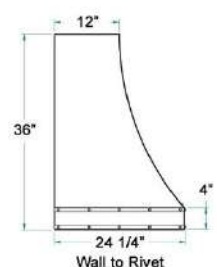
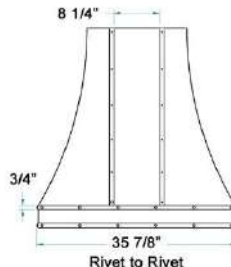
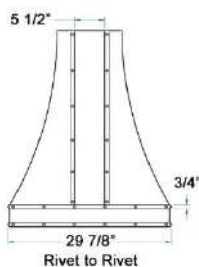

BLOWER OPTIONS	IN-HOOD		IN-LINE		REMOTE		DISCHARGE	
CFM POWER	600	1200	800	1200	1000	1400	TOP	REAR
MODEL #	BS-CFM-600-IN06	BS-CFM-1200-IN12	ATEX-0.8	ATEX-1.2	HYEX-1.0-GA	HYEX-1.4-GA		
UMRP	\$ 965	\$ 995	\$ 1,260	\$ 1,510	\$ 1,385	\$ 1,640	Available at time of order	
RL030MLPLT	•		•	•	•	•		
RL036MLPLT	•	•	•	•	•	•		
RL042MLPLT	•	•	•	•	•	•		
RL048MLPLT	•	•	•	•	•	•		
RL054MLPLT	•	•	•	•	•	•		
RL060MLPLT	•	•	•	•	•	•		

## DESIGNER SERIES: 42", 48", 54" & 60" RIDGELINE WALL HOODS

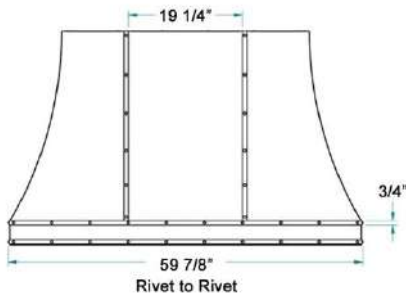
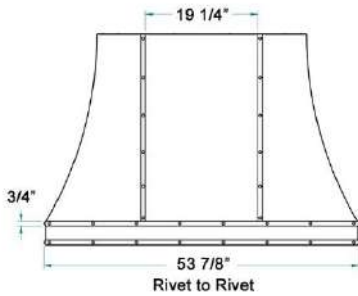
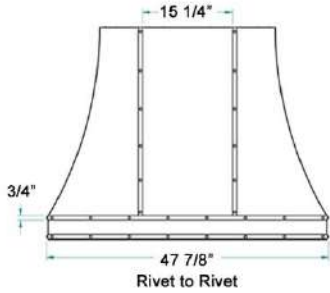
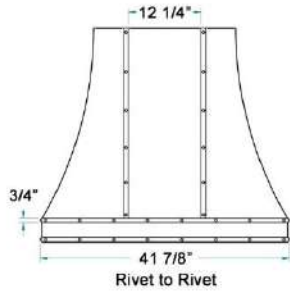

42" RIDGELINE CURVED SIDES HOODS:		UMRP	MSRP
RL042MLPLT	Body: Stainless Steel   Strap/Rivets: Stainless Steel	\$ 7,995	\$ 9,195
RL042MLPLTD	Body: Stainless Steel   Strap/Rivets: Des. Metal*	\$ 8,390	\$ 9,650
RL042MLPLTC	Body: Std RAL Color*   Strap/Rivets: Stainless Steel	\$ 9,490	\$ 10,915
RL042MLPLTDC	Body: Std RAL Color*   Strap/Rivets: Des Metal*	\$ 9,885	\$ 11,370
RL042MLPLTCF	Body: Spec. Finish*   Strap/Rivets: Stainless Steel	\$ 10,590	\$ 12,180
RL042MLPLTDCF	Body: Spec. Finish*   Strap/Rivets: Des. Metal*	\$ 10,985	\$ 12,635
RL042MLPLTCC	Body: Custom Color*   Strap/Rivets: Stainless Steel	\$ 11,990	\$ 13,790
RL042MLPLTDCC	Body: Custom Color*   Strap/Rivets: Des. Metal*	\$ 12,385	\$ 14,245
48" RIDGELINE HOODS:		UMRP	MSRP
RL048MLPLT	Body: Stainless Steel   Strap/Rivets: Stainless Steel	\$ 8,495	\$ 9,770
RL048MLPLTD	Body: Stainless Steel   Strap/Rivets: Des. Metal*	\$ 8,890	\$ 10,225
RL048MLPLTC	Body: Std RAL Color*   Strap/Rivets: Stainless Steel	\$ 9,990	\$ 11,490
RL048MLPLTDC	Body: Std RAL Color*   Strap/Rivets: Des Metal*	\$ 10,385	\$ 11,945
RL048MLPLTCF	Body: Spec. Finish*   Strap/Rivets: Stainless Steel	\$ 11,090	\$ 12,755
RL048MLPLTDCF	Body: Spec. Finish*   Strap/Rivets: Des. Metal*	\$ 11,485	\$ 13,210
RL048MLPLTCC	Body: Custom Color*   Strap/Rivets: Stainless Steel	\$ 12,490	\$ 14,365
RL048MLPLTDCC	Body: Custom Color*   Strap/Rivets: Des. Metal*	\$ 12,885	\$ 14,820
54" RIDGELINE HOODS:		UMRP	MSRP
RL054MLPLT	Body: Stainless Steel   Strap/Rivets: Stainless Steel	\$ 9,895	\$ 11,380
RL054MLPLTD	Body: Stainless Steel   Strap/Rivets: Des. Metal*	\$ 10,290	\$ 11,835
RL054MLPLTC	Body: Std RAL Color*   Strap/Rivets: Stainless Steel	\$ 11,390	\$ 13,100
RL054MLPLTDC	Body: Std RAL Color*   Strap/Rivets: Des Metal*	\$ 11,785	\$ 13,555
RL054MLPLTCF	Body: Spec. Finish*   Strap/Rivets: Stainless Steel	\$ 12,490	\$ 14,365
RL054MLPLTDCF	Body: Spec. Finish*   Strap/Rivets: Des. Metal*	\$ 12,885	\$ 14,820
RL054MLPLTCC	Body: Custom Color*   Strap/Rivets: Stainless Steel	\$ 13,890	\$ 15,975
RL054MLPLTDCC	Body: Custom Color*   Strap/Rivets: Des. Metal*	\$ 14,285	\$ 16,460
60" RIDGELINE HOODS:		UMRP	MSRP
RL060MLPLT	Body: Stainless Steel   Strap/Rivets: Stainless Steel	\$ 11,595	\$ 13,335
RL060MLPLTD	Body: Stainless Steel   Strap/Rivets: Des. Metal*	\$ 11,990	\$ 13,790
RL060MLPLTC	Body: Std RAL Color*   Strap/Rivets: Stainless Steel	\$ 13,090	\$ 15,055
RL060MLPLTDC	Body: Std RAL Color*   Strap/Rivets: Des Metal*	\$ 13,485	\$ 15,510
RL060MLPLTCF	Body: Spec. Finish*   Strap/Rivets: Stainless Steel	\$ 14,190	\$ 16,320
RL060MLPLTDCF	Body: Spec. Finish*   Strap/Rivets: Des. Metal*	\$ 15,585	\$ 16,775
RL060MLPLTCC	Body: Custom Color*   Strap/Rivets: Stainless Steel	\$ 15,590	\$ 17,930
RL060MLPLTDCC	Body: Custom Color*   Strap/Rivets: Des. Metal*	\$ 15,985	\$ 18,385

# ABBAKA SERIES: ATLAS WALL HOODS

REQUEST A QUOTE  
QUOTE@BLUESTARCOOKING.COM

Model Number Color & Customization Guide:				
(C) 190 Standard RAL (Semi-Gloss) Colors	(CF) Specialty Finish (190 Matte RAL, Precious Metals & Textures)	(CC) Custom Color Match	(PLT) Stainless Steel Straps & Rivets	(D) Designer Metal Straps & Rivets



30" & 36" Atlas Wall Hood

Standard Height: 30" | Bottom Depth: 24 1/4" | Top Depth: 12"

### FEATURES:

- Professional-grade performance with three exhaust settings and new Boost feature
- Whisper quiet operation
- Heavy duty, commercial grade materials
- Dimmable LED lighting
- Easy-to-use push-button controls
- Innovative, multi-stage grease capture system
- Stainless baffle filters seamlessly remove for easy dishwasher cleaning
- Choose from stainless steel or 1,000+ colors and finishes
- Simple installation
- 30" & 36" models: 600 CFM internal fan included (*Must be included on order*)
- Available with top or rear discharge - Discharge is field reversible.
- In-line, in-hood and remote blower compatible

### CUSTOMIZATION OPTIONS:

- 1,000+ Colors & Finishes
- Designer Metals like brass & copper
- Custom strapping & rivets
- Full custom options

(\*) Trim finishes on Cooking & Refrigeration products are different substrates than the trim finishes on Ventilation hoods. Due to these differing processes and substrates the finishes will coordinate but may not match exactly.

Model	Description (* Denotes item that must be specified)	UMRP	MSRP	
<b>30" ATLAS HOODS: (3 Vertical Straps   1 Horizontal)</b>				
AT030MLPLT	Body: Stainless Steel   Strap/Rivets: Stainless Steel   600 CFM	\$ 5,795	\$ 6,665	
AT030MLPLTD	Body: Stainless Steel   Strap/Rivets: Des. Metal*   600 CFM	\$ 6,090	\$ 7,005	
AT030MLPLTC	Body: Std RAL Color*   Strap/Rivets: Stainless Steel   600 CFM	\$ 6,990	\$ 8,040	
AT030MLPLTDC	Body: Std RAL Color*   Strap/Rivets: Des Metal*   600 CFM	\$ 7,285	\$ 8,380	
AT030MLPLTCF	Body: Spec. Finish*   Strap/Rivets: Stainless Steel   600 CFM	\$ 7,990	\$ 9,190	
AT030MLPLTDCF	Body: Spec. Finish*   Strap/Rivets: Des. Metal*   600 CFM	\$ 8,285	\$ 9,530	
AT030MLPLTCC	Body: Custom Color*   Strap/Rivets: Stainless Steel   600 CFM	\$ 9,490	\$ 10,915	
AT030MLPLTDCC	Body: Custom Color*   Strap/Rivets: Des. Metal*   600 CFM	\$ 9,785	\$ 11,255	
<b>36" ATLAS HOODS: (3 Vertical Straps   1 Horizontal)</b>				
AT036MLPLT	Body: Stainless Steel   Strap/Rivets: Stainless Steel   600 CFM	\$ 6,095	\$ 7,010	
AT036MLPLTD	Body: Stainless Steel   Strap/Rivets: Des. Metal*   600 CFM	\$ 6,490	\$ 7,465	
AT036MLPLTC	Body: Std RAL Color*   Strap/Rivets: Stainless Steel   600 CFM	\$ 7,290	\$ 8,385	
AT036MLPLTDC	Body: Std RAL Color*   Strap/Rivets: Des Metal*   600 CFM	\$ 7,685	\$ 8,840	
AT036MLPLTCF	Body: Spec. Finish*   Strap/Rivets: Stainless Steel   600 CFM	\$ 8,290	\$ 9,535	
AT036MLPLTDCF	Body: Spec. Finish*   Strap/Rivets: Des. Metal*   600 CFM	\$ 8,685	\$ 9,990	
AT036MLPLTCC	Body: Custom Color*   Strap/Rivets: Stainless Steel   600 CFM	\$ 9,790	\$ 11,260	
AT036MLPLTDCC	Body: Custom Color*   Strap/Rivets: Des. Metal*   600 CFM	\$ 10,185	\$ 11,715	
<b>DESIGNER METAL OPTIONS FOR STRAPPING &amp; RIVETS:</b>				
Brushed Stainless	Polished Stainless	Antique Brass	Brushed Brass	Polished Brass
Antique Copper	Brushed Copper	Polished Copper	Oil Rubbed Bronze	Pewter
<b>VENTILATION HOOD ACCESSORIES:</b>				
Refer to page 87 for all Atlas hood duct cover options				
• Available duct cover heights: 2", 6", 12", 18", 24", 30", 36", 42" & 48"				
Refer to page 103 for Ventilation Hood Accessories				

BLOWER OPTIONS-	IN-HOOD		IN-LINE		REMOTE		DISCHARGE			
CFM POWER	600	1200	800	1200	1000	1400	TOP	REAR		
MODEL #	BS-CFM-600-IN06	BS-CFM-1200-IN12	ATEX-0.8	ATEX-1.2	HYEX-1.0-GA	HYEX-1.4-GA				
UMRP	\$ 965	\$ 995	\$ 1,260	\$ 1,510	\$ 1,385	\$ 1,640	Available at time of order			
AT030MLPLT	•		•	•	•	•			•	•
AT036MLPLT	•	•	•	•	•	•			•	•
AT042MLPLT	•	•	•	•	•	•			•	•
AT048MLPLT	•	•	•	•	•	•			•	•
AT054MLPLT	•	•	•	•	•	•			•	•
AT060MLPLT	•	•	•	•	•	•			•	•
AT066MLPLT	•	•	•	•	•	•	•	•		

## DESIGNER SERIES: 42", 48", 54" & 66" ATLAS WALL HOODS



42", 48", 54" & 66" Atlas Wall Hood

Standard Height: 30" | Bottom Depth: 24 1/4" | Top Depth: 12"



66" Atlas Wall Hood

Standard Height: 18" | Bottom Depth: 24 1/4" | Top Depth: 12"

42" ATLAS HOODS: (4 Vertical Straps   1 Horizontal)		UMRP	MSRP
AT042MLPLT	Body: Stainless Steel   Strap/Rivets: Stainless Steel	\$ 6,695	\$ 7,700
AT042MLPLTD	Body: Stainless Steel   Strap/Rivets: Des. Metal*	\$ 7,090	\$ 8,155
AT042MLPLTC	Body: Std RAL Color*   Strap/Rivets: Stainless Steel	\$ 8,190	\$ 9,420
AT042MLPLTDC	Body: Std RAL Color*   Strap/Rivets: Des Metal*	\$ 8,585	\$ 9,875
AT042MLPLTCF	Body: Spec. Finish*   Strap/Rivets: Stainless Steel	\$ 9,290	\$ 10,685
AT042MLPLTDCF	Body: Spec. Finish*   Strap/Rivets: Des. Metal*	\$ 9,685	\$ 11,140
AT042MLPLTCC	Body: Custom Color*   Strap/Rivets: Stainless Steel	\$ 10,690	\$ 12,295
AT042MLPLTDCC	Body: Custom Color*   Strap/Rivets: Des. Metal*	\$ 11,085	\$ 12,750
48" ATLAS HOODS: (4 Vertical Straps   1 Horizontal)		UMRP	MSRP
AT048MLPLT	Body: Stainless Steel   Strap/Rivets: Stainless Steel	\$ 6,895	\$ 7,930
AT048MLPLTD	Body: Stainless Steel   Strap/Rivets: Des. Metal*	\$ 7,290	\$ 8,385
AT048MLPLTC	Body: Std RAL Color*   Strap/Rivets: Stainless Steel	\$ 8,390	\$ 9,650
AT048MLPLTDC	Body: Std RAL Color*   Strap/Rivets: Des Metal*	\$ 8,785	\$ 10,105
AT048MLPLTCF	Body: Spec. Finish*   Strap/Rivets: Stainless Steel	\$ 9,490	\$ 10,915
AT048MLPLTDCF	Body: Spec. Finish*   Strap/Rivets: Des. Metal*	\$ 9,885	\$ 11,370
AT048MLPLTCC	Body: Custom Color*   Strap/Rivets: Stainless Steel	\$ 10,890	\$ 12,525
AT048MLPLTDCC	Body: Custom Color*   Strap/Rivets: Des. Metal*	\$ 11,285	\$ 12,980
54" ATLAS HOODS: (4 Vertical Straps   1 Horizontal)		UMRP	MSRP
AT054MLPLT	Body: Stainless Steel   Strap/Rivets: Stainless Steel	\$ 7,195	\$ 8,275
AT054MLPLTD	Body: Stainless Steel   Strap/Rivets: Des. Metal*	\$ 7,590	\$ 8,730
AT054MLPLTC	Body: Std RAL Color*   Strap/Rivets: Stainless Steel	\$ 8,690	\$ 9,995
AT054MLPLTDC	Body: Std RAL Color*   Strap/Rivets: Des Metal*	\$ 9,085	\$ 10,450
AT054MLPLTCF	Body: Spec. Finish*   Strap/Rivets: Stainless Steel	\$ 9,790	\$ 11,260
AT054MLPLTDCF	Body: Spec. Finish*   Strap/Rivets: Des. Metal*	\$ 10,185	\$ 11,715
AT054MLPLTCC	Body: Custom Color*   Strap/Rivets: Stainless Steel	\$ 11,190	\$ 12,870
AT054MLPLTDCC	Body: Custom Color*   Strap/Rivets: Des. Metal*	\$ 11,585	\$ 13,325
60" ATLAS HOODS: (4 Vertical Straps   1 Horizontal)		UMRP	MSRP
AT060MLPLT	Body: Stainless Steel   Strap/Rivets: Stainless Steel	\$ 7,595	\$ 8,735
AT060MLPLTD	Body: Stainless Steel   Strap/Rivets: Des. Metal*	\$ 7,990	\$ 9,190
AT060MLPLTC	Body: Std RAL Color*   Strap/Rivets: Stainless Steel	\$ 9,090	\$ 10,455
AT060MLPLTDC	Body: Std RAL Color*   Strap/Rivets: Des Metal*	\$ 9,485	\$ 10,910
AT060MLPLTCF	Body: Spec. Finish*   Strap/Rivets: Stainless Steel	\$ 10,190	\$ 11,720
AT060MLPLTDCF	Body: Spec. Finish*   Strap/Rivets: Des. Metal*	\$ 10,585	\$ 12,175
AT060MLPLTCC	Body: Custom Color*   Strap/Rivets: Stainless Steel	\$ 11,590	\$ 13,330
AT060MLPLTDCC	Body: Custom Color*   Strap/Rivets: Des. Metal*	\$ 11,985	\$ 13,785
66" ATLAS HOODS: (5 Vertical Straps   1 Horizontal)		UMRP	MSRP
AT066MLPLT	Body: Stainless Steel   Strap/Rivets: Stainless Steel	\$ 8,295	\$ 9,540
AT066MLPLTD	Body: Stainless Steel   Strap/Rivets: Des. Metal*	\$ 8,690	\$ 9,995
AT066MLPLTC	Body: Std RAL Color*   Strap/Rivets: Stainless Steel	\$ 9,790	\$ 11,260
AT066MLPLTDC	Body: Std RAL Color*   Strap/Rivets: Des Metal*	\$ 10,185	\$ 11,715
AT066MLPLTCF	Body: Spec. Finish*   Strap/Rivets: Stainless Steel	\$ 10,890	\$ 12,525
AT066MLPLTDCF	Body: Spec. Finish*   Strap/Rivets: Des. Metal*	\$ 11,285	\$ 12,980
AT066MLPLTCC	Body: Custom Color*   Strap/Rivets: Stainless Steel	\$ 12,290	\$ 14,135
AT066MLPLTDCC	Body: Custom Color*   Strap/Rivets: Des. Metal*	\$ 12,685	\$ 14,590

# ABBAKA SERIES: MESA WALL HOODS

REQUEST A QUOTE  
QUOTE@BLUESTARCOOKING.COM

## Model Number Color & Customization Guide:

(C) 190 Standard RAL (Semi-Gloss) Colors	(CF) Specialty Finish (190 Matte RAL, Precious Metals & Textures)	(CC) Custom Color Match	(PLT) Custom Only
--	---	-------------------------	-------------------



Standard Height: 30" | Bottom Depth: 24" | Top Depth: 12"

### FEATURES:

- Professional-grade performance with three exhaust settings and new Boost feature
- Whisper quiet operation
- Heavy duty, commercial grade materials
- Dimmable LED lighting
- Easy-to-use push-button controls
- Innovative, multi-stage grease capture system
- Stainless baffle filters seamlessly remove for easy dishwasher cleaning
- Choose from stainless steel or 1,000+ colors and finishes
- Simple installation
- 30" & 36" models: 600 CFM internal fan included (*Must be included on order*)
- Available with top or rear discharge - Discharge is field reversible.
- In-line, in-hood and remote blower compatible

### CUSTOMIZATION OPTIONS:

- 1,000+ Colors & Finishes
- Designer Metals like brass & copper
- Custom strapping & rivets
- Full custom options

(\* ) Trim finishes on Cooking & Refrigeration products are different substrates than the trim finishes on Ventilation hoods. Due to these differing processes and substrates the finishes will coordinate but may not match exactly.

Model	Description (* ) Denotes item that must be specified	UMRP	MSRP
ME030ML	30" Mesa   Stainless Steel   600 CFM Blower	\$ 3,795	\$ 4,365
ME030MLC	30" Mesa   Std RAL Color*   600 CFM Blower	\$ 4,990	\$ 5,740
ME030MLCF	30" Mesa   Specialty Finish*   600 CFM Blower	\$ 5,990	\$ 6,890
ME030MLCC	30" Mesa   Custom Color*   600 CFM Blower	\$ 7,490	\$ 8,615
ME036ML	36" Mesa   Stainless Steel   600 CFM Blower	\$ 3,895	\$ 4,480
ME036MLC	36" Mesa   Std RAL Color*   600 CFM Blower	\$ 5,090	\$ 5,855
ME036MLCF	36" Mesa   Specialty Finish*   600 CFM Blower	\$ 6,090	\$ 7,005
ME036MLCC	36" Mesa   Custom Color*   600 CFM Blower	\$ 7,590	\$ 8,730
ME042ML	42" Mesa   Stainless Steel	\$ 4,095	\$ 4,710
ME042MLC	42" Mesa   Std RAL Color*	\$ 5,590	\$ 6,430
ME042MLCF	42" Mesa   Specialty Finish*	\$ 6,690	\$ 7,695
ME042MLCC	42" Mesa   Custom Color*	\$ 8,090	\$ 9,305
ME048ML	48" Mesa   Stainless Steel	\$ 4,395	\$ 5,055
ME048MLC	48" Mesa   Std RAL Color*	\$ 5,890	\$ 6,775
ME048MLCF	48" Mesa   Specialty Finish*	\$ 6,990	\$ 8,040
ME048MLCC	48" Mesa   Custom Color*	\$ 8,390	\$ 9,650
ME054ML	54" Mesa   Stainless Steel	\$ 4,495	\$ 5,170
ME054MLC	54" Mesa   Std RAL Color*	\$ 5,990	\$ 6,890
ME054MLCF	54" Mesa   Specialty Finish*	\$ 7,090	\$ 8,155
ME054MLCC	54" Mesa   Custom Color*	\$ 8,490	\$ 9,765
ME060ML	60" Mesa   Stainless Steel	\$ 4,795	\$ 5,515
ME060MLC	60" Mesa   Std RAL Color*	\$ 6,290	\$ 7,235
ME060MLCF	60" Mesa   Specialty Finish*	\$ 7,390	\$ 8,500
ME060MLCC	60" Mesa   Custom Color*	\$ 8,790	\$ 10,110
ME066ML	66" Mesa   Stainless Steel	\$ 5,095	\$ 5,860
ME066MLC	66" Mesa   Std RAL Color*	\$ 6,590	\$ 7,580
ME066MLCF	66" Mesa   Specialty Finish*	\$ 7,690	\$ 8,845
ME066MLCC	66" Mesa   Custom Color*	\$ 9,090	\$ 10,455

### VENTILATION HOOD ACCESSORIES:

Refer to page 103 for Ventilation Hood Accessories

BLOWER OPTIONS	IN-HOOD		IN-LINE		REMOTE		DISCHARGE	
CFM POWER	600	1200	800	1200	1000	1400	TOP	REAR
MODEL #	BS-CFM-600-IN06	BS-CFM-1200-IN12	ATEX-0.8	ATEX-1.2	HYEX-1.0-GA	HYEX-1.4-GA		
UMRP	\$ 965	\$ 995	\$ 1,260	\$ 1,510	\$ 1,385	\$ 1,640		
ME030ML	•		•	•	•	•	•	Available at time of order
ME036ML	•	•	•	•	•	•	•	
ME042ML	•	•	•	•	•	•	•	
ME048ML	•	•	•	•	•	•	•	
ME054ML	•	•	•	•	•	•	•	
ME060ML	•	•	•	•	•	•	•	
ME066ML	•	•	•	•	•	•	•	

## ABBAKA SERIES: 36", 42" & 48" NORMANDY WALL HOODS

### Model Number Color & Customization Guide:

(C) 190 Standard RAL (Semi-Gloss) Colors	(CF) Specialty Finish (190 Matte RAL, Precious Metals & Textures)	(CC) Custom Color Match	(PLT) Custom Only
--	---	-------------------------	-------------------

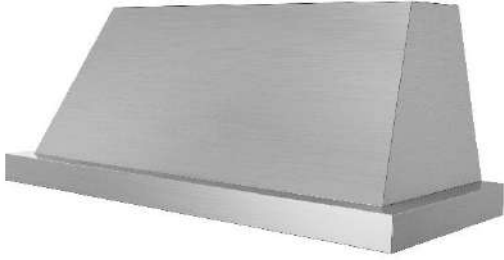

Standard Height: 30" | Bottom Depth: 24" | Top Depth: 12"

#### FEATURES:

- Professional-grade performance with three exhaust settings and new Boost feature
- Whisper quiet operation
- Heavy duty, commercial grade materials
- Dimmable LED lighting
- Easy-to-use push-button controls
- Innovative, multi-stage grease capture system
- Stainless baffle filters seamlessly remove for easy dishwasher cleaning
- Choose from stainless steel or 1,000+ colors and finishes
- Simple installation
- 36" models: 600 CFM internal fan included (*Must be included on order*)
- Available with top or rear discharge - Discharge is field reversible.
- In-line, in-hood and remote blower compatible

#### CUSTOMIZATION OPTIONS:

- 1,000+ Colors & Finishes
- Designer Metals like brass & copper
- Custom strapping & rivets
- Full custom options

Model	Description (* Denotes item that must be specified)	UMRP	MSRP
<b>All hoods include a brushed stainless steel lower reveal. For a lower reveal in a designer metal finish request a quote at <a href="mailto:quote@bluestarcooking.com">quote@bluestarcooking.com</a></b>			
NR036ML	36" Normandy   Stainless Steel   600 CFM Blower	\$ 6,295	\$ 7,240
NR036MLC	36" Normandy   Std RAL Color*   600 CFM Blower	\$ 7,490	\$ 8,615
NR036MLCF	36" Normandy   Specialty Finish*   600 CFM Blower	\$ 8,490	\$ 9,765
NR036MLCC	36" Normandy   Custom Color*   600 CFM Blower	\$ 9,990	\$ 11,490
NR042ML	42" Normandy   Stainless Steel	\$ 6,695	\$ 7,700
NR042MLC	42" Normandy   Std RAL Color*	\$ 8,190	\$ 9,420
NR042MLCF	42" Normandy   Specialty Finish*	\$ 9,290	\$ 10,685
NR042MLCC	42" Normandy   Custom Color*	\$ 10,690	\$ 12,295
NR048ML	48" Normandy   Stainless Steel	\$ 8,695	\$ 10,000
NR048MLC	48" Normandy   Std RAL Color*	\$ 10,190	\$ 11,720
NR048MLCF	48" Normandy   Specialty Finish*	\$ 11,290	\$ 12,985
NR048MLCC	48" Normandy   Custom Color*	\$ 12,690	\$ 14,595
<b>VENTILATION HOOD ACCESSORIES:</b>			
Refer to page 103 for Ventilation Hood Accessories			

(\* ) Trim finishes on Cooking & Refrigeration products are different substrates than the trim finishes on Ventilation hoods. Due to these differing processes and substrates the finishes will coordinate but may not match exactly.

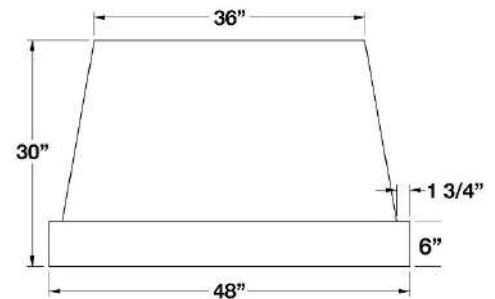
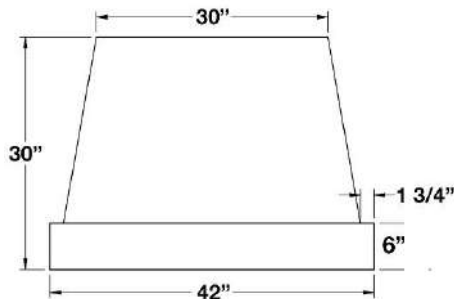
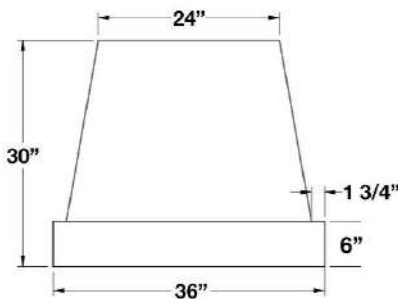

BLOWER OPTIONS	IN-HOOD		IN-LINE		REMOTE		DISCHARGE	
CFM POWER	600	1200	800	1200	1000	1400	TOP	REAR
MODEL #	BS-CFM-600-IN06	BS-CFM-1200-IN12	ATEX-0.8	ATEX-1.2	HYEX-1.0-GA	HYEX-1.4-GA		
UMRP	\$ 965	\$ 995	\$ 1,260	\$ 1,510	\$ 1,385	\$ 1,640	Available at time of order	
NR036MLPLT	•	•	•	•	•	•		
NR042MLPLT	•	•	•	•	•	•		
NR048MLPLT	•	•	•	•	•	•		
NR054MLPLT	•	•	•	•	•	•		
NR060MLPLT	•	•	•	•	•	•		
NR066MLPLT	•	•	•	•	•	•		

## ABBAKA SERIES: 54", 60" & 66" NORMANDY WALL HOODS

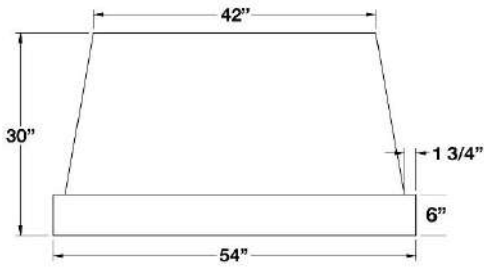

54" NORMANDY HOODS		UMRP	MSRP
NR054ML	54" Normandy   Stainless Steel	\$ 9,195	\$ 10,575
NR054MLC	54" Normandy   Std RAL Color*	\$ 10,690	\$ 12,295
NR054MLCF	54" Normandy   Specialty Finish*	\$ 11,790	\$ 13,560
NR054MLCC	54" Normandy   Custom Color*	\$ 13,190	\$ 15,170

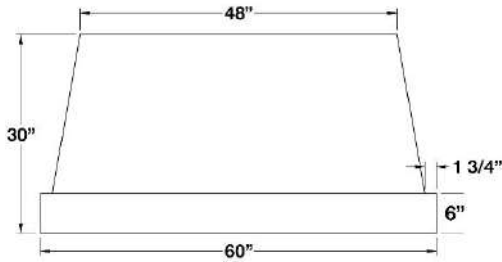

60" NORMANDY HOODS		UMRP	MSRP
NR060ML	60" Normandy   Stainless Steel	\$ 9,895	\$ 11,380
NR060MLC	60" Normandy   Std RAL Color*	\$ 11,390	\$ 13,100
NR060MLCF	60" Normandy   Specialty Finish*	\$ 12,490	\$ 14,365
NR060MLCC	60" Normandy   Custom Color*	\$ 13,890	\$ 15,975

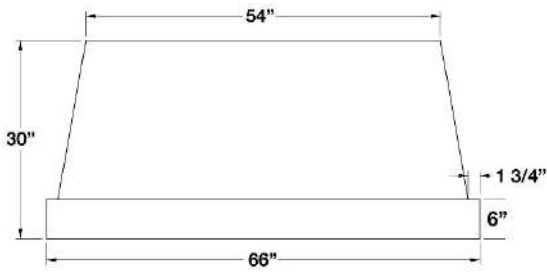

66" NORMANDY HOODS		UMRP	MSRP
NR066ML	66" Normandy   Stainless Steel	\$ 10,595	\$ 12,185
NR066MLC	66" Normandy   Std RAL Color*	\$ 12,090	\$ 13,905
NR066MLCF	66" Normandy   Specialty Finish*	\$ 13,190	\$ 15,170
NR066MLCC	66" Normandy   Custom Color*	\$ 14,590	\$ 16,780

## VENTILATION HOODS: CUSTOMIZATION & ACCESSORY OPTIONS

BLOWERS & TRANSITIONS: BLUESTAR PROFESSIONAL & DESIGNER SERIES HOODS			
Model	Description	UMRP	MSRP
<b>BLOWERS AND TRANSITIONS: PL, PY, BZ, HA, MA, SC,WR, RL, AT, ME, NR &amp; PM</b>			
BS-CFM-600-IN06	INTERNAL 3 speed 600 cfm blower	\$ 965	\$ 1,110
BS-CFM-1200-IN12	INTERNAL 3 speed 1200 cfm blower	\$ 995	\$ 1,145
ATEX-0.8	800 CFM IN LINE 8" DUCT	\$ 1,260	\$ 1,450
ATEX-1.2	1200 CFM IN LINE 10" DUCT	\$ 1,510	\$ 1,735
SW-ATEX1.2	Wall Switch for ATEX Series Inline Blowers	\$ 140	\$ 160
HYEX-1.0-GA	1000 CFM 8" DUCT GALVALUME	\$ 1,385	\$ 1,595
HYEX-1.4-GA	1400 CFM 10" DUCT GALVALUME	\$ 1,640	\$ 1,885
781100	Wall Switch for HYEX Series Remote Blowers	\$ 65 ea	\$ 75 ea
SM-10	Muffler & Isolation Clamps - 10" Duct	\$ 620	\$ 715
SM-08	Muffler & Isolation Clamps - 8" Duct	\$ 550	\$ 635

Model	Description	UMRP	MSRP
<b>BLOWERS &amp; TRANSITIONS: MANHATTAN ISLAND &amp; PRE-MAY 2020 VENTILATION HOODS</b>			
PH-CFM-600	INTERNAL 3 speed 600 cfm blower	\$ 965	\$ 1,110
PH-CFM-1200	INTERNAL 3 speed 1200 cfm blower	\$ 1,385	\$ 1,595
PH-CFMR-1000	REMOTE 3 speed 1000 cfm blower	\$ 1,890	\$ 2,175
PH-CFMR-1400	REMOTE 3 speed 1400 cfm blower	\$ 2,020	\$ 2,325
PH-INLB600	INLINE 3 speed 600 cfm INLINE blower	\$ 1,520	\$ 1,750
PH-INLB1200	INLINE 3 speed 1200 cfm INLINE blower	\$ 1,875	\$ 2,155
780038	Transition for top discharge, 6 x 15 to 8" round - 8" h. with damper	\$ 295	\$ 340
780037	Transition for top discharge, 6 x 15 to 10" round - 8" h. with damper	\$ 305	\$ 350
780188	Transition for rear discharge, 6 x 15 to 8" round - 3.5" h. without damper	\$ 295	\$ 340
780189	Transition for rear discharge, 6 x 15 to 10" round - 3.5" h. without damper	\$ 305	\$ 350

WALL LINERS:				
	Model	Description	UMRP	MSRP
<p>Height 38"</p> <p>30" 36" 42" 48" 54" 60" 66"</p>	WL-30-SS	Wall Liner: 30"w x 38"h	\$ 485	\$ 560
	WL-36-SS	Wall Liner: 36"w x 38"h	\$ 525	\$ 605
	WL-42-SS	Wall Liner: 42"w x 38"h	\$ 550	\$ 635
	WL-48-SS	Wall Liner: 48"w x 38"h	\$ 575	\$ 660
	WL-54-SS	Wall Liner: 54"w x 38"h	\$ 600	\$ 690
	WL-60-SS	Wall Liner: 60"w x 38"h	\$ 650	\$ 745
	WL-66-SS	Wall Liner: 66"w x 38"h	\$ 675	\$ 775

## CUSTOMIZATION SUMMARY GUIDE

COOKING: FREESTANDING RANGES	Product	Standard RAL Paint Paint Semi-Gloss (C)	Custom Finishes Matte & Textures (CF)	Custom Colors Custom Match (CC)	Plated Trim Kit (PLT)
	24" Models	\$ 1,195	\$ 2,195	\$ 3,695	\$ 1,595
	30" Models	\$ 1,195	\$ 2,195	\$ 3,695	\$ 1,595
	36" Models	\$ 1,195	\$ 2,195	\$ 3,695	\$ 1,895
	48" Models	\$ 1,495	\$ 2,595	\$ 3,995	\$ 2,195
	60" Models	\$ 1,495	\$ 2,595	\$ 3,995	\$ 2,495

COOKING: WALL OVENS	Product	Standard RAL Paint Paint Semi-Gloss (C)	Custom Finishes Matte & Textures (CF)	Custom Colors Custom Match (CC)	Plated Trim Kit (PLT)
	30" Double	\$ 1,495	\$ 2,395	\$ 3,795	\$ 2,395
	24" Single	\$ 1,195	\$ 2,195	\$ 3,695	\$ 1,095
	30" Single	\$ 1,195	\$ 2,195	\$ 3,695	\$ 1,595
	36" Single	\$ 1,195	\$ 2,195	\$ 3,695	\$ 1,595

COOKING: RANGETOPS, INDUCTION COOKTOP & SALAMANDER	Product	Standard RAL Paint Paint Semi-Gloss (C)	Custom Finishes Matte & Textures (CF)	Custom Colors Custom Match (CC)	Plated Trim Kit (PLT)
	24" Models	N/C	N/C	N/C	\$ 795
	30" Models	N/C	N/C	N/C	\$ 795
	36" Models	N/C	N/C	N/C	\$ 1,095
	48" Models	N/C	N/C	N/C	\$ 1,495
	60" Models	N/C	N/C	N/C	\$ 1,795
	Salamander	N/C	N/C	N/C	\$ 1,095

COOKING: KNOBS	Product	Standard RAL Paint Paint Semi-Gloss (C)	Custom Finishes Matte & Textures (CF)	Custom Colors Custom Match (CC)	Plated (PLT)
	Knob Price Each	\$ 115 ea	\$ 185 ea	\$ 200 ea	\$ 250 ea

REFRIGERATION:	Product	Standard RAL Paint Paint Semi-Gloss (C)	Custom Finishes Matte & Textures (CF)	Custom Colors Custom Match (CC)	Plated Trim Kit (PLT)
	36" Built-In (Swing Door)	\$ 1,495	\$ 1,995	\$ 3,295	\$ 1,395
	36" French Door (BIR or Counter-Depth)	\$ 1,595	\$ 2,095	\$ 3,295	\$ 1,595
	Built-In Painted Top Grill	\$ 250	\$ 250	\$ 250	\$ 250
	18" Columns	\$ 1,095	\$ 1,595	\$ 2,895	\$ 1,195
	24" Columns	\$ 1,095	\$ 1,595	\$ 2,895	\$ 1,195
	30" Columns	\$ 1,395	\$ 1,995	\$ 3,295	\$ 1,195
	Columns Painted Toe Kick Grill	\$ 235	\$ 235	\$ 235	\$ 235

VENTILATION:	Product	Standard RAL Paint Paint Semi-Gloss (C)	Custom Finishes Matte & Textures (CF)	Custom Colors Custom Match (CC)	Plated Trim Kit (PLT)
	30" Models	\$ 1,195	\$ 2,195	\$ 3,695	\$ 295
	36" Models	\$ 1,195	\$ 2,195	\$ 3,695	\$ 395
	42" Models	\$ 1,495	\$ 2,595	\$ 3,995	\$ 395
	48" Models	\$ 1,495	\$ 2,595	\$ 3,995	\$ 395
	54" Models	\$ 1,495	\$ 2,595	\$ 3,995	\$ 395
	60" Models	\$ 1,495	\$ 2,595	\$ 3,995	\$ 395
	66" Models	\$ 1,495	\$ 2,595	\$ 3,995	\$ 395



318 June Avenue, Blandon, PA 19510  
(800) 449 - 8691