

# Valli.

handle creators 

2023 USA

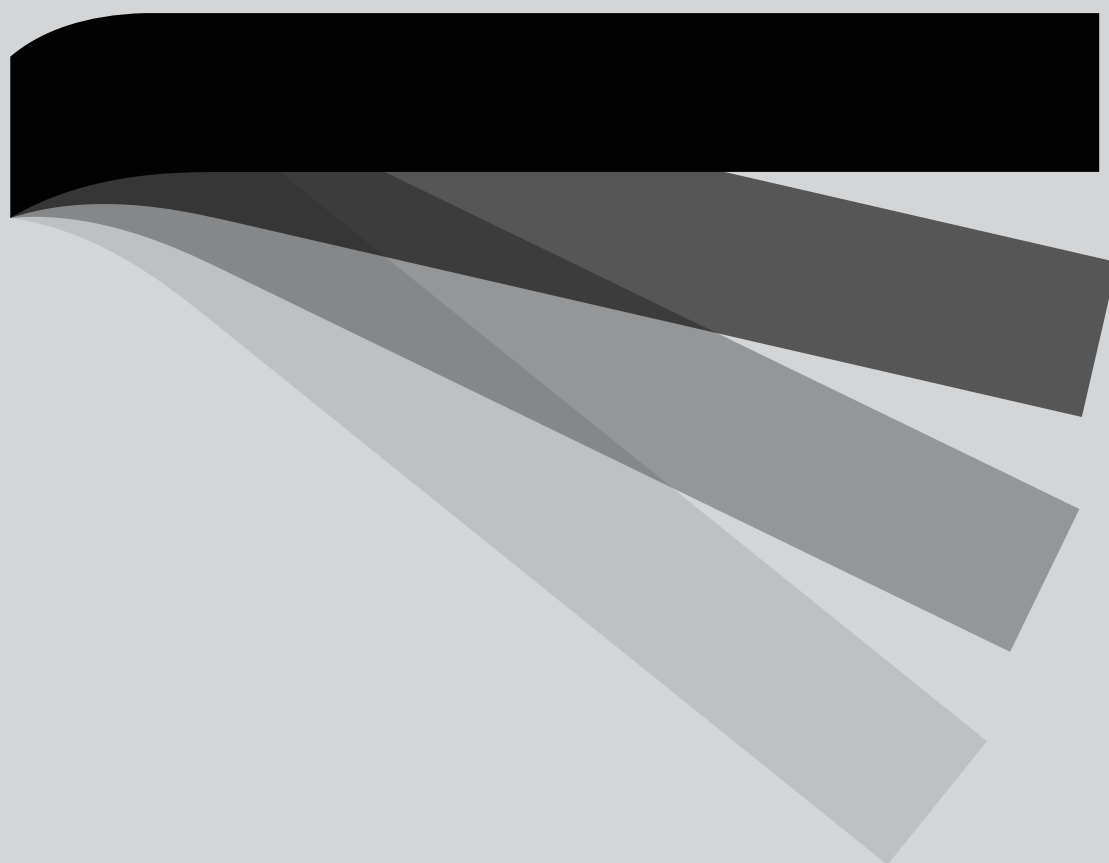

Price list



**Valli.**  
handle creators

USA Price list 2023



---

Finishes [p. 12](#)

PRESTO / Quick ship [p. 18](#)

Affordable luxury [p. 19](#)

4 You [p. 16](#)

---

Door levers [p. 20](#)

---

#### Door accessories

Door knobs [p. 106](#)

Door pulls [p. 120](#)

Entry handlesets [p. 136](#)

Pocket doors [p. 140](#)

Deadlock [p. 150](#)

Deadbolts [p. 152](#)

Privacy bolts [p. 154](#)

Escutcheon with deadbolts [p. 156](#)

Multipoint [p. 160](#)

Mortise locks [p. 168](#)

Coat hooks [p. 185](#)

Door stoppers [p. 184](#)

Miscellaneous parts [p. 186](#)

---

Door thicknesses [p. 200](#)

Certifications [p. 203](#)

General sales terms and conditions [p. 204](#)

# Fusital collection

**H 198** Eero Aarnio  
p. 28



**H 311** Mario Bellini  
p. 29



PRESTO

**H 315** Pierluigi Cerri  
p. 30



**H 317** Antonio Citterio  
p. 31



**H 327** Antonio Citterio  
p. 32



**H 329** Taller Design  
Ricardo Bofill  
p. 33



**H 330** Matteo Thun  
p. 34



**H 334** Foster + Partners  
p. 35



**H 335** Richard Meier  
p. 36



**H 338** Yoshimi Kono  
p. 37



**H 343** John Pawson  
p. 38



**H 348** David Chipperfield  
p. 39



**H 356** Zaha Hadid  
p. 40



**H 359** SOM - Skidmore,  
Owings & Merrill  
p. 41



**H 361** Antonio Citterio  
with Toan Nguyen  
p. 42



PRESTO

**H 364** Mario Bellini  
p. 43



**H 367** Giancarlo Vegni  
p. 44



**H 368** Cerri & Associati  
p. 45



**H 370** Doriana e  
Massimiliano Fuksas  
p. 46



**H 372** Eri Goshen  
p. 47



**H 376** Giancarlo Vegni  
p. 48



**H 377** Steve Leung  
p. 49



**H 378** Yabu Pushelberg  
p. 50



**H 379** Antonio Citterio  
p. 51



**H 380** Antonio Citterio  
p. 52



**H 381** Khalid Al Najjar  
p. 53



**H 382** Joe Cheng  
p. 54



**H 383** Perkins & Will  
p. 55



**H 384** CetraRuddy  
Architecture D.P.C.  
p. 56



**H 385** Federica Biasi  
p. 57



**H 386** Meneghello  
Paoelli  
p. 58



**H 1003** Matteo Thun  
p. 64



**H 1026** Antonio Bullo  
p. 69



**H 1039** Jean-Baptiste  
Sibertin Blanc  
p. 72



**H 1040** Gabriele e  
Oscar Buratti  
p. 73



**H 1043** Matteo Thun  
p. 74



AFFORDABLE LUXURY

**H 1044** Vincent  
Van Duysen  
p. 75



**H 1044 U** Vincent  
Van Duysen  
p. 76



**H 1045** Yoshimi Kono  
p. 77



PRESTO

**H 1052** Mikhail Leykin  
p. 81



**H 1060** SOM - Skidmore,  
Owings & Merrill  
p. 86



**H 1061** Di Virgilio  
Veneziano  
p. 87



AFFORDABLE LUXURY

PRESTO

H 1066 Bertone Design  
p. 89



H 1068 Pembroke  
& Ives  
p. 90



H 5008 Taller Design  
Ricardo Bofill  
p. 95



H 5014 Bernina  
p. 96



H 5015 Antonio Citterio  
H 5015 with leather  
p. 97-98



H 5017 Hans Kollhoff  
p. 99



## Lab collection

H 163 Sarissa  
p. 24



AFFORDABLE LUXURY

H 165 Germana  
p. 25



H 176 Spiga  
p. 26



H 192 Prunus  
p. 27



AFFORDABLE LUXURY

H 1004 Antares  
p. 65



AFFORDABLE LUXURY

H 1016 Nabucco  
p. 66



H 1022 Ernani  
p. 67



H 1024 Lolita  
p. 68



H 1027 Dafne  
p. 70



H 1037 Teseo  
p. 71



AFFORDABLE LUXURY

H 1046 Nais  
p. 78



PRESTO

H 1049 Divara  
p. 79



PRESTO

H 1050 Giasone  
p. 80



H 1054 W.W.  
p. 82



PRESTO

H 1056 Quadra  
p. 83



H 1057 Retrò  
p. 84



AFFORDABLE LUXURY

H 1058 Amica  
p. 85



AFFORDABLE LUXURY

H 1062 Carmen  
p. 88



H 1069 Susannah  
p. 91



H 1748 Estrella  
p. 92



PRESTO

H 411 Leila  
p. 59



AFFORDABLE LUXURY

PRESTO

H 414 Amber  
p. 60



AFFORDABLE LUXURY

H 415 Scarlet  
p. 61



AFFORDABLE LUXURY

H 416 Garnet  
p. 62



AFFORDABLE LUXURY

H 419 Bordeaux  
p. 63



AFFORDABLE LUXURY

H 4730 White  
p. 93



H 4742 Coral  
p. 94



## Door pulls Fusital collection

**K 352** Richard Meier  
p. 120



**K 353** Taller Design  
Ricardo Bofill  
p. 120



**K 356** John Pawson  
p. 121



**K 358** Cerri & Associati  
p. 121



**K 368** Antonio Citterio  
with Toan Nguyen  
p. 122



**K 377** Steve Leung  
p. 122



**K 378** Yabu Pushelberg  
p. 123



**K 379** Antonio Citterio  
p. 123



**K 380** Antonio Citterio  
p. 124



**K 381** Khalid Al Najjar  
p. 124



**K 383** Perkins&Will  
p. 125



**K 385** Federica Biasi  
p. 125



**K 386** Meneghello  
Paoletti  
p. 126



**K 1060** SOM - Skidmore,  
Owings & Merrill  
p. 127



**K 1061** Di Virgilio  
Veneziano  
p. 128



**K 1068** Pembroke  
& Ives  
p. 128



**K 1210** Eero Aarnio  
p. 130



**K 1226** Jean-Baptiste  
Sibertin Blanc  
p. 131



**K 1228** Yoshimi Kono  
p. 132



**P 5405** Taller Design  
Ricardo Bofill  
p. 133



**P 5406** Antonio Citterio  
p. 134



**P 5408** Antonio Citterio  
p. 135



## Door pulls Lab collection

**K 1054** W.W.  
p. 126



**K 1056** Quadra  
p. 127



**K 1069** Susannah  
p. 129



**K 1188**  
p. 129



**K 1219**  
p. 130



**K 1224**  
p. 131



**K 1231**  
p. 132



**K 1235**  
p. 133



## Door knobs Fusital collection

**K 377** Steve Leung  
p. 106



**K 378** Yabu Pushelberg  
p. 107



**K 383** Perkins&Will  
p. 108



**K 1060** SOM - Skidmore,  
Owings & Merrill  
p. 111



**K 1061** Di Virgilio  
Veneziano  
p. 112



## Door knobs Lab collection

**K 1054** W.W.  
p. 109



**K 1056** Quadra  
p. 110



**K 1155**  
p. 113



**K 1168** Giasone  
p. 114



**K 1170**  
p. 115



**K 1171**  
p. 116



**K 1730**  
p. 117



**K 5301**  
p. 118



## Handlesets

**K 1810** Entry Handleset  
p. 136



**K 1868** Entry Handleset  
p. 136



**K 1869** Entry Handleset  
p. 137



**K 1870** Entry Handleset  
p. 137



## Pocket doors Fusital collection

**K 1230 Privacy**  
Yoshimi Kono  
p. 146



**K 1232 Passage**  
Yoshimi Kono  
p. 146



**K 3012 Privacy**  
Antonio Citterio  
with Toan Nguyen  
p. 147



**K 3014 Privacy**  
Antonio Citterio  
with Toan Nguyen  
p. 147



## Pocket doors Lab collection

**K 1186 Dummy**  
p. 140



**K 1195 Dummy**  
p. 140



**K 1202 Passage**  
p. 141



**K 1203 Finger Pull**  
p. 141



**K 1204 Privacy**  
p. 142



**K 1206 Passage**  
p. 142



**K 1211 Privacy**  
p. 143



**K 1212 Passage**  
p. 143



**K 1215 Privacy**  
**K 1215 Privacy ADA**  
p. 144



**K 1215 Dummy**  
p. 144



**K 1215 Entry**  
p. 145



**K 1215 Passage**  
p. 145



**K 4200 Privacy**  
p. 148



**K 4202 Passage**  
p. 148



## Fusital collection grouped by architects name

H 1026	<b>Antonio Bullo</b>	p. 69	H 334	<b>Foster + Partners</b>	p. 35	H 315	<b>Pierluigi Cerri</b>	p. 30
H 380	<b>Antonio Citterio</b>	p. 52	H 1040	<b>Gabriele e Oscar Buratti</b>	p. 73	H 335	<b>Richard Meier</b>	p. 36
H 379	<b>Antonio Citterio</b>	p. 51	H 376	<b>Giancarlo Vegni</b>	p. 48	H 359	<b>SOM - Skidmore, Owings &amp; Merrill</b>	p. 41
H 327	<b>Antonio Citterio</b>	p. 32	H 367	<b>Giancarlo Vegni</b>	p. 44	H 1060	<b>SOM - Skidmore, Owings &amp; Merrill</b>	p. 86
H 317	<b>Antonio Citterio</b>	p. 31	H 5017	<b>Hans Kollhoff</b>	p. 99	H 377	<b>Steve Leung</b>	p. 49
H 5015	<b>Antonio Citterio</b>	p. 97	H 1039	<b>Jean-Baptiste Sibertin Blanc</b>	p. 72	H 329	<b>Taller Design Ricardo Bofill</b>	p. 33
H 5015 L	<b>Antonio Citterio</b>	p. 98	H 382	<b>Joe Cheng</b>	p. 54	H 5008	<b>Taller Design Ricardo Bofill</b>	p. 95
H 361	<b>Antonio Citterio with Toan Nguyen</b>	p. 41	H 343	<b>John Pawson</b>	p. 38	H 1044	<b>Vincent Van Duysen</b>	p. 75
H 5014	<b>Bernina</b>	p. 96	H 381	<b>Khalid Al Najjar</b>	p. 53	H 1044 U	<b>Vincent Van Duysen</b>	p. 76
H 1066	<b>Bertone Design</b>	p. 89	H 364	<b>Mario Bellini</b>	p. 43	H 378	<b>Yabu Pushelberg</b>	p. 50
H 368	<b>Cerri &amp; Associati</b>	p. 45	H 311	<b>Mario Bellini</b>	p. 29	H 338	<b>Yoshimi Kono</b>	p. 37
H 384	<b>CetraRuddy Architecture D.P.C.</b>	p. 56	H 1043	<b>Matteo Thun</b>	p. 74	H 1045	<b>Yoshimi Kono</b>	p. 77
H 348	<b>David Chipperfield</b>	p. 39	H 1003	<b>Matteo Thun</b>	p. 64	H 356	<b>Zaha Hadid</b>	p. 40
H 1061	<b>Di Virgilio Veneziano</b>	p. 87	H 330	<b>Matteo Thun</b>	p. 34			
H 370	<b>Doriana e Massimiliano Fuksas</b>	p. 46	<b>NEW</b> H 386	<b>Meneghello Paoletti</b>	p. 58			
H 198	<b>Eero Aarnio</b>	p. 28	H 1052	<b>Mikhail Leykin</b>	p. 81			
H 372	<b>Eri Goshen</b>	p. 47	H 1068	<b>Pembroke &amp; Ives</b>	p. 90			
<b>NEW</b> H 385	<b>Federica Biasi</b>	p. 57	H 383	<b>Perkins&amp;Will</b>	p. 55			

## Code and Group index

### Fusital collection

<b>H 198</b>	Group 1	p. 28	<b>H 348</b>	Group 5	p. 39	<b>H 378</b>	Group 6	p. 50	<b>H 1039</b>	Group 3	p. 72	<b>H 5008</b>	Group 7	p. 95
<b>H 311</b>	Group 6	p. 29	<b>H 356</b>	Group 8	p. 40	<b>H 379</b>	Group 8	p. 51	<b>H 1040</b>	Group 3	p. 73	<b>H 5014</b>	Group 6	p. 96
<b>H 315</b>	Group 5	p. 30	<b>H 359</b>	Group 6	p. 41	<b>H 380</b>	Group 8	p. 52	<b>H 1043</b>	Group 4	p. 74	<b>H 5015</b>	Group 8	p. 97
<b>H 317</b>	Group 5	p. 31	<b>H 361</b>	Group 5	p. 42	<b>H 381</b>	Group 5	p. 53	<b>H 1044</b>	Group 4	p. 75	<b>H 5015 L</b>	Group 9	p. 98
<b>H 327</b>	Group 5	p. 32	<b>H 364</b>	Group 5	p. 43	<b>H 382</b>	Group 5	p. 54	<b>H 1044 U</b>	Group 2	p. 76	<b>H 5017</b>	Group 8	p. 99
<b>H 329</b>	Group 6	p. 33	<b>H 367</b>	Group 5	p. 44	<b>H 383</b>	Group 5	p. 55	<b>H 1045</b>	Group 2	p. 77			
<b>H 330</b>	Group 5	p. 34	<b>H 368</b>	Group 5	p. 45	<b>H 384</b>	Group 6	p. 56	<b>H 1052</b>	Group 2	p. 81			
<b>H 334</b>	Group 5	p. 35	<b>H 370</b>	Group 5	p. 46	<b>H 385</b>	Group 5	p. 57	<b>H 1060</b>	Group 3	p. 86			
<b>H 335</b>	Group 6	p. 36	<b>H 372</b>	Group 5	p. 47	<b>H 386</b>	Group 5	p. 58	<b>H 1061</b>	Group 2	p. 87			
<b>H 338</b>	Group 5	p. 37	<b>H 376</b>	Group 6	p. 48	<b>H 1003</b>	Group 1	p. 64	<b>H 1066</b>	Group 2	p. 89			
<b>H 343</b>	Group 6	p. 38	<b>H 377</b>	Group 7	p. 49	<b>H 1026</b>	Group 2	p. 69	<b>H 1068</b>	Group 3	p. 90			

## Lab collection in alphabetical order

H 414	<b>Amber</b>	p. 60
H 1058	<b>Amica</b>	p. 85
H 1004	<b>Antares</b>	p. 65
H 419	<b>Bordeaux</b>	p. 63
H 1062	<b>Carmen</b>	p. 88
H 4742	<b>Coral</b>	p. 94
H 1748	<b>Estrella</b>	p. 92
H 1027	<b>Dafne</b>	p. 70
H 1049	<b>Divara</b>	p. 79

H 1022	<b>Ernani</b>	p. 67
H 416	<b>Garnet</b>	p. 62
H 165	<b>Germana</b>	p. 25
H 1050	<b>Giasone</b>	p. 80
<b>NEW</b> H 411	<b>Leila</b>	p. 59
H 1024	<b>Lolita</b>	p. 68
H 1016	<b>Nabucco</b>	p. 66
H 1046	<b>Nais</b>	p. 78
H 192	<b>Prunus</b>	p. 27

H 1056	<b>Quadra</b>	p. 83
H 1057	<b>Retrò</b>	p. 84
H 163	<b>Sarissa</b>	p. 24
H 415	<b>Scarlet</b>	p. 61
H 176	<b>Spiga</b>	p. 26
<b>NEW</b> H 1069	<b>Susannah</b>	p. 91
H 1037	<b>Teseo</b>	p. 71
H 4730	<b>White</b>	p. 93
H 1054	<b>W.W.</b>	p. 82

### PRESTO

H 311	<b>Mario Bellini</b>	p. 29
H 361	<b>Antonio Citterio with Toan Nguyen</b>	p. 41
H 1044	<b>Vincent Van Duysen</b>	p. 75

H 1045	<b>Yoshimi Kono</b>	p. 77
H 1046	<b>Nais</b>	p. 78
H 1049	<b>Divara</b>	p. 79

H 1054	<b>W.W.</b>	p. 82
H 1748	<b>Estrella</b>	p. 92
H 411	<b>Leila</b>	p. 59

### AFFORDABLE LUXURY

H 1043	<b>Matteo Thun</b>	p. 74
H 1044	<b>Vincent Van Duysen</b>	p. 75
H 163	<b>Sarissa</b>	p. 24
H 192	<b>Prunus</b>	p. 27

H 1004	<b>Antares</b>	p. 65
H 1037	<b>Teseo</b>	p. 71
H 1058	<b>Amica</b>	p. 85
H 411	<b>Leila</b>	p. 59

H 414	<b>Amber</b>	p. 60
H 415	<b>Scarlet</b>	p. 61
H 416	<b>Garnet</b>	p. 62
H 419	<b>Bordeaux</b>	p. 63

## Code and Group index

### Lab collection

<b>H 163</b>	Group 4	p. 24
<b>H 165</b>	Group 2	p. 25
<b>H 176</b>	Group 2	p. 26
<b>H 192</b>	Group 4	p. 27
<b>H 411</b>	Group 4	p. 59
<b>H 414</b>	Group 4	p. 60
<b>H 415</b>	Group 4	p. 61
<b>H 416</b>	Group 4	p. 62
<b>H 419</b>	Group 4	p. 63
<b>H 1004</b>	Group 4	p. 65
<b>H 1016</b>	Group 2	p. 66

<b>H 1022</b>	Group 1	p. 67
<b>H 1024</b>	Group 1	p. 68
<b>H 1027</b>	Group 2	p. 70
<b>H 1037</b>	Group 4	p. 71
<b>H 1046</b>	Group 2	p. 78
<b>H 1049</b>	Group 2	p. 79
<b>H 1050</b>	Group 1	p. 80
<b>H 1054</b>	Group 2	p. 82
<b>H 1056</b>	Group 2	p. 83
<b>H 1057</b>	Group 2	p. 84
<b>H 1058</b>	Group 4	p. 85

<b>H 1062</b>	Group 2	p. 88
<b>H 1069</b>	Group 3	p. 91
<b>H 1748</b>	Group 3	p. 92
<b>H 4730</b>	Group 1	p. 93
<b>H 4742</b>	Group 1	p. 94

# Finishes



**32 Polished stainless steel**  
N1



**32D Satin stainless steel**  
N2



**03 Polished brass**  
A



**03D Satin brass**  
AB



**Unlaquered brass**  
B



**Antique natural brass**  
BA



**06B Brunito**  
(Dark brown - hand made)  
BC



**06A Anticato**  
(Antique brass)  
BD



**26D Satin chrome**  
CA



**14 Polished nickel**  
D



**15 Satin nickel**  
DA



**18 Satin black nickel**  
DC



**06M Matt bronze**  
EA



**56 Dark bronze**  
ED



**16 Dull black**  
F



**22M Matt white**  
FB



**17A Polished black nickel**  
L



Anti-microbial  
finish applicable



Available also  
in PVD finish

# Finishes of matching components



**03M Matt brass**  
AC

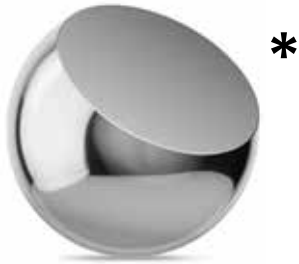

**26 Polished chrome**  
C



**10S Satin bronze**  
E

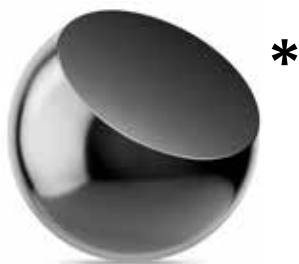

**55 Titanium PVD**  
H

Levers and knobs		Corresponding face and strike	
26	Polished chrome	26	Polished chrome
26D	Satin chrome	26D	Satin chrome
03	Polished brass	03	Polished brass
03D	Satin brass	03D	Satin brass
03D-PVD	Satin brass PVD	03D	Satin brass
03M	Matt brass	03D	Satin brass
06B	Brunito (Dark brown)	06B	Brunito
06A	Anticato (Antique brass)	06	Antique brass
26-PVD	Polished chrome PVD	26	Polished chrome
26D-PVD	Satin chrome PVD	26D	Satin chrome
17A	Polished black nickel	14	Polished nickel
18	Satin black nickel	15	Satin nickel
32D	Satin stainless steel	15	Satin nickel
14	Nickel	14	Polished nickel
15	Satin nickel	15	Satin nickel
10S-PVD	Satin bronze PVD	06B	Brunito
10S	Satin bronze	06B	Brunito
06M	Matt bronze	06B	Brunito
56	Dark bronze	06B	Brunito
32	Polished stainless steel	14	Polished nickel
16	Dull black	16	Dull black
22M	Matt white	22M	Matt white
55-PVD	Titanium PVD	15	Satin nickel
B	Unlaquered brass	03	Polished brass
BA	Antique natural brass	03D	Satin brass
BB	Antique brass	06	Antique brass

BioCote® is an International approved technology that drastically reduces bacteria on the levers by up to 99.5% and the proliferation of microbes by up to 99.9%. PVD finishes may have slight tone differences compared to the corresponding traditional finishes.

# Finishes matrix

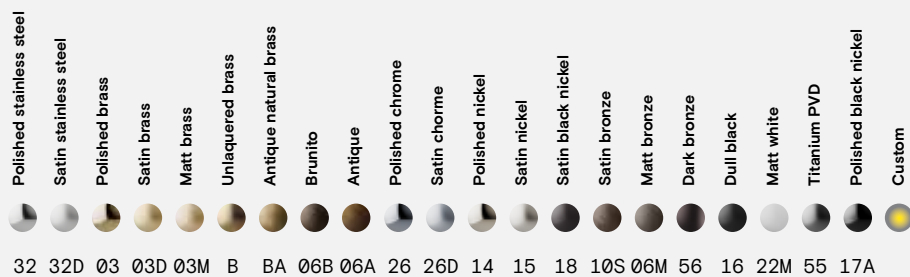

		32	32D	03	03D	03M	B	BA	06B	06A	26	26D	14	15	18	10S	06M	56	16	22M	55	17A	!
H 163	Sarissa										•	•											•
H 165	Germana			•	•					•													•
H 176	Spiga			•					•														•
H 192	Prunus																						•
H 198	Eero Aarnio			•						•		•											•
H 311	Mario Bellini										•	•	•	•									•
H 315	Pierluigi Cerri			•							•												•
H 317	Antonio Citterio										•	•											•
H 327	Antonio Citterio			•							•	•											•
H 329	Taller Design Ricardo Bofill										•								•				•
H 330	Matteo Thun											•					•						•
H 334	Foster + Partners			•								•											•
H 335	Richard Meier										•	•											•
H 338	Yoshimi Kono											•								•			•
H 343	John Pawson										•	•	•	•									•
H 348	David Chipperfield										•	•	•	•									•
H 356	Zaha Hadid										•	•											•
H 359	SOM - Skidmore, Owings & Merrill										•	•	•	•			•						•
H 361	Antonio Citterio with Toan Nguyen										•	•	•	•									•
H 364	Mario Bellini										•	•		•									•
H 367	Giancarlo Vegni										•	•											•
H 368	Cerri & Associati										•	•											•
H 370	Doriana e Massimiliano Fuksas										•	•											•
H 372	Eri Goshen										•	•										•	•
H 376	Giancarlo Vegni										•	•											•
H 377	Steve Leung					•												•	•				•
H 378	Yabu Pushelberg										•	•										•	•
H 379	Antonio Citterio					•						•					•						•
H 380	Antonio Citterio											•	•					•					•
H 381	Khalid Al Najjar					•						•		•								•	•
H 382	Joe Cheng							•			•		•										•
H 383	Perkins&Will											•		•				•	•				•
H 384	CetraRuddy Architecture D.P.C.										•	•						•				•	•
H 385	Federica Biasi										•	•		•					•				•
H 386	Meneghello Paoletti										•	•		•								•	•
H 411	Leila										•	•							•				•
H 414	Amber		•																				•
H 415	Scarlet		•																				•

32 32D 03 03D 03M B BA 06B 06A 26 26D 14 15 18 10S 06M 56 16 22M 55 17A !

Available in PVD finish			•	•							•	•				•	•	•					
Anti-microbial finish			•	•	•		•	•	•			•	•	•	•	•	•	•	•	•	•	•	•

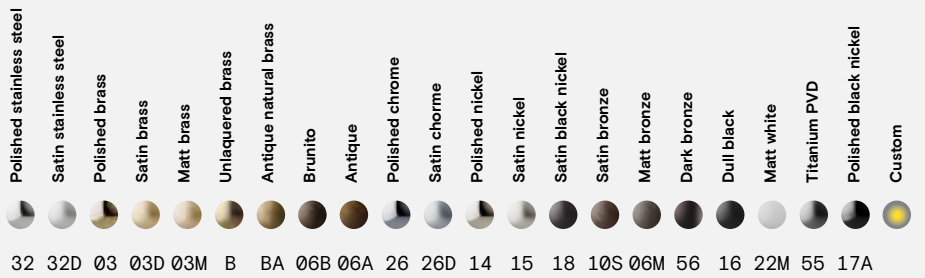

		32	32D	03	03D	03M	B	BA	06B	06A	26	26D	14	15	18	10S	06M	56	16	22M	55	17A	!	
H 416	Garnet		•																					•
H 419	Bordeaux		•																					•
H 1003	Matteo Thun			•				•			•		•	•										•
H 1004	Antares				•				•															•
H 1016	Nabucco										•					•								•
H 1022	Ernani		•									•												•
H 1024	Lolita		•								•	•												•
H 1026	Antonio Bullo		•								•													•
H 1027	Dafne		•									•												•
H 1037	Teseo		•										•	•										•
H 1039	Jean-Baptiste Sibertin Blanc										•		•	•										•
H 1040	Gabriele e Oscar Buratti										•					•								•
H 1043	Matteo Thun										•					•								•
H 1044	Vincent Van Duysen										•	•	•	•					•					•
H 1044 U	Vincent Van Duysen										•					•			•					•
H 1045	Yoshimi Kono										•	•	•	•					•					•
H 1046	Nais										•	•				•			•					•
H 1049	Divara										•	•							•				•	•
H 1050	Giasone										•	•												•
H 1052	Mikhail Leykin										•	•				•		•						•
H 1054	W.W.					•					•	•				•			•					•
H 1056	Quadra										•	•												•
H 1057	Retrò		•								•													•
H 1058	Amica										•								•		•			•
H 1060	SOM - Skidmore, Owings & Merrill										•	•							•					•
H 1061	Di Virgilio Veneziano			•												•							•	•
H 1062	Carmen											•				•		•	•					•
H 1066	Bertone Design					•					•													•
H 1068	Pembroke & Ives		•								•					•			•					•
H 1069	Susannah										•	•				•								•
H 1748	Estrella							•			•	•	•	•										•
H 4730	White										•													•
H 4742	Coral		•								•													•
H 5008	Taller Design Ricardo Bofill		•									•												•
H 5014	Bernina	•	•																					•
H 5015	Antonio Citterio	•	•																					•
H 5015 L	Antonio Citterio	•	•																					•
H 5017	Hans Kollhoff	•	•																					•

32 32D 03 03D 03M B BA 06B 06A 26 26D 14 15 18 10S 06M 56 16 22M 55 17A !

Available in PVD finish			•	•							•	•				•	•	•						
Anti-microbial finish			•	•	•			•	•	•			•	•	•	•	•	•	•	•	•	•	•	

## 4 you

The artisanal expertise of Valli allows to create unique and personal pieces.



H 377  
Titanium



H 377  
Titanium + brown braided leather



H 377  
Titanium + knurling



H 377  
Titanium + dark leather



H 377  
Titanium + marble

### Customization options

Any lever in this catalog can be customized to customers' request and it will be especially manufactured 4 You.

#### Rosette

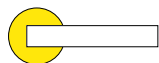

round

square

traditional

slim

regular

13/64"

13/32"

13/64"

13/32"

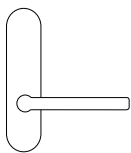

oval

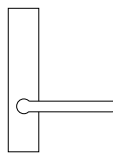

rectangular

#### Finish

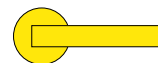

Over 20 standard finishes to choose from. PVD and anti-microbial treatments available. Third party finish matching available.

#### Special materials

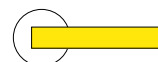

Additional insert to be used. See option at page 12.

#### Texture and shapes

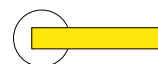

Grip available in different textures.

# Upcharges

## Standard configurations

The configuration on each catalog page is considered Standard.

Tubular latches standard backsets: 2.3/4" and 2.3/8".

Mortise lock standard backsets: 2.3/4" and 2.1/2".

Standard door thickness: 1.3/4".

The tubular sets are supplied with T-strikes.

If the requested configuration is not included, it might be produced upon special request and upcharges.

All customizations need to be approved by R&D Department in Italy.

1	Keying charges	KA – keyed alike (5 pins) – <b>NO CHARGE</b> (KA is not available on Multi-Point cylinders).
2	Drop ship charges	<b>\$ 5.00 NET</b> applies to drop ship orders
3	Rush delivery charges	<b>\$ 30.00 NET</b> applies to all orders requested to be shipped within 48 hours
4	Finishes	<i>Split finishes: + \$ 20.00 NET</i> to the highest priced finish indicated. <i>Non-standard finishes:</i> <b>+ \$ 100.00 NET</b> to the highest priced finish for levers, deadbolts, privacy bolts, pulls, multi point and pocket door trims <b>+ \$ 50.00 NET</b> to the highest priced finish for single dummies and deadlocks <i>Anti-microbial finishes (BIOCOTE details at page 14):</i> <b>+ \$ 150.00 NET</b> to the highest priced finish for levers, deadbolts, privacy bolts, pulls, multi point and pocket door trims <b>+ \$ 70.00 NET</b> to the highest priced finish for single dummies and deadlocks
5	Backset	<i>Narrow mortise lock backset (&lt; 2.1/2"):</i> <b>+ \$ 250.00 LIST</b> to the price of the standard sets Special backset request: call for details and pricing
6	Upside down mortise lock	<b>+ \$ 100.00 LIST</b> to the price of the standard mortise lock sets
7	Magnetic locks	<i>Tubular latches:</i> <b>+ \$ 30.00 LIST</b> to the price of the standard sets <i>American mortise locks:</i> <b>+ \$ 200.00 LIST</b> for no thumb–turn functions <b>+ \$ 250.00 LIST</b> for thumb–turn functions
8	Door thickness	<i>Tubular latches and bolts:</i> 2.1/4" Thick door: <b>+ \$ 50.00 LIST</b> 2.1/2" Thick door: <b>+ \$ 70.00 LIST</b> 3" Thick door: <b>+ \$ 90.00 LIST</b> <i>Mortise lock and multi-point (Multi-point only accommodates up to 2.1/4" thick door):</i> 2.1/4" Thick door: <b>+ \$ 70.00 LIST</b> 2.1/2" Thick door: <b>+ \$ 90.00 LIST</b> 3" Thick door: <b>+ \$ 120.00 LIST</b> > 3" Thick door: <b>+ \$150.00 LIST</b>
9	Non standard rosettes	<i>Single Dummy</i> Non-listed RQ and RQS (square rosette): <b>+ \$ 55.00 LIST</b> to the RP/RPS price <i>Full set</i> Non listed RQ and RQS (square rosette): <b>+ \$ 110.00 LIST</b> to the RP/RPS price <b>RS</b> = Small European rosettes – Same price as standard American rosettes <b>RS/Round</b> rosettes (45mm, 50mm, 55mm) – Same price as RP <b>RSQ/Square</b> rosettes (45mm, 50mm, 55mm) – Same price as RQ Privacy function on small rosette = Requires the purchase of a Passage set and an additional Privacy Bolt <b>RSB</b> = Slim rosettes – full pricing at pages 102-103. <b>RE</b> = Rectangular rosettes (for tubular latches only) + \$ 30.00 LIST to the RQ prices
10	Non standard plates and thumb pieces	Narrow plates <b>NEP, NES, NER</b> and <b>NERS</b> = Same price as standard plates EP, EPS, ER, ERS Thumb piece change on ER/Rectangular plate and EP/Oval plate (ex. use of the K1225): <b>+ \$ 100.00 LIST</b>
11	Dummy set adaptor (For 2.1/8" Pre-drilled doors only)	XO03/1 back to back application: <b>+ \$ 75.00 LIST</b> to DMY price XO03/2 single application: <b>+ \$ 90.00 LIST</b> to DMY price
12	Strike plates	ASA Strike plates: <b>+ \$ 60.00 LIST</b> Custom strike plates available upon request. Call for pricing.

## PRESTO / Quick ship

Valli has selected some of the most popular levers in its collection to be **continuously in stock** for quick shipment.

These levers are recognized throughout the catalog by the PRESTO writing indicated on corresponding page.

The levers of the PRESTO Collection are meant to ship **within 3-5 business days** from the order confirmation. Contact our customer service for more information.

The PRESTO items are available under the following conditions:

- Maximum 10 sets per order. Contact our customer service for any request higher than this quantity.
- Available functions: Tubular passage, privacy and dummy (mix of different functions per order).  
Entry mortise lock 2.3/4" backset.
- Presto stock is available in the following standard finishes only: 14, 15, 26 & 26D and 32D (as indicated per lever page).

## Fusital

H 311 Mario Bellini  
p. 29



H 361 Antonio Citterio  
with Toan Nguyen  
p. 42



H 1044 Vincent  
Van Duysen  
p. 75



H 1045 Yoshimi Kono  
p. 77



## Lab

H 1046 Nais  
p. 78



H 1049 Divara  
p. 79



H 1054 W.W.  
p. 82



H 1748 Estrella  
p. 92



H 411 Leila  
p. 59



The Affordable Luxury collection groups our high quality products with unbeatable prices, within \$250 LIST price for a passage lever on a round rosette.

No compromise on quality. The levers in this range have the standard high quality materials and mechanisms used in every other product, but with a more affordable price tag!

## Fusital

H 1043 Matteo Thun  
p. 74



H 1044 Vincent  
Van Duysen  
p. 75



## Lab

H 163 Sarissa  
p. 24



H 192 Prunus  
p. 27



H 1004 Antares  
p. 65



H 1037 Teseo  
p. 71



H 1058 Amica  
p. 85



H 411 Leila  
p. 59



H 414 Amber  
p. 60



H 415 Scarlet  
p. 61



H 416 Garnet  
p. 62



H 419 Bordeaux  
p. 63



# Door levers





# How to specify

<b>1 Lever/knob model</b>	Choose from our collection of levers / knobs (ex. H 1062 or K 377).
<b>2 Trim option</b>	Choose among the options at page 23.
<b>3 Function</b>	PGE Passage PCY Privacy DMY Dummy ML-XXX Mortise lock (Different functions available. Check details at page 168) 101 Deadbolt single cylinder 102 Deadbolt double cylinder 105 Privacy bolt
<b>4 Handing</b>	<p>RH, LH, RHR or LHR. The hand of the door is always determined from the outside. Follow the diagram below.</p> <p>The diagram illustrates four door handing configurations. In the top-left, 'LH LEFT HAND' shows the lever on the outside and the handle on the inside. In the top-right, 'RH RIGHT HAND' shows the lever on the outside and the handle on the inside. In the bottom-left, 'LHR LEFT HAND REVERSE BEVEL' shows the lever on the outside and the handle on the inside. In the bottom-right, 'RHR RIGHT HAND REVERSE BEVEL' shows the lever on the outside and the handle on the inside. Labels 'INSIDE' and 'OUTSIDE' indicate the respective sides of the door.</p>
<b>5 Finish</b>	Standard finishes are indicated on each lever page. Special finishes are available upon request for an upcharge. Choose one of the finishes at pages 12-13.
<b>6 Backset</b>	Choose between these standard options: 2.3/8" or 2.3/4" for tubular application 2.1/2" or 2.3/4" for mortise application
<b>7 Door thickness</b>	To be specified. 1.3/4" is considered standard. Up to 3" thick door available (Upcharges apply).
<b>8 Miscellaneous</b>	Note any special keying information, or special instruction.

Examples	1	2	3	4	5	6	7	8
<b>Tubular set</b>	H 1068	RP	PCY	RH	26	2.3/8"	1.3/4"	Full lip strike
<b>Mortise lock</b>	H 1066	RS50	ML-F	LHR	16	2.3/4"	2.1/4"	KA Cylinders
<b>Deadbolt/Privacy bolt</b>	105	RQ	-	-	26D	2.3/4"	1.3/4"	Less exterior
<b>Multipoint</b>	See specification details at page 160.							

# Trim options

Any lever/knob in the catalog can be matched with any type of rosette and escutcheon plates. Choose from the options below:

## Configurations for Pre – drilled doors (2.1/8" BORE)

### Rosettes

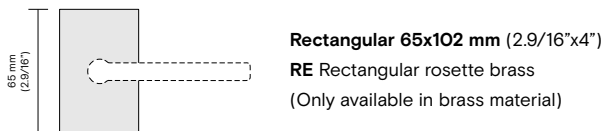
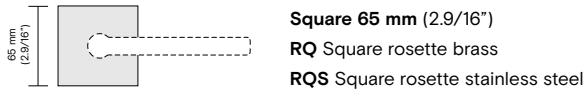
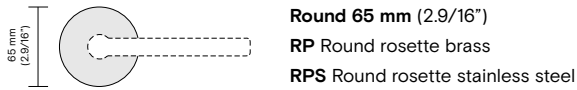

### Escutcheon – Plates

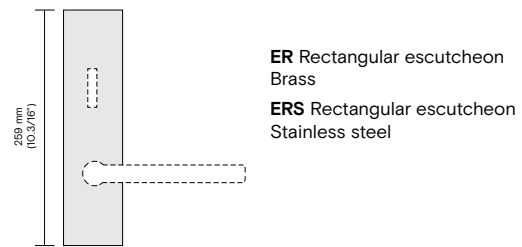
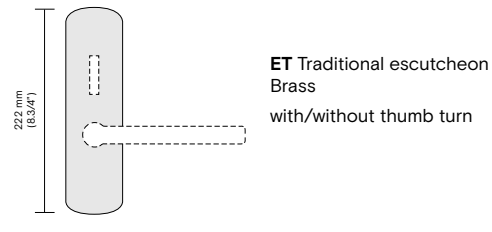
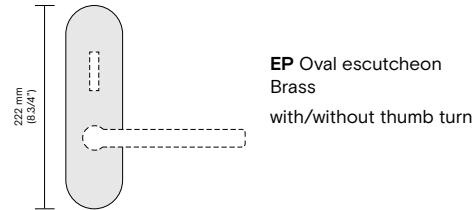

## Configurations for Non pre – drilled doors

### Rosettes

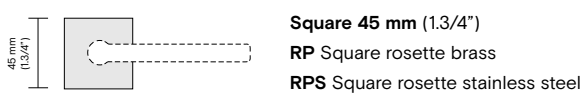
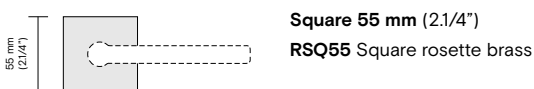
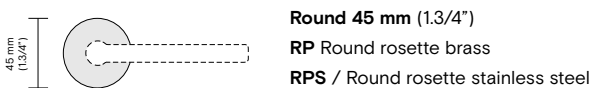
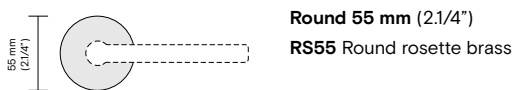

### Escutcheons – Narrow plates

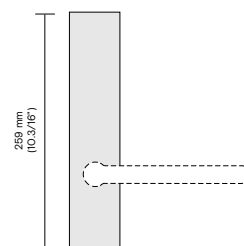
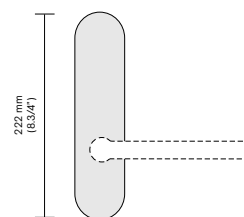
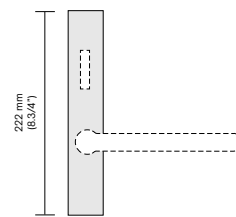
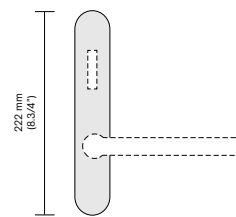



# H 163

## Sarissa

Material	Collection	Group
Brass	Lab	4

Standard option (mm/inches)

**RP Round rosette**

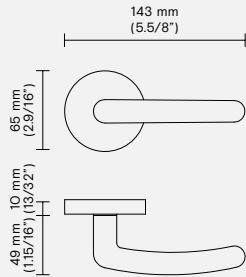

Standard option (mm/inches)

**RQ Square rosette**

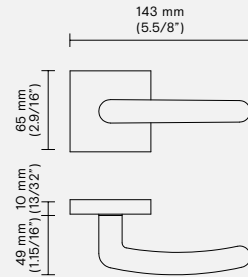

Escutcheon options (mm/inches)

**EP Oval plate**

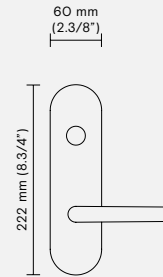

**ER Rectangular plate**

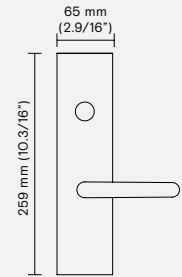

Slim rosette available - See pages 102-103

Conversions from metric to U.S. measurements are approximate.

**Retail price**

Finish	Rosette	Function PGE	PCY	DMY R/L Single	ML-F Entry
26 Polished chrome	RP Round	\$ 223.00	\$ 226.00	\$ 113.00	\$ 924.00
	RQ Square	\$ 321.00	\$ 323.00	\$ 172.00	\$ 1,062.00
26D Satin chrome	RP Round	\$ 223.00	\$ 226.00	\$ 113.00	\$ 924.00
	RQ Square	\$ 321.00	\$ 323.00	\$ 172.00	\$ 1,062.00

**Retail price**

Finish	Escutcheon	Function PGE	PCY	DMY R/L Single	DMY R/L Pair	ML-F Entry
26 Polished chrome	EP Oval	\$ 481.00	\$ 494.00	\$ 254.00	\$ 430.00	\$ 859.00
	ER Rectangular	\$ 558.00	\$ 570.00	\$ 267.00	\$ 481.00	\$ 899.00
26D Satin chrome	EP Oval	\$ 481.00	\$ 494.00	\$ 254.00	\$ 430.00	\$ 859.00
	ER Rectangular	\$ 558.00	\$ 570.00	\$ 267.00	\$ 481.00	\$ 899.00

The options listed above are considered standard. Non-standard options are available upon request.

For more options on Rosettes and Escutcheon plates see page 23. For more options on Finishes see pages 12-13.

RE = Rectangular rosettes available for tubular latch application only. Add + \$ 30.00 LIST to the price of the RQ

**Upcharges apply for the following special options:**

- Extra thick door (> 2")
- Non-standard rosettes (rosettes not listed above)
- Non-standard finishes (finishes not listed above)
- Split finishes

See page 17 for pricing. Exclusions may apply.

**Matching elements**

- Pg 168 Mortise lock functions
- Pg 152 Deadbolts
- Pg 154 Privacy Bolts
- Pg 156 Escutcheons with deadbolts
- Pg 160 Multi-Point Trim functions

Window lever available in the same design. Call for pricing.



# H 165 Germana

Material  
Brass

Collection  
Lab

Group  
2

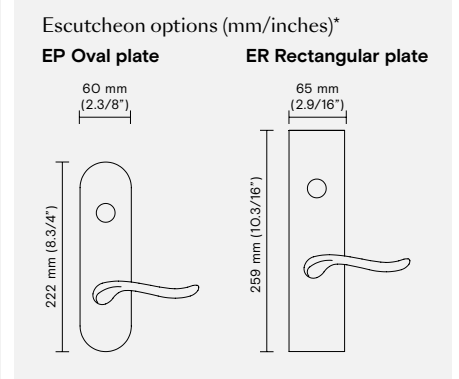
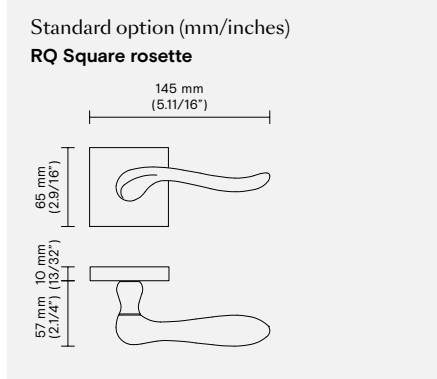
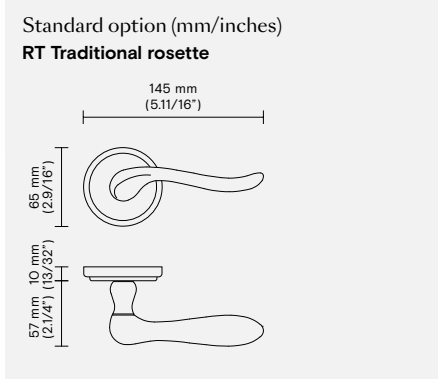

Conversions from metric to U.S. measurements are approximate.

\*Only available on request

## Retail price

Finish	Rosette	Function PGE	PCY	DMY R/L Single	ML-F Entry
<b>O3</b> Polished brass	<b>RT</b> Traditional	\$ 368.00	\$ 389.00	\$ 170.00	\$ 1,037.00
	<b>RQ</b> Square	\$ 486.00	\$ 508.00	\$ 229.00	\$ 1,176.00
<b>O3D</b> Satin brass	<b>RT</b> Traditional	\$ 368.00	\$ 389.00	\$ 170.00	\$ 1,037.00
	<b>RQ</b> Square	\$ 486.00	\$ 508.00	\$ 229.00	\$ 1,176.00
<b>O6A</b> Anticato	<b>RT</b> Traditional	\$ 384.00	\$ 401.00	\$ 180.00	\$ 1,037.00
	<b>RQ</b> Square	\$ 503.00	\$ 520.00	\$ 239.00	\$ 1,176.00

**Note:** This lever is also available with RP Round Rosette. Same price as RT Traditional Rosette.

The options listed above are considered standard.  
Non-standard options are available upon request.

For more options on Rosettes and Escutcheon plates see page 23.  
For more options on Finishes see pages 12-13.

RE = Rectangular rosettes available for tubular latch application only.  
Add + \$ 30.00 LIST to the price of the RQ.  
For slim rosette and European version see pages 100-103.

Upcharges apply for the following special options:

- Extra thick door (> 2")
- Non-standard rosettes (rosettes not listed above)
- Non-standard finishes (finishes not listed above)
- Split finishes

See page 17 for pricing. Exclusions may apply.

## Matching elements

- Pg 168 Mortise lock functions
- Pg 152 Deadbolts
- Pg 154 Privacy Bolts
- Pg 156 Escutcheons with deadbolts
- Pg 160 Multi-Point Trim functions

European window lever style available in the same design.  
Call for pricing.



# H 176 Spiga

Material	Collection	Group
Brass + Porcelain	Lab	2

Standard option (mm/inches)  
**RT Traditional rosette**

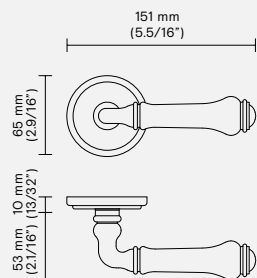

Standard option (mm/inches)  
**RQ Square rosette**

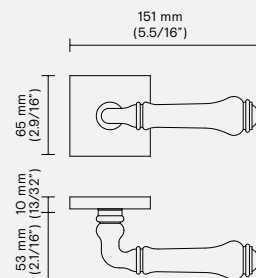

Escutcheon options (mm/inches)\*

**EP Oval plate**

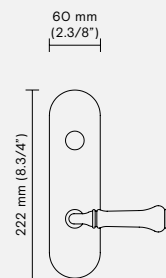

**ER Rectangular plate**

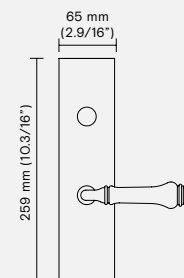

Conversions from metric to U.S. measurements are approximate.

\*Only available on request

### Retail price

Finish	Rosette	Function PGE	PCY	DMY R/L Single	ML-F Entry
<b>03/White</b> Polished brass / White	RT Traditional	\$ 436.00	\$ 459.00	\$ 207.00	\$ 1,037.00
	RQ Square	\$ 555.00	\$ 578.00	\$ 266.00	\$ 1,176.00
<b>06B/Ivory</b> Brunito / Ivory	RT Traditional	\$ 453.00	\$ 459.00	\$ 215.00	\$ 1,037.00
	RQ Square	\$ 572.00	\$ 602.00	\$ 275.00	\$ 1,176.00

**Note:** The insert is made of porcelain, not suitable for commercial use.  
This lever is also available with RP Round Rosette. Same price as RT Traditional Rosette.

The options listed above are considered standard.  
Non-standard options are available upon request.

For more options on Rosettes and Escutcheon plates see page 23.  
For more options on Finishes see pages 12-13.

RE = Rectangular rosettes available for tubular latch application only.  
Add + \$ 30.00 LIST to the price of the RQ.  
For slim rosette and European version see pages 100-103.

**Upcharges apply for the following special options:**

- Extra thick door (> 2")
- Non-standard rosettes (rosettes not listed above)
- Non-standard finishes (finishes not listed above)
- Split finishes

See page 17 for pricing. Exclusions may apply.

**Matching elements**

- Pg 168 Mortise lock functions
- Pg 152 Deadbolts
- Pg 154 Privacy Bolts
- Pg 156 Escutcheons with deadbolts
- Pg 160 Multi-Point Trim functions

European window lever style available in the same design.  
Call for pricing.



# H 192 Prunus

Material  
Brass

Collection  
Lab

Group  
4

### Standard option (mm/inches)

#### RP Round rosette

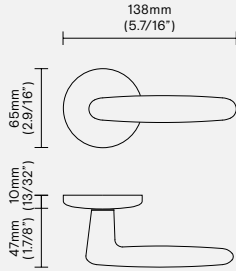

### Standard option (mm/inches)

#### RQ Square rosette

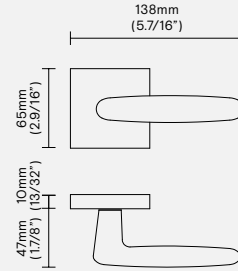

### Escutcheon options (mm/inches)

#### EP Oval plate

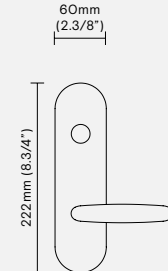

#### ER Rectangular plate

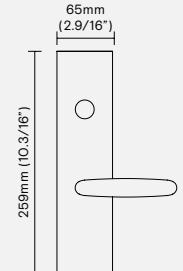

Slim rosette available - See pages 102-103

\*Only available on request  
Conversions from metric to U.S. measurements are approximate.

### Retail price

Finish	Rosette	Function PGE	PCY	DMY R/L Single	ML-F Entry
15 Satin nickel	RP Round	\$ 223.00	\$ 226.00	\$ 113.00	\$ 924.00
	RQ Square	\$ 321.00	\$ 323.00	\$ 172.00	\$ 1,062.00

The options listed above are considered standard.  
Non-standard options are available upon request.

For more options on Rosettes and Escutcheon plates see page 23.  
For more options on Finishes see pages 12-13.

RE = Rectangular rosettes available for tubular latch application only.  
Add + \$ 30.00 LIST to the price of the RQ

#### Upcharges apply for the following special options:

- Extra thick door (> 2")
- Non-standard rosettes (rosettes not listed above)
- Non-standard finishes (finishes not listed above)
- Split finishes

See page 17 for pricing. Exclusions may apply.

#### Matching elements

- Pg 168 Mortise lock functions
- Pg 152 Deadbolts
- Pg 154 Privacy Bolts
- Pg 156 Escutcheons with deadbolts
- Pg 160 Multi-Point Trim functions

Window lever available in the same design, Call for pricing.



# H 198

## Eero Aarnio

Material	Collection	Group
Brass	Fusital	1

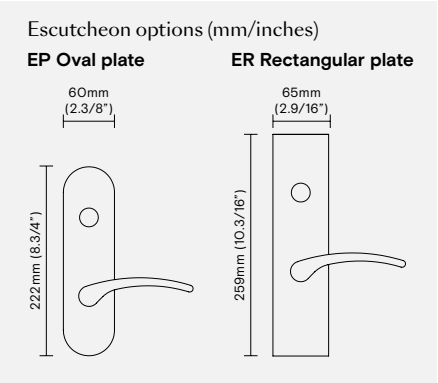
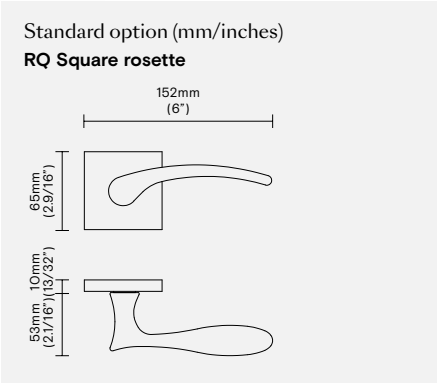
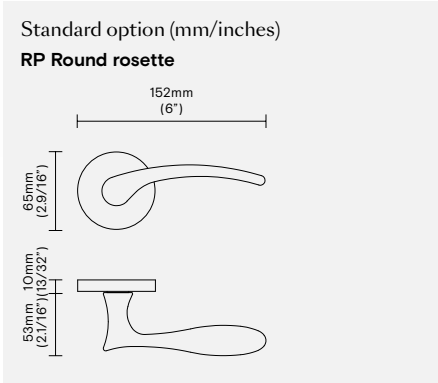

**Slim rosette** available - See pages 102-103

Conversions from metric to U.S. measurements are approximate.

**Retail price**

Finish	Rosette	Function PGE	PCY	DMY R/L Single	ML-F Entry
<b>03</b> Polished brass	<b>RP</b> Round	\$ 336.00	\$ 361.00	\$ 157.00	\$ 961.00
	<b>RQ</b> Square	\$ 455.00	\$ 480.00	\$ 216.00	\$ 1,100.00
<b>06A</b> Anticato	<b>RP</b> Round	\$ 377.00	\$ 401.00	\$ 180.00	\$ 961.00
	<b>RQ</b> Square	\$ 496.00	\$ 516.00	\$ 239.00	\$ 1,100.00
<b>15</b> Satin nickel	<b>RP</b> Round	\$ 362.00	\$ 375.00	\$ 168.00	\$ 961.00
	<b>RQ</b> Square	\$ 481.00	\$ 494.00	\$ 227.00	\$ 1,100.00
<b>26D</b> Satin chrome	<b>RP</b> Round	\$ 353.00	\$ 370.00	\$ 166.00	\$ 961.00
	<b>RQ</b> Square	\$ 471.00	\$ 489.00	\$ 225.00	\$ 1,100.00

**Retail price**

Finish	Escutcheon	Function PGE	PCY	DMY R/L Single	DMY R/L Pair	ML-F Entry
<b>26D</b> Satin chrome	<b>EP</b> Oval	\$ 520.00	\$ 545.00	\$ 254.00	\$ 455.00	\$ 899.00
	<b>ER</b> Rectangular	\$ 570.00	\$ 596.00	\$ 279.00	\$ 506.00	\$ 935.00

The options listed above are considered standard. Non-standard options are available upon request.

For more options on Rosettes and Escutcheon plates see page 23. For more options on Finishes see pages 12-13.

RE = Rectangular rosettes available for tubular latch application only. Add + \$ 30.00 LIST to the price of the RQ.

For slim rosette and European version see pages 100-103.

**Upcharges apply for the following special options:**

- Extra thick door (> 2")
- Non-standard rosettes (rosettes not listed above)
- Non-standard finishes (finishes not listed above)
- Split finishes

See page 17 for pricing. Exclusions may apply.

**Matching elements**

- Pg 168 Mortise lock functions
- Pg 152 Deadbolts
- Pg 154 Privacy Bolts
- Pg 156 Escutcheons with deadbolts
- Pg 160 Multi-Point Trim functions

European window lever style available in the same design. Call for pricing.

# H 311

## Mario Bellini



Material  
Brass

Collection  
Fusital

Group  
6

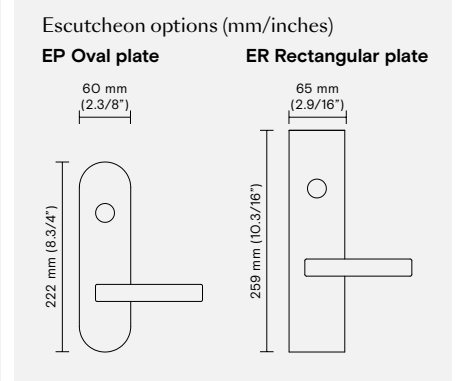
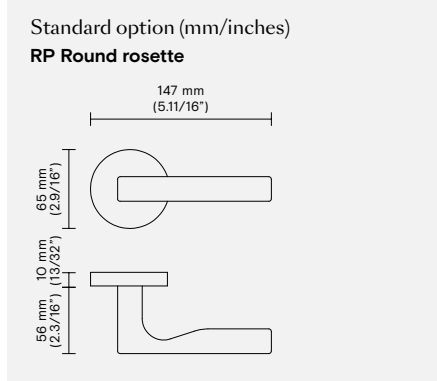
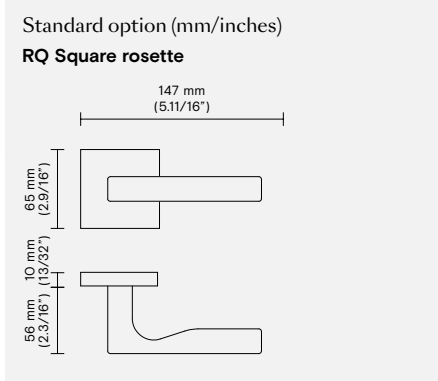

Slim rosette available - See pages 102-103

Conversions from metric to U.S. measurements are approximate.

### Retail price

Finish	Rosette	Function PGE	PCY	DMY R/L Single	ML-F Entry
14 Polished nickel	RP Round	\$ 677.00	\$ 699.00	\$ 329.00	\$ 1,213.00
	RQ Square	\$ 815.00	\$ 836.00	\$ 406.00	\$ 1,389.00
15 Satin nickel	RP Round	\$ 685.00	\$ 705.00	\$ 332.00	\$ 1,213.00
	RQ Square	\$ 766.00	\$ 778.00	\$ 408.00	\$ 1,389.00
26 Polished chrome	RP Round	\$ 599.00	\$ 612.00	\$ 293.00	\$ 1,213.00
	RQ Square	\$ 714.00	\$ 733.00	\$ 358.00	\$ 1,389.00
26D Satin chrome	RP Round	\$ 632.00	\$ 647.00	\$ 306.00	\$ 1,213.00
	RQ Square	\$ 755.00	\$ 777.00	\$ 383.00	\$ 1,389.00

### Retail price

Finish	Escutcheon	Function PGE	PCY	DMY R/L Single	DMY R/L Pair	ML-F Entry
26 Polished chrome	EP Oval	\$ 785.00	\$ 796.00	\$ 387.00	\$ 724.00	\$ 1,163.00
	ER Rectangular	\$ 819.00	\$ 833.00	\$ 410.00	\$ 772.00	\$ 1,200.00
26D Satin chrome	EP Oval	\$ 785.00	\$ 796.00	\$ 387.00	\$ 724.00	\$ 1,163.00
	ER Rectangular	\$ 819.00	\$ 833.00	\$ 410.00	\$ 772.00	\$ 1,200.00

The options listed above are considered standard. Non-standard options are available upon request.

For more options on Rosettes and Escutcheon plates see page 23. For more options on Finishes see pages 12-13.

RE = Rectangular rosettes available for tubular latch application only. Add + \$ 30.00 LIST to the price of the RQ. For slim rosette and European version see pages 100-103.

Upcharges apply for the following special options:

- Extra thick door (> 2")
- Non-standard rosettes (rosettes not listed above)
- Non-standard finishes (finishes not listed above)
- Split finishes

See page 17 for pricing. Exclusions may apply.

### Matching elements

- Pg 168 Mortise lock functions
- Pg 152 Deadbolts
- Pg 154 Privacy Bolts
- Pg 156 Escutcheons with deadbolts
- Pg 160 Multi-Point Trim functions

European window lever style available in the same design. Call for pricing.



# H 315

## Pierluigi Cerri

Material	Collection	Group
Brass + Porcelain	Fusital	5

### Standard option (mm/inches)

#### RP Round rosette

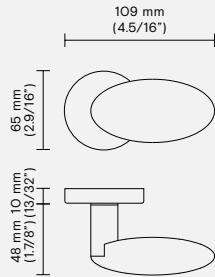

### Standard option (mm/inches)

#### RQ Square rosette

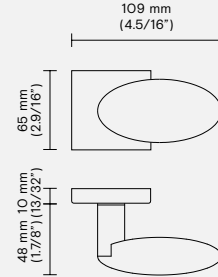

### Escutcheon options (mm/inches)

#### EP Oval plate

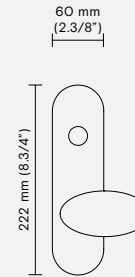

#### ER Rectangular plate

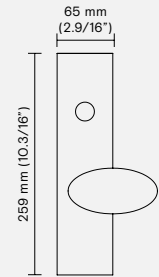

**Slim rosette** available - See pages 102-103

Conversions from metric to U.S. measurements are approximate.

### Retail price

Finish	Rosette	Function PGE	PCY	DMY R/L Single	ML-F Entry
<b>03/White</b> Polished brass / White	RP Round	\$ 483.00	\$ 516.00	\$ 235.00	\$ 1,100.00
	RQ Square	\$ 602.00	\$ 634.00	\$ 294.00	\$ 1,238.00
<b>26/White</b> Polished chrome / White	RP Round	\$ 483.00	\$ 516.00	\$ 235.00	\$ 1,100.00
	RQ Square	\$ 602.00	\$ 634.00	\$ 294.00	\$ 1,238.00

**Note:** Lever made of porcelain, not suitable for commercial use.

### Retail price

Finish	Escutcheon	Function PGE	PCY	DMY R/L Single	DMY R/L Pair	ML-F Entry
<b>26/White</b> Polished chrome / White	EP Oval	\$ 683.00	\$ 696.00	\$ 330.00	\$ 607.00	\$ 1,037.00
	ER Rectangular	\$ 734.00	\$ 747.00	\$ 369.00	\$ 671.00	\$ 1,075.00

The options listed above are considered standard. Non-standard options are available upon request.

For more options on Rosettes and Escutcheon plates see page 23. For more options on Finishes see pages 12-13.

RE = Rectangular rosettes available for tubular latch application only. Add + \$ 30.00 LIST to the price of the RQ. For slim rosette and European version see pages 100-103.

#### Upcharges apply for the following special options:

- Extra thick door (> 2")
- Non-standard rosettes (rosettes not listed above)
- Non-standard finishes (finishes not listed above)
- Split finishes

See page 17 for pricing. Exclusions may apply.

#### Matching elements

- Pg 168 Mortise lock functions
- Pg 152 Deadbolts
- Pg 154 Privacy Bolts
- Pg 156 Escutcheons with deadbolts
- Pg 160 Multi-Point Trim functions

European window lever style available in the same design. Call for pricing.



# H 317

## Antonio Citterio

Material	Collection	Group
Brass	Fusital	5

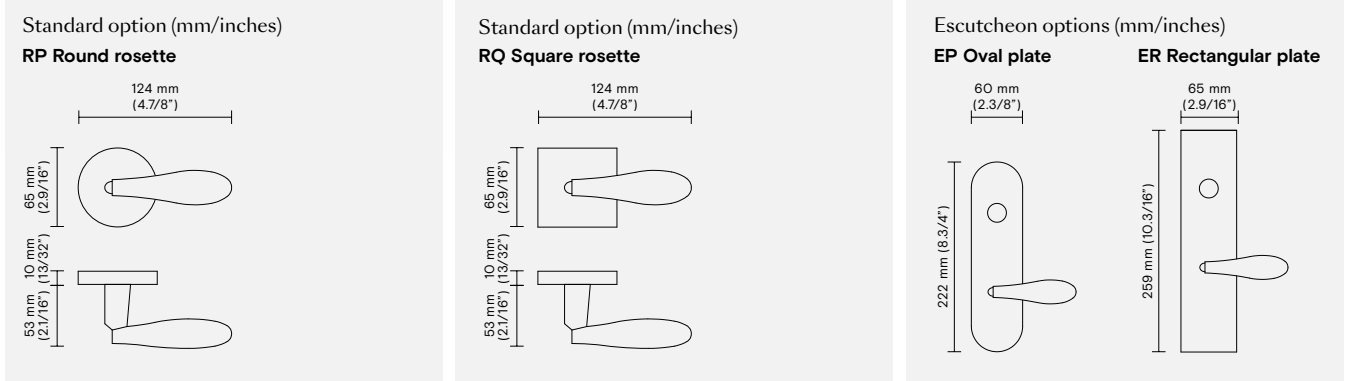

Slim rosette available - See pages 102-103

Conversions from metric to U.S. measurements are approximate.

### Retail price

Finish	Rosette	Function PGE	PCY	DMY R/L Single	ML-F Entry
26 Polished chrome	RP Round	\$ 483.00	\$ 495.00	\$ 227.00	\$ 1,100.00
	RQ Square	\$ 602.00	\$ 614.00	\$ 287.00	\$ 1,238.00
26D Satin chrome	RP Round	\$ 663.00	\$ 679.00	\$ 321.00	\$ 1,100.00
	RQ Square	\$ 792.00	\$ 815.00	\$ 401.00	\$ 1,238.00

### Retail price

Finish	Escutcheon	Function PGE	PCY	DMY R/L Single	DMY R/L Pair	ML-F Entry
26 Polished chrome	EP Oval	\$ 683.00	\$ 696.00	\$ 330.00	\$ 607.00	\$ 1,037.00
	ER Rectangular	\$ 734.00	\$ 747.00	\$ 369.00	\$ 671.00	\$ 1,075.00
26D Satin chrome	EP Oval	\$ 683.00	\$ 696.00	\$ 330.00	\$ 607.00	\$ 1,037.00
	ER Rectangular	\$ 734.00	\$ 747.00	\$ 369.00	\$ 671.00	\$ 1,075.00

The options listed above are considered standard. Non-standard options are available upon request.

For more options on Rosettes and Escutcheon plates see page 23. For more options on Finishes see pages 12-13.

RE = Rectangular rosettes available for tubular latch application only. Add + \$ 30.00 LIST to the price of the RQ. For slim rosette and European version see pages 100-103.

Upcharges apply for the following special options:

- Extra thick door (> 2")
- Non-standard rosettes (rosettes not listed above)
- Non-standard finishes (finishes not listed above)
- Split finishes

See page 17 for pricing. Exclusions may apply.

### Matching elements

- Pg 168 Mortise lock functions
- Pg 152 Deadbolts
- Pg 154 Privacy Bolts
- Pg 156 Escutcheons with deadbolts
- Pg 160 Multi-Point Trim functions

European window lever style available in the same design. Call for pricing.



# H 327

## Antonio Citterio

Material	Collection	Group
Brass	Fusital	5

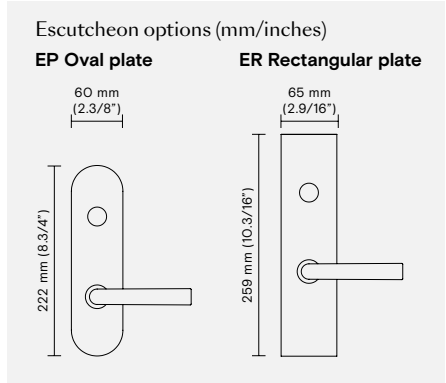
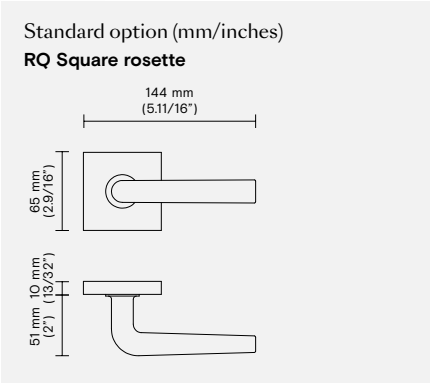
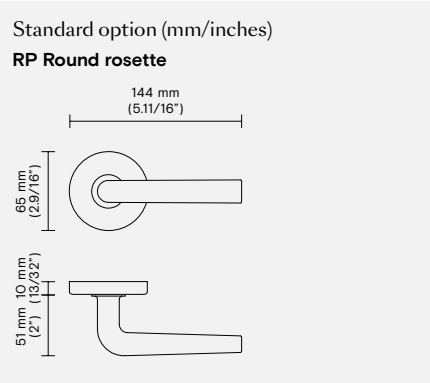

**Slim rosette** available - See pages 102-103

Conversions from metric to U.S. measurements are approximate.

**Retail price**

Finish	Rosette	Function PGE	PCY	DMY R/L Single	ML-F Entry
<b>03</b> Polished brass	<b>RP</b> Round	\$ 373.00	\$ 397.00	\$ 177.00	\$ 1,100.00
	<b>RQ</b> Square	\$ 491.00	\$ 516.00	\$ 236.00	\$ 1,238.00
<b>26D</b> Satin chrome	<b>RP</b> Round	\$ 378.00	\$ 400.00	\$ 181.00	\$ 1,100.00
	<b>RQ</b> Square	\$ 497.00	\$ 519.00	\$ 240.00	\$ 1,238.00

**Retail price**

Finish	Escutcheon	Function PGE	PCY	DMY R/L Single	DMY R/L Pair	ML-F Entry
<b>26D</b> Satin chrome	<b>EP</b> Oval	\$ 683.00	\$ 696.00	\$ 330.00	\$ 607.00	\$ 1,037.00
	<b>ER</b> Rectangular	\$ 734.00	\$ 747.00	\$ 369.00	\$ 671.00	\$ 1,075.00

The options listed above are considered standard. Non-standard options are available upon request.

For more options on Rosettes and Escutcheon plates see page 23. For more options on Finishes see pages 12-13.

RE = Rectangular rosettes available for tubular latch application only. Add + \$ 30.00 LIST to the price of the RQ.

For slim rosette and European version see pages 100-103.

**Upcharges apply for the following special options:**

- Extra thick door (> 2")
- Non-standard rosettes (rosettes not listed above)
- Non-standard finishes (finishes not listed above)
- Split finishes

See page 17 for pricing. Exclusions may apply.

**Matching elements**

- Pg 168 Mortise lock functions
- Pg 152 Deadbolts
- Pg 154 Privacy Bolts
- Pg 156 Escutcheons with deadbolts
- Pg 160 Multi-Point Trim functions

European window lever style available in the same design. Call for pricing.



# H 329

## Taller Design Ricardo Bofill

Material	Collection	Group
Brass	Fusital	6

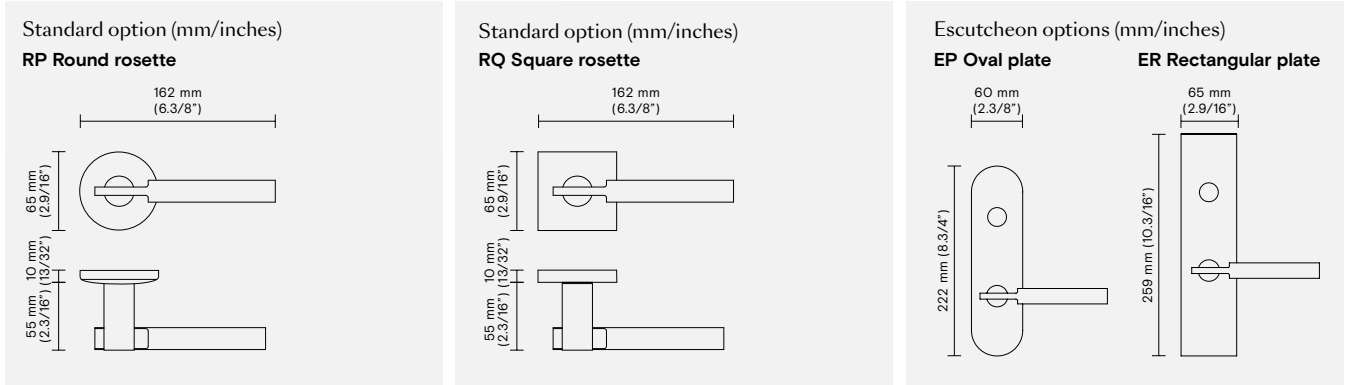

Slim rosette available - See pages 102-103

Conversions from metric to U.S. measurements are approximate.

### Retail price

Finish	Rosette	Function PGE	PCY	DMY R/L Single	ML-F Entry
26/26D Polished chrome / Satin chrome*	RP Round	\$ 555.00	\$ 581.00	\$ 267.00	\$ 1,213.00
	RQ Square	\$ 670.00	\$ 688.00	\$ 336.00	\$ 1,389.00
56 Dark bronze	RP Round	\$ 555.00	\$ 581.00	\$ 267.00	\$ 1,213.00
	RQ Square	\$ 670.00	\$ 688.00	\$ 336.00	\$ 1,389.00

### Retail price

Finish	Escutcheon	Function PGE	PCY	DMY R/L Single	DMY R/L Pair	ML-F Entry
26/26D Polished chrome / Satin chrome*	EP Oval	\$ 785.00	\$ 796.00	\$ 387.00	\$ 724.00	\$ 1,163.00
	ER Rectangular	\$ 819.00	\$ 833.00	\$ 410.00	\$ 772.00	\$ 1,200.00

\* The lever grip is satin, the shank is polished. The rosette/escutcheon is polished.

The options listed above are considered standard. Non-standard options are available upon request.

For more options on Rosettes and Escutcheon plates see page 23. For more options on Finishes see pages 12-13.

RE = Rectangular rosettes available for tubular latch application only. Add + \$ 30.00 LIST to the price of the RQ. For slim rosette and European version see pages 100-103.

Upcharges apply for the following special options:

- Extra thick door (> 2")
- Non-standard rosettes (rosettes not listed above)
- Non-standard finishes (finishes not listed above)
- Split finishes

See page 17 for pricing. Exclusions may apply.

#### Matching elements

- Pg 168 Mortise lock functions
- Pg 152 Deadbolts
- Pg 154 Privacy Bolts
- Pg 156 Escutcheons with deadbolts
- Pg 160 Multi-Point Trim functions

European window lever style available in the same design. Call for pricing.



# H 330

## Matteo Thun

Material	Collection	Group
Brass	Fusital	5

Standard option (mm/inches)

**RP Round rosette**

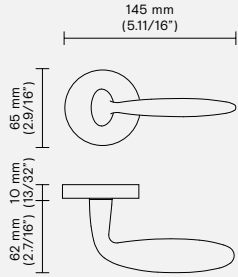

Standard option (mm/inches)

**RQ Square rosette**

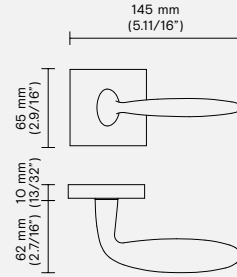

Escutcheon options (mm/inches)

**EP Oval plate**

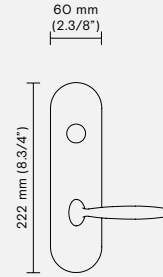

**ER Rectangular plate**

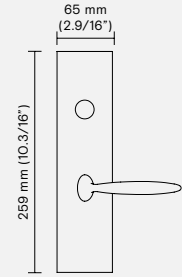

**Slim rosette** available - See pages 102-103

Conversions from metric to U.S. measurements are approximate.

**Retail price**

Finish	Rosette	Function PGE	PCY	DMY R/L Single	ML-F Entry
<b>06M</b> Matt bronze	<b>RP</b> Round	\$ 428.00	\$ 449.00	\$ 202.00	\$ 1,100.00
	<b>RQ</b> Square	\$ 547.00	\$ 569.00	\$ 262.00	\$ 1,238.00
<b>26D</b> Satin chrome	<b>RP</b> Round	\$ 428.00	\$ 449.00	\$ 202.00	\$ 1,100.00
	<b>RQ</b> Square	\$ 547.00	\$ 569.00	\$ 262.00	\$ 1,238.00

**Retail price**

Finish	Escutcheon	Function PGE	PCY	DMY R/L Single	DMY R/L Pair	ML-F Entry
<b>26D</b> Satin chrome	<b>EP</b> Oval	\$ 683.00	\$ 696.00	\$ 330.00	\$ 607.00	\$ 1,037.00
	<b>ER</b> Rectangular	\$ 734.00	\$ 747.00	\$ 369.00	\$ 671.00	\$ 1,075.00

The options listed above are considered standard. Non-standard options are available upon request.

For more options on Rosettes and Escutcheon plates see page 23. For more options on Finishes see pages 12-13.

RE = Rectangular rosettes available for tubular latch application only. Add + \$ 30.00 LIST to the price of the RQ. For slim rosette and European version see pages 100-103.

**Upcharges apply for the following special options:**

- Extra thick door (> 2")
- Non-standard rosettes (rosettes not listed above)
- Non-standard finishes (finishes not listed above)
- Split finishes

See page 17 for pricing. Exclusions may apply.

**Matching elements**

- Pg 168 Mortise lock functions
- Pg 152 Deadbolts
- Pg 154 Privacy Bolts
- Pg 156 Escutcheons with deadbolts
- Pg 160 Multi-Point Trim functions

European window lever style available in the same design. Call for pricing.



# H 334

## Foster + Partners

Material	Collection	Group
Brass	Fusital	5

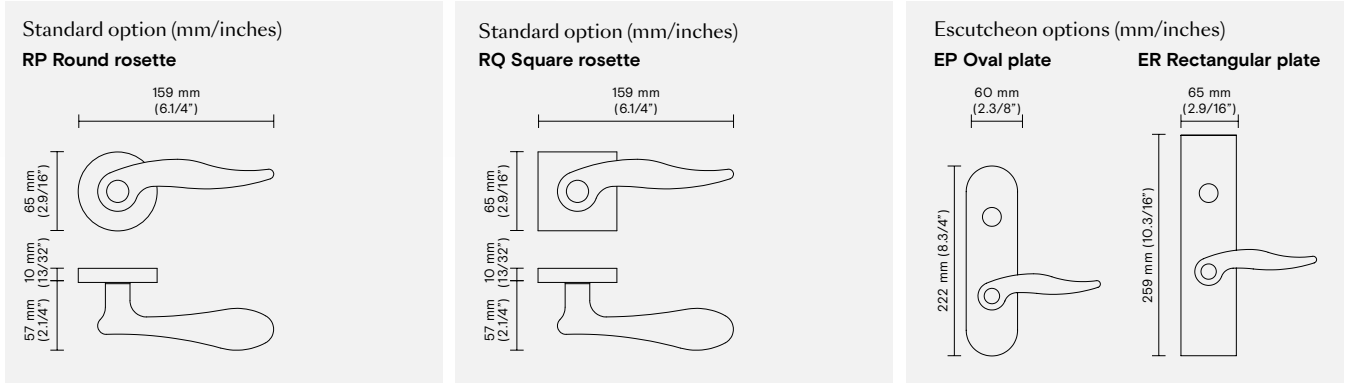

Conversions from metric to U.S. measurements are approximate.

### Retail price

Finish	Rosette	Function PGE	PCY	DMY R/L Single	ML-F Entry
<b>03</b> Polished brass	<b>RP</b> Round	\$ 530.00	\$ 548.00	\$ 252.00	\$ 1,100.00
	<b>RQ</b> Square	\$ 654.00	\$ 670.00	\$ 312.00	\$ 1,238.00
<b>26D</b> Satin chrome	<b>RP</b> Round	\$ 535.00	\$ 551.00	\$ 255.00	\$ 1,100.00
	<b>RQ</b> Square	\$ 654.00	\$ 670.00	\$ 315.00	\$ 1,238.00

### Retail price

Finish	Escutcheon	Function PGE	PCY	DMY R/L Single	DMY R/L Pair	ML-F Entry
<b>26D</b> Satin chrome	<b>EP</b> Oval	\$ 683.00	\$ 696.00	\$ 330.00	\$ 607.00	\$ 1,037.00
	<b>ER</b> Rectangular	\$ 734.00	\$ 747.00	\$ 369.00	\$ 671.00	\$ 1,075.00

The options listed above are considered standard. Non-standard options are available upon request.

For more options on Rosettes and Escutcheon plates see page 23. For more options on Finishes see pages 12-13.

RE = Rectangular rosettes available for tubular latch application only. Add + \$ 30.00 LIST to the price of the RQ. For slim rosette and European version see pages 100-103.

Upcharges apply for the following special options:

- Extra thick door (> 2")
- Non-standard rosettes (rosettes not listed above)
- Non-standard finishes (finishes not listed above)
- Split finishes

See page 17 for pricing. Exclusions may apply.

### Matching elements

- Pg 168 Mortise lock functions
- Pg 152 Deadbolts
- Pg 154 Privacy Bolts
- Pg 156 Escutcheons with deadbolts
- Pg 160 Multi-Point Trim functions

European window lever style available in the same design. Call for pricing.



# H 335

## Richard Meier

Material	Collection	Group
Brass	Fusital	6

Standard option (mm/inches)

**RP Round rosette**

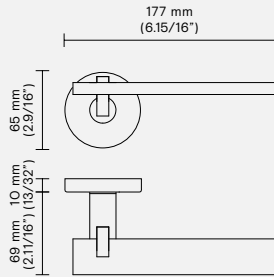

Standard option (mm/inches)

**RQ Square rosette**

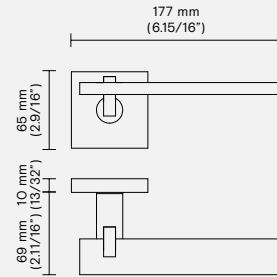

Escutcheon options (mm/inches)

**EP Oval plate**

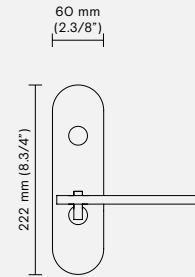

**ER Rectangular plate**

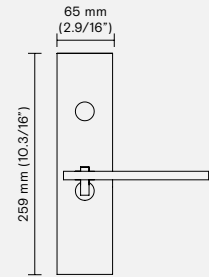

Conversions from metric to U.S. measurements are approximate.

**Retail price**

Finish	Rosette	Function PGE	PCY	DMY R/L Single	ML-F Entry
26 Polished chrome	RP Round	\$ 710.00	\$ 751.00	\$ 348.00	\$ 1,213.00
	RQ Square	\$ 829.00	\$ 870.00	\$ 408.00	\$ 1,389.00
26D Satin chrome	RP Round	\$ 791.00	\$ 827.00	\$ 386.00	\$ 1,213.00
	RQ Square	\$ 910.00	\$ 945.00	\$ 445.00	\$ 1,389.00

**Retail price**

Finish	Escutcheon	Function PGE	PCY	DMY R/L Single	DMY R/L Pair	ML-F Entry
26 Polished chrome	EP Oval	\$ 785.00	\$ 796.00	\$ 387.00	\$ 724.00	\$ 1,163.00
	ER Rectangular	\$ 819.00	\$ 833.00	\$ 410.00	\$ 772.00	\$ 1,200.00
26D Satin chrome	EP Oval	\$ 785.00	\$ 796.00	\$ 387.00	\$ 724.00	\$ 1,163.00
	ER Rectangular	\$ 819.00	\$ 833.00	\$ 410.00	\$ 772.00	\$ 1,200.00

The options listed above are considered standard. Non-standard options are available upon request.

For more options on Rosettes and Escutcheon plates see page 23. For more options on Finishes see pages 12-13.

RE = Rectangular rosettes available for tubular latch application only. Add + \$ 30.00 LIST to the price of the RQ. For slim rosette and European version see pages 100-103.

**Upcharges apply for the following special options:**

- Extra thick door (> 2")
- Non-standard rosettes (rosettes not listed above)
- Non-standard finishes (finishes not listed above)
- Split finishes

See page 17 for pricing. Exclusions may apply.

**Matching elements**

- Pg 168 Mortise lock functions
- Pg 152 Deadbolts
- Pg 154 Privacy Bolts
- Pg 156 Escutcheons with deadbolts
- Pg 160 Multi-Point Trim functions

European window lever style available in the same design. Call for pricing.



# H 338

## Yoshimi Kono

Material	Collection	Group
Brass	Fusital	5

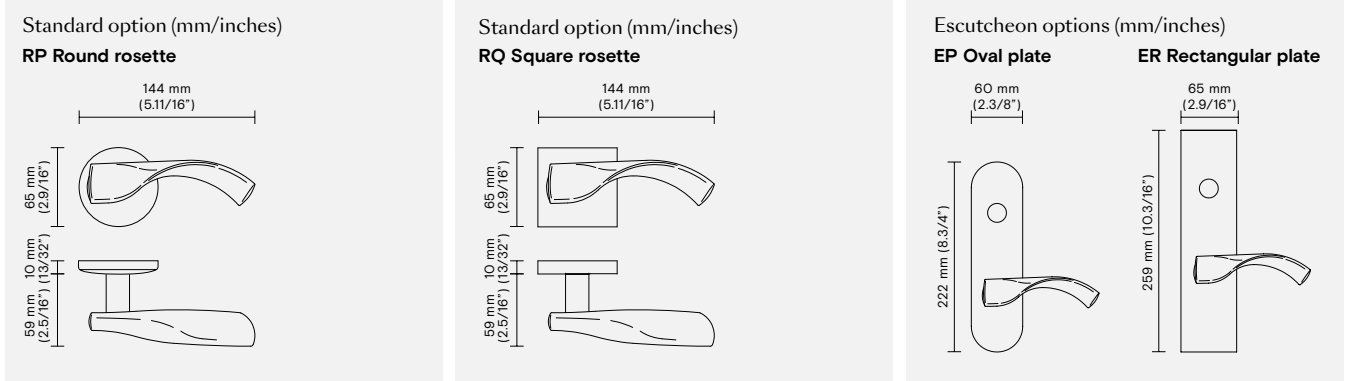

**Slim rosette** available - See pages 102-103

Conversions from metric to U.S. measurements are approximate.

### Retail price

Finish	Rosette	Function PGE	PCY	DMY R/L Single	ML-F Entry
<b>15</b> Satin nickel	<b>RP</b> Round	\$ 719.00	\$ 739.00	\$ 348.00	\$ 1,100.00
	<b>RQ</b> Square	\$ 803.00	\$ 816.00	\$ 428.00	\$ 1,238.00
<b>16</b> Dull black	<b>RP</b> Round	\$ 790.00	\$ 813.00	\$ 383.00	\$ 1,100.00
	<b>RQ</b> Square	\$ 883.00	\$ 933.00	\$ 470.00	\$ 1,238.00
<b>26D</b> Satin chrome	<b>RP</b> Round	\$ 535.00	\$ 551.00	\$ 255.00	\$ 1,100.00
	<b>RQ</b> Square	\$ 654.00	\$ 670.00	\$ 315.00	\$ 1,238.00

### Retail price

Finish	Escutcheon	Function PGE	PCY	DMY R/L Single	DMY R/L Pair	ML-F Entry
<b>26D</b> Satin chrome	<b>EP</b> Oval	\$ 683.00	\$ 696.00	\$ 330.00	\$ 607.00	\$ 1,037.00
	<b>ER</b> Rectangular	\$ 734.00	\$ 747.00	\$ 369.00	\$ 671.00	\$ 1,075.00

The options listed above are considered standard. Non-standard options are available upon request.

For more options on Rosettes and Escutcheon plates see page 23. For more options on Finishes see pages 12-13.

RE = Rectangular rosettes available for tubular latch application only. Add + \$ 30.00 LIST to the price of the RQ. For slim rosette and European version see pages 100-103.

#### Upcharges apply for the following special options:

- Extra thick door (> 2")
- Non-standard rosettes (rosettes not listed above)
- Non-standard finishes (finishes not listed above)
- Split finishes

See page 17 for pricing. Exclusions may apply.

#### Matching elements

- Pg 168 Mortise lock functions
- Pg 152 Deadbolts
- Pg 154 Privacy Bolts
- Pg 156 Escutcheons with deadbolts
- Pg 160 Multi-Point Trim functions

European window lever style available in the same design. Call for pricing.



# H 343

## John Pawson

Material	Collection	Group
Brass	Fusital	6

Standard option (mm/inches)

**RQ Square rosette**

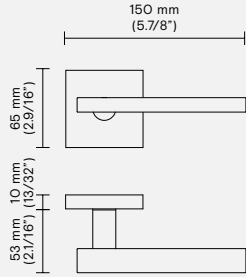

Standard option (mm/inches)

**RP Round rosette**

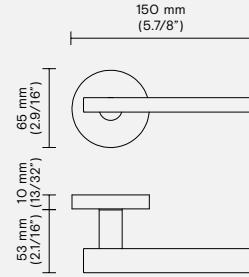

Escutcheon options (mm/inches)

**EP Oval plate**

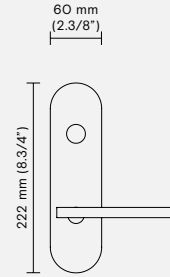

**ER Rectangular plate**

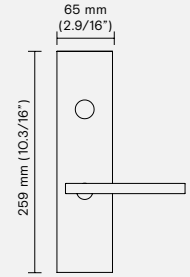

**Slim rosette** available - See pages 102-103

Conversions from metric to U.S. measurements are approximate.

**Retail price**

Finish	Rosette	Function PGE	PCY	DMY R/L Single	ML-F Entry
<b>14</b> Polished nickel	<b>RP</b> Round	\$ 642.00	\$ 683.00	\$ 320.00	\$ 1,213.00
	<b>RQ</b> Square	\$ 790.00	\$ 827.00	\$ 401.00	\$ 1,389.00
<b>15</b> Satin nickel	<b>RP</b> Round	\$ 623.00	\$ 657.00	\$ 308.00	\$ 1,213.00
	<b>RQ</b> Square	\$ 754.00	\$ 782.00	\$ 386.00	\$ 1,389.00
<b>26</b> Polished chrome	<b>RP</b> Round	\$ 571.00	\$ 599.00	\$ 280.00	\$ 1,213.00
	<b>RQ</b> Square	\$ 694.00	\$ 728.00	\$ 350.00	\$ 1,389.00
<b>26D</b> Satin chrome	<b>RP</b> Round	\$ 594.00	\$ 626.00	\$ 293.00	\$ 1,213.00
	<b>RQ</b> Square	\$ 734.00	\$ 767.00	\$ 373.00	\$ 1,389.00

**Retail price**

Finish	Escutcheon	Function PGE	PCY	DMY R/L Single	DMY R/L Pair	ML-F Entry
<b>26</b> Polished chrome	<b>EP</b> Oval	\$ 785.00	\$ 796.00	\$ 387.00	\$ 724.00	\$ 1,163.00
	<b>ER</b> Rectangular	\$ 819.00	\$ 833.00	\$ 410.00	\$ 772.00	\$ 1,200.00
<b>26D</b> Satin chrome	<b>EP</b> Oval	\$ 785.00	\$ 796.00	\$ 387.00	\$ 724.00	\$ 1,163.00
	<b>ER</b> Rectangular	\$ 819.00	\$ 833.00	\$ 410.00	\$ 772.00	\$ 1,200.00

The options listed above are considered standard. Non-standard options are available upon request.

For more options on Rosettes and Escutcheon plates see page 23. For more options on Finishes see pages 12-13.

RE = Rectangular rosettes available for tubular latch application only. Add + \$ 30.00 LIST to the price of the RQ. For slim rosette and European version see pages 100-103.

**Upcharges apply for the following special options:**

- Extra thick door (> 2")
- Non-standard rosettes (rosettes not listed above)
- Non-standard finishes (finishes not listed above)
- Split finishes

See page 17 for pricing. Exclusions may apply.

**Matching elements**

- Pg 168 Mortise lock functions
- Pg 152 Deadbolts
- Pg 154 Privacy Bolts
- Pg 156 Escutcheons with deadbolts
- Pg 160 Multi-Point Trim functions

European window lever style available in the same design. Call for pricing.



# H 348

## David Chipperfield

Material	Collection	Group
Brass	Fusital	5

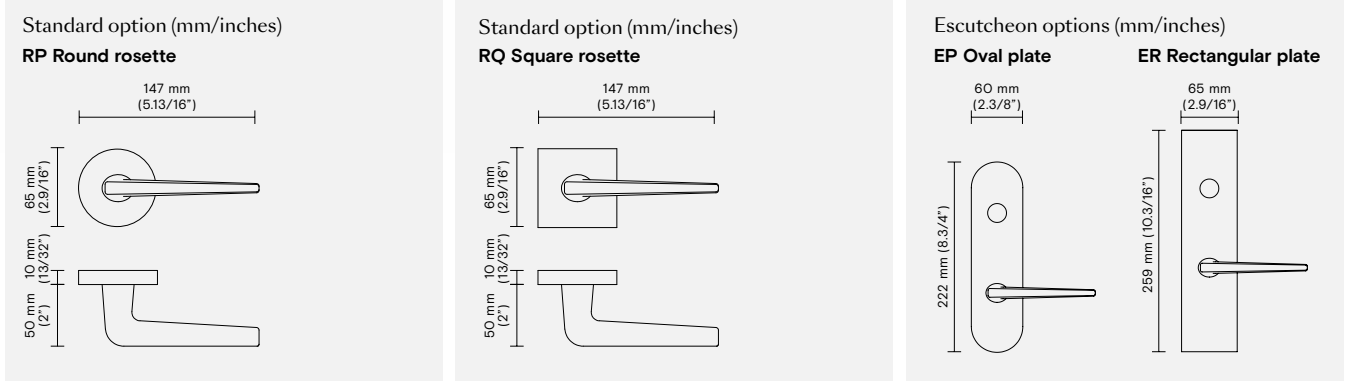

**Slim rosette** available - See pages 102-103

Conversions from metric to U.S. measurements are approximate.

### Retail price

Finish	Rosette	Function PGE	PCY	DMY R/L Single	ML-F Entry
<b>15</b> Satin nickel	<b>RP</b> Round	\$ 547.00	\$ 562.00	\$ 264.00	\$ 1,100.00
	<b>RQ</b> Square	\$ 666.00	\$ 681.00	\$ 323.00	\$ 1,238.00
<b>16</b> Dull black	<b>RP</b> Round	\$ 505.00	\$ 532.00	\$ 249.00	\$ 1,100.00
	<b>RQ</b> Square	\$ 624.00	\$ 651.00	\$ 308.00	\$ 1,238.00
<b>26</b> Polished chrome	<b>RP</b> Round	\$ 441.00	\$ 466.00	\$ 211.00	\$ 1,100.00
	<b>RQ</b> Square	\$ 560.00	\$ 585.00	\$ 270.00	\$ 1,238.00
<b>26D</b> Satin chrome	<b>RP</b> Round	\$ 445.00	\$ 469.00	\$ 213.00	\$ 1,100.00
	<b>RQ</b> Square	\$ 564.00	\$ 588.00	\$ 273.00	\$ 1,238.00

### Retail price

Finish	Escutcheon	Function PGE	PCY	DMY R/L Single	DMY R/L Pair	ML-F Entry
<b>26</b> Polished chrome	<b>EP</b> Oval	\$ 683.00	\$ 696.00	\$ 330.00	\$ 607.00	\$ 1,037.00
	<b>ER</b> Rectangular	\$ 734.00	\$ 747.00	\$ 369.00	\$ 671.00	\$ 1,075.00
<b>26D</b> Satin chrome	<b>EP</b> Oval	\$ 683.00	\$ 696.00	\$ 330.00	\$ 607.00	\$ 1,037.00
	<b>ER</b> Rectangular	\$ 734.00	\$ 747.00	\$ 369.00	\$ 671.00	\$ 1,075.00

The options listed above are considered standard. Non-standard options are available upon request.

For more options on Rosettes and Escutcheon plates see page 23. For more options on Finishes see pages 12-13.

RE = Rectangular rosettes available for tubular latch application only. Add + \$ 30.00 LIST to the price of the RQ. For slim rosette and European version see pages 100-103.

Upcharges apply for the following special options:

- Extra thick door (> 2")
- Non-standard rosettes (rosettes not listed above)
- Non-standard finishes (finishes not listed above)
- Split finishes

See page 17 for pricing. Exclusions may apply.

### Matching elements

- Pg 168 Mortise lock functions
- Pg 152 Deadbolts
- Pg 154 Privacy Bolts
- Pg 156 Escutcheons with deadbolts
- Pg 160 Multi-Point Trim functions

European window lever style available in the same design. Call for pricing.



# H 356

## Zaha Hadid

Material	Collection	Group
Zinc alloy	Fusital	8

### Standard option (mm/inches)

#### RP Round rosette

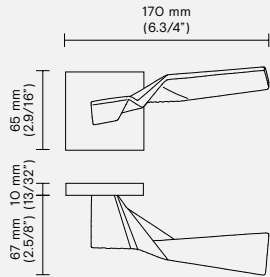

### Standard option (mm/inches)

#### RQ Square rosette

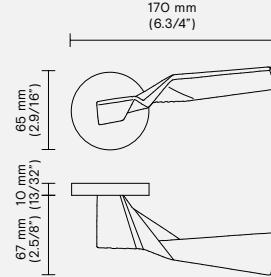

### Escutcheon options (mm/inches)

#### EP Oval plate

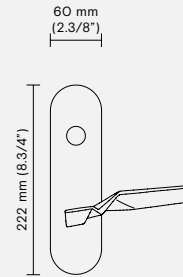

#### ER Rectangular plate

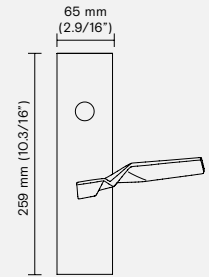

**Slim rosette** available - See pages 102-103

Conversions from metric to U.S. measurements are approximate.

### Retail price

Finish	Rosette	Function PGE	PCY	DMY R/L Single	ML-F Entry
<b>22M</b> Matt white	<b>RP</b> Round	\$ 1,088.00	\$ 1,116.00	\$ 538.00	\$ 1,668.00
	<b>RQ</b> Square	\$ 1,208.00	\$ 1,242.00	\$ 610.00	\$ 1,819.00
<b>26</b> Polished chrome	<b>RP</b> Round	\$ 1,088.00	\$ 1,116.00	\$ 538.00	\$ 1,668.00
	<b>RQ</b> Square	\$ 1,208.00	\$ 1,242.00	\$ 610.00	\$ 1,819.00
<b>26D</b> Satin chrome	<b>RP</b> Round	\$ 1,095.00	\$ 1,125.00	\$ 540.00	\$ 1,668.00
	<b>RQ</b> Square	\$ 1,230.00	\$ 1,269.00	\$ 626.00	\$ 1,819.00

### Retail price

Finish	Escutcheon	Function PGE	PCY	DMY R/L Single	DMY R/L Pair	ML-F Entry
<b>26</b> Polished chrome	<b>EP</b> Oval	\$ 1,264.00	\$ 1,289.00	\$ 633.00	\$ 1,200.00	\$ 1,617.00
	<b>ER</b> Rectangular	\$ 1,328.00	\$ 1,340.00	\$ 658.00	\$ 1,251.00	\$ 1,655.00
<b>26D</b> Satin chrome	<b>EP</b> Oval	\$ 1,264.00	\$ 1,289.00	\$ 633.00	\$ 1,200.00	\$ 1,617.00
	<b>ER</b> Rectangular	\$ 1,328.00	\$ 1,340.00	\$ 658.00	\$ 1,251.00	\$ 1,655.00

The options listed above are considered standard. Non-standard options are available upon request.

For more options on Rosettes and Escutcheon plates see page 23. For more options on Finishes see pages 12-13.

RE = Rectangular rosettes available for tubular latch application only. Add + \$ 30.00 LIST to the price of the RQ. For slim rosette and European version see pages 100-103.

#### Upcharges apply for the following special options:

- Extra thick door (> 2")
- Non-standard rosettes (rosettes not listed above)
- Non-standard finishes (finishes not listed above)
- Split finishes

See page 17 for pricing. Exclusions may apply.

#### Matching elements

- Pg 168 Mortise lock functions
- Pg 152 Deadbolts
- Pg 154 Privacy Bolts
- Pg 156 Escutcheons with deadbolts
- Pg 160 Multi-Point Trim functions

European window lever style available in the same design. Call for pricing.



# H 359

## SOM - Skidmore, Owings & Merrill

Material	Collection	Group
Brass	Fusital	6

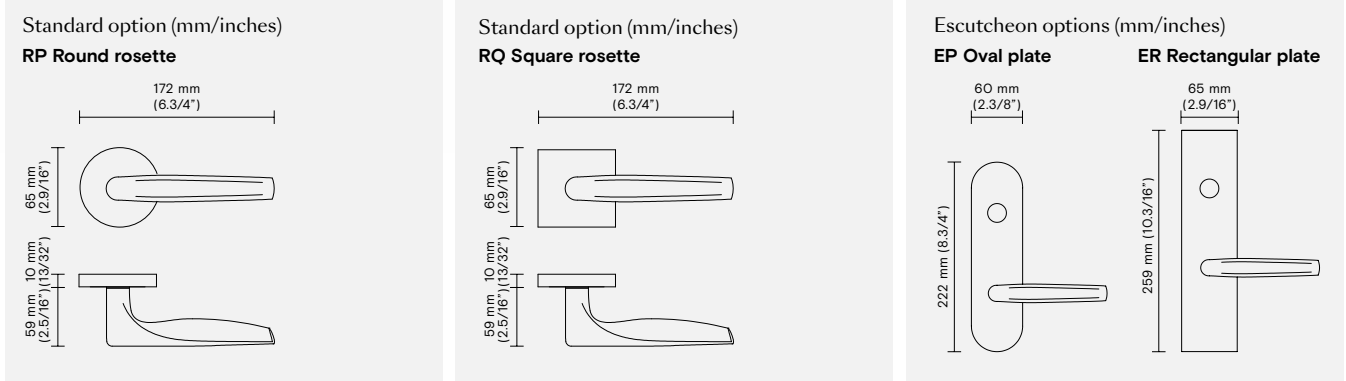

Slim rosette available - See pages 102-103

Conversions from metric to U.S. measurements are approximate.

### Retail price

Finish	Rosette	Function PGE	PCY	DMY R/L Single	ML-F Entry
<b>06M</b> Matt bronze	RP Round	\$ 590.00	\$ 606.00	\$ 281.00	\$ 1,213.00
	RQ Square	\$ 709.00	\$ 725.00	\$ 341.00	\$ 1,389.00
<b>14</b> Polished nickel	RP Round	\$ 604.00	\$ 623.00	\$ 292.00	\$ 1,213.00
	RQ Square	\$ 723.00	\$ 741.00	\$ 351.00	\$ 1,389.00
<b>15</b> Satin nickel	RP Round	\$ 604.00	\$ 623.00	\$ 292.00	\$ 1,213.00
	RQ Square	\$ 723.00	\$ 741.00	\$ 351.00	\$ 1,389.00
<b>26</b> Polished chrome	RP Round	\$ 535.00	\$ 549.00	\$ 256.00	\$ 1,213.00
	RQ Square	\$ 654.00	\$ 668.00	\$ 316.00	\$ 1,389.00
<b>26D</b> Satin chrome	RP Round	\$ 562.00	\$ 578.00	\$ 269.00	\$ 1,213.00
	RQ Square	\$ 681.00	\$ 697.00	\$ 329.00	\$ 1,389.00

### Retail price

Finish	Escutcheon	Function PGE	PCY	DMY R/L Single	DMY R/L Pair	ML-F Entry
<b>26</b> Polished chrome	EP Oval	\$ 785.00	\$ 796.00	\$ 387.00	\$ 724.00	\$ 1,163.00
	ER Rectangular	\$ 819.00	\$ 833.00	\$ 410.00	\$ 772.00	\$ 1,200.00
<b>26D</b> Satin chrome	EP Oval	\$ 785.00	\$ 796.00	\$ 387.00	\$ 724.00	\$ 1,163.00
	ER Rectangular	\$ 819.00	\$ 833.00	\$ 410.00	\$ 772.00	\$ 1,200.00

The options listed above are considered standard. Non-standard options are available upon request.

For more options on Rosettes and Escutcheon plates see page 23. For more options on Finishes see pages 12-13.

RE = Rectangular rosettes available for tubular latch application only. Add + \$ 30.00 LIST to the price of the RQ. For slim rosette and European version see pages 100-103.

Upcharges apply for the following special options:

- Extra thick door (> 2")
- Non-standard rosettes (rosettes not listed above)
- Non-standard finishes (finishes not listed above)
- Split finishes

See page 17 for pricing. Exclusions may apply.

### Matching elements

- Pg 168 Mortise lock functions
- Pg 152 Deadbolts
- Pg 154 Privacy Bolts
- Pg 156 Escutcheons with deadbolts
- Pg 160 Multi-Point Trim functions

European window lever style available in the same design. Call for pricing.

# H 361

## Antonio Citterio with Toan Nguyen



Material	Collection	Group
Zinc alloy	Fusital	5

Standard option (mm/inches)

**RQ Square rosette**

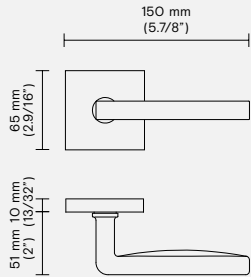

Standard option (mm/inches)

**RP Round rosette**

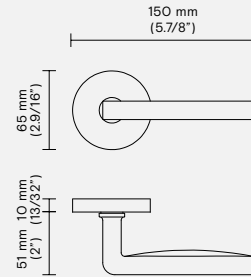

Escutcheon options (mm/inches)

**EP Oval plate**

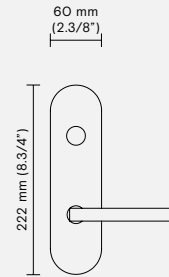

**ER Rectangular plate**

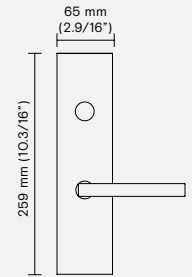

**Slim rosette** available - See pages 102-103

Conversions from metric to U.S. measurements are approximate.

**Retail price**

Finish	Rosette	Function PGE	PCY	DMY R/L Single	ML-F Entry
<b>14</b> Polished nickel	<b>RP</b> Round	\$ 462.00	\$ 490.00	\$ 224.00	\$ 1,100.00
	<b>RQ</b> Square	\$ 610.00	\$ 628.00	\$ 308.00	\$ 1,238.00
<b>15</b> Satin nickel	<b>RP</b> Round	\$ 463.00	\$ 495.00	\$ 224.00	\$ 1,100.00
	<b>RQ</b> Square	\$ 597.00	\$ 615.00	\$ 303.00	\$ 1,238.00
<b>26</b> Polished chrome	<b>RP</b> Round	\$ 409.00	\$ 439.00	\$ 196.00	\$ 1,100.00
	<b>RQ</b> Square	\$ 538.00	\$ 555.00	\$ 267.00	\$ 1,238.00
<b>26D</b> Satin chrome	<b>RP</b> Round	\$ 422.00	\$ 456.00	\$ 207.00	\$ 1,100.00
	<b>RQ</b> Square	\$ 565.00	\$ 583.00	\$ 288.00	\$ 1,238.00

**Retail price**

Finish	Escutcheon	Function PGE	PCY	DMY R/L Single	DMY R/L Pair	ML-F Entry
<b>26</b> Polished chrome	<b>EP</b> Oval	\$ 683.00	\$ 696.00	\$ 330.00	\$ 607.00	\$ 1,037.00
	<b>ER</b> Rectangular	\$ 734.00	\$ 747.00	\$ 369.00	\$ 671.00	\$ 1,075.00
<b>26D</b> Satin chrome	<b>EP</b> Oval	\$ 683.00	\$ 696.00	\$ 330.00	\$ 607.00	\$ 1,037.00
	<b>ER</b> Rectangular	\$ 734.00	\$ 747.00	\$ 369.00	\$ 671.00	\$ 1,075.00

The options listed above are considered standard. Non-standard options are available upon request.

For more options on Rosettes and Escutcheon plates see page 23. For more options on Finishes see pages 12-13.

RE = Rectangular rosettes available for tubular latch application only. Add + \$ 30.00 LIST to the price of the RQ. For slim rosette and European version see pages 100-103.

Upcharges apply for the following special options:

- Extra thick door (> 2")
- Non-standard rosettes (rosettes not listed above)
- Non-standard finishes (finishes not listed above)
- Split finishes

See page 17 for pricing. Exclusions may apply.

**Matching elements**

- Pg 168 Mortise lock functions
- Pg 152 Deadbolts
- Pg 154 Privacy Bolts
- Pg 156 Escutcheons with deadbolts
- Pg 160 Multi-Point Trim functions

European window lever style available in the same design. Call for pricing.

# H 364

## Mario Bellini

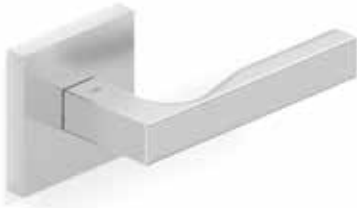

Material  
Brass

Collection  
Fusital

Group  
5

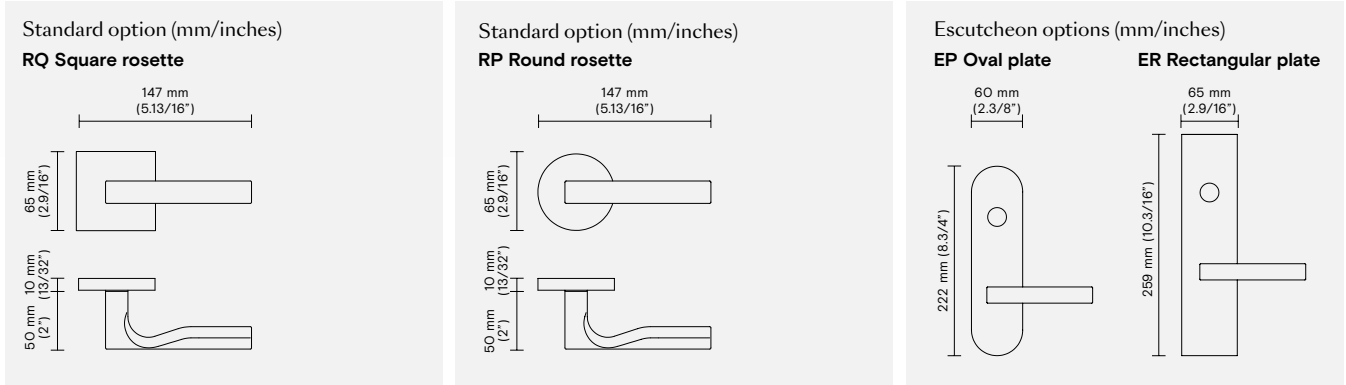

Slim rosette available - See pages 102-103

Conversions from metric to U.S. measurements are approximate.

### Retail price

Finish	Rosette	Function PGE	PCY	DMY R/L Single	ML-F Entry
15 Satin nickel	RP Round	\$ 535.00	\$ 571.00	\$ 259.00	\$ 1,100.00
	RQ Square	\$ 664.00	\$ 712.00	\$ 340.00	\$ 1,238.00
26 Polished chrome	RP Round	\$ 497.00	\$ 522.00	\$ 236.00	\$ 1,100.00
	RQ Square	\$ 617.00	\$ 651.00	\$ 312.00	\$ 1,238.00
26D Satin chrome	RP Round	\$ 502.00	\$ 535.00	\$ 238.00	\$ 1,100.00
	RQ Square	\$ 636.00	\$ 668.00	\$ 326.00	\$ 1,238.00

### Retail price

Finish	Escutcheon	Function PGE	PCY	DMY R/L Single	DMY R/L Pair	ML-F Entry
26 Polished chrome	EP Oval	\$ 683.00	\$ 696.00	\$ 330.00	\$ 607.00	\$ 1,037.00
	ER Rectangular	\$ 734.00	\$ 747.00	\$ 369.00	\$ 671.00	\$ 1,075.00
26D Satin chrome	EP Oval	\$ 683.00	\$ 696.00	\$ 330.00	\$ 607.00	\$ 1,037.00
	ER Rectangular	\$ 734.00	\$ 747.00	\$ 369.00	\$ 671.00	\$ 1,075.00

The options listed above are considered standard.  
Non-standard options are available upon request.

For more options on Rosettes and Escutcheon plates see page 23.  
For more options on Finishes see pages 12-13.

RE = Rectangular rosettes available for tubular latch application only.  
Add + \$ 30.00 LIST to the price of the RQ.  
For slim rosette and European version see pages 100-103.

Upcharges apply for the following special options:

- Extra thick door (> 2")
- Non-standard rosettes (rosettes not listed above)
- Non-standard finishes (finishes not listed above)
- Split finishes

See page 17 for pricing. Exclusions may apply.

### Matching elements

- Pg 168 Mortise lock functions
- Pg 152 Deadbolts
- Pg 154 Privacy Bolts
- Pg 156 Escutcheons with deadbolts
- Pg 160 Multi-Point Trim functions

European window lever style available in the same design.  
Call for pricing.



# H 367

## Giancarlo Vegni

Material: Brass  
 Collection: Fusital  
 Group: 5

### Standard option (mm/inches)

#### RQ Square rosette

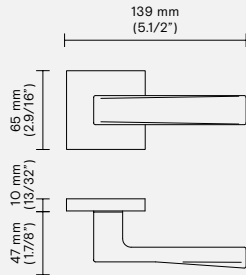

### Standard option (mm/inches)

#### RP Round rosette

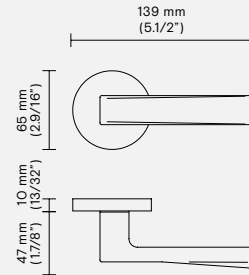

### Escutcheon options (mm/inches)

#### EP Oval plate

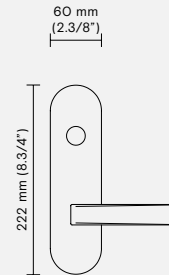

#### ER Rectangular plate

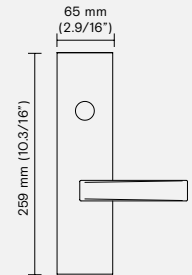

Slim rosette available - See pages 102-103

Conversions from metric to U.S. measurements are approximate.

### Retail price

Finish	Rosette	Function PGE	PCY	DMY R/L Single	ML-F Entry
26 Polished chrome	RP Round	\$ 502.00	\$ 526.00	\$ 238.00	\$ 1,100.00
	RQ Square	\$ 617.00	\$ 651.00	\$ 312.00	\$ 1,238.00
26D Satin chrome	RP Round	\$ 509.00	\$ 509.00	\$ 240.00	\$ 1,100.00
	RQ Square	\$ 636.00	\$ 668.00	\$ 326.00	\$ 1,238.00

### Retail price

Finish	Escutcheon	Function PGE	PCY	DMY R/L Single	DMY R/L Pair	ML-F Entry
26 Polished chrome	EP Oval	\$ 683.00	\$ 696.00	\$ 330.00	\$ 607.00	\$ 1,037.00
	ER Rectangular	\$ 734.00	\$ 747.00	\$ 369.00	\$ 671.00	\$ 1,075.00
26D Satin chrome	EP Oval	\$ 683.00	\$ 696.00	\$ 330.00	\$ 607.00	\$ 1,037.00
	ER Rectangular	\$ 734.00	\$ 747.00	\$ 369.00	\$ 671.00	\$ 1,075.00

The options listed above are considered standard. Non-standard options are available upon request.

For more options on Rosettes and Escutcheon plates see page 23. For more options on Finishes see pages 12-13.

RE = Rectangular rosettes available for tubular latch application only. Add + \$ 30.00 LIST to the price of the RQ. For slim rosette and European version see pages 100-103.

#### Upcharges apply for the following special options:

- Extra thick door (> 2")
- Non-standard rosettes (rosettes not listed above)
- Non-standard finishes (finishes not listed above)
- Split finishes

See page 17 for pricing. Exclusions may apply.

#### Matching elements

- Pg 168 Mortise lock functions
- Pg 152 Deadbolts
- Pg 154 Privacy Bolts
- Pg 156 Escutcheons with deadbolts
- Pg 160 Multi-Point Trim functions

European window lever style available in the same design. Call for pricing.



# H 368

## Cerri & Associati

Material  
Brass

Collection  
Fusital

Group  
5

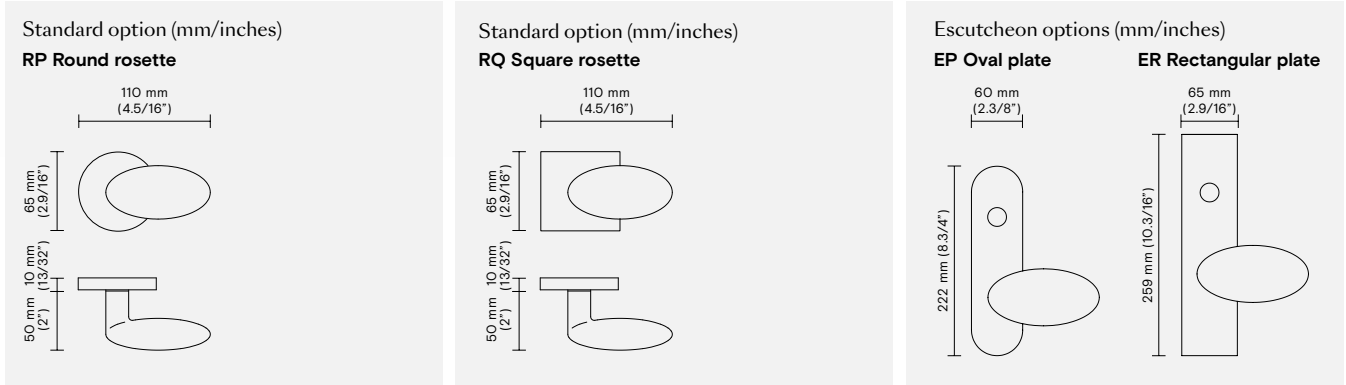

Slim rosette available - See pages 102-103

Conversions from metric to U.S. measurements are approximate.

### Retail price

Finish	Rosette	Function PGE	PCY	DMY R/L Single	ML-F Entry
26 Polished chrome	RP Round	\$ 459.00	\$ 484.00	\$ 216.00	\$ 1,100.00
	RQ Square	\$ 578.00	\$ 603.00	\$ 276.00	\$ 1,238.00
26D Satin chrome	RP Round	\$ 474.00	\$ 499.00	\$ 224.00	\$ 1,100.00
	RQ Square	\$ 592.00	\$ 618.00	\$ 283.00	\$ 1,238.00

### Retail price

Finish	Escutcheon	Function PGE	PCY	DMY R/L Single	DMY R/L Pair	ML-F Entry
26 Polished chrome	EP Oval	\$ 683.00	\$ 696.00	\$ 330.00	\$ 607.00	\$ 1,037.00
	ER Rectangular	\$ 734.00	\$ 747.00	\$ 369.00	\$ 671.00	\$ 1,075.00
26D Satin chrome	EP Oval	\$ 683.00	\$ 696.00	\$ 330.00	\$ 607.00	\$ 1,037.00
	ER Rectangular	\$ 734.00	\$ 747.00	\$ 369.00	\$ 671.00	\$ 1,075.00

The options listed above are considered standard. Non-standard options are available upon request.

For more options on Rosettes and Escutcheon plates see page 23. For more options on Finishes see pages 12-13.

RE = Rectangular rosettes available for tubular latch application only. Add + \$ 30.00 LIST to the price of the RQ. For slim rosette and European version see pages 100-103.

Upcharges apply for the following special options:

- Extra thick door (> 2")
- Non-standard rosettes (rosettes not listed above)
- Non-standard finishes (finishes not listed above)
- Split finishes

See page 17 for pricing. Exclusions may apply.

### Matching elements

- Pg 168 Mortise lock functions
- Pg 152 Deadbolts
- Pg 154 Privacy Bolts
- Pg 156 Escutcheons with deadbolts
- Pg 160 Multi-Point Trim functions

European window lever style available in the same design. Call for pricing.

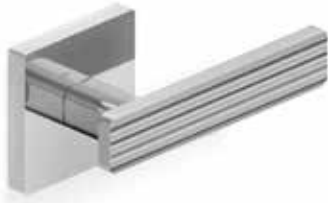

# H 370

Doriana e Massimiliano Fuksas

Material	Collection	Group
Brass	Fusital	5

### Standard option (mm/inches)

#### RQ Square rosette

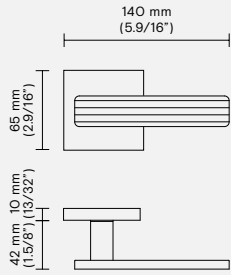

### Standard option (mm/inches)

#### RP Round rosette

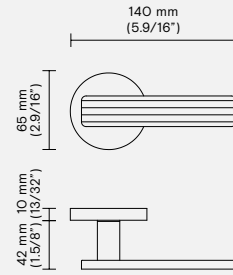

### Escutcheon options (mm/inches)

#### EP Oval plate

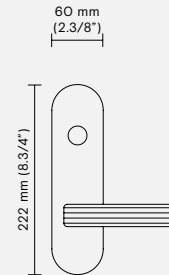

#### ER Rectangular plate

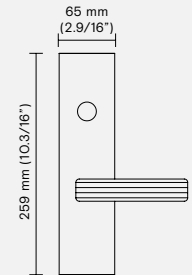

Slim rosette available - See pages 102-103

Conversions from metric to U.S. measurements are approximate.

### Retail price

Finish	Rosette	Function PGE	PCY	DMY R/L Single	ML-F Entry
26 Polished chrome	RP Round	\$ 389.00	\$ 417.00	\$ 194.00	\$ 1,100.00
	RQ Square	\$ 518.00	\$ 552.00	\$ 268.00	\$ 1,238.00
26D Satin chrome	RP Round	\$ 401.00	\$ 428.00	\$ 202.00	\$ 1,100.00
	RQ Square	\$ 536.00	\$ 573.00	\$ 288.00	\$ 1,238.00

### Retail price

Finish	Escutcheon	Function PGE	PCY	DMY R/L Single	DMY R/L Pair	ML-F Entry
26 Polished chrome	EP Oval	\$ 683.00	\$ 696.00	\$ 330.00	\$ 607.00	\$ 1,037.00
	ER Rectangular	\$ 734.00	\$ 747.00	\$ 369.00	\$ 671.00	\$ 1,075.00
26D Satin chrome	EP Oval	\$ 683.00	\$ 696.00	\$ 330.00	\$ 607.00	\$ 1,037.00
	ER Rectangular	\$ 734.00	\$ 747.00	\$ 369.00	\$ 671.00	\$ 1,075.00

The options listed above are considered standard. Non-standard options are available upon request.

For more options on Rosettes and Escutcheon plates see page 23. For more options on Finishes see pages 12-13.

RE = Rectangular rosettes available for tubular latch application only. Add + \$ 30.00 LIST to the price of the RQ. For slim rosette and European version see pages 100-103.

#### Upcharges apply for the following special options:

- Extra thick door (> 2")
- Non-standard rosettes (rosettes not listed above)
- Non-standard finishes (finishes not listed above)
- Split finishes

See page 17 for pricing. Exclusions may apply.

#### Matching elements

- Pg 168 Mortise lock functions
- Pg 152 Deadbolts
- Pg 154 Privacy Bolts
- Pg 156 Escutcheons with deadbolts
- Pg 160 Multi-Point Trim functions

European window lever style available in the same design. Call for pricing.



# H 372

## Eri Goshen

Material  
Brass

Collection  
Fusital

Group  
5

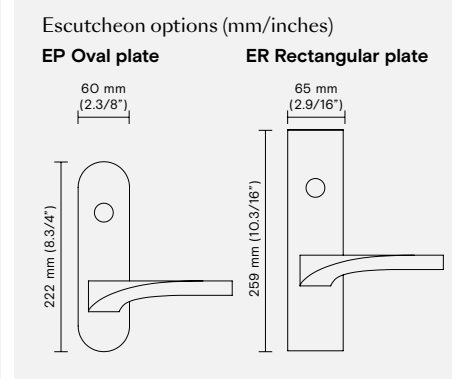
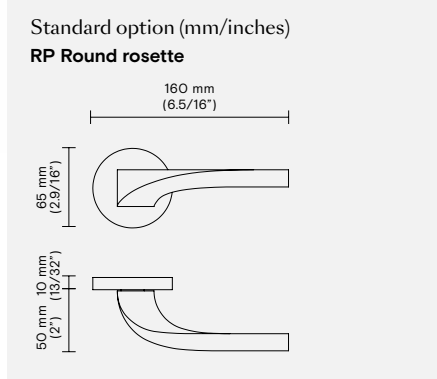
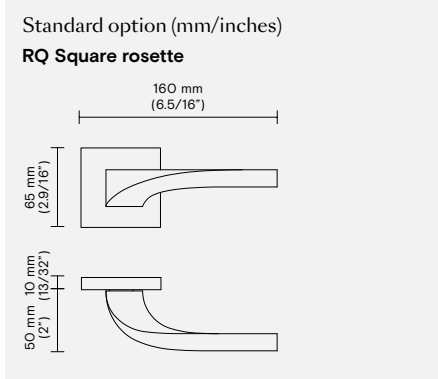

**Slim rosette** available - See pages 102-103

Conversions from metric to U.S. measurements are approximate.

### Retail price

Finish	Rosette	Function PGE	PCY	DMY R/L Single	ML-F Entry
<b>17A</b> Polished black nickel	<b>RP</b> Round	\$ 454.00	\$ 485.00	\$ 228.00	\$ 1,100.00
	<b>RQ</b> Square	\$ 602.00	\$ 640.00	\$ 321.00	\$ 1,238.00
<b>26</b> Polished chrome	<b>RP</b> Round	\$ 398.00	\$ 423.00	\$ 199.00	\$ 1,100.00
	<b>RQ</b> Square	\$ 518.00	\$ 552.00	\$ 272.00	\$ 1,238.00
<b>26D</b> Satin chrome	<b>RP</b> Round	\$ 414.00	\$ 443.00	\$ 209.00	\$ 1,100.00
	<b>RQ</b> Square	\$ 549.00	\$ 583.00	\$ 293.00	\$ 1,238.00

### Retail price

Finish	Escutcheon	Function PGE	PCY	DMY R/L Single	DMY R/L Pair	ML-F Entry
<b>26</b> Polished chrome	<b>EP</b> Oval	\$ 683.00	\$ 696.00	\$ 330.00	\$ 607.00	\$ 1,037.00
	<b>ER</b> Rectangular	\$ 734.00	\$ 747.00	\$ 369.00	\$ 671.00	\$ 1,075.00
<b>26D</b> Satin chrome	<b>EP</b> Oval	\$ 683.00	\$ 696.00	\$ 330.00	\$ 607.00	\$ 1,037.00
	<b>ER</b> Rectangular	\$ 734.00	\$ 747.00	\$ 369.00	\$ 671.00	\$ 1,075.00

The options listed above are considered standard.  
Non-standard options are available upon request.

For more options on Rosettes and Escutcheon plates see page 23.  
For more options on Finishes see pages 12-13.

RE = Rectangular rosettes available for tubular latch application only.  
Add + \$ 30.00 LIST to the price of the RQ.  
For slim rosette and European version see pages 100-103.

#### Upcharges apply for the following special options:

- Extra thick door (> 2")
- Non-standard rosettes (rosettes not listed above)
- Non-standard finishes (finishes not listed above)
- Split finishes

See page 17 for pricing. Exclusions may apply.

#### Matching elements

- Pg 168 Mortise lock functions
- Pg 152 Deadbolts
- Pg 154 Privacy Bolts
- Pg 156 Escutcheons with deadbolts
- Pg 160 Multi-Point Trim functions

European window lever style available in the same design.  
Call for pricing.



# H 376

## Giancarlo Vegni

Material	Collection	Group
Brass	Fusital	6

### Standard option (mm/inches)

#### RQ Square rosette

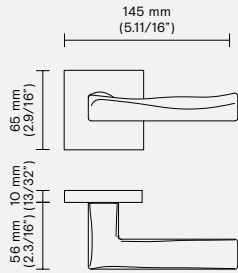

### Standard option (mm/inches)

#### RP Round rosette

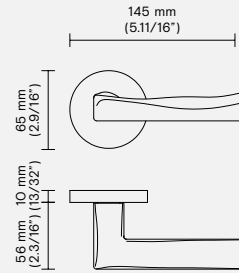

### Escutcheon options (mm/inches)

#### EP Oval plate

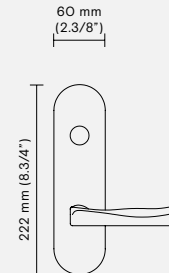

#### ER Rectangular plate

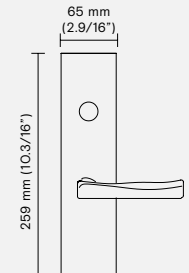

Conversions from metric to U.S. measurements are approximate.

### Retail price

Finish	Rosette	Function PGE	PCY	DMY R/L Single	ML-F Entry
26 Polished chrome	RP Round	\$ 517.00	\$ 536.00	\$ 252.00	\$ 1,213.00
	RQ Square	\$ 629.00	\$ 668.00	\$ 322.00	\$ 1,389.00
26D Satin chrome	RP Round	\$ 530.00	\$ 555.00	\$ 266.00	\$ 1,213.00
	RQ Square	\$ 668.00	\$ 699.00	\$ 354.00	\$ 1,389.00

### Retail price

Finish	Escutcheon	Function PGE	PCY	DMY R/L Single	DMY R/L Pair	ML-F Entry
26 Polished chrome	EP Oval	\$ 683.00	\$ 696.00	\$ 330.00	\$ 607.00	\$ 1,163.00
	ER Rectangular	\$ 734.00	\$ 747.00	\$ 369.00	\$ 671.00	\$ 1,200.00
26D Satin chrome	EP Oval	\$ 683.00	\$ 696.00	\$ 330.00	\$ 607.00	\$ 1,163.00
	ER Rectangular	\$ 734.00	\$ 747.00	\$ 369.00	\$ 671.00	\$ 1,200.00

The options listed above are considered standard. Non-standard options are available upon request.

For more options on Rosettes and Escutcheon plates see page 23. For more options on Finishes see pages 12-13.

RE = Rectangular rosettes available for tubular latch application only. Add + \$ 30.00 LIST to the price of the RQ. For slim rosette and European version see pages 100-103.

#### Upcharges apply for the following special options:

- Extra thick door (> 2")
- Non-standard rosettes (rosettes not listed above)
- Non-standard finishes (finishes not listed above)
- Split finishes

See page 17 for pricing. Exclusions may apply.

#### Matching elements

- Pg 168 Mortise lock functions
- Pg 152 Deadbolts
- Pg 154 Privacy Bolts
- Pg 156 Escutcheons with deadbolts
- Pg 160 Multi-Point Trim functions

European window lever style available in the same design. Call for pricing.



# H 377

## Steve Leung

Material  
Brass

Collection  
Fusital

Group  
7

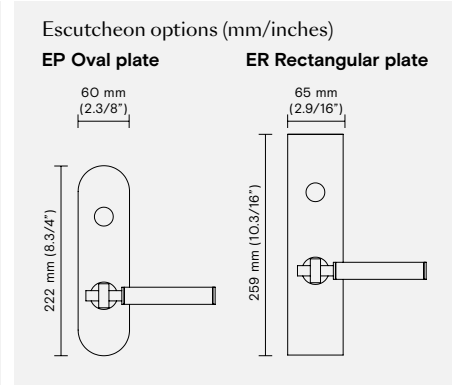
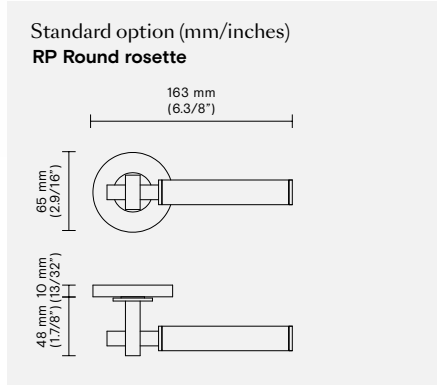
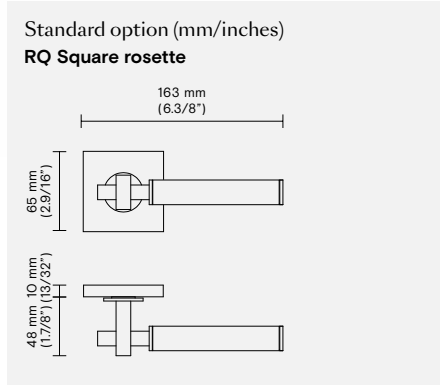

**Slim rosette** available - See pages 102-103

\*Only available on request  
Conversions from metric to U.S. measurements are approximate.

### Retail price

Finish	Rosette	Function PGE	PCY	DMY R/L Single	ML-F Entry
<b>03M</b> Matt brass	<b>RP</b> Round	\$ 617.00	\$ 646.00	\$ 302.00	\$ 1,617.00
	<b>RQ</b> Square	\$ 726.00	\$ 754.00	\$ 356.00	\$ 1,755.00
<b>16</b> Dull black	<b>RP</b> Round	\$ 517.00	\$ 543.00	\$ 254.00	\$ 1,617.00
	<b>RQ</b> Square	\$ 651.00	\$ 692.00	\$ 342.00	\$ 1,755.00
<b>56</b> Dark bronze	<b>RP</b> Round	\$ 720.00	\$ 774.00	\$ 365.00	\$ 1,617.00
	<b>RQ</b> Square	\$ 838.00	\$ 881.00	\$ 425.00	\$ 1,755.00

The options listed above are considered standard.  
Non-standard options are available upon request.

For more options on Rosettes and Escutcheon plates see page 23.  
For more options on Finishes see pages 12-13.

RE = Rectangular rosettes available for tubular latch application only.  
Add + \$ 30.00 LIST to the price of the RQ.  
For slim rosette and European version see pages 100-103.

Upcharges apply for the following special options:

- Extra thick door (> 2")
- Non-standard rosettes (rosettes not listed above)
- Non-standard finishes (finishes not listed above)
- Split finishes

See page 17 for pricing. Exclusions may apply.

### Matching elements

- Pg 168 Mortise lock functions
- Pg 152 Deadbolts
- Pg 154 Privacy Bolts
- Pg 156 Escutcheons with deadbolts
- Pg 160 Multi-Point Trim functions

European window lever style available in the same design.  
Call for pricing.



# H 378

## Yabu Pushelberg

Material	Collection	Group
Brass	Fusital	6

Standard option (mm/inches)

**RP Round rosette**

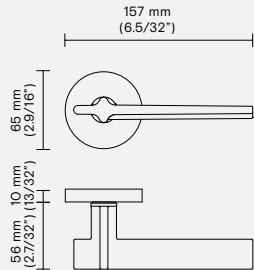

Standard option (mm/inches)

**RQ Square rosette**

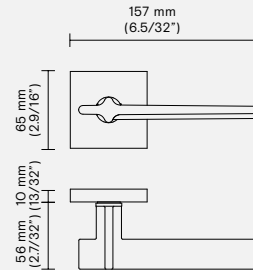

Escutcheon options (mm/inches)

**EP Oval plate**

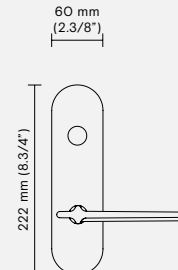

**ER Rectangular plate**

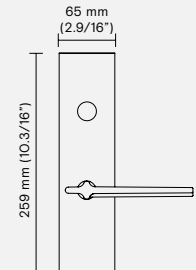

**Slim rosette** available - See pages 102-103

Conversions from metric to U.S. measurements are approximate.

**Retail price**

Finish	Rosette	Function PGE	PCY	DMY R/L Single	ML-F Entry
<b>17A</b> Polished black nickel	<b>RP</b> Round	\$ 618.00	\$ 649.00	\$ 298.00	\$ 1,213.00
	<b>RQ</b> Square	\$ 747.00	\$ 766.00	\$ 373.00	\$ 1,389.00
<b>26</b> Polished chrome	<b>RP</b> Round	\$ 590.00	\$ 562.00	\$ 271.00	\$ 1,213.00
	<b>RQ</b> Square	\$ 679.00	\$ 697.00	\$ 341.00	\$ 1,389.00
<b>56</b> Dark bronze	<b>RP</b> Round	\$ 676.00	\$ 709.00	\$ 325.00	\$ 1,213.00
	<b>RQ</b> Square	\$ 815.00	\$ 835.00	\$ 408.00	\$ 1,389.00

**Retail price**

Finish	Escutcheon	Function PGE	PCY	DMY R/L Single	DMY R/L Pair	ML-F Entry
<b>26</b> Polished chrome	<b>EP</b> Oval	\$ 785.00	\$ 796.00	\$ 387.00	\$ 724.00	\$ 1,163.00
	<b>ER</b> Rectangular	\$ 819.00	\$ 833.00	\$ 410.00	\$ 772.00	\$ 1,200.00

The options listed above are considered standard. Non-standard options are available upon request.

For more options on Rosettes and Escutcheon plates see page 23. For more options on Finishes see pages 12-13.

RE = Rectangular rosettes available for tubular latch application only. Add + \$ 30.00 LIST to the price of the RQ. For slim rosette and European version see pages 100-103.

**Upcharges apply for the following special options:**

- Extra thick door (> 2")
- Non-standard rosettes (rosettes not listed above)
- Non-standard finishes (finishes not listed above)
- Split finishes

See page 17 for pricing. Exclusions may apply.

**Matching elements**

- Pg 168 Mortise lock functions
- Pg 152 Deadbolts
- Pg 154 Privacy Bolts
- Pg 156 Escutcheons with deadbolts
- Pg 160 Multi-Point Trim functions

European window lever style available in the same design. Call for pricing.

# H 379

## Antonio Citterio



Material  
Brass

Collection  
Fusital

Group  
8

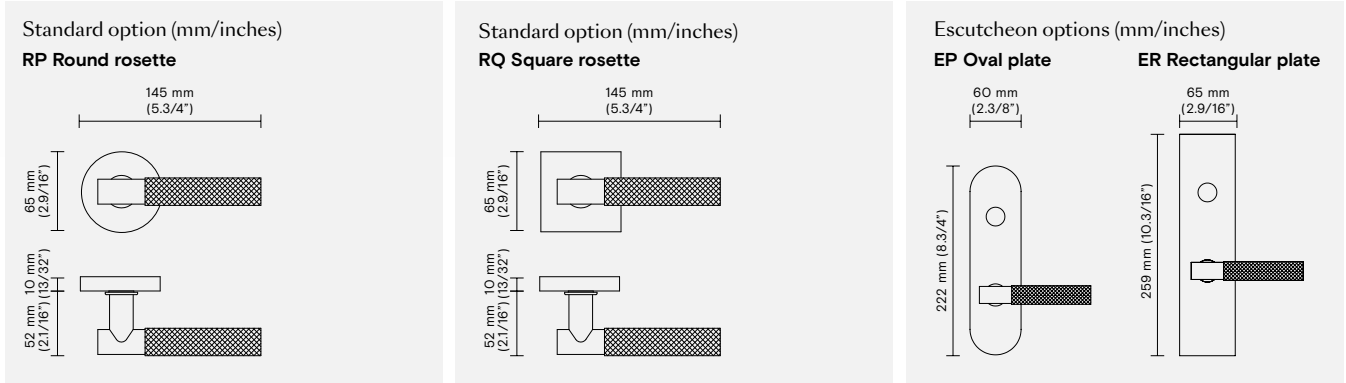

Slim rosette available - See pages 102-103

Conversions from metric to U.S. measurements are approximate.

### Retail price

Finish	Rosette	Function PGE	PCY	DMY R/L Single	ML-F Entry
03M Matt brass	RP Round	\$ 647.00	\$ 670.00	\$ 270.00	\$ 1,668.00
	RQ Square	\$ 755.00	\$ 789.00	\$ 323.00	\$ 1,819.00
06M Matt bronze	RP Round	\$ 759.00	\$ 775.00	\$ 319.00	\$ 1,668.00
	RQ Square	\$ 877.00	\$ 894.00	\$ 378.00	\$ 1,819.00
26D Satin chrome	RP Round	\$ 815.00	\$ 828.00	\$ 340.00	\$ 1,668.00
	RQ Square	\$ 934.00	\$ 947.00	\$ 399.00	\$ 1,819.00

### Retail price

Finish	Escutcheon	Function PGE	PCY	DMY R/L Single	DMY R/L Pair	ML-F Entry
26D Satin chrome	EP Oval	\$ 1,264.00	\$ 1,289.00	\$ 633.00	\$ 1,200.00	\$ 1,617.00
	ER Rectangular	\$ 1,328.00	\$ 1,340.00	\$ 658.00	\$ 1,251.00	\$ 1,655.00

The options listed above are considered standard. Non-standard options are available upon request.

For more options on Rosettes and Escutcheon plates see page 23. For more options on Finishes see pages 12-13.

RE = Rectangular rosettes available for tubular latch application only. Add + \$ 30.00 LIST to the price of the RQ. For slim rosette and European version see pages 100-103.

Upcharges apply for the following special options:

- Extra thick door (> 2")
- Non-standard rosettes (rosettes not listed above)
- Non-standard finishes (finishes not listed above)
- Split finishes

See page 17 for pricing. Exclusions may apply.

### Matching elements

- Pg 168 Mortise lock functions
- Pg 152 Deadbolts
- Pg 154 Privacy Bolts
- Pg 156 Escutcheons with deadbolts
- Pg 160 Multi-Point Trim functions

European window lever style available in the same design. Call for pricing.



# H 380

## Antonio Citterio

Material	Collection	Group
Brass	Fusital	8

Standard option (mm/inches)

**RP Round rosette**

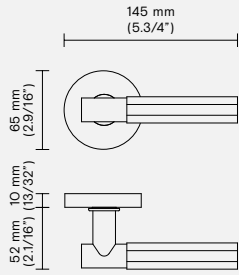

Standard option (mm/inches)

**RQ Square rosette**

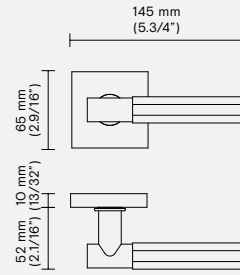

Escutcheon options (mm/inches)

**EP Oval plate**

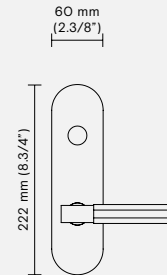

**ER Rectangular plate**

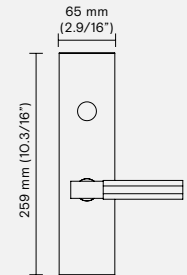

Slim rosette available - See pages 102-103

Conversions from metric to U.S. measurements are approximate.

**Retail price**

Finish	Rosette	Function PGE	PCY	DMY R/L Single	ML-F Entry
14 Polished nickel	RP Round	\$ 724.00	\$ 739.00	\$ 304.00	\$ 1,668.00
	RQ Square	\$ 837.00	\$ 852.00	\$ 361.00	\$ 1,819.00
26D Satin chrome	RP Round	\$ 724.00	\$ 739.00	\$ 304.00	\$ 1,668.00
	RQ Square	\$ 837.00	\$ 852.00	\$ 361.00	\$ 1,819.00
56 Dark bronze	RP Round	\$ 724.00	\$ 739.00	\$ 304.00	\$ 1,668.00
	RQ Square	\$ 837.00	\$ 852.00	\$ 361.00	\$ 1,819.00

**Retail price**

Finish	Escutcheon	Function PGE	PCY	DMY R/L Single	DMY R/L Pair	ML-F Entry
26D Satin chrome	EP Oval	\$ 1,264.00	\$ 1,289.00	\$ 633.00	\$ 1,200.00	\$ 1,617.00
	ER Rectangular	\$ 1,328.00	\$ 1,340.00	\$ 658.00	\$ 1,251.00	\$ 1,655.00

The options listed above are considered standard. Non-standard options are available upon request.

For more options on Rosettes and Escutcheon plates see page 23. For more options on Finishes see pages 12-13.

RE = Rectangular rosettes available for tubular latch application only. Add + \$ 30.00 LIST to the price of the RQ. For slim rosette and European version see pages 100-103.

**Upcharges apply for the following special options:**

- Extra thick door (> 2")
- Non-standard rosettes (rosettes not listed above)
- Non-standard finishes (finishes not listed above)
- Split finishes

See page 17 for pricing. Exclusions may apply.

**Matching elements**

- Pg 168 Mortise lock functions
- Pg 152 Deadbolts
- Pg 154 Privacy Bolts
- Pg 156 Escutcheons with deadbolts
- Pg 160 Multi-Point Trim functions

European window lever style available in the same design. Call for pricing.

# H 381

## Khalid Al Najjar



Material	Collection	Group
Brass	Fusital	5

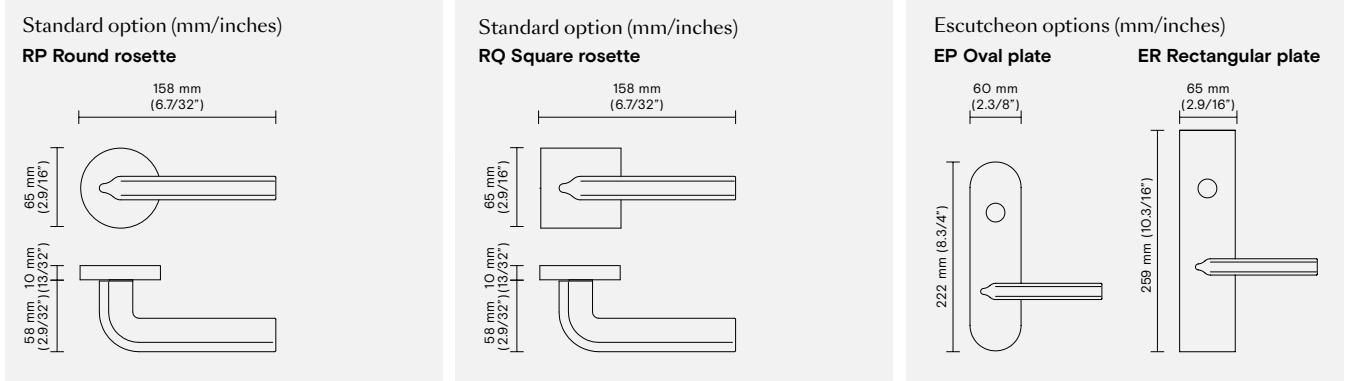

Slim rosette available - See pages 102-103

Conversions from metric to U.S. measurements are approximate.

### Retail price

Finish	Rosette	Function PGE	PCY	DMY R/L Single	ML-F Entry
03M Matt brass	RP Round	\$ 441.00	\$ 736.00	\$ 211.00	\$ 1,100.00
	RQ Square	\$ 560.00	\$ 855.00	\$ 270.00	\$ 1,238.00
15 Satin nickel	RP Round	\$ 539.00	\$ 832.00	\$ 264.00	\$ 1,100.00
	RQ Square	\$ 666.00	\$ 951.00	\$ 323.00	\$ 1,238.00
17A Polished balck nickel	RP Round	\$ 539.00	\$ 832.00	\$ 264.00	\$ 1,100.00
	RQ Square	\$ 666.00	\$ 951.00	\$ 323.00	\$ 1,238.00
26D Satin chrome	RP Round	\$ 539.00	\$ 832.00	\$ 264.00	\$ 1,100.00
	RQ Square	\$ 666.00	\$ 951.00	\$ 323.00	\$ 1,238.00

It does not fit a privacy pin, supplied with 105 Privacy Bolt.

### Retail price

Finish	Escutcheon	Function PGE	PCY	DMY R/L Single	DMY R/L Pair	ML-F Entry
26D Satin chrome	EP Oval	\$ 683.00	\$ 696.00	\$ 330.00	\$ 607.00	\$ 1,037.00
	ER Rectangular	\$ 734.00	\$ 747.00	\$ 369.00	\$ 671.00	\$ 1,075.00

The options listed above are considered standard. Non-standard options are available upon request.

For more options on Rosettes and Escutcheon plates see page 23. For more options on Finishes see pages 12-13.

RE = Rectangular rosettes available for tubular latch application only. Add + \$ 30.00 LIST to the price of the RQ. For slim rosette and European version see pages 100-103.

Upcharges apply for the following special options:

- Extra thick door (> 2")
- Non-standard rosettes (rosettes not listed above)
- Non-standard finishes (finishes not listed above)
- Split finishes

See page 17 for pricing. Exclusions may apply.

### Matching elements

- Pg 168 Mortise lock functions
- Pg 152 Deadbolts
- Pg 154 Privacy Bolts
- Pg 156 Escutcheons with deadbolts
- Pg 160 Multi-Point Trim functions

European window lever style available in the same design. Call for pricing.



# H 382

## Joe Cheng

Material: Brass      Collection: Fusital      Group: 5

Standard option (mm/inches)

**RP Round rosette**

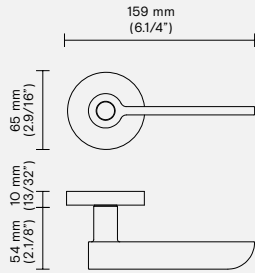

Standard option (mm/inches)

**RQ Square rosette**

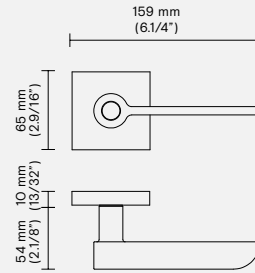

Escutcheon options (mm/inches)

**EP Oval plate**

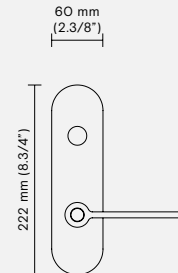

**ER Rectangular plate**

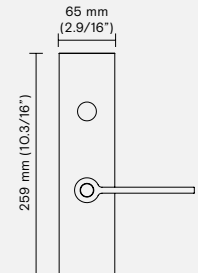

Slim rosette available - See pages 102-103

Conversions from metric to U.S. measurements are approximate.

**Retail price**

Finish	Rosette	Function PGE	PCY	DMY R/L Single	ML-F Entry
<b>06B</b> Brunito	<b>RP</b> Round	\$ 441.00	\$ 466.00	\$ 211.00	\$ 1,100.00
	<b>RQ</b> Square	\$ 560.00	\$ 585.00	\$ 270.00	\$ 1,238.00
<b>14</b> Polished nickel	<b>RP</b> Round	\$ 539.00	\$ 562.00	\$ 264.00	\$ 1,100.00
	<b>RQ</b> Square	\$ 666.00	\$ 681.00	\$ 323.00	\$ 1,238.00
<b>26</b> Polished chrome	<b>RP</b> Round	\$ 539.00	\$ 562.00	\$ 264.00	\$ 1,100.00
	<b>RQ</b> Square	\$ 666.00	\$ 681.00	\$ 323.00	\$ 1,238.00

**Retail price**

Finish	Escutcheon	Function PGE	PCY	DMY R/L Single	DMY R/L Pair	ML-F Entry
<b>26</b> Polished chrome	<b>EP</b> Oval	\$ 683.00	\$ 696.00	\$ 330.00	\$ 607.00	\$ 1,037.00
	<b>ER</b> Rectangular	\$ 734.00	\$ 747.00	\$ 369.00	\$ 671.00	\$ 1,075.00

The options listed above are considered standard. Non-standard options are available upon request.

For more options on Rosettes and Escutcheon plates see page 23. For more options on Finishes see pages 12-13.

RE = Rectangular rosettes available for tubular latch application only. Add + \$ 30.00 LIST to the price of the RQ. For slim rosette and European version see pages 100-103.

**Upcharges apply for the following special options:**

- Extra thick door (> 2")
- Non-standard rosettes (rosettes not listed above)
- Non-standard finishes (finishes not listed above)
- Split finishes

See page 17 for pricing. Exclusions may apply.

**Matching elements**

- Pg 168 Mortise lock functions
- Pg 152 Deadbolts
- Pg 154 Privacy Bolts
- Pg 156 Escutcheons with deadbolts
- Pg 160 Multi-Point Trim functions

European window lever style available in the same design. Call for pricing.

# H 383

## Perkins&Will



Material  
Brass

Collection  
Fusital

Group  
5

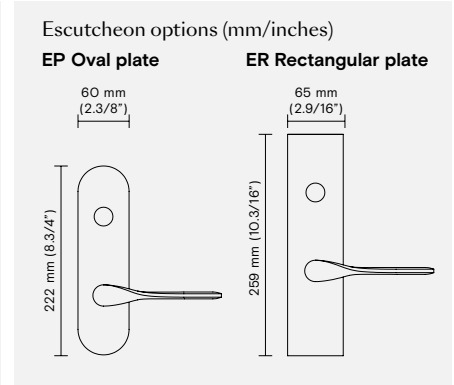
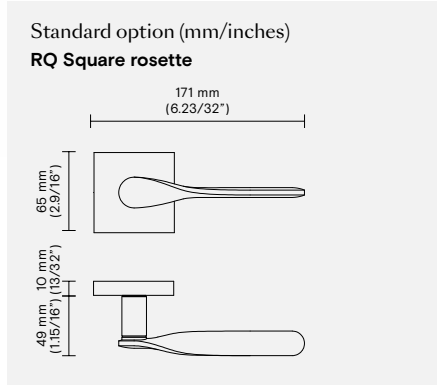
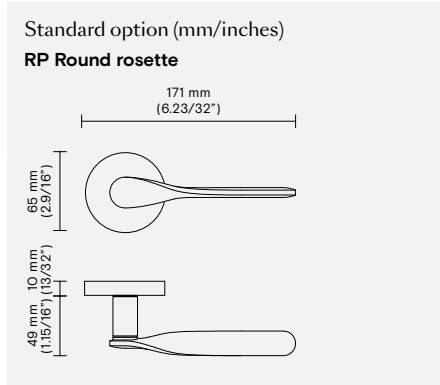

Slim rosette available - See pages 102-103

Conversions from metric to U.S. measurements are approximate.

### Retail price

Finish	Rosette	Function PGE	PCY	DMY R/L Single	ML-F Entry
15 Satin nickel	RP Round	\$ 539.00	\$ 562.00	\$ 264.00	\$ 1,100.00
	RQ Square	\$ 666.00	\$ 681.00	\$ 323.00	\$ 1,238.00
16 Dull black	RP Round	\$ 539.00	\$ 562.00	\$ 264.00	\$ 1,100.00
	RQ Square	\$ 666.00	\$ 681.00	\$ 323.00	\$ 1,238.00
26D Satin chrome	RP Round	\$ 539.00	\$ 562.00	\$ 264.00	\$ 1,100.00
	RQ Square	\$ 666.00	\$ 681.00	\$ 323.00	\$ 1,238.00
56 Dark bronze	RP Round	\$ 539.00	\$ 562.00	\$ 264.00	\$ 1,100.00
	RQ Square	\$ 666.00	\$ 681.00	\$ 323.00	\$ 1,238.00

### Retail price

Finish	Escutcheon	Function PGE	PCY	DMY R/L Single	DMY R/L Pair	ML-F Entry
26D Satin chrome	EP Oval	\$ 683.00	\$ 696.00	\$ 330.00	\$ 607.00	\$ 1,037.00
	ER Rectangular	\$ 734.00	\$ 747.00	\$ 369.00	\$ 671.00	\$ 1,075.00

The options listed above are considered standard. Non-standard options are available upon request.

For more options on Rosettes and Escutcheon plates see page 23. For more options on Finishes see pages 12-13.

RE = Rectangular rosettes available for tubular latch application only. Add + \$ 30.00 LIST to the price of the RQ. For slim rosette and European version see pages 100-103.

Upcharges apply for the following special options:

- Extra thick door (> 2")
- Non-standard rosettes (rosettes not listed above)
- Non-standard finishes (finishes not listed above)
- Split finishes

See page 17 for pricing. Exclusions may apply.

### Matching elements

- Pg 168 Mortise lock functions
- Pg 152 Deadbolts
- Pg 154 Privacy Bolts
- Pg 156 Escutcheons with deadbolts
- Pg 160 Multi-Point Trim functions

European window lever style available in the same design. Call for pricing.



# H 384

## CetraRuddy Architecture D.P.C.

Material	Collection	Group
Brass	Fusital	6

Standard option (mm/inches)

**RP Round rosette**

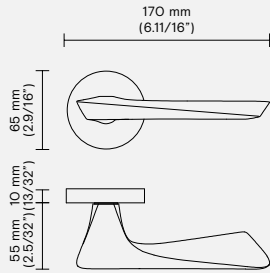

Standard option (mm/inches)

**RQ Square rosette**

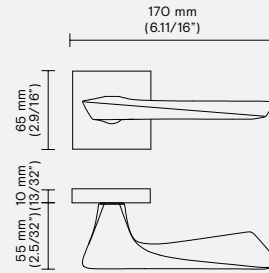

Escutcheon options (mm/inches)

**EP Oval plate**

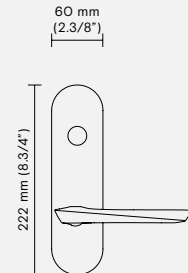

**ER Rectangular plate**

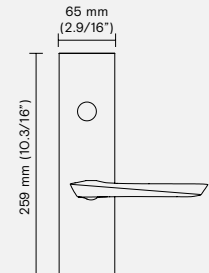

Slim rosette available - See pages 102-103

Conversions from metric to U.S. measurements are approximate.

**Retail price**

Finish	Rosette	Function PGE	PCY	DMY R/L Single	ML-F Entry
17A Polished black nickel	RP Round	\$ 631.00	\$ 647.00	\$ 308.00	\$ 1,213.00
	RQ Square	\$ 750.00	\$ 755.00	\$ 362.00	\$ 1,389.00
26 Polished chrome	RP Round	\$ 562.00	\$ 578.00	\$ 269.00	\$ 1,213.00
	RQ Square	\$ 681.00	\$ 697.00	\$ 323.00	\$ 1,389.00
26D Satin chrome	RP Round	\$ 610.00	\$ 626.00	\$ 292.00	\$ 1,213.00
	RQ Square	\$ 728.00	\$ 745.00	\$ 351.00	\$ 1,389.00
56 Dark bronze	RP Round	\$ 610.00	\$ 626.00	\$ 292.00	\$ 1,213.00
	RQ Square	\$ 728.00	\$ 745.00	\$ 351.00	\$ 1,389.00

**Retail price**

Finish	Escutcheon	Function PGE	PCY	DMY R/L Single	DMY R/L Pair	ML-F Entry
26 Polished chrome	EP Oval	\$ 785.00	\$ 796.00	\$ 387.00	\$ 724.00	\$ 1,163.00
	ER Rectangular	\$ 819.00	\$ 833.00	\$ 410.00	\$ 772.00	\$ 1,200.00
26D Satin chrome	EP Oval	\$ 785.00	\$ 796.00	\$ 387.00	\$ 724.00	\$ 1,163.00
	ER Rectangular	\$ 819.00	\$ 833.00	\$ 410.00	\$ 772.00	\$ 1,200.00

The options listed above are considered standard. Non-standard options are available upon request.

For more options on Rosettes and Escutcheon plates see page 23. For more options on Finishes see pages 12-13.

RE = Rectangular rosettes available for tubular latch application only. Add + \$ 30.00 LIST to the price of the RQ. For slim rosette and European version see pages 100-103.

**Upcharges apply for the following special options:**

- Extra thick door (> 2")
- Non-standard rosettes (rosettes not listed above)
- Non-standard finishes (finishes not listed above)
- Split finishes

See page 17 for pricing. Exclusions may apply.

**Matching elements**

- Pg 168 Mortise lock functions
- Pg 152 Deadbolts
- Pg 154 Privacy Bolts
- Pg 156 Escutcheons with deadbolts
- Pg 160 Multi-Point Trim functions

European window lever style available in the same design. Call for pricing.

# H 385

## Federica Biasi

NEW



Material	Collection	Group
Zinc alloy	Fusital	5

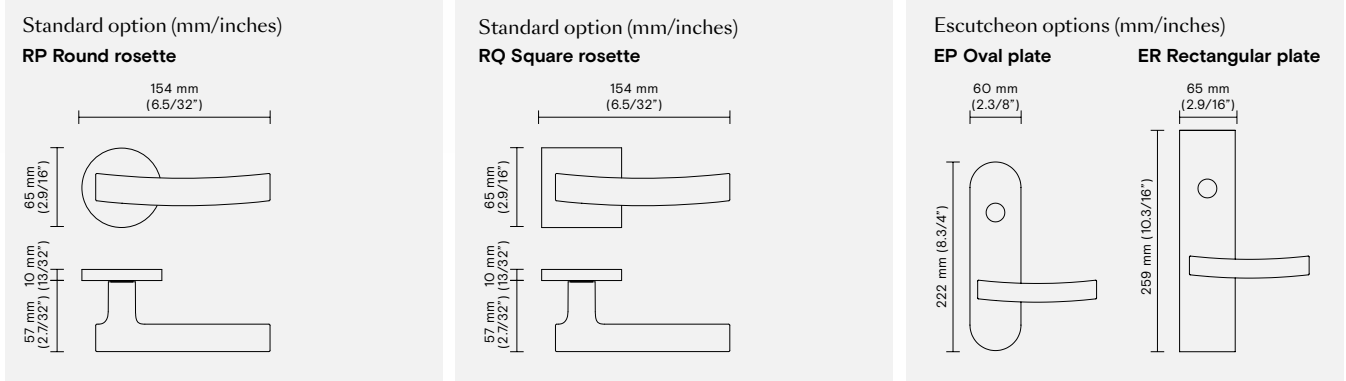

Slim rosette available - See pages 102-103

Conversions from metric to U.S. measurements are approximate.

### Retail price

Finish	Rosette	Function PGE	PCY	DMY R/L Single	ML-F Entry
15 Satin nickel	RP Round	\$ 378.00	\$ 417.00	\$ 184.00	\$ 1,100.00
	RQ Square	\$ 497.00	\$ 536.00	\$ 243.00	\$ 1,238.00
16 Dull black	RP Round	\$ 357.00	\$ 394.00	\$ 173.00	\$ 1,100.00
	RQ Square	\$ 476.00	\$ 512.00	\$ 216.00	\$ 1,238.00
26 Polished chrome	RP Round	\$ 378.00	\$ 417.00	\$ 184.00	\$ 1,100.00
	RQ Square	\$ 497.00	\$ 536.00	\$ 243.00	\$ 1,238.00
26D Satin chrome	RP Round	\$ 378.00	\$ 417.00	\$ 184.00	\$ 1,100.00
	RQ Square	\$ 497.00	\$ 536.00	\$ 243.00	\$ 1,238.00

### Retail price

Finish	Escutcheon	Function PGE	PCY	DMY R/L Single	DMY R/L Pair	ML-F Entry
26 Polished chrome	EP Oval	\$ 683.00	\$ 696.00	\$ 330.00	\$ 607.00	\$ 1,037.00
	ER Rectangular	\$ 734.00	\$ 747.00	\$ 369.00	\$ 671.00	\$ 1,075.00
26D Satin chrome	EP Oval	\$ 683.00	\$ 696.00	\$ 330.00	\$ 607.00	\$ 1,037.00
	ER Rectangular	\$ 734.00	\$ 747.00	\$ 369.00	\$ 671.00	\$ 1,075.00

The options listed above are considered standard. Non-standard options are available upon request.

For more options on Rosettes and Escutcheon plates see page 23. For more options on Finishes see pages 12-13.

RE = Rectangular rosettes available for tubular latch application only. Add + \$ 30.00 LIST to the price of the RQ. For slim rosette and European version see pages 100-103.

Upcharges apply for the following special options:

- Extra thick door (> 2")
- Non-standard rosettes (rosettes not listed above)
- Non-standard finishes (finishes not listed above)
- Split finishes

See page 17 for pricing. Exclusions may apply.

### Matching elements

- Pg 168 Mortise lock functions
- Pg 152 Deadbolts
- Pg 154 Privacy Bolts
- Pg 156 Escutcheons with deadbolts
- Pg 160 Multi-Point Trim functions

European window lever style available in the same design. Call for pricing.



# H 386

## Meneghello Paoelli

**NEW**

Material	Collection	Group
Zinc alloy	Fusital	5

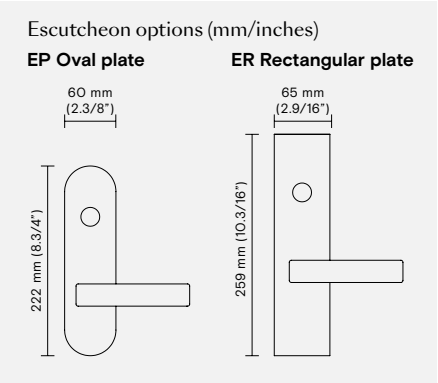
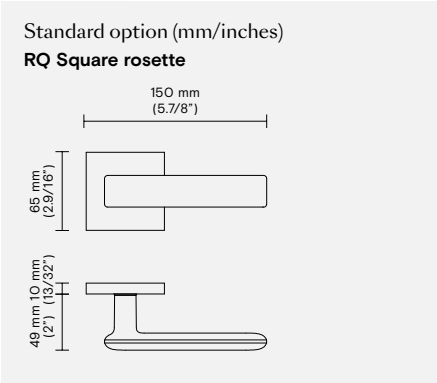
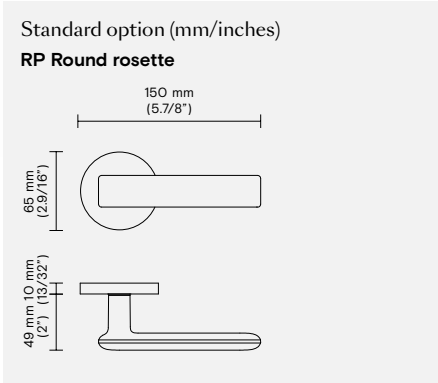

**Slim rosette** available - See pages 102-103

Conversions from metric to U.S. measurements are approximate.

**Retail price**

Finish	Rosette	Function PGE	PCY	DMY R/L Single	ML-F Entry
<b>15</b> Satin nickel	<b>RP</b> Round	\$ 354.00	\$ 370.00	\$ 165.00	\$ 1,100.00
	<b>RQ</b> Square	\$ 479.00	\$ 498.00	\$ 243.00	\$ 1,238.00
<b>17A</b> Polished black nickel	<b>RP</b> Round	\$ 360.00	\$ 382.00	\$ 170.00	\$ 1,100.00
	<b>RQ</b> Square	\$ 505.00	\$ 518.00	\$ 250.00	\$ 1,238.00
<b>26</b> Polished chrome	<b>RP</b> Round	\$ 327.00	\$ 337.00	\$ 148.00	\$ 1,100.00
	<b>RQ</b> Square	\$ 441.00	\$ 458.00	\$ 220.00	\$ 1,238.00
<b>26D</b> Satin chrome	<b>RP</b> Round	\$ 332.00	\$ 350.00	\$ 155.00	\$ 1,100.00
	<b>RQ</b> Square	\$ 463.00	\$ 480.00	\$ 236.00	\$ 1,238.00

**Retail price**

Finish	Escutcheon	Function PGE	PCY	DMY R/L Single	DMY R/L Pair	ML-F Entry
<b>26</b> Polished chrome	<b>EP</b> Oval	\$ 683.00	\$ 696.00	\$ 330.00	\$ 607.00	\$ 1,037.00
	<b>ER</b> Rectangular	\$ 734.00	\$ 747.00	\$ 369.00	\$ 671.00	\$ 1,075.00
<b>26D</b> Satin chrome	<b>EP</b> Oval	\$ 683.00	\$ 696.00	\$ 330.00	\$ 607.00	\$ 1,037.00
	<b>ER</b> Rectangular	\$ 734.00	\$ 747.00	\$ 369.00	\$ 671.00	\$ 1,075.00

The options listed above are considered standard. Non-standard options are available upon request.

For more options on Rosettes and Escutcheon plates see page 23. For more options on Finishes see pages 12-13.

RE = Rectangular rosettes available for tubular latch application only. Add + \$ 30.00 LIST to the price of the RQ.

For slim rosette and European version see pages 100-103.

**Upcharges apply for the following special options:**

- Extra thick door (> 2")
- Non-standard rosettes (rosettes not listed above)
- Non-standard finishes (finishes not listed above)
- Split finishes

See page 17 for pricing. Exclusions may apply.

**Matching elements**

Pg 168 Mortise lock functions  
 Pg 152 Deadbolts  
 Pg 154 Privacy Bolts  
 Pg 156 Escutcheons with deadbolts  
 Pg 160 Multi-Point Trim functions

European window lever style available in the same design. Call for pricing.



# H 411

## Leila

PRESTO

Material: Brass  
 Collection: Lab  
 Group: 4

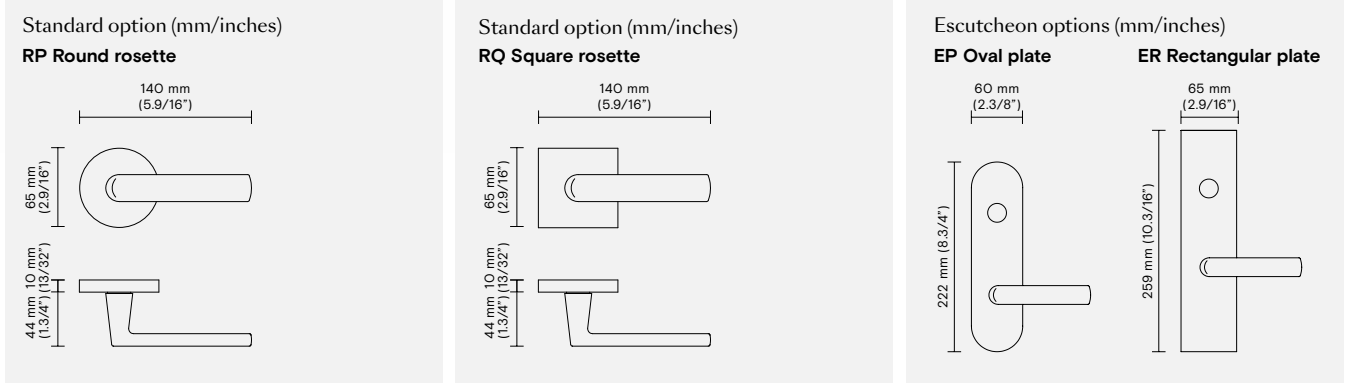

Slim rosette available - See pages 102-103

Conversions from metric to U.S. measurements are approximate.

### Retail price

Finish	Rosette	Function PGE	PCY	DMY R/L Single	ML-F Entry
16 Dull black	RP Round	\$ 223.00	\$ 226.00	\$ 113.00	\$ 924.00
	RQ Square	\$ 321.00	\$ 323.00	\$ 172.00	\$ 1,062.00
26 Polished chrome	RP Round	\$ 223.00	\$ 226.00	\$ 113.00	\$ 924.00
	RQ Square	\$ 321.00	\$ 323.00	\$ 172.00	\$ 1,062.00
26D Satin chrome	RP Round	\$ 223.00	\$ 226.00	\$ 113.00	\$ 924.00
	RQ Square	\$ 321.00	\$ 323.00	\$ 172.00	\$ 1,062.00

### Retail price

Finish	Escutcheon	Function PGE	PCY	DMY R/L Single	DMY R/L Pair	ML-F Entry
26 Polished chrome	EP Oval	\$ 481.00	\$ 494.00	\$ 254.00	\$ 430.00	\$ 859.00
	ER Rectangular	\$ 558.00	\$ 570.00	\$ 267.00	\$ 481.00	\$ 899.00
26D Satin chrome	EP Oval	\$ 481.00	\$ 494.00	\$ 254.00	\$ 430.00	\$ 859.00
	ER Rectangular	\$ 558.00	\$ 570.00	\$ 267.00	\$ 481.00	\$ 899.00

The options listed above are considered standard. Non-standard options are available upon request.

For more options on Rosettes and Escutcheon plates see page 23. For more options on Finishes see pages 12-13.

RE = Rectangular rosettes available for tubular latch application only. Add + \$ 30.00 LIST to the price of the RQ

Upcharges apply for the following special options:

- Extra thick door (> 2")
- Non-standard rosettes (rosettes not listed above)
- Non-standard finishes (finishes not listed above)
- Split finishes

See page 17 for pricing. Exclusions may apply.

Matching elements

- Pg 168 Mortise lock functions
- Pg 152 Deadbolts
- Pg 154 Privacy Bolts
- Pg 156 Escutcheons with deadbolts
- Pg 160 Multi-Point Trim functions

Window lever available in the same design, Call for pricing.



# H 414 Amber

Material	Collection	Group
Stainless steel AISI 304	Lab	4

### Standard option (mm/inches)

#### RPS Round rosette

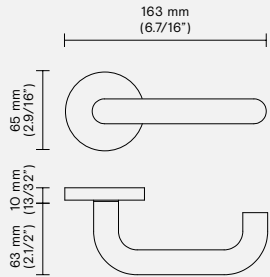

### Standard option (mm/inches)

#### RQS Square rosette

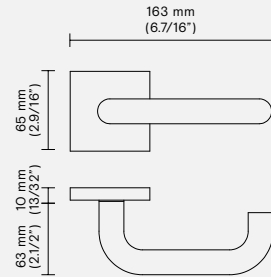

### Escutcheon options (mm/inches)

#### EP Oval plate

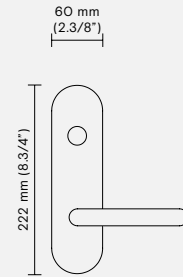

#### ER Rectangular plate

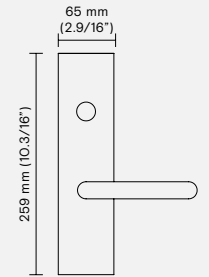

Conversions from metric to U.S. measurements are approximate.

### Retail price

Finish	Rosette	Function PGE	PCY	DMY R/L Single	ML-F Entry
32D Satin stainless steel	RPS Round	\$ 196.00	\$ 214.00	\$ 102.00	\$ 1,176.00
	RQS Square	\$ 304.00	\$ 323.00	\$ 161.00	\$ 1,188.00

### Retail price

Finish	Escutcheon	Function PGE	PCY	DMY R/L Single	DMY R/L Pair	ML-F Entry
32D Satin stainless steel	EPS Oval	\$ 481.00	\$ 494.00	\$ 254.00	\$ 430.00	\$ 859.00
	ERS Rectangular	\$ 558.00	\$ 570.00	\$ 267.00	\$ 481.00	\$ 899.00

The options listed above are considered standard.  
Non-standard options are available upon request.

For more options on Rosettes and Escutcheon plates see page 23.  
For more options on Finishes see pages 12-13.

RE = Rectangular rosettes available for tubular latch application only.  
Add + \$ 30.00 LIST to the price of the RQ

#### Upcharges apply for the following special options:

- Extra thick door (> 2")
- Non-standard rosettes (rosettes not listed above)
- Non-standard finishes (finishes not listed above)
- Split finishes

See page 17 for pricing. Exclusions may apply.

#### Matching elements

- Pg 168 Mortise lock functions
- Pg 152 Deadbolts
- Pg 154 Privacy Bolts
- Pg 156 Escutcheons with deadbolts
- Pg 160 Multi-Point Trim functions

Window lever available in the same design. Call for pricing.



# H 415 Scarlet

Material	Collection	Group
Stainless steel AISI 304	Lab	4

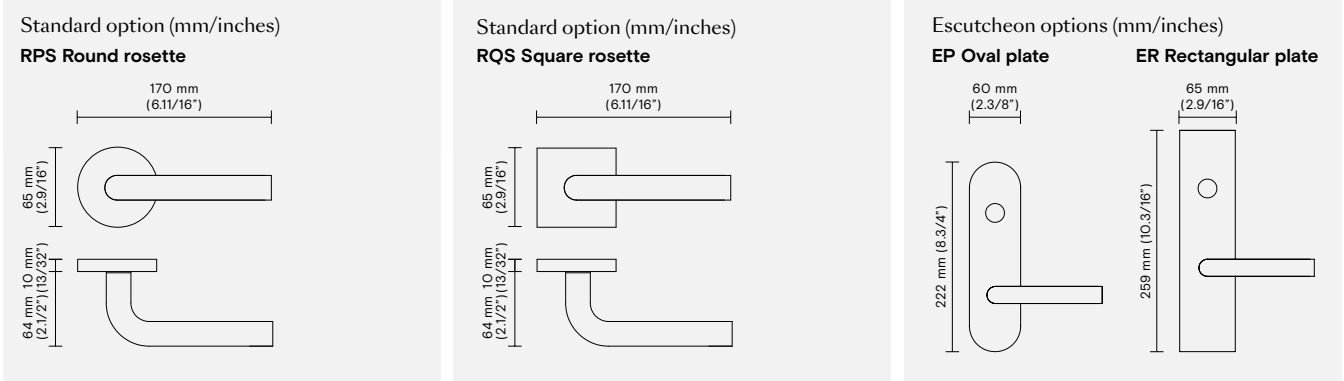

Conversions from metric to U.S. measurements are approximate.

### Retail price

Finish	Rosette	Function PGE	PCY	DMY R/L Single	ML-F Entry
32D Satin stainless steel	RPS Round	\$ 196.00	\$ 214.00	\$ 102.00	\$ 1,176.00
	RQS Square	\$ 304.00	\$ 323.00	\$ 161.00	\$ 1,188.00

### Retail price

Finish	Escutcheon	Function PGE	PCY	DMY R/L Single	DMY R/L Pair	ML-F Entry
32D Satin stainless steel	EPS Oval	\$ 481.00	\$ 494.00	\$ 254.00	\$ 430.00	\$ 859.00
	ERS Rectangular	\$ 558.00	\$ 570.00	\$ 267.00	\$ 481.00	\$ 899.00

The options listed above are considered standard.  
Non-standard options are available upon request.

For more options on Rosettes and Escutcheon plates see page 23.  
For more options on Finishes see pages 12-13.

RE = Rectangular rosettes available for tubular latch application only.  
Add + \$ 30.00 LIST to the price of the RQ

#### Upcharges apply for the following special options:

- Extra thick door (> 2")
- Non-standard rosettes (rosettes not listed above)
- Non-standard finishes (finishes not listed above)
- Split finishes

See page 17 for pricing. Exclusions may apply.

#### Matching elements

- Pg 168 Mortise lock functions
- Pg 152 Deadbolts
- Pg 154 Privacy Bolts
- Pg 156 Escutcheons with deadbolts
- Pg 160 Multi-Point Trim functions

Window lever available in the same design, Call for pricing.



# H 416 Garnet

Material	Collection	Group
Stainless steel AISI 304	Lab	4

### Standard option (mm/inches)

#### RPS Round rosette

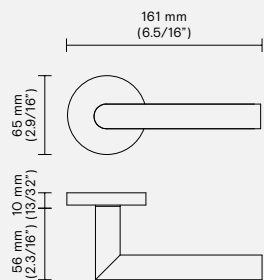

### Standard option (mm/inches)

#### RQS Square rosette

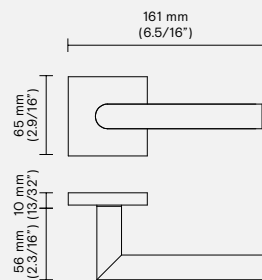

### Escutcheon options (mm/inches)

#### EP Oval plate

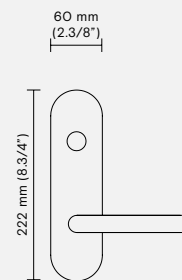

#### ER Rectangular plate

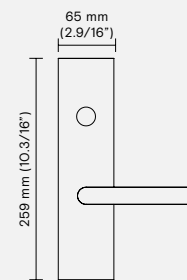

Conversions from metric to U.S. measurements are approximate.

### Retail price

Finish	Rosette	Function PGE	PCY	DMY R/L Single	ML-F Entry
32D Satin stainless steel	RPS Round	\$ 196.00	\$ 214.00	\$ 102.00	\$ 1,176.00
	RQS Square	\$ 304.00	\$ 323.00	\$ 161.00	\$ 1,188.00

### Retail price

Finish	Escutcheon	Function PGE	PCY	DMY R/L Single	DMY R/L Pair	ML-F Entry
32D Satin stainless steel	EPS Oval	\$ 481.00	\$ 494.00	\$ 254.00	\$ 430.00	\$ 859.00
	ERS Rectangular	\$ 583.00	\$ 620.00	\$ 293.00	\$ 520.00	\$ 999.00

The options listed above are considered standard.  
Non-standard options are available upon request.

For more options on Rosettes and Escutcheon plates see page 23.  
For more options on Finishes see pages 12-13.

RE = Rectangular rosettes available for tubular latch application only.  
Add + \$ 30.00 LIST to the price of the RQ

#### Upcharges apply for the following special options:

- Extra thick door (> 2")
- Non-standard rosettes (rosettes not listed above)
- Non-standard finishes (finishes not listed above)
- Split finishes

See page 17 for pricing. Exclusions may apply.

#### Matching elements

- Pg 168 Mortise lock functions
- Pg 152 Deadbolts
- Pg 154 Privacy Bolts
- Pg 156 Escutcheons with deadbolts
- Pg 160 Multi-Point Trim functions

Window lever available in the same design. Call for pricing.



# H 419

## Bordeaux

Material	Collection	Group
Stainless steel AISI 304	Lab	4

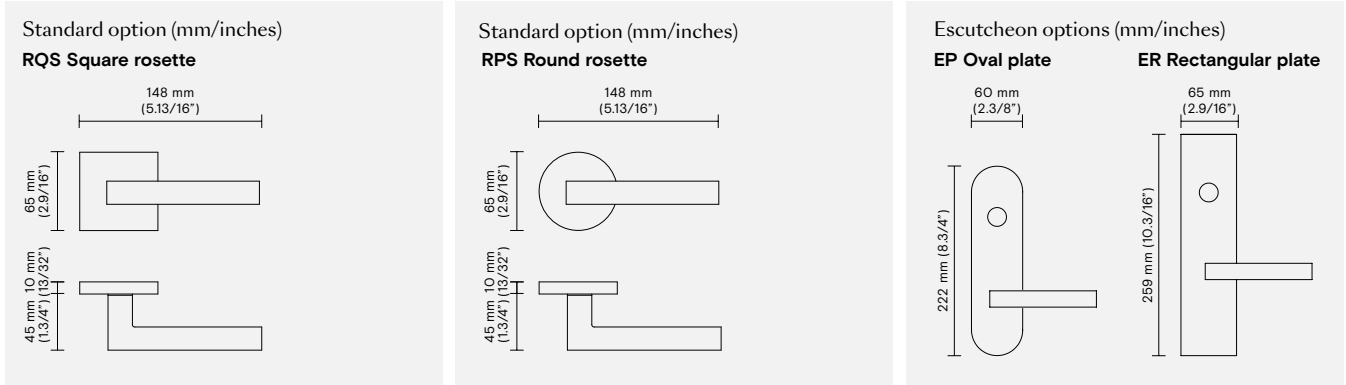

Conversions from metric to U.S. measurements are approximate.

### Retail price

Finish	Rosette	Function PGE	PCY	DMY R/L Single	ML-F Entry
32D Satin stainless steel	RPS Round	\$ 223.00	\$ 226.00	\$ 113.00	\$ 1,176.00
	RQS Square	\$ 304.00	\$ 323.00	\$ 175.00	\$ 1,188.00

### Retail price

Finish	Escutcheon	Function PGE	PCY	DMY R/L Single	DMY R/L Pair	ML-F Entry
32D Satin stainless steel	EPS Oval	\$ 481.00	\$ 494.00	\$ 254.00	\$ 430.00	\$ 859.00
	ERS Rectangular	\$ 583.00	\$ 620.00	\$ 293.00	\$ 520.00	\$ 999.00

The options listed above are considered standard.  
Non-standard options are available upon request.

For more options on Rosettes and Escutcheon plates see page 23.  
For more options on Finishes see pages 12-13.

RE = Rectangular rosettes available for tubular latch application only.  
Add + \$ 30.00 LIST to the price of the RQ

#### Upcharges apply for the following special options:

- Extra thick door (> 2")
- Non-standard rosettes (rosettes not listed above)
- Non-standard finishes (finishes not listed above)
- Split finishes

See page 17 for pricing. Exclusions may apply.

#### Matching elements

- Pg 168 Mortise lock functions
- Pg 152 Deadbolts
- Pg 154 Privacy Bolts
- Pg 156 Escutcheons with deadbolts
- Pg 160 Multi-Point Trim functions

Window lever available in the same design, Call for pricing.



# H 1003 Matteo Thun

Material	Collection	Group
Brass	Fusital	1

Standard option (mm/inches)

**RP Round rosette**

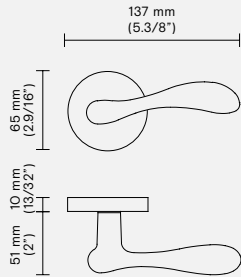

Standard option (mm/inches)

**RQ Square rosette**

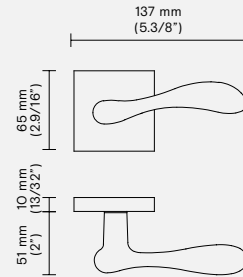

Escutcheon options (mm/inches)

**EP Oval plate**

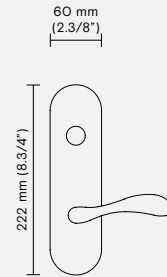

**ER Rectangular plate**

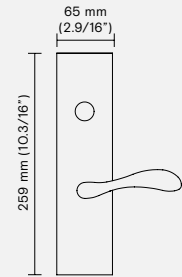

**Slim rosette** available - See pages 102-103

Conversions from metric to U.S. measurements are approximate.

**Retail price**

Finish	Rosette	Function PGE	PCY	DMY R/L Single	ML-F Entry
<b>03</b> Polished brass	<b>RP</b> Round	\$ 310.00	\$ 329.00	\$ 143.00	\$ 961.00
	<b>RQ</b> Square	\$ 429.00	\$ 448.00	\$ 202.00	\$ 1,100.00
<b>14</b> Polished nickel	<b>RP</b> Round	\$ 342.00	\$ 371.00	\$ 161.00	\$ 961.00
	<b>RQ</b> Square	\$ 461.00	\$ 490.00	\$ 221.00	\$ 1,100.00
<b>15</b> Satin nickel	<b>RP</b> Round	\$ 332.00	\$ 348.00	\$ 152.00	\$ 961.00
	<b>RQ</b> Square	\$ 451.00	\$ 467.00	\$ 211.00	\$ 1,100.00
<b>26/26D</b> Polished chrome / Satin chrome*	<b>RP</b> Round	\$ 328.00	\$ 342.00	\$ 151.00	\$ 961.00
	<b>RQ</b> Square	\$ 447.00	\$ 461.00	\$ 210.00	\$ 1,100.00

**Retail price**

Finish	Escutcheon	Function PGE	PCY	DMY R/L Single	DMY R/L Pair	ML-F Entry
<b>26/26D</b> Polished chrome / Satin chrome*	<b>EP</b> Oval	\$ 520.00	\$ 545.00	\$ 254.00	\$ 455.00	\$ 899.00
	<b>ER</b> Rectangular	\$ 570.00	\$ 596.00	\$ 279.00	\$ 506.00	\$ 935.00

\* **Note:** The shank portion is polished while the length of the lever is satin. The rosette/escutcheon is polished.

The options listed above are considered standard. Non-standard options are available upon request.

For more options on Rosettes and Escutcheon plates see page 23. For more options on Finishes see pages 12-13.

RE = Rectangular rosettes available for tubular latch application only. Add + \$ 30.00 LIST to the price of the RQ. For slim rosette and European version see pages 100-103.

Upcharges apply for the following special options:

- Extra thick door (> 2")
- Non-standard rosettes (rosettes not listed above)
- Non-standard finishes (finishes not listed above)
- Split finishes

See page 17 for pricing. Exclusions may apply.

**Matching elements**

- Pg 168 Mortise lock functions
- Pg 152 Deadbolts
- Pg 154 Privacy Bolts
- Pg 156 Escutcheons with deadbolts
- Pg 160 Multi-Point Trim functions

European window lever style available in the same design. Call for pricing.



# H 1004 Antares

Material  
Brass

Collection  
Lab

Group  
4

### Standard option (mm/inches) RT Traditional rosette

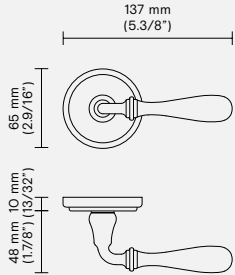

### Standard option (mm/inches) RQ Square rosette

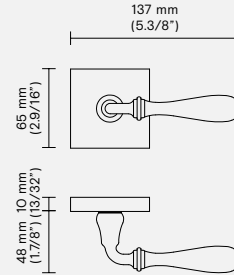

### Escutcheon options (mm/inches)\*

#### EP Oval plate

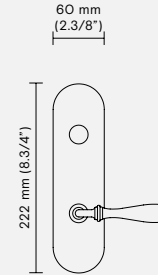

#### ER Rectangular plate

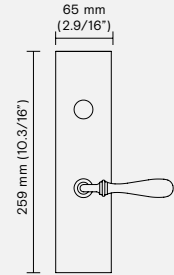

Conversions from metric to U.S. measurements are approximate.

\*Only available on request

### Retail price

Finish	Rosette	Function PGE	PCY	DMY R/L Single	ML-F Entry
O3D Satin brass	RT Traditional	\$ 223.00	\$ 226.00	\$ 113.00	\$ 924.00
	RQ Square	\$ 321.00	\$ 323.00	\$ 172.00	\$ 1,062.00
O6B Brunito	RT Traditional	\$ 223.00	\$ 226.00	\$ 113.00	\$ 924.00
	RQ Square	\$ 321.00	\$ 323.00	\$ 172.00	\$ 1,062.00

Note: This lever is also available with RP Round Rosette. Same price as RT Traditional Rosette.

The options listed above are considered standard.  
Non-standard options are available upon request.

For more options on Rosettes and Escutcheon plates see page 23.  
For more options on Finishes see pages 12-13.

RE = Rectangular rosettes available for tubular latch application only.  
Add + \$ 30.00 LIST to the price of the RQ

#### Upcharges apply for the following special options:

- Extra thick door (> 2")
- Non-standard rosettes (rosettes not listed above)
- Non-standard finishes (finishes not listed above)
- Split finishes

See page 17 for pricing. Exclusions may apply.

#### Matching elements

- Pg 168 Mortise lock functions
- Pg 152 Deadbolts
- Pg 154 Privacy Bolts
- Pg 156 Escutcheons with deadbolts
- Pg 160 Multi-Point Trim functions

Window lever available in the same design, Call for pricing.



# H 1016 Nabucco

Material	Collection	Group
Brass	Lab	2

### Standard option (mm/inches)

#### RP Round rosette

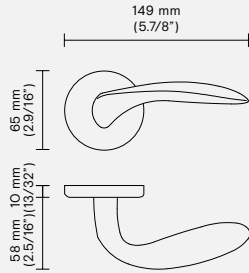

### Standard option (mm/inches)

#### RQ Square rosette

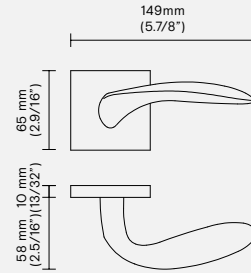

### Escutcheon options (mm/inches)

#### EP Oval plate

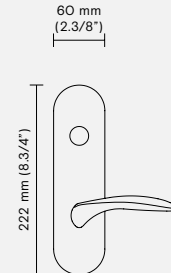

#### ER Rectangular plate

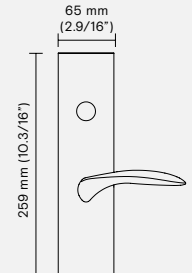

Conversions from metric to U.S. measurements are approximate.

### Retail price

Finish	Rosette	Function		DMY R/L Single	ML-F Entry
		PGE	PCY		
15 Satin nickel	RP Round	\$ 396.00	\$ 426.00	\$ 191.00	\$ 1,037.00
	RQ Square	\$ 515.00	\$ 545.00	\$ 250.00	\$ 1,176.00
26 Polished chrome	RP Round	\$ 360.00	\$ 391.00	\$ 172.00	\$ 1,037.00
	RQ Square	\$ 479.00	\$ 510.00	\$ 232.00	\$ 1,176.00

### Retail price

Finish	Escutcheon	Function		DMY R/L Single	DMY R/L Pair	ML-F Entry
		PGE	PCY			
26 Polished chrome	EP Oval	\$ 596.00	\$ 633.00	\$ 293.00	\$ 549.00	\$ 974.00
	ER Rectangular	\$ 645.00	\$ 658.00	\$ 318.00	\$ 583.00	\$ 1,010.00

The options listed above are considered standard. Non-standard options are available upon request.

For more options on Rosettes and Escutcheon plates see page 23. For more options on Finishes see pages 12-13.

RE = Rectangular rosettes available for tubular latch application only. Add + \$ 30.00 LIST to the price of the RQ. For slim rosette and European version see pages 100-103.

#### Upcharges apply for the following special options:

- Extra thick door (> 2")
- Non-standard rosettes (rosettes not listed above)
- Non-standard finishes (finishes not listed above)
- Split finishes

See page 17 for pricing. Exclusions may apply.

#### Matching elements

- Pg 168 Mortise lock functions
- Pg 152 Deadbolts
- Pg 154 Privacy Bolts
- Pg 156 Escutcheons with deadbolts
- Pg 160 Multi-Point Trim functions

European window lever style available in the same design. Call for pricing.



# H 1022

## Ernani

Material  
Brass

Collection  
Lab

Group  
1

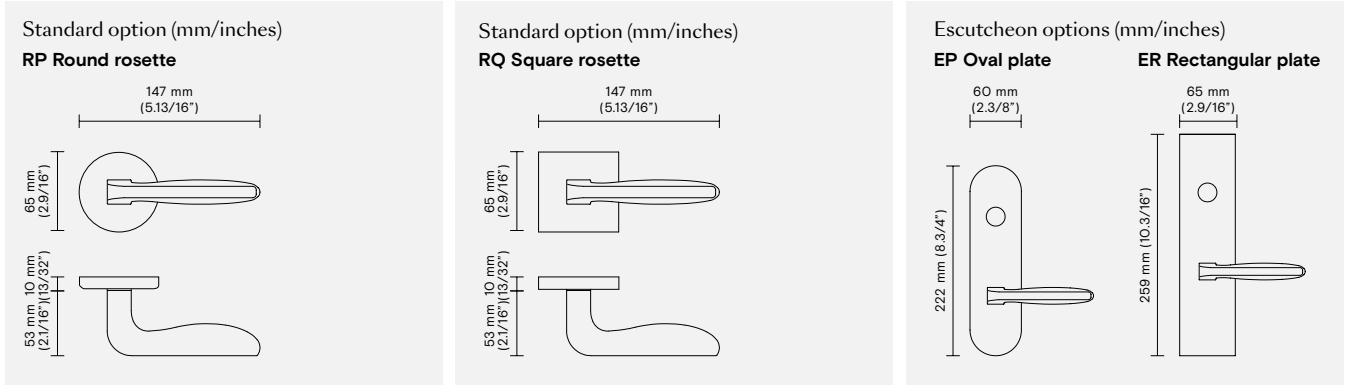

Slim rosette available - See pages 102-103

Conversions from metric to U.S. measurements are approximate.

### Retail price

Finish	Rosette	Function PGE	PCY	DMY R/L Single	ML-F Entry
03/O3D Polished brass / Satin brass*	RP Round	\$ 388.00	\$ 412.00	\$ 185.00	\$ 961.00
	RQ Square	\$ 507.00	\$ 531.00	\$ 245.00	\$ 1,100.00
26D/26 Satin chrome / Polished chrome*	RP Round	\$ 376.00	\$ 393.00	\$ 177.00	\$ 961.00
	RQ Square	\$ 495.00	\$ 511.00	\$ 236.00	\$ 1,100.00

### Retail price

Finish	Escutcheon	Function PGE	PCY	DMY R/L Single	DMY R/L Pair	ML-F Entry
26D/26 Satin chrome / Polished chrome*	EP Oval	\$ 520.00	\$ 545.00	\$ 254.00	\$ 455.00	\$ 899.00
	ER Rectangular	\$ 570.00	\$ 596.00	\$ 279.00	\$ 506.00	\$ 935.00

\* In the 03/O3D version, the front and side edge of the lever are satin, while the rest of the lever is polished. The rosette/escutcheon is polished.  
 In the 26/26D version, the front and side edge of the lever are polished, while the rest of the lever is satin. The rosette/escutcheon is satin.

The options listed above are considered standard.  
 Non-standard options are available upon request.

For more options on Rosettes and Escutcheon plates see page 23.  
 For more options on Finishes see pages 12-13.

RE = Rectangular rosettes available for tubular latch application only.  
 Add + \$ 30.00 LIST to the price of the RQ.  
 For slim rosette and European version see pages 100-103.

Upcharges apply for the following special options:

- Extra thick door (> 2")
- Non-standard rosettes (rosettes not listed above)
- Non-standard finishes (finishes not listed above)
- Split finishes

See page 17 for pricing. Exclusions may apply.

#### Matching elements

- Pg 168 Mortise lock functions
- Pg 152 Deadbolts
- Pg 154 Privacy Bolts
- Pg 156 Escutcheons with deadbolts
- Pg 160 Multi-Point Trim functions

European window lever style available in the same design.  
 Call for pricing.



# H 1024

## Lolita

Material	Collection	Group
Brass	Lab	1

Standard option (mm/inches)

**RP Round rosette**

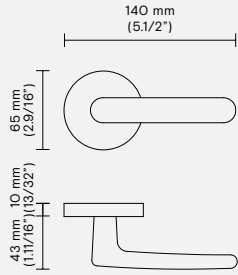

Standard option (mm/inches)

**RQ Square rosette**

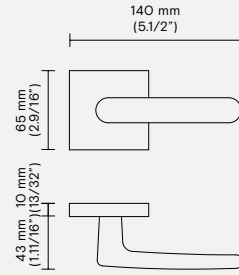

Escutcheon options (mm/inches)

**EP Oval plate**

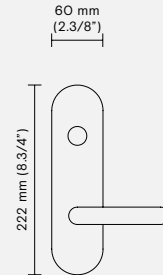

**ER Rectangular plate**

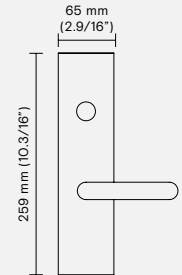

Slim rosette available - See pages 102-103

Conversions from metric to U.S. measurements are approximate.

**Retail price**

Finish	Rosette	Function PGE	PCY	DMY R/L Single	ML-F Entry
03 Polished brass	RP Round	\$ 282.00	\$ 310.00	\$ 130.00	\$ 961.00
	RQ Square	\$ 401.00	\$ 429.00	\$ 189.00	\$ 1,100.00
26 Polished chrome	RP Round	\$ 276.00	\$ 292.00	\$ 125.00	\$ 961.00
	RQ Square	\$ 395.00	\$ 411.00	\$ 184.00	\$ 1,100.00
26D Satin chrome	RP Round	\$ 290.00	\$ 308.00	\$ 134.00	\$ 961.00
	RQ Square	\$ 409.00	\$ 427.00	\$ 194.00	\$ 1,100.00

**Retail price**

Finish	Escutcheon	Function PGE	PCY	DMY R/L Single	DMY R/L Pair	ML-F Entry
26 Polished chrome	EP Oval	\$ 520.00	\$ 545.00	\$ 254.00	\$ 455.00	\$ 899.00
	ER Rectangular	\$ 570.00	\$ 596.00	\$ 279.00	\$ 506.00	\$ 935.00
26D Satin chrome	EP Oval	\$ 520.00	\$ 545.00	\$ 254.00	\$ 455.00	\$ 899.00
	ER Rectangular	\$ 570.00	\$ 596.00	\$ 279.00	\$ 506.00	\$ 935.00

The options listed above are considered standard. Non-standard options are available upon request.

For more options on Rosettes and Escutcheon plates see page 23. For more options on Finishes see pages 12-13.

RE = Rectangular rosettes available for tubular latch application only. Add + \$ 30.00 LIST to the price of the RQ. For slim rosette and European version see pages 100-103.

**Upcharges apply for the following special options:**

- Extra thick door (> 2")
- Non-standard rosettes (rosettes not listed above)
- Non-standard finishes (finishes not listed above)
- Split finishes

See page 17 for pricing. Exclusions may apply.

**Matching elements**

- Pg 168 Mortise lock functions
- Pg 152 Deadbolts
- Pg 154 Privacy Bolts
- Pg 156 Escutcheons with deadbolts
- Pg 160 Multi-Point Trim functions

European window lever style available in the same design. Call for pricing.



# H 1026

## Antonio Bullo

Material	Collection	Group
Brass	Fusital	2

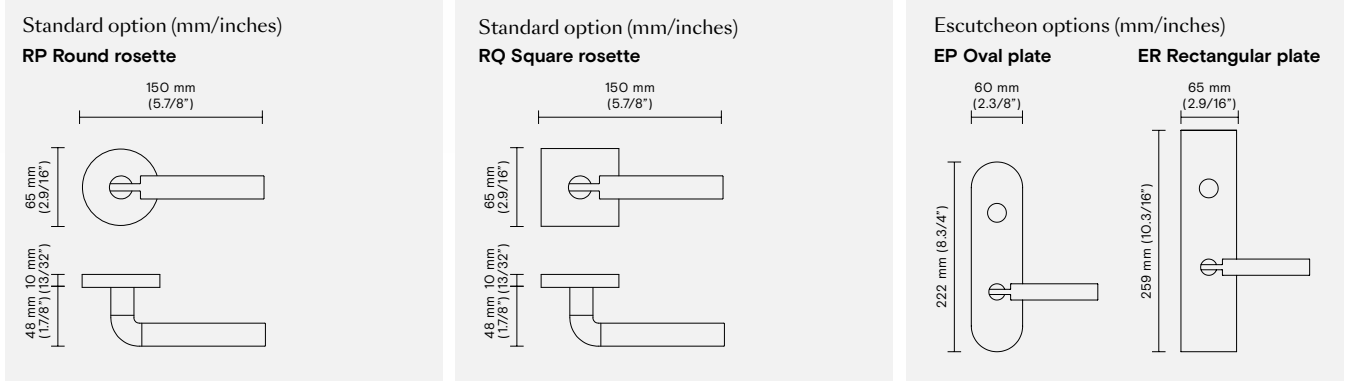

Slim rosette available - See pages 102-103

Conversions from metric to U.S. measurements are approximate.

### Retail price

Finish	Rosette	Function PGE	PCY	DMY R/L Single	ML-F Entry
03/03D Polished brass / Satin brass*	RP Round	\$ 374.00	\$ 413.00	\$ 183.00	\$ 1,037.00
	RQ Square	\$ 493.00	\$ 532.00	\$ 243.00	\$ 1,176.00
26/26D Polished chrome / Satin chrome*	RP Round	\$ 381.00	\$ 415.00	\$ 183.00	\$ 1,037.00
	RQ Square	\$ 499.00	\$ 555.00	\$ 243.00	\$ 1,176.00

### Retail price

Finish	Escutcheon	Function PGE	PCY	DMY R/L Single	DMY R/L Pair	ML-F Entry
26/26D Polished chrome / Satin chrome*	EP Oval	\$ 596.00	\$ 633.00	\$ 293.00	\$ 549.00	\$ 974.00
	ER Rectangular	\$ 645.00	\$ 658.00	\$ 318.00	\$ 583.00	\$ 1,010.00

\* Note: The curved shank portion is polished, while the base and the length of the grip are satin. The rosette/escutcheon is satin.

The options listed above are considered standard. Non-standard options are available upon request.

For more options on Rosettes and Escutcheon plates see page 23. For more options on Finishes see pages 12-13.

RE = Rectangular rosettes available for tubular latch application only. Add + \$ 30.00 LIST to the price of the RQ. For slim rosette and European version see pages 100-103.

Upcharges apply for the following special options:

- Extra thick door (> 2")
- Non-standard rosettes (rosettes not listed above)
- Non-standard finishes (finishes not listed above)
- Split finishes

See page 17 for pricing. Exclusions may apply.

### Matching elements

- Pg 168 Mortise lock functions
- Pg 152 Deadbolts
- Pg 154 Privacy Bolts
- Pg 156 Escutcheons with deadbolts
- Pg 160 Multi-Point Trim functions

European window lever style available in the same design. Call for pricing.



# H 1027 Dafne

Material	Collection	Group
Brass	Lab	2

### Standard option (mm/inches)

#### RP Round rosette

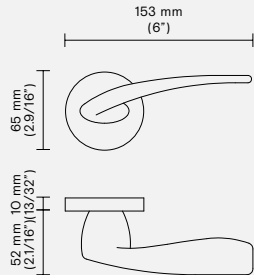

### Standard option (mm/inches)

#### RQ Square rosette

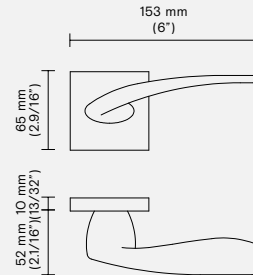

### Escutcheon options (mm/inches)

#### EP Oval plate

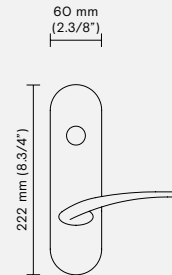

#### ER Rectangular plate

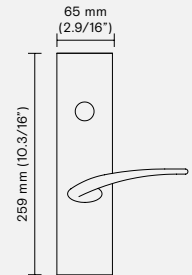

Conversions from metric to U.S. measurements are approximate.

### Retail price

Finish	Rosette	Function PGE	PCY*	DMY R/L Single	ML-F Entry
03 Polished brass	RP Round	\$ 369.00	\$ 674.00	\$ 172.00	\$ 1,037.00
	RQ Square	\$ 488.00	\$ 793.00	\$ 232.00	\$ 1,176.00
26D Satin chrome	RP Round	\$ 377.00	\$ 728.00	\$ 175.00	\$ 1,037.00
	RQ Square	\$ 496.00	\$ 847.00	\$ 235.00	\$ 1,176.00

\* If it does not fit a privacy pin, supplied with 105 privacy bolt.

### Retail price

Finish	Escutcheon	Function PGE	PCY	DMY R/L Single	DMY R/L Pair	ML-F Entry
26D Satin chrome	EP Oval	\$ 596.00	\$ 633.00	\$ 293.00	\$ 549.00	\$ 974.00
	ER Rectangular	\$ 645.00	\$ 658.00	\$ 318.00	\$ 583.00	\$ 1,010.00

The options listed above are considered standard. Non-standard options are available upon request.

For more options on Rosettes and Escutcheon plates see page 23. For more options on Finishes see pages 12-13.

RE = Rectangular rosettes available for tubular latch application only. Add + \$ 30.00 LIST to the price of the RQ. For slim rosette and European version see pages 100-103.

#### Upcharges apply for the following special options:

- Extra thick door (> 2")
- Non-standard rosettes (rosettes not listed above)
- Non-standard finishes (finishes not listed above)
- Split finishes

See page 17 for pricing. Exclusions may apply.

#### Matching elements

- Pg 168 Mortise lock functions
- Pg 152 Deadbolts
- Pg 154 Privacy Bolts
- Pg 156 Escutcheons with deadbolts
- Pg 160 Multi-Point Trim functions

European window lever style available in the same design. Call for pricing.



# H 1037

## Teseo

Material  
Brass

Collection  
Lab

Group  
4

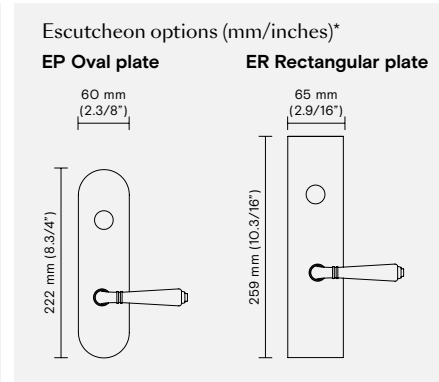
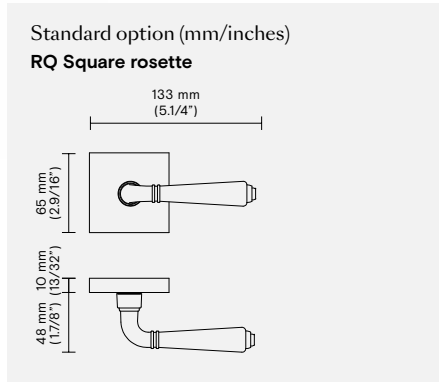
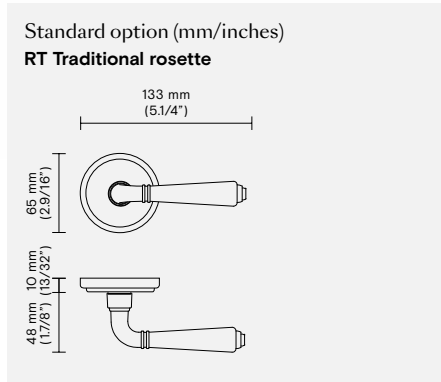

Conversions from metric to U.S. measurements are approximate.

\*Only available on request

### Retail price

Finish	Rosette	Function PGE	PCY	DMY R/L Single	ML-F Entry
<b>03</b> Polished brass	<b>RT</b> Traditional	\$ 223.00	\$ 226.00	\$ 113.00	\$ 924.00
	<b>RQ</b> Square	\$ 321.00	\$ 323.00	\$ 172.00	\$ 1,062.00
<b>14</b> Polished nickel	<b>RT</b> Traditional	\$ 223.00	\$ 226.00	\$ 113.00	\$ 924.00
	<b>RQ</b> Square	\$ 321.00	\$ 323.00	\$ 172.00	\$ 1,062.00
<b>15</b> Satin nickel	<b>RT</b> Traditional	\$ 223.00	\$ 226.00	\$ 113.00	\$ 924.00
	<b>RQ</b> Square	\$ 321.00	\$ 323.00	\$ 172.00	\$ 1,062.00

**Note:** This lever is also available with RP Round Rosette. Same price as RT Traditional Rosette.

The options listed above are considered standard.  
Non-standard options are available upon request.

For more options on Rosettes and Escutcheon plates see page 23.  
For more options on Finishes see pages 12-13.

RE = Rectangular rosettes available for tubular latch application only.  
Add + \$ 30.00 LIST to the price of the RQ

#### Upcharges apply for the following special options:

- Extra thick door (> 2")
- Non-standard rosettes (rosettes not listed above)
- Non-standard finishes (finishes not listed above)
- Split finishes

See page 17 for pricing. Exclusions may apply.

#### Matching elements

- Pg 168 Mortise lock functions
- Pg 152 Deadbolts
- Pg 154 Privacy Bolts
- Pg 156 Escutcheons with deadbolts
- Pg 160 Multi-Point Trim functions

Window lever available in the same design, Call for pricing.



# H 1039

## Jean-Baptiste Sibertin Blanc

Material	Collection	Group
Brass	Fusital	3

### Standard option (mm/inches)

#### RP Round rosette

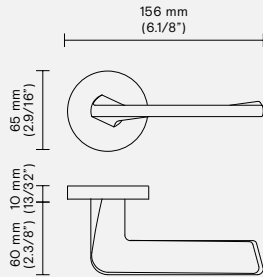

### Standard option (mm/inches)

#### RQ Square rosette

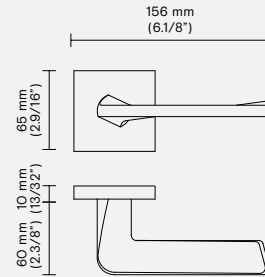

### Escutcheon options (mm/inches)

#### EP Oval plate

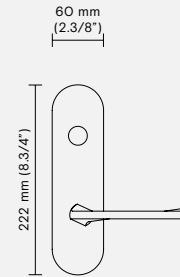

#### ER Rectangular plate

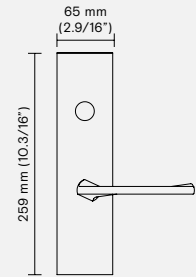

**Slim rosette** available - See pages 102-103

Conversions from metric to U.S. measurements are approximate.

### Retail price

Finish	Rosette	Function PGE	PCY	DMY R/L Single	ML-F Entry
<b>14</b> Polished nickel	<b>RP</b> Round	\$ 378.00	\$ 417.00	\$ 184.00	\$ 1,251.00
	<b>RQ</b> Square	\$ 497.00	\$ 536.00	\$ 243.00	\$ 1,389.00
<b>15</b> Satin nickel	<b>RP</b> Round	\$ 378.00	\$ 417.00	\$ 184.00	\$ 1,251.00
	<b>RQ</b> Square	\$ 497.00	\$ 536.00	\$ 243.00	\$ 1,389.00
<b>26/26D</b> Polished chrome / Satin chrome*	<b>RP</b> Round	\$ 336.00	\$ 372.00	\$ 162.00	\$ 1,251.00
	<b>RQ</b> Square	\$ 455.00	\$ 491.00	\$ 222.00	\$ 1,389.00

### Retail price

Finish	Escutcheon	Function PGE	PCY	DMY R/L Single	DMY R/L Pair	ML-F Entry
<b>26/26D</b> Polished chrome / Satin chrome*	<b>EP</b> Oval	\$ 809.00	\$ 823.00	\$ 405.00	\$ 747.00	\$ 1,200.00
	<b>ER</b> Rectangular	\$ 859.00	\$ 873.00	\$ 430.00	\$ 798.00	\$ 1,226.00

\* **Note:** The front and side edges are polished, while the top and bottom surfaces are satin. The rosette/escutcheon is satin.

The options listed above are considered standard. Non-standard options are available upon request.

For more options on Rosettes and Escutcheon plates see page 23. For more options on Finishes see pages 12-13.

RE = Rectangular rosettes available for tubular latch application only. Add + \$ 30.00 LIST to the price of the RQ. For slim rosette and European version see pages 100-103.

#### Upcharges apply for the following special options:

- Extra thick door (> 2")
- Non-standard rosettes (rosettes not listed above)
- Non-standard finishes (finishes not listed above)
- Split finishes

See page 17 for pricing. Exclusions may apply.

#### Matching elements

- Pg 168 Mortise lock functions
- Pg 152 Deadbolts
- Pg 154 Privacy Bolts
- Pg 156 Escutcheons with deadbolts
- Pg 160 Multi-Point Trim functions

European window lever style available in the same design. Call for pricing.



# H 1040

Gabriele e Oscar Buratti

Material  
Brass

Collection  
Fusital

Group  
3

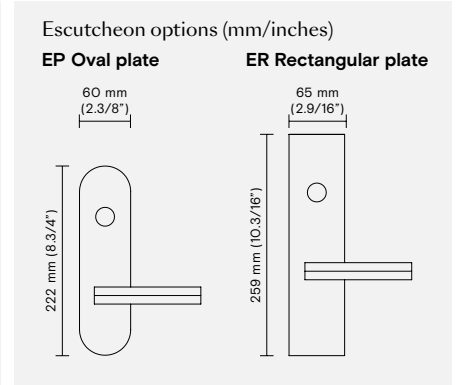
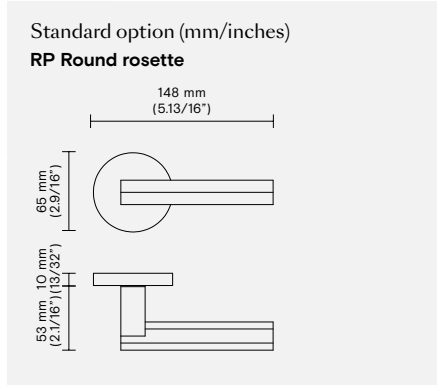
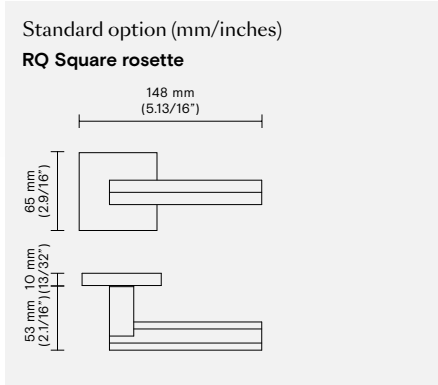

**Slim rosette** available - See pages 102-103

Conversions from metric to U.S. measurements are approximate.

## Retail price

Finish	Rosette	Function PGE	PCY	DMY R/L Single	ML-F Entry
15 Satin nickel	RP Round	\$ 672.00	\$ 697.00	\$ 336.00	\$ 1,251.00
	RQ Square	\$ 792.00	\$ 828.00	\$ 407.00	\$ 1,389.00
26 Polished chrome	RP Round	\$ 672.00	\$ 697.00	\$ 336.00	\$ 1,251.00
	RQ Square	\$ 792.00	\$ 828.00	\$ 407.00	\$ 1,389.00

## Retail price

Finish	Escutcheon	Function PGE	PCY	DMY R/L Single	DMY R/L Pair	ML-F Entry
26 Polished chrome	EP Oval	\$ 809.00	\$ 823.00	\$ 405.00	\$ 747.00	\$ 1,200.00
	ER Rectangular	\$ 859.00	\$ 873.00	\$ 430.00	\$ 798.00	\$ 1,226.00

**Note:** The lever grip has an octagonal shape.

The options listed above are considered standard.  
Non-standard options are available upon request.

For more options on Rosettes and Escutcheon plates see page 23.  
For more options on Finishes see pages 12-13.

RE = Rectangular rosettes available for tubular latch application only.  
Add + \$ 30.00 LIST to the price of the RQ.  
For slim rosette and European version see pages 100-103.

**Upcharges apply for the following special options:**

- Extra thick door (> 2")
- Non-standard rosettes (rosettes not listed above)
- Non-standard finishes (finishes not listed above)
- Split finishes

See page 17 for pricing. Exclusions may apply.

### Matching elements

- Pg 168 Mortise lock functions
- Pg 152 Deadbolts
- Pg 154 Privacy Bolts
- Pg 156 Escutcheons with deadbolts
- Pg 160 Multi-Point Trim functions

European window lever style available in the same design.  
Call for pricing.



# H 1043

## Matteo Thun

Material	Collection	Group
Zinc alloy	Fusital	4

Standard option (mm/inches)

**RP Round rosette**

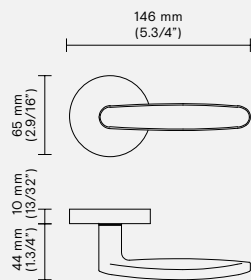

Standard option (mm/inches)

**RQ Square rosette**

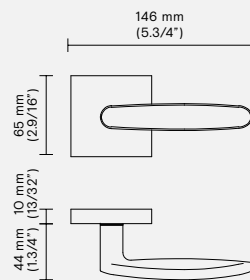

Escutcheon options (mm/inches)

**EP Oval plate**

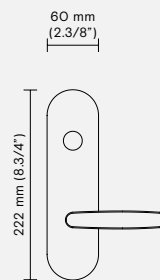

**ER Rectangular plate**

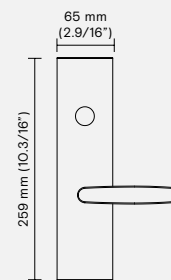

Slim rosette available - See pages 102-103

Conversions from metric to U.S. measurements are approximate.

**Retail price**

Finish	Rosette	Function PGE	PCY	DMY R/L Single	ML-F Entry
15 Satin nickel	RP Round	\$ 223.00	\$ 226.00	\$ 113.00	\$ 924.00
	RQ Square	\$ 321.00	\$ 323.00	\$ 172.00	\$ 1,062.00
26/26D Polished chrome / Satin chrome*	RP Round	\$ 223.00	\$ 226.00	\$ 113.00	\$ 924.00
	RQ Square	\$ 321.00	\$ 323.00	\$ 172.00	\$ 1,062.00

**Retail price**

Finish	Escutcheon	Function PGE	PCY	DMY R/L Single	DMY R/L Pair	ML-F Entry
26/26D Polished chrome / Satin chrome*	EP Oval	\$ 481.00	\$ 494.00	\$ 254.00	\$ 430.00	\$ 859.00
	ER Rectangular	\$ 558.00	\$ 570.00	\$ 267.00	\$ 481.00	\$ 899.00

\* Note: The lever is satin on its front face only, while the shank and the rest of the lever is polished. The rosette/escutcheon is polished.

The options listed above are considered standard. Non-standard options are available upon request.

For more options on Rosettes and Escutcheon plates see page 23. For more options on Finishes see pages 12-13.

RE = Rectangular rosettes available for tubular latch application only. Add + \$ 30.00 LIST to the price of the RQ

**Upcharges apply for the following special options:**

- Extra thick door (> 2")
- Non-standard rosettes (rosettes not listed above)
- Non-standard finishes (finishes not listed above)
- Split finishes

See page 17 for pricing. Exclusions may apply.

**Matching elements**

- Pg 168 Mortise lock functions
- Pg 152 Deadbolts
- Pg 154 Privacy Bolts
- Pg 156 Escutcheons with deadbolts
- Pg 160 Multi-Point Trim functions

Window lever available in the same design. Call for pricing.

# H 1044

## Vincent Van Duysen



Material	Collection	Group
Zinc alloy	Fusital	4

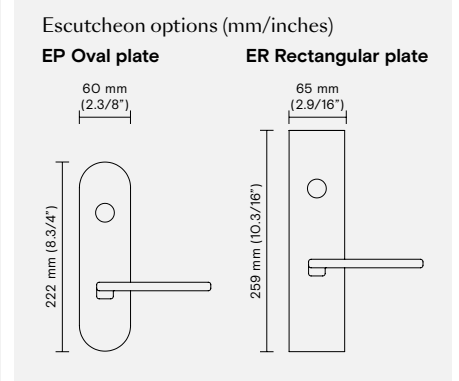
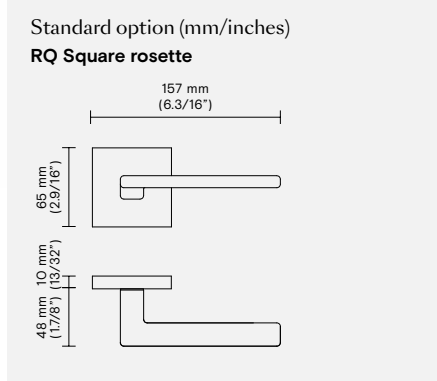
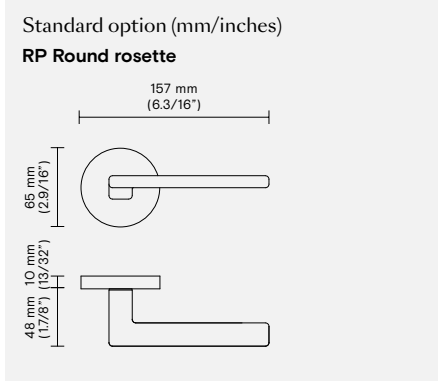

Slim rosette available - See pages 102-103

Conversions from metric to U.S. measurements are approximate.

**Retail price**

Finish	Rosette	Function PGE	PCY	DMY R/L Single	ML-F Entry
14 Polished nickel	RP Round	\$ 202.00	\$ 205.00	\$ 106.00	\$ 924.00
	RQ Square	\$ 306.00	\$ 308.00	\$ 164.00	\$ 1,062.00
15 Satin nickel	RP Round	\$ 202.00	\$ 205.00	\$ 106.00	\$ 924.00
	RQ Square	\$ 306.00	\$ 308.00	\$ 164.00	\$ 1,062.00
16 Dull black	RP Round	\$ 202.00	\$ 205.00	\$ 106.00	\$ 924.00
	RQ Square	\$ 306.00	\$ 308.00	\$ 164.00	\$ 1,062.00
26 Polished chrome	RP Round	\$ 202.00	\$ 205.00	\$ 106.00	\$ 924.00
	RQ Square	\$ 306.00	\$ 308.00	\$ 164.00	\$ 1,062.00
26D Satin chrome	RP Round	\$ 202.00	\$ 205.00	\$ 106.00	\$ 924.00
	RQ Square	\$ 306.00	\$ 308.00	\$ 164.00	\$ 1,062.00

Note: The H 1044 lever is also available with return on the smaller end, please see next page.

**Retail price**

Finish	Escutcheon	Function PGE	PCY	DMY R/L Single	DMY R/L Pair	ML-F Entry
26 Polished chrome	EP Oval	\$ 481.00	\$ 494.00	\$ 254.00	\$ 430.00	\$ 859.00
	ER Rectangular	\$ 558.00	\$ 570.00	\$ 267.00	\$ 481.00	\$ 899.00
26D Satin chrome	EP Oval	\$ 481.00	\$ 494.00	\$ 254.00	\$ 430.00	\$ 859.00
	ER Rectangular	\$ 558.00	\$ 570.00	\$ 267.00	\$ 481.00	\$ 899.00

The options listed above are considered standard. Non-standard options are available upon request.

For more options on Rosettes and Escutcheon plates see page 23. For more options on Finishes see pages 12-13.

RE = Rectangular rosettes available for tubular latch application only. Add + \$ 30.00 LIST to the price of the RQ

Upcharges apply for the following special options:

- Extra thick door (> 2")
- Non-standard rosettes (rosettes not listed above)
- Non-standard finishes (finishes not listed above)
- Split finishes

See page 17 for pricing. Exclusions may apply.

Matching elements

- Pg 168 Mortise lock functions
- Pg 152 Deadbolts
- Pg 154 Privacy Bolts
- Pg 156 Escutcheons with deadbolts
- Pg 160 Multi-Point Trim functions

Window lever available in the same design, Call for pricing.



# H 1044 U

## Vincent Van Duysen

Material	Collection	Group
Brass	Fusital	2

Standard option (mm/inches)

**RP Round rosette**

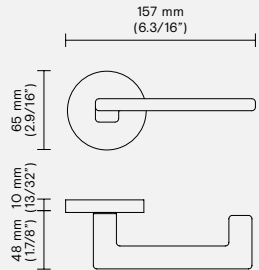

Standard option (mm/inches)

**RQ Square rosette**

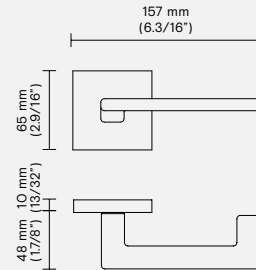

Escutcheon options (mm/inches)

**EP Oval plate**

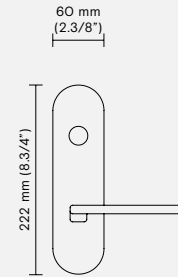

**ER Rectangular plate**

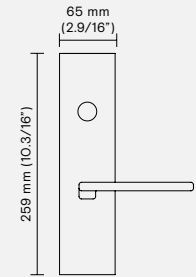

Conversions from metric to U.S. measurements are approximate.

**Retail price**

Finish	Rosette	Function PGE	PCY	DMY R/L Single	ML-F Entry
15 Satin nickel	RP Round	\$ 443.00	\$ 463.00	\$ 210.00	\$ 1,037.00
	RQ Square	\$ 573.00	\$ 592.00	\$ 289.00	\$ 1,176.00
16 Dull black	RP Round	\$ 443.00	\$ 463.00	\$ 210.00	\$ 1,037.00
	RQ Square	\$ 573.00	\$ 592.00	\$ 289.00	\$ 1,176.00
26 Polished chrome	RP Round	\$ 411.00	\$ 420.00	\$ 211.00	\$ 1,037.00
	RQ Square	\$ 529.00	\$ 539.00	\$ 263.00	\$ 1,176.00

Note: The H 1044 lever is also available without return, please see previous page.

**Retail price**

Finish	Escutcheon	Function PGE	PCY	DMY R/L Single	DMY R/L Pair	ML-F Entry
26 Polished chrome	EP Oval	\$ 596.00	\$ 633.00	\$ 293.00	\$ 549.00	\$ 974.00
	ER Rectangular	\$ 645.00	\$ 658.00	\$ 318.00	\$ 583.00	\$ 1,010.00

The options listed above are considered standard. Non-standard options are available upon request.

For more options on Rosettes and Escutcheon plates see page 23. For more options on Finishes see pages 12-13.

RE = Rectangular rosettes available for tubular latch application only. Add + \$ 30.00 LIST to the price of the RQ

**Upcharges apply for the following special options:**

- Extra thick door (> 2")
- Non-standard rosettes (rosettes not listed above)
- Non-standard finishes (finishes not listed above)
- Split finishes

See page 17 for pricing. Exclusions may apply.

**Matching elements**

- Pg 168 Mortise lock functions
- Pg 152 Deadbolts
- Pg 154 Privacy Bolts
- Pg 156 Escutcheons with deadbolts
- Pg 160 Multi-Point Trim functions

Window lever available in the same design. Call for pricing.

# H 1045

## Yoshimi Kono



Material: Brass  
 Collection: Fusital  
 Group: 2

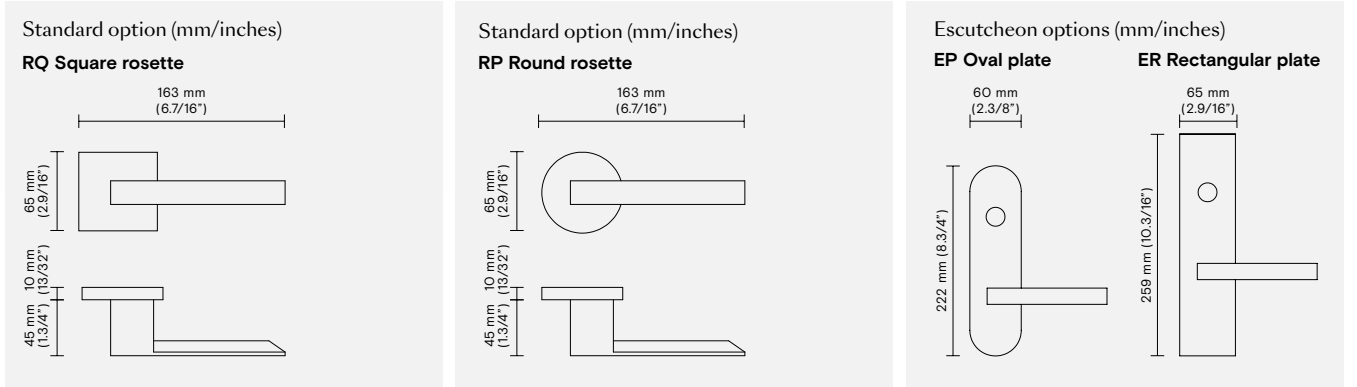

Slim rosette available - See pages 102-103

Conversions from metric to U.S. measurements are approximate.

### Retail price

Finish	Rosette	Function PGE	PCY	DMY R/L Single	ML-F Entry
14 Polished nickel	RP Round	\$ 437.00	\$ 455.00	\$ 205.00	\$ 1,037.00
	RQ Square	\$ 573.00	\$ 586.00	\$ 283.00	\$ 1,176.00
15 Satin nickel	RP Round	\$ 423.00	\$ 441.00	\$ 200.00	\$ 1,037.00
	RQ Square	\$ 546.00	\$ 558.00	\$ 276.00	\$ 1,176.00
26 Polished chrome	RP Round	\$ 392.00	\$ 400.00	\$ 184.00	\$ 1,037.00
	RQ Square	\$ 504.00	\$ 521.00	\$ 251.00	\$ 1,176.00
26D Satin chrome	RP Round	\$ 410.00	\$ 424.00	\$ 195.00	\$ 1,037.00
	RQ Square	\$ 534.00	\$ 548.00	\$ 270.00	\$ 1,176.00

### Retail price

Finish	Escutcheon	Function PGE	PCY	DMY R/L Single	DMY R/L Pair	ML-F Entry
26 Polished chrome	EP Oval	\$ 596.00	\$ 633.00	\$ 293.00	\$ 549.00	\$ 974.00
	ER Rectangular	\$ 645.00	\$ 658.00	\$ 318.00	\$ 583.00	\$ 1,010.00
26D Satin chrome	EP Oval	\$ 596.00	\$ 633.00	\$ 293.00	\$ 549.00	\$ 974.00
	ER Rectangular	\$ 645.00	\$ 658.00	\$ 318.00	\$ 583.00	\$ 1,010.00

The options listed above are considered standard. Non-standard options are available upon request.

For more options on Rosettes and Escutcheon plates see page 23. For more options on Finishes see pages 12-13.

RE = Rectangular rosettes available for tubular latch application only. Add + \$ 30.00 LIST to the price of the RQ. For slim rosette and European version see pages 100-103.

#### Upcharges apply for the following special options:

- Extra thick door (> 2")
- Non-standard rosettes (rosettes not listed above)
- Non-standard finishes (finishes not listed above)
- Split finishes

See page 17 for pricing. Exclusions may apply.

#### Matching elements

- Pg 168 Mortise lock functions
- Pg 152 Deadbolts
- Pg 154 Privacy Bolts
- Pg 156 Escutcheons with deadbolts
- Pg 160 Multi-Point Trim functions

European window lever style available in the same design. Call for pricing.

# H 1046

## Nais



Material	Collection	Group
Brass	Lab	2

### Standard option (mm/inches)

#### RQ Square rosette

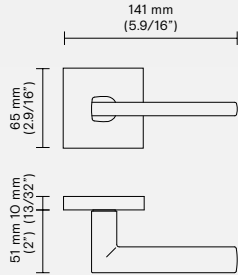

### Standard option (mm/inches)

#### RP Round rosette

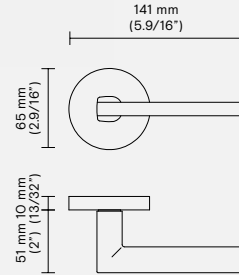

### Escutcheon options (mm/inches)

#### EP Oval plate

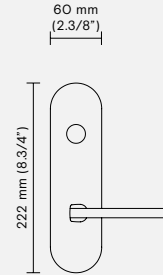

#### ER Rectangular plate

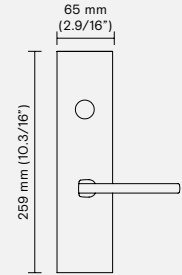

**Slim rosette** available - See pages 102-103

Conversions from metric to U.S. measurements are approximate.

### Retail price

Finish	Rosette	Function PGE	PCY	DMY R/L Single	ML-F Entry
15 Satin nickel	RP Round	\$ 354.00	\$ 370.00	\$ 165.00	\$ 1,037.00
	RQ Square	\$ 479.00	\$ 498.00	\$ 243.00	\$ 1,176.00
16 Dull black	RP Round	\$ 332.00	\$ 350.00	\$ 155.00	\$ 1,037.00
	RQ Square	\$ 463.00	\$ 480.00	\$ 236.00	\$ 1,176.00
26 Polished chrome	RP Round	\$ 327.00	\$ 337.00	\$ 148.00	\$ 1,037.00
	RQ Square	\$ 441.00	\$ 458.00	\$ 220.00	\$ 1,176.00
26D Satin chrome	RP Round	\$ 332.00	\$ 350.00	\$ 155.00	\$ 1,037.00
	RQ Square	\$ 463.00	\$ 480.00	\$ 236.00	\$ 1,176.00

### Retail price

Finish	Escutcheon	Function PGE	PCY	DMY R/L Single	DMY R/L Pair	ML-F Entry
26 Polished chrome	EP Oval	\$ 596.00	\$ 633.00	\$ 293.00	\$ 549.00	\$ 974.00
	ER Rectangular	\$ 645.00	\$ 658.00	\$ 318.00	\$ 583.00	\$ 1,010.00
26D Satin chrome	EP Oval	\$ 596.00	\$ 633.00	\$ 293.00	\$ 549.00	\$ 974.00
	ER Rectangular	\$ 645.00	\$ 658.00	\$ 318.00	\$ 583.00	\$ 1,010.00

The options listed above are considered standard. Non-standard options are available upon request.

For more options on Rosettes and Escutcheon plates see page 23. For more options on Finishes see pages 12-13.

RE = Rectangular rosettes available for tubular latch application only. Add + \$ 30.00 LIST to the price of the RQ. For slim rosette and European version see pages 100-103.

#### Upcharges apply for the following special options:

- Extra thick door (> 2")
- Non-standard rosettes (rosettes not listed above)
- Non-standard finishes (finishes not listed above)
- Split finishes

See page 17 for pricing. Exclusions may apply.

#### Matching elements

- Pg 168 Mortise lock functions
- Pg 152 Deadbolts
- Pg 154 Privacy Bolts
- Pg 156 Escutcheons with deadbolts
- Pg 160 Multi-Point Trim functions

European window lever style available in the same design. Call for pricing.

# H 1049

## Divara



Material  
Brass

Collection  
Lab

Group  
2

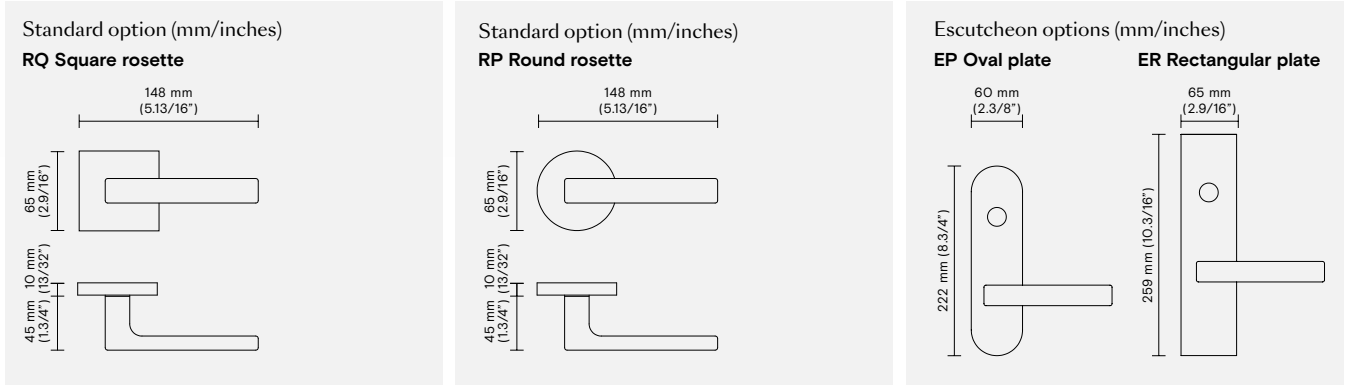

Slim rosette available - See pages 102-103

Conversions from metric to U.S. measurements are approximate.

### Retail price

Finish	Rosette	Function PGE	PCY	DMY R/L Single	ML-F Entry
16 Dull black	RP Round	\$ 375.00	\$ 404.00	\$ 179.00	\$ 1,037.00
	RQ Square	\$ 506.00	\$ 532.00	\$ 256.00	\$ 1,176.00
17A Polished black nickel	RP Round	\$ 435.00	\$ 469.00	\$ 208.00	\$ 1,037.00
	RQ Square	\$ 588.00	\$ 617.00	\$ 297.00	\$ 1,176.00
26 Polished chrome	RP Round	\$ 393.00	\$ 422.00	\$ 188.00	\$ 1,037.00
	RQ Square	\$ 516.00	\$ 548.00	\$ 259.00	\$ 1,176.00
26D Satin chrome	RP Round	\$ 397.00	\$ 427.00	\$ 189.00	\$ 1,037.00
	RQ Square	\$ 535.00	\$ 562.00	\$ 272.00	\$ 1,176.00

### Retail price

Finish	Escutcheon	Function PGE	PCY	DMY R/L Single	DMY R/L Pair	ML-F Entry
26 Polished chrome	EP Oval	\$ 596.00	\$ 633.00	\$ 293.00	\$ 549.00	\$ 974.00
	ER Rectangular	\$ 645.00	\$ 658.00	\$ 318.00	\$ 583.00	\$ 1,010.00
26D Satin chrome	EP Oval	\$ 596.00	\$ 633.00	\$ 293.00	\$ 549.00	\$ 974.00
	ER Rectangular	\$ 645.00	\$ 658.00	\$ 318.00	\$ 583.00	\$ 1,010.00

The options listed above are considered standard. Non-standard options are available upon request.

For more options on Rosettes and Escutcheon plates see page 23. For more options on Finishes see pages 12-13.

RE = Rectangular rosettes available for tubular latch application only. Add + \$ 30.00 LIST to the price of the RQ. For slim rosette and European version see pages 100-103.

Upcharges apply for the following special options:

- Extra thick door (> 2")
- Non-standard rosettes (rosettes not listed above)
- Non-standard finishes (finishes not listed above)
- Split finishes

See page 17 for pricing. Exclusions may apply.

### Matching elements

- Pg 168 Mortise lock functions
- Pg 152 Deadbolts
- Pg 154 Privacy Bolts
- Pg 156 Escutcheons with deadbolts
- Pg 160 Multi-Point Trim functions

European window lever style available in the same design. Call for pricing.



# H 1050

## Giasone

Material	Collection	Group
Brass	Lab	1

### Standard option (mm/inches)

#### RP Round rosette

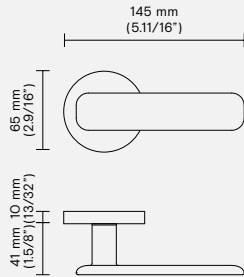

### Standard option (mm/inches)

#### RQ Square rosette

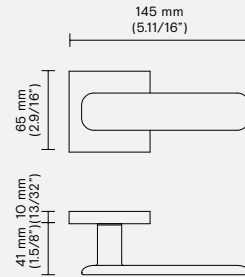

### Escutcheon options (mm/inches)

#### EP Oval plate

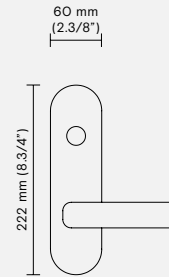

#### ER Rectangular plate

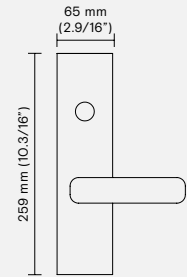

**Slim rosette** available - See pages 102-103

Conversions from metric to U.S. measurements are approximate.

### Retail price

Finish	Rosette	Function PGE	PCY	DMY R/L Single	ML-F Entry
26 Polished chrome	RP Round	\$ 374.00	\$ 408.00	\$ 188.00	\$ 961.00
	RQ Square	\$ 502.00	\$ 532.00	\$ 262.00	\$ 1,100.00
26D Satin chrome	RP Round	\$ 374.00	\$ 408.00	\$ 188.00	\$ 961.00
	RQ Square	\$ 515.00	\$ 542.00	\$ 276.00	\$ 1,100.00

### Retail price

Finish	Escutcheon	Function PGE	PCY	DMY R/L Single	DMY R/L Pair	ML-F Entry
26 Polished chrome	EP Oval	\$ 520.00	\$ 545.00	\$ 254.00	\$ 455.00	\$ 899.00
	ER Rectangular	\$ 570.00	\$ 596.00	\$ 279.00	\$ 506.00	\$ 935.00
26D Satin chrome	EP Oval	\$ 520.00	\$ 545.00	\$ 254.00	\$ 455.00	\$ 899.00
	ER Rectangular	\$ 570.00	\$ 596.00	\$ 279.00	\$ 506.00	\$ 935.00

The options listed above are considered standard. Non-standard options are available upon request.

For more options on Rosettes and Escutcheon plates see page 23. For more options on Finishes see pages 12-13.

RE = Rectangular rosettes available for tubular latch application only. Add + \$ 30.00 LIST to the price of the RQ. For slim rosette and European version see pages 100-103.

#### Upcharges apply for the following special options:

- Extra thick door (> 2")
- Non-standard rosettes (rosettes not listed above)
- Non-standard finishes (finishes not listed above)
- Split finishes

See page 17 for pricing. Exclusions may apply.

#### Matching elements

- Pg 168 Mortise lock functions
- Pg 152 Deadbolts
- Pg 154 Privacy Bolts
- Pg 156 Escutcheons with deadbolts
- Pg 160 Multi-Point Trim functions

European window lever style available in the same design. Call for pricing.



# H 1052

## Mikhail Leykin

Material  
Brass

Collection  
Fusital

Group  
2

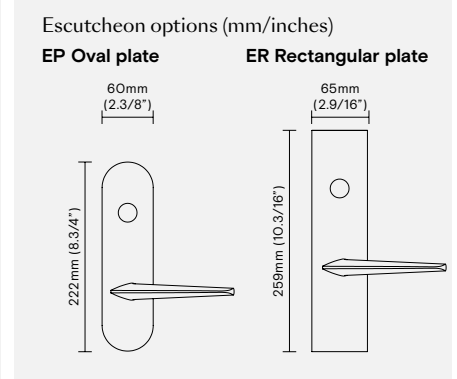
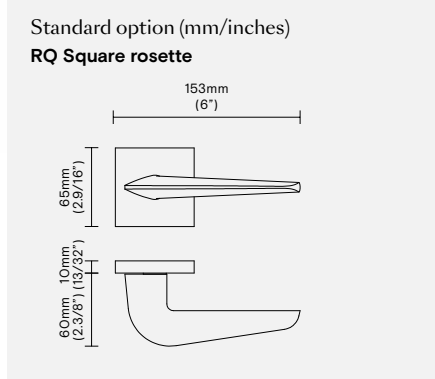
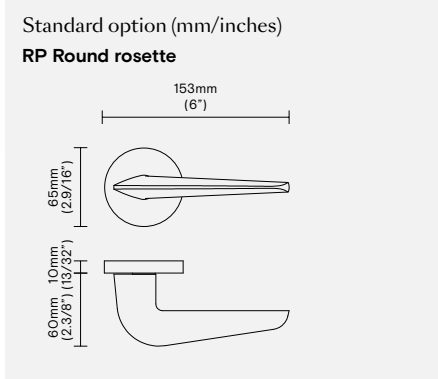

**Slim rosette** available - See pages 102-103

Conversions from metric to U.S. measurements are approximate.

### Retail price

Finish	Rosette	Function PGE	PCY	DMY R/L Single	ML-F Entry
<b>06M</b> Matt bronze	<b>RP</b> Round	\$ 477.00	\$ 717.00	\$ 236.00	\$ 1,037.00
	<b>RQ</b> Square	\$ 596.00	\$ 857.00	\$ 295.00	\$ 1,176.00
<b>16</b> Dull black	<b>RP</b> Round	\$ 396.00	\$ 717.00	\$ 189.00	\$ 1,037.00
	<b>RQ</b> Square	\$ 515.00	\$ 857.00	\$ 249.00	\$ 1,176.00
<b>26</b> Polished chrome	<b>RP</b> Round	\$ 402.00	\$ 667.00	\$ 198.00	\$ 1,037.00
	<b>RQ</b> Square	\$ 521.00	\$ 807.00	\$ 258.00	\$ 1,176.00
<b>26D</b> Satin chrome	<b>RP</b> Round	\$ 421.00	\$ 725.00	\$ 208.00	\$ 1,037.00
	<b>RQ</b> Square	\$ 539.00	\$ 855.00	\$ 267.00	\$ 1,176.00

**Note:** If does not fit a privacy pin, supplied with 105 privacy bolt.

### Retail price

Finish	Escutcheon	Function PGE	PCY	DMY R/L Single	DMY R/L Pair	ML-F Entry
<b>26</b> Polished chrome	<b>EP</b> Oval	\$ 596.00	\$ 633.00	\$ 293.00	\$ 549.00	\$ 974.00
	<b>ER</b> Rectangular	\$ 645.00	\$ 658.00	\$ 318.00	\$ 583.00	\$ 1,010.00
<b>26D</b> Satin chrome	<b>EP</b> Oval	\$ 596.00	\$ 633.00	\$ 293.00	\$ 549.00	\$ 974.00
	<b>ER</b> Rectangular	\$ 645.00	\$ 658.00	\$ 318.00	\$ 583.00	\$ 1,010.00

The options listed above are considered standard. Non-standard options are available upon request.

For more options on Rosettes and Escutcheon plates see page 23. For more options on Finishes see pages 12-13.

RE = Rectangular rosettes available for tubular latch application only. Add + \$ 30.00 LIST to the price of the RQ. For slim rosette and European version see pages 100-103.

**Upcharges apply for the following special options:**

- Extra thick door (> 2")
- Non-standard rosettes (rosettes not listed above)
- Non-standard finishes (finishes not listed above)
- Split finishes

See page 17 for pricing. Exclusions may apply.

### Matching elements

- Pg 168 Mortise lock functions
- Pg 152 Deadbolts
- Pg 154 Privacy Bolts
- Pg 156 Escutcheons with deadbolts
- Pg 160 Multi-Point Trim functions

European window lever style available in the same design. Call for pricing.

# H 1054

## W.W.



Material	Collection	Group
Brass	Lab	2

### Standard option (mm/inches)

#### RP Round rosette

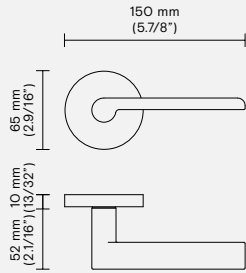

### Standard option (mm/inches)

#### RQ Square rosette

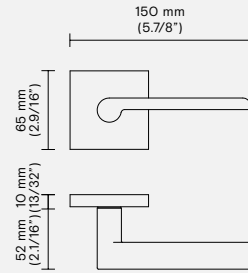

### Escutcheon options (mm/inches)

#### EP Oval plate

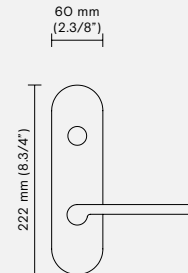

#### ER Rectangular plate

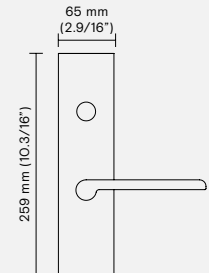

Slim rosette available - See pages 102-103

Conversions from metric to U.S. measurements are approximate.

### Retail price

Finish	Rosette	Function PGE	PCY	DMY R/L Single	ML-F Entry
03M Matt brass	RP Round	\$ 462.00	\$ 488.00	\$ 229.00	\$ 1,037.00
	RQ Square	\$ 555.00	\$ 590.00	\$ 287.00	\$ 1,176.00
15 Satin nickel	RP Round	\$ 437.00	\$ 462.00	\$ 216.00	\$ 1,037.00
	RQ Square	\$ 560.00	\$ 598.00	\$ 296.00	\$ 1,176.00
16 Dull black	RP Round	\$ 399.00	\$ 431.00	\$ 194.00	\$ 1,037.00
	RQ Square	\$ 521.00	\$ 559.00	\$ 269.00	\$ 1,176.00
26 Polished chrome	RP Round	\$ 399.00	\$ 431.00	\$ 194.00	\$ 1,037.00
	RQ Square	\$ 521.00	\$ 559.00	\$ 269.00	\$ 1,176.00

### Retail price

Finish	Escutcheon	Function PGE	PCY	DMY R/L Single	DMY R/L Pair	ML-F Entry
26 Polished chrome	EP Oval	\$ 596.00	\$ 633.00	\$ 293.00	\$ 549.00	\$ 974.00
	ER Rectangular	\$ 645.00	\$ 658.00	\$ 318.00	\$ 583.00	\$ 1,010.00

The options listed above are considered standard. Non-standard options are available upon request.

For more options on Rosettes and Escutcheon plates see page 23. For more options on Finishes see pages 12-13.

RE = Rectangular rosettes available for tubular latch application only. Add + \$ 30.00 LIST to the price of the RQ. For slim rosette and European version see pages 100-103.

#### Upcharges apply for the following special options:

- Extra thick door (> 2")
- Non-standard rosettes (rosettes not listed above)
- Non-standard finishes (finishes not listed above)
- Split finishes

See page 17 for pricing. Exclusions may apply.

#### Matching elements

- Pg 168 Mortise lock functions
- Pg 152 Deadbolts
- Pg 154 Privacy Bolts
- Pg 156 Escutcheons with deadbolts
- Pg 160 Multi-Point Trim functions

European window lever style available in the same design. Call for pricing.



# H 1056 Quadra

Material  
Zinc alloy

Collection  
Lab

Group  
2

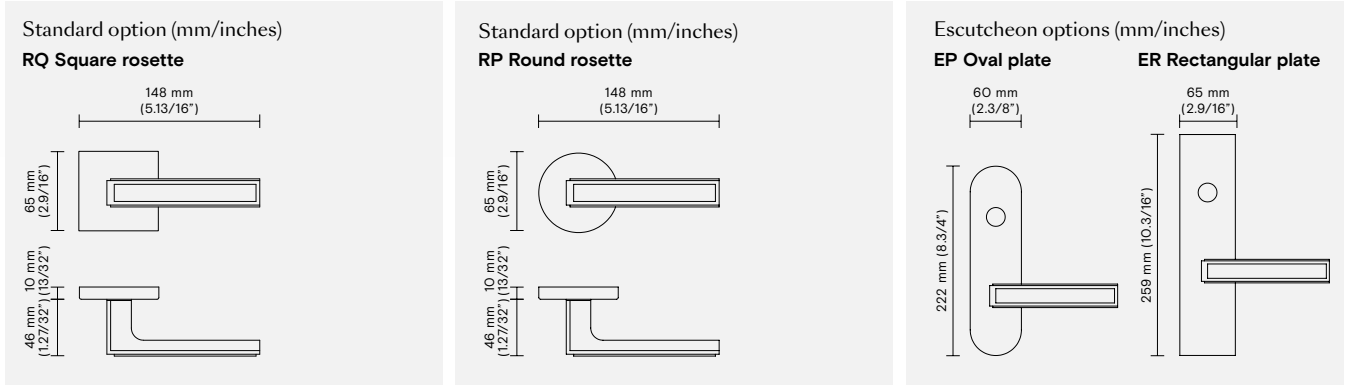

Slim rosette available - See pages 102-103

Conversions from metric to U.S. measurements are approximate.

## Retail price

Finish	Rosette	Function PGE	PCY	DMY R/L Single	ML-F Entry
26 Polished chrome	RP Round	\$ 403.00	\$ 428.00	\$ 198.00	\$ 1,037.00
	RQ Square	\$ 497.00	\$ 534.00	\$ 256.00	\$ 1,176.00
26D Satin chrome	RP Round	\$ 426.00	\$ 451.00	\$ 233.00	\$ 1,037.00
	RQ Square	\$ 520.00	\$ 545.00	\$ 267.00	\$ 1,176.00

## Retail price

Finish	Escutcheon	Function PGE	PCY	DMY R/L Single	DMY R/L Pair	ML-F Entry
26 Polished chrome	EP Oval	\$ 596.00	\$ 633.00	\$ 293.00	\$ 549.00	\$ 974.00
	ER Rectangular	\$ 645.00	\$ 658.00	\$ 318.00	\$ 583.00	\$ 1,010.00
26D Satin chrome	EP Oval	\$ 596.00	\$ 633.00	\$ 293.00	\$ 549.00	\$ 974.00
	ER Rectangular	\$ 645.00	\$ 658.00	\$ 318.00	\$ 583.00	\$ 1,010.00

The options listed above are considered standard.  
Non-standard options are available upon request.

For more options on Rosettes and Escutcheon plates see page 23.  
For more options on Finishes see pages 12-13.

RE = Rectangular rosettes available for tubular latch application only.  
Add + \$ 30.00 LIST to the price of the RQ.  
For slim rosette and European version see pages 100-103.

Upcharges apply for the following special options:

- Extra thick door (> 2")
- Non-standard rosettes (rosettes not listed above)
- Non-standard finishes (finishes not listed above)
- Split finishes

See page 17 for pricing. Exclusions may apply.

## Matching elements

- Pg 168 Mortise lock functions
- Pg 152 Deadbolts
- Pg 154 Privacy Bolts
- Pg 156 Escutcheons with deadbolts
- Pg 160 Multi-Point Trim functions

European window lever style available in the same design.  
Call for pricing.



# H 1057 Retrò

Material	Collection	Group
Brass	Lab	2

### Standard option (mm/inches)

#### RP Round rosette

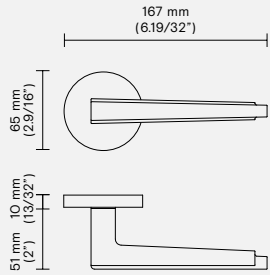

### Standard option (mm/inches)

#### RQ Square rosette

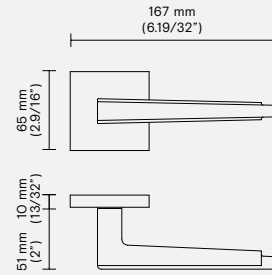

### Escutcheon options (mm/inches)

#### EP Oval plate

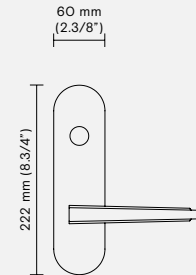

#### ER Rectangular plate

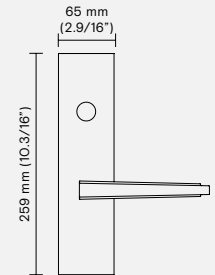

Conversions from metric to U.S. measurements are approximate.

### Retail price

Finish	Rosette	Function PGE	PCY	DMY R/L Single	ML-F Entry
03 Polished brass	RP Round	\$ 353.00	\$ 375.00	\$ 193.00	\$ 1,037.00
	RQ Square	\$ 391.00	\$ 411.00	\$ 260.00	\$ 1,176.00
26 Polished chrome	RP Round	\$ 397.00	\$ 416.00	\$ 195.00	\$ 1,037.00
	RQ Square	\$ 511.00	\$ 549.00	\$ 264.00	\$ 1,176.00

### Retail price

Finish	Escutcheon	Function PGE	PCY	DMY R/L Single	DMY R/L Pair	ML-F Entry
26 Polished chrome	EP Oval	\$ 596.00	\$ 633.00	\$ 293.00	\$ 549.00	\$ 974.00
	ER Rectangular	\$ 645.00	\$ 658.00	\$ 318.00	\$ 583.00	\$ 1,010.00

The options listed above are considered standard. Non-standard options are available upon request.

For more options on Rosettes and Escutcheon plates see page 23. For more options on Finishes see pages 12-13.

RE = Rectangular rosettes available for tubular latch application only. Add + \$ 30.00 LIST to the price of the RQ. For slim rosette and European version see pages 100-103.

#### Upcharges apply for the following special options:

- Extra thick door (> 2")
- Non-standard rosettes (rosettes not listed above)
- Non-standard finishes (finishes not listed above)
- Split finishes

See page 17 for pricing. Exclusions may apply.

#### Matching elements

- Pg 168 Mortise lock functions
- Pg 152 Deadbolts
- Pg 154 Privacy Bolts
- Pg 156 Escutcheons with deadbolts
- Pg 160 Multi-Point Trim functions

European window lever style available in the same design. Call for pricing.



# H 1058

## Amica

Material  
Zinc alloy

Collection  
Lab

Group  
4

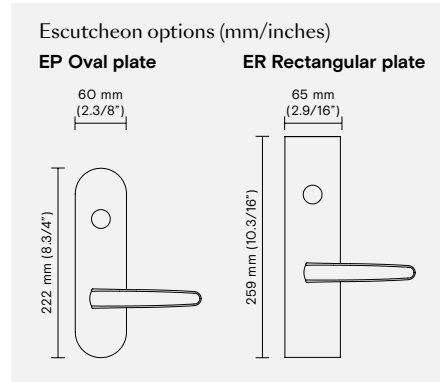
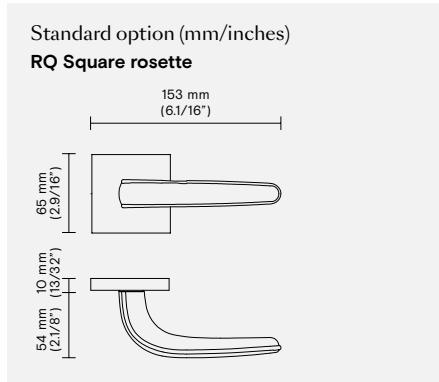
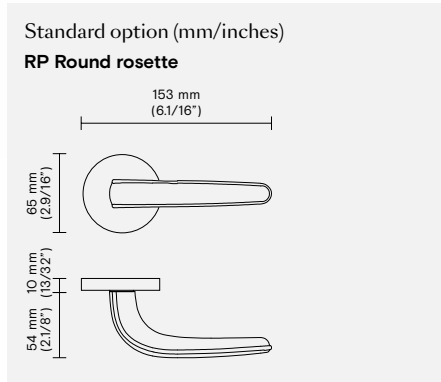

**Slim rosette** available - See pages 102-103

Conversions from metric to U.S. measurements are approximate.

### Retail price

Finish	Rosette	Function PGE	PCY	DMY R/L Single	ML-F Entry
<b>22M</b> Matt white	<b>RP</b> Round	\$ 223.00	\$ 226.00	\$ 113.00	\$ 924.00
	<b>RQ</b> Square	\$ 321.00	\$ 323.00	\$ 172.00	\$ 1,062.00
<b>26/26D</b> Polished chrome / Satin chrome	<b>RP</b> Round	\$ 223.00	\$ 226.00	\$ 113.00	\$ 924.00
	<b>RQ</b> Square	\$ 321.00	\$ 323.00	\$ 172.00	\$ 1,062.00

### Retail price

Finish	Escutcheon	Function PGE	PCY	DMY R/L Single	DMY R/L Pair	ML-F Entry
<b>26/26D</b> Polished chrome / Satin chrome	<b>EP</b> Oval	\$ 481.00	\$ 494.00	\$ 254.00	\$ 430.00	\$ 859.00
	<b>ER</b> Rectangular	\$ 558.00	\$ 570.00	\$ 267.00	\$ 481.00	\$ 899.00

The options listed above are considered standard.  
Non-standard options are available upon request.

For more options on Rosettes and Escutcheon plates see page 23.  
For more options on Finishes see pages 12-13.

RE = Rectangular rosettes available for tubular latch application only.  
Add + \$ 30.00 LIST to the price of the RQ

#### Upcharges apply for the following special options:

- Extra thick door (> 2")
- Non-standard rosettes (rosettes not listed above)
- Non-standard finishes (finishes not listed above)
- Split finishes

See page 17 for pricing. Exclusions may apply.

#### Matching elements

- Pg 168 Mortise lock functions
- Pg 152 Deadbolts
- Pg 154 Privacy Bolts
- Pg 156 Escutcheons with deadbolts
- Pg 160 Multi-Point Trim functions

Window lever available in the same design, Call for pricing.

# H 1060

## SOM - Skidmore, Owings & Merrill



Material	Collection	Group
Brass	Fusital	3

Standard option (mm/inches)

**RQ Square rosette**



Standard option (mm/inches)

**RP Round rosette**

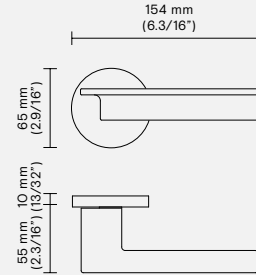

Escutcheon options (mm/inches)

**EP Oval plate**

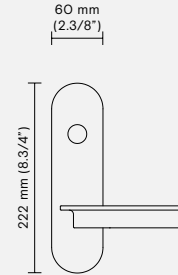

**ER Rectangular plate**

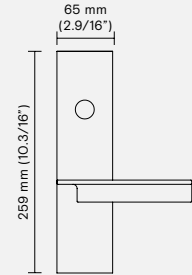

**Slim rosette** available - See pages 102-103

Conversions from metric to U.S. measurements are approximate.

**Retail price**

Finish	Rosette	Function PGE	PCY	DMY R/L Single	ML-F Entry
<b>16</b> Dull black	<b>RP</b> Round	\$ 612.00	\$ 622.00	\$ 297.00	\$ 1,251.00
	<b>RQ</b> Square	\$ 502.00	\$ 511.00	\$ 242.00	\$ 1,389.00
<b>26</b> Polished chrome	<b>RP</b> Round	\$ 638.00	\$ 650.00	\$ 258.00	\$ 1,251.00
	<b>RQ</b> Square	\$ 528.00	\$ 540.00	\$ 253.00	\$ 1,389.00
<b>26D</b> Satin chrome	<b>RP</b> Round	\$ 638.00	\$ 650.00	\$ 258.00	\$ 1,251.00
	<b>RQ</b> Square	\$ 528.00	\$ 540.00	\$ 253.00	\$ 1,389.00

**Retail price**

Finish	Escutcheon	Function PGE	PCY	DMY R/L Single	DMY R/L Pair	ML-F Entry
<b>26</b> Polished chrome	<b>EP</b> Oval	\$ 772.00	\$ 785.00	\$ 387.00	\$ 712.00	\$ 1,200.00
	<b>ER</b> Rectangular	\$ 819.00	\$ 833.00	\$ 410.00	\$ 761.00	\$ 1,226.00
<b>26D</b> Satin chrome	<b>EP</b> Oval	\$ 772.00	\$ 785.00	\$ 387.00	\$ 712.00	\$ 1,200.00
	<b>ER</b> Rectangular	\$ 819.00	\$ 833.00	\$ 410.00	\$ 761.00	\$ 1,226.00

The options listed above are considered standard. Non-standard options are available upon request.

For more options on Rosettes and Escutcheon plates see page 23. For more options on Finishes see pages 12-13.

RE = Rectangular rosettes available for tubular latch application only. Add + \$ 30.00 LIST to the price of the RQ. For slim rosette and European version see pages 100-103.

**Upcharges apply for the following special options:**

- Extra thick door (> 2")
- Non-standard rosettes (rosettes not listed above)
- Non-standard finishes (finishes not listed above)
- Split finishes

See page 17 for pricing. Exclusions may apply.

**Matching elements**

- Pg 168 Mortise lock functions
- Pg 152 Deadbolts
- Pg 154 Privacy Bolts
- Pg 156 Escutcheons with deadbolts
- Pg 160 Multi-Point Trim functions

European window lever style available in the same design. Call for pricing.

# H 1061

## Di Virgilio Veneziano



Material  
Brass

Collection  
Fusital

Group  
2

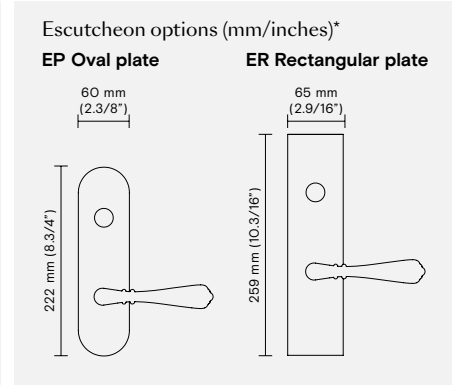
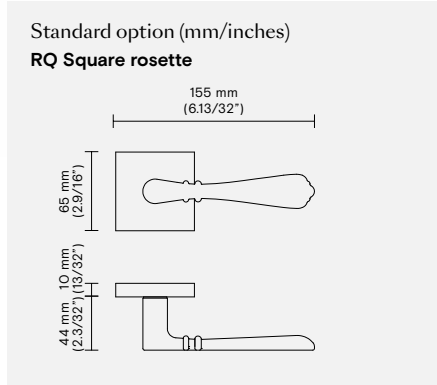
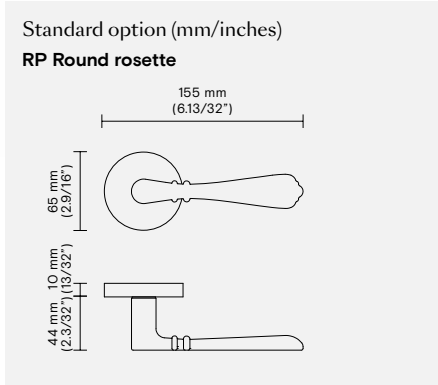

**Slim rosette** available - See pages 102-103

\*Only available on request  
Conversions from metric to U.S. measurements are approximate.

### Retail price

Finish	Rosette	Function PGE	PCY	DMY R/L Single	ML-F Entry
<b>O3D</b> Satin brass	<b>RP</b> Round	\$ 492.00	\$ 516.00	\$ 245.00	\$ 1,037.00
	<b>RQ</b> Square	\$ 590.00	\$ 626.00	\$ 305.00	\$ 1,176.00
<b>O6M</b> Matt bronze	<b>RP</b> Round	\$ 492.00	\$ 516.00	\$ 245.00	\$ 1,037.00
	<b>RQ</b> Square	\$ 590.00	\$ 626.00	\$ 305.00	\$ 1,176.00
<b>17A</b> Polished black nickel	<b>RP</b> Round	\$ 522.00	\$ 547.00	\$ 260.00	\$ 1,037.00
	<b>RQ</b> Square	\$ 597.00	\$ 664.00	\$ 323.00	\$ 1,176.00

The options listed above are considered standard.  
Non-standard options are available upon request.

For more options on Rosettes and Escutcheon plates see page 23.  
For more options on Finishes see pages 12-13.

RE = Rectangular rosettes available for tubular latch application only.  
Add + \$ 30.00 LIST to the price of the RQ.  
For slim rosette and European version see pages 100-103.

#### Upcharges apply for the following special options:

- Extra thick door (> 2")
- Non-standard rosettes (rosettes not listed above)
- Non-standard finishes (finishes not listed above)
- Split finishes

See page 17 for pricing. Exclusions may apply.

#### Matching elements

- Pg 168 Mortise lock functions
- Pg 152 Deadbolts
- Pg 154 Privacy Bolts
- Pg 156 Escutcheons with deadbolts
- Pg 160 Multi-Point Trim functions

European window lever style available in the same design.  
Call for pricing.



# H 1062 Carmen

Material	Collection	Group
Brass	Lab	2

Standard option (mm/inches)

**RP Round rosette**

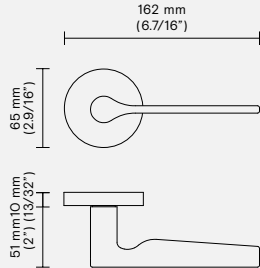

Standard option (mm/inches)

**RQ Square rosette**

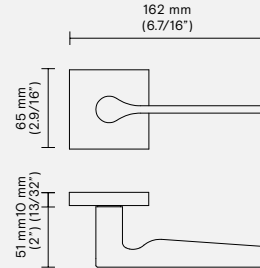

Escutcheon options (mm/inches)

**EP Oval plate**

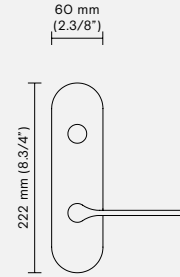

**ER Rectangular plate**

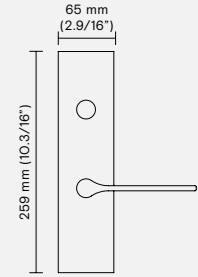

**Slim rosette** available - See pages 102-103

Conversions from metric to U.S. measurements are approximate.

**Retail price**

Finish	Rosette	Function PGE	PCY	DMY R/L Single	ML-F Entry
<b>15</b> Satin nickel	<b>RP</b> Round	\$ 378.00	\$ 417.00	\$ 184.00	\$ 1,037.00
	<b>RQ</b> Square	\$ 497.00	\$ 536.00	\$ 243.00	\$ 1,176.00
<b>16</b> Dull black	<b>RP</b> Round	\$ 357.00	\$ 394.00	\$ 173.00	\$ 1,037.00
	<b>RQ</b> Square	\$ 476.00	\$ 512.00	\$ 216.00	\$ 1,176.00
<b>26D</b> Satin chrome	<b>RP</b> Round	\$ 378.00	\$ 417.00	\$ 184.00	\$ 1,037.00
	<b>RQ</b> Square	\$ 497.00	\$ 536.00	\$ 243.00	\$ 1,176.00
<b>56</b> Dark bronze	<b>RP</b> Round	\$ 378.00	\$ 417.00	\$ 184.00	\$ 1,037.00
	<b>RQ</b> Square	\$ 497.00	\$ 536.00	\$ 243.00	\$ 1,176.00

**Retail price**

Finish	Escutcheon	Function PGE	PCY	DMY R/L Single	DMY R/L Pair	ML-F Entry
<b>26D</b> Satin chrome	<b>EP</b> Oval	\$ 596.00	\$ 633.00	\$ 293.00	\$ 549.00	\$ 974.00
	<b>ER</b> Rectangular	\$ 645.00	\$ 658.00	\$ 318.00	\$ 583.00	\$ 1,010.00

The options listed above are considered standard. Non-standard options are available upon request.

For more options on Rosettes and Escutcheon plates see page 23. For more options on Finishes see pages 12-13.

RE = Rectangular rosettes available for tubular latch application only. Add + \$ 30.00 LIST to the price of the RQ. For slim rosette and European version see pages 100-103.

**Upcharges apply for the following special options:**

- Extra thick door (> 2")
- Non-standard rosettes (rosettes not listed above)
- Non-standard finishes (finishes not listed above)
- Split finishes

See page 17 for pricing. Exclusions may apply.

**Matching elements**

- Pg 168 Mortise lock functions
- Pg 152 Deadbolts
- Pg 154 Privacy Bolts
- Pg 156 Escutcheons with deadbolts
- Pg 160 Multi-Point Trim functions

European window lever style available in the same design. Call for pricing.

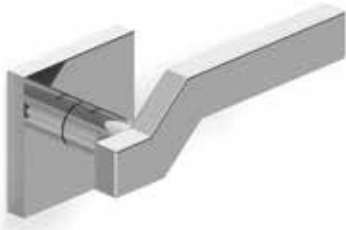

# H 1066

## Bertone Design

Material  
Brass

Collection  
Fusital

Group  
2

Standard option (mm/inches)

### RQ Square rosette

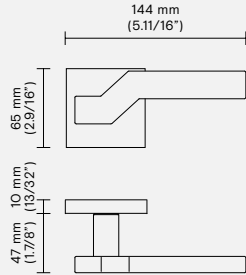

Standard option (mm/inches)

### RP Round rosette

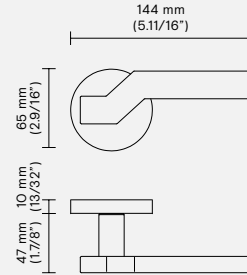

Escutcheon options (mm/inches)

### EP Oval plate

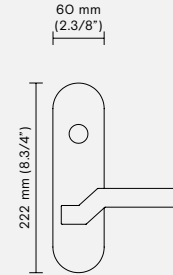

### ER Rectangular plate

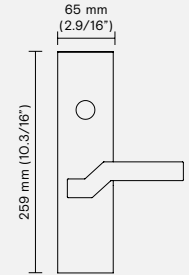

Slim rosette available - See pages 102-103

Conversions from metric to U.S. measurements are approximate.

### Retail price

Finish	Rosette	Function PGE	PCY	DMY R/L Single	ML-F Entry
03M Matt brass	RP Round	\$ 492.00	\$ 516.00	\$ 245.00	\$ 1,037.00
	RQ Square	\$ 590.00	\$ 626.00	\$ 305.00	\$ 1,176.00
26 Polished chrome	RP Round	\$ 492.00	\$ 516.00	\$ 245.00	\$ 1,037.00
	RQ Square	\$ 590.00	\$ 626.00	\$ 305.00	\$ 1,176.00

### Retail price

Finish	Escutcheon	Function PGE	PCY	DMY R/L Single	DMY R/L Pair	ML-F Entry
26 Polished chrome	EP Oval	\$ 596.00	\$ 633.00	\$ 293.00	\$ 549.00	\$ 974.00
	ER Rectangular	\$ 645.00	\$ 658.00	\$ 318.00	\$ 583.00	\$ 1,010.00

The options listed above are considered standard.  
Non-standard options are available upon request.

For more options on Rosettes and Escutcheon plates see page 23.  
For more options on Finishes see pages 12-13.

RE = Rectangular rosettes available for tubular latch application only.  
Add + \$ 30.00 LIST to the price of the RQ.  
For slim rosette and European version see pages 100-103.

Upcharges apply for the following special options:

- Extra thick door (> 2")
- Non-standard rosettes (rosettes not listed above)
- Non-standard finishes (finishes not listed above)
- Split finishes

See page 17 for pricing. Exclusions may apply.

### Matching elements

- Pg 168 Mortise lock functions
- Pg 152 Deadbolts
- Pg 154 Privacy Bolts
- Pg 156 Escutcheons with deadbolts
- Pg 160 Multi-Point Trim functions

European window lever style available in the same design.  
Call for pricing.



# H 1068

## Pembroke & Ives

Material	Collection	Group
Brass	Fusital	3

Standard option (mm/inches)

**RQ Square rosette**

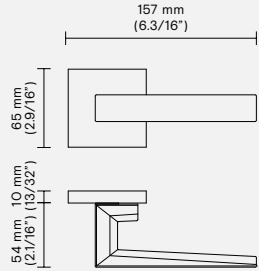

Standard option (mm/inches)

**RP Round rosette**

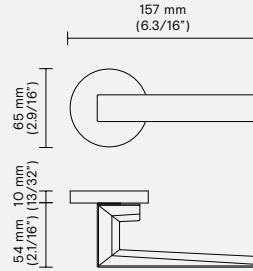

Escutcheon options (mm/inches)

**EP Oval plate**

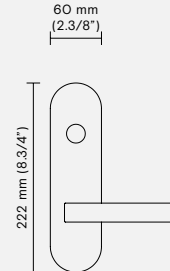

**ER Rectangular plate**

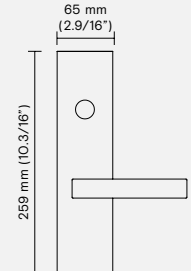

Slim rosette available - See pages 102-103

Conversions from metric to U.S. measurements are approximate.

**Retail price**

Finish	Rosette	Function		DMY R/L Single	ML-F Entry
		PGE	PCY		
03/03D Polished brass / Satin brass*	RP Round	\$ 546.00	\$ 571.00	\$ 278.00	\$ 1,251.00
	RQ Square	\$ 757.00	\$ 781.00	\$ 385.00	\$ 1,389.00
15 Satin nickel	RP Round	\$ 529.00	\$ 553.00	\$ 274.00	\$ 1,251.00
	RQ Square	\$ 637.00	\$ 673.00	\$ 337.00	\$ 1,389.00
16 Dull black	RP Round	\$ 469.00	\$ 492.00	\$ 233.00	\$ 1,251.00
	RQ Square	\$ 563.00	\$ 597.00	\$ 291.00	\$ 1,389.00
26/26D Polished chrome / Satin chrome*	RP Round	\$ 546.00	\$ 571.00	\$ 278.00	\$ 1,251.00
	RQ Square	\$ 757.00	\$ 781.00	\$ 385.00	\$ 1,389.00

**Retail price**

Finish	Escutcheon	Function		DMY R/L Single	DMY R/L Pair	ML-F Entry
		PGE	PCY			
26/26D Polished chrome / Satin chrome*	EP Oval	\$ 772.00	\$ 785.00	\$ 387.00	\$ 712.00	\$ 1,200.00
	ER Rectangular	\$ 819.00	\$ 833.00	\$ 410.00	\$ 761.00	\$ 1,226.00

\* Note: The lever is satin on its front and side edge, while the rest is polished. The rosette/escutcheon is polished.

The options listed above are considered standard. Non-standard options are available upon request.

For more options on Rosettes and Escutcheon plates see page 23. For more options on Finishes see pages 12-13.

RE = Rectangular rosettes available for tubular latch application only. Add + \$ 30.00 LIST to the price of the RQ. For slim rosette and European version see pages 100-103.

Upcharges apply for the following special options:

- Extra thick door (> 2")
- Non-standard rosettes (rosettes not listed above)
- Non-standard finishes (finishes not listed above)
- Split finishes

See page 17 for pricing. Exclusions may apply.

**Matching elements**

- Pg 168 Mortise lock functions
- Pg 152 Deadbolts
- Pg 154 Privacy Bolts
- Pg 156 Escutcheons with deadbolts
- Pg 160 Multi-Point Trim functions

European window lever style available in the same design. Call for pricing.

# H 1069 Susannah



Material  
Brass

Collection  
Lab

Group  
3

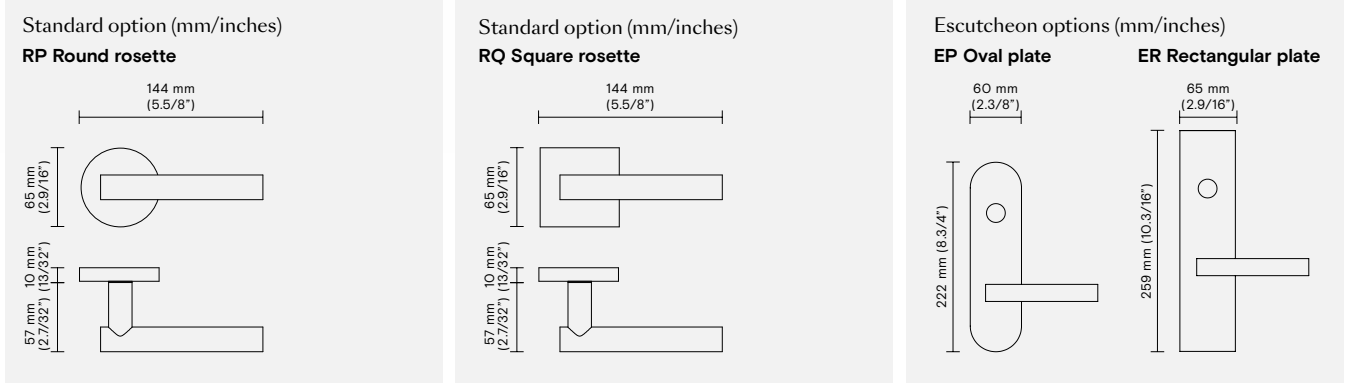

Slim rosette available - See pages 102-103

Conversions from metric to U.S. measurements are approximate.

### Retail price

Finish	Rosette	Function PGE	PCY	DMY R/L Single	ML-F Entry
15 Satin nickel	RP Round	\$ 597.00	\$ 599.00	\$ 291.00	\$ 1,251.00
	RQ Square	\$ 793.00	\$ 819.00	\$ 403.00	\$ 1,389.00
26 Polished chrome	RP Round	\$ 597.00	\$ 599.00	\$ 291.00	\$ 1,251.00
	RQ Square	\$ 793.00	\$ 819.00	\$ 403.00	\$ 1,389.00
26D Satin chrome	RP Round	\$ 597.00	\$ 599.00	\$ 291.00	\$ 1,251.00
	RQ Square	\$ 793.00	\$ 819.00	\$ 403.00	\$ 1,389.00

### Retail price

Finish	Escutcheon	Function PGE	PCY	DMY R/L Single	DMY R/L Pair	ML-F Entry
26 Polished chrome	EP Oval	\$ 772.00	\$ 785.00	\$ 387.00	\$ 712.00	\$ 1,200.00
	ER Rectangular	\$ 819.00	\$ 833.00	\$ 410.00	\$ 761.00	\$ 1,226.00
26D Satin chrome	EP Oval	\$ 772.00	\$ 785.00	\$ 387.00	\$ 712.00	\$ 1,200.00
	ER Rectangular	\$ 819.00	\$ 833.00	\$ 410.00	\$ 761.00	\$ 1,226.00

The options listed above are considered standard. Non-standard options are available upon request.

For more options on Rosettes and Escutcheon plates see page 23. For more options on Finishes see pages 12-13.

RE = Rectangular rosettes available for tubular latch application only. Add + \$ 30.00 LIST to the price of the RQ. For slim rosette and European version see pages 100-103.

#### Upcharges apply for the following special options:

- Extra thick door (> 2")
- Non-standard rosettes (rosettes not listed above)
- Non-standard finishes (finishes not listed above)
- Split finishes

See page 17 for pricing. Exclusions may apply.

#### Matching elements

- Pg 168 Mortise lock functions
- Pg 152 Deadbolts
- Pg 154 Privacy Bolts
- Pg 156 Escutcheons with deadbolts
- Pg 160 Multi-Point Trim functions

European window lever style available in the same design. Call for pricing.

# H 1748 Estrella



Material: Brass  
Collection: Lab  
Group: 3

Standard option (mm/inches)

**RP Round rosette**

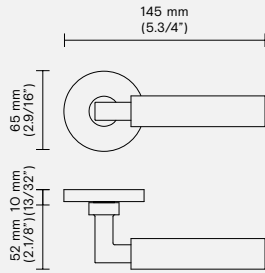

Standard option (mm/inches)

**RQ Square rosette**

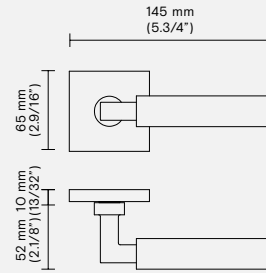

Escutcheon options (mm/inches)

**EP Oval plate**

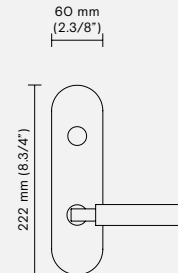

**ER Rectangular plate**

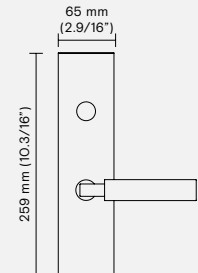

Slim rosette available - See pages 102-103

Conversions from metric to U.S. measurements are approximate.

**Retail price**

Finish	Rosette	Function PGE	PCY	DMY R/L Single	ML-F Entry
06B Brunito	RP Round	\$ 569.00	\$ 571.00	\$ 278.00	\$ 1,251.00
	RQ Square	\$ 757.00	\$ 781.00	\$ 385.00	\$ 1,389.00
14 Polished nickel	RP Round	\$ 569.00	\$ 571.00	\$ 278.00	\$ 1,251.00
	RQ Square	\$ 757.00	\$ 781.00	\$ 385.00	\$ 1,389.00
15 Satin nickel	RP Round	\$ 529.00	\$ 553.00	\$ 274.00	\$ 1,251.00
	RQ Square	\$ 637.00	\$ 673.00	\$ 337.00	\$ 1,389.00
26 Polished chrome	RP Round	\$ 569.00	\$ 571.00	\$ 278.00	\$ 1,251.00
	RQ Square	\$ 757.00	\$ 781.00	\$ 385.00	\$ 1,389.00
26D Satin chrome	RP Round	\$ 529.00	\$ 553.00	\$ 274.00	\$ 1,251.00
	RQ Square	\$ 637.00	\$ 673.00	\$ 337.00	\$ 1,389.00

**Retail price**

Finish	Escutcheon	Function PGE	PCY	DMY R/L Single	DMY R/L Pair	ML-F Entry
26 Polished chrome	EP Oval	\$ 772.00	\$ 785.00	\$ 387.00	\$ 712.00	\$ 1,200.00
	ER Rectangular	\$ 819.00	\$ 833.00	\$ 410.00	\$ 761.00	\$ 1,226.00
26D Satin chrome	EP Oval	\$ 772.00	\$ 785.00	\$ 387.00	\$ 712.00	\$ 1,200.00
	ER Rectangular	\$ 819.00	\$ 833.00	\$ 410.00	\$ 761.00	\$ 1,226.00

The options listed above are considered standard. Non-standard options are available upon request.

For more options on Rosettes and Escutcheon plates see page 23. For more options on Finishes see pages 12-13.

RE = Rectangular rosettes available for tubular latch application only. Add + \$ 30.00 LIST to the price of the RQ. For slim rosette and European version see pages 100-103.

**Upcharges apply for the following special options:**

- Extra thick door (> 2")
- Non-standard rosettes (rosettes not listed above)
- Non-standard finishes (finishes not listed above)
- Split finishes

See page 17 for pricing. Exclusions may apply.

**Matching elements**

- Pg 168 Mortise lock functions
- Pg 152 Deadbolts
- Pg 154 Privacy Bolts
- Pg 156 Escutcheons with deadbolts
- Pg 160 Multi-Point Trim functions

European window lever style available in the same design. Call for pricing.



# H 4730

## White

Material  
Zinc alloy +  
Stainless steel  
AISI 304

Collection  
Lab

Group  
1

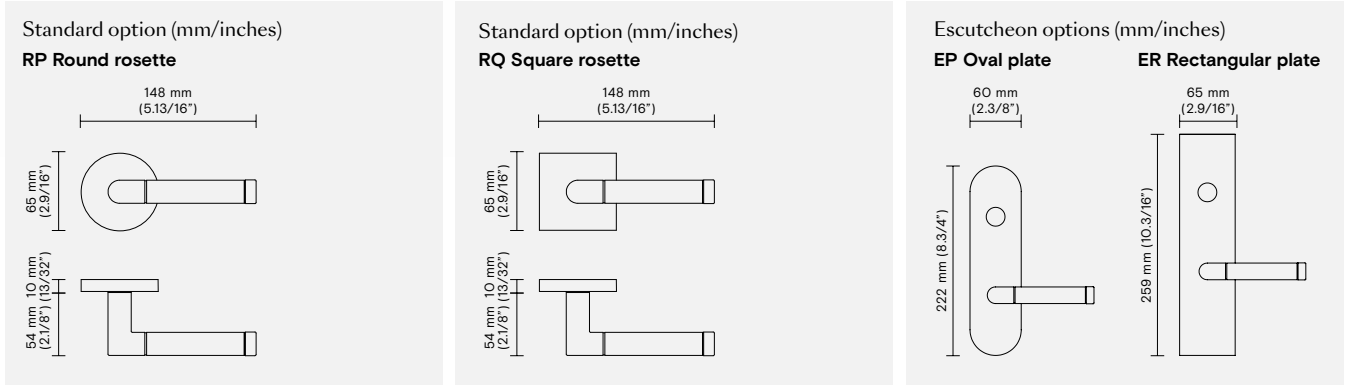

Slim rosette available - See pages 102-103

Conversions from metric to U.S. measurements are approximate.

### Retail price

Finish	Rosette	Function PGE	PCY	DMY R/L Single	ML-F Entry
26/32D Polished chrome / Satin stainless steel*	RP Round	\$ 341.00	\$ 356.00	\$159.00	\$ 961.00
	RQ Square	\$ 459.00	\$ 475.00	\$219.00	\$ 1,100.00

### Retail price

Finish	Escutcheon	Function PGE	PCY	DMY R/L Single	DMY R/L Pair	ML-F Entry
26/32D Polished chrome / Satin stainless steel*	EP Oval	\$ 520.00	\$ 545.00	\$ 254.00	\$ 455.00	\$ 899.00
	ER Rectangular	\$ 570.00	\$ 596.00	\$ 279.00	\$ 506.00	\$ 935.00

\* Note: the shank and the end cap portions are polished while the grip is satin made of stainless steel. The rosette/escutcheon is polished.

The options listed above are considered standard.  
Non-standard options are available upon request.

For more options on Rosettes and Escutcheon plates see page 23.  
For more options on Finishes see pages 12-13.

RE = Rectangular rosettes available for tubular latch application only.  
Add + \$ 30.00 LIST to the price of the RQ.  
For slim rosette and European version see pages 100-103.

#### Upcharges apply for the following special options:

- Extra thick door (> 2")
- Non-standard rosettes (rosettes not listed above)
- Non-standard finishes (finishes not listed above)
- Split finishes

See page 17 for pricing. Exclusions may apply.

#### Matching elements

- Pg 168 Mortise lock functions
- Pg 152 Deadbolts
- Pg 154 Privacy Bolts
- Pg 156 Escutcheons with deadbolts
- Pg 160 Multi-Point Trim functions

European window lever style available in the same design.  
Call for pricing.



# H 4742

## Coral

Material	Collection	Group
Zinc alloy + Stainless steel AISI 304	Lab	1

### Standard option (mm/inches)

#### RP Round rosette

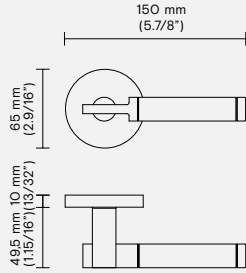

### Standard option (mm/inches)

#### RQ Square rosette

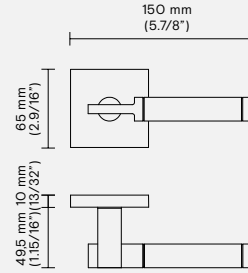

### Escutcheon options (mm/inches)

#### EP Oval plate

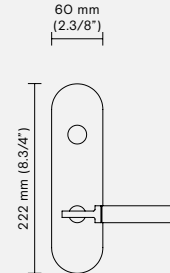

#### ER Rectangular plate

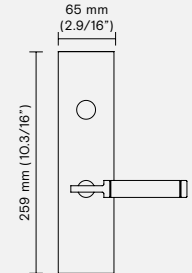

**Slim rosette** available - See pages 102-103

Conversions from metric to U.S. measurements are approximate.

### Retail price

Finish	Rosette	Function		DMY R/L Single	ML-F Entry
		PGE	PCY		
26/32D Polished chrome / Satin stainless steel*	RP Round	\$ 341.00	\$ 356.00	\$159.00	\$ 961.00
	RQ Square	\$ 459.00	\$ 475.00	\$219.00	\$ 1,100.00

### Retail price

Finish	Escutcheon	Function		DMY R/L Single	DMY R/L Pair	ML-F Entry
		PGE	PCY			
26/32D Polished chrome / Satin stainless steel*	EP Oval	\$ 520.00	\$ 545.00	\$ 254.00	\$ 455.00	\$ 899.00
	ER Rectangular	\$ 570.00	\$ 596.00	\$ 279.00	\$ 506.00	\$ 935.00

\* **Note:** the base, the shank and the end cap portions are polished while the grip is satin made of stainless steel. The rosette/escutcheon is polished.

The options listed above are considered standard.  
Non-standard options are available upon request.

For more options on Rosettes and Escutcheon plates see page 23.  
For more options on Finishes see pages 12-13.

RE = Rectangular rosettes available for tubular latch application only.  
Add + \$ 30.00 LIST to the price of the RQ.  
For slim rosette and European version see pages 100-103.

#### Upcharges apply for the following special options:

- Extra thick door (> 2")
- Non-standard rosettes (rosettes not listed above)
- Non-standard finishes (finishes not listed above)
- Split finishes

See page 17 for pricing. Exclusions may apply.

#### Matching elements

- Pg 168 Mortise lock functions
- Pg 152 Deadbolts
- Pg 154 Privacy Bolts
- Pg 156 Escutcheons with deadbolts
- Pg 160 Multi-Point Trim functions

European window lever style available in the same design.  
Call for pricing.



# H 5008

## Taller Design Ricardo Bofill

Material	Collection	Group
Stainless steel AISI 316 L	Fusital	7

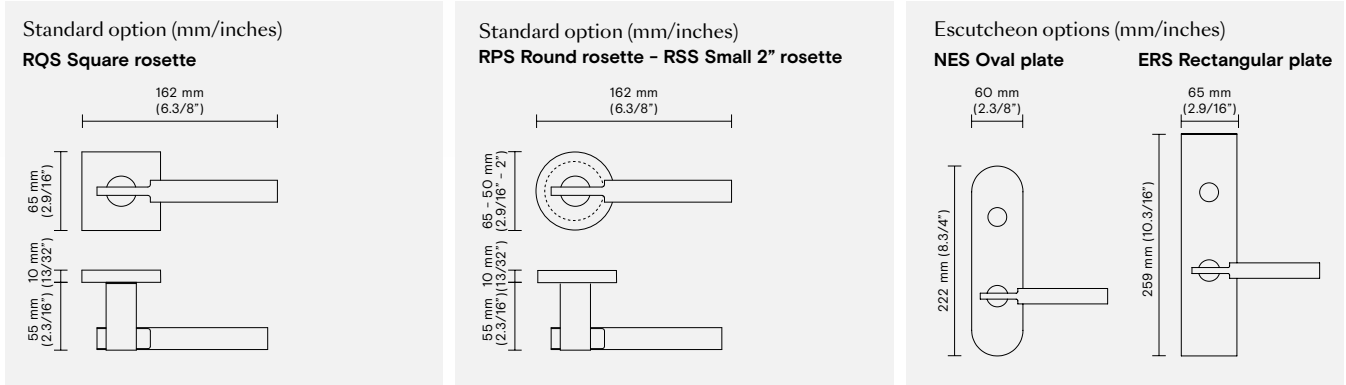

Conversions from metric to U.S. measurements are approximate.

### Retail price

Finish	Rosette	Function PGE	PCY	DMY R/L Single	ML-F Entry
32 Polished stainless steel	RPS Round	\$ 779.00	\$ 804.00	\$ 378.00	\$ 1,516.00
	RQS Square	\$ 947.00	\$ 987.00	\$ 473.00	\$ 1,542.00
	RSS Round	\$ 747.00	\$ 934.00	\$ 358.00	\$ 1,303.00
32D Satin stainless steel	RPS Round	\$ 715.00	\$ 737.00	\$ 346.00	\$ 1,516.00
	RQS Square	\$ 883.00	\$ 923.00	\$ 441.00	\$ 1,542.00
	RSS Round	\$ 683.00	\$ 870.00	\$ 324.00	\$ 1,303.00

**Note:** The RSS Small round rosette does not fit a privacy pin. Supplied with 105. RSS Trims (2") note recommended for commercial use RSS privacy bolt.

### Retail price

Finish	Escutcheon	Function PGE	PCY	DMY R/L Single	DMY R/L Pair	ML-F Entry
32D Satin stainless steel	NES Oval	\$ 885.00	\$ 961.00	\$ 444.00	\$ 859.00	\$ 1,340.00
	ERS Rectangular	\$ 949.00	\$ 985.00	\$ 481.00	\$ 899.00	\$ 1,579.00

The options listed above are considered standard. Non-standard options are available upon request.

For more options on Rosettes and Escutcheon plates see page 23. For more options on Finishes see pages 12-13.

RE = Rectangular rosettes available for tubular latch application only. Add + \$ 30.00 LIST to the price of the RQ. For slim rosette and European version see pages 100-103.

#### Upcharges apply for the following special options:

- Extra thick door (> 2")
- Non-standard rosettes (rosettes not listed above)
- Non-standard finishes (finishes not listed above)
- Split finishes

See page 17 for pricing. Exclusions may apply.

#### Matching elements

- Pg 168 Mortise lock functions
- Pg 152 Deadbolts
- Pg 154 Privacy Bolts
- Pg 156 Escutcheons with deadbolts
- Pg 160 Multi-Point Trim functions

European window lever style available in the same design. Call for pricing.



# H 5014

## Bernina

Material	Collection	Group
Stainless steel AISI 316 L	Fusital	6

### Standard option (mm/inches)

#### RPS Round rosette - RSS Small 2" rosette

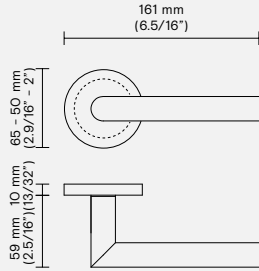

### Standard option (mm/inches)

#### RQS Square rosette

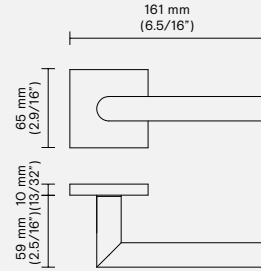

### Escutcheon options (mm/inches)

#### NES Oval plate

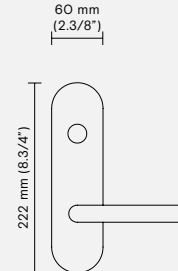

#### ERS Rectangular plate

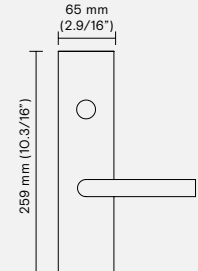

Conversions from metric to U.S. measurements are approximate.

### Retail price

Finish	Rosette	Function PGE	PCY	DMY R/L Single	ML-F Entry
32 Polished stainless steel	RPS Round	\$ 467.00	\$ 504.00	\$ 227.00	\$ 1,314.00
	RQS Square	\$ 586.00	\$ 623.00	\$ 287.00	\$ 1,340.00
	RSS Round	\$ 422.00	\$ 657.00	\$ 192.00	\$ 1,049.00
32D Satin stainless steel	RPS Round	\$ 403.00	\$ 414.00	\$ 200.00	\$ 1,314.00
	RQS Square	\$ 522.00	\$ 533.00	\$ 260.00	\$ 1,340.00
	RSS Round	\$ 360.00	\$ 548.00	\$ 166.00	\$ 1,049.00

**Note:** The RSS Small round rosette does not fit a privacy pin. Supplied with 105. RSS Trims (2") note recommended for commercial use RSS privacy bolt.

### Retail price

Finish	Escutcheon	Function PGE	PCY	DMY R/L Single	DMY R/L Pair	ML-F Entry
32D Satin stainless steel	NES Oval	\$ 785.00	\$ 796.00	\$ 387.00	\$ 724.00	\$ 1,163.00
	ERS Rectangular	\$ 819.00	\$ 833.00	\$ 410.00	\$ 772.00	\$ 1,200.00

The options listed above are considered standard. Non-standard options are available upon request.

For more options on Rosettes and Escutcheon plates see page 23. For more options on Finishes see pages 12-13.

RE = Rectangular rosettes available for tubular latch application only. Add + \$ 30.00 LIST to the price of the RQ. For slim rosette and European version see pages 100-103.

#### Upcharges apply for the following special options:

- Extra thick door (> 2")
- Non-standard rosettes (rosettes not listed above)
- Non-standard finishes (finishes not listed above)
- Split finishes

See page 17 for pricing. Exclusions may apply.

#### Matching elements

- Pg 168 Mortise lock functions
- Pg 152 Deadbolts
- Pg 154 Privacy Bolts
- Pg 156 Escutcheons with deadbolts
- Pg 160 Multi-Point Trim functions

European window lever style available in the same design. Call for pricing.



# H 5015

## Antonio Citterio

Material	Collection	Group
Stainless steel AISI 316 L	Fusital	8

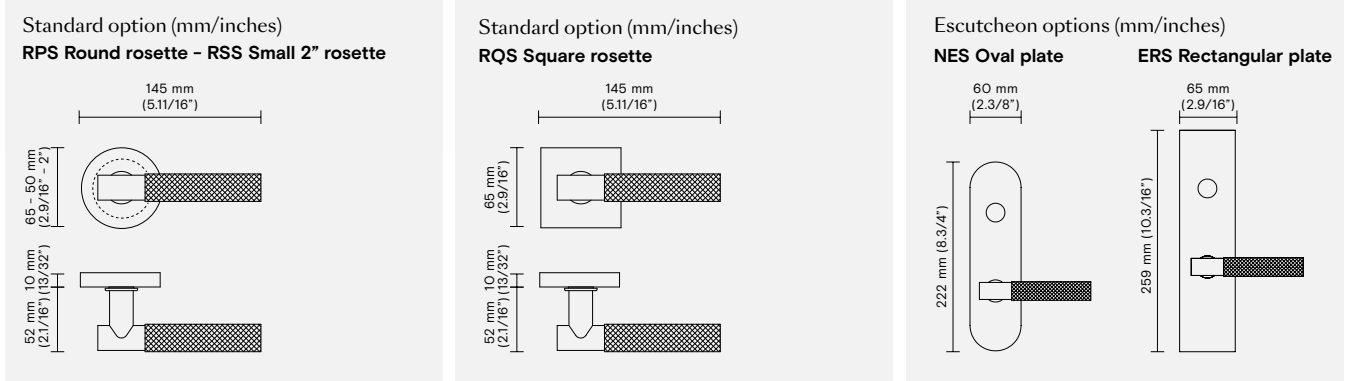

Conversions from metric to U.S. measurements are approximate.

### Retail price

Finish	Rosette	Function PGE	PCY	DMY R/L Single	ML-F Entry
<b>32</b> Polished stainless steel	<b>RPS</b> Round	\$ 1,109.00	\$ 1,145.00	\$ 549.00	\$ 1,844.00
	<b>RQS</b> Square	\$ 1,222.00	\$ 1,258.00	\$ 606.00	\$ 1,869.00
	<b>RSS</b> Round	\$ 1,070.00	\$ 1,272.00	\$ 517.00	\$ 1,579.00
<b>32D</b> Satin stainless steel	<b>RPS</b> Round	\$ 880.00	\$ 892.00	\$ 427.00	\$ 1,844.00
	<b>RQS</b> Square	\$ 993.00	\$ 1,006.00	\$ 484.00	\$ 1,869.00
	<b>RSS</b> Round	\$ 852.00	\$ 1,020.00	\$ 408.00	\$ 1,579.00

**Note:** The RSS Small round rosette does not fit a privacy pin. Supplied with 105.  
 RSS Trims (2") note recommended for commercial use RSS privacy bolt.

### Retail price

Finish	Escutcheon	Function PGE	PCY	DMY R/L Single	DMY R/L Pair	ML-F Entry
<b>32D</b> Satin stainless steel	<b>NES</b> Oval	\$ 1,264.00	\$ 1,289.00	\$ 633.00	\$ 1,200.00	\$ 1,617.00
	<b>ERS</b> Rectangular	\$ 1,328.00	\$ 1,340.00	\$ 658.00	\$ 1,251.00	\$ 1,655.00

The options listed above are considered standard.  
 Non-standard options are available upon request.

For more options on Rosettes and Escutcheon plates see page 23.  
 For more options on Finishes see pages 12-13.

RE = Rectangular rosettes available for tubular latch application only.  
 Add + \$ 30.00 LIST to the price of the RQ.  
 For slim rosette and European version see pages 100-103.

#### Upcharges apply for the following special options:

- Extra thick door (> 2")
- Non-standard rosettes (rosettes not listed above)
- Non-standard finishes (finishes not listed above)
- Split finishes

See page 17 for pricing. Exclusions may apply.

#### Matching elements

- Pg 168 Mortise lock functions
- Pg 152 Deadbolts
- Pg 154 Privacy Bolts
- Pg 156 Escutcheons with deadbolts
- Pg 160 Multi-Point Trim functions

European window lever style available in the same design.  
 Call for pricing.



# H 5015 with leather

## Antonio Citterio

Material	Collection	Group
Stainless steel AISI 316 L + Leather	Fusital	9

Standard option (mm/inches)

**RPS Round rosette - RSS Small 2" rosette**

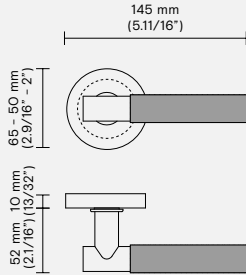

Standard option (mm/inches)

**RQS Square rosette**

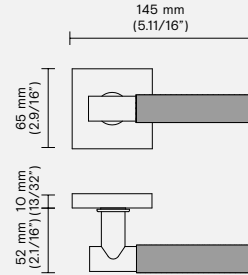

Escutcheon options (mm/inches)

**NES Oval plate**

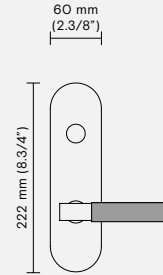

**ERS Rectangular plate**

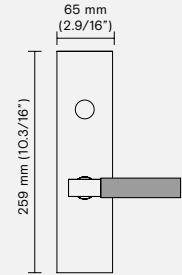

Conversions from metric to U.S. measurements are approximate.

**Retail price**

Finish	Rosette	Function PGE	PCY	DMY R/L Single	ML-F Entry
<b>32/BLK</b> Polished stainless steel / Black leather	<b>RPS</b> Round	\$ 1,401.00	\$ 1,440.00	\$ 700.00	\$ 2,299.00
	<b>RQS</b> Square	\$ 1,515.00	\$ 1,553.00	\$ 757.00	\$ 2,464.00
	<b>RSS</b> Round	\$ 1,381.00	\$ 1,566.00	\$ 673.00	\$ 2,009.00
<b>32/ORNG</b> Polished stainless steel / Orange leather	<b>RPS</b> Round	\$ 1,401.00	\$ 1,440.00	\$ 700.00	\$ 2,299.00
	<b>RQS</b> Square	\$ 1,515.00	\$ 1,553.00	\$ 757.00	\$ 2,464.00
	<b>RSS</b> Round	\$ 1,381.00	\$ 1,566.00	\$ 673.00	\$ 2,009.00
<b>32D/BLK</b> Satin stainless steel / Black leather	<b>RPS</b> Round	\$ 1,337.00	\$ 1,376.00	\$ 668.00	\$ 2,299.00
	<b>RQS</b> Square	\$ 1,451.00	\$ 1,489.00	\$ 725.00	\$ 2,464.00
	<b>RSS</b> Round	\$ 1,317.00	\$ 1,502.00	\$ 641.00	\$ 2,009.00
<b>32D/ORNG</b> Satin stainless steel / Orange leather	<b>RPS</b> Round	\$ 1,337.00	\$ 1,376.00	\$ 668.00	\$ 2,299.00
	<b>RQS</b> Square	\$ 1,451.00	\$ 1,489.00	\$ 725.00	\$ 2,464.00
	<b>RSS</b> Round	\$ 1,317.00	\$ 1,502.00	\$ 641.00	\$ 2,009.00

**Note:** The RSS Small round rosette does not fit a privacy pin. Supplied with 105. RSS Trims (2") note recommended for commercial use RSS privacy bolt.

**Retail price**

Finish	Escutcheon	Function PGE	PCY	DMY R/L Single	DMY R/L Pair	ML-F Entry
<b>32D/BLK</b> Satin stainless steel / Black leather	<b>NES</b> Oval	\$ 1,627.00	\$ 1,674.00	\$ 809.00	\$ 1,567.00	\$ 2,059.00
	<b>ERS</b> Rectangular	\$ 1,687.00	\$ 1,747.00	\$ 844.00	\$ 1,627.00	\$ 2,101.00
<b>32D/ORNG</b> Satin stainless steel / Orange leather	<b>NES</b> Oval	\$ 1,627.00	\$ 1,674.00	\$ 809.00	\$ 1,567.00	\$ 2,059.00
	<b>ERS</b> Rectangular	\$ 1,687.00	\$ 1,747.00	\$ 844.00	\$ 1,627.00	\$ 2,101.00

The options listed above are considered standard. Non-standard options are available upon request.

For more options on Rosettes and Escutcheon plates see page 23. For more options on Finishes see pages 12-13.

RE = Rectangular rosettes available for tubular latch application only. Add + \$ 30.00 LIST to the price of the RQ. For slim rosette and European version see pages 100-103.

**Upcharges apply for the following special options:**

- Extra thick door (> 2")
- Non-standard rosettes (rosettes not listed above)
- Non-standard finishes (finishes not listed above)
- Split finishes

See page 17 for pricing. Exclusions may apply.

**Matching elements**

- Pg 168 Mortise lock functions
- Pg 152 Deadbolts
- Pg 154 Privacy Bolts
- Pg 156 Escutcheons with deadbolts
- Pg 160 Multi-Point Trim functions

European window lever style available in the same design. Call for pricing.



# H 5017

## Hans Kollhoff

Material	Collection	Group
Stainless steel AISI 316 L	Fusital	8

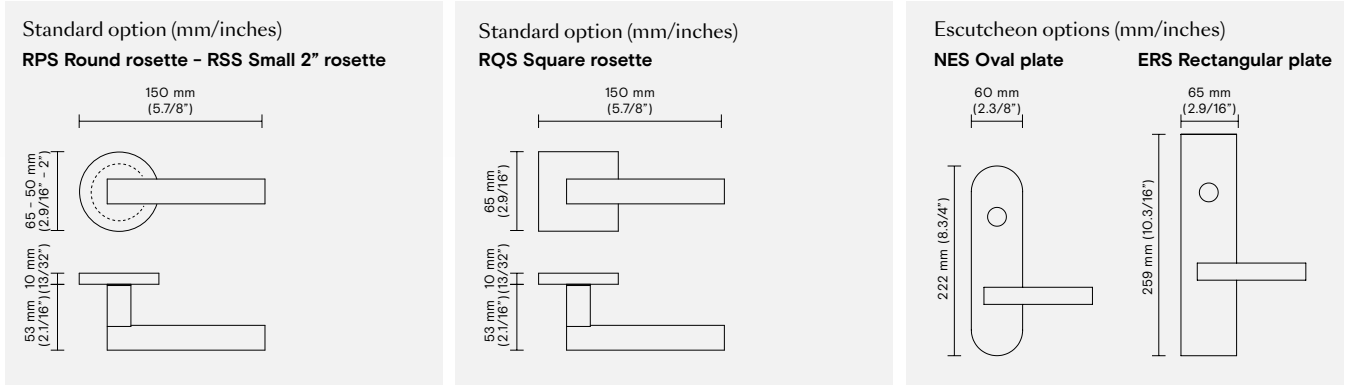

Conversions from metric to U.S. measurements are approximate.

### Retail price

Finish	Rosette	Function PGE	PCY	DMY R/L Single	ML-F Entry
<b>32</b> Polished stainless steel	<b>RPS</b> Round	\$ 1,255.00	\$ 1,295.00	\$ 616.00	\$ 1,844.00
	<b>RQS</b> Square	\$ 1,374.00	\$ 1,414.00	\$ 675.00	\$ 1,869.00
	<b>RSS</b> Round	\$ 1,207.00	\$ 1,437.00	\$ 577.00	\$ 1,579.00
<b>32D</b> Satin stainless steel	<b>RPS</b> Round	\$ 987.00	\$ 998.00	\$ 483.00	\$ 1,844.00
	<b>RQS</b> Square	\$ 1,105.00	\$ 1,117.00	\$ 543.00	\$ 1,869.00
	<b>RSS</b> Round	\$ 942.00	\$ 1,143.00	\$ 459.00	\$ 1,579.00

**Note:** The RSS Small round rosette does not fit a privacy pin. Supplied with 105.  
 RSS Trims (2") note recommended for commercial use RSS privacy bolt.

### Retail price

Finish	Escutcheon	Function PGE	PCY	DMY R/L Single	DMY R/L Pair	ML-F Entry
<b>32D</b> Satin stainless steel	<b>NES</b> Oval	\$ 1,264.00	\$ 1,289.00	\$ 633.00	\$ 1,200.00	\$ 1,617.00
	<b>ERS</b> Rectangular	\$ 1,328.00	\$ 1,340.00	\$ 658.00	\$ 1,251.00	\$ 1,655.00

The options listed above are considered standard.  
 Non-standard options are available upon request.

For more options on Rosettes and Escutcheon plates see page 23.  
 For more options on Finishes see pages 12-13.

RE = Rectangular rosettes available for tubular latch application only.  
 Add + \$ 30.00 LIST to the price of the RQ.  
 For slim rosette and European version see pages 100-103.

#### Upcharges apply for the following special options:

- Extra thick door (> 2")
- Non-standard rosettes (rosettes not listed above)
- Non-standard finishes (finishes not listed above)
- Split finishes

See page 17 for pricing. Exclusions may apply.

#### Matching elements

- Pg 168 Mortise lock functions
- Pg 152 Deadbolts
- Pg 154 Privacy Bolts
- Pg 156 Escutcheons with deadbolts
- Pg 160 Multi-Point Trim functions

European window lever style available in the same design.  
 Call for pricing.

## EUROPEAN TRIM – Rosette diameter 2” (50mm), thickness 13/32” (10mm)

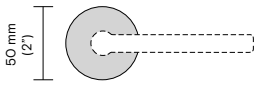

**Round 50 mm (2")**  
**RS50** Round rosette brass  
**RSS50** Round rosette stainless steel

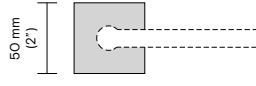

**Square 50 mm (2")**  
**RSQ50** Square rosette brass  
**RSQS50** Square rosette stainless steel

Conversions from metric to U.S. measurements are approximate.

### Group 1

H 198, H 1003, H 1022, H 1024, H 1050, H 4730, H 4742, K 1155, K 1168, K 1170

Model	Retail price	
	Round rosette	Square rosette
R8Y (PGE)	\$ 319.00	\$ 444.00
R8 BZG (PCY with PCY thumb turn)	\$ 680.00	\$ 804.00

### Group 2

H 165, H 176, H 1016, H 1026, H 1027, H 1044 U, H 1045, H 1046, H 1049, H 1052, H 1054, H 1056, H 1057, H 1061, H 1062, H 1066

Model	Retail price	
	Round rosette	Square rosette
R8Y (PGE)	\$ 394.00	\$ 519.00
R8 BZG (PCY with PCY thumb turn)	\$ 754.00	\$ 880.00

### Group 3

H 1039, H 1040, H 1060, H 1068, H 1069, H 1748, K 1054, K 1056, K 1060, K 1061, K 1171, K 1730

Model	Retail price	
	Round rosette	Square rosette
R8Y (PGE)	\$ 606.00	\$ 741.00
R8 BZG (PCY with PCY thumb turn)	\$ 967.00	\$ 1,078.00

### Group 4

H 163, H 192, H 1004, H 1037, H 1043, H 1044, H 1058, H 411, H 414, H 415, H 416, H 419

Model	Retail price	
	Round rosette	Square rosette
R8Y (PGE)	\$ 280.00	\$ 405.00
R8 BZG (PCY with PCY thumb turn)	\$ 642.00	\$ 766.00

### Group 5

H 315, H 317, H 327, H 330, H 334, H 338, H 348, H 361, H 364, H 367, H 368, H 370, H 372, H 381, H 382, H 383, H 385, H 386, K 383

Model	Retail price	
	Round rosette	Square rosette
R8Y (PGE)	\$ 455.00	\$ 579.00
R8 BZG (PCY with PCY thumb turn)	\$ 804.00	\$ 929.00

The configuration above is only suitable for European mortise locks. The lock is not included in the prices. European mortise locks (mechanical and magnetic) can be purchased separately. Call for pricing.

The prices above are for the standard finishes of each lever listed. See corresponding catalog pages. Different finishes are available upon request. See pages 12-13 for more finish options.

The privacy sets are supplied with the European privacy thumb turn: K1704 R678 50 BZG (round) or K1225 R678 50 BZG (square).

## EUROPEAN TRIM – Rosette diameter 2” (50mm), thickness 13/32” (10mm)

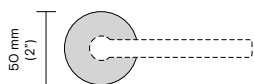

**Round 50 mm (2”) – Thickness 10 mm**  
**RS50** Round rosette brass  
**RSS50** Round rosette stainless steel

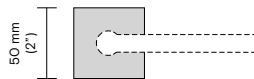

**Square 50 mm (2”) – Thickness 10 mm**  
**RSQ50** Square rosette brass  
**RSQS50** Square rosette stainless steel

Conversions from metric to U.S. measurements are approximate.

### Group 6

H 311, H 329, H 335, H 343, H 359, H 376, H 378, H 384, H 5014, K 378

Model	Retail price	
	RP/RPS	RQ/RQS
R8Y (PGE)	\$ 580.00	\$ 706.00
R8 BZG (PCY with PCY thumb turn)	\$ 943.00	\$ 1,068.00

### Group 7

H 377, H 5008, K 5301, K 377

Model	Retail price	
	RP/RPS	RQ/RQS
R8Y (PGE)	\$ 924.00	\$ 1,048.00
R8 BZG (PCY with PCY thumb turn)	\$ 1,296.00	\$ 1,442.00

### Group 8

H 356, H 379, H 380, H 5015/32D, H 5017

Model	Retail price	
	RP/RPS	RQ/RQS
R8Y (PGE)	\$ 985.00	\$ 1,079.00
R8 BZG (PCY with PCY thumb turn)	\$ 1,393.00	\$ 1,512.00

### Group 9

H 5015 Black Leather, H 5015 Orange Leather

Model	Retail price	
	RP/RPS	RQ/RQS
R8Y (PGE)	\$ 985.00	\$ 1,079.00
R8 BZG (PCY with PCY thumb turn)	\$ 1,393.00	\$ 1,512.00

The configuration above is only suitable for European mortise locks.  
 The lock is not included in the prices.  
 European mortise locks (mechanical and magnetic) can be purchased separately. Call for pricing.

The prices above are for the standard finishes of each lever listed. See corresponding catalog pages.  
 Different finishes are available upon request.  
 See pages 12-13 for more finish options.

The privacy sets are supplied with the European privacy thumb turn: K1704 R678 50 BZG (round) or K1225 R678 50 BZG (square).

**SLIM ROSETTES – Rosette diameter 2” (50mm), thickness 3/16” (5mm)**

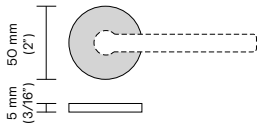

**Round 50 mm (2")**  
RSB Round rosette brass

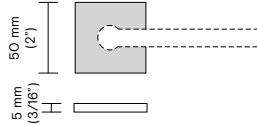

**Square 50 mm (2")**  
RSBQ Square rosette brass

Valli offers special slim rosettes = 3/16” (5mm) exclusively for the models below. To order, select a lever/knob and use the code RSB (round) or RSBQ (square). For privacy bolt only price see page 154.

**Group 1**

H 198, H 1003, H 1022, H 1024, H 1024, H 1050, H 4730, H 4742, K 1155, K 1168, K 1170

Model	Retail price	
	RSB	RSBQ
R8Y (PGE)	\$ 364.00	\$ 490.00
R8 BZG (PCY with PCY thumb turn)	\$ 776.00	\$ 901.00
Dummy RH or LH	\$ 164.00	\$ 215.00

**Group 2**

H 1026, H 1045, H 1046, H 1049, H 1052, H 1054, H 1056, H 1061, H 1062, H 1066

Model	Retail price	
	RSB	RSBQ
R8Y (PGE)	\$ 439.00	\$ 564.00
R8 BZG (PCY with PCY thumb turn)	\$ 852.00	\$ 976.00
Dummy RH or LH	\$ 201.00	\$ 264.00

**Group 3**

H 1039, H 1040, H 1060, H 1068, H 1069, H 1748, K 1054, K 1056, K 1060, K 1061, K 1171

Model	Retail price	
	RSB	RSBQ
R8Y (PGE)	\$ 652.00	\$ 776.00
R8 BZG (PCY with PCY thumb turn)	\$ 1,026.00	\$ 1,078.00
Dummy RH or LH	\$ 315.00	\$ 359.00

**Group 4**

H 163, H 192, H 1043, H 1044, H 1058

Model	Retail price	
	RSB	RSBQ
R8Y (PGE)	\$ 324.00	\$ 451.00
R8 BZG (PCY with PCY thumb turn)	\$ 739.00	\$ 863.00
Dummy RH or LH	\$ 152.00	\$ 213.00

**Group 5**

H 315, H 317, H 327, H 330, H 334, H 338, H 348, H 361, H 364, H 367, H 368, H 370, H 372, H 381, H 382, H 383, H 385, H 386, K 383

Model	Retail price	
	RSB	RSBQ
R8Y (PGE)	\$ 501.00	\$ 626.00
R8 BZG (PCY with PCY thumb turn)	\$ 901.00	\$ 1,026.00
Dummy RH or LH	\$ 238.00	\$ 301.00

The configuration above is only suitable for European mortise locks. The lock is not included in the prices. European mortise locks (mechanical and magnetic) can be purchased separately. Call for pricing.

The prices above are for the standard finishes of each lever listed. See corresponding catalog pages. Different finishes are available upon request. See pages 12-13 for more finish options.

The privacy sets are supplied with the European privacy thumb turn: K1704 R678 50 BZG (round) or K1225 R678 50 BZG (square).

## SLIM ROSETTES – Rosette diameter 2” (50mm), thickness 3/16” (5mm)

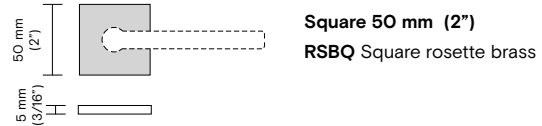
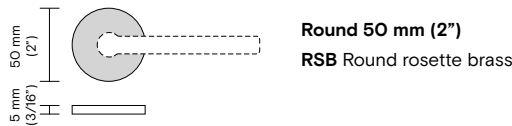

Valli offers special slim rosettes = 3/16” (5mm) exclusively for the models below. To order, select a lever/knob and use the code RSB (round) or RSBQ (square). For privacy bolt only price see page 154.

### Group 6

H 311, H 329, H 343, H 359, H 378, H 384, K 378

Model	Retail price	
	RSB	RSBQ
R8Y (PGE)	\$ 627.00	\$ 751.00
R8 BZG (PCY with PCY thumb turn)	\$ 1,039.00	\$ 1,164.00
Dummy RH or LH	\$ 301.00	\$ 363.00

### Group 7

H 377, K 377

Model	Retail price	
	RSB	RSBQ
R8Y (PGE)	\$ 1,014.00	\$ 1,139.00
R8 BZG (PCY with PCY thumb turn)	\$ 1,413.00	\$ 1,538.00
Dummy RH or LH	\$ 490.00	\$ 551.00

### Group 8

H 356, H 379, H 380

Model	Retail price	
	RSB	RSBQ
R8Y (PGE)	\$ 1,076.00	\$ 1,201.00
R8 BZG (PCY with PCY thumb turn)	\$ 1,489.00	\$ 1,614.00
Dummy RH or LH	\$ 526.00	\$ 588.00

The configuration above is only suitable for European mortise locks. The lock is not included in the prices. European mortise locks (mechanical and magnetic) can be purchased separately. Call for pricing.

The prices above are for the standard finishes of each lever listed. See corresponding catalog pages. Different finishes are available upon request. See pages 12-13 for more finish options.

The privacy sets are supplied with the European privacy thumb turn: K1704 R678 50 BZG (round) or K1225 R678 50 BZG (square).

# Door accessories







# K 377

## Steve Leung

Material	Collection	Group
Brass	Fusital	7

### Standard option (mm/inches)

#### RQ Square rosette

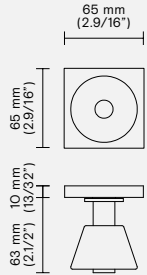

### Standard option (mm/inches)

#### RP Round rosette

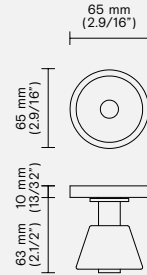

### Escutcheon options (mm/inches)

#### EP Oval plate

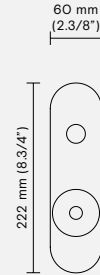

#### ER Rectangular plate

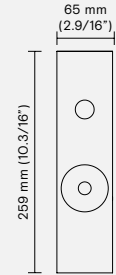

**Slim rosette** available - See pages 102-103

\*Only available on request  
Conversions from metric to U.S. measurements are approximate.

### Retail price

Finish	Rosette	Function		DMY R/L Single	ML-F Entry
		PGE	PCY		
03M Matt brass	RP Round	\$ 512.00	\$ 526.00	\$ 249.00	\$ 1,617.00
	RQ Square	\$ 643.00	\$ 658.00	\$ 310.00	\$ 1,755.00
16 Dull black	RP Round	\$ 429.00	\$ 440.00	\$ 210.00	\$ 1,617.00
	RQ Square	\$ 539.00	\$ 552.00	\$ 261.00	\$ 1,755.00
56 Dark bronze	RP Round	\$ 520.00	\$ 547.00	\$ 253.00	\$ 1,617.00
	RQ Square	\$ 896.00	\$ 907.00	\$ 442.00	\$ 1,755.00

The options listed above are considered standard.  
Non-standard options are available upon request.

For more options on Rosettes and Escutcheon plates see page 23.  
For more options on Finishes see pages 12-13.

RE = Rectangular rosettes available for tubular latch application only.  
Add + \$ 30.00 LIST to the price of the RQ.  
For slim rosette (European version) see pages 100-103.

#### Upcharges apply for the following special options:

- Extra thick door (> 2")
- Non-standard rosettes (rosettes not listed above)
- Non-standard finishes (finishes not listed above)
- Split finishes

See page 17 for pricing. Exclusions may apply.



# K 378

## Yabu Pushelberg

Material	Collection	Group
Brass	Fusital	6

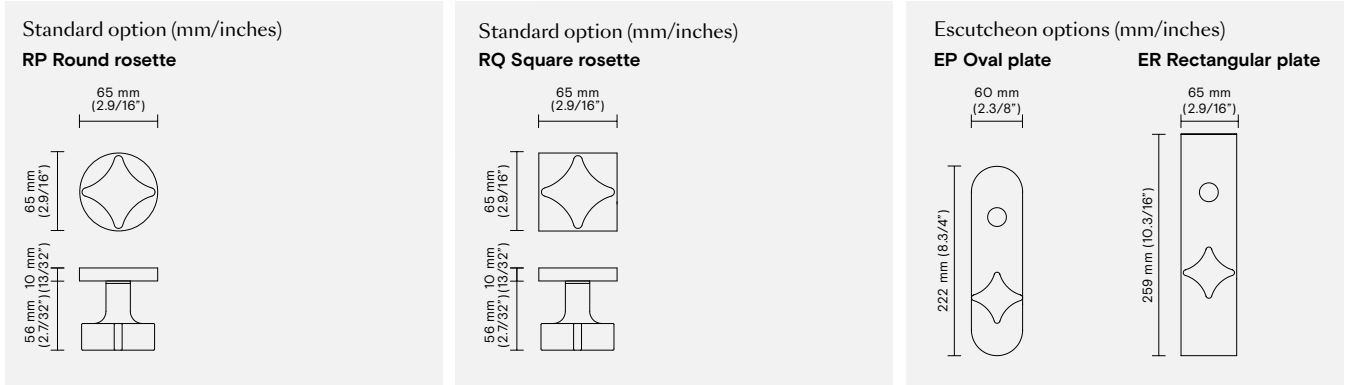

Slim rosette available - See pages 102-103

Conversions from metric to U.S. measurements are approximate.

### Retail price

Finish	Rosette	Function PGE	PCY	DMY R/L Single	ML-F Entry
17A Polished black nickel	RP Round	\$ 520.00	\$ 545.00	\$ 252.00	\$ 1,213.00
	RQ Square	\$ 861.00	\$ 872.00	\$ 428.00	\$ 1,389.00
26 Polished chrome	RP Round	\$ 451.00	\$ 464.00	\$ 270.00	\$ 1,213.00
	RQ Square	\$ 565.00	\$ 579.00	\$ 273.00	\$ 1,389.00
56 Dark bronze	RP Round	\$ 520.00	\$ 545.00	\$ 252.00	\$ 1,213.00
	RQ Square	\$ 861.00	\$ 872.00	\$ 428.00	\$ 1,389.00

### Retail price

Finish	Escutcheon	Function PGE	PCY	DMY R/L Single	DMY R/L Pair	ML-F Entry
26 Polished chrome	EP Oval	\$ 785.00	\$ 796.00	\$ 387.00	\$ 724.00	\$ 1,163.00
	ER Rectangular	\$ 819.00	\$ 833.00	\$ 410.00	\$ 772.00	\$ 1,200.00

The options listed above are considered standard. Non-standard options are available upon request.

For more options on Rosettes and Escutcheon plates see page 23. For more options on Finishes see pages 12-13.

RE = Rectangular rosettes available for tubular latch application only. Add + \$ 30.00 LIST to the price of the RQ. For slim rosette (European version) see pages 100-103.

#### Upcharges apply for the following special options:

- Extra thick door (> 2")
- Non-standard rosettes (rosettes not listed above)
- Non-standard finishes (finishes not listed above)
- Split finishes

See page 17 for pricing. Exclusions may apply.



# K 383

## Perkins&Will

Material	Collection	Group
Brass	Fusital	5

### Standard option (mm/inches)

#### RP Round rosette

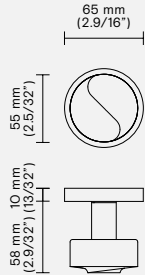

### Standard option (mm/inches)

#### RQ Square rosette

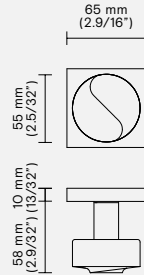

### Escutcheon options (mm/inches)

#### EP Oval plate

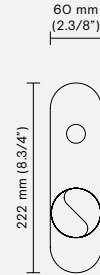

#### ER Rectangular plate

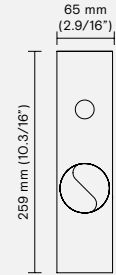

Slim rosette available - See pages 102-103

Conversions from metric to U.S. measurements are approximate.

### Retail price

Finish	Rosette	Function		DMY R/L Single	ML-F Entry
		PGE	PCY		
15 Satin nickel	RP Round	\$ 623.00	\$ 683.00	\$ 320.00	\$ 1,213.00
	RQ Square	\$ 754.00	\$ 782.00	\$ 386.00	\$ 1,389.00
16 Dull black	RP Round	\$ 530.00	\$ 573.00	\$ 259.00	\$ 1,213.00
	RQ Square	\$ 659.00	\$ 702.00	\$ 323.00	\$ 1,389.00
26D Satin chrome	RP Round	\$ 594.00	\$ 626.00	\$ 293.00	\$ 1,213.00
	RQ Square	\$ 734.00	\$ 767.00	\$ 373.00	\$ 1,389.00
56 Dark bronze	RP Round	\$ 647.00	\$ 702.00	\$ 335.00	\$ 1,213.00
	RQ Square	\$ 777.00	\$ 832.00	\$ 465.00	\$ 1,389.00

### Retail price

Finish	Escutcheon	Function		DMY R/L Single	DMY R/L Pair	ML-F Entry
		PGE	PCY			
26D Satin chrome	EP Oval	\$ 683.00	\$ 696.00	\$ 330.00	\$ 607.00	\$ 1,037.00
	ER Rectangular	\$ 734.00	\$ 747.00	\$ 369.00	\$ 671.00	\$ 1,075.00

The options listed above are considered standard. Non-standard options are available upon request.

For more options on Rosettes and Escutcheon plates see page 23.  
For more options on Finishes see pages 12-13.

RE = Rectangular rosettes available for tubular latch application only.  
Add + \$ 30.00 LIST to the price of the RQ.  
For slim rosette (European version) see pages 100-103.

#### Upcharges apply for the following special options:

- Extra thick door (> 2")
- Non-standard rosettes (rosettes not listed above)
- Non-standard finishes (finishes not listed above)
- Split finishes

See page 17 for pricing. Exclusions may apply.



# K 1054

## W.W.

Material	Collection	Group
Aluminum	Lab	3

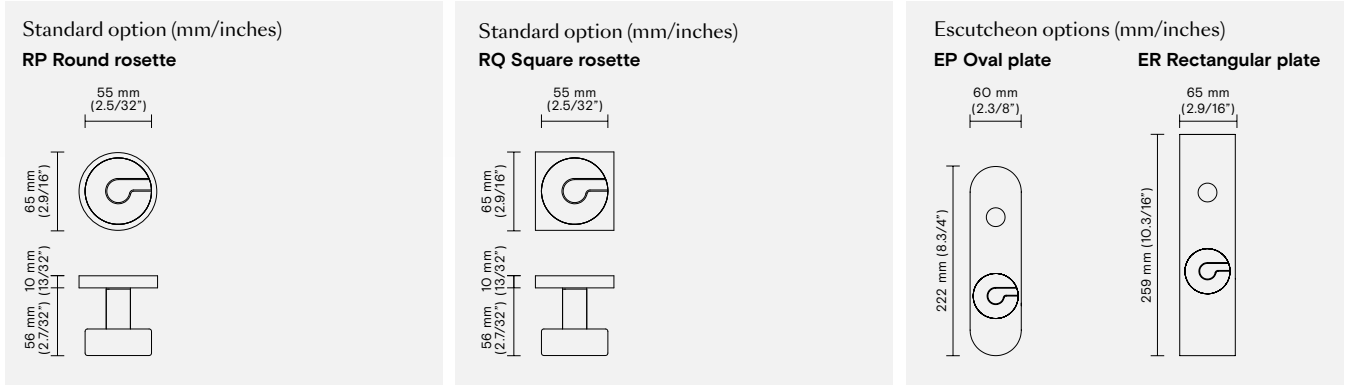

Slim rosette available - See pages 102-103

Conversions from metric to U.S. measurements are approximate.

### Retail price

Finish	Rosette	Function PGE	PCY	DMY R/L Single	ML-F Entry
03M Matt brass	RP Round	\$ 525.00	\$ 551.00	\$ 260.00	\$ 1,251.00
	RQ Square	\$ 607.00	\$ 615.00	\$ 290.00	\$ 1,389.00
15 Satin nickel	RP Round	\$ 528.00	\$ 550.00	\$ 261.00	\$ 1,251.00
	RQ Square	\$ 645.00	\$ 679.00	\$ 337.00	\$ 1,389.00
16 Dull black	RP Round	\$ 496.00	\$ 521.00	\$ 246.00	\$ 1,251.00
	RQ Square	\$ 575.00	\$ 582.00	\$ 274.00	\$ 1,389.00
26 Polished chrome	RP Round	\$ 509.00	\$ 528.00	\$ 250.00	\$ 1,251.00
	RQ Square	\$ 621.00	\$ 655.00	\$ 318.00	\$ 1,389.00

### Retail price

Finish	Escutcheon	Function PGE	PCY	DMY R/L Single	DMY R/L Pair	ML-F Entry
26 Polished chrome	EP Oval	\$ 809.00	\$ 823.00	\$ 405.00	\$ 747.00	\$ 1,200.00
	ER Rectangular	\$ 859.00	\$ 873.00	\$ 430.00	\$ 798.00	\$ 1,226.00

The options listed above are considered standard. Non-standard options are available upon request.

For more options on Rosettes and Escutcheon plates see page 23.  
For more options on Finishes see pages 12-13.  
RE = Rectangular rosettes available for tubular latch application only.  
Add + \$ 30.00 LIST to the price of the RQ.  
For slim rosette (European version) see pages 100-103.

#### Upcharges apply for the following special options:

- Extra thick door (> 2")
- Non-standard rosettes (rosettes not listed above)
- Non-standard finishes (finishes not listed above)
- Split finishes

See page 17 for pricing. Exclusions may apply.



# K 1056 Quadra

Material	Collection	Group
Aluminum	Lab	3

### Standard option (mm/inches)

#### RQ Square rosette

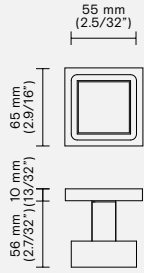

### Standard option (mm/inches)

#### RP Round rosette

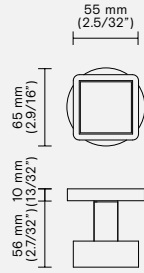

### Escutcheon options (mm/inches)

#### EP Oval plate

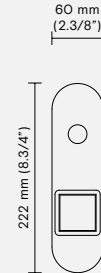

#### ER Rectangular plate

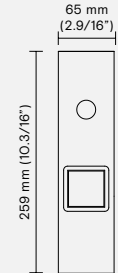

Slim rosette available - See pages 102-103

Conversions from metric to U.S. measurements are approximate.

### Retail price

Finish	Rosette	Function PGE	PCY	DMY R/L Single	ML-F Entry
26 Polished chrome	RP Round	\$ 556.00	\$ 579.00	\$ 273.00	\$ 1,251.00
	RQ Square	\$ 674.00	\$ 698.00	\$ 332.00	\$ 1,389.00
26D Satin chrome	RP Round	\$ 556.00	\$ 579.00	\$ 273.00	\$ 1,251.00
	RQ Square	\$ 674.00	\$ 698.00	\$ 332.00	\$ 1,389.00

### Retail price

Finish	Escutcheon	Function PGE	PCY	DMY R/L Single	DMY R/L Pair	ML-F Entry
26 Polished chrome	EP Oval	\$ 809.00	\$ 823.00	\$ 405.00	\$ 747.00	\$ 1,200.00
	ER Rectangular	\$ 859.00	\$ 873.00	\$ 430.00	\$ 798.00	\$ 1,226.00
26D Satin chrome	EP Oval	\$ 809.00	\$ 823.00	\$ 405.00	\$ 747.00	\$ 1,200.00
	ER Rectangular	\$ 859.00	\$ 873.00	\$ 430.00	\$ 798.00	\$ 1,226.00

The options listed above are considered standard. Non-standard options are available upon request.

For more options on Rosettes and Escutcheon plates see page 23. For more options on Finishes see pages 12-13.

RE = Rectangular rosettes available for tubular latch application only. Add + \$ 30.00 LIST to the price of the RQ. For slim rosette (European version) see pages 100-103.

#### Upcharges apply for the following special options:

- Extra thick door (> 2")
- Non-standard rosettes (rosettes not listed above)
- Non-standard finishes (finishes not listed above)
- Split finishes

See page 17 for pricing. Exclusions may apply.

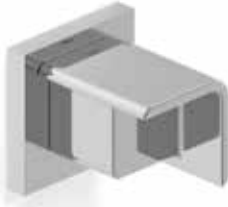

# K 1060

## SOM - Skidmore, Owings & Merrill

Material  
Brass

Collection  
Fusital

Group  
3

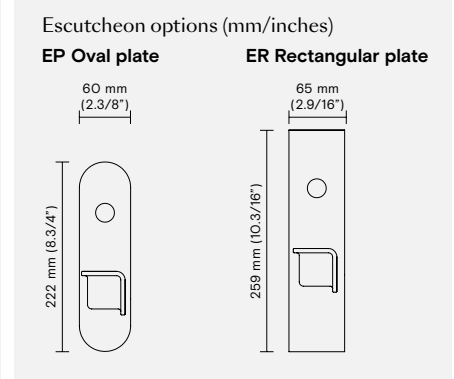
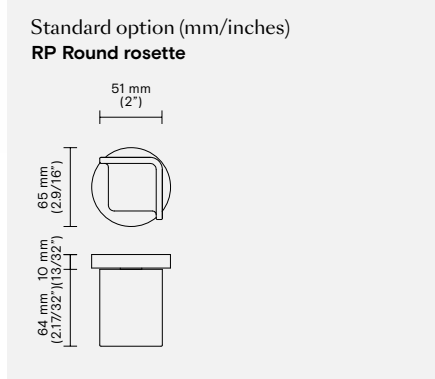
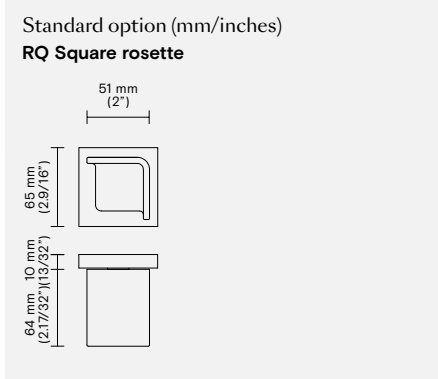

**Slim rosette** available - See pages 102-103

Conversions from metric to U.S. measurements are approximate.

### Retail price

Finish	Rosette	Function PGE	PCY	DMY R/L Single	ML-F Entry
<b>16</b> Dull black	<b>RP</b> Round	\$ 456.00	\$ 694.00	\$ 240.00	\$ 1,251.00
	<b>RQ</b> Square	\$ 480.00	\$ 718.00	\$ 253.00	\$ 1,389.00
<b>26</b> Polished chrome	<b>RP</b> Round	\$ 570.00	\$ 807.00	\$ 251.00	\$ 1,251.00
	<b>RQ</b> Square	\$ 600.00	\$ 837.00	\$ 265.00	\$ 1,389.00
<b>26D</b> Satin chrome	<b>RP</b> Round	\$ 570.00	\$ 807.00	\$ 251.00	\$ 1,251.00
	<b>RQ</b> Square	\$ 600.00	\$ 837.00	\$ 265.00	\$ 1,389.00

**Note:** Due to the design of the knob, it is not possible to be installed on a round rosette or oval plate.

### Retail price

Finish	Escutcheon	Function PGE	PCY	DMY R/L Single	DMY R/L Pair	ML-F Entry
<b>26</b> Polished chrome	<b>EP</b> Oval	\$ 772.00	\$ 785.00	\$ 387.00	\$ 712.00	\$ 1,200.00
	<b>ER</b> Rectangular	\$ 819.00	\$ 833.00	\$ 410.00	\$ 761.00	\$ 1,226.00
<b>26D</b> Satin chrome	<b>EP</b> Oval	\$ 772.00	\$ 785.00	\$ 387.00	\$ 712.00	\$ 1,200.00
	<b>ER</b> Rectangular	\$ 819.00	\$ 833.00	\$ 410.00	\$ 761.00	\$ 1,226.00

**Note:** Due to the special design of the knob, the EP/Oval escutcheon plate option is not available on this lever.

The options listed above are considered standard.  
Non-standard options are available upon request.

For more options on Rosettes and Escutcheon plates see page 23.  
For more options on Finishes see pages 12-13.  
RE = Rectangular rosettes available for tubular latch application only.  
Add + \$ 30.00 LIST to the price of the RQ.  
For slim rosette (European version) see pages 100-103.

#### Upcharges apply for the following special options:

- Extra thick door (> 2")
- Non-standard rosettes (rosettes not listed above)
- Non-standard finishes (finishes not listed above)
- Split finishes

See page 17 for pricing. Exclusions may apply.



# K 1061

## Di Virgilio Veneziano

Material	Collection	Group
Brass	Fusital	3

### Standard option (mm/inches)

#### RP Round rosette

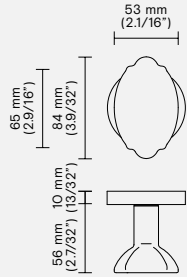

### Standard option (mm/inches)

#### RQ Square rosette

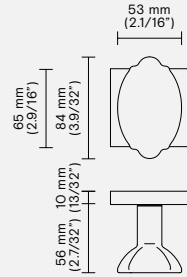

### Escutcheon options (mm/inches)\*

#### EP Oval plate

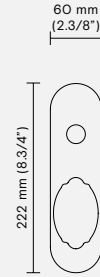

#### ER Rectangular plate

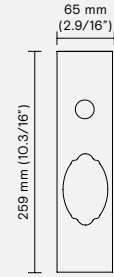

Slim rosette available - See pages 102-103

\*Only available on request  
Conversions from metric to U.S. measurements are approximate.

### Retail price

Finish	Rosette	Function PGE	PCY	DMY R/L Single	ML-F Entry
03D Satin brass	RP Round	\$ 509.00	\$ 519.00	\$ 251.00	\$ 1,251.00
	RQ Square	\$ 575.00	\$ 588.00	\$ 282.00	\$ 1,389.00
06M Matt bronze	RP Round	\$ 509.00	\$ 519.00	\$ 252.00	\$ 1,251.00
	RQ Square	\$ 575.00	\$ 588.00	\$ 282.00	\$ 1,389.00
17A Polished black nickel	RP Round	\$ 636.00	\$ 648.00	\$ 319.00	\$ 1,251.00
	RQ Square	\$ 719.00	\$ 736.00	\$ 353.00	\$ 1,389.00

The options listed above are considered standard.  
Non-standard options are available upon request.

For more options on Rosettes and Escutcheon plates see page 23.  
For more options on Finishes see pages 12-13.

RE = Rectangular rosettes available for tubular latch application only.  
Add + \$ 30.00 LIST to the price of the RQ.  
For slim rosette (European version) see pages 100-103.

#### Upcharges apply for the following special options:

- Extra thick door (> 2")
- Non-standard rosettes (rosettes not listed above)
- Non-standard finishes (finishes not listed above)
- Split finishes

See page 17 for pricing. Exclusions may apply.

# K 1155



Material  
Brass

Collection  
Lab

Group  
1

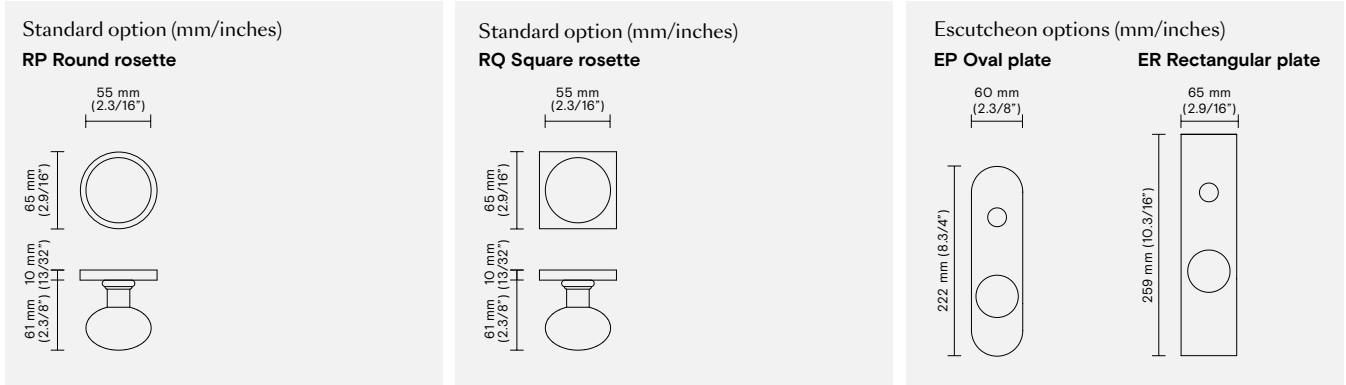

Conversions from metric to U.S. measurements are approximate.

## Retail price

Finish	Rosette	Function PGE	PCY	DMY R/L Single	ML-F Entry
O3 Polished brass	RP Round	\$ 236.00	\$ 239.00	\$ 119.00	\$ 961.00
	RQ Square	\$ 355.00	\$ 358.00	\$ 179.00	\$ 1,100.00
O3D Satin brass	RP Round	\$ 236.00	\$ 239.00	\$ 119.00	\$ 961.00
	RQ Square	\$ 355.00	\$ 358.00	\$ 179.00	\$ 1,100.00
O6A Anticato	RP Round	\$ 236.00	\$ 239.00	\$ 119.00	\$ 961.00
	RQ Square	\$ 355.00	\$ 358.00	\$ 179.00	\$ 1,100.00
O6B Brunito	RP Round	\$ 236.00	\$ 239.00	\$ 119.00	\$ 961.00
	RQ Square	\$ 355.00	\$ 358.00	\$ 179.00	\$ 1,100.00
26 Polished chrome	RP Round	\$ 236.00	\$ 239.00	\$ 119.00	\$ 961.00
	RQ Square	\$ 355.00	\$ 358.00	\$ 179.00	\$ 1,100.00
26D Satin chrome	RP Round	\$ 236.00	\$ 239.00	\$ 119.00	\$ 961.00
	RQ Square	\$ 355.00	\$ 358.00	\$ 179.00	\$ 1,100.00

## Retail price

Finish	Escutcheon	Function PGE	PCY	DMY R/L Single	DMY R/L Pair	ML-F Entry
26 Polished chrome	EP Oval	\$ 520.00	\$ 545.00	\$ 254.00	\$ 455.00	\$ 899.00
	ER Rectangular	\$ 570.00	\$ 596.00	\$ 279.00	\$ 506.00	\$ 935.00
26D Satin chrome	EP Oval	\$ 520.00	\$ 545.00	\$ 254.00	\$ 455.00	\$ 899.00
	ER Rectangular	\$ 570.00	\$ 596.00	\$ 279.00	\$ 506.00	\$ 935.00

The options listed above are considered standard. Non-standard options are available upon request.

For more options on Rosettes and Escutcheon plates see page 23. For more options on Finishes see pages 12-13.

RE = Rectangular rosettes available for tubular latch application only. Add + \$ 30.00 LIST to the price of the RQ. For slim rosette (European version) see pages 100-103.

### Upcharges apply for the following special options:

- Extra thick door (> 2")
- Non-standard rosettes (rosettes not listed above)
- Non-standard finishes (finishes not listed above)
- Split finishes

See page 17 for pricing. Exclusions may apply.



# K 1168 Giasone

Material	Collection	Group
Brass	Lab	1

### Standard option (mm/inches)

#### RP Round rosette

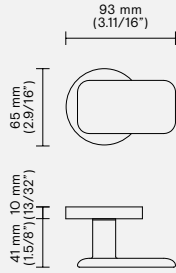

### Standard option (mm/inches)

#### RQ Square rosette

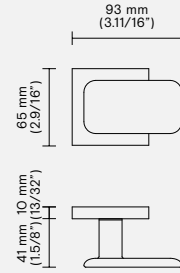

### Escutcheon options (mm/inches)

#### EP Oval plate

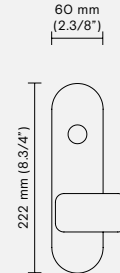

#### ER Rectangular plate

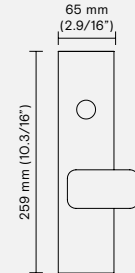

**Slim rosette** available - See pages 102-103

Conversions from metric to U.S. measurements are approximate.

### Retail price

Finish	Rosette	Function PGE	PCY	DMY R/L Single	ML-F Entry
26 Polished chrome	RP Round	\$ 384.00	\$ 417.00	\$ 185.00	\$ 961.00
	RQ Square	\$ 494.00	\$ 522.00	\$ 259.00	\$ 1,100.00
26D Satin chrome	RP Round	\$ 377.00	\$ 403.00	\$ 191.00	\$ 961.00
	RQ Square	\$ 513.00	\$ 542.00	\$ 275.00	\$ 1,100.00

### Retail price

Finish	Escutcheon	Function PGE	PCY	DMY R/L Single	DMY R/L Pair	ML-F Entry
26 Polished chrome	EP Oval	\$ 520.00	\$ 545.00	\$ 254.00	\$ 455.00	\$ 899.00
	ER Rectangular	\$ 570.00	\$ 596.00	\$ 279.00	\$ 506.00	\$ 935.00
26D Satin chrome	EP Oval	\$ 520.00	\$ 545.00	\$ 254.00	\$ 455.00	\$ 899.00
	ER Rectangular	\$ 570.00	\$ 596.00	\$ 279.00	\$ 506.00	\$ 935.00

The options listed above are considered standard. Non-standard options are available upon request.

For more options on Rosettes and Escutcheon plates see page 23.  
For more options on Finishes see pages 12-13.

RE = Rectangular rosettes available for tubular latch application only.  
Add + \$ 30.00 LIST to the price of the RQ.  
For slim rosette (European version) see pages 100-103.

#### Upcharges apply for the following special options:

- Extra thick door (> 2")
- Non-standard rosettes (rosettes not listed above)
- Non-standard finishes (finishes not listed above)
- Split finishes

See page 17 for pricing. Exclusions may apply.

# K 1170



Material  
Aluminum

Collection  
Lab

Group  
1

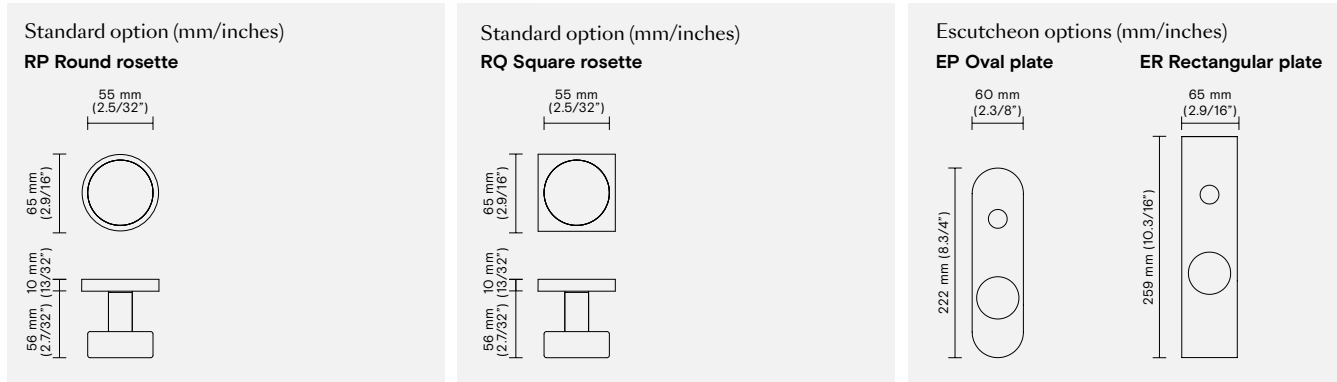

Slim rosette available - See pages 102-103

Conversions from metric to U.S. measurements are approximate.

## Retail price

Finish	Rosette	Function PGE	PCY	DMY R/L Single	ML-F Entry
06M Matt bronze	RP Round	\$ 397.00	\$ 423.00	\$ 202.00	\$ 961.00
	RQ Square	\$ 516.00	\$ 542.00	\$ 262.00	\$ 1,100.00
16 Dull black	RP Round	\$ 236.00	\$ 239.00	\$ 119.00	\$ 961.00
	RQ Square	\$ 355.00	\$ 358.00	\$ 179.00	\$ 1,100.00
22M Matt white	RP Round	\$ 397.00	\$ 423.00	\$ 202.00	\$ 961.00
	RQ Square	\$ 516.00	\$ 542.00	\$ 262.00	\$ 1,100.00
26 Polished chrome	RP Round	\$ 236.00	\$ 239.00	\$ 119.00	\$ 961.00
	RQ Square	\$ 355.00	\$ 358.00	\$ 179.00	\$ 1,100.00
26D Satin chrome	RP Round	\$ 236.00	\$ 239.00	\$ 119.00	\$ 961.00
	RQ Square	\$ 355.00	\$ 358.00	\$ 179.00	\$ 1,100.00

## Retail price

Finish	Escutcheon	Function PGE	PCY	DMY R/L Single	DMY R/L Pair	ML-F Entry
26 Polished chrome	EP Oval	\$ 520.00	\$ 545.00	\$ 254.00	\$ 455.00	\$ 899.00
	ER Rectangular	\$ 570.00	\$ 596.00	\$ 279.00	\$ 506.00	\$ 935.00
26D Satin chrome	EP Oval	\$ 520.00	\$ 545.00	\$ 254.00	\$ 455.00	\$ 899.00
	ER Rectangular	\$ 570.00	\$ 596.00	\$ 279.00	\$ 506.00	\$ 935.00

### Upcharges apply for the following special options:

- Extra thick door (> 2")
- Non-standard rosettes (rosettes not listed above)
- Non-standard finishes (finishes not listed above)
- Split finishes

See page 17 for pricing. Exclusions may apply.

For more options on Rosettes and Escutcheon plates see page 23.  
For more options on Finishes see pages 12-13.

RE = Rectangular rosettes available for tubular latch application only.  
Add + \$ 30.00 LIST to the price of the RQ.  
For slim rosette (European version) see pages 100-103.

The options listed above are considered standard.  
Non-standard options are available upon request.

# K 1171



Material	Collection	Group
Aluminum	Lab	3

Standard option (mm/inches)

**RQ Square rosette**

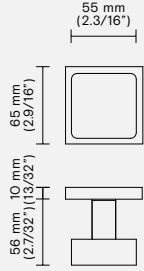

Standard option (mm/inches)

**RP Round rosette**

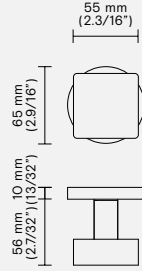

Escutcheon options (mm/inches)

**EP Oval plate**

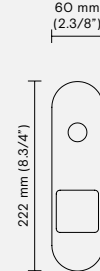

**ER Rectangular plate**

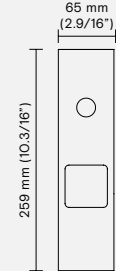

**Slim rosette** available - See pages 102-103

Conversions from metric to U.S. measurements are approximate.

**Retail price**

Finish	Rosette	Function PGE	PCY	DMY R/L Single	ML-F Entry
<b>26</b> Polished chrome	<b>RP</b> Round	\$ 416.00	\$ 423.00	\$ 197.00	\$ 1,251.00
	<b>RQ</b> Square	\$ 542.00	\$ 548.00	\$ 260.00	\$ 1,389.00
<b>26D</b> Satin chrome	<b>RP</b> Round	\$ 416.00	\$ 423.00	\$ 197.00	\$ 1,251.00
	<b>RQ</b> Square	\$ 542.00	\$ 548.00	\$ 260.00	\$ 1,389.00

**Retail price**

Finish	Escutcheon	Function PGE	PCY	DMY R/L Single	DMY R/L Pair	ML-F Entry
<b>26</b> Polished chrome	<b>EP</b> Oval	\$ 809.00	\$ 823.00	\$ 405.00	\$ 747.00	\$ 1,200.00
	<b>ER</b> Rectangular	\$ 859.00	\$ 873.00	\$ 430.00	\$ 798.00	\$ 1,226.00
<b>26D</b> Satin chrome	<b>EP</b> Oval	\$ 809.00	\$ 823.00	\$ 405.00	\$ 747.00	\$ 1,200.00
	<b>ER</b> Rectangular	\$ 859.00	\$ 873.00	\$ 430.00	\$ 798.00	\$ 1,226.00

The options listed above are considered standard. Non-standard options are available upon request.

For more options on Rosettes and Escutcheon plates see page 23. For more options on Finishes see pages 12-13.

RE = Rectangular rosettes available for tubular latch application only. Add + \$ 30.00 LIST to the price of the RQ. For slim rosette (European version) see pages 100-103.

**Upcharges apply for the following special options:**

- Extra thick door (> 2")
- Non-standard rosettes (rosettes not listed above)
- Non-standard finishes (finishes not listed above)
- Split finishes

See page 17 for pricing. Exclusions may apply.

# K 1730



Material  
Brass

Collection  
Lab

Group  
3

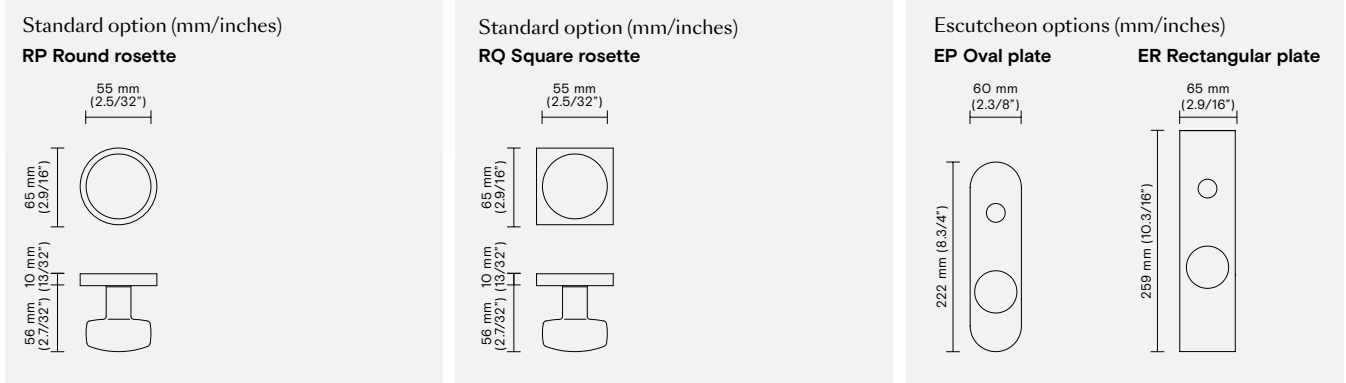

Slim rosette available - See pages 102-103

Conversions from metric to U.S. measurements are approximate.

## Retail price

Finish	Rosette	Function PGE	PCY	DMY R/L Single	ML-F Entry
03 Polished brass	RP Round	\$ 424.00	\$ 435.00	\$ 227.00	\$ 1,251.00
	RQ Square	\$ 462.00	\$ 480.00	\$ 293.00	\$ 1,389.00
15 Satin nickel	RP Round	\$ 435.00	\$ 486.00	\$ 231.00	\$ 1,251.00
	RQ Square	\$ 584.00	\$ 605.00	\$ 307.00	\$ 1,389.00
26 Polished chrome	RP Round	\$ 435.00	\$ 486.00	\$ 231.00	\$ 1,251.00
	RQ Square	\$ 584.00	\$ 605.00	\$ 307.00	\$ 1,389.00
26D Satin chrome	RP Round	\$ 435.00	\$ 486.00	\$ 231.00	\$ 1,251.00
	RQ Square	\$ 584.00	\$ 605.00	\$ 307.00	\$ 1,389.00

## Retail price

Finish	Escutcheon	Function PGE	PCY	DMY R/L Single	DMY R/L Pair	ML-F Entry
26 Polished chrome	EP Oval	\$ 520.00	\$ 545.00	\$ 254.00	\$ 455.00	\$ 1,200.00
	ER Rectangular	\$ 570.00	\$ 596.00	\$ 279.00	\$ 506.00	\$ 1,226.00
26D Satin chrome	EP Oval	\$ 520.00	\$ 545.00	\$ 254.00	\$ 455.00	\$ 1,200.00
	ER Rectangular	\$ 570.00	\$ 596.00	\$ 279.00	\$ 506.00	\$ 1,226.00

The options listed above are considered standard. Non-standard options are available upon request.

For more options on Rosettes and Escutcheon plates see page 23.  
For more options on Finishes see pages 12-13.  
RE = Rectangular rosettes available for tubular latch application only.  
Add + \$ 30.00 LIST to the price of the RQ.  
For slim rosette (European version) see pages 100-103.

### Upcharges apply for the following special options:

- Extra thick door (> 2")
- Non-standard rosettes (rosettes not listed above)
- Non-standard finishes (finishes not listed above)
- Split finishes

See page 17 for pricing. Exclusions may apply.



# K 5301

Material	Collection	Group
Stainless steel AISI 316 L	Fusital	7

### Standard option (mm/inches)

#### RP Round rosette

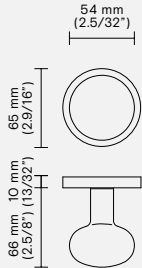

### Standard option (mm/inches)

#### RQ Square rosette

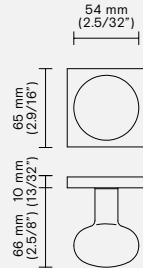

### Escutcheon options (mm/inches)

#### EP Oval plate

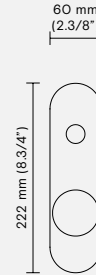

#### ER Rectangular plate

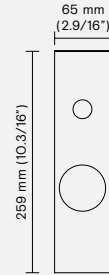

Conversions from metric to U.S. measurements are approximate.

### Retail price

Finish	Rosette	Function PGE	PCY	DMY R/L Single	ML-F Entry
32 Polished stainless steel	RPS Round	\$ 737.00	\$ 775.00	\$ 366.00	\$ 1,516.00
	RQS Square	\$ 856.00	\$ 894.00	\$ 425.00	\$ 1,542.00
	RSS Round	\$ 688.00	\$ 923.00	\$ 329.00	\$ 1,303.00
32D Satin stainless steel	RPS Round	\$ 589.00	\$ 602.00	\$ 282.00	\$ 1,516.00
	RQS Square	\$ 708.00	\$ 721.00	\$ 342.00	\$ 1,542.00
	RSS Round	\$ 549.00	\$ 737.00	\$ 266.00	\$ 1,303.00

### Retail price

Finish	Escutcheon	Function PGE	PCY	DMY R/L Single	DMY R/L Pair	ML-F Entry
32D Satin stainless steel	EP Oval	\$ 885.00	\$ 961.00	\$ 444.00	\$ 859.00	\$ 1,340.00
	ER Rectangular	\$ 949.00	\$ 985.00	\$ 481.00	\$ 899.00	\$ 1,579.00

The options listed above are considered standard. Non-standard options are available upon request.

For more options on Rosettes and Escutcheon plates see page 23. For more options on Finishes see pages 12-13.

RE = Rectangular rosettes available for tubular latch application only. Add + \$ 30.00 LIST to the price of the RQ. For slim rosette (European version) see pages 100-103.

#### Upcharges apply for the following special options:

- Extra thick door (> 2")
- Non-standard rosettes (rosettes not listed above)
- Non-standard finishes (finishes not listed above)
- Split finishes

See page 17 for pricing. Exclusions may apply.



## K 352 Richard Meier

Material Brass Collection Fusital

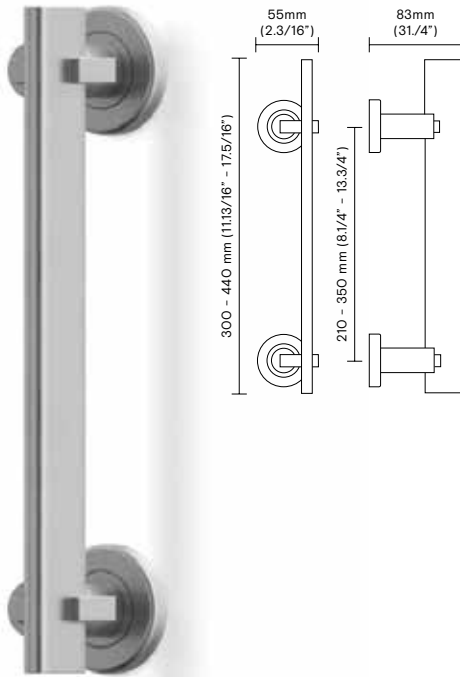

### Retail price

Finish	Center to center (mm/inches)	Single	Back to back
26 Polished chrome	210 (8.1/4") RH	\$ 576.00	\$ 1,198.00
	350 (13.13/4") RH	\$ 679.00	\$ 1,404.00
	210 (8.1/4") LH	\$ 576.00	\$ 1,198.00
	350 (13.13/4") LH	\$ 679.00	\$ 1,404.00

**Note:** Complete with fixing systems for single and back to back mounting on wood (X O526, X O523) and glass doors (X O525, X O523).

When ordering the K 352 specify the below:  
 RH = Pull grip on the right side  
 LH = Pull grip on the left side

## K 353 Taller Design Ricardo Boffill

Material Brass Collection Fusital

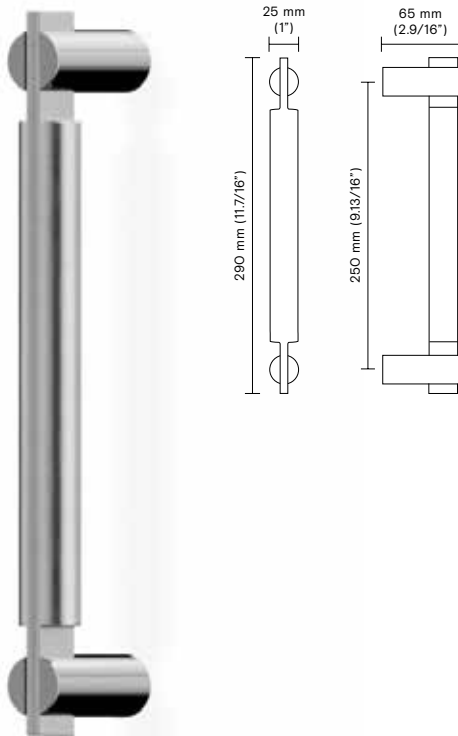

### Retail price

Finish	Center to center (mm/inches)	Single	Back to back
26/26D Polished chrome / Satin chrome*	250 (9.13/16")	\$ 542.00	\$ 1,150.00

\* The grip part is satin, the stand-off posts are polished. The dual finish version has the posts in polished chrome and the grip in satin chrome.

**Note:** Complete with fixing systems for single and back to back mounting on wood (X O526, X O523) and glass doors (X O525, X O523).

All the options listed in this page are considered standard. For more options on finishes, see pages 12-13, and upcharges at page 17.

For fixing spare parts, please check at pages 194-199.

Conversions from metric to U.S. measurements are approximate.

## K 356 John Pawson

Material Brass Collection Fusital

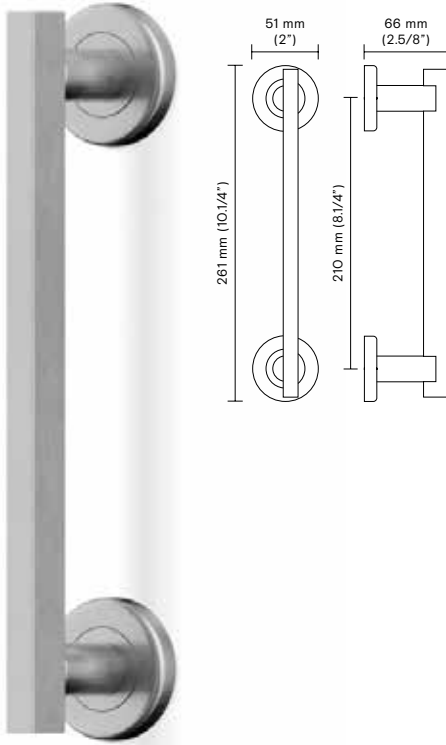

### Retail price

Finish	Center to center (mm/inches)	Single	Back to back
<b>26</b> Polished chrome	210 (8.1/4")	\$ 601.00	\$ 1,248.00
<b>26D</b> Satin chrome	210 (8.1/4")	\$ 582.00	\$ 1,210.00

**Note:** Complete with fixing systems for single and back to back mounting on wood (X O526, X O523) and glass doors (X O525, X O523).

## K 358 Cerri & Associati

Material Brass Collection Fusital

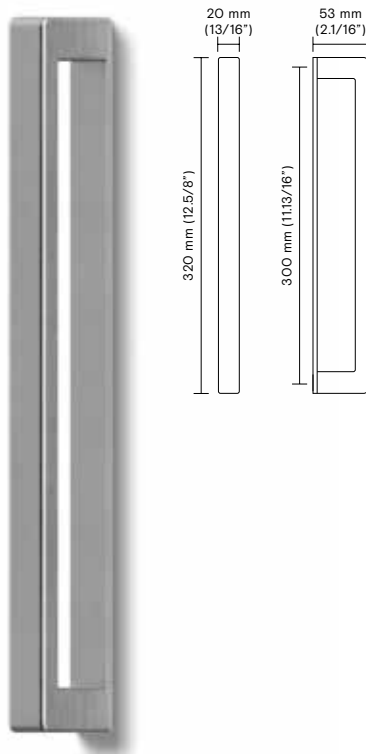

### Retail price

Finish	Center to center (mm/inches)	Single	Back to back
<b>26</b> Polished chrome	300 (11.13/16")	\$ 600.00	\$ 1,246.00
<b>26D</b> Satin chrome	300 (11.13/16")	\$ 630.00	\$ 1,306.00

**Note:** Complete with fixing systems for single and back to back mounting on wood (X O526, X O523) and glass doors (X O525, X O523).

All the options listed in this page are considered standard.  
For more options on finishes, see pages 12-13, and upcharges at page 17.

For fixing spare parts, please check at pages 194-199.

Conversions from metric to U.S. measurements are approximate.

## K 368 Antonio Citterio with Toan Nguyen

Material Brass Collection Fusital

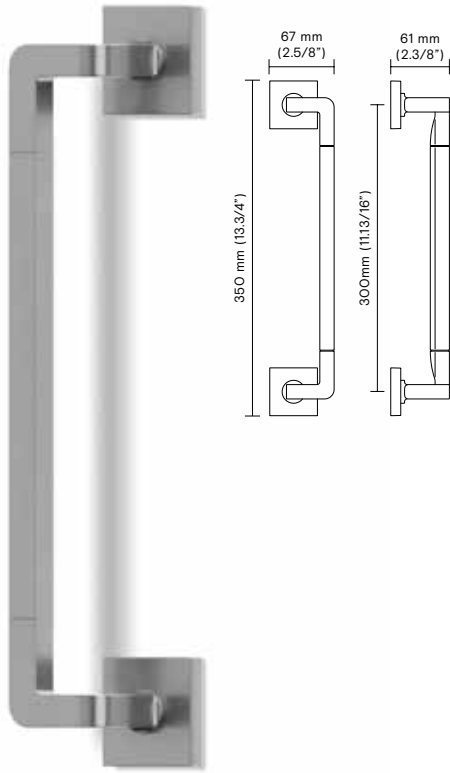

### Retail price

Finish	Center to center (mm/inches)	Single	Back to back
<b>26</b> Polished chrome	300 (11.13/16")	\$ 700.00	\$ 1,448.00
<b>26D</b> Satin chrome	300 (11.13/16")	\$ 737.00	\$ 1,519.00

**Note:** Complete with fixing systems for single and back to back mounting on wood (X 0526, X 0523) and glass doors (X 0525, X 0523).

## K 377 Steve Leung

Material Brass Collection Fusital

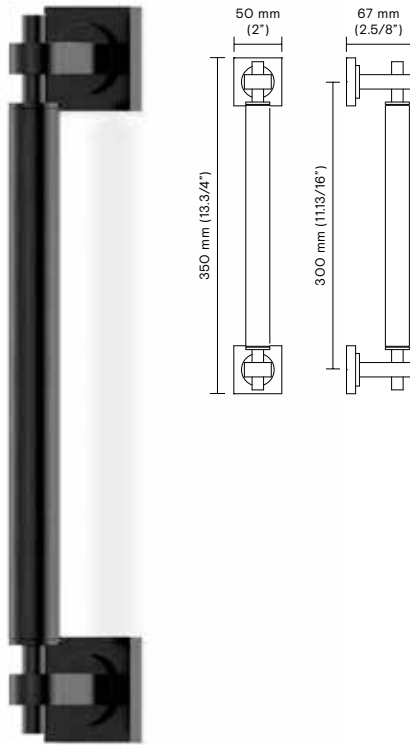

### Retail price

Finish	Center to center (mm/inches)	Single	Back to back
<b>03M</b> Matt brass	300 (11.13/16")	\$ 486.00	\$ 1,016.00
<b>16</b> Dull black	300 (11.13/16")	\$ 389.00	\$ 823.00
<b>56</b> Dark bronze	300 (11.13/16")	\$ 486.00	\$ 1,016.00

**Note:** Complete with fixing systems for single and back to back mounting on wood (X 0526, X 0523) and glass doors (X 0525, X 0523).

All the options listed in this page are considered standard.  
For more options on finishes, see pages 12-13, and upcharges at page 17.

For fixing spare parts, please check at pages 194-199.

Conversions from metric to U.S. measurements are approximate.

## K 378 Yabu Pushelberg

Material Brass Collection Fusital

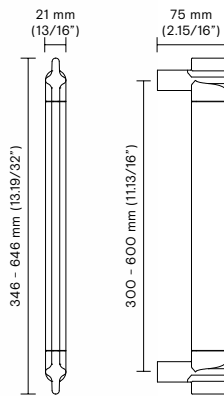

### Retail price

Finish	Center to center (mm/inches)	Single	Back to back
<b>17A</b> Polished black nickel	300 (11.13/16")	\$ 773.00	\$ 1,600.00
<b>26</b> Polished chrome	300 (11.13/16")	\$ 702.00	\$ 1,454.00
<b>56</b> Dark bronze	300 (11.13/16")	\$ 843.00	\$ 1,745.00

Due to its particular design, this pull cannot be produced in any satin or matt finishes. Call for details

**Note:** Complete with fixing systems for single and back to back mounting on wood (X O526, X O523) and glass doors (X O525, X O523).

## K 379 Antonio Citterio

Material Brass Collection Fusital

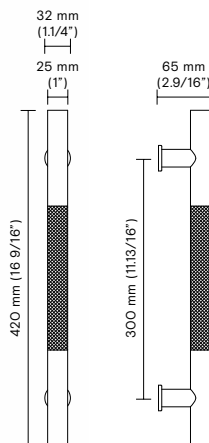

### Retail price

Finish	Center to center (mm/inches)	Single	Back to back
<b>O3D</b> Satin brass	300 (11.13/16")	\$ 594.00	\$ 1,258.00
<b>O6M</b> Matt bronze	300 (11.13/16")	\$ 670.00	\$ 1,409.00
<b>26D</b> Satin chrome	300 (11.13/16")	\$ 755.00	\$ 1,579.00

**Note:** Complete with fixing systems for single and back to back mounting on wood (X O526, X O523) and glass doors (X O525, X O523).

Conversions from metric to U.S. measurements are approximate.

All the options listed in this page are considered standard.  
For more options on finishes, see pages 12-13, and upcharges at page 17.

For fixing spare parts, please check at pages 194-199.

Conversions from metric to U.S. measurements are approximate.

## K 380 Antonio Citterio

Material Brass Collection Fusital

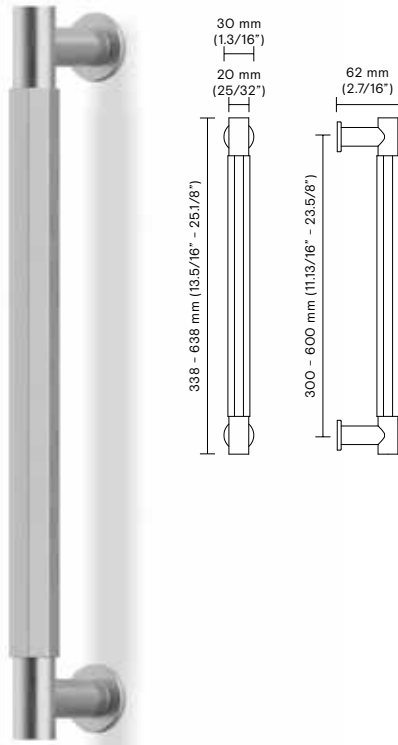

### Retail price

Finish	Center to center (mm/inches)	Single	Back to back
<b>14</b> Polished nickel	300 (11.13/16")	\$ 627.00	\$ 1,322.00
	600 (23.5/8")	\$ 863.00	\$ 1,795.00
<b>26D</b> Satin chrome	300 (11.13/16")	\$ 594.00	\$ 1,258.00
	600 (23.5/8")	\$ 831.00	\$ 1,731.00
<b>56</b> Dark bronze	300 (11.13/16")	\$ 627.00	\$ 1,322.00
	600 (23.5/8")	\$ 863.00	\$ 1,795.00

**Note:** Complete with fixing systems for single and back to back mounting on wood (X 0526, X 0523) and glass doors (X 0525, X 0523).

## K 381 Khalid Al Najjar

Material Brass Collection Fusital

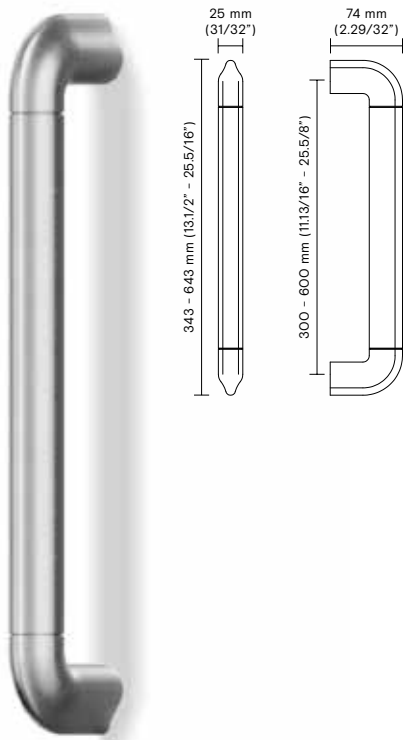

### Retail price

Finish	Center to center (mm/inches)	Single	Back to back
<b>03M</b> Matt brass	300 (11.13/16")	\$ 431.00	\$ 931.00
	600 (23.5/8")	\$ 604.00	\$ 1,277.00
<b>15</b> Satin nickel	300 (11.13/16")	\$ 449.00	\$ 966.00
	600 (23.5/8")	\$ 621.00	\$ 1,312.00
<b>17A</b> Polished black nickel	300 (11.13/16")	\$ 486.00	\$ 1,042.00
	600 (23.5/8")	\$ 659.00	\$ 1,387.00
<b>26D</b> Satin chrome	300 (11.13/16")	\$ 449.00	\$ 966.00
	600 (23.5/8")	\$ 621.00	\$ 1,312.00

**Note:** Complete with fixing systems for single and back to back mounting on wood (X 0526, X 0523) and glass doors (X 0525, X 0523).

All the options listed in this page are considered standard.  
For more options on finishes, see pages 12-13, and upcharges at page 17.

For fixing spare parts, please check at pages 194-199.

Conversions from metric to U.S. measurements are approximate.

## K 383 Perkins&Will

Material Brass Collection Fusital

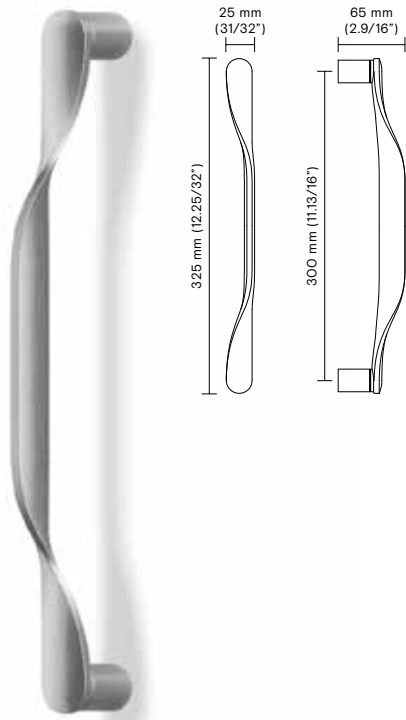

### Retail price

Finish	Center to center (mm/inches)	Single	Back to back
15 Satin nickel	300 (11.13/16")	\$ 584.00	\$ 1,236.00
16 Dull black	300 (11.13/16")	\$ 530.00	\$ 1,128.00
26D Satin chrome	300 (11.13/16")	\$ 584.00	\$ 1,236.00
56 Dark bronze	300 (11.13/16")	\$ 638.00	\$ 1,344.00

**Note:** Complete with fixing systems for single and back to back mounting on wood (X 0526, X 0523) and glass doors (X 0525, X 0523).

## K 385 Federica Biasi

NEW

Material Brass Collection Fusital

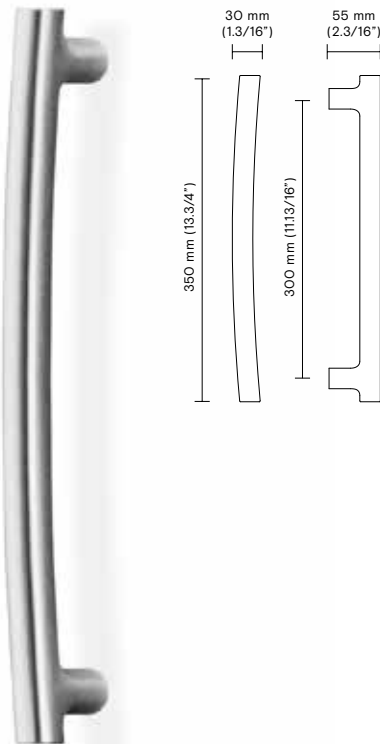

### Retail price

Finish	Center to center (mm/inches)	Single	Back to back
15 Satin nickel	300 (11.13/16")	\$ 400.00	\$ 830.00
16 Dull black	300 (11.13/16")	\$ 400.00	\$ 830.00
26 Polished chrome	300 (11.13/16")	\$ 400.00	\$ 830.00
26D Satin chrome	300 (11.13/16")	\$ 400.00	\$ 830.00

**Note:** Complete with fixing systems for single and back to back mounting on wood (X 0526, X 0523) and glass doors (X 0525, X 0523).

All the options listed in this page are considered standard.  
For more options on finishes, see pages 12-13, and upcharges at page 17.

For fixing spare parts, please check at pages 194-199.

Conversions from metric to U.S. measurements are approximate.

## K 386 Meneghello Paoelli

**NEW**

Material Brass Collection Fusital

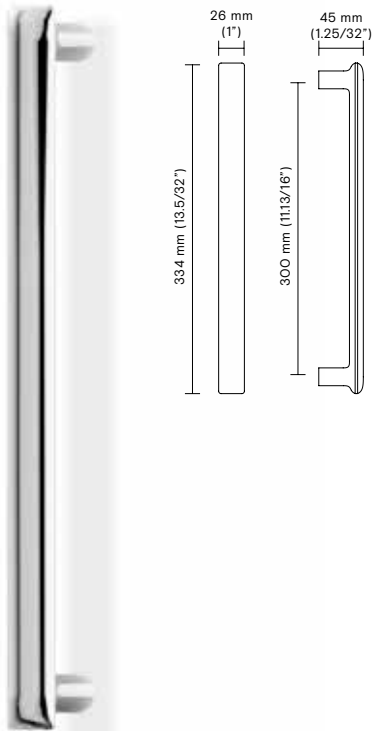

### Retail price

Finish	Center to center (mm/inches)	Single	Back to back
<b>15</b> Satin nickel	300 (11.13/16")	\$ 400.00	\$ 830.00
<b>17A</b> Polished black nickel	300 (11.13/16")	\$ 400.00	\$ 830.00
<b>26</b> Polished chrome	300 (11.13/16")	\$ 400.00	\$ 830.00
<b>26D</b> Satin chrome	300 (11.13/16")	\$ 400.00	\$ 830.00

**Note:** Complete with fixing systems for single and back to back mounting on wood (X 0526, X 0523) and glass doors (X 0525, X 0523)

## K 1054 W.W.

Material Aluminum Collection Lab

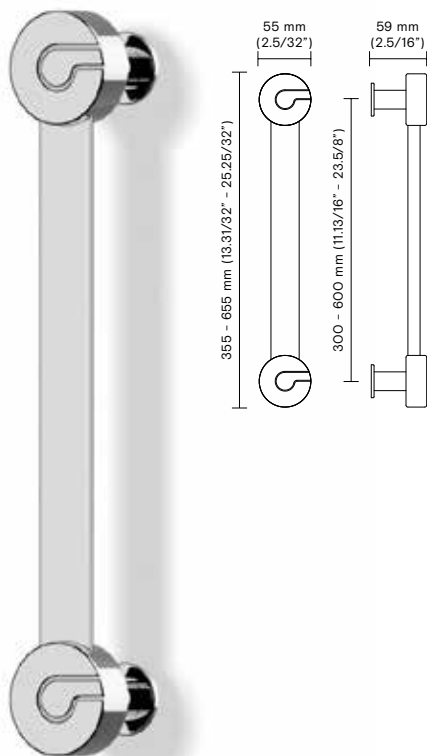

### Retail price

Finish	Center to center (mm/inches)	Single	Back to back
<b>03M</b> Matt brass	300 (11.13/16")	\$ 441.00	\$ 925.00
	600 (23.5/8")	\$ 486.00	\$ 1,018.00
<b>15</b> Satin nickel	300 (11.13/16")	\$ 405.00	\$ 858.00
	600 (23.5/8")	\$ 452.00	\$ 950.00
<b>16</b> Dull black	300 (11.13/16")	\$ 393.00	\$ 829.00
	600 (23.5/8")	\$ 438.00	\$ 920.00
<b>26</b> Polished chrome	300 (11.13/16")	\$ 393.00	\$ 829.00
	600 (23.5/8")	\$ 438.00	\$ 920.00

**Note:** Complete with fixing systems for single and back to back mounting on wood (X 0531, X 0528) and glass doors (X 0530, X 0528).

All the options listed in this page are considered standard.  
For more options on finishes, see pages 12-13, and upcharges at page 17.

For fixing spare parts, please check at pages 194-199.

Conversions from metric to U.S. measurements are approximate.

## K 1056 Quadra

Material Aluminum    Collection Lab

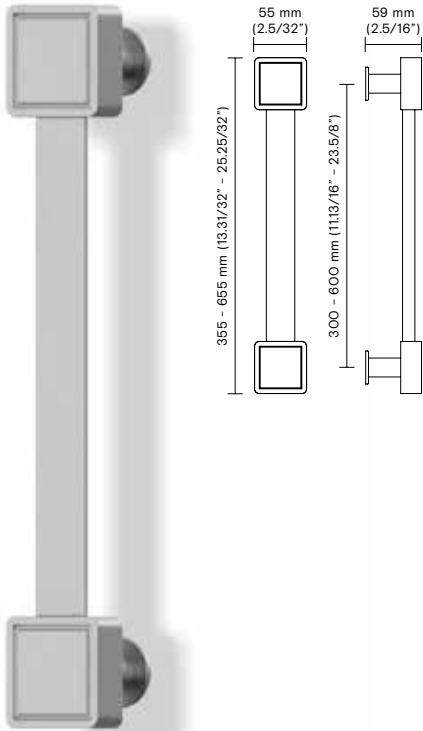

### Retail price

Finish	Center to center (mm/inches)	Single	Back to back
<b>26</b> Polished chrome	300 (11.13/16")	\$ 466.00	\$ 976.00
	600 (23.5/8")	\$ 466.00	\$ 976.00
<b>26D</b> Satin chrome	300 (11.13/16")	\$ 512.00	\$ 1,069.00
	600 (23.5/8")	\$ 512.00	\$ 1,069.00

**Note:** Complete with fixing systems for single and back to back mounting on wood (X O531, X O528) and glass doors (X O530, X O528).

## K 1060 SOM - Skidmore, Owings & Merrill

Material Brass    Collection Fusital

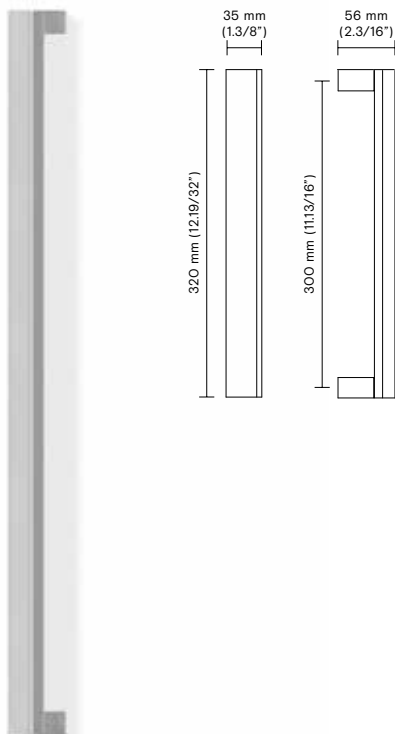

### Retail price

Finish	Center to center (mm/inches)	Single	Back to back
<b>16</b> Dull black	300 (11.13/16")	\$ 550.00	\$ 1,167.00
<b>26</b> Polished chrome	300 (11.13/16")	\$ 578.00	\$ 1,223.00
<b>26D</b> Satin chrome	300 (11.13/16")	\$ 578.00	\$ 1,223.00

**Note:** Complete with fixing systems for single and back to back mounting on wood (X O531, X O528) and glass doors (X O530, X O528).

All the options listed in this page are considered standard.  
For more options on finishes, see pages 12-13, and upcharges at page 17.

For fixing spare parts, please check at pages 194-199.

Conversions from metric to U.S. measurements are approximate.

## K 1061 Di Virgilio Veneziano

Material Brass Collection Fusital

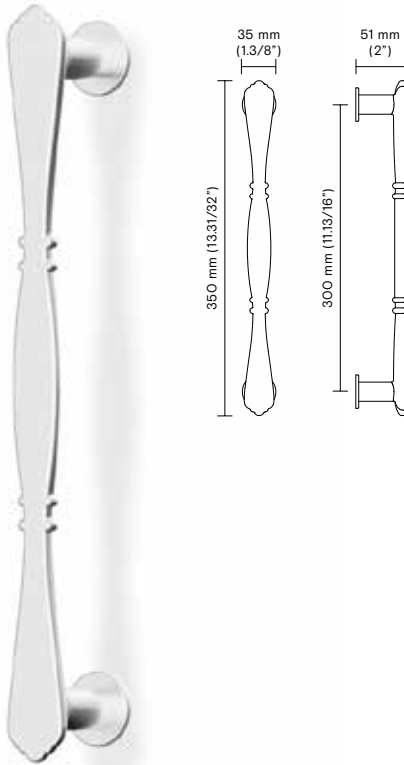

### Retail price

Finish	Center to center (mm/inches)	Single	Back to back
<b>03D</b> Satin brass	300 (11.13/16")	\$ 442.00	\$ 951.00
<b>06M</b> Bronze matt	300 (11.13/16")	\$ 442.00	\$ 951.00
<b>17A</b> Polished black nickel	300 (11.13/16")	\$ 552.00	\$ 1,132.00

**Note:** Complete with fixing systems for single and back to back mounting on wood (X O531, X O528) and glass doors (X O530, X O528).

## K 1068 Pembroke & Ives

Material Brass Collection Lab

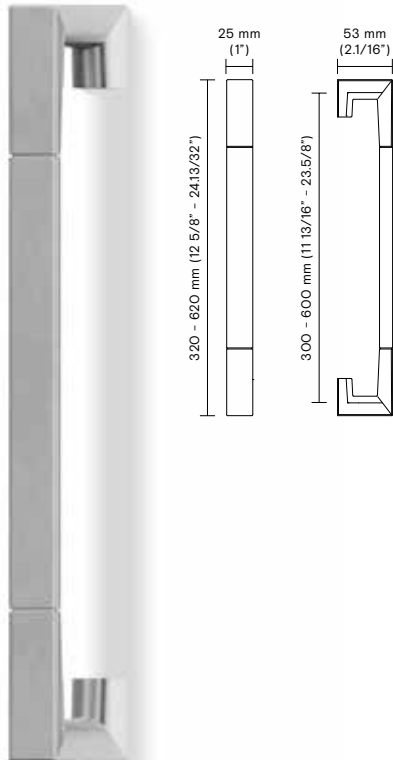

### Retail price

Finish	Center to center (mm/inches)	Single	Back to back
<b>03/03D</b> Polished brass / Satin brass*	300 (11.13/16")	\$ 700.00	\$ 1,469.00
	600 (23.5/8")	\$ 735.00	\$ 1,538.00
<b>15</b> Satin nickel	300 (11.13/16")	\$ 700.00	\$ 1,469.00
	600 (23.5/8")	\$ 735.00	\$ 1,538.00
<b>16</b> Dull black	300 (11.13/16")	\$ 700.00	\$ 1,469.00
	600 (23.5/8")	\$ 735.00	\$ 1,538.00
<b>26/26D</b> Polished chrome / Satin chrome*	300 (11.13/16")	\$ 700.00	\$ 1,469.00
	600 (23.5/8")	\$ 735.00	\$ 1,538.00

\* The pull is satin on its front and side edge, while polished on the rest.

**Note:** Complete with fixing systems for single and back to back mounting on wood (X O531, X O528) and glass doors (X O530, X O528).

All the options listed in this page are considered standard. For more options on finishes, see pages 12-13, and upcharges at page 17.

For fixing spare parts, please check at pages 194-199.

Conversions from metric to U.S. measurements are approximate.

# K 1069 Susannah

NEW

Material Brass Collection Lab

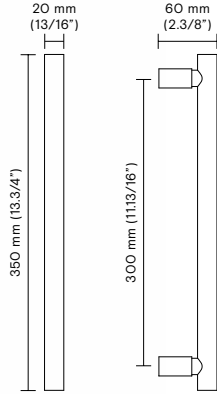

### Retail price

Finish	Center to center (mm/inches)	Single	Back to back
15 Satin nickel	300 (11.13/16")	\$ 648.00	\$ 1,366.00
26 Polished chrome	300 (11.13/16")	\$ 577.00	\$ 1,223.00
26D Satin chrome	300 (11.13/16")	\$ 577.00	\$ 1,223.00

For different sizes, call our customer service.

**Note:** Complete with fixing systems for single and back to back mounting on wood (X O531, X O528) and glass doors (X O530, X O528).

# K 1188

Material Brass Collection Lab

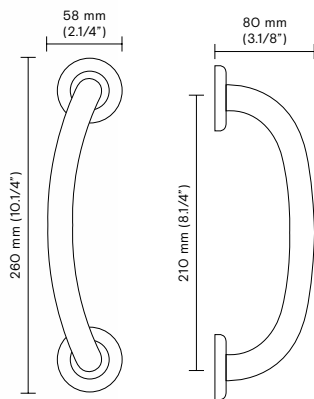

### Retail price

Finish	Center to center (mm/inches)	Single
03 Polished brass	210 (8.1/4")	\$ 246.00
03D Satin brass	210 (8.1/4")	\$ 246.00
06B Brunito	210 (8.1/4")	\$ 258.00
26D Satin chrome	210 (8.1/4")	\$ 258.00

**Note:** Complete with fixing systems for single and back to back mounting on wood (X O326, X O523) and glass doors (X O525, X O523).

Possibility of mounting without cover-nut rosettes.

All the options listed in this page are considered standard.  
For more options on finishes, see pages 12-13, and upcharges at page 17.  
For fixing spare parts, please check at pages 194-199.

Conversions from metric to U.S. measurements are approximate.

## K 1210 Eero Aarnio

Material Brass Collection Fusital

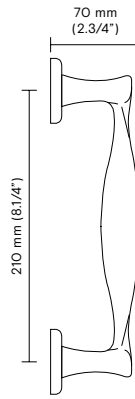
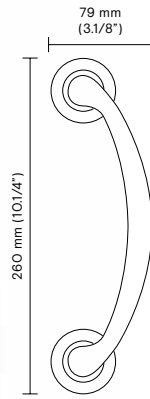

### Retail price

Finish	Center to center (mm/inches)	Single
<b>06A</b> Anticato	210 (8.1/4")	\$ 279.00
<b>03</b> Polished brass	210 (8.1/4")	\$ 279.00
<b>26D</b> Satin chrome	210 (8.1/4")	\$ 291.00

**Note:** Complete with fixing systems for single and back to back mounting on wood (X O326, X O523) and glass doors (X O525, X O523).

Possibility of mounting without cover-nut rosettes.

## K 1219

Material Stainless Steel AISI 304 Collection Lab

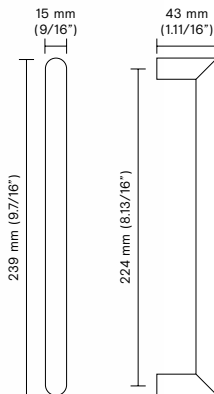

### Retail price

Finish	Center to center (mm/inches)	Single	Back to back
<b>32</b> Polished stainless steel	224 (8.13/16")	\$ 127.00	\$ 258.00
<b>32D</b> Satin stainless steel	224 (8.13/16")	\$ 104.00	\$ 250.00

**Note:** Complete with fixing systems for single and back to back mounting on wood (X O373). For glass doors it can only be installed back to back (X O373).

All the options listed in this page are considered standard. For more options on finishes, see pages 12-13, and upcharges at page 17.

For fixing spare parts, please check at pages 194-199.

Conversions from metric to U.S. measurements are approximate.

## K 1224

Material Stainless Steel AISI 304    Collection Lab

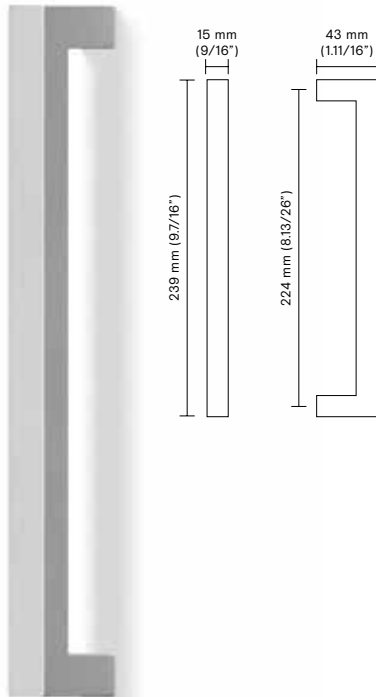

### Retail price

Finish	Center to center (mm/inches)	Single	Back to back
<b>32D</b> Satin stainless steel	224 (8.13/16")	\$ 827.00	\$ 258.00

**Note:** Complete with fixing systems for single and back to back mounting on wood (X 0373).  
For glass doors it can only be installed back to back (X 0373).

## K 1226 Jean-Baptiste Sibertin Blanc

Material Brass    Collection Fusital

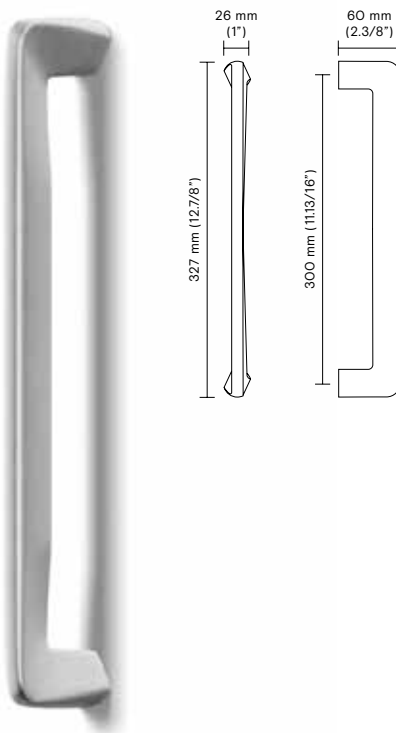

### Retail price

Finish	Center to center (mm/inches)	Single	Back to back
<b>26D/26</b> Satin chrome / Polished chrome*	300 (11.13/16")	\$ 399.00	\$ 827.00

\* The front and the side edge are polished, while the rest is satin.

**Note:** Complete with fixing systems for single and back to back mounting on wood (X 0531, X 0528) and glass doors (X 0530, X 0528).

All the options listed in this page are considered standard.  
For more options on finishes, see pages 12-13, and upcharges at page 17.

For fixing spare parts, please check at pages 194-199.

Conversions from metric to U.S. measurements are approximate.

## K 1228 Yoshimi Kono

Material Brass Collection Fusital

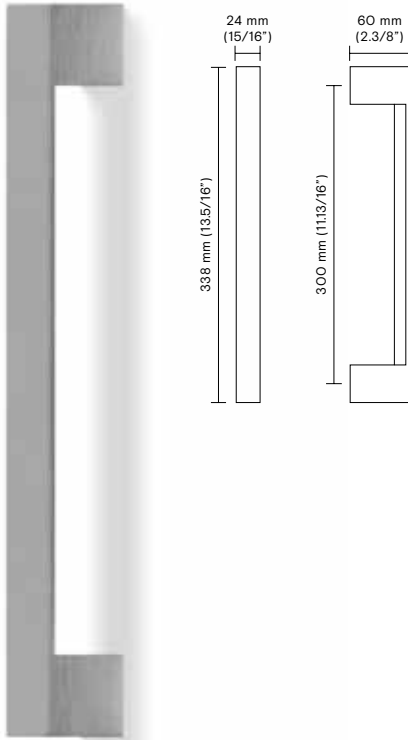

### Retail price

Finish	Center to center (mm/inches)	Single	Back to back
<b>26</b> Polished chrome	300 (11.13/16")	\$ 386.00	\$ 820.00

**Note:** Complete with fixing systems for single and back to back mounting on wood (X 0531, X 0528) and glass doors (X 0530, X 0528).

## K 1231

Material Brass Collection Lab

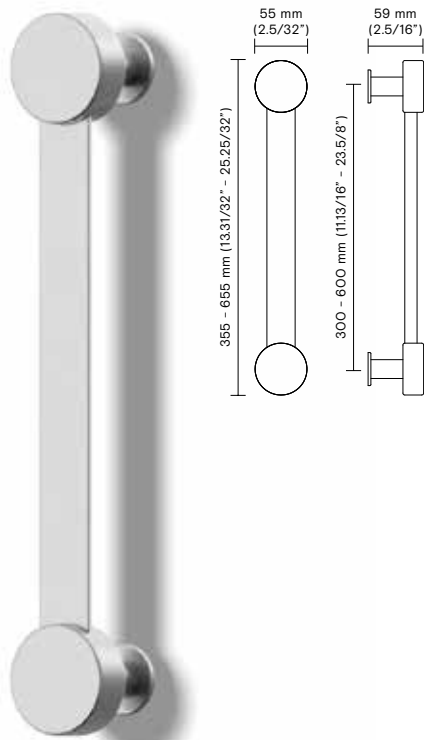

### Retail price

Finish	Center to center (mm/inches)	Single	Back to back
<b>06M</b> Matt bronze	300 (11.13/16")	\$ 371.00	\$ 786.00
	600 (23.5/8")	\$ 441.00	\$ 926.00
<b>16</b> Dull black	300 (11.13/16")	\$ 306.00	\$ 657.00
	600 (23.5/8")	\$ 353.00	\$ 749.00
<b>22M</b> Matt white	300 (11.13/16")	\$ 306.00	\$ 657.00
	600 (23.5/8")	\$ 353.00	\$ 749.00
<b>26</b> Polished chrome	300 (11.13/16")	\$ 313.00	\$ 670.00
	600 (23.5/8")	\$ 361.00	\$ 767.00
<b>26D</b> Satin chrome	300 (11.13/16")	\$ 313.00	\$ 670.00
	600 (23.5/8")	\$ 361.00	\$ 767.00

**Note:** Complete with fixing systems for single and back to back mounting on wood (X 0531, X 0528) and glass doors (X 0530, X 0528).

All the options listed in this page are considered standard.  
For more options on finishes, see pages 12-13, and upcharges at page 17.

For fixing spare parts, please check at pages 194-199.

Conversions from metric to U.S. measurements are approximate.

## K 1235

Material Aluminum Collection Lab

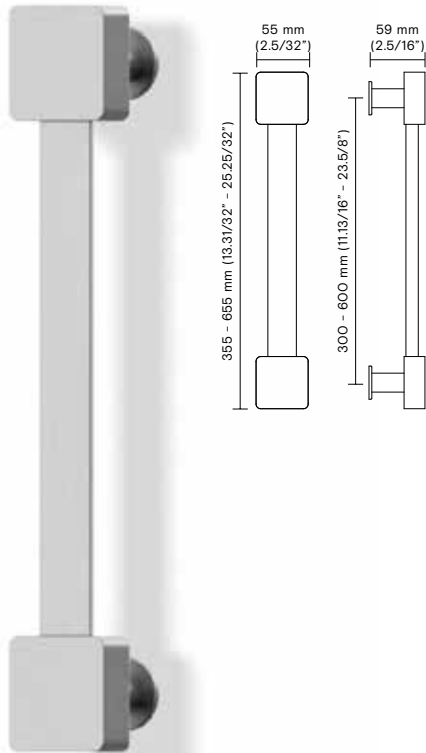

### Retail price

Finish	Center to center (mm/inches)	Single	Back to back
<b>26</b> Polished chrome	300 (11.13/16")	\$ 389.00	\$ 823.00
	600 (23.5/8")	\$ 389.00	\$ 823.00
<b>26D</b> Satin chrome	300 (11.13/16")	\$ 436.00	\$ 915.00
	600 (23.5/8")	\$ 436.00	\$ 915.00

**Note:** Complete with fixing systems for single and back to back mounting on wood (X O531, X O528) and glass doors (X O530, X O528).

## P 5405 Taller Design Ricardo Bofill

Material Stainless steel AISI 316 L Collection Fusital

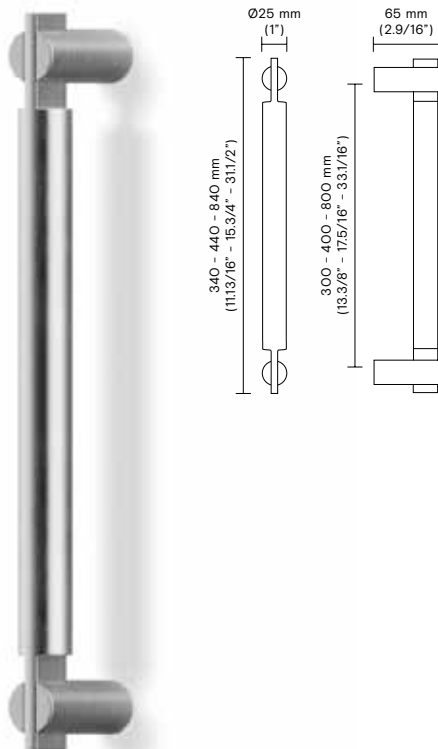

### Retail price

Finish	Center to center (mm/inches)	Single	Back to back
<b>32</b> Polished stainless steel	300 (11.13/16")	\$ 1,014.00	\$ 2,139.00
	400 (15.3/4")	\$ 1,287.00	\$ 2,683.00
	800 (31.1/2")	\$ 1,569.00	\$ 3,246.00
<b>32D</b> Satin stainless steel	300 (11.13/16")	\$ 781.00	\$ 1,670.00
	400 (15.3/4")	\$ 984.00	\$ 2,075.00
	800 (31.1/2")	\$ 1,199.00	\$ 2,506.00

**Note:** Complete with fixing systems for single and back to back mounting on wood (X O510, X O509) and glass doors (X O508, X O510).

All the options listed in this page are considered standard.  
For more options on finishes, see pages 12-13, and upcharges at page 17.

For fixing spare parts, please check at pages 194-199.

Conversions from metric to U.S. measurements are approximate.

## P 5406 Antonio Citterio

Material Stainless steel AISI 316 L Collection Fusital

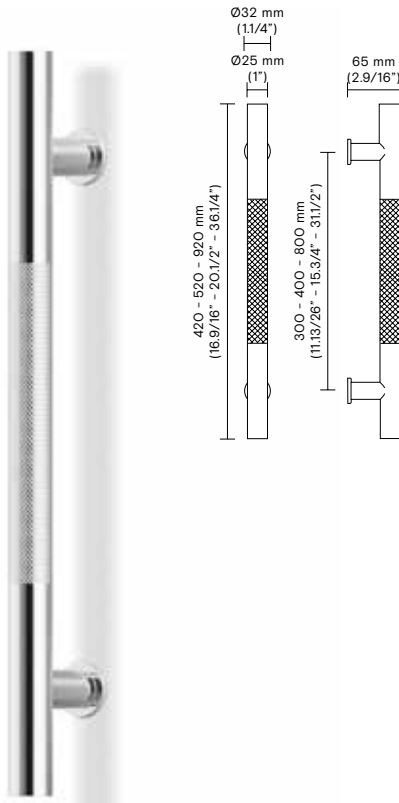

### Retail price

Finish	Center to center (mm/inches)	Single	Back to back
32 Polished stainless steel	300 (11.13/16")	\$ 1,025.00	\$ 2,160.00
	400 (15.3/4")	\$ 1,412.00	\$ 2,934.00
	800 (31.1/2")	\$ 1,722.00	\$ 3,552.00
32D Satin stainless steel	300 (11.13/16")	\$ 823.00	\$ 1,754.00
	400 (15.3/4")	\$ 1,082.00	\$ 2,266.00
	800 (31.1/2")	\$ 1,316.00	\$ 2,737.00

**Note:** Complete with fixing systems for single and back to back mounting on wood (X 0510, X 0509) and glass doors (X 0508, X 0510).

## P 5408 Antonio Citterio

Material Stainless steel AISI 316 L Collection Fusital

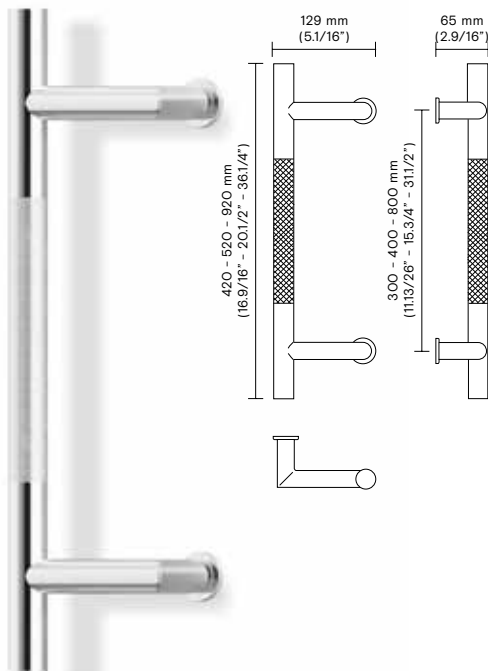

### Retail price

Finish	Center to center (mm/inches)	Single	Back to back
32 Polished stainless steel	300 (11.13/16")	\$ 1,831.00	\$ 3,773.00
	400 (15.3/4")	\$ 2,162.00	\$ 4,433.00
	800 (31.1/2")	\$ 2,499.00	\$ 5,106.00
32D Satin stainless steel	300 (11.13/16")	\$ 1,413.00	\$ 2,936.00
	400 (15.3/4")	\$ 1,658.00	\$ 3,526.00
	800 (31.1/2")	\$ 1,916.00	\$ 3,939.00

**Note:** Complete with fixing systems for single and back to back mounting on wood (X 0510, X 0509) and glass doors (X 0508, X 0510).

All the options listed in this page are considered standard.  
For more options on finishes, see pages 12-13, and upcharges at page 17.

For fixing spare parts, please check at pages 194-199.

Conversions from metric to U.S. measurements are approximate.



Each handleset can be matched with an interior lever.

Any lever can be used as interior trim.

Choose a lever model from one of the groups on the front page.

## K 1810 Entry Handleset

Choose any lever as interior trim.

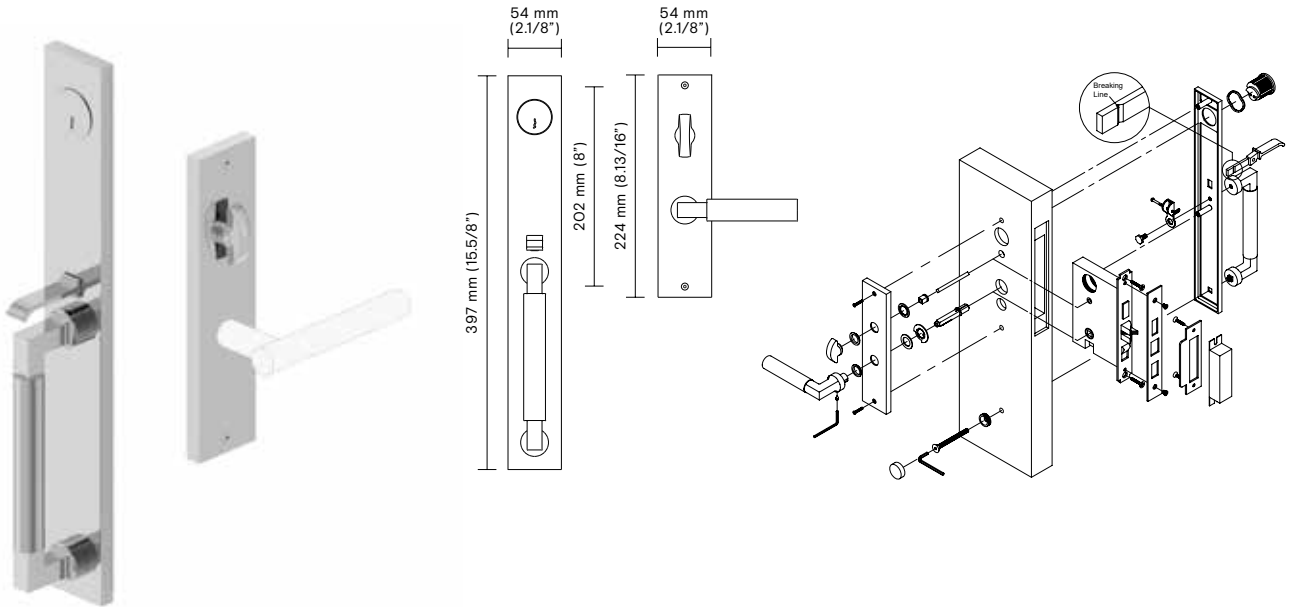

## K 1868 Entry Handleset

Choose any lever as interior trim.

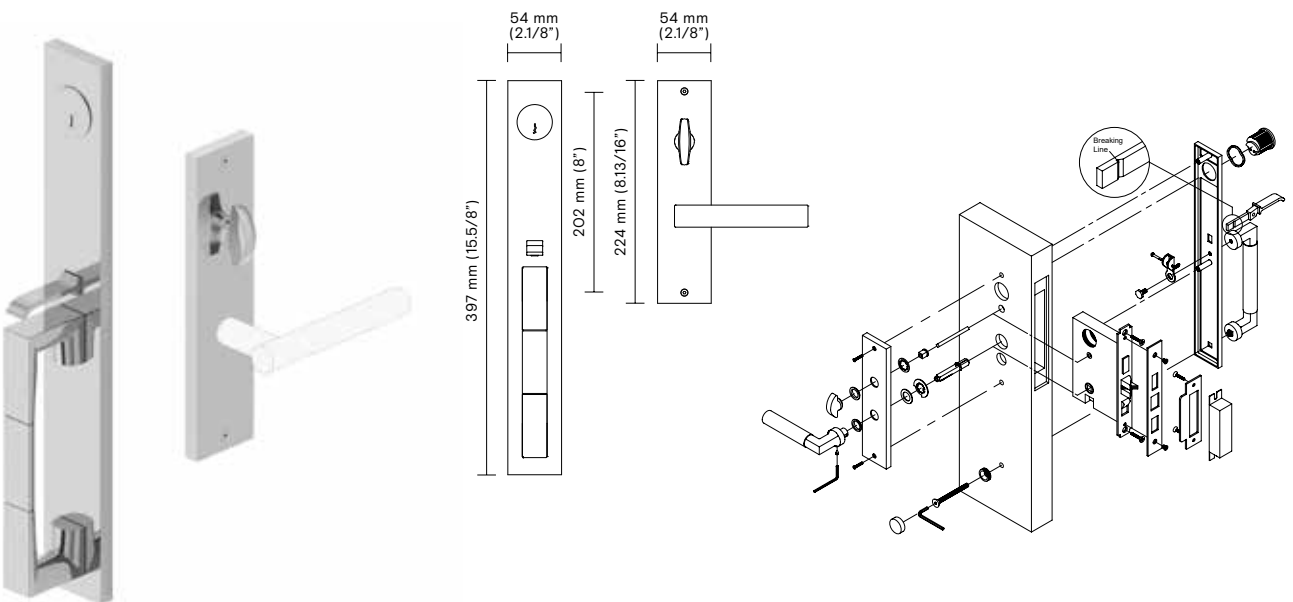

## K 1869 Entry Handleset

Choose any lever as interior trim.

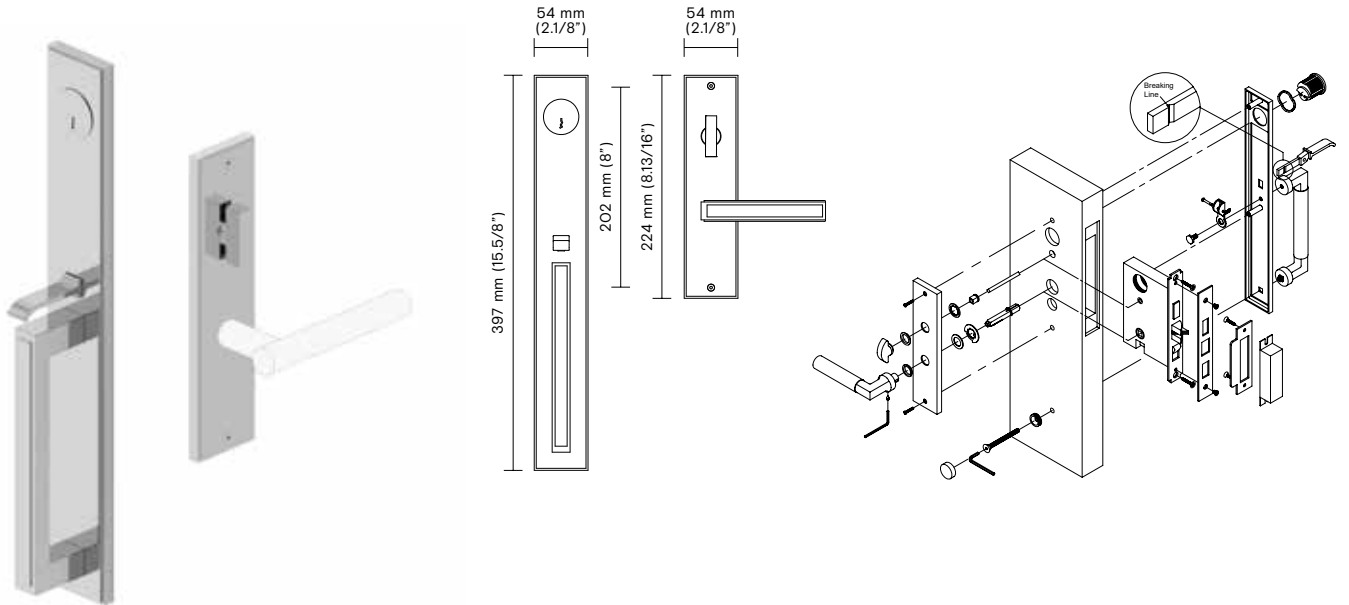

## K 1870 Entry Handleset

Choose any lever as interior trim.

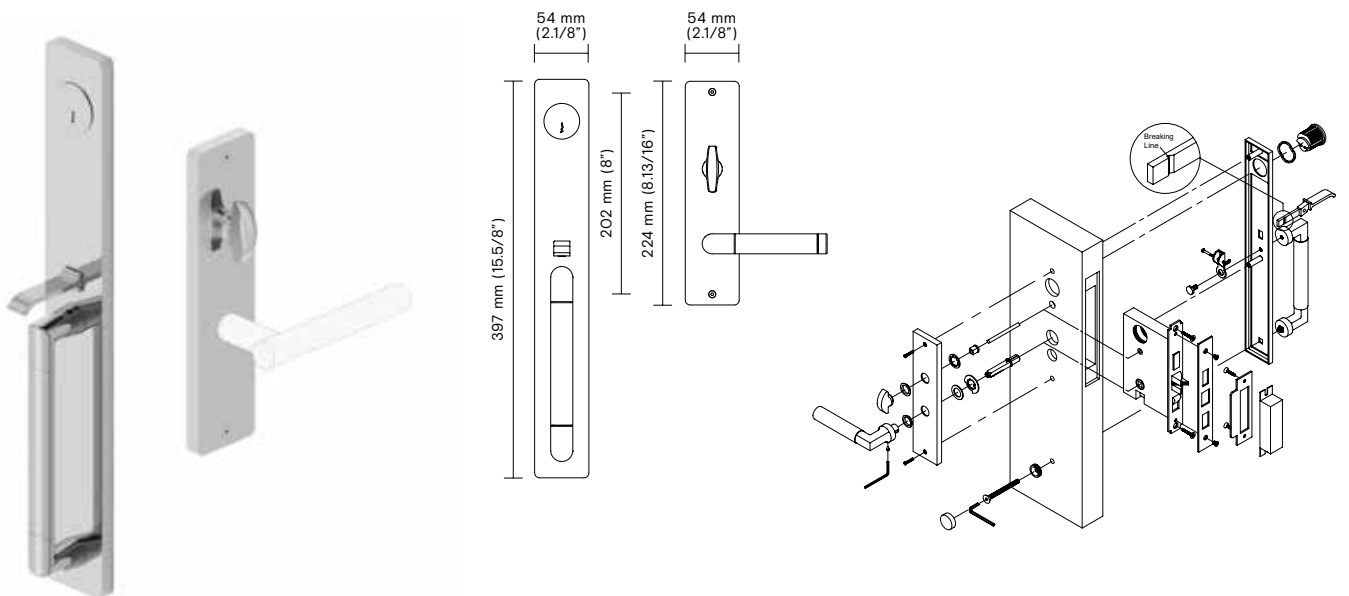

### Group 1

H 198, H 1003, H 1022, H 1024, H 1050, H 4730, H 4742, K 1155, K 1168, K 1170

Finish	K 1810		K 1868		K 1869		K 1870	
	Entry ENT	Dummy Set FD	Entry ENT	Dummy Set FD	Entry ENT	Dummy Set FD	Entry ENT	Dummy Set FD
26 Polished chrome	\$ 1,454.00	\$ 668.00	\$ 1,599.00	\$ 780.00	\$ 1,454.00	\$ 709.00	\$ 1,454.00	\$ 709.00
26D Satin chrome	\$ 1,491.00	\$ 734.00	\$ 1,640.00	\$ 807.00	\$ 1,491.00	\$ 734.00	\$ 1,491.00	\$ 734.00

### Group 2

H 1016, H 1026, H 1027, H 1044 U, H 1045, H 1046, H 1049, H 1052, H 1054, H 1056, H 1057, H 1062, H 1066

Finish	K 1810		K 1868		K 1869		K 1870	
	Entry ENT	Dummy Set FD	Entry ENT	Dummy Set FD	Entry ENT	Dummy Set FD	Entry ENT	Dummy Set FD
26 Polished chrome	\$ 1,479.00	\$ 747.00	\$ 1,627.00	\$ 821.00	\$ 1,479.00	\$ 747.00	\$ 1,479.00	\$ 747.00
26D Satin chrome	\$ 1,504.00	\$ 759.00	\$ 1,655.00	\$ 834.00	\$ 1,504.00	\$ 759.00	\$ 1,504.00	\$ 759.00

### Group 3

H 1039, H 1040, H 1060, H 1068, H 1069, H 1748, K 1054, K 1056, K 1060, K 1171, K 1730

Finish	K 1810		K 1868		K 1869		K 1870	
	Entry ENT	Dummy Set FD	Entry ENT	Dummy Set FD	Entry ENT	Dummy Set FD	Entry ENT	Dummy Set FD
26 Polished chrome	\$ 1,627.00	\$ 859.00	\$ 1,752.00	\$ 945.00	\$ 1,592.00	\$ 859.00	\$ 1,592.00	\$ 859.00
26D Satin chrome	\$ 1,655.00	\$ 873.00	\$ 1,778.00	\$ 960.00	\$ 1,617.00	\$ 873.00	\$ 1,617.00	\$ 873.00

### Group 4

H 163, H 411, H 1043, H 1044, H 1058

Finish	K 1810		K 1868		K 1869		K 1870	
	Entry ENT	Dummy Set FD	Entry ENT	Dummy Set FD	Entry ENT	Dummy Set FD	Entry ENT	Dummy Set FD
26 Polished chrome	\$ 1,415.00	\$ 683.00	\$ 1,556.00	\$ 752.00	\$ 1,415.00	\$ 683.00	\$ 1,415.00	\$ 683.00
26D Satin chrome	\$ 1,454.00	\$ 696.00	\$ 1,599.00	\$ 765.00	\$ 1,454.00	\$ 696.00	\$ 1,454.00	\$ 696.00

All the options listed in this page are considered standard.  
For more options on finishes, see pages 12-13, and upcharges at page 17.

## Group 5

H 315, H 317, H 327, H 330, H 334, H 338, H 348, H 361, H 364, H 367, H 368, H 370, H 372, H 381, H 382, H 383, H 385, H 386, K 383

Finish	K 1810		K 1868		K 1869		K 1870	
	Entry ENT	Dummy Set FD	Entry ENT	Dummy Set FD	Entry ENT	Dummy Set FD	Entry ENT	Dummy Set FD
26 Polished chrome	\$ 1,516.00	\$ 773.00	\$ 1,516.00	\$ 773.00	\$ 1,516.00	\$ 773.00	\$ 1,516.00	\$ 773.00
26D Satin chrome	\$ 1,555.00	\$ 785.00	\$ 1,555.00	\$ 785.00	\$ 1,555.00	\$ 785.00	\$ 1,555.00	\$ 785.00

## Group 6

H 311, H 329, H 335, H 343, H 359, H 376, H 378, H 384, K 378

Finish	K 1810		K 1868		K 1869		K 1870	
	Entry ENT	Dummy Set FD	Entry ENT	Dummy Set FD	Entry ENT	Dummy Set FD	Entry ENT	Dummy Set FD
26 Polished chrome	\$ 1,579.00	\$ 848.00	\$ 1,579.00	\$ 848.00	\$ 1,579.00	\$ 848.00	\$ 1,579.00	\$ 848.00
26D Satin chrome	\$ 1,617.00	\$ 859.00	\$ 1,617.00	\$ 859.00	\$ 1,617.00	\$ 859.00	\$ 1,617.00	\$ 859.00

## Group 7

H 377, K 377

Finish	K 1810		K 1868		K 1869		K 1870	
	Entry ENT	Dummy Set FD	Entry ENT	Dummy Set FD	Entry ENT	Dummy Set FD	Entry ENT	Dummy Set FD
26 Polished chrome	\$ 1,768.00	\$ 1,037.00	\$ 1,768.00	\$ 1,037.00	\$ 1,768.00	\$ 1,037.00	\$ 1,768.00	\$ 1,037.00
26D Satin chrome	\$ 1,793.00	\$ 1,049.00	\$ 1,793.00	\$ 1,049.00	\$ 1,793.00	\$ 1,049.00	\$ 1,793.00	\$ 1,049.00

## Group 8

H 356, H 379, H 380

Finish	K 1810		K 1868		K 1869		K 1870	
	Entry ENT	Dummy Set FD	Entry ENT	Dummy Set FD	Entry ENT	Dummy Set FD	Entry ENT	Dummy Set FD
26 Polished chrome	\$ 1,793.00	\$ 1,075.00	\$ 1,793.00	\$ 1,075.00	\$ 1,793.00	\$ 1,075.00	\$ 1,793.00	\$ 1,075.00
26D Satin chrome	\$ 1,832.00	\$ 1,100.00	\$ 1,832.00	\$ 1,100.00	\$ 1,832.00	\$ 1,100.00	\$ 1,832.00	\$ 1,100.00

All the options listed in this page are considered standard.  
For more options on finishes, see pages 12-13, and upcharges at page 17.

## K 1186 Dummy

Material Brass Collection Lab

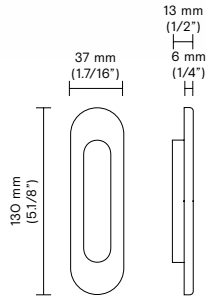

### Retail price

Finish	Door thickness 1.3/4"	Door thickness 1.3/8"
<b>03</b> Polished brass	\$ 78.00	\$ 78.00
<b>03D</b> Satin brass	\$ 78.00	\$ 78.00
<b>06A</b> Anticato	\$ 81.00	\$ 81.00
<b>06B</b> Brunito	\$ 78.00	\$ 78.00
<b>15</b> Satin nickel	\$ 99.00	\$ 99.00
<b>26</b> Polished chrome	\$ 78.00	\$ 78.00
<b>26D</b> Satin chrome	\$ 81.00	\$ 81.00

Dummy piece.

## K 1195 Dummy

Material Brass Collection Lab

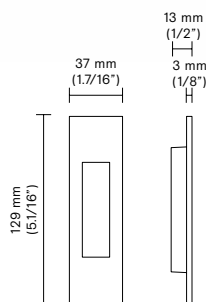

### Retail price

Finish	Door thickness 1.3/4"	Door thickness 1.3/8"
<b>26</b> Polished chrome	\$ 86.00	\$ 86.00
<b>26D</b> Satin chrome	\$ 90.00	\$ 90.00

Dummy piece.

All the options listed in this page are considered standard.  
For more options on finishes, see pages 12-13, and upcharges at page 17.

Conversions from metric to U.S. measurements are approximate.

## K 1202 Passage

Material Brass Collection Lab

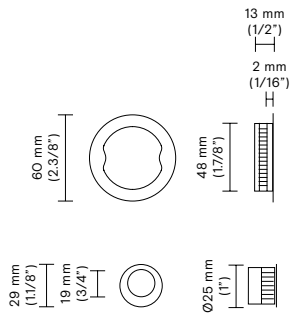

### Retail price

Finish	Door thickness 1.3/4"	Door thickness 1.3/8"
<b>O3</b> Polished brass	\$ 127.00	\$ 127.00
<b>O3D</b> Satin brass	\$ 127.00	\$ 127.00
<b>O6A</b> Anticato	\$ 127.00	\$ 127.00
<b>O6B</b> Brunito	\$ 127.00	\$ 127.00
<b>15</b> Satin nickel	\$ 184.00	\$ 184.00
<b>26</b> Polished chrome	\$ 142.00	\$ 142.00
<b>26D</b> Satin chrome	\$ 142.00	\$ 142.00

Complete set with recessed finger pull - no lock.

## K 1203 Finger Pull

Material Brass Collection Lab



### Retail price

Finish	Door thickness 1.3/4"	Door thickness 1.3/8"
<b>O3</b> Polished brass	\$ 33.00	\$ 33.00
<b>O3D</b> Satin brass	\$ 33.00	\$ 33.00
<b>O6A</b> Anticato	\$ 33.00	\$ 33.00
<b>15</b> Satin nickel	\$ 35.00	\$ 35.00
<b>26</b> Polished chrome	\$ 35.00	\$ 35.00
<b>26D</b> Satin chrome	\$ 35.00	\$ 35.00

Recessed finger pull - spare apart.

The privacy flush pulls accommodate 1.3/4" and 1.3/8" door thickness. 1.3/8" door thickness requires minimum pocket width of 2.1/8", a spacer will add 1/8" to surface on both sides of the door.

Conversions from metric to U.S. measurements are approximate.

The finishes above are considered standard. For different finish options see pages 12-13 and pricing at page 17.

## K 1204 Privacy

Material Brass Collection Lab

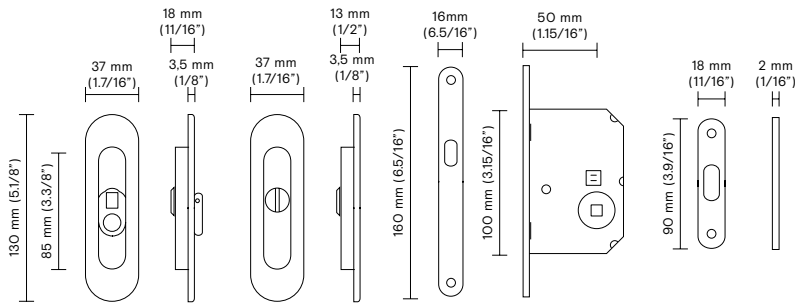
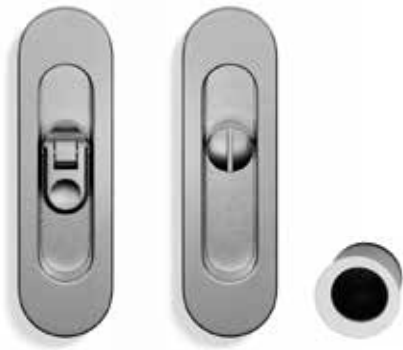

### Retail price

Finish	Door thickness 1.3/4"	Door thickness 1.3/8"
<b>03</b> Polished brass	\$ 263.00	\$ 263.00
<b>03D</b> Satin brass	\$ 263.00	\$ 263.00
<b>06A</b> Anticato	\$ 263.00	\$ 263.00
<b>15</b> Satin nickel	\$ 418.00	\$ 418.00
<b>26</b> Polished chrome	\$ 289.00	\$ 289.00
<b>26D</b> Satin chrome	\$ 289.00	\$ 289.00

Complete set with European style lock and recessed finger pull.

## K 1206 Passage

Material Brass Collection Lab

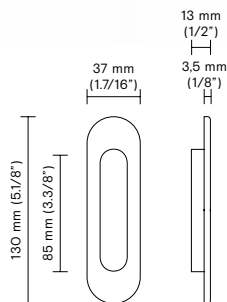
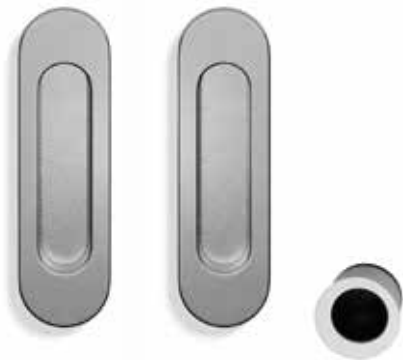

### Retail price

Finish	Door thickness 1.3/4"	Door thickness 1.3/8"
<b>03</b> Polished brass	\$ 158.00	\$ 158.00
<b>03D</b> Satin brass	\$ 158.00	\$ 158.00
<b>06A</b> Anticato	\$ 158.00	\$ 158.00
<b>15</b> Satin nickel	\$ 250.00	\$ 250.00
<b>26</b> Polished chrome	\$ 173.00	\$ 173.00
<b>26D</b> Satin chrome	\$ 173.00	\$ 173.00

Complete set with recessed finger pull - no lock.



The privacy flush pulls accommodate 1 3/4" and 1 3/8" door thickness. 1 3/8" door thickness requires minimum pocket width of 2 1/8", a spacer will add 1/8" to surface on both sides of the door.

Conversions from metric to U.S. measurements are approximate.

The finishes above are considered standard. For different finish options see pages 12-13 and pricing at page 17.

The thumb turn protrudes 7/32" from surface plate. The pocket door thumb turn does not flush complete.

**Satin nickel** trims are combined with Satin chrome face and strike plates.  
**Polished nickel** trims are combined with Polished chrome face and strike plates.

## K 1211 Privacy

Material Brass Collection Lab

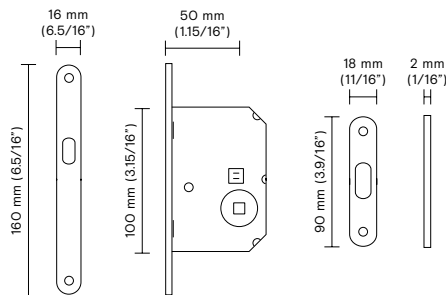
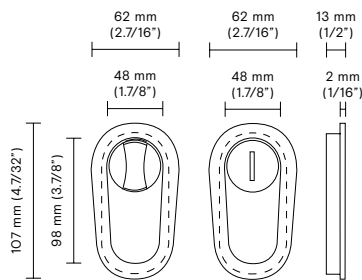
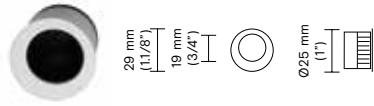

### Retail price

Finish	Function Privacy	
	Door thickness 1.3/4"	Door thickness 1.3/8"
<b>03</b> Polished brass	\$ 384.00	\$ 464.00
<b>14</b> Polished nickel	\$ 437.00	\$ 531.00
<b>15</b> Satin nickel	\$ 418.00	\$ 497.00
<b>26</b> Polished chrome	\$ 399.00	\$ 464.00
<b>26D</b> Satin chrome	\$ 399.00	\$ 464.00

Complete set with European lock and recessed finger pull.

## K 1212 Passage

Material Brass Collection Lab

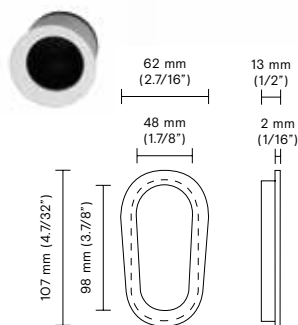

### Retail price

Finish	Door thickness 1.3/4"	
	Door thickness 1.3/4"	Door thickness 1.3/8"
<b>03</b> Polished brass	\$ 198.00	\$ 198.00
<b>14</b> Polished nickel	\$ 281.00	\$ 281.00
<b>15</b> Satin nickel	\$ 227.00	\$ 227.00
<b>26</b> Polished chrome	\$ 252.00	\$ 252.00
<b>26D</b> Satin chrome	\$ 215.00	\$ 215.00

Complete set with recessed finger pull - no lock.



The privacy flush pulls accommodate 1.3/4" and 1.3/8" door thickness. 1.3/8" door thickness requires minimum pocket width of 2.1/8", a spacer will add 1/8" to surface on both sides of the door.

Conversions from metric to U.S. measurements are approximate.

The finishes above are considered standard. For different finish options see pages 12-13 and pricing at page 17.

The thumb turn protrudes 7/32" from surface plate. The pocket door thumb turn does not flush complete.

**Satin nickel** trims are combined with Satin chrome face and strike plates.  
**Polished nickel** trims are combined with Polished chrome face and strike plates.

## K 1215 Privacy

Material Brass Collection Lab

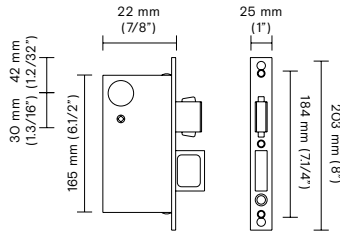
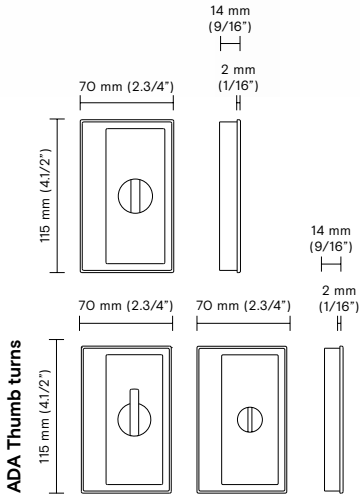

### Retail price

Finish	Privacy Standard	Privacy ADA
14 Polished nickel	\$ 1,367.00	\$ 1,572.00
15 Satin nickel	\$ 1,190.00	\$ 1,368.00
16 Dull black	\$ 1,246.00	\$ 1,420.00
26 Polished chrome	\$ 1,190.00	\$ 1,368.00
26D Satin chrome	\$ 1,190.00	\$ 1,368.00

Complete set with interior, exterior trim and pull-out mortise lock.

Minimum door thickness: 1.3/4"  
Must specify backset: 2.1/2" or 2.3/4".

Other backsets are available on special request.

## K 1215 Dummy

Material Brass Collection Lab

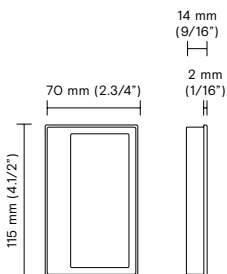

### Retail price

Finish	Door thickness 1.3/4"	Door thickness 1.3/8"
14 Polished nickel	\$ 164.00	\$ 164.00
15 Satin nickel	\$ 155.00	\$ 155.00
16 Dull black	\$ 117.00	\$ 117.00
26 Polished chrome	\$ 164.00	\$ 164.00
26D Satin chrome	\$ 155.00	\$ 155.00

Single dummy pull.

## K 1215 Entry

Material Brass Collection Lab



### Retail price

Finish	Door thickness 1.3/4"	Door thickness 1.3/8"
<b>14</b> Polished nickel	\$ 1,572.00	\$ 1,572.00
<b>15</b> Satin nickel	\$ 1,368.00	\$ 1,368.00
<b>16</b> Dull black	\$ 1,420.00	\$ 1,420.00
<b>26</b> Polished chrome	\$ 1,368.00	\$ 1,368.00
<b>26D</b> Satin chrome	\$ 1,368.00	\$ 1,368.00

Complete set with American mortise lock.  
Complete set with interior, exterior trim and pull-out mortise lock.

Minimum door thickness: 1.3/4"  
Must specify backset: 2.1/2" or 2.3/4".  
Other backsets are available on special request.

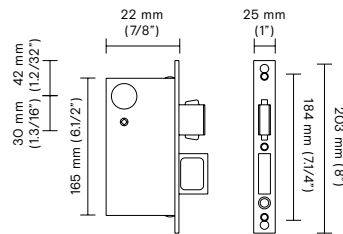
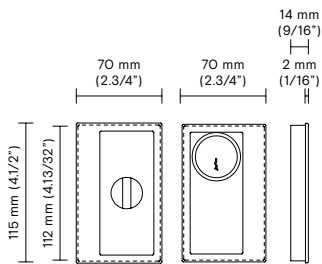

## K 1215 Passage

Material Brass Collection Lab



### Retail price

Finish	Function Passage Door thickness 1.3/4"	Door thickness 1.3/8"
<b>14</b> Polished nickel	\$ 814.00	\$ 814.00
<b>15</b> Satin nickel	\$ 814.00	\$ 814.00
<b>16</b> Dull black	\$ 814.00	\$ 814.00
<b>26</b> Polished chrome	\$ 814.00	\$ 814.00
<b>26D</b> Satin chrome	\$ 814.00	\$ 814.00

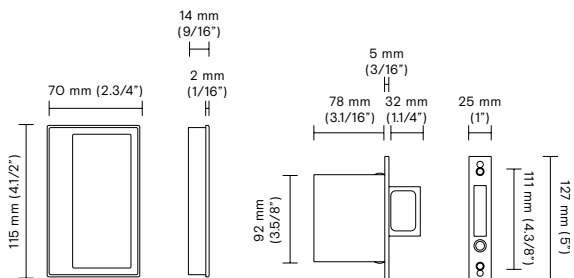

Conversions from metric to U.S. measurements are approximate.

The finishes above are considered standard.  
For different finish options see pages 12-13 and pricing at page 17.

## K 1230 Privacy • Yoshimi Kono

Material Brass Collection Fusital

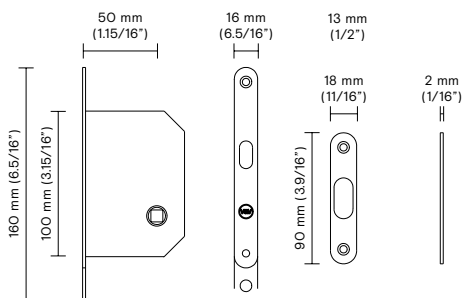
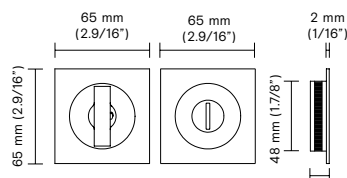
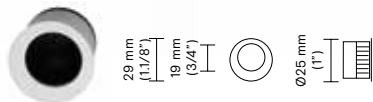

### Retail price

Finish	Door thickness 1.3/4"	Door thickness 1.3/8"
14 Polished nickel	\$ 374.00	\$ 430.00
15 Satin nickel	\$ 374.00	\$ 430.00
26 Polished chrome	\$ 326.00	\$ 376.00
26D Satin chrome	\$ 341.00	\$ 388.00

Complete set with European style lock and recessed finger pull.  
Also available with American privacy lock. For details of the lock please see page 144.  
For prices please contact our customer service.

## K 1232 Passage • Yoshimi Kono

Material Brass Collection Fusital

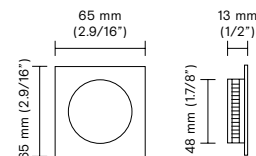

### Retail price

Finish	Door thickness 1.3/4"	Door thickness 1.3/8"
14 Polished nickel	\$ 189.00	\$ 189.00
15 Satin nickel	\$ 184.00	\$ 184.00
26 Polished chrome	\$ 165.00	\$ 165.00
26D Satin chrome	\$ 172.00	\$ 172.00

Complete set with recessed finger pull - no lock.  
Also available with American passage lock. For details of the lock please see page 145.  
For prices please contact our customer service.

The privacy flush pulls accommodate 1 3/4" and 1 3/8" door thickness. 1 3/8" door thickness requires minimum pocket width of 2 1/8", a spacer will add 1/8" to surface on both sides of the door.

Conversions from metric to U.S. measurements are approximate.

The finishes above are considered standard.  
For different finish options see pages 12-13 and pricing at page 17.

The thumb turn protrudes 7/32" from surface plate.  
The pocket door thumb turn does not flush complete.

Satin nickel trims are combined with Satin chrome face and strike plates.  
Polished nickel trims are combined with Polished chrome face and strike plates.

## K 3012 Privacy • Antonio Citterio with Toan Nguyen

Material Brass Collection Fusital

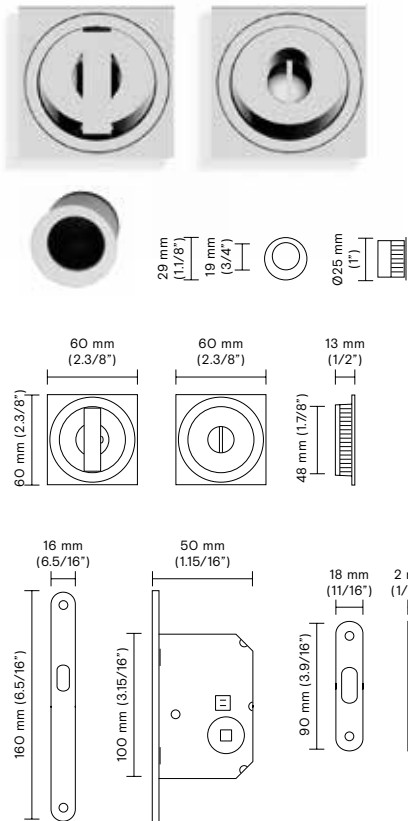

### Retail price

Finish	Door thickness 1.3/4"	Door thickness 1.3/8"
14 Polished nickel	\$ 428.00	\$ 492.00
15 Satin nickel	\$ 428.00	\$ 492.00
26 Polished chrome	\$ 378.00	\$ 429.00
26D Satin chrome	\$ 397.00	\$ 447.00

Complete set with European style lock and recessed finger pull.  
Also available with American privacy lock. For details of the lock please see page 144.  
For prices please contact our customer service.

## K 3014 Passage • Antonio Citterio with Toan Nguyen

Material Brass Collection Fusital

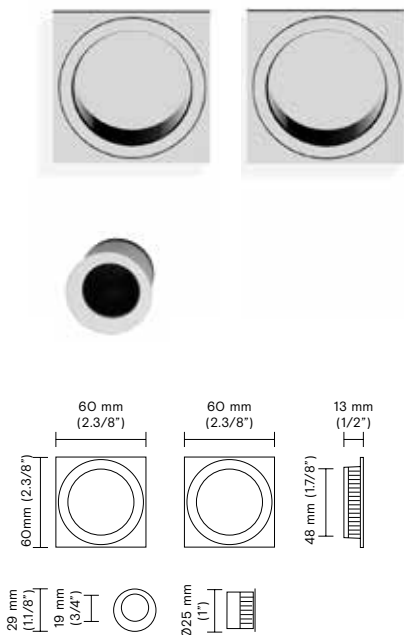

### Retail price

Finish	Door thickness 1.3/4"	Door thickness 1.3/8"
14 Polished nickel	\$ 247.00	\$ 247.00
15 Satin nickel	\$ 258.00	\$ 258.00
26 Polished chrome	\$ 221.00	\$ 221.00
26D Satin chrome	\$ 232.00	\$ 232.00

Complete set with recessed finger pull - no lock.  
Also available with American passage lock. For details of the lock please see page 145.  
For prices please contact our customer service.

The privacy flush pulls accommodate 1.3/4" and 1.3/8" door thickness.  
1.3/8" door thickness requires minimum pocket width of 2.1/8",  
a spacer will add 1/8" to surface on both sides of the door.

Conversions from metric to U.S. measurements are approximate.

The finishes above are considered standard.  
For different finish options see pages 12-13 and pricing at page 17.

The thumb turn protrudes 7/32" from surface plate.  
The pocket door thumb turn does not flush complete.

Satin nickel trims are combined with Satin chrome face and strike plates.

Polished nickel trims are combined with Polished chrome face and strike plates.

## K 4200 Privacy

Material Brass Collection Lab

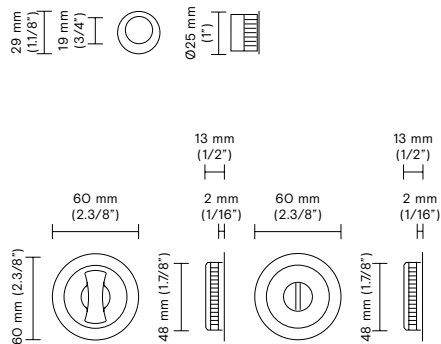

### Retail price

Finish	Door thickness 1.3/4"	Door thickness 1.3/8"
<b>03</b> Polished brass	\$ 133.00	\$ 270.00
<b>26</b> Polished chrome	\$ 147.00	\$ 302.00
<b>26D</b> Satin chrome	\$ 147.00	\$ 308.00

Complete set with European style lock and recessed finger pull.  
Also available with American privacy lock. For details of the lock please see page 144.  
For prices please contact our customer service.

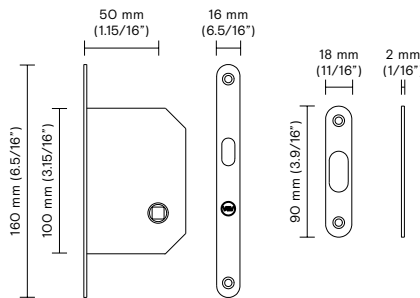

## K 4202 Passage

Material Brass Collection Lab

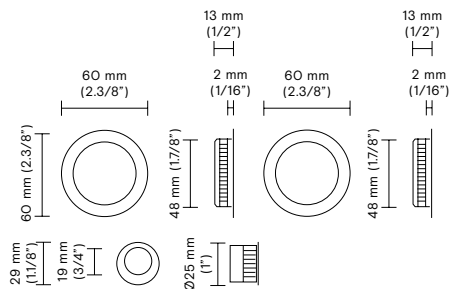

### Retail price

Finish	Door thickness 1.3/4"	Door thickness 1.3/8"
<b>03</b> Polished brass	\$ 71.00	\$ 71.00
<b>26</b> Polished chrome	\$ 78.00	\$ 78.00
<b>26D</b> Satin chrome	\$ 78.00	\$ 78.00

Complete set with recessed finger pull - no lock.  
Also available with American passage lock. For details of the lock please see page 145.  
For prices please contact our customer service.

The privacy flush pulls accommodate 1.3/4" and 1.3/8" door thickness. 1.3/8" door thickness requires minimum pocket width of 2.1/6", a spacer will add 1/8" to surface on both sides of the door.

Conversions from metric to U.S. measurements are approximate.

The finishes above are considered standard. For different finish options see pages 12-13 and pricing at page 17.

The thumb turn protrudes 7/32" from surface plate. The pocket door thumb turn does not flush complete.

**Satin nickel** trims are combined with Satin chrome face and strike plates.  
**Polished nickel** trims are combined with Polished chrome face and strike plates.



## Deadlock - Stainless steel material trims

### Retail price

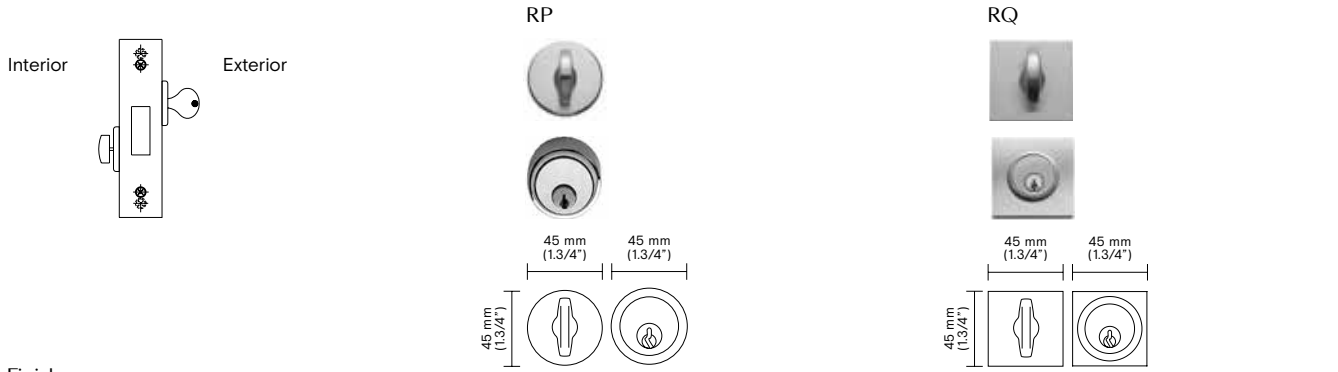

### Finish

<b>03</b> Polished brass	\$ 390.00	\$ 504.00
<b>03D</b> Satin brass	\$ 390.00	\$ 504.00
<b>14</b> Polished nickel	\$ 428.00	\$ 552.00
<b>15</b> Satin nickel	\$ 428.00	\$ 552.00
<b>16</b> Dull black	\$ 390.00	\$ 504.00
<b>26</b> Polished chrome	\$ 390.00	\$ 504.00
<b>26D</b> Satin chrome	\$ 420.00	\$ 537.00

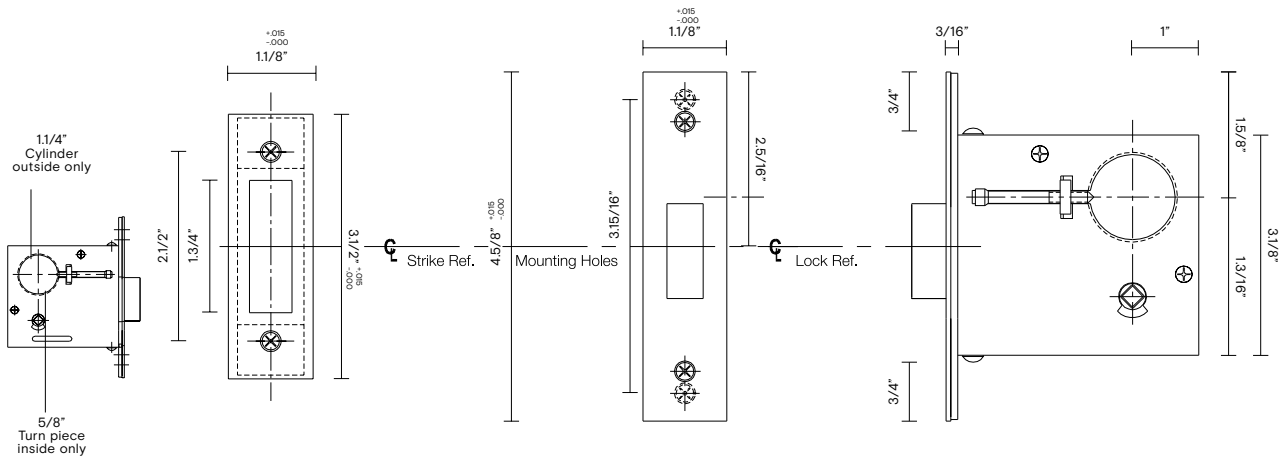

The finishes above are considered standard.  
Different finishes are available upon special request.  
See pages 12-13 for different finish options and page 17 for pricing.

Available in 2.3/4" and 2.1/2" for the same price.  
The backset needs to be specified by the time of the order.  
Cylinders are not included and priced apart.

# Deadlock - Stainless steel material trims

## Retail price

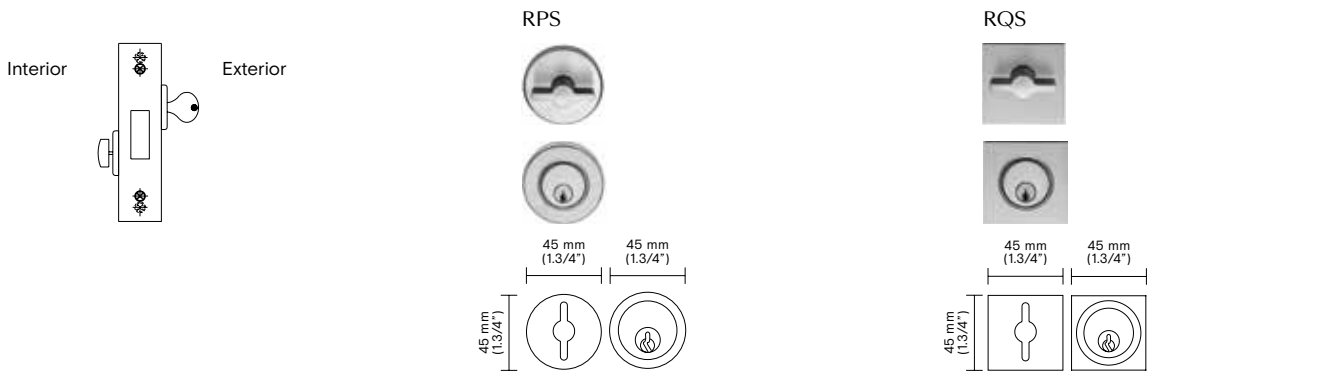

<b>32</b> Polished stainless steel	\$ 611.00	\$ 778.00
<b>32D</b> Satin stainless steel	\$ 558.00	\$ 724.00

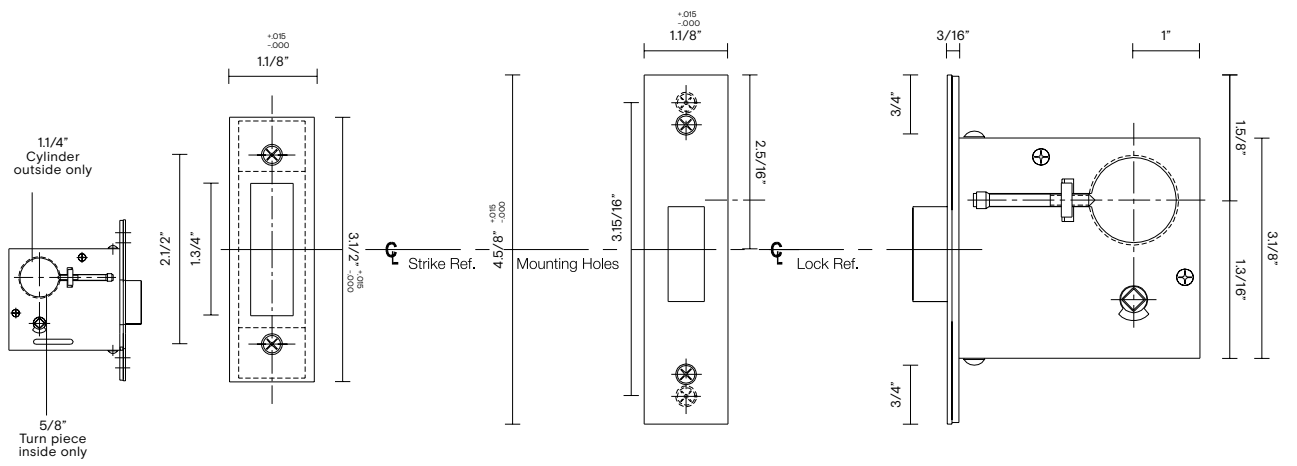

# 101 Single cylinder deadbolt

Brass or Stainless steel 316 L

## Retail price

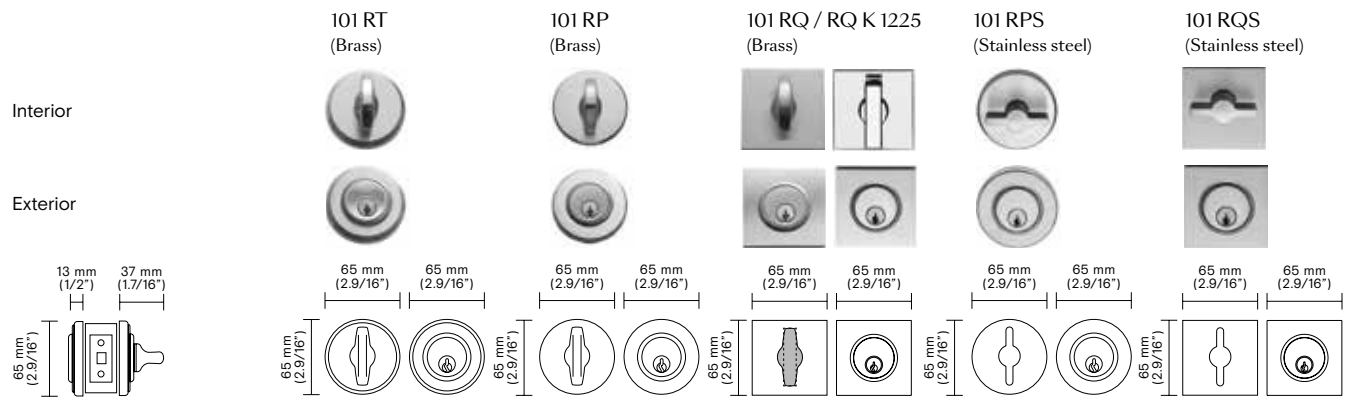

## Finish

<b>03</b> Polished brass	-	\$ 351.00	\$ 459.00	\$ 459.00	-	-
<b>03D</b> Satin brass	-	\$ 348.00	-	-	-	-
<b>03/03D</b> Polished brass / Satin brass (Split finish rosette)	\$ 314.00	-	-	-	-	-
<b>03M</b> Matt brass	-	\$ 348.00	\$ 462.00	\$ 462.00	-	-
<b>06</b> Antique natural brass	\$ 323.00	-	-	-	-	-
<b>06A</b> Anticato	\$ 343.00	\$ 357.00	-	-	-	-
<b>06B</b> Brunito	\$ 327.00	\$ 337.00	\$ 459.00	\$ 459.00	-	-
<b>06M</b> Matt bronze	-	\$ 368.00	\$ 486.00	\$ 486.00	-	-
<b>10S</b> Satin bronze	-	\$ 368.00	\$ 486.00	\$ 486.00	-	-
<b>14</b> Polished nickel	\$ 344.00	\$ 345.00	\$ 466.00	\$ 466.00	-	-
<b>15</b> Satin nickel	\$ 340.00	\$ 344.00	\$ 472.00	\$ 472.00	-	-
<b>16</b> Dull black	-	\$ 327.00	\$ 423.00	\$ 423.00	-	-
<b>17A</b> Polished black nickel	-	\$ 368.00	\$ 485.00	\$ 485.00	-	-
<b>22M</b> Matt white	-	\$ 339.00	\$ 436.00	\$ 436.00	-	-
<b>26</b> Polished chrome	-	\$ 331.00	\$ 441.00	\$ 441.00	-	-
<b>26D</b> Satin chrome	-	\$ 332.00	\$ 462.00	\$ 462.00	-	-
<b>26/26D</b> Polished chrome / Satin chrome (Split finish rosette)	\$ 326.00	-	-	-	-	-
<b>32</b> Polished stainless steel	-	-	-	-	\$ 644.00	\$ 668.00
<b>32D</b> Satin stainless steel	-	-	-	-	\$ 538.00	\$ 549.00
<b>56</b> Dark bronze	-	\$ 367.00	\$ 485.00	\$ 485.00	-	-

Conversions from metric to U.S. measurements are approximate.

Cylinder finishes are supplied as below, unless differently requested at the time of the order.

Trim finish 03 = Cylinder finish 03 / POLISHED BRASS  
 Trim finishes 03D, 03M = Cylinder in 03D / SATIN BRASS  
 Trim finish 06 = Cylinder finish 06 / ANTIQUE BRASS  
 Trim finishes 06A, 06B, 06M, 10S, 56 = Cylinder in 10B / OIL RUBBED BRONZE

Trim finishes 14, 17A, 26, 32 = Cylinder finish 26 / POLISHED CHROME  
 Trim finishes 15, 32D = Cylinder in 15 / SATIN NICKEL  
 Trim finish 16 = Cylinder finish 16 / DULL BLACK  
 Trim finish 22M = Cylinder in 22M / MATT WHITE  
 Trim finish 26D = Cylinder in 26D / SATIN CHROME

The finishes above are considered standard.  
 For different finish options see pages 12-13 and pricing at page 17.  
 The deadbolt can be ordered less exterior trim.

For pricing, remove \$150.00 from the listed prices above for 32 and 32D finish, and \$75.00 for all other finishes.  
 Specify "Less Exterior - L/E" as a note to the order.

For the pricing of the 101 RQ/K1225, consider the same price for the 101 RQ and specify as a note to the order "with K1225 thumb turn".

# 102 Double cylinder deadbolt

Brass or Stainless steel 316 L

## Retail price

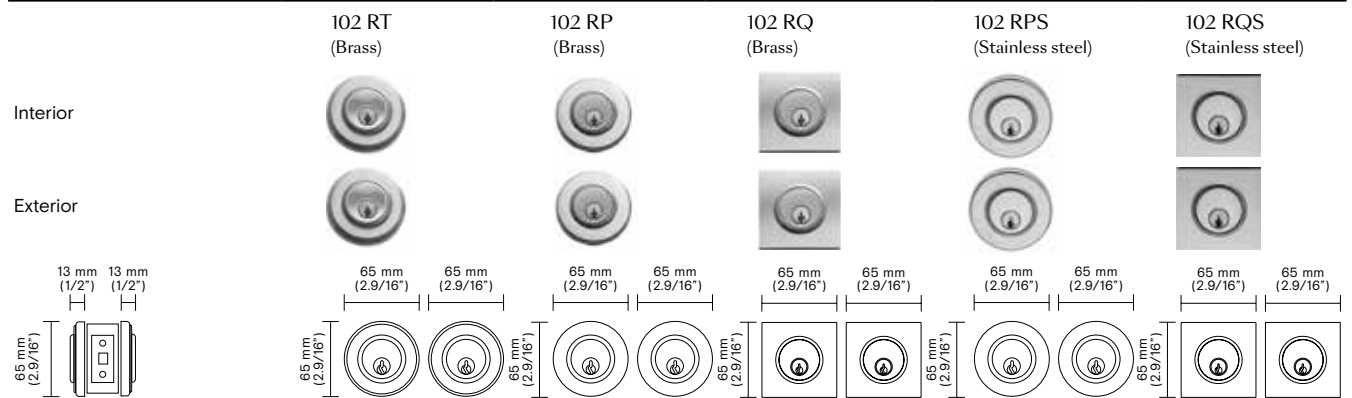

## Finish

<b>O3</b> Polished brass	-	\$ 334.00	\$ 437.00	-	-
<b>O3D</b> Satin brass	-	\$ 343.00	-	-	-
<b>O3/O3D</b> Polished brass / Satin brass (Split finish rosette)	\$ 329.00	-	-	-	-
<b>O3M</b> Matt brass	-	\$ 362.00	\$ 443.00	-	-
<b>O6</b> Antique natural brass	\$ 315.00	-	-	-	-
<b>O6A</b> Anticato	\$ 327.00	\$ 350.00	-	-	-
<b>O6B</b> Brunito	\$ 350.00	\$ 369.00	\$ 469.00	-	-
<b>O6M</b> Matt bronze	-	\$ 369.00	\$ 469.00	-	-
<b>10S</b> Satin bronze	-	\$ 369.00	\$ 469.00	-	-
<b>14</b> Polished nickel	\$ 353.00	\$ 362.00	\$ 443.00	-	-
<b>15</b> Satin nickel	\$ 362.00	\$ 370.00	\$ 469.00	-	-
<b>16</b> Dull black	-	\$ 334.00	\$ 437.00	-	-
<b>17A</b> Polished black nickel	-	\$ 369.00	\$ 469.00	-	-
<b>22M</b> Matt white	-	\$ 342.00	\$ 443.00	-	-
<b>26</b> Polished chrome	-	\$ 350.00	\$ 422.00	-	-
<b>26D</b> Satin chrome	-	\$ 346.00	\$ 443.00	-	-
<b>26/26D</b> Polished chrome / Satin chrome (Split finish rosette)	\$ 330.00	-	-	-	-
<b>32</b> Polished stainless steel	-	-	-	\$ 623.00	\$ 671.00
<b>32D</b> Satin stainless steel	-	-	-	\$ 538.00	\$ 577.00
<b>56</b> Dark bronze	-	\$ 369.00	\$ 469.00	-	-

Conversions from metric to U.S. measurements are approximate.

Cylinder finishes are supplied as below, unless differently requested at the time of the order.

Trim finish O3 = Cylinder finish O3 / POLISHED BRASS  
 Trim finishes O3D, O3M = Cylinder in O3D / SATIN BRASS  
 Trim finish O6 = Cylinder finish O6 / ANTIQUE BRASS  
 Trim finishes O6A, O6B, O6M, 10S, 56 = Cylinder in 10B / OIL RUBBED BRONZE

Trim finishes 14, 17A, 26, 32 = Cylinder finish 26 / POLISHED CHROME  
 Trim finishes 15, 32D = Cylinder in 15 / SATIN NICKEL  
 Trim finish 16 = Cylinder finish 16 / DULL BLACK  
 Trim finish 22M = Cylinder in 22M / MATT WHITE  
 Trim finish 26D = Cylinder in 26D / SATIN CHROME

The finishes above are considered standard.  
 For different finish options see pages 12-13 and pricing at page 17.  
 The deadbolt can be ordered less exterior trim.

For pricing, remove \$150.00 from the listed prices above for 32 and 32D finish, and \$75.00 for all other finishes. Specify "Less Exterior - L/E" as a note to the order.

For the pricing of the 101 RQ/K1225, consider the same price for the 101 RQ and specify as a note to the order "with K1225 thumb thurn".

## 105 Privacy bolts

Brass or Stainless steel 316 L

### Retail price

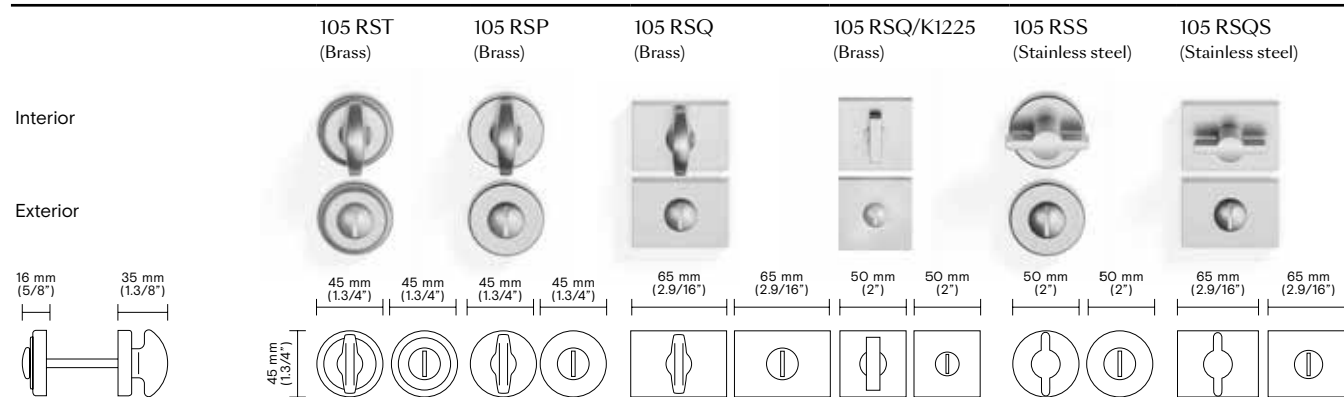

### Finish

	105 RST (Brass)	105 RSP (Brass)	105 RSQ (Brass)	105 RSQ/K1225 (Brass)	105 RSS (Stainless steel)	105 RSQS (Stainless steel)
<b>03</b> Polished brass	\$ 303.00	\$ 272.00	\$ 394.00	\$ 396.00	-	-
<b>03D</b> Satin brass	-	\$ 272.00	-	-	-	-
<b>03/03D</b> Polished brass / Satin brass (Split finish rosette)	\$ 299.00	-	-	-	-	-
<b>03M</b> Matt brass	-	\$ 310.00	\$ 423.00	\$ 436.00	-	-
<b>06</b> Antique natural brass	\$ 345.00	-	-	-	-	-
<b>06A</b> Anticato	\$ 366.00	\$ 303.00	-	-	-	-
<b>06B</b> Brunito	-	\$ 289.00	\$ 444.00	\$ 444.00	-	-
<b>06M</b> Matt bronze	-	\$ 332.00	\$ 444.00	\$ 471.00	-	-
<b>10S</b> Satin bronze	-	\$ 332.00	\$ 444.00	\$ 471.00	-	-
<b>14</b> Polished nickel	\$ 341.00	\$ 327.00	\$ 471.00	\$ 471.00	-	-
<b>15</b> Satin nickel	\$ 324.00	\$ 310.00	\$ 430.00	\$ 430.00	-	-
<b>16</b> Dull black	-	\$ 280.00	\$ 395.00	\$ 403.00	-	-
<b>17A</b> Polished black nickel	-	\$ 332.00	\$ 444.00	\$ 471.00	-	-
<b>22M</b> Matt white	-	\$ 332.00	\$ 395.00	\$ 471.00	-	-
<b>26</b> Polished chrome	-	\$ 276.00	\$ 397.00	\$ 376.00	-	-
<b>26D</b> Satin chrome	-	\$ 310.00	\$ 430.00	\$ 430.00	-	-
<b>26/26D</b> Polished chrome / Satin chrome (Split finish rosette)	\$ 361.00	-	-	-	-	-
<b>32</b> Polished stainless steel	-	-	-	-	\$301.00	\$ 567.00
<b>32D</b> Satin stainless steel	-	-	-	-	\$273.00	\$4 56.00
<b>56</b> Dark bronze	-	\$ 332.00	\$ 444.00	\$ 471.00	-	-

## 106 Privacy Bolts

For the 106 privacy bolt, call for pricing.

## 107 ADA Privacy Bolts

For the ADA compliant privacy bolt, add \$150 to the list prices above.

Conversions from metric to U.S. measurements are approximate.

The finishes above are considered standard. For different finish options see pages 12-13 and pricing at page 17. The 105 and 107 privacy bolts can be ordered less exterior trim.

For pricing, remove \$100.00 from the listed prices above for 32 and 32D finish, and \$50.00 for all other finishes. Specify "Less Exterior - L/E" as a note to the order.

For the privacy bolt with slim rosettes consider the same price of 105 RSP (round) and 105 RSQ (square).

**Standard** thumb turns for deadlocks, deadbolts, privacy bolts and mortise locks

**K1725 (Half moon)**

Brass

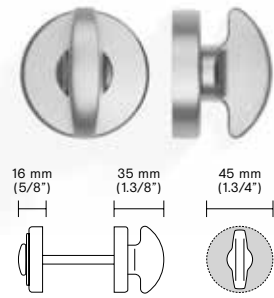

**K1225 (Square)**

Brass

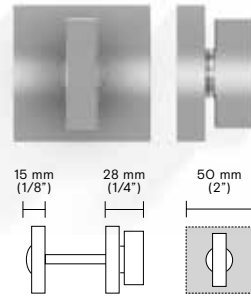

**S5501 (Butterfly)**

Stainless Steel (only for trims in Stainless steel)

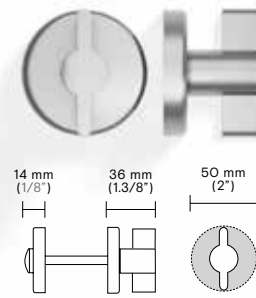

**Optional** thumb turns for deadlocks, deadbolts, privacy bolts and mortise locks

**K 3040 (KAN)**

Brass

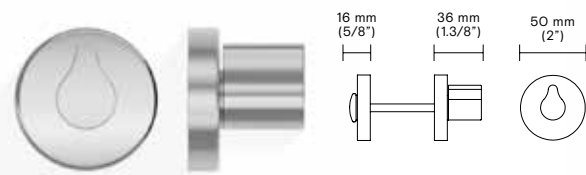

**K 1704 (Euro design)**

Brass

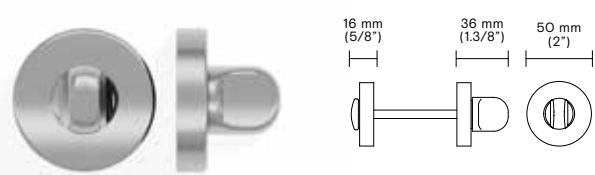

**K 3041 (CCD)**

Brass

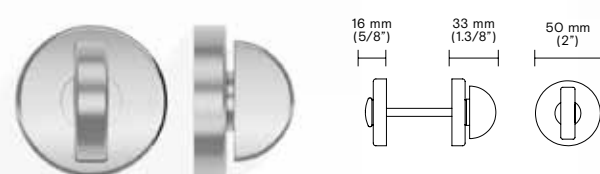

**K 1705 Custom \*\***

Brass

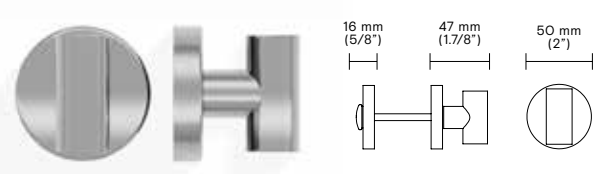

**K 1818 Custom \*\***

Brass

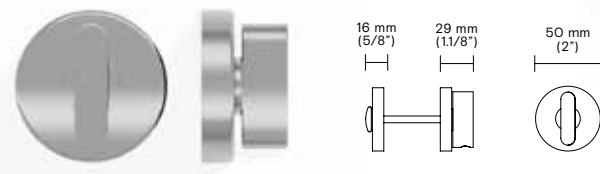

**K 1811 (ADA)**

Brass

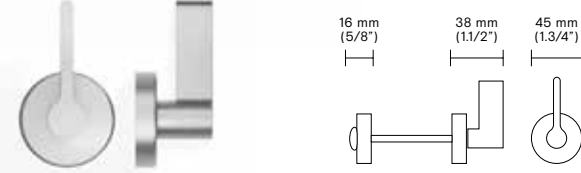

**Occupancy indicator on Emergency release**



The thumb turns shown in this page can be matched with either round or square rosettes, oval or rectangular plates.

In brackets are the names of the series.

The K1725 is provided standard on all the applications for brass levers.

The S5501 is standard for stainless steel levers.

The remaining thumb turns are provided only request, with an additional cost of \$150 LIST to the price of the standard brass thumb turn.

The thumb turns with (\*\*) are only available on a Minimum order quantity. Call for details.

The brass material thumb turns can be produced in any finish. See pages 12-13 for finish options.

Stainless steel thumb turn are only produced in 32/Polished stainless steel and 32D/Satin stainless steel.

Trim options

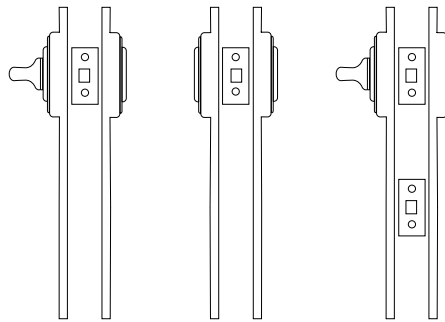
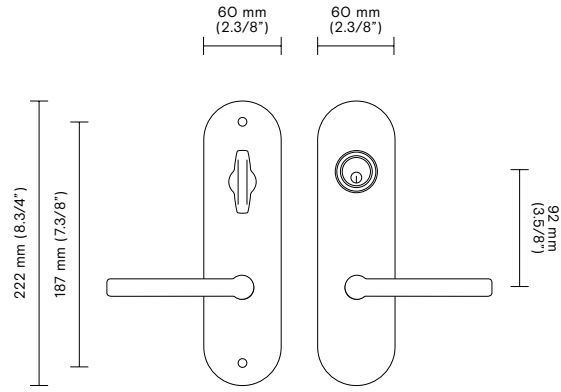
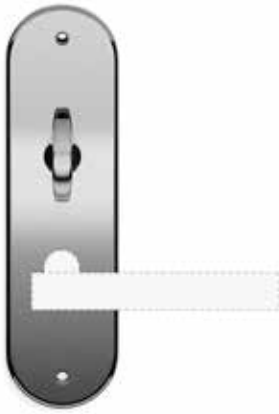

103 EP

104 EP

106 EP

EP

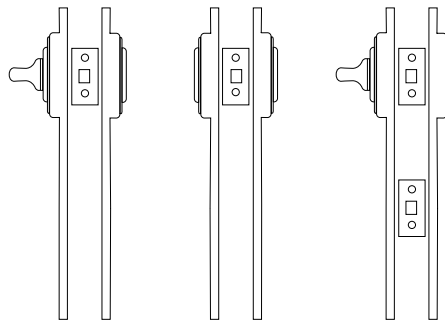
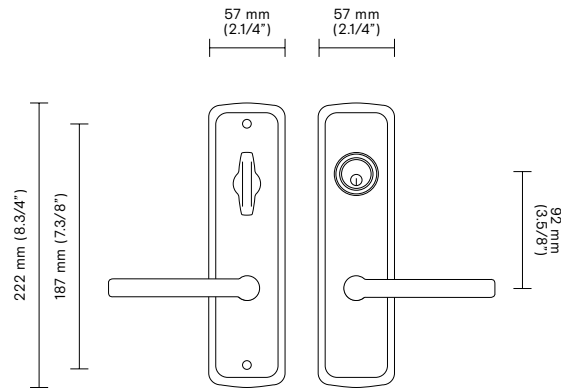

103 ET

104 ET

106 ET

ET

Specify one of the configurations:

- 103 Escutcheon single cylinder
- 104 Escutcheon double cylinder
- 106 Escutcheon privacy bolt

EP/ET = standard finish 26 - 26D  
 ER = standard finish 26 - 26D  
 ERS = available only in 32D finish

Special finishes available on request.  
 For different finish options see pages 12-13 and pricing at page 17.

# Trim options

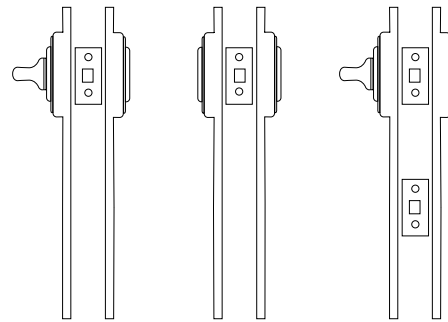
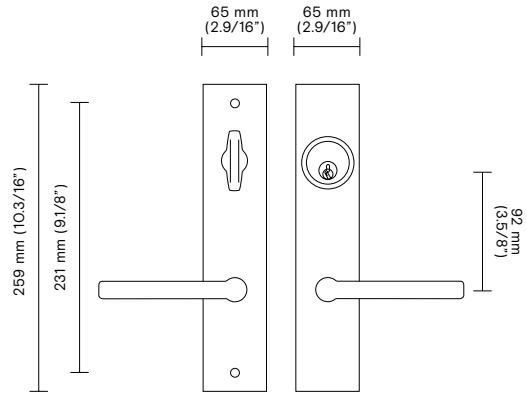

103 ER      104 ER      106 ER

**ER**

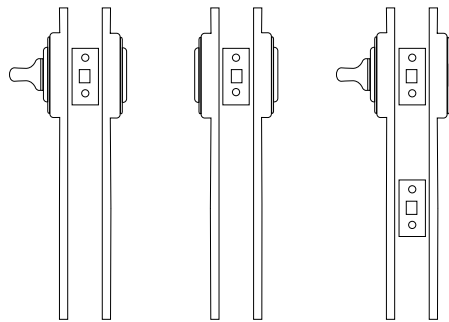
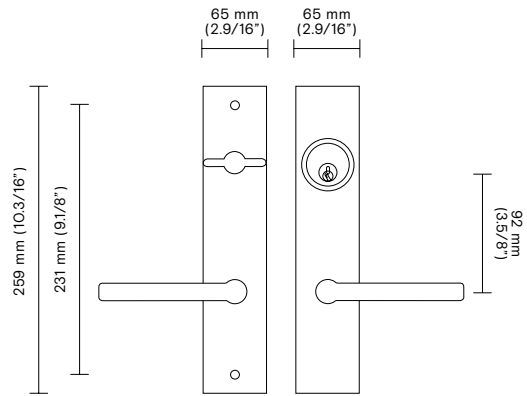

103 ERS      104 ERS      106 ERS

**ERS**  
(Only available for stainless steel levers)

**Specify one of the configurations:**

- 103 Escutcheon single cylinder
- 104 Escutcheon double cylinder
- 106 Escutcheon privacy bolt

EP/ET = standard finish 26 - 26D  
ER = standard finish 26 - 26D  
ERS = available only in 32D finish

Special finishes available on request.  
For different finish options see pages 12-13 and pricing at page 17.

### Group 1

H 198, H 1003, H 1022, H 1024, H 1050, H 4730, H 4742, K 1155, K 1168, K 1170

Model	Retail price			
	EP	ET	ER	ERS
103 Single cylinder	\$ 709.00	\$ 709.00	\$ 759.00	--
104 Double cylinder	\$ 709.00	\$ 709.00	\$ 734.00	--
106 Privacy bolt	\$ 658.00	\$ 658.00	\$ 696.00	--

### Group 2

H 165, H 176, H 1016, H 1026, H 1027, H 1044 U, H 1045, H 1046, H 1049, H 1052, H 1054, H 1056, H 1057, H 1061, H 1062, H 1066

Model	Retail price			
	EP	ET	ER	ERS
103 Single cylinder	\$ 773.00	\$ 773.00	\$ 823.00	--
104 Double cylinder	\$ 759.00	\$ 759.00	\$ 823.00	--
106 Privacy bolt	\$ 721.00	\$ 721.00	\$ 785.00	--

### Group 3

H 1039, H 1040, H 1060, H 1068, H 1748, K 1054, K 1056, K 1060, K 1061, K 1171, K 1730

Model	Retail price			
	EP	ET	ER	ERS
103 Single cylinder	\$ 999.00	\$ 999.00	\$ 1,024.00	--
104 Double cylinder	\$ 985.00	\$ 985.00	\$ 929.00	--
106 Privacy bolt	\$ 935.00	\$ 935.00	\$ 985.00	--

### Group 4

H 163, H 192, H 1004, H 1037, H 1043, H 1044, H 1058, H 411, H 414, H 415, H 416, H 419

Model	Retail price			
	EP	ET	ER	ERS
103 Single cylinder	\$ 645.00	\$ 645.00	\$ 709.00	\$ 809.00
104 Double cylinder	\$ 550.00	\$ 550.00	\$ 696.00	\$ 785.00
106 Privacy bolt	\$ 607.00	\$ 607.00	\$ 645.00	\$ 645.00

### Group 5

H 315, H 317, H 327, H 330, H 334, H 338, H 348, H 361, H 364, H 367, H 368, H 370, H 372, H 381, H 382, H 383, H 385, H 386, K 383

Model	Retail price			
	EP	ET	ER	ERS
103 Single cylinder	\$ 885.00	\$ 885.00	\$ 924.00	--
104 Double cylinder	\$ 859.00	\$ 859.00	\$ 910.00	--
106 Privacy bolt	\$ 798.00	\$ 798.00	\$ 859.00	--

EP/ET = standard finish 26 - 26D  
ER = standard finish 26 - 26D  
ERS = available only in 32D finish

Special finishes available on request.  
For different finish options see pages 12-13 and pricing at page 17.

## Group 6

H 311, H 329, H 335, H 343, H 359, H 376, H 378, H 384, H 5014, K 378,

Model	Retail price			
	EP	ET	ER	ERS
103 Single cylinder	\$ 999.00	\$ 999.00	\$ 1,037.00	\$ 924.00
104 Double cylinder	\$ 985.00	\$ 985.00	\$ 1,024.00	\$ 961.00
106 Privacy bolt	\$ 935.00	\$ 935.00	\$ 985.00	\$ 798.00

## Group 7

H 377, H 5008, K 5301, K 377

Model	Retail price			
	EP	ET	ER	ERS
103 Single cylinder	\$ 1,365.00	\$ 1,365.00	\$ 1,415.00	\$ 1,163.00
104 Double cylinder	\$ 1,353.00	\$ 1,353.00	\$ 1,389.00	\$ 1,188.00
106 Privacy bolt	\$ 1,303.00	\$ 1,303.00	\$ 1,353.00	\$ 1,037.00

## Group 8

H 356, H 379, H 380, H 5015/32D, H 5017

Model	Retail price			
	EP	ET	ER	ERS
103 Single cylinder	\$ 1,454.00	\$ 1,454.00	\$ 1,516.00	\$ 1,516.00
104 Double cylinder	\$ 1,440.00	\$ 1,440.00	\$ 1,504.00	\$ 1,579.00
106 Privacy bolt	\$ 1,389.00	\$ 1,389.00	\$ 1,465.00	\$ 1,389.00

## Group 9

H 5015 Black leather, H 5015 Orange leather

Model	Retail price			
	EP	ET	ER	ERS
103 Single cylinder	--	--	--	\$ 1,934.00
104 Double cylinder	--	--	--	\$ 1,959.00
106 Privacy bolt	--	--	--	\$ 1,768.00

## How to specify

Valli provides different configurations of Multipoint trim.  
In order to select the right configuration you should identify the following:

- 1. The name of the manufacturer of the door and of the multi-point lock.** Each manufacturer uses different templates for door drilling and different configurations are needed according to the manufacturer of the lock. Valli covers the main configurations of the following manufacturers:  
Weathershield®, Sierra Pacific®, PGT®, Pella®, Paddock®, Milgard®, Marvin®, Loewen®, KFV®, Jeld-Wen®, Hoppe®, G-U®, Crestline®, BiltBest®, Atrium®, Ashland®, Andersen®.
- 2. The distance between the lever and the cylinder (center to center).**  
Valli accommodates CTC distance of 92mm (3.5/8”) standard only.
- 3. The lever position on the plate if above or below the cylinder.**  
This determines the different functions – see page 163 for details.
- 4. The cylinder used in the door: if American or Euro profile cylinder.**  
The cylinder is always included in the configuration and pricing, unless differently specified.

When all these 4 questions are answered, it is possible to proceed with the specification.

<b>1</b>	<b>Lever model</b>	Chose from all our collection of levers, ex H 1054
<b>2</b>	<b>Trim options</b>	Chose among the options ar page 161, narrow long escutcheon plates or rosettes: Plates: NEP, NES, NER, NERS Rosettes: RSM, RSSM
<b>3</b>	<b>Door configuraton</b>	Please specify one of the 5 configurations from page 162.
<b>4</b>	<b>Function</b>	See page 163 to determine
<b>5</b>	<b>Handing</b>	Follow the diagram at page 22 to determine RH, LH, RHR, or LHR
<b>6</b>	<b>Finish</b>	NEP Available standard in 26 and 26D NER Available standard in 26 and 26D RSM Available standard in 26 and 26D NES, NERS and RSSM Available standard in 32D Different finishes available upon request. Choose from pages 12-13, pricing at page 17.
<b>7</b>	<b>Door thickness</b>	1.3/4” is considered standard. Accomodates up to 2.1/4” thick door. Upcharges apply. See page 17.
<b>8</b>	<b>Miscellaneous</b>	Note any special keying information or special instructions

Example	1	2	3	4	5	6	7	8
	H 1054	NEP	#1	EE	RH	26	1.3/4”	Off-set 55x47

# Trim options Multipoint trim

## Plates

**NEP** (Only for levers made of brass)  
**K 1789**

**EAB** Exterior plate  
Brass

**EAB** Interior plate  
Brass

**NES** (Only for levers made of stainless steel)  
**K 5701**

**EE** Exterior plate  
Stainless steel

**PAA** Interior plate  
Stainless steel

**NER** (Only for levers made of brass)  
**K 1805**

**EAB** Exterior plate  
Brass

**EAB** Interior plate  
Brass

**NEERS** (Only for levers made of stainless steel)  
**K 5713**

**EE** Exterior plate  
Stainless steel

**PAA** Interior plate  
Stainless steel

## Rosettes

**RSM**  
 (Only for levers made of brass)

**EE - PE**  
Brass

**RSSM**  
 (Only for levers made of stainless steel)

**EE - PE**  
Stainless Steel

## Door configuration Multipoint trim

### Standard Valli configuration

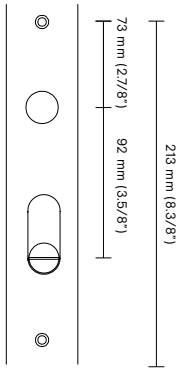

**Door configuration #1**  
American cylinder below handle  
3.5/8" (92mm) center to center

Accommodates: Pella®, Milgard®, Marvin®

### Additional configurations (to be approved by the R&D department)

All the configurations below can also be accommodated for non-pre-drilled doors.  
The doors must be drilled as per the dimensions in our standard configuration.

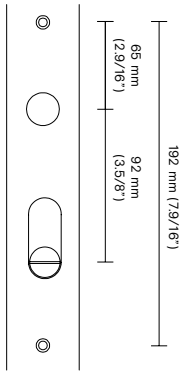

**Door configuration #2**  
American cylinder below handle  
3.5/8" (92mm) CTC

Accommodates: Superior®, Paddock®, G-U®, Atrium®, Andersen®

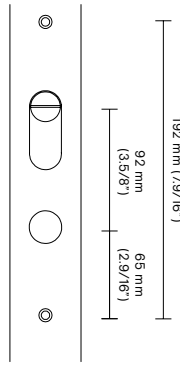

**Door configuration #3**  
American cylinder above handle  
3.5/8" (92mm) CTC

Accommodates: Hurd®, G-U®, BiltBest®, Andersen®

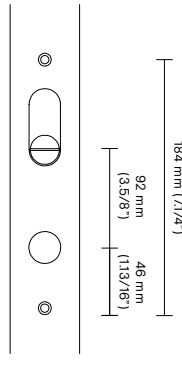

**Door configuration #4**  
American cylinder above handle  
3.5/8" (92mm) CTC

Accommodates: Weathershield®, PGT®, Marvin®, JELD-WEN®, G-U®, Caradco®, Ashland®

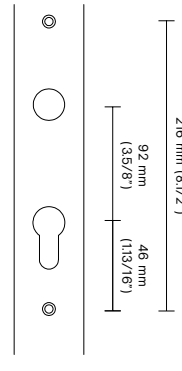

**Door configuration #5**  
European profile cylinder  
3.5/8" (92mm) CTC

Accommodates: Windsor®, Willmar®, Weathershield®, Vetter®, Therma-Tru®, Simpson®, Signature®, Sierra Pacific®, Semco®, Peachtree®, Paddock®, Loewen®, Lincoln®, Kolbe&Kolbe®, KFV®, Hurd®, Hoppe®, Crestline®

## Functions

### EAA - Entry American Above

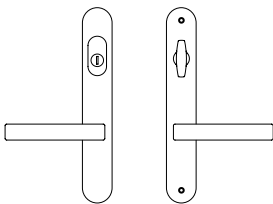

Oval trim

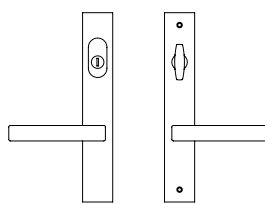

Rectangular trim

**EAA Entry set  
Key above**

Entry function with American cylinder above the lever, 3.5/8" (92mm) center to center.

### EAB - Entry American Below

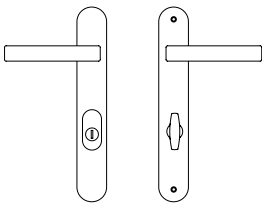

Oval trim

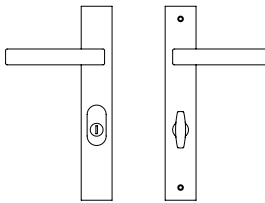

Rectangular trim

**EAB Entry set  
Key below**

Entry function with American Cylinder below the lever, 3.5/8" (92mm) center to center.

# Functions

## EE - Entry European

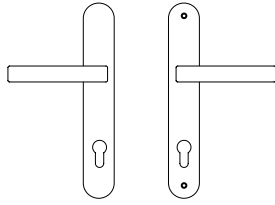

Oval trim

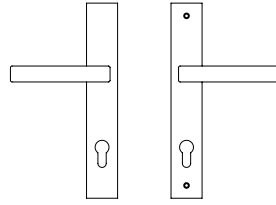

Rectangular trim

**EE Entry set**  
**With profile cylinder**  
 Entry function with European profile cylinder.  
 3.5/8" (92mm) center to center.

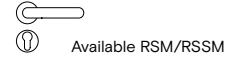

## PAA - Patio American Above

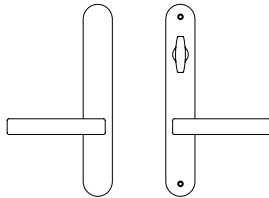

Oval trim

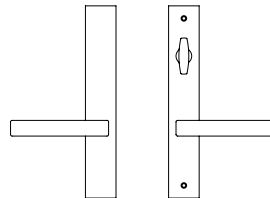

Rectangular trim

**PAA Patio set**  
**No keyway**  
 Patio function with the interior thumb turn above the lever, no keyway on the exterior plate.

## PAB - Patio American Below

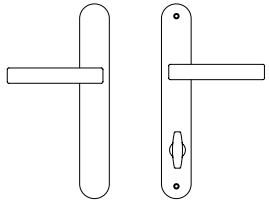

Oval trim

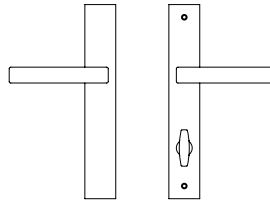

Rectangular trim

**PAB Patio set**  
**No keyway**  
 Patio function with the interior thumb turn below the lever, no keyway on the exterior plate.

## PE - Patio European

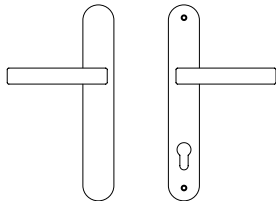

Oval trim

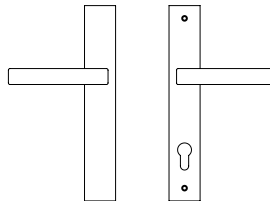

Rectangular trim

**PE Patio set**  
**Profile cylinder no key**  
 Patio function with European half profile cylinder and thumb turn, no keyway on the exterior plate.



## DA - Active Dummy Pair

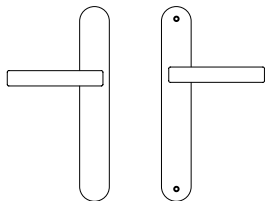

Oval trim

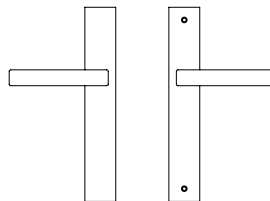

Rectangular trim

**DA Active dummy pair**

## DS - Single Dummy Piece

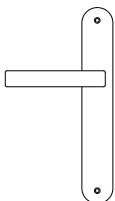

Oval trim

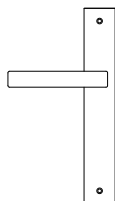

Rectangular trim

**DS Single dummy piece**

Conversions from metric to U.S. measurements are approximate.

## Group 1

H 198, H 1003, H 1022, H 1024, H 1050, H 4730, H 4742

Retail price

Option	NEP K 1789	NER K 1805	RSM
EAB Entry Set - Key below	\$ 620.00	\$ 734.00	--
PAB Patio Set - Key below	\$ 494.00	\$ 620.00	--
EAA Entry Set - Key above	\$ 620.00	\$ 734.00	--
PAA Patio Set - No keyway	\$ 494.00	\$ 620.00	--
EE Entry Set - With profile cyl.	\$ 935.00	\$ 1,037.00	\$ 910.00
PE Patio Set - Profile cyl. no key	\$ 570.00	\$ 683.00	\$ 469.00
CE Entry Set - Custom	call for details	call for details	--
DA Active Dummy	\$ 444.00	\$ 570.00	\$ 293.00

## Group 2

H 1016, H 1026, H 1044 U, H 1046, H 1049, H 1054, H 1056, H 1057, H 1062, H 1066

Retail price

Option	NEP K 1789	NER K 1805	RSM
EAB Entry Set - Key below	\$ 683.00	\$ 809.00	--
PAB Patio Set - Key below	\$ 570.00	\$ 683.00	--
EAA Entry Set - Key above	\$ 683.00	\$ 809.00	--
PAA Patio Set - No keyway	\$ 570.00	\$ 683.00	--
EE Entry Set - With profile cyl.	\$ 999.00	\$ 1,113.00	\$ 974.00
PE Patio Set - Profile cyl. no key	\$ 645.00	\$ 759.00	\$ 532.00
DA Active Dummy	\$ 520.00	\$ 645.00	\$ 369.00

## Group 3

H 1039, H 1040, H 1069, H 1748

Retail price

Option	NEP K 1789	NER K 1805	RSM
EAB Entry Set - Key below	\$ 899.00	\$ 1,024.00	--
PAB Patio Set - Key below	\$ 785.00	\$ 910.00	--
EAA Entry Set - Key above	\$ 899.00	\$ 1,024.00	--
PAA Patio Set - No keyway	\$ 785.00	\$ 910.00	--
EE Entry Set - With profile cyl.	\$ 1,226.00	\$ 1,328.00	\$ 1,199.00
PE Patio Set - Profile cyl. no key	\$ 859.00	\$ 974.00	\$ 759.00
DA Active Dummy	\$ 734.00	\$ 859.00	\$ 583.00

## Group 4

H 163, H 1043, H 1044, H 1058, H411, H 414, H 415, H 416, H 419

Retail price

Option	NEP K 1789	NER K 1805	RSM
EAB Entry Set - Key below	\$ 583.00	\$ 696.00	--
PAB Patio Set - Key below	\$ 455.00	\$ 583.00	--
EAA Entry Set - Key above	\$ 583.00	\$ 696.00	--
PAA Patio Set - No keyway	\$ 455.00	\$ 583.00	--
EE Entry Set - With profile cyl.	\$ 899.00	\$ 1,010.00	\$ 859.00
PE Patio Set - Profile cyl. no key	\$ 532.00	\$ 645.00	\$ 430.00
DA Active Dummy	\$ 405.00	\$ 532.00	\$ 254.00

Available standard finishes:  
**Brass levers:** Satin chrome and polished chrome  
**Stainless steel levers:** Satin stainless steel and polished stainless steel

NEP: Narrow long oval plate  
 NER: Narrow long rectangular plate  
 RSM: Small 45mm (1.3/4") rosette

Different finishes are available on special request.  
 See pages 12-13 for more options on finishes and page 17 for pricing.  
 The cylinders are included in the prices of all the corresponding configurations.

## Group 5

H 315, H 317, H 327, H 330, H 334, H 338, H 348, H 361, H 364, H 367, H 368, H 370, H 372, H 381, H 382, H 383, H 385, H 386

Retail price

Option	NEP K 1789	NER K 1805	RSM
EAB Entry Set - Key below	\$ 747.00	\$ 873.00	--
PAB Patio Set - Key below	\$ 633.00	\$ 759.00	--
EAA Entry Set - Key above	\$ 747.00	\$ 873.00	--
PAA Patio Set - No keyway	\$ 633.00	\$ 759.00	--
EE Entry Set - With profile cyl.	\$ 1,062.00	\$ 1,176.00	\$ 1,037.00
PE Patio Set - Profile cyl. no key	\$ 709.00	\$ 823.00	\$ 607.00
DA Active Dummy	\$ 330.00	\$ 709.00	\$ 430.00

## Group 6

H 311, H 329, H 335, H 343, H 359, H 376, H 378, H 384, H 5014

Retail price

Option	NEP/NES K 1789/K 5701	NER/NERS K 1805/K 5713	RSM/RSSM
EAB Entry Set - Key below	\$ 1,264.00	\$ 1,389.00	--
PAB Patio Set - Key below	\$ 1,151.00	\$ 1,277.00	--
EAA Entry Set - Key above	\$ 1,264.00	\$ 1,389.00	--
PAA Patio Set - No keyway	\$ 1,151.00	\$ 1,277.00	--
EE Entry Set - With profile cyl.	\$ 1,579.00	\$ 1,706.00	\$ 1,555.00
PE Patio Set - Profile cyl. no key	\$ 1,226.00	\$ 1,340.00	\$ 1,125.00
DA Active Dummy	\$ 848.00	\$ 1,226.00	\$ 949.00

## Group 7

H 5008

Retail price

Option	NEP/NES K 1789/K 5701	NER/NERS K 1805/K 5713	RSM/RSSM
EAB Entry Set - Key below	\$ 1,192.00	\$ 1,311.00	--
PAB Patio Set - Key below	\$ 1,085.00	\$ 1,205.00	--
EAA Entry Set - Key above	\$ 1,192.00	\$ 1,311.00	--
PAA Patio Set - No keyway	\$ 1,085.00	\$ 1,205.00	--
EE Entry Set - With profile cyl.	\$ 1,490.00	\$ 1,609.00	\$ 1,466.00
PE Patio Set - Profile cyl. no key	\$ 1,156.00	\$ 1,263.00	\$ 1,061.00
DA Active Dummy	\$ 800.00	\$ 1,156.00	\$ 895.00

## Group 8

H 356, H 379, H 380, H 5015/32D, H 5017

Retail price

Option	NEP/NES K 1789/K 5701	NER/NERS K 1805/K 5713	RSM/RSSM
EAB Entry Set - Key below	\$ 1,328.00	\$ 1,454.00	--
PAB Patio Set - Key below	\$ 1,213.00	\$ 1,340.00	--
EAA Entry Set - Key above	\$ 1,328.00	\$ 1,454.00	--
PAA Patio Set - No keyway	\$ 1,213.00	\$ 1,340.00	--
EE Entry Set - With profile cyl.	\$ 1,643.00	\$ 1,755.00	\$ 1,617.00
PE Patio Set - Profile cyl. no key	\$ 1,289.00	\$ 1,415.00	\$ 1,176.00
DA Active Dummy	\$ 910.00	\$ 1,289.00	\$ 1,010.00

Available standard finishes:

**Brass levers:** Satin chrome and polished chrome

**Stainless steel levers:** Satin stainless steel and polished stainless steel

Different finishes are available on special request.

See pages 12-13 for more options on finishes and page 17 for pricing.

The cylinders are included in the prices of all the corresponding configurations.

NEP: Narrow long oval plate  
NER: Narrow long rectangular plate  
RSM: Small 45mm (1.3/4") rosette

NES: Long oval plate stainless steel material  
NERS: Long rectangular plate stainless steel material  
RSSM: Round rosette 50mm (2") Stainless steel material

## Group 9

H 5015 Black leather, H 5015 Orange leather

Retail price

Option	NES K 5701	NERS K 5713	RSSM
EAB Entry Set - Key below	\$ 1,819.00	\$ 1,920.00	--
PAB Patio Set - Key below	\$ 1,681.00	\$ 1,744.00	--
EAA Entry Set - Key above	\$ 1,819.00	\$ 1,920.00	--
PAA Patio Set - No keyway	\$ 1,681.00	\$ 1,744.00	--
EE Entry Set - With profile cyl.	\$ 2,085.00	\$ 2,135.00	\$ 1,844.00
PE Patio Set - Profile cyl. no key	\$ 1,731.00	\$ 1,744.00	\$ 1,457.00
DA Active Dummy	\$ 1,579.00	\$ 1,643.00	\$ 1,289.00

Available standard finishes:  
**Brass levers:** Satin chrome and polished chrome  
**Stainless steel levers:** Satin stainless steel and polished stainless steel

NES: Long oval plate stainless steel material  
 NERS: Long rectangular plate stainless steel material  
 RSSM: Round rosette 50mm (2") stainless steel material

Different finishes are available on special request.  
 See pages 12-13 for more options on finishes and page 17 for pricing.  
 The cylinders are included in the prices of all the corresponding configurations.



## How to specify







In order to select the right configuration you should identify the following:

<b>1</b>	<b>Lever model</b>	Chose from all our collection of levers, ex H 1066
<b>2</b>	<b>Trim options</b>	Chose among the options ar page 169.
<b>3</b>	<b>Function</b>	See page 171 to determine
<b>4</b>	<b>Handing</b>	Follow the diagram at page 22 to determine RH, LH, RHR, or LHR
<b>5</b>	<b>Finish</b>	See page 12-13 to determine
<b>6</b>	<b>Door thickness</b>	1.3/4" is considered standard. Accomodates up to 2.1/4" thick door. Upcharges apply. See page 17.
<b>7</b>	<b>Miscellaneous</b>	Note any special keying information or special instruction

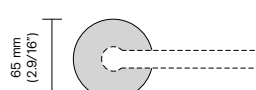
Example	1	2	3	4	5	6	7
	H 1054	RP	ML-FD	RH	26	1.3/4"	--

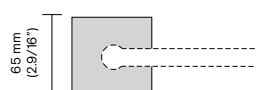
## Trim options

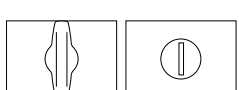
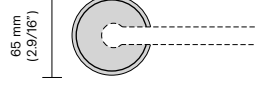
### Configuration for Pre - drilled doors (2.1/8" BORE)

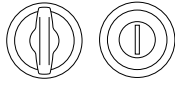
Rosettes	Key cylinder	Thumb turn
 <p><b>Round 65 mm (2.9/16")</b>  <b>RP</b> Round rosette                      Brass  <b>RPS</b> Round rosette                      Stainless steel</p>	<p>45 mm (1.3/4")</p> 	<p>45 mm (1.3/4")    45 mm (1.3/4")</p> 
 <p><b>Square 65mm (2.9/16")</b>  <b>RQ</b> Square rosette                      Brass  <b>RQS</b> Square rosette                      Stainless steel</p>	<p>45 mm (1.3/4")</p> 	<p>65 mm (2.9/16")    65 mm (2.9/16")</p> 
 <p><b>Traditional 65 mm (2.9/16")</b>  <b>RT</b> Traditional rosette                      Brass (Only available in brass material)</p>	<p>45 mm (1.3/4")</p> 	<p>45 mm (1.3/4")    45 mm (1.3/4")</p> 

# Trim options

## Configuration for Non pre – drilled doors

### Rosettes

### Key cylinder

### Thumb turn

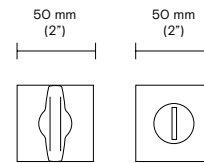
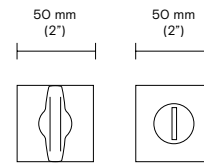
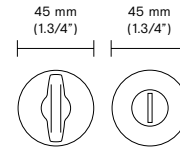
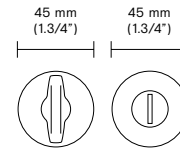

### Escutcheons plates

#### Brass levers

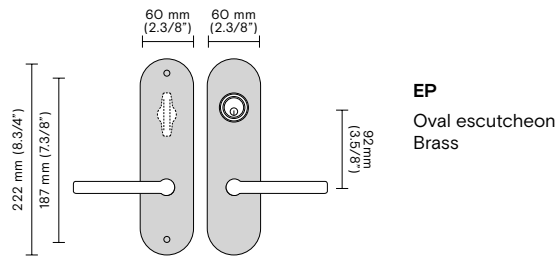

#### Stainless steel levers

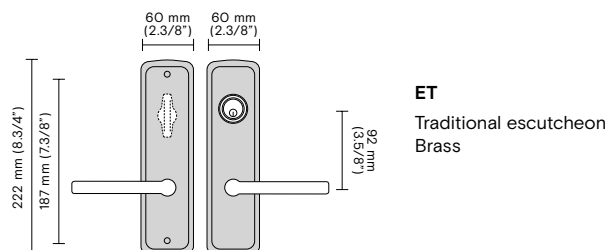
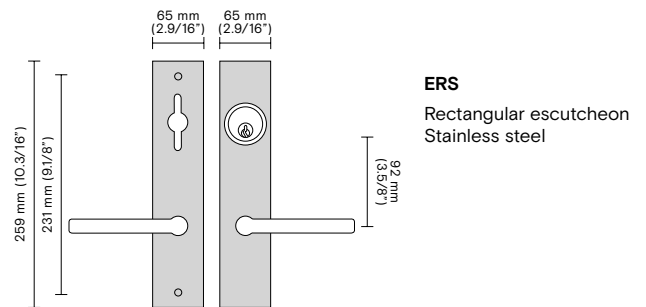
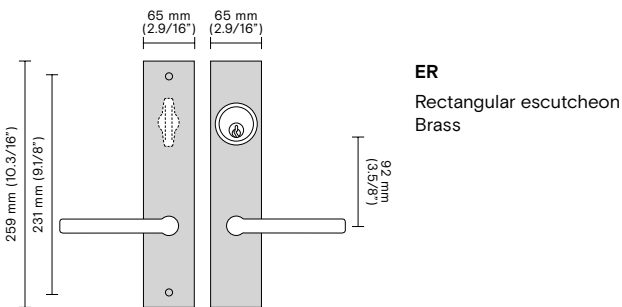
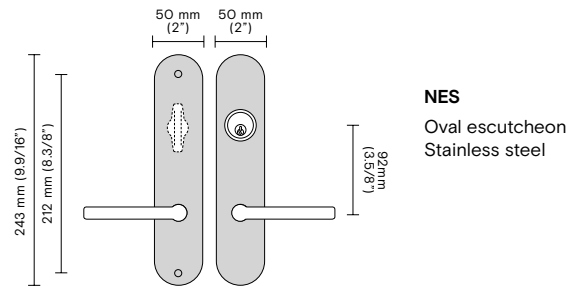

## Mortise locks

Each lever and knob design in this catalog is available for mortise lock application. Valli provides mortise locks of different backsets and functions.

### Standard backset lock

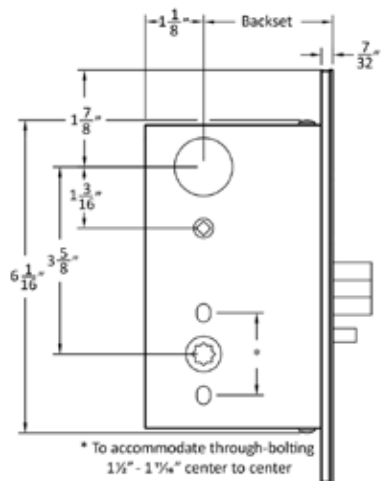

Lock body  
(shown ML-F function)

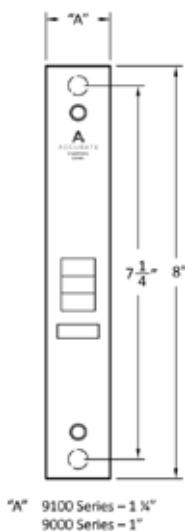

Lock front  
(shown ML-F function)

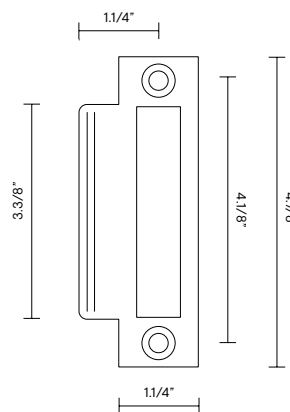

Universal strike plate

### Narrow backset lock

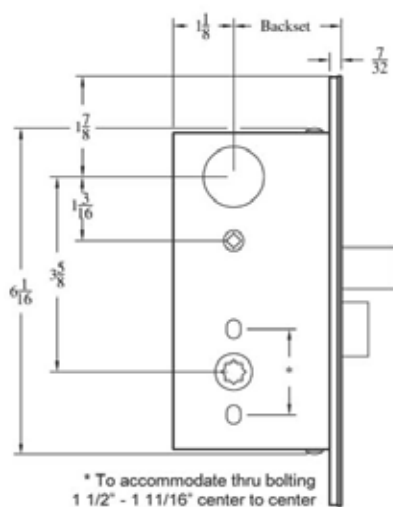

STANDARD BACKSETS: 2 3/4" - 2 1/2"

SPECIAL BACKSETS ON REQUEST:  
1 1/4" - 1 1/2" - 1 3/4" - 2" - 2 1/4" - 3" - 5"

Different customized backsets may be produced upon special request and after technical approval.

Upcharges apply to different backset requests.  
See page 17 for details.

Magnetic mortise locks also available on request.  
See page 17 for pricing.

## Mortise lock functions

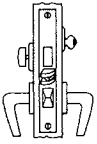

### ML-F ENTRANCE

Latch bolt by key outside and lever either side unless outside lever is locked by toggle-action stop. Dead bolt by key outside and turnpiece inside. Turning inside lever retracts latch and dead bolt simultaneously. Outside lever remains locked.

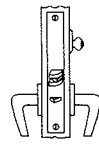

### ML-ELECT ELECTRIFIED

Must specify: EU = Fail secure or EL = Fail safe  
Voltage: 24 VDC or 12 VDC  
Latch by lever inside and key outside.  
Outside lever is always rigid.  
Auxiliary latch deadlocks latch bolt.

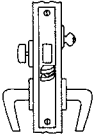

### ML-FW DORMITORY

Latch bolt by lever either side.  
Dead bolt by key outside and turnpiece inside. A turn of inside lever retracts latch and dead bolt simultaneously—automatically unlocking outside lever. No Toggle.

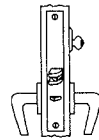

### ML-J CLASSROOM

Latch bolt by key outside and lever either side unless outside lever is locked by key outside. Auxiliary latch deadlocks latch bolt.

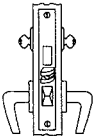

### ML-AC ENTRANCE

Latch bolt by lever either side unless outside lever is locked by toggle action stop.  
Dead bolt by key either side.

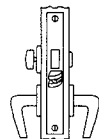

### ML-LF PRIVACY

Latch bolt by lever either side.  
Dead bolt by turnpiece inside and coin key outside. A turn of inside lever retracts latch and dead bolt simultaneously—automatically unlocking outside lever.

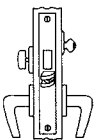

### ML-B ENTRANCE

Latch bolt by lever either side.  
Dead bolt by key outside and thumb turn inside. No Toggle. No emergency egress.

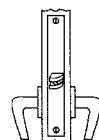

### ML-N PASSAGE

Latch bolt by lever either side.

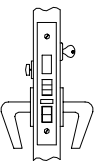

### ML-FD ENTRANCE / APARTMENT LOCK

Latch bolt by key outside and lever either side. Unless outside lever is locked by toggle-action stop. Dead bolt by key outside and turnpiece inside. Turning inside lever retracts latch and dead bolt simultaneously. Outside lever remains locked. Auxiliary latch deadlocks latch bolt and prevents manipulation of locked toggle action stop.

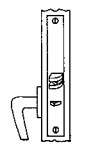

### ML-NC COMMUNICATING

Latch bolt by lever one side.

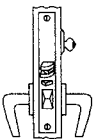

### ML-E OFFICE

Latch bolt by key outside and lever either side unless outside lever is locked by toggle-action stop. Auxiliary latch deadlocks latch bolt.

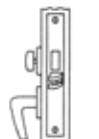

### ML-LFC COMMUNICATING

Latch bolt by lever inside only.  
Dead bolt by turnpiece inside only.  
A turn of inside lever retracts latch and dead bolt simultaneously—automatically unlocking door.

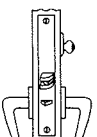

### ML-EW STOREROOM

Latch by lever inside and key outside.  
Outside lever is always rigid.  
Auxiliary latch deadlocks latch bolt.

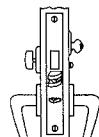

### ML-H HOTEL

Latch bolt by lever inside and guest or master key outside. Outside lever always rigid.  
Dead bolt by turnpiece inside and key outside. A turn of inside lever retracts latch and dead bolt simultaneously. Auxiliary latch deadlocks latch bolt.

The narrow backset mortise locks are available only in the following functions:

ML-FW Entrance  
ML-F Entrance  
ML-N Passage  
ML-LF Privacy

ML-J Classroom  
ML-E Office  
ML-EW Storeroom

Rosette options for mortise application

1. Keyed functions

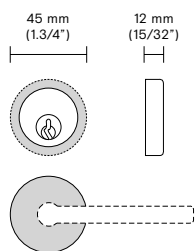

**RP** Round rosette with cylinder collar

**RPS** Round rosette Stainless steel with cylinder collar

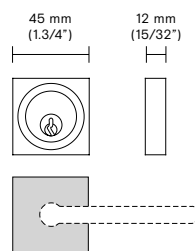

**RQ** Square rosette with cylinder collar

**RQS** Square rosette Stainless steel with cylinder collar

2. Privacy function with thumb turn/emergency release (Brass material)

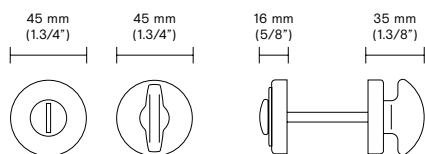

**RP** Round rosette 45 mm (1.3/4")  
Thumb turn (Interior and emergency release)

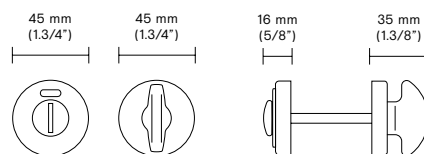

Interior and emergency release with indicator

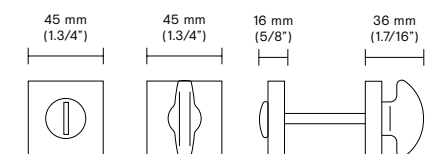

**RQ** Square rosette 45 mm (1.3/4")  
Thumb turn (Interior and emergency release)

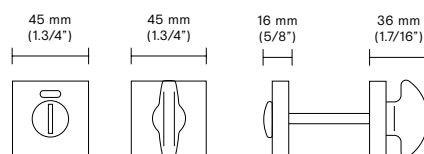

Interior and emergency release with indicator

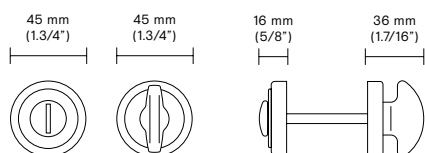

**RT** Traditional rosette 45 mm (1.3/4")  
Thumb turn (Interior and emergency release)

Conversions from metric to U.S. measurements are approximate.

The configurations above are considered standard with the exclusion of the emergency release with indicator, only available on special request.

ADA compliant thumb turn is available on special request. For its design check page 155. Call for pricing.

Other thumb turns are available as optional. Check page 155 for details.

## Rosette options for mortise application

### 3. Privacy function with thumb turn/emergency release (Stainless steel material)

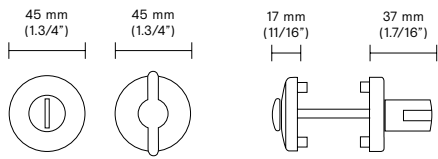

**RPS Round rosette** Stainless steel  
45 mm (1.3/4")  
Thumb turn (Interior and emergency release)

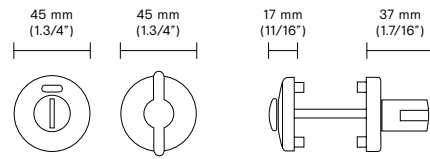

Interior and emergency release  
with indicator

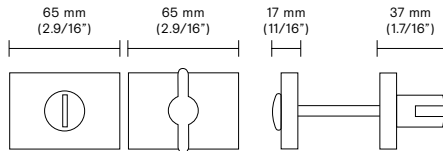

**RQS Square rosette** Stainless steel  
mm 65 (2.9/16")  
Thumb turn (Interior and emergency release)

### Cylinder finish options

The cylinders are supplied in the finishes below, unless differently requested at the time of the order:

Trim finish O3 = Cylinder finish O3 / POLISHED BRASS

Trim finishes O3D, O3M = Cylinder in O3D / SATIN BRASS

Trim finish O6 = Cylinder in O6 / ANTIQUE BRASS

Trim finishes O6A, O6B, O6M, 10S, 56 = Cylinders in 10B / OIL RUBBED BRONZE

Trim finish 14, 17A, 26, 32 = Cylinder in 26 / POLISHED CHROME

Trim finish 15, 32D = Cylinder in 15 / SATIN NICKEL

Trim finish 16 = Cylinder in 16 / DULL BLACK

Trim finish 22M = Cylinder in 22M / MATT WHITE

Trim finish 26D = Cylinder in 26D / SATIN CHROME

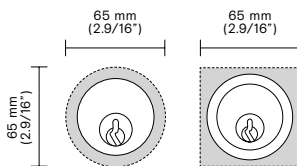

The configurations above are considered standard with the exclusion of the emergency release with indicator, available on special request.  
ADA compliant thumb turn is available on special request. For its design check page 155. Call for pricing.

## Group 1 Mortise locks

Door levers \_\_\_\_\_ H 198, H 1003, H 1022, H 1024, H 1050, H 4730, H 4742

Door knobs \_\_\_\_\_ K 1155, K 1168, K 1170

### Retail price

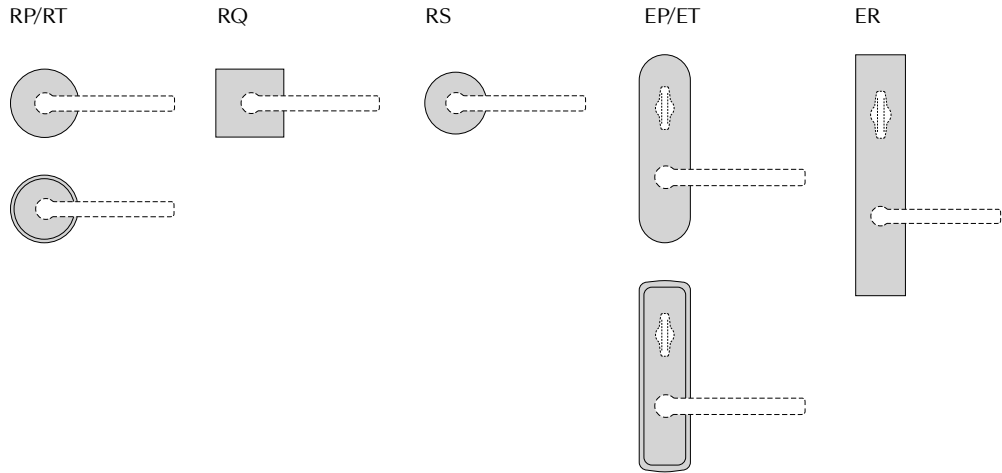

<b>ML F/Entrance</b>	\$ 961.00	\$ 1,100.00	\$ 848.00	\$ 899.00	\$ 935.00
<b>ML FD/Entrance</b>	\$ 1,010.00	\$ 1,163.00	\$ 910.00	\$ 949.00	\$ 999.00
<b>ML FW/Entrance</b>	\$ 935.00	\$ 1,087.00	\$ 809.00	\$ 873.00	\$ 910.00
<b>ML B/Entrance</b>	\$ 935.00	\$ 1,087.00	\$ 823.00	\$ 848.00	\$ 910.00
<b>ML AC/Entrance</b>	\$ 935.00	\$ 1,049.00	\$ 809.00	\$ 910.00	\$ 949.00
<b>ML E/Office</b>	\$ 899.00	\$ 985.00	\$ 823.00	\$ 899.00	\$ 949.00
<b>ML EW/Storeroom</b>	\$ 859.00	\$ 935.00	\$ 747.00	\$ 859.00	\$ 910.00
<b>ML J/Classroom</b>	\$ 899.00	\$ 985.00	\$ 823.00	\$ 899.00	\$ 949.00
<b>ML N/Passage</b>	\$ 734.00	\$ 773.00	\$ 607.00	\$ 759.00	\$ 798.00
<b>ML LF/Privacy</b>	\$ 961.00	\$ 1,113.00	\$ 848.00	\$ 848.00	\$ 885.00
<b>ML H/Hotel</b>	\$ 961.00	\$ 1,100.00	\$ 848.00	\$ 834.00	\$ 924.00
<b>ML NC/Communicating</b>	\$ 545.00	\$ 545.00	\$ 558.00	\$ 620.00	\$ 633.00
<b>ML ELEC/Electrified</b>	\$ 2,210.00	\$ 2,274.00	\$ 2,085.00	\$ 2,185.00	\$ 2,236.00

Conversions from metric to U.S. measurements are approximate.

The prices above refer to locks of 2.3/4" and 2.1/2" backset. Upcharges apply for different backsets. See page 17.

If requested without mortise lock, deduct \$120 retail price. For ML-ELECT without mortise lock, deduct \$120 from ML-EW retail price.

If requested without cylinder, deduct \$15 retail price.

Same prices for all the standard finishes as indicated per each lever page. Special finishes are available upon request. See pages 12-13 for finish selection. Upcharges apply.

Upside Down and Magnetic Locks are available upon request. Upcharges at page 17.

For the electrified mortise locks, the AE switch (Request to Exit) must be requested at the time of the order. Upcharges apply.

## Group 2 Mortise locks

### Door levers

H 165, H 176, H 1016, H 1018, H 1026, H 1027, H 1044 U, H 1045, H 1046, H 1049, H 1052, H 1054, H 1055, H 1056, H 1057, H 1061, H 1062, H 1066

### Retail price

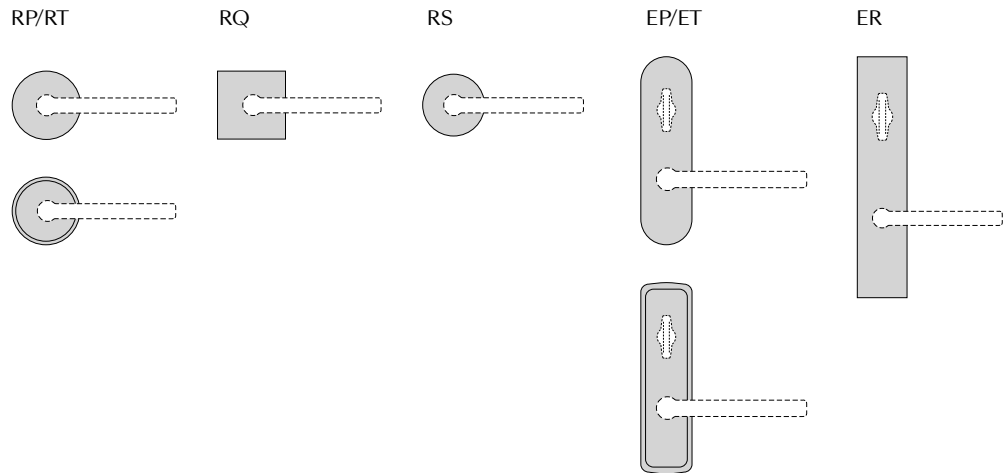

	RP/RT	RQ	RS	EP/ET	ER
ML F/Entrance	\$ 1,037.00	\$ 1,176.00	\$ 924.00	\$ 974.00	\$ 1,010.00
ML FD/Entrance	\$ 1,087.00	\$ 1,226.00	\$ 974.00	\$ 1,024.00	\$ 1,062.00
ML FW/Entrance	\$ 1,010.00	\$ 1,163.00	\$ 885.00	\$ 949.00	\$ 985.00
ML B/Entrance	\$ 999.00	\$ 1,163.00	\$ 899.00	\$ 924.00	\$ 985.00
ML AC/Entrance	\$ 1,010.00	\$ 1,125.00	\$ 899.00	\$ 985.00	\$ 1,024.00
ML E/Office	\$ 974.00	\$ 1,062.00	\$ 859.00	\$ 974.00	\$ 1,037.00
ML EW/Storeroom	\$ 935.00	\$ 1,010.00	\$ 823.00	\$ 935.00	\$ 985.00
ML J/Classroom	\$ 974.00	\$ 1,062.00	\$ 859.00	\$ 974.00	\$ 1,037.00
ML N/Passage	\$ 809.00	\$ 848.00	\$ 683.00	\$ 834.00	\$ 873.00
ML LF/Privacy	\$ 1,037.00	\$ 1,188.00	\$ 924.00	\$ 924.00	\$ 961.00
ML H/Hotel	\$ 1,037.00	\$ 1,176.00	\$ 924.00	\$ 910.00	\$ 999.00
ML NC/Communicating	\$ 570.00	\$ 583.00	\$ 583.00	\$ 658.00	\$ 671.00
ML ELEC/Electrified	\$ 2,274.00	\$ 2,374.00	\$ 2,160.00	\$ 2,261.00	\$ 2,313.00

Conversions from metric to U.S. measurements are approximate.

The prices above refer to locks of 2.3/4" and 2.1/2" backset. Upcharges apply for different backsets. See page 17.

If requested without mortise lock, deduct \$120 retail price. For ML-ELECT without mortise lock, deduct \$120 from ML-EW retail price.

If requested without cylinder, deduct \$15 retail price.

Same prices for all the standard finishes as indicated per each lever page. Special finishes are available upon request. See pages 12-13 for finish selection. Upcharges apply.

Upside Down and Magnetic Locks are available upon request. Upcharges at page 17.

For the electrified mortise locks, the AE switch (Request to Exit) must be requested at the time of the order. Upcharges apply.

## Group 3 Mortise locks

Door levers \_\_\_\_\_ H 1039, H 1040, H 1060, H 1068, H 1069, H 1748

Door knobs \_\_\_\_\_ K 1054, K 1056, K 1060, K 1061, K 1171, K 1730

### Retail price

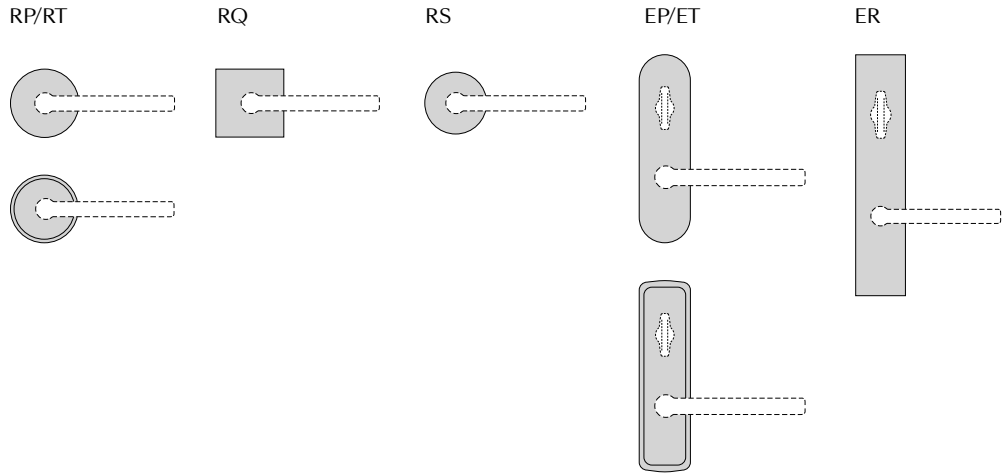

<b>ML F/Entrance</b>	\$ 1,251.00	\$ 1,389.00	\$ 1,138.00	\$ 1,200.00	\$ 1,226.00
<b>ML FD/Entrance</b>	\$ 1,314.00	\$ 1,454.00	\$ 1,188.00	\$ 1,251.00	\$ 1,289.00
<b>ML FW/Entrance</b>	\$ 1,226.00	\$ 1,379.00	\$ 1,087.00	\$ 1,163.00	\$ 1,200.00
<b>ML B/Entrance</b>	\$ 1,226.00	\$ 1,389.00	\$ 1,100.00	\$ 1,151.00	\$ 1,200.00
<b>ML AC/Entrance</b>	\$ 1,251.00	\$ 1,328.00	\$ 1,100.00	\$ 1,200.00	\$ 1,238.00
<b>ML E/Office</b>	\$ 1,188.00	\$ 1,289.00	\$ 1,075.00	\$ 1,200.00	\$ 1,251.00
<b>ML EW/Storeroom</b>	\$ 1,151.00	\$ 1,226.00	\$ 1,037.00	\$ 1,151.00	\$ 1,200.00
<b>ML J/Classroom</b>	\$ 1,188.00	\$ 1,289.00	\$ 1,075.00	\$ 1,200.00	\$ 1,251.00
<b>ML N/Passage</b>	\$ 1,024.00	\$ 1,049.00	\$ 899.00	\$ 1,049.00	\$ 1,087.00
<b>ML LF/Privacy</b>	\$ 1,251.00	\$ 1,415.00	\$ 1,138.00	\$ 1,138.00	\$ 1,188.00
<b>ML H/Hotel</b>	\$ 1,251.00	\$ 1,389.00	\$ 1,138.00	\$ 1,113.00	\$ 1,226.00
<b>ML NC/Communicating</b>	\$ 683.00	\$ 696.00	\$ 696.00	\$ 759.00	\$ 785.00
<b>ML ELEC/Electrified</b>	\$ 2,464.00	\$ 2,551.00	\$ 2,362.00	\$ 2,500.00	\$ 2,526.00

Conversions from metric to U.S. measurements are approximate.

The prices above refer to locks of 2.3/4" and 2.1/2" backset. Upcharges apply for different backsets. See page 17.

If requested without mortise lock, deduct \$120 retail price. For ML-ELECT without mortise lock, deduct \$120 from ML-EW retail price.

If requested without cylinder, deduct \$15 retail price.

Same prices for all the standard finishes as indicated per each lever page. Special finishes are available upon request. See pages 12-13 for finish selection. Upcharges apply.

Upside Down and Magnetic Locks are available upon request. Upcharges at page 17.

For the electrified mortise locks, the AE switch (Request to Exit) must be requested at the time of the order. Upcharges apply.

# Group 4 Mortise locks

## Door levers

H 163, H 192, H 1004, H 1037, H 1043, H 1044, H 1058, H 411, H 414, H 415, H 416, H 419

## Retail price

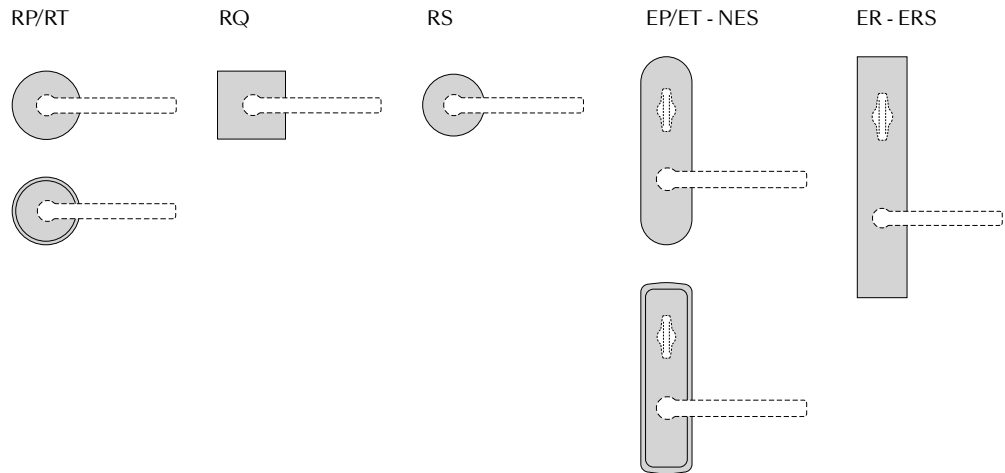

	RP/RT	RQ	RS	EP/ET - NES	ER - ERS
<b>ML F/Entrance</b>	\$ 924.00	\$ 1,062.00	\$ 809.00	\$ 859.00	\$ 899.00
<b>ML FD/Entrance</b>	\$ 974.00	\$ 1,125.00	\$ 859.00	\$ 910.00	\$ 949.00
<b>ML FW/Entrance</b>	\$ 899.00	\$ 1,037.00	\$ 773.00	\$ 834.00	\$ 873.00
<b>ML B/Entrance</b>	\$ 899.00	\$ 1,049.00	\$ 785.00	\$ 809.00	\$ 873.00
<b>ML AC/Entrance</b>	\$ 899.00	\$ 1,010.00	\$ 773.00	\$ 873.00	\$ 910.00
<b>ML E/Office</b>	\$ 859.00	\$ 949.00	\$ 747.00	\$ 873.00	\$ 910.00
<b>ML EW/Storeroom</b>	\$ 823.00	\$ 910.00	\$ 709.00	\$ 823.00	\$ 873.00
<b>ML J/Classroom</b>	\$ 859.00	\$ 949.00	\$ 747.00	\$ 873.00	\$ 910.00
<b>ML N/Passage</b>	\$ 734.00	\$ 734.00	\$ 721.00	\$ 759.00	\$ 924.00
<b>ML LF/Privacy</b>	\$ 924.00	\$ 1,075.00	\$ 809.00	\$ 809.00	\$ 859.00
<b>ML H/Hotel</b>	\$ 924.00	\$ 1,062.00	\$ 809.00	\$ 798.00	\$ 885.00
<b>ML NC/Communicating</b>	\$ 520.00	\$ 532.00	\$ 532.00	\$ 596.00	\$ 620.00
<b>ML ELEC/Electrified</b>	\$ 2,148.00	\$ 2,248.00	\$ 2,047.00	\$ 2,158.00	\$ 2,210.00

Conversions from metric to U.S. measurements are approximate.

The prices above refer to locks of 2.3/4" and 2.1/2" backset. Upcharges apply for different backsets. See page 17.

If requested without mortise lock, deduct \$120 retail price. For ML-ELECT without mortise lock, deduct \$120 from ML-EW retail price.

If requested without cylinder, deduct \$15 retail price.

Same prices for all the standard finishes as indicated per each lever page. Special finishes are available upon request. See pages 12-13 for finish selection. Upcharges apply.

Upside Down and Magnetic Locks are available upon request. Upcharges at page 17.

For the electrified mortise locks, the AE switch (Request to Exit) must be requested at the time of the order. Upcharges apply.

## Group 5 Mortise locks

Door levers \_\_\_\_\_ H 315, H 317, H 327, H 330, H 334, H 338, H 348, H 361, H 364, H 367, H 368, H 370, H 372, H 381, H 382, H 383, H 385, H 386

Door knobs \_\_\_\_\_ K 383

### Retail price

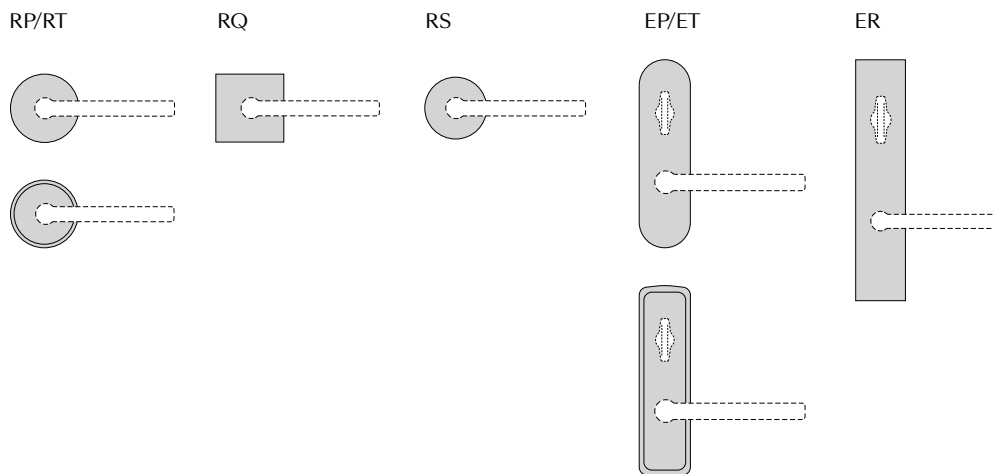

<b>ML F/Entrance</b>	\$ 1,100.00	\$ 1,238.00	\$ 985.00	\$ 1,037.00	\$ 1,075.00
<b>ML FD/Entrance</b>	\$ 1,151.00	\$ 1,289.00	\$ 1,037.00	\$ 1,087.00	\$ 1,125.00
<b>ML FW/Entrance</b>	\$ 1,075.00	\$ 1,213.00	\$ 935.00	\$ 999.00	\$ 1,049.00
<b>ML B/Entrance</b>	\$ 1,075.00	\$ 1,213.00	\$ 949.00	\$ 999.00	\$ 1,049.00
<b>ML AC/Entrance</b>	\$ 1,075.00	\$ 1,188.00	\$ 961.00	\$ 1,049.00	\$ 1,087.00
<b>ML E/Office</b>	\$ 1,037.00	\$ 1,125.00	\$ 924.00	\$ 1,037.00	\$ 1,049.00
<b>ML EW/Storeroom</b>	\$ 999.00	\$ 1,075.00	\$ 873.00	\$ 999.00	\$ 1,006.00
<b>ML J/Classroom</b>	\$ 1,037.00	\$ 1,125.00	\$ 924.00	\$ 1,037.00	\$ 1,049.00
<b>ML N/Passage</b>	\$ 873.00	\$ 910.00	\$ 747.00	\$ 899.00	\$ 935.00
<b>ML LF/Privacy</b>	\$ 1,100.00	\$ 1,251.00	\$ 985.00	\$ 985.00	\$ 1,037.00
<b>ML H/Hotel</b>	-	-	-	\$ 974.00	\$ 1,075.00
<b>ML NC/Communicating</b>	\$ 607.00	\$ 620.00	\$ 620.00	\$ 696.00	\$ 721.00
<b>ML ELEC/Electrified</b>	\$ 2,324.00	\$ 2,425.00	\$ 2,210.00	\$ 2,324.00	\$ 2,374.00

Conversions from metric to U.S. measurements are approximate.

The prices above refer to locks of 2.3/4" and 2.1/2" backset. Upcharges apply for different backsets. See page 17.

If requested without mortise lock, deduct \$120 retail price. For ML-ELECT without mortise lock, deduct \$120 from ML-EW retail price.

If requested without cylinder, deduct \$15 retail price.

Same prices for all the standard finishes as indicated per each lever page. Special finishes are available upon request. See pages 12-13 for finish selection. Upcharges apply.

Upside Down and Magnetic Locks are available upon request. Upcharges at page 17.

For the electrified mortise locks, the AE switch (Request to Exit) must be requested at the time of the order. Upcharges apply.

# Group 6 Mortise locks

**Door levers**

H 311, H 329, H 335, H 343, H 359, H 376, H 378, H 384, H 5014

**Door knob**

K 378

**Retail price**

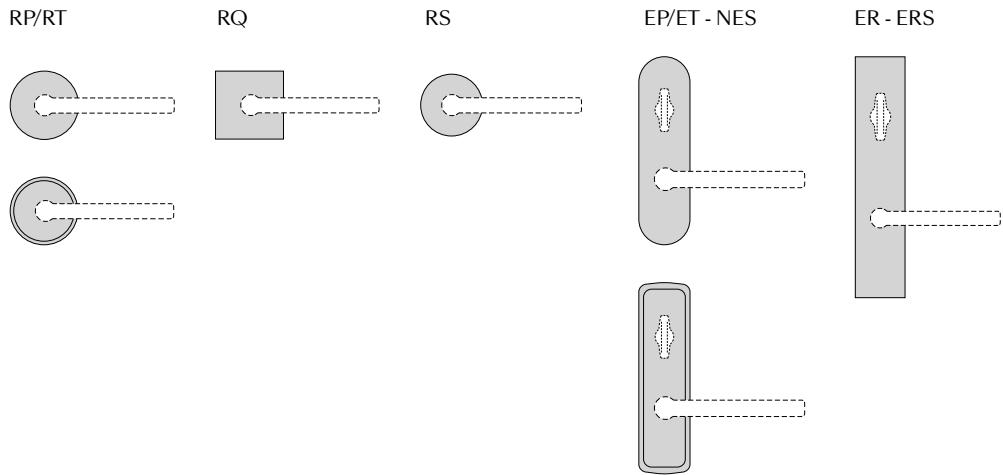

<b>ML F/Entrance</b>	\$ 1,213.00	\$ 1,389.00	\$ 1,125.00	\$ 1,163.00	\$ 1,200.00
<b>ML FD/Entrance</b>	\$ 1,289.00	\$ 1,428.00	\$ 1,176.00	\$ 1,226.00	\$ 1,264.00
<b>ML FW/Entrance</b>	\$ 1,200.00	\$ 1,353.00	\$ 1,075.00	\$ 1,138.00	\$ 1,188.00
<b>ML B/Entrance</b>	\$ 1,213.00	\$ 1,353.00	\$ 1,087.00	\$ 1,125.00	\$ 1,176.00
<b>ML AC/Entrance</b>	\$ 1,200.00	\$ 1,314.00	\$ 1,084.00	\$ 1,188.00	\$ 1,226.00
<b>ML E/Office</b>	\$ 1,176.00	\$ 1,251.00	\$ 1,062.00	\$ 1,176.00	\$ 1,226.00
<b>ML EW/Storeroom</b>	\$ 1,138.00	\$ 1,213.00	\$ 1,010.00	\$ 1,125.00	\$ 1,176.00
<b>ML J/Classroom</b>	\$ 1,176.00	\$ 1,251.00	\$ 1,062.00	\$ 1,176.00	\$ 1,226.00
<b>ML N/Passage</b>	\$ 1,010.00	\$ 1,037.00	\$ 885.00	\$ 1,037.00	\$ 1,075.00
<b>ML LF/Privacy</b>	\$ 1,226.00	\$ 1,389.00	\$ 1,113.00	\$ 1,113.00	\$ 1,163.00
<b>ML H/Hotel</b>	-	-	-	\$ 1,100.00	\$ 1,188.00
<b>ML NC/Communicating</b>	\$ 671.00	\$ 683.00	\$ 683.00	\$ 759.00	\$ 773.00
<b>ML ELEC/Electrified</b>	\$ 2,464.00	\$ 2,576.00	\$ 2,338.00	\$ 2,450.00	\$ 2,500.00

Conversions from metric to U.S. measurements are approximate.

The prices above refer to locks of 2.3/4" and 2.1/2" backset. Upcharges apply for different backsets. See page 17.

If requested without mortise lock, deduct \$120 retail price. For ML-ELECT without mortise lock, deduct \$120 from ML-EW retail price.

If requested without cylinder, deduct \$15 retail price.

Same prices for all the standard finishes as indicated per each lever page. Special finishes are available upon request. See pages 12-13 for finish selection. Upcharges apply.

Upside Down and Magnetic Locks are available upon request. Upcharges at page 17.

For the electrified mortise locks, the AE switch (Request to Exit) must be requested at the time of the order. Upcharges apply.

## Group 7 Mortise locks

Door levers \_\_\_\_\_ H 377, H 5008

Door knob \_\_\_\_\_ K 377, K 5301

### Retail price

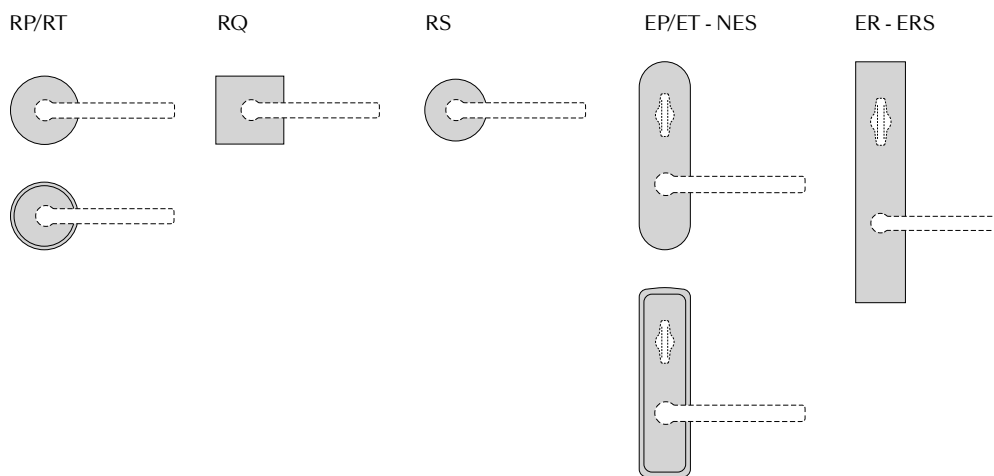

	RP/RT	RQ	RS	EP/ET - NES	ER - ERS
<b>ML F/Entrance</b>	\$ 1,617.00	\$ 1,755.00	\$ 1,504.00	\$ 1,555.00	\$ 1,592.00
<b>ML FD/Entrance</b>	\$ 1,668.00	\$ 1,807.00	\$ 1,555.00	\$ 1,605.00	\$ 1,643.00
<b>ML FW/Entrance</b>	\$ 1,579.00	\$ 1,755.00	\$ 1,454.00	\$ 1,516.00	\$ 1,568.00
<b>ML B/Entrance</b>	\$ 1,579.00	\$ 1,744.00	\$ 1,465.00	\$ 1,504.00	\$ 1,568.00
<b>ML AC/Entrance</b>	\$ 1,592.00	\$ 1,693.00	\$ 1,465.00	\$ 1,568.00	\$ 1,605.00
<b>ML E/Office</b>	\$ 1,568.00	\$ 1,643.00	\$ 1,440.00	\$ 1,555.00	\$ 1,605.00
<b>ML EW/Storeroom</b>	\$ 1,516.00	\$ 1,592.00	\$ 1,389.00	\$ 1,516.00	\$ 1,568.00
<b>ML J/Classroom</b>	\$ 1,568.00	\$ 1,643.00	\$ 1,440.00	\$ 1,555.00	\$ 1,605.00
<b>ML N/Passage</b>	\$ 1,403.00	\$ 1,428.00	\$ 1,264.00	\$ 1,415.00	\$ 1,465.00
<b>ML LF/Privacy</b>	\$ 1,617.00	\$ 1,668.00	\$ 1,504.00	\$ 1,504.00	\$ 1,555.00
<b>ML H/Hotel</b>	-	-	-	\$ 1,491.00	\$ 1,579.00
<b>ML NC/Communicating</b>	\$ 859.00	\$ 873.00	\$ 873.00	\$ 949.00	\$ 961.00
<b>ML ELEC/Electrified</b>	\$ 2,843.00	\$ 2,918.00	\$ 2,727.00	\$ 2,842.00	\$ 2,905.00

Conversions from metric to U.S. measurements are approximate.

The prices above refer to locks of 2.3/4" and 2.1/2" backset. Upcharges apply for different backsets. See page 17.

If requested without mortise lock, deduct \$120 retail price. For ML-ELECT without mortise lock, deduct \$120 from ML-EW retail price.

If requested without cylinder, deduct \$15 retail price.

Same prices for all the standard finishes as indicated per each lever page. Special finishes are available upon request. See pages 12-13 for finish selection. Upcharges apply.

Upside Down and Magnetic Locks are available upon request. Upcharges at page 17.

For the electrified mortise locks, the AE switch (Request to Exit) must be requested at the time of the order. Upcharges apply.

# Group 8 Mortise locks

## Door levers

H 356, H 379, H 380, H 5015/32D, H 5017

## Retail price

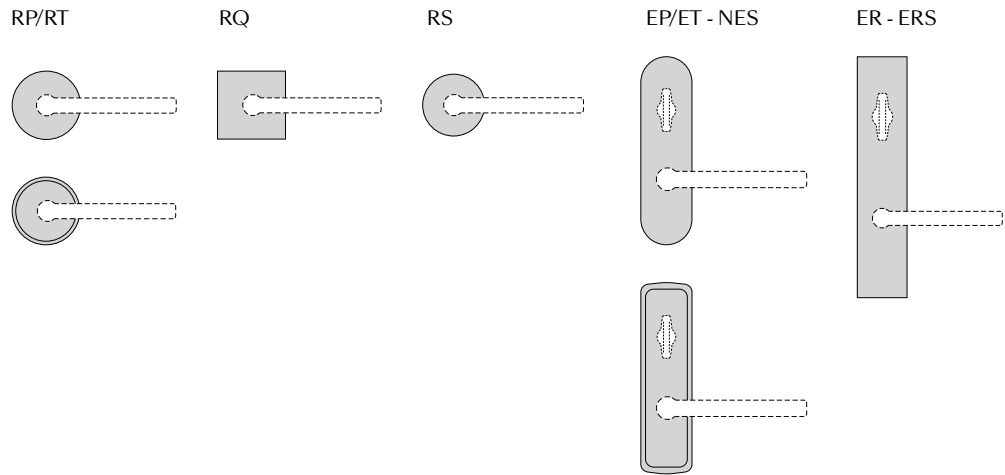

	RP/RT	RQ	RS	EP/ET - NES	ER - ERS
ML F/Entrance	\$ 1,668.00	\$ 1,819.00	\$ 1,579.00	\$ 1,617.00	\$ 1,655.00
ML FD/Entrance	\$ 1,744.00	\$ 1,869.00	\$ 1,617.00	\$ 1,668.00	\$ 1,706.00
ML FW/Entrance	\$ 1,643.00	\$ 1,793.00	\$ 1,516.00	\$ 1,592.00	\$ 1,630.00
ML B/Entrance	\$ 1,643.00	\$ 1,793.00	\$ 1,542.00	\$ 1,592.00	\$ 1,630.00
ML AC/Entrance	\$ 1,668.00	\$ 1,793.00	\$ 1,568.00	\$ 1,655.00	\$ 1,706.00
ML E/Office	\$ 1,617.00	\$ 1,706.00	\$ 1,328.00	\$ 1,617.00	\$ 1,643.00
ML EW/Storeroom	\$ 1,592.00	\$ 1,668.00	\$ 1,290.00	\$ 1,579.00	\$ 1,630.00
ML J/Classroom	\$ 1,617.00	\$ 1,706.00	\$ 1,328.00	\$ 1,617.00	\$ 1,643.00
ML N/Passage	\$ 1,454.00	\$ 1,617.00	\$ 1,238.00	\$ 1,479.00	\$ 1,516.00
ML LF/Privacy	\$ 1,693.00	\$ 1,819.00	\$ 1,568.00	\$ 1,568.00	\$ 1,605.00
ML H/Hotel	-	-	-	\$ 1,542.00	\$ 1,643.00
ML NC/Communicating	\$ 899.00	\$ 902.00	\$ 910.00	\$ 985.00	\$ 999.00
ML ELEC/Electrified	\$ 2,918.00	\$ 3,030.00	\$ 2,778.00	\$ 2,905.00	\$ 2,968.00

Conversions from metric to U.S. measurements are approximate.

The prices above refer to locks of 2.3/4" and 2.1/2" backset. Upcharges apply for different backsets. See page 17.

If requested without mortise lock, deduct \$120 retail price. For ML-ELECT without mortise lock, deduct \$120 from ML-EW retail price.

If requested without cylinder, deduct \$15 retail price.

Same prices for all the standard finishes as indicated per each lever page. Special finishes are available upon request. See pages 12-13 for finish selection. Upcharges apply.

Upside Down and Magnetic Locks are available upon request. Upcharges at page 17.

For the electrified mortise locks, the AE switch (Request to Exit) must be requested at the time of the order. Upcharges apply.

## Group 9 Mortise locks

Door levers \_\_\_\_\_ H 5015 Black leather, H 5015 Orange leather

**Retail price**

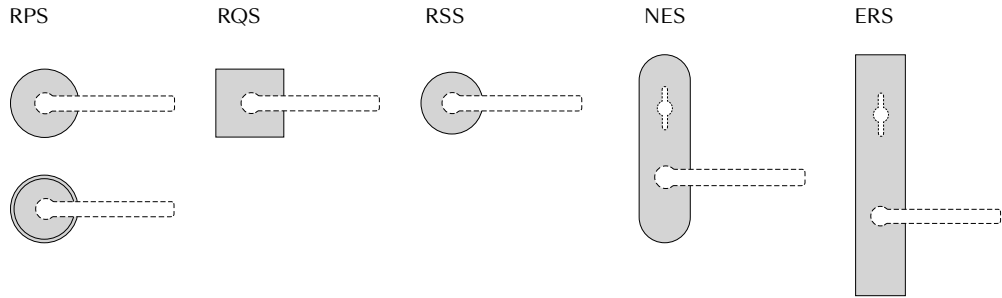

<b>ML F/Entrance</b>	\$ 2,299.00	\$ 2,464.00	\$ 2,009.00	\$ 2,059.00	\$ 2,101.00
<b>ML FD/Entrance</b>	\$ 2,349.00	\$ 2,464.00	\$ 2,059.00	\$ 2,110.00	\$ 2,148.00
<b>ML FW/Entrance</b>	\$ 2,261.00	\$ 2,274.00	\$ 1,983.00	\$ 2,047.00	\$ 2,085.00
<b>ML B/Entrance</b>	\$ 2,248.00	\$ 2,274.00	\$ 1,995.00	\$ 2,047.00	\$ 2,085.00
<b>ML AC/Entrance</b>	\$ 2,210.00	\$ 2,274.00	\$ 1,934.00	\$ 2,085.00	\$ 2,172.00
<b>ML E/Office</b>	\$ 2,123.00	\$ 2,210.00	\$ 1,844.00	\$ 2,009.00	\$ 2,110.00
<b>ML EW/Storeroom</b>	\$ 2,085.00	\$ 2,148.00	\$ 1,807.00	\$ 1,970.00	\$ 2,059.00
<b>ML J/Classroom</b>	\$ 2,123.00	\$ 2,210.00	\$ 1,844.00	\$ 2,009.00	\$ 2,110.00
<b>ML N/Passage</b>	\$ 1,895.00	\$ 1,959.00	\$ 1,617.00	\$ 1,832.00	\$ 1,934.00
<b>ML LF/Privacy</b>	\$ 2,274.00	\$ 2,263.00	\$ 1,995.00	\$ 1,959.00	\$ 2,020.00
<b>ML H/Hotel</b>	-	-	-	\$ 2,097.00	\$ 2,027.00
<b>ML NC/Communicating</b>	\$ 1,138.00	\$ 1,200.00	\$ 1,113.00	\$ 1,138.00	\$ 1,213.00
<b>ML ELEC/Electrified</b>	\$ 3,409.00	\$ 3,535.00	\$ 3,132.00	\$ 3,284.00	\$ 3,384.00

Conversions from metric to U.S. measurements are approximate.

The prices above refer to locks of 2.3/4" and 2.1/2" backset. Upcharges apply for different backsets. See page 17.

If requested without mortise lock, deduct \$120 retail price. For ML-ELECT without mortise lock, deduct \$120 from ML-EW retail price.

If requested without cylinder, deduct \$15 retail price.

Same prices for all the standard finishes as indicated per each lever page. Special finishes are available upon request. See pages 12-13 for finish selection. Upcharges apply.

Upside Down and Magnetic Locks are available upon request. Upcharges at page 17.

For the electrified mortise locks, the AE switch (Request to Exit) must be requested at the time of the order. Upcharges apply.



### L 198

Brass

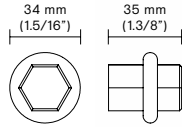

Finish	Retail price
<b>03</b> Polished brass	\$ 35.00
<b>03D</b> Satin brass	\$ 38.00
<b>14</b> Polished nickel	\$ 46.00
<b>15</b> Satin nickel	\$ 49.00
<b>26</b> Polished chrome	\$ 42.00
<b>26D</b> Satin chrome	\$ 44.00

### L 192

Brass

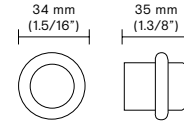

Finish	Retail price
<b>03</b> Polished brass	\$ 34.00
<b>03D</b> Satin brass	\$ 34.00
<b>06A</b> Anticato	\$ 49.00
<b>06B</b> Brunito	\$ 49.00
<b>14</b> Polished nickel	\$ 48.00
<b>15</b> Satin nickel	\$ 48.00
<b>26</b> Polished chrome	\$ 50.00
<b>26D</b> Satin chrome	\$ 39.00

### L 190

Brass

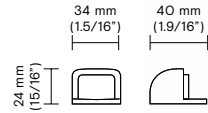

Finish	Retail price
<b>03</b> Polished brass	\$ 40.00
<b>06B</b> Brunito	\$ 40.00
<b>14</b> Polished nickel	\$ 49.00
<b>26</b> Polished chrome	\$ 40.00
<b>26D</b> Satin chrome	\$ 46.00

### L 490

Stainless steel AISI 304

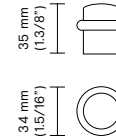

Finish	Retail price
<b>32D</b> Satin stainless steel	\$ 35.00

The options listed above are considered standard.  
Non-standard options are available upon request.

For more options on Finishes see pages 12-13.

### E 183

Brass

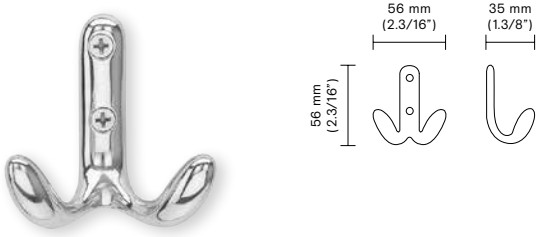

Finish	Retail price
<b>03</b> Polished brass	\$ 30.00
<b>06B</b> Brunito	\$ 36.00
<b>26</b> Polished chrome	\$ 30.00
<b>26D</b> Satin chrome	\$ 32.00

### E 182

Brass

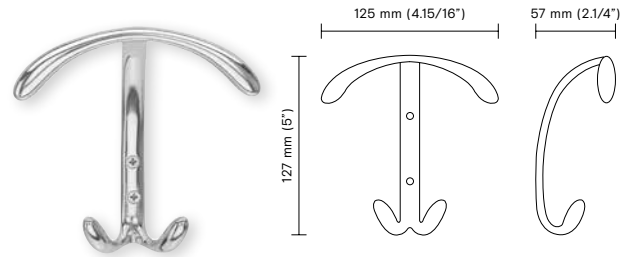

Finish	Retail price
<b>03</b> Polished brass	\$ 58.00
<b>06B</b> Brunito	\$ 69.00
<b>26</b> Polished chrome	\$ 63.00
<b>26D</b> Satin chrome	\$ 60.00

### E 180

Brass

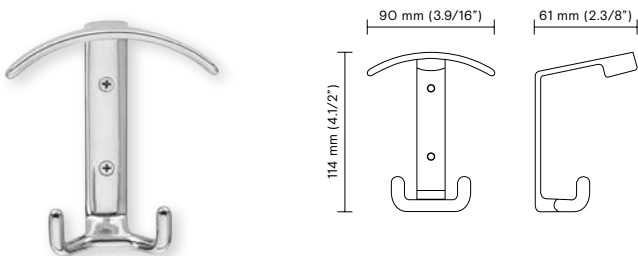

Finish	Retail price
<b>03</b> Polished brass	\$ 93.00
<b>26D</b> Satin chrome	\$ 83.00

The options listed above are considered standard.  
Non-standard options are available upon request.

For more options on Finishes see pages 12-13.

**MAGNETIC TUBULAR LATCH**

Every lever and knob in our range can be matched to a magnetic tubular latch. The latch is only available in 3 finishes: 26/Polished chrome, 26D/Satin chrome, 16/Dull black. The upcharge is \$ 35.00 LIST from the price of a standard tubular set. The price of the spare latches are listed below.

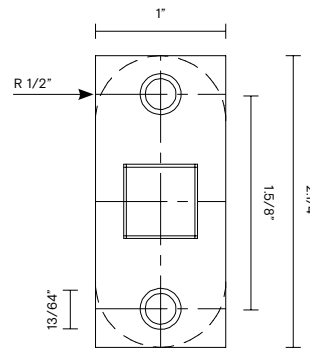
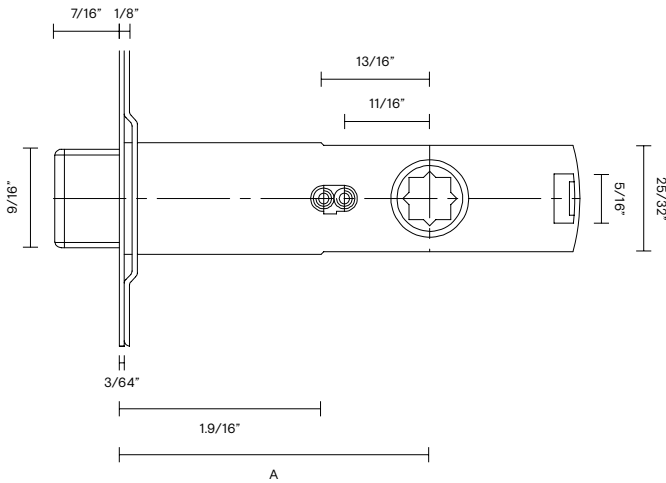

A = 2.3/8" or 2.3/4"

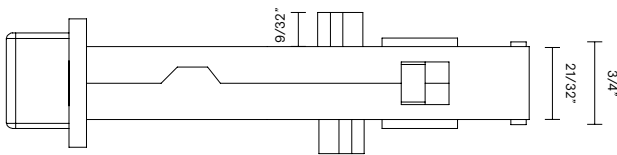

**Retail price**

Part N°	Backset	Functions	Overall latch size	26	26D	16
<b>01M</b>	2.3/8"	Passage	3.1/2"	\$ 65.00	\$ 65.00	\$ 65.00
<b>02M</b>	2.3/4"	Passage	3.7/8"	\$ 65.00	\$ 65.00	\$ 65.00
<b>03M</b>	2.3/8"	Privacy	3.1/2"	\$ 75.00	\$ 75.00	\$ 75.00
<b>04M</b>	2.3/4"	Privacy	3.7/8"	\$ 75.00	\$ 75.00	\$ 75.00

## TUBULAR LATCH BOLTS 28 DEGREES

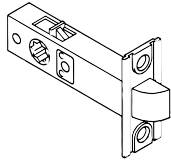

### Retail price

Part N°	Backset	Functions	Overall latch size	03 Polished brass	06 Antique brass	26/14 Polished chrome/ Polished nickel	26D/15 Satin chrome/ Satin nickel	Others
<b>01L</b>	2.3/8"	Passage	3.1/4"	\$ 45.00	\$ 45.00	\$ 45.00	\$ 45.00	\$ 65.00
<b>02L</b>	2.3/4"	Passage	3.5/8"	\$ 45.00	\$ 45.00	\$ 45.00	\$ 45.00	\$ 65.00
<b>03L</b>	2.3/8"	Privacy	3.1/4"	\$ 55.00	\$ 55.00	\$ 55.00	\$ 55.00	\$ 75.00
<b>04L</b>	2.3/4"	Privacy	3.5/8"	\$ 55.00	\$ 55.00	\$ 55.00	\$ 55.00	\$ 75.00

## DEADBOLT LATCH & PRIVACY BOLTS

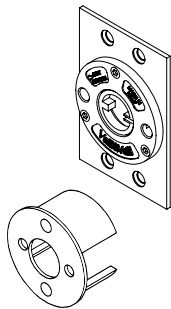
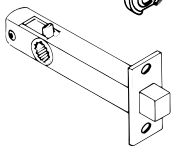
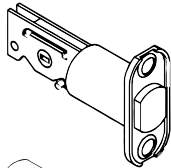

Part N°	Backset	Functions	Overall latch size	03 Polished brass	06 Antique brass	26/14 Polished chrome/ Polished nickel	26D/15 Satin chrome/ Satin nickel	Others
<b>09</b>	2.3/8"	Dead bolt	3.1/4"	\$ 90.00	\$ 90.00	\$ 90.00	\$ 90.00	\$ 100.00
<b>10</b>	2.3/4"	Dead bolt	3.5/8"	\$ 90.00	\$ 90.00	\$ 90.00	\$ 90.00	\$ 100.00

**Above includes:** deadbolt latch, mortise cylinder housing, strike plate for both metal and wood jambs, face plate and screws (no cylinder)

<b>X 30</b>	2.3/8"	Privacy bolt	3.5/16"	\$ 55.00	\$ 55.00	\$ 55.00	\$ 55.00	\$ 60.00
<b>X 31</b>	2.3/4"	Privacy bolt	3.3/4"	\$ 55.00	\$ 55.00	\$ 55.00	\$ 55.00	\$ 60.00

## HOUSINGS

### Retail price

<b>X 2122 / X 0436</b>	Housing for rosettes	\$ 27.00 each
<b>X 0403</b>	Interior underosette to mount interior deadbolt trim	\$ 55.00 each
<b>X 1116 / X 0545</b>	Underrosettes for RP/Round Deadbolt	\$ 98.00 pair
<b>X 0550</b>	Underrosettes for RQ/Square Deadbolt	\$ 17.00 side
<b>X 0547</b>	Underrosettes for RQ Mortise lock	\$ 52.00 pair
<b>X 2124M / X 0428</b>	Housing, spring loaded for long escutcheon plates	\$ 22.00 each

## STRIKE PLATES

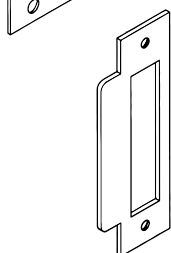
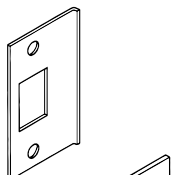
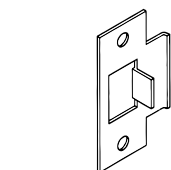

Part N°		03 Polished brass	06 Antique brass	15 Satin nickel	26 Polished chrome	26D Satin chrome	14 Polished nickel
<b>TS 01</b>	T-strikes (tubular latch)	\$ 10.00	-	\$ 10.00	\$ 10.00	\$ 10.00	\$ 10.00
<b>ETS-115</b>	Extended for doors 2.1/4" thick	\$ 50.00	\$ 50.00	\$ 50.00	\$ 50.00	\$ 50.00	-
<b>ETS-175</b>	Extended for doors 2.1/2" & up	\$ 50.00	\$ 50.00	\$ 50.00	\$ 50.00	\$ 50.00	-
<b>FL 01</b>	Full lip (tubular latch)	\$ 9.00	\$ 9.00	\$ 9.00	\$ 9.00	\$ 9.00	\$ 9.00
<b>ETS-115</b>	Extended for doors 2.1/4" thick	\$ 50.00	\$ 50.00	\$ 50.00	\$ 50.00	\$ 50.00	-
<b>ETS-175</b>	Extended for doors 2.1/2" & up	\$ 50.00	\$ 50.00	\$ 50.00	\$ 50.00	\$ 50.00	-
<b>TS 01</b>	T-strikes (tubular latch)	\$ 10.00	-	\$ 10.00	\$ 10.00	\$ 10.00	\$ 10.00
<b>ETS-115</b>	Extended for doors 2.1/4" thick	\$ 50.00	\$ 50.00	\$ 50.00	\$ 50.00	\$ 50.00	-
<b>ETS-175</b>	Extended for doors 2.1/2" & up	\$ 50.00	\$ 50.00	\$ 50.00	\$ 50.00	\$ 50.00	-

## Rosettes

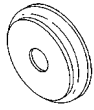

## Retail price

RT Traditional 2.9/16" (65mtm)	03/03D Polished brass / Satin brass	14 Polished nickel	15 Satin nickel	26/26D Polished chrome/ Satin chrome	Other
<b>K 1749</b> RS (ML) threaded each	\$ 43.00	\$ 53.00	\$ 45.00	\$ 44.00	\$ 53.00
<b>K 1741</b> RRS PGE CP	\$ 39.00	\$ 39.00	\$ 49.00	\$ 39.00	\$ 59.00
<b>K 1741</b> RRS PCY CPK	\$ 54.00	\$ 81.00	\$ 64.00	\$ 54.00	\$ 81.00
<b>K 1741</b> RRS SF (DMY) each	\$ 19.00	\$ 30.00	\$ 25.00	\$ 19.00	\$ 29.00

## Retail price

RP Round 2.9/16" (65mm)	03/03D Polished brass / Satin brass	14 Polished nickel	15 Satin nickel	26 Polished chrome	26D Satin chrome	Other
<b>K 1748</b> RS (ML) threaded each	\$ 41.00	\$ 54.00	\$ 50.00	\$ 41.00	\$ 50.00	\$ 54.00
<b>K 1742</b> RRS PGE CP	\$ 44.00	\$ 45.00	\$ 53.00	\$ 42.00	\$ 45.00	\$ 71.00
<b>K 1742</b> RRS PCY CPK	\$ 54.00	\$ 56.00	\$ 64.00	\$ 59.00	\$ 56.00	\$ 89.00
<b>K 1742</b> RRS SF (DMY) each	\$ 21.00	\$ 23.00	\$ 27.00	\$ 19.00	\$ 23.00	\$ 37.00



## Retail price

RP Round	03/03D Polished brass / Satin brass	14 Polished nickel	15 Satin nickel	26 Polished chrome	26D Satin chrome	Other
<b>K 1112</b> RS 1.3/4" (45 mm) each	\$ 32.00	\$ 35.00	\$ 35.00	\$ 32.00	\$ 35.00	\$ 37.00
<b>K 1121</b> RS 2" (50 mm) each	\$ 32.00	\$ 35.00	\$ 35.00	\$ 32.00	\$ 35.00	\$ 37.00



## Retail price

RPS Stainless Steel Round 2.9/16" (65mm)	32 Polished stainless steel	32D Satin stainless steel
<b>R 5701</b> (ML) threaded each	\$ 146.00	\$ 111.00
<b>R 5703</b> RRS PGE	\$ 117.00	\$ 122.00
<b>R 5703</b> RRS PCY CPK	\$ 136.00	\$ 122.00
<b>R 5703</b> RRS SF (DMY) each	\$ 59.00	\$ 62.00



## Retail price

RSS Stainless Steel Round 2" (50mm)	32 Polished stainless steel	32D Satin stainless steel
<b>R 5704</b> RRS PGE	\$ 81.00	\$ 58.00
<b>R 5702</b> RS (DMY) each	\$ 27.00	\$ 22.00



## Retail price

RQ Square 2.9/16" (65mm)	14 Polished nickel	15 Satin nickel	26 Polished chrome	26D Satin chrome	Other
<b>K 1780</b> RS I (inside) ML each	\$ 103.00	\$ 103.00	\$ 85.00	\$ 103.00	\$ 103.00
<b>K 1780</b> RS E (outside) ML each	\$ 103.00	\$ 103.00	\$ 85.00	\$ 103.00	\$ 103.00
<b>K 1798</b> RRS PGE	\$ 192.00	\$ 176.00	\$ 161.00	\$ 176.00	\$ 192.00
<b>K 1798</b> RRS PCY	\$ 203.00	\$ 187.00	\$ 187.00	\$ 203.00	\$ 203.00
<b>K 1798</b> RRS (DMY) each	\$ 103.00	\$ 103.00	\$ 85.00	\$ 103.00	\$ 103.00

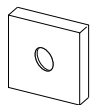

## Retail price

RQS Square 2" (50mm)	26 Polished chrome	26D Satin chrome	Other
<b>K 1138</b> RS each	\$ 37.00	\$ 48.00	\$ 48.00



## Rosettes

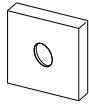

### Retail price

Part N°	Description	32 Polished stainless steel	32D Satin stainless steel
RPS	Stainless steel square 2.9/16" (65mm)		
R 5709 RS I	(inside) ML each	\$ 173.00	\$ 132.00
R 5709 RS E	(outside) ML each	\$ 173.00	\$ 132.00
R 5707 RRS	PGE	\$ 326.00	\$ 252.00
R 5707 RRS	PCY	\$ 354.00	\$ 272.00
R 5707 RRS	(DMY) each	\$ 173.00	\$ 132.00

## Mortise cylinder - C keyway

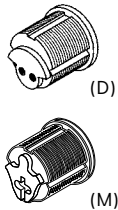

### Retail price

Part N°	Door thickness	03 Polished brass	06B Brunito	15 Satin nickel	26 Polished chrome	26D Satin chrome
C 01	1.3/8" D	\$ 43.00	\$ 43.00	\$ 43.00	\$ 43.00	\$ 43.00
C 02	1.3/4" D	\$ 43.00	\$ 43.00	\$ 43.00	\$ 43.00	\$ 43.00
C 03	2" D - 1.3/4" M	\$ 43.00	\$ 43.00	\$ 43.00	\$ 43.00	\$ 43.00
C 04	1.3/8" cyl. 2.1/4" D - 2" M	\$ 43.00	\$ 43.00	\$ 43.00	\$ 43.00	\$ 43.00
C 05	1.1/2" cyl. 2.1/2" D - 2.1/4" M	\$ 43.00	\$ 43.00	\$ 43.00	\$ 43.00	\$ 43.00
C06	1.3/4" cyl. 3" D - 2.3/4" M	\$ 43.00	\$ 43.00	\$ 43.00	\$ 43.00	\$ 43.00

Must specify Daedbolt (D) or Mortise lock (M). Straight cam is used for mortise locks without thumb turns.

## Profile cylinder - C keyway

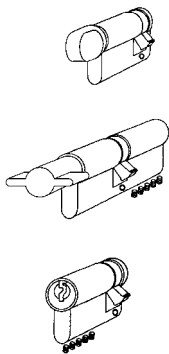

### Retail price

Part N°	Description	Door thickness	03 Polished brass	26 Polished chrome	15/26D Satin nickel / Polished chrome	32D Satin stainless steel
C 07	35 mm Key by thumb turn		\$ 43.00	\$ 43.00	\$ 43.00	--
C 08	72 mm Key by thumb turn profile cylinder	1.3/4"	\$ 432.00	\$ 432.00	\$ 432.00	--
C 09	81 mm Key by thumb turn profile cylinder	2.1/4"	\$ 432.00	--	\$ 432.00	--
C 12	45 mm Half profile profile cylinder with thumb turn		\$ 432.00	\$ 432.00	\$ 432.00	--
C 13	50 mm Half profile profile cylinder with thumb turn		\$ 432.00	--	\$ 432.00	--
C 14	45 mm Half profile profile cylinder with keyway		\$ 432.00	--	\$ 432.00	--
K 1799/6	Thumb turn for profile cylinder (brass)		\$ 43.00	\$ 43.00	\$ 43.00	--
S 5702 BZG MP	Thumb turn for profile cylinder (stainless steel)		--	--	--	\$ 85.00

Must add price of thumb turn to profile cylinder.

## Allen wrenches & set screw (metric)



### Retail price

X 0286	Set screws with allen wrench for stainless steel levers and knobs	\$ 14.00
W 04	Allen wrench for deadbolt cylinder locking screw	\$ 3.00

Set screws with allen wrenches for brass levers and knobs: Set screws size  $\varnothing$ =mm 6 wide x 9 long.

## Dust box

### Retail price

Part N°	Description	03 Polished brass	26 Polished chrome	15/26D Satin nickel / Polished chrome	Other
DB-04	Dust box T-strike	--	--	--	\$ 6.00
DB-03	Dust box full lip strike	--	--	--	\$ 6.00
DB-02	Dust box mortise strike	\$ 6.00	\$ 6.00	\$ 12.00	--

**Mortise locks**

Must specify 2.1/2" or 2.3/4" backset. Must specify for levers or knobs. Includes: mortise lock body, face plate, strike plate, screws and dust box (no cylinder). Custom mortise locks and other backsets available upon special request.  UL listed 3 hours fire rating.

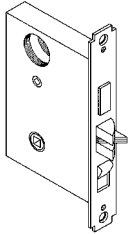

Part N°	Description	Retail price
ML-F	Entrance (lever sets)	\$ 350.00
ML-FD	Entrance	\$ 450.00
ML-FW	Entrance	\$ 350.00
ML-J	Classroom	\$ 450.00
ML-AC	Entrance	\$ 350.00
ML-N	Passage	\$ 350.00
ML-B	Entrance	\$ 350.00
ML-NC	Communicating	\$ 450.00
ML-E	Office	\$ 450.00
ML-LF	Privacy	\$ 350.00
ML-ELEC	Electrified	\$ 2,150.00
ML-EW	Storeroom	\$ 350.00
ML-H	Hotel	\$ 350.00
ML-DEADLOCK	Mortise deadlock	\$ 200.00
ML-PL2000 PGE	Mortise lock for passage pocket door	\$ 400.00
ML-2002 PCY	Mortise lock for privacy pocket door	\$ 450.00

See page 171 for details on functions.

**Spindles**

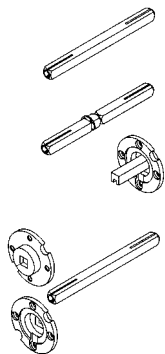

Part N°	Description	Overall length	Retail price
X O16	8mm, solid spindle for doors 1.3/8" to 2.1/4"	4.1/2"	\$ 11.00
X O100/8 - 145	8mm, solid spindle for doors 2.3/8" to 3"	5.5/8"	\$ 22.00
X O163 / X 1119-114	8mm, split spindle for doors 1.3/8" to 2.1/4"	4.1/2"	\$ 16.00
X O163 / X 1119-145	8mm, split spindle for doors 2.3/8" to 3"	5.3/4"	\$ 16.00
X O571	8mm, surface mounted dummy (for round rosette)		\$ 27.00
X O571 OT SQ	8mm, surface mounted dummy (for square rosette)		\$ 30.00
X O572	8mm, opposing mounted dummy plates		\$ 29.00
X 1118	5mm/tailpiece, for deadbolts with doors 1.3/8" to 1.3/4"		\$ 8.00
X 117/5-60	5mm x 60mm, for mortise lock functions with doors 1.3/4"		\$ 4.00
X 117/5-85	5mm x 85mm, for 105 privacy bolts with doors up to 1.3/4"		\$ 4.00

**Deadbolt, privacy bolt, mortise trim only**

**Retail price**



K 1725



S 5700

Part N°	03/03D Polished brass / Satin brass	14 Polished nickel	15 Satin nickel	26 Polished chrome	26D Satin chrome	32 Polished stainless steel	32D Satin stainless steel	26/26D Polished chrome / Satin chrome	Other
<b>K 1724 RS BZG</b> Interior trim for 105 RST (Traditional)	\$ 90.00	\$ 108.00	\$ 93.00	--	--	--	--	\$ 118.00	\$ 122.00
<b>K 1724 RS VBZG</b> Exterior trim for 105 RST (Traditional) Emergency release	\$ 90.00	\$ 108.00	\$ 99.00	--	--	--	--	\$ 118.00	\$ 122.00
<b>K 1725 RS BZG</b> Interior trim for 105 RSP (Round)	\$ 80.00	\$ 103.00	\$ 96.00	\$ 80.00	\$ 96.00	--	--	--	\$ 108.00
<b>K 1725 RS VBZG</b> Exterior trim for 105 RSP (Round) Emergency release	\$ 80.00	\$ 103.00	\$ 96.00	\$ 80.00	\$ 96.00	--	--	--	\$ 80.00
<b>S 5700 RS BZG</b> Interior trim for 105 RSS (Stainless Steel)	--	--	--	--	--	\$ 207.00	\$ 179.00	--	--
<b>S 5700 RS VBZG</b> Exterior trim for 105 RSS (Stainless Steel) Emergency release	--	--	--	--	--	\$ 161.00	\$ 123.00	--	--

## Deadbolt, privacy bolt, mortise trim only

### Retail price

K 1781

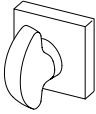

S 5703

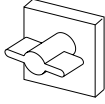

K 1729



Part N°	03/03D Polished brass / Satin brass	14 Polished nickel	15 Satin nickel	26 Polished chrome	26D Satin chrome	32 Polished stainless steel	32D Satin stainless steel	26/26D Polished chrome / Satin chrome	Other
<b>K 1781 RS BZG</b> Interior trim for 105 RSQ (Square)	--	\$ 190.00	\$ 174.00	\$ 158.00	\$ 174.00	--	--	--	\$ 174.00
<b>K 1781 RS VBZG</b> Exterior trim for 105 RSQ (Square) Emergency release	--	\$ 190.00	\$ 174.00	\$ 158.00	\$ 174.00	--	--	--	\$ 174.00
<b>S 5703 RS BZG</b> Interior trim for 105 RSQS (Square) Stainless Steel	--	--	--	--	--	\$ 280.00	\$ 215.00	--	--
<b>S 5703 RS VBZG</b> Exterior trim for 105 RSQS (Square) Stainless Steel Emergency release	--	--	--	--	--	\$ 200.00	\$ 153.00	--	--
<b>K 1728 RS BZG</b> Interior trim for traditional deadbolt (101 RT)	\$ 78.00	\$ 89.00	\$ 85.00	--	\$ 89.00	--	--	--	\$ 102.00
<b>K 1749 RSC</b> Exterior trim for traditional deadbolt (101 RT)	\$ 43.00	\$ 53.00	\$ 45.00	--	--	--	--	\$ 44.00	\$ 53.00
<b>K 1729 RS BZG</b> Interior trim for traditional deadbolt (101 RT)	\$ 106.00	\$ 85.00	\$ 85.00	\$ 78.00	\$ 85.00	--	--	--	\$ 106.00
<b>K 1748 RSC</b> Exterior rosette for round deadbolt (101 RP)	\$ 47.00	\$ 52.00	\$ 52.00	\$ 48.00	\$ 52.00	--	--	--	\$ 54.00
<b>R 5701 RS BZG</b> Interior trim for round stainless deadbolt (101 RPS)	--	--	--	--	--	\$ 253.00	\$ 193.00	--	--
<b>R 5705 RS</b> Exterior trim for round stainless deadbolt (101 RPS)	--	--	--	--	--	\$ 145.00	\$ 111.00	--	--
<b>R 5708 RS BZG</b> Interior trim for square stainless deadbolt (101 RQS)	--	--	--	--	--	\$ 283.00	\$ 218.00	--	--
<b>R 5709 RS</b> Exterior trim for square stainless deadbolt (101 RQS)	--	--	--	--	--	\$ 177.00	\$ 136.00	--	--
<b>K 1778 RS BZG</b> Interior trim for square brass deadbolt (101 RQ)	--	\$ 208.00	\$ 174.00	\$ 158.00	\$ 174.00	--	--	--	\$ 174.00
<b>K 1780 RS</b> Exterior trim for square brass deadbolt (101 RQ)	--	\$ 100.00	\$ 107.00	\$ 91.00	\$ 107.00	--	--	--	\$ 107.00
<b>K 1726</b> Mortise lock cylinder collar (Traditional)	\$ 49.00	\$ 49.00	\$ 49.00	\$ 40.00	\$ 45.00	--	--	--	\$ 55.00
<b>K 1727</b> Mortise lock cylinder collar round (Brass)	\$ 58.00	\$ 53.00	\$ 53.00	\$ 48.00	\$ 48.00	--	--	--	\$ 58.00
<b>R 5700</b> Mortise lock cylinder collar round (Stainless Steel)	--	--	--	--	--	\$ 107.00	\$ 87.00	--	--
<b>K 1767</b> Mortise lock cylinder collar square (Brass)	--	\$ 120.00	\$ 109.00	\$ 99.00	\$ 99.00	--	--	--	\$ 109.00
<b>R 5710</b> Mortise lock cylinder collar square (Stainless Steel)	--	--	--	--	--	\$ 147.00	\$ 112.00	--	--
<b>X 1121 K / X O228</b> Cylinder collar for exterior rosette for deadbolt (Brass)	\$ 22.00	\$ 22.00	\$ 22.00	\$ 22.00	\$ 22.00	--	--	--	\$ 22.00
<b>X 1121 K / X O237</b> Cylinder collar for exterior rosette for deadbolt (Stainless)	--	--	--	--	--	\$ 43.00	\$ 43.00	--	--
<b>K 1806/1225 RS BZG</b> Interior trim for K 1225 RSQ (Square)	--	\$ 198.00	\$ 174.00	\$ 158.00	\$ 174.00	--	--	--	\$ 174.00
<b>K 1806 RS VBZG</b> Exterior trim for K 1225 RSQ (Square) Emergency release	--	\$ 198.00	\$ 174.00	\$ 158.00	\$ 174.00	--	--	--	\$ 174.00

## Privacy pin

Part N°	Description	Finish options	Retail price
X 0227	Pin for tubular latch (M3 thread)	O3, O3D, O6A, O6B, 26, 26D, 16	\$ 13.00
X 0248	Pin for tubular latch stainless steel (M3 thread)	32, 32D	\$ 15.00

## Fasteners

Part N°	Description	Retail price
X 176	Retaining ring to attach levers to rosettes and long escutcheons. Specify RH - LH	\$ 5.00
X 187	Metal washer	\$ 4.00
X 184	Retaining clip to attach thumb turns to rosettes and long escutcheons	\$ 4.00
X 1161	Locking o-ring to attach levers to rosettes and long escutcheon plates	\$ 4.00
X 1162	Stainless steel washer	\$ 4.00
X 1167	Stainless steel washer	\$ 4.00
X 0326	Nylon bushing to convert 8mm to 5mm	\$ 4.00
X 0339	Nylon bushing to convert 8mm to a flat tailpiece	\$ 4.00
X 1100	Spring for lever and rosette assembly	\$ 3.00
X 1107	Small nylon washer	\$ 3.00
X 1105	Medium nylon washer	\$ 3.00
X 1106	Large nylon washer	\$ 3.00

## Metric screws for door sets

Part N°	Description	Retail price
X 15	Standard pack for 1.3/8" or 1.3/4" doors (rosettes)	\$ 3.00
X 17	Standard pack for 1.3/8" or 1.3/4" doors (long escutcheons)	\$ 5.00
<b>M4 x 30mm (1.1/4")</b>		\$ 1.00
<b>M4 x 40mm (1.1/2")</b>		\$ 1.00
<b>M4 x 50mm (2")</b>		\$ 1.00
<b>M4 x 90mm (3.1/2")</b>		\$ 1.00

X0230 Longer screws for 2.1/4" thick doors \$8

## DOOR PULL MOUNTING KITS

### X 0508 - Single mount

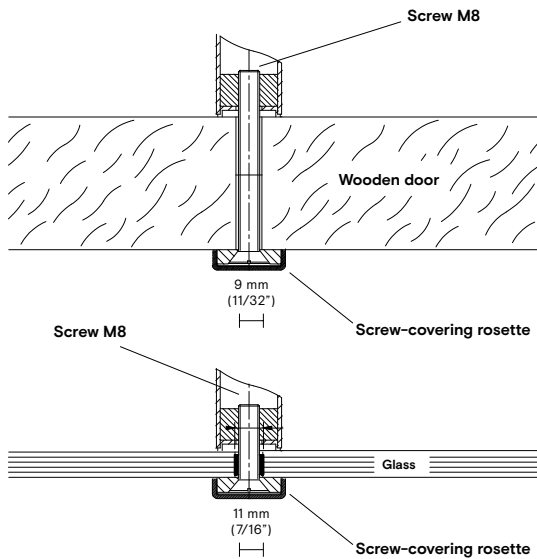

For mounting a single door pull on a wooden door, thickness:  
**45±60 mm (1.25/32"±2.3/8")**  
**60±75 mm (2.3/8"±2.15/16")**  
**75±90 mm (2.15/16"±3.17/32")**

On a glass door, thickness:  
**8±12 mm (5/16"±15/32")**

For pulls:  
**K 353 - P 5405 25**  
**P 5406 25 - P 5408 25**

Recommender hole diameter:  
 Wooden door: **Ø 9 mm (11/32")**  
 Glass door: **Ø 11 mm (7/16")**

X 0508 \$ 91.00

### X 0509 - Back to back mount

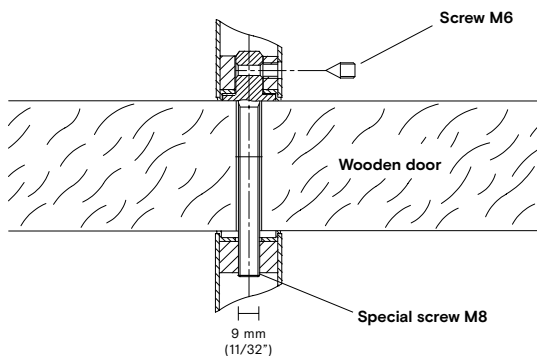

For mounting a pair of door pull on a wooden door, thickness:  
**45±60 mm (1.25/32"±2.3/8")**  
**60±75 mm (2.3/8"±2.15/16")**  
**75±90 mm (2.15/16"±3.17/32")**

For pulls:  
**K 353 - P 5405 25**  
**P 5406 25 - P 5408 25**

Recommender hole diameter:  
**Ø 9 mm (11/32")**

Part N° Retail price

X 0509 \$ 68.00

### X 0510 - Single mount

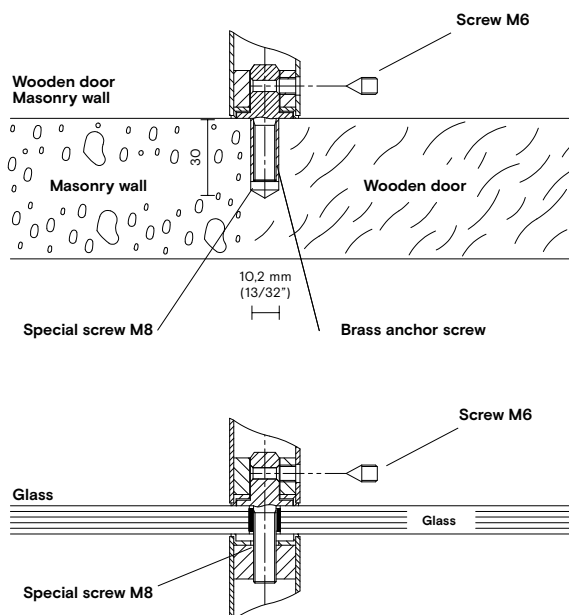

For mounting a single door pull on a wooden door on a masonry wall using a brass anchor screw.

For pulls:  
**K 353 S - P 5405 S 25 -**  
**P 5406 S 25 - P 5408 S 25**

For mounting a pair of handle on a glass door, thickness:  
**8±12 mm (5/16"±15/32")**

For pulls:  
**K 353 - P 5405 25 -**  
**P 5406 25 - P 5408 25**

Recommender hole diameter:  
 Wooden door: **Ø 10,2 mm (13/32")**  
 Glass door: **Ø 11 mm (7/16")**

Part N° Retail price

X 0510 \$ 68.00

**X 0523 - Back to back mount**

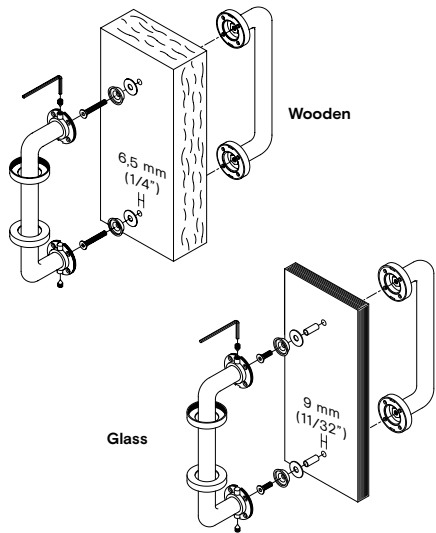

Part N°                      Retail price

X 0523                      \$ 68.00

For fixing a pair of door pull with rosettes on a wooden door, thickness:  
**45+55 mm (1.25/32"±2.5/32")**  
**55+65 mm (2.5/32"±2.9/16")**

On a glass door, thickness:  
**8+12 mm (5/16"±15/32")**

For pulls:  
**K 352 RH/LH - K 356**  
**K 368 - K 377 - K 1188 - K 1210**

Recommender hole diameter:  
 Wooden door: **Ø 6,5 mm (1/4")**  
 Glass door: **Ø 9 mm (11/32")**

**X 0525 - Single mount**

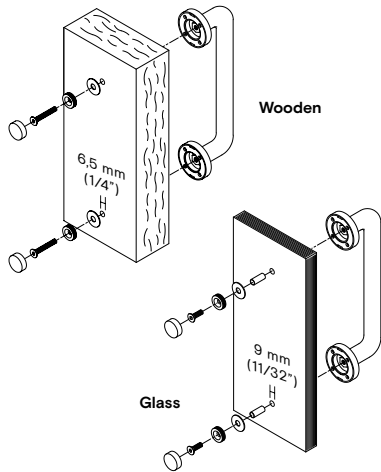

Part N°                      Retail price

X 0525                      \$ 91.00

For fixing a pair of door pull with rosettes on a wooden door, thickness:  
**45+55 mm (1.25/32"±2.5/32")**  
**55+65 mm (2.5/32"±2.9/16")**

On a glass door, thickness:  
**8+12 mm (5/16"±15/32")**

For pulls:  
**K 352 RH/LH - K 356 - K 368**  
**K 377 - K 1188 - K 1210**

Recommender hole diameter:  
 Wooden door: **Ø 6,5 mm (1/4")**  
 Glass door: **Ø 9 mm (11/32")**

**X 0526 - Single mount**

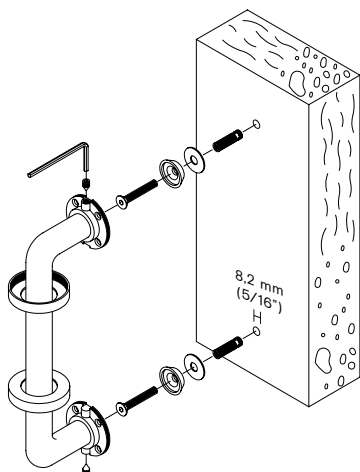

Part N°                      Retail price

X 0526                      \$ 57.00

For mounting a single door pull with screw-covering rosettes on wooden door or on a masonry wall using a brass anchor screw.

For pulls:  
**K 352 RH/LH - K 356 - K 368**  
**K 377 - K 1188 - K 1210**

Recommender hole diameter:  
**Ø 8,2 mm (5/16")**

## X 0528 - Back to back mount

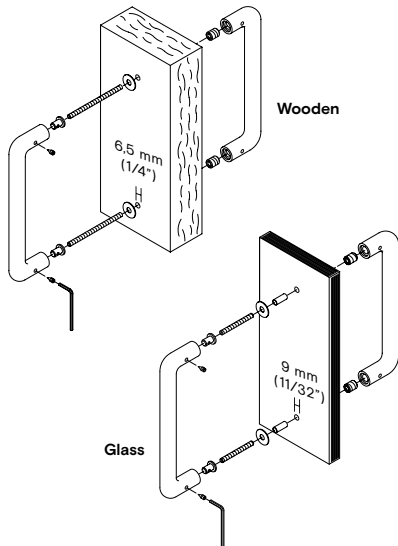

Part N°                      Retail price

X 0528                              \$ 68.00

For mounting a pair of door pull without screw-covering rosettes on a wooden door, thickness:  
**45÷55 mm (1.25/32"÷2.5/32")**  
**55÷65 mm (2.5/32"÷2.9/16")**

On a glass door, thickness:  
**8÷12 mm (5/16"÷15/32")**

For pulls:  
**K 358 - K 378 - K 379 - K 380 - K 381**  
**K 383 - K 385 - K 386 - K 1226 - K 1228**  
**K 1060 - K 1068 - K 1069**

For pulls:  
**K352 RH/LH K 356 - K 368 - K 377**  
**K 1054 - K 1056 - K 1061 - K 1188**  
**K 1210 - K 1231 - K 1235**  
 (Before installation roses must be removed)

Recommender hole diameter:  
 Wooden door: **Ø 6,5 mm (1/4")**  
 Glass door: **Ø 9 mm (11/32")**

## X 0530 - Single mount

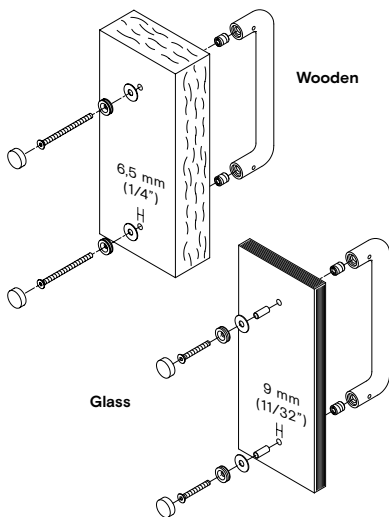

Part N°                      Retail price

X 0530                              \$ 91.00

For mounting a single door pull without rosettes on a wooden door, thickness:  
**45÷55 mm (1.25/32"÷2.5/32")**  
**55÷65 mm (2.5/32"÷2.9/16")**

On a glass door, thickness:  
**8÷12 mm (5/16"÷15/32")**

For pulls:  
**K 358 - K 378 - K 379 - K 380 - K 381**  
**K 383 - K 385 - K386 - K 1226 - K 1228**  
**K 1060 - K 1068 - K 1069**

For pulls:  
**K 352 RH/LH - K 356 - K 368 - K 377 - K 1054**  
**K 1056 - K 1188 - K 1210 - K 1231 - K 1235**  
 (Before installation roses must be removed)

Recommender hole diameter:  
 Wooden door: **Ø 6,5 mm (1/4")**  
 Glass door: **Ø 9 mm (11/32")**

## X 0531 - Single mount

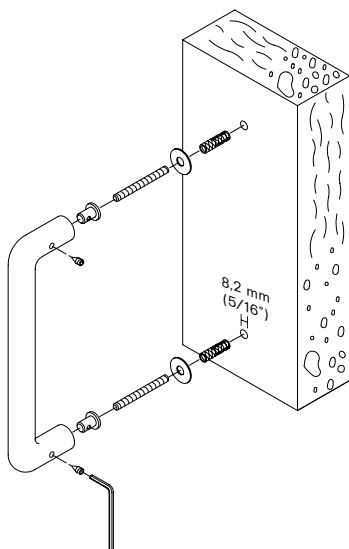

Part N°                      Retail price

X 0531                              \$ 57.00

For mounting a single door pull without rosettes on a wooden door or on a masonry wall using a brass anchor screw.

For pulls:  
**K 358 - K 378 - K 379 - K 380 - K 381**  
**K 383 - K 385 - K 386 - K 1226 - K 1228**  
**K 1060 - K 1068 - K 1069**

For pulls:  
**K 352 RH/LH - K 356 - K 368 - K 377**  
**K 1054 - K 1056 - K 1188 - K 1210 - K 1061**  
**K 1231 - K 1235**  
 (Before installation roses must be removed)

Recommended hole diameter:  
**Ø 8,2 mm (5/16")**

X 0544 / 1

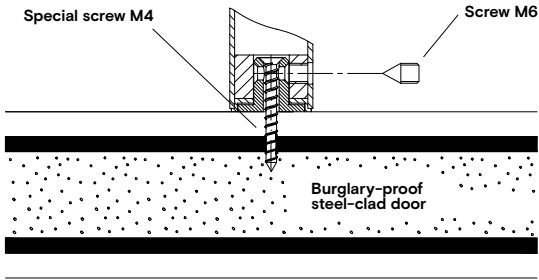

For mounting a single pull handle without rosettes on a burglary-proof steel-clad door.

For pulls:  
**K 353 S - P 5405 S 25**  
**P 5406 S 25 - P 5408 S 25**

Part N°	Retail price
X 0544/1	\$ 57.00

X 0544

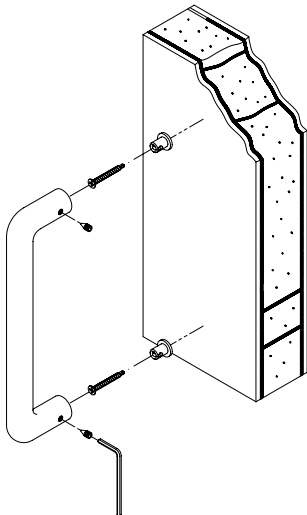

For mounting a single door pull without rosettes on a burglary-proof steel-clad door.

For pulls:  
**K 358 - K 378 - K 379 - K 380**  
**K 381 - K 383 - K 385 - K 386**  
**K 1226 - K 1228 - K 1060**  
**K 1068 - K 1069**

For pulls:  
**K 352 RH/LH - K 356 - K 368**  
**K 377 - K 1054 - K 1056**  
**K 1188 - K 1210 - K 1061**  
**K 1231 - K 1235**  
 (Before installation roses must be removed)

Part N°	Retail price
X 0544	\$ 91.00

X 0551

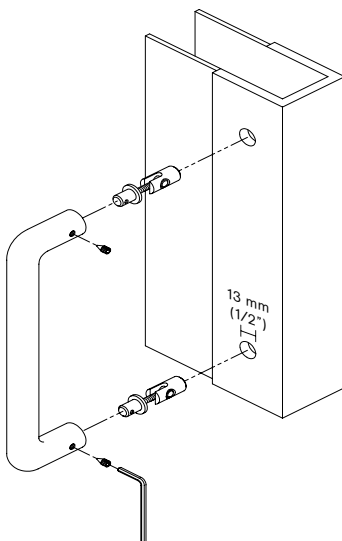

For mounting a single pull handle without screw-covering rosettes on an aluminum door.

For pulls:  
**K 358 - K 378 - K 379 - K 380**  
**K 381 - K 383 - K 385 - K 386**  
**K 1226 - K 1228 - K 1060**  
**K 1068 - K 1069**

For pulls:  
**K 352 RH/LH - K 356 - K 368**  
**K 377 - K 1054 - K 1056 - K 1061**  
**K 1188 - K 1210 - K 1231 - K 1235**  
 (Before installation roses must be removed)

Recommended hole diameter:  
**Ø 13 mm (1/2")**

Part N°	Retail price
X 0551	\$ 91.00

## X 0552

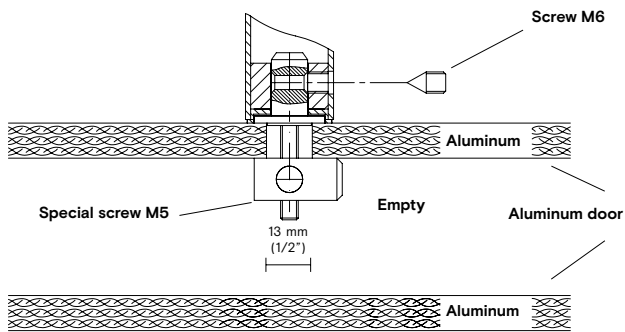

For fixing a single door pull without screw-covering rosettes on an aluminum door.

For pulls:  
**K 353 S - P 5405 S 25**  
**P 5406 S 25 - P 5408 S 25**

Recommended hole diameter:  
**Ø 13 mm (1/2")**

Part N°	Retail price
X 0552	\$ 91.00

## DUMMY SET ADAPTORS Round rosettes - Brass

### X 003/1 Double RP

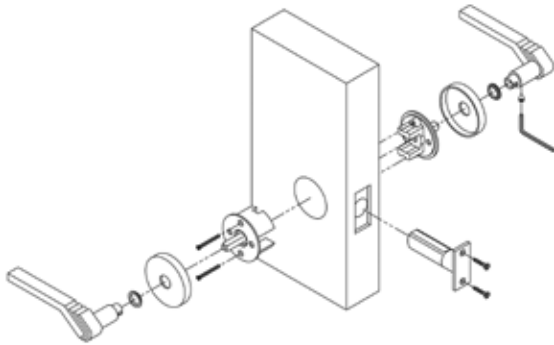

Set includes:  
**2 underosettes,**  
**1 latch bolt blank**

BACKSET 2.3/4" and 2.3/8"

Part N°	Retail price
X 003/1	\$ 85.00

### X 003/2 Single RP

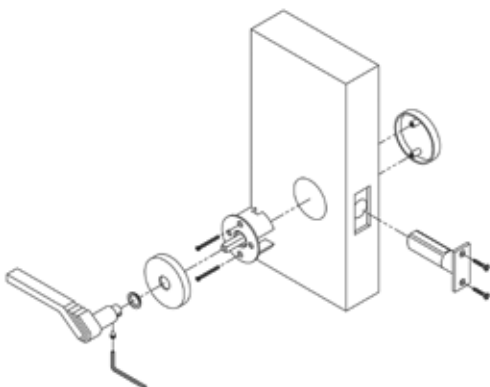

Set includes:  
**1 underosette,**  
**1 latch bolt blank,**  
**1 blind brass rosette**  
**for opposite side.**

BACKSET 2.3/4" and 2.3/8"

Part N°	Retail price
X 003/2	\$ 103.00

**DUMMY SET ADAPTORS Square rosettes - Brass**

**X 003/1 Double RQ**

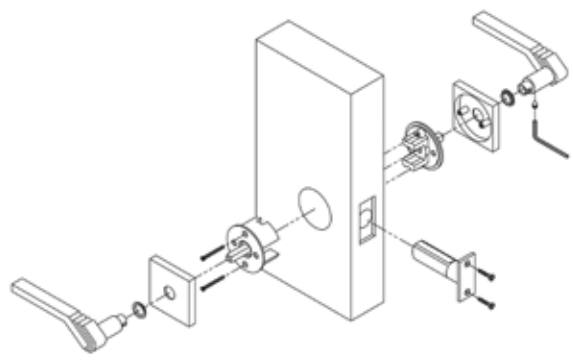

Set includes:  
**2 underosettes,**  
**1 latch bolt blank**  
 BACKSET 2.3/4" and 2.3/8"

Part N°	Retail price
X 003/1	\$ 85.00

**X 003/2 Single RQ**

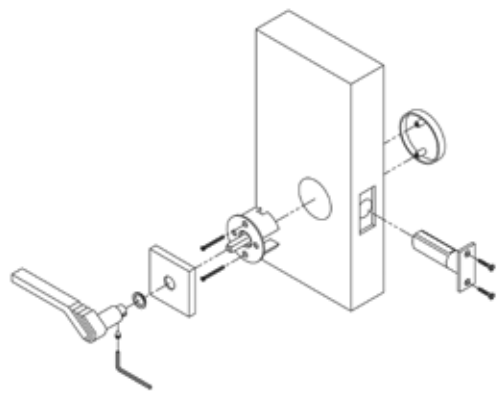

Set includes:  
**1 underosette,**  
**1 latch bolt blank,**  
**1 blind brass rosette**  
**for opposite side.**  
 BACKSET 2.3/4" and 2.3/8"

Part N°	Retail price
X 003/2	\$ 103.00

**DUMMY SET ADAPTORS Round rosettes - Stainless steel**

**X 003/1 Double RPS**

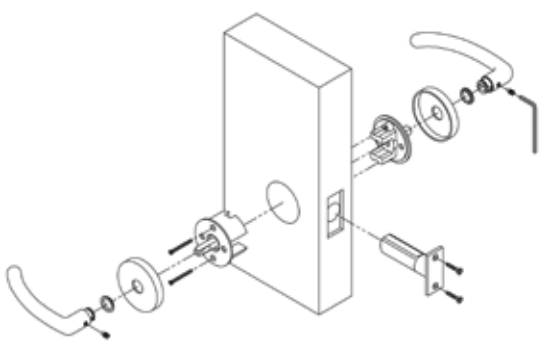

Set includes:  
**2 underosettes,**  
**1 latch bolt blank**  
 BACKSET 2.3/4" and 2.3/8"

Part N°	Retail price
X 003/1	\$ 85.00

## X 003/2 Single RPS

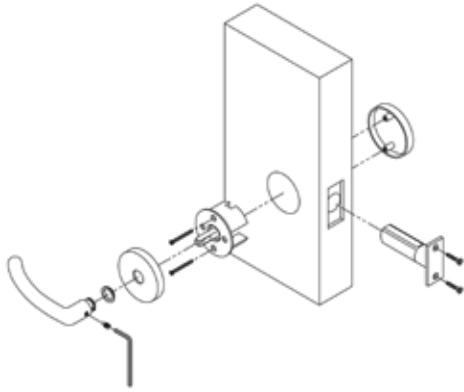

Set includes:  
**1 underosette,**  
**1 latch bolt blank,**  
**1 blind brass rosette**  
**for opposite side.**

BACKSET 2.3/4" and 2.3/8"

Part N°	Retail price
X 003/2	\$ 103.00

## DUMMY SET ADAPTORS Square rosettes - Stainless steel

### X 003/1 Double RQS

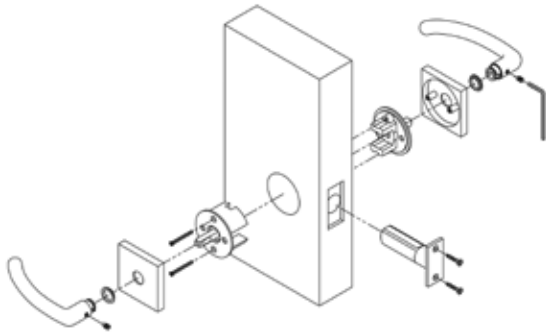

Set includes:  
**2 underosettes,**  
**1 latch bolt blank**

BACKSET 2.3/4" and 2.3/8"

Part N°	Retail price
X 003/1	\$ 85.00

### X 003/2 Single RQS

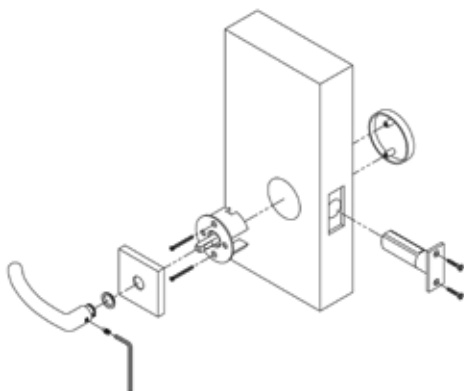

Set includes:  
**1 underosette,**  
**1 latch bolt blank,**  
**1 blind brass rosette**  
**for opposite side.**

BACKSET 2.3/4" and 2.3/8"

Part N°	Retail price
X 003/2	\$ 103.00

# List of door thickness

Each lever/knob design accommodates a different spindle length, based on the shape of the shank. See below the list of the standard spindle lengths for each model. Our set-up is for 1.3/4" thick door. Different door thicknesses must be specified at the time of the order. The below is for reference only.

Article	Series	Thickness from / to	1.3/4" with spindle	1.3/8" with spindle
H 163	Sarissa	33 - 55 mm (1.1/4"x2.1/8")	8 x 114 mm (1.1/4"x2.1/8")	
H 165	Germana	33 - 53 mm (1.1/4"x2.1/8")	8 x 114 mm (1.1/4"x2.1/8")	
H 176	Spiga	33 - 55 mm (1.1/4"x2.1/8")	8 x 114 mm (1.1/4"x2.1/8")	
H 192	Prunus	33 - 55 mm (1.1/4"x2.1/8")	8 x 114 mm (1.1/4"x2.1/8")	
H 198	Eero Aarnio	33 - 55 mm (1.1/4"x2.1/8")	8 x 114 mm (1.1/4"x2.1/8")	
H 311	Mario Bellini	30 - 60 mm (1.1/8"x2.3/8")	8 x 114 mm (1.1/4"x2.1/8")	
H 315	Pierluigi Cerri	33 - 55 mm (1.1/4"x2.1/8")	8 x 114 mm (1.1/4"x2.1/8")	
H 317	Antonio Citterio	33 - 55 mm (1.1/4"x2.1/8")	8 x 114 mm (1.1/4"x2.1/8")	
H 327	Antonio Citterio	33 - 55 mm (1.1/4"x2.1/8")	8 x 114 mm (1.1/4"x2.1/8")	
H 329	Taller Design Ricardo Bofill	33 - 55 mm (1.1/4"x2.1/8")	8 x 114 mm (1.1/4"x2.1/8")	
H 330	Matteo Thun	33 - 55 mm (1.1/4"x2.1/8")	8 x 114 mm (1.1/4"x2.1/8")	
H 334	Foster + Partners	33 - 55 mm (1.1/4"x2.1/8")	8 x 114 mm (1.1/4"x2.1/8")	
H 335	Richard Meier	33 - 43 mm (1.1/4"x1.3/4")	8 x 104 mm (3/8"x4.1/8")	8 x 96 mm (3/8"x3.3/4")
H 338	Yoshimi Kono	33 - 55 mm (1.1/4"x2.1/8")	8 x 114 mm (1.1/4"x2.1/8")	
H 343	John Pawson	39 - 50 mm (1.1/2"x2")	8 x 104 mm (3/8"x4.1/8")	8 x 96 mm (3/8"x3.3/4")
H 348	David Chipperfield	33 - 55 mm (1.1/4"x2.1/8")	8 x 114 mm (1.1/4"x2.1/8")	
H 356	Zaha Hadid	33 - 55 mm (1.1/4"x2.1/8")	8 x 104 mm (3/8"x4.1/8")	
H 359	SOM - Skidmore, Owings & Merrill	30 - 60 mm (1.1/8"x2.3/8")	8 x 104 mm (3/8"x4.1/8")	
H 361	Antonio Citterio with Toan Nguyen	40 - 60 mm (1.5/8"x2.3/8")	8 x 114 mm (1.1/4"x2.1/8")	8 x 104 mm (3/8"x4.1/8")
H 364	Mario Bellini	40 - 60 mm (1.5/8"x2.3/8")	8 x 114 mm (1.1/4"x2.1/8")	8 x 104 mm (3/8"x4.1/8")
H 367	Giancarlo Vegni	40 - 60 mm (1.5/8"x2.3/8")	8 x 114 mm (1.1/4"x2.1/8")	8 x 104 mm (3/8"x4.1/8")
H 368	Cerri & Associati	40 - 60 mm (1.5/8"x2.3/8")	8 x 114 mm (1.1/4"x2.1/8")	8 x 104 mm (3/8"x4.1/8")
H 370	Doriana e Massimiliano Fuksas	33 - 55 mm (1.1/4"x2.1/8")	8 x 114 mm (1.1/4"x2.1/8")	
H 372	Eri Goshen	38 - 48 mm (1.1/2"x1.7/8")	8 x 104 mm (3/8"x4.1/8")	8 x 96 mm (3/8"x3.3/4")
H 376	Giancarlo Vegni	40 - 60 mm (1.5/8"x2.3/8")	8 x 114 mm (1.1/4"x2.1/8")	8 x 104 mm (3/8"x4.1/8")
H 377	Steve Leung	40 - 60 mm (1.5/8"x2.3/8")	8 x 114 mm (1.1/4"x2.1/8")	8 x 104 mm (3/8"x4.1/8")
H 378	Yabu Pushelberg	32 - 63 mm (1.1/4"x 2.1/2")	8 x 114 mm (1.1/4"x2.1/8")	8 x 104 mm (3/8"x4.1/8")
H 379	Antonio Citterio	33 - 43 mm (1.1/4"x1.3/4")	8 x 96 mm (3/8"x3.3/4")	
H 380	Antonio Citterio	33 - 43 mm (1.1/4"x1.3/4")	8 x 96 mm (3/8"x3.3/4")	
H 381	Khalid Al Najjar	32 - 63 mm (1.1/4"x 2.1/2")	8 x 114 mm (1.1/4"x2.1/8")	
H 382	Joe Cheng	32 - 63 mm (1.1/4"x 2.1/2")	8 x 114 mm (1.1/4"x2.1/8")	
H 383	Perkins&Will	40 - 55 mm (1.5/8"x2.1/8")	8 x 114 mm (1.1/4"x2.1/8")	
H 384	CetraRuddy Architecture D.P.C.	32 - 63 mm (1.1/4"x 2.1/2")	8 x 114 mm (1.1/4"x2.1/8")	
H 385	Federica Biasi	32 - 63 mm (1.1/4"x 2.1/2")	8 x 114 mm (1.1/4"x2.1/8")	
H 386	Meneghello Paoletti	32 - 63 mm (1.1/4"x 2.1/2")	8 x 114 mm (1.1/4"x2.1/8")	
H 411	Leila	30 - 60 mm (1.1/8"x2.3/8")	8 x 114 mm (1.1/4"x2.1/8")	
H 414	Amber	30 - 60 mm (1.1/8"x2.3/8")	8 x 114 mm (1.1/4"x2.1/8")	
H 415	Scarlet	30 - 60 mm (1.1/8"x2.3/8")	8 x 114 mm (1.1/4"x2.1/8")	
H 416	Garnet	30 - 60 mm (1.1/8"x2.3/8")	8 x 114 mm (1.1/4"x2.1/8")	
H 419	Bordeaux	30 - 60 mm (1.1/8"x2.3/8")	8 x 114 mm (1.1/4"x2.1/8")	
H 1003	Matteo Thun	33 - 55 mm (1.1/4"x2.1/8")	8 x 114 mm (1.1/4"x2.1/8")	
H 1004	Antares	37 - 57 mm (1.1/2"x2.1/4")	8 x 96 mm (3/8"x3.3/4")	
H 1016	Nabucco	37 - 57 mm (1.1/2"x2.1/4")	8 x 104 mm (3/8"x4.1/8")	8 x 96 mm (3/8"x3.3/4")
H 1022	Ernani	37 - 55 mm (1.1/2"x2.1/8")	8 x 114 mm (1.1/4"x2.1/8")	8 x 104 mm (3/8"x4.1/8")
H 1024	Lolita	30 - 55 mm (1.1/8"x2.1/8")	8 x 114 mm (1.1/4"x2.1/8")	
H 1026	Antonio Bullo	38 - 48 mm (1.1/2"x1.7/8")	8 x 96 mm (3/8"x3.3/4")	
H 1027	Dafne	33 - 55 mm (1.1/4"x2.1/8")	8 x 114 mm (1.1/4"x2.1/8")	
H 1037	Teseo	38 - 50 mm (1.1/2"x2")	8 x 104 mm (3/8"x4.1/8")	8 x 96 mm
H 1039	Jean-Baptiste Sibertin Blanc	27 - 54 mm (1.1/8"x2.1/8")	8 x 104 mm (3/8"x4.1/8")	

Article	Series	Thickness from / to	1.3/4" with spindle	1.3/8" with spindle
H 1040	Gabriele e Oscar Buratti	32 - 50 mm (1.1/4"x2")	8 x 104 mm (3/8"x4.1/8")	
H 1043	Matteo Thun	35 - 64 mm (1.1/4"x 2.1/2")	8 x 114 mm (1.1/4"x2.1/8")	
H 1044	Vincent Van Duysen	40 - 55 mm (1.5/8"x2.1/8")	8 x 104 mm (3/8"x4.1/8")	8 x 96 mm (3/8"x3.3/4")
H 1044 U	Vincent Van Duysen	40 - 55 mm (1.5/8"x2.1/8")	8 x 104 mm (3/8"x4.1/8")	8 x 96 mm (3/8"x3.3/4")
H 1045	Yoshimi Kono	36 - 62 mm (1.1/2"x 2.1/2")	8 x 114 mm (1.1/4"x2.1/8")	8 x 104 mm (3/8"x4.1/8")
H 1046	Nais	32 - 63 mm (1.1/4"x 2.1/2")	8 x 114 mm (1.1/4"x2.1/8")	
H 1049	Divara	32 - 63 mm (1.1/4"x 2.1/2")	8 x 114 mm (1.1/4"x2.1/8")	
H 1050	Giasone	32 - 63 mm (1.1/4"x 2.1/2")	8 x 114 mm (1.1/4"x2.1/8")	
H 1052	Mikhail Leykin	32 - 63 mm (1.1/4"x 2.1/2")	8 x 114 mm (1.1/4"x2.1/8")	
H 1054	W.W.	32 - 63 mm (1.1/4"x 2.1/2")	8 x 114 mm (1.1/4"x2.1/8")	
H 1056	Quadra	32 - 63 mm (1.1/4"x 2.1/2")	8 x 114 mm (1.1/4"x2.1/8")	
H 1057	Retrò	32 - 63 mm (1.1/4"x 2.1/2")	8 x 114 mm (1.1/4"x2.1/8")	
H 1058	Amica	37 - 52 mm (1.1/2"x2.1/8")	8 x 104 mm (3/8"x4.1/8")	8 x 96 mm (3/8"x3.3/4")
H 1060	SOM - Skidmore, Owings & Merrill	37 - 52 mm (1.1/2"x2.1/8")	8 x 104 mm (3/8"x4.1/8")	
H 1061	Di Virgilio Veneziano	32 - 63 mm (1.1/4"x 2.1/2")	8 x 114 mm (1.1/4"x2.1/8")	
H 1062	Carmen	32 - 63 mm (1.1/4"x 2.1/2")	8 x 114 mm (1.1/4"x2.1/8")	
H 1066	Bertone Design	37 - 52 mm (1.1/2"x2.1/8")	8 x 104 mm (3/8"x4.1/8")	
H 1068	Pembrooke & Ives	32 - 63 mm (1.1/4"x 2.1/2")	8 x 114 mm (1.1/4"x2.1/8")	
H 1069	Susannah	37 - 52 mm (1.1/2"x2.1/8")	8 x 114 mm (1.1/4"x2.1/8")	
H 1748	Estrella	33 - 63 mm (1.1/4"x 2.1/2")	8 x 114 mm (1.1/4"x2.1/8")	
H 4730	White	30 - 60 mm (1.1/8"x2.3/8")	8 x 114 mm (1.1/4"x2.1/8")	
H 4742	Coral	38 - 52 mm (1.1/2"x2.1/8")	8 x 104 mm (3/8"x4.1/8")	8 x 96 mm (3/8"x3.3/4")
H 5008	Taller Design Ricardo Bofill	34 - 50 mm (1.1/4"x2")	8 x 114 mm (1.1/4"x2.1/8")	
H 5014	Bernina	30 - 60 mm (1.1/8"x2.3/8")	8 x 114 mm (1.1/4"x2.1/8")	
H 5015	Antonio Citterio	30 - 60 mm (1.1/8"x2.3/8")	8 x 114 mm (1.1/4"x2.1/8")	
H 5017	Hans Kollhoff	40 - 60 mm (1.5/8"x2.3/8")	8 x 114 mm (1.1/4"x2.1/8")	

**Note:** For the levers on slim rosette, the spindle is 10 mm shorter than what indicated in the list above.

K 377	Steve Leung	40 - 60 mm (1.5/8"x2.3/8")	8 x 114 mm (1.1/4"x2.1/8")	
K 378	Yabu Pushelberg	32 - 63 mm (1.1/4"x 2.1/2")	8 x 114 mm (1.1/4"x2.1/8")	
K 383	Perkins&Will	40 - 60 mm (1.5/8"x2.3/8")	8 x 114 mm (1.1/4"x2.1/8")	
K 1054	W.W.	42 - 54 mm (x1.3/4"x2.1/8")	8 x 96 mm (3/8"x3.3/4")	
K 1056	Quadra	42 - 54 mm (x1.3/4"x2.1/8")	8 x 96 mm (3/8"x3.3/4")	
K 1060	SOM - Skidmore, Owings & Merrill	33 - 45 mm (1.1/4"x1.3/4")	8 x 114 mm (1.1/4"x2.1/8")	
K 1061	Di Virgilio Veneziano	20 - 55 mm (25/32" x 2.5/32")	8 x 114 mm (1.1/4"x2.1/8")	
K 1155		33 - 50 mm (1.1/4"x2")	8 x 114 mm (1.1/4"x2.1/8")	
K 1168	Giasone	42 - 54 mm (x1.3/4"x2.1/8")	8 x 114 mm (1.1/4"x2.1/8")	
K 1170		42 - 54 mm (x1.3/4"x2.1/8")	8 x 114 mm (1.1/4"x2.1/8")	
K 1171		42 - 54 mm (x1.3/4"x2.1/8")	8 x 114 mm (1.1/4"x2.1/8")	
K 1730		33 - 50 mm (1.1/4"x2")	8 x 114 mm (1.1/4"x2.1/8")	
K 5301	Yabu Pushelberg	34 - 50 mm (1.1/4"x2")	8 x 114 mm (1.1/4"x2.1/8")	



# Certifications



**Environmental Management  
according to UNI EN ISO 14001:2015**



**Quality Management according  
to UNI EN ISO 9001:2015**



**European Norm EN 1906:2012  
Product certification**



**Certificate of fire resistant  
and smoke control EN 1634-1:2018**

# General sales terms and conditions

These General Sales Terms and Conditions ("Terms and Conditions") apply to all sales by Valli & Valli (U.S.A.) Inc. ("VALLI") to the buyer ("Buyer") of handles and related accessories distinguished by the trademark "VALLI." ("Product/s"). All orders are accepted subject to these Terms and Conditions. Any terms and/or conditions contained in the Buyer's purchase order or other writing pertaining to such order which are in conflict with or add to or subtract from the following Terms and Conditions shall not become part of any resulting contract unless expressly accepted in writing by VALLI.

## 1. GENERAL INFORMATION

(a) VALLI reserves the right to accept or reject any order for any reason. (b) No order is binding on VALLI until received in writing and approved by VALLI. VALLI agrees to sell and Buyer agrees to buy only in accordance with these Terms and Conditions which are applicable to and binding upon the sale and purchase of every Product sold by VALLI. No departure from these terms and conditions in any respect whatsoever shall be valid except when in writing and signed by an authorized officer of VALLI. Any additions, deletions or other changes to or in an order are subject to the Terms and Conditions stated herein. No salesman or agent of VALLI has the authority to make any changes in VALLI's Terms and Conditions or sale prices.

(c) VALLI shall deliver the Products specified on an order within a reasonable time after acceptance of orders, and shall use reasonable efforts to make timely delivery subject to the ability of VALLI to ship, at the time and in the quantity specified, contingent upon strikes, floods, fires, accidents, labor or material troubles, product availability, or rules and regulations of the United States or any state, municipal or other lawful authority therein or where the Products are manufactured, or other causes beyond the control of VALLI, and VALLI shall not be liable for damages for failure to make partial or complete shipment or for any delay in making shipments. In no event shall the terms of this provision affect Buyer's obligation to pay for goods sold and delivered.

(d) The Buyer may not cancel an order without VALLI's consent. If VALLI is unable to make shipment of specified quantities of its standard Products within thirty (30) days of the specified time and so notifies the Buyer, the Buyer may give notice to VALLI by e-mail confirmed by letter sent registered mail of its intention to cancel that part of the order which remains unshipped at the time of VALLI's receipt of such telefax or within fifteen (15) days after the post-marked date of such letter, whereupon such unshipped part of the order shall be cancelled.

(e) All specifications listed in our Catalog and/or Price List are subject to change without notice including packing, weights, measurements and Product designs.

## 2. PRICES

(a) Prices are quoted, Products are sold, and all shipments are made F.O.B. VALLI's warehouse, unless otherwise specified. All prices are stated in U.S. currency.

(b) Each order, or any part thereof, is subject to billing and payment at VALLI's prices in effect at the time of shipment.

(c) VALLI reserves the right to change any of the prices of an order up to the date of shipment, upon notice to the Buyer. Any orders upon which prices have been changed which are not confirmed by Buyer within fifteen (15) days of notice being sent shall be cancelled.

(d) All prices are subject to additional federal, city and state taxes, if applicable.

(e) Prices, terms and conditions of sale, and trade discounts, if any, are subject to change without prior notice at any time prior to VALLI's acceptance of the Buyer's order.

## 3. TERMS OF PAYMENT

(a) Payment terms are offered to accounts only after a review and approval of VALLI's credit application. Incomplete applications, insufficient references or lack of credit worthiness may result in rejection of application, Prepaid or COD terms only. Payment is not timely unless actually received by VALLI on or before the due date.

(b) A service and carrying charge of one and one half (1-1/2%) percent per month (annual percentage rate eighteen (18%) percent) will be charged on all invoices outstanding more than thirty-five (35) days. Buyer shall pay all costs and expenses (including reasonable attorney's fees) incurred by VALLI in connection with any payments not made when due. VALLI reserves the right to stop confirmed shipments to accounts

which have invoices over sixty (60) days past due.

(c) If Buyer fails to pay an invoice at maturity or defaults on or repudiates this or any other agreement with VALLI, or becomes insolvent or calls a meeting of its creditors or if a bankruptcy, insolvency, re-organization or arrangement proceeding is commenced by or against Buyer, VALLI may (i) cancel this and/or any other contracts with Buyer, and Buyer shall remain liable for any damages to VALLI; or (ii) (a) declare all outstanding invoices under this and/or any other contracts immediately due and payable; (b) defer any shipments hereunder; (c) sell all or part of the undelivered goods at private or public sale, at which VALLI may become buyer; (d) bill at contract price all or any part of the undelivered goods to Buyer, with delivery to Buyer only after full payment is made; and (e) take possession of delivered but unpaid for goods wherever found without process of law.

(d) If, at any time, reasonable grounds for insecurity arise with respect to Buyer's performance of its payment obligations to VALLI. VALLI may demand payment in full for the Products or such financial security which in VALLI's sole discretion shall be equivalent to the sales price of the Products.

## 4. RUSH DELIVERY CHARGES

\$ 30.00 NET AND DROP SHIP CHARGES \$ 5.00

Applies to all orders requested to be shipped within 48 hrs.

## 5. SHIPPING AND FREIGHT ALLOWANCE

VALLI will ship the Products in any manner most satisfactory to VALLI, based upon convenience, experience and cost. Full freight allowed and prepaid to all points in the continental United States on any shipment equal to or in excess of One Thousand (\$1,000.00) Dollars net invoice value by the carrier of VALLI's selection.

No freight allowance on shipments of less than One Thousand (\$1,000.00) Dollars net invoice value. A One (\$1.50) Dollar fifty cent service charge per shipment shall be applied for freight handling and insurance coverage.

## 6. RETURNS

A written request must be received by VALLI within 90 days from the date of the receipt of the order and approved by an authorized officer of VALLI in writing prior to the return of any Products.

Returns must be made within 90 days of RGA approval. Any approved returns shall be delivered at Buyers expense freight prepaid to any point designated by VALLI and a minimum of thirty-five (35%) percent handling charge will apply. A handling fee will be charged on all returned goods. All returned goods must be returned in the original factory sealed cartons and must be in saleable condition.

Merchandise may be returned for credit toward future orders only. Credit must be applied within one (1) year of the date of issuance.

## 7. CLAIMS

Risks of theft, loss or damage to, or destruction of, the Products shall pass to the Buyer when the Products are placed in the possession of the first carrier at VALLI's place of shipment. Claims for damage, loss in transit and delay in delivery must be made to the carrier by the Buyer. All other claims must be reported promptly within fifteen (15) days of receipt of merchandise. Replacement deliveries shall be made or returns accepted only if VALLI's investigation supports the claim. VALLI's liability with respect to substantiated claims shall be limited to either replacing or accepting the return of the Products with refund of the original purchase price.

## 8. LIMITED WARRANTY

Valli warrants to the buyer, that the products shall be free from defects in material or workmanship for a period of one (1) year following the date of the buyer's purchase from valli. This limited warranty is transferable during, and subject to, the above warranty period, only to third parties purchasing the products directly from the buyer. Under penalty of forfeiture, the buyer shall give written notice to valli that some or all of the products do not comply with this limited warranty within 15 business days of delivery (in case of apparent defects), or of latent defects having become apparent (within the warranty period). Valli's sole obligation under this warranty shall be to repair or replace the products which valli determines to be defective and which, after timely notice, are returned to valli with proper documentation during the warranty period, shipping charges prepaid to valli USA, 100 Commerce Way, Suite 2, Hackensack, NJ 07601.

Valli does not assume any warranty responsibility for damages due to conditions over which Valli has no control, including but not limited to improper installation, impact, tampering or abuse. Finishes cannot be guaranteed from tarnishing, excessive wear, or deterioration due to exposure to atmospheric conditions over which Valli has no control.

Valli makes no other warranties, express or implied, with respect to the products delivered, including without limitation, any warranty of merchantability or fitness for a particular purpose. In no event shall Valli be liable for any special, indirect, incidental or consequential damages including, but not limited to, loss of profits or damages to business or business relations. To the extent permitted by law the remedies set forth above are exclusive and in lieu of all other warranties express or implied, statutory or otherwise, and limited to the duration of the warranty period of this express warranty.

Some states do not allow limitation on how long an implied warranty lasts or the exclusion or limitation of incidental or consequential damages so these limitations or exclusions may not apply to the buyer.

This limited warranty gives you the buyer specific legal rights, and buyers qualifying as consumers buying consumer goods for personal use may have also other rights which may vary from state to state.

## 9. LIMITATION OF LIABILITY

Nothing in these terms and conditions shall limit or exclude a party's liability for any matter in respect of which it would be unlawful to exclude or restrict liability.

To the extent permitted by law, Valli shall not be liable toward the buyer, or any other party, whether based in contract, warranty, tort (including negligence), strict liability, indemnity or any other legal or equitable theory, for: any special, indirect, incidental, consequential or punitive damages including, but not limited to, loss of profits, revenue, reputation, opportunity, loss of, or damages to, business or goodwill. Some jurisdictions do not allow the exclusion or limitation of incidental or consequential damages, so these limitations may not apply to buyer. In no event shall Valli's total aggregate liability exceed the actual price paid by buyer for the products under the relevant order or, in case several orders, under the relevant orders of the previous 12 months, provided that in no event shall such Valli's total aggregate liability exceed the amount of \$ 250,000 (two-hundred-fifty-thousand).

## 10. GOVERNING LAWS AND ARBITRATION

Any controversy or claim arising out of or relating to the purchase or sale of VALLI Products shall be construed in accordance with the laws of the State of New York and shall be settled by arbitration in the City, Country and State of New York in accordance with the current Commercial Arbitration Rules of the American Arbitration Association and judgment upon the award rendered may be entered in any court of competent jurisdiction.

## 11. CODE OF CONDUCT

The Buyer, its directors, officers, employees, shall perform their obligations under these Terms and Conditions in full compliance with the ASSA ABLOY Code of Conduct which is accessible online at:

<https://www.assaabloy.com/group/en/sustainability/code-of-conduct>

## 12. SIZES AND DIMENSIONS

Conversion from metric to U.S. measurements is approximate. Refer to Product for exact metric sizing.

## 13. PROJECTS

All project orders require a down payment. Freight FOB New Jersey Warehouse.

## 14. DISCONTINUED

We may discontinue the VALLI Products or alter specifications at any time without prior notification or obligation. Product will continue to be available as long as inventory remains, after which the Product will be discontinued. This program is intended to help our customers anticipate future needs and to avoid bidding or taking orders on parts which may not be available in sufficient quantities when needed.

## 15. INDUSTRY STANDARD

The prevailing industry standard is that the special order items, electrical products and specialty keyed products may not be returned.

## 16. CARE & MAINTENANCE

Door handles and their accessories are designed to open and close doors. They represent a complimentary element of the door, together with the frame, hinges, door panel, lock and cylinder.

Opening and closing a door with a handle requires certain actions, such as opening a security bolt.

Only in certain cases, such as on emergency doors, the handles serves the function of working the lock by lowering or pushing it.

Window handles too are to be considered only a complimentary part of the window. It is normally the opening system of the window that determines the hardware required and consequently the mechanism required for the working of the window handle.

Door handles, pull handles and window handles are often incorrectly used, damaging the Product and the quality standard defined by the producer. Common errors include:

The use of the handle as a support or hook for objects which may be excessively heavy.

The use of the handle as a plaything by children.

The use of the handle as a doorstep against the wall.

VALLI Products do not require excessive maintenance

For care and cleaning, except in those cases where a specific Product is recommended for certain finishes, VALLI recommends the use of just a soft dry cloth.

VALLI discourages the use of sanitizing wipes, or sprays, which may affect the surface of the lever with possible peeling of the external coating, and consequent oxidation.

VALLI also suggests to protect the levers from any liquid or spray product used for mirror/window cleaning. It may result in the damage of the lever surface, especially on polished finishes.

To ensure a correct installation, the instructions contained in the box should be followed.

If necessary consult the retailer or specialized personnel, or the specific "HOW TO" section in the VALLI website.

In the case of Products in glass or porcelain together with brass, it should be remembered that these fragile materials are liable to break if used incorrectly.

VALLI recommends the use of doorstops fixed to the floor or the wall close to the door or its handle.

On all Products with a set screw VALLI recommends the use of a retaining compound. It is also advisable to check the position and tightness of all fixing elements at regular intervals.

The user/purchaser of the Product should ask the retailer for instructions regarding the correct installation, care and maintenance of the Product. VALLI Products are subject to a continual process of development and updating, and Production is constantly monitored by VALLI Quality Assurance.

Most VALLI Products are "tools" for opening and closing doors and windows. Inevitably, as with all artifacts, depending on the material of which they are made and where they are made and where they are used, they are subject to wear and then passing of time.

Brass, an alloy subject to oxidation, has to be covered with a protective coating if its appearance is to remain unchanged over time.

Care should be taken during use and maintenance, as improper use or poor maintenance could damage the protective coating, permitting corrosion and consequently causing an anti-aesthetic appearance.

Stainless steel is generally considered to be indestructible.

However, even this material can show the occasional scratch or spot of rust.

Such rust-spots are so-called "surface ruse", and can be removed using an appropriate cleaner, available from specialized retailers.

The manufacturer cannot be held responsible for damage due to normal wear and tear, incorrect treatment, installation or maintenance or non-observance of the above warnings.

This terms and conditions - version 1/2023 - are published on the website <https://www.vallihandles.com/us/en/documents/general-sales-conditions/valli-us-sales.pdf> in a format which can be saved and printed.



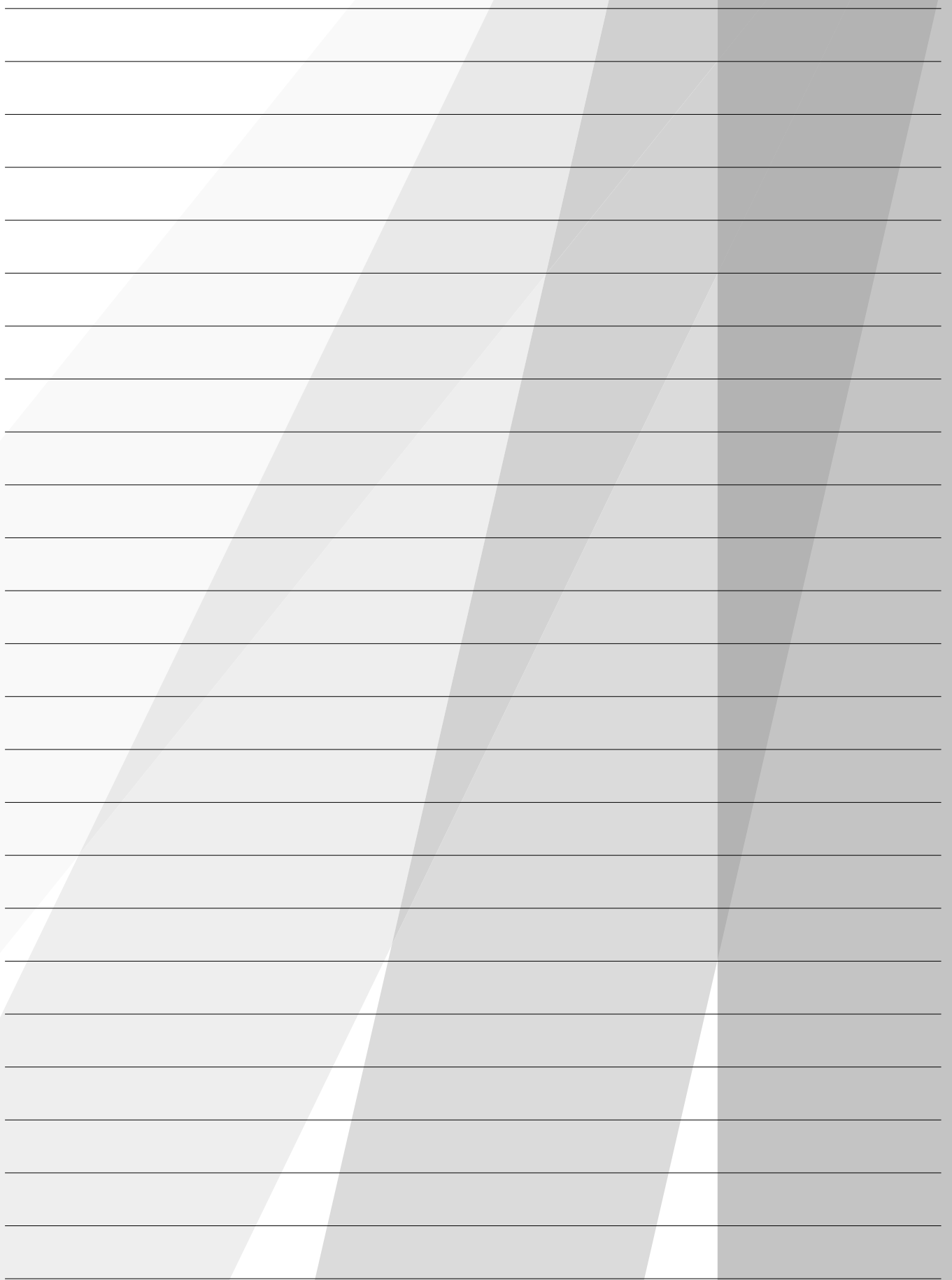

A series of 25 horizontal lines spanning the width of the page, overlaid on a background of diagonal grey bands that create a sense of depth and movement.

**Valli US  
Headquarters and Showroom**

22 West 21st Street, 6th floor  
New York, NY 10010  
Tel (212) 326 8811  
Toll Free (877) 326 2565  
[sales.us@vallihandles.com](mailto:sales.us@vallihandles.com)

**Valli US  
Warehouse**

100 Commerce Way, Suite 2  
Hackensack, NJ 07601  
Tel (973) 249 0085

**Valli Factory  
and Italian offices**

via Concordia, 16  
20838 Renate (MB)  
Italy

**[vallihandles.com/us/en](http://vallihandles.com/us/en)**

This catalogue is constantly updated. We reserve the right to make any changes to the products featured herein or to discontinue them without prior notice. Images, data, measurements, and technical drawings are for information only and are not to be considered binding. Please consult the [vallihandles.com/us/en](http://vallihandles.com/us/en) website for the latest updates on the Valli product range and available finishes. Valli will not be held responsible for any misprints and/or errors in the catalogue.



Z2023 LIST V. US23 MANIG

