

US

# PRODUCT CATALOG 2024

February 1<sup>st</sup>





## General Terms & Conditions of Sale

### CUSTOMERS

Smedbo Inc. only sells and ships to recognized DEALER customers for resale. All Smedbo customers must complete a credit application prior to the shipment of any orders. No sales are made to end-users.

### PRICES

The February 1<sup>st</sup> 2024 price list applies effective February 1<sup>st</sup>, 2024 and all prior corresponding price lists are cancelled. Prices are subject to change without notice. Prices in effect at time of shipment will apply. Items may be discontinued without notice.

### PAYMENT TERMS

Net 30 days from date of shipment and past due thereafter. Accounts past due are subject to a 1.5% monthly charge (18% per annum). Settlement of past due invoices is required before additional shipments will be made. Unless Smedbo has received payment for all products provided by Smedbo, Smedbo shall retain sufficient title to such products so that all such products which remain within the possession or control of the customers shall be subject to being demanded back by Smedbo upon request pursuant to SMEDBO's purchase money security interest in such products.

### FREIGHT

All goods are shipped FOB from the Smedbo facility in Lake Bluff, Illinois. All orders are shipped via United Parcel Service, unless another common carrier is agreed upon in writing. Upon customer request, Smedbo can ship next day, 2nd and 3rd day air. All freight charges, including insurance, will be added to invoice. FFA on all orders over \$200.00 net.

### PROJECT QUOTES

Special discounting may be given for larger construction projects and developments. Contact your local Sales Representative or SMEDBO to obtain a quote.

### DELIVERY

Delivery shall be deemed complete when products have been released to the freight carrier. Ownership of products shall also pass to customer upon delivery to the freight carrier, subject only to being demanded back by Smedbo pursuant to SMEDBO's purchase money security interest in such products (see Payment terms).

### RETURNS

No return merchandise will be accepted without prior written Smedbo authorization and a Smedbo Returned Goods Authorization (RGA) number. Goods returned without such authorization will be refused. All returns to Smedbo will be freight prepaid. No returns will be accepted beyond 60 days from original date of shipment. A credit will be issued for the original amount of the returned items. All returned merchandise will be subject to a 30% handling and restocking charge. If the goods are returned due to defect or a mistake in packaging, no charge will be applied.

### CLAIMS

All claims for damages, apparent or concealed must be made in writing to Smedbo within eight (8) days after receipt of merchandise. Failure to do so shall constitute acceptance of the merchandise and a waiver of any future claims. All goods are packed by Smedbo in approved containers and our responsibility for damage in transit ceases upon acceptance by the freight carrier. If packages are received damaged, please note this on the receipt of the freight carrier before signing. Be sure to save all damaged cartons and packing materials to present to the freight carrier when filing claim. Claims for shortages must be made in writing with documentation and are subject to Smedbo verification.



From SMEDBO, Sweden - Swedish Quality



SIDELINE - Art. No. DV3001S, HOME - Art. No HV359, HV370, HV343P



# CONTENT

## **SMEDBO BATHROOM LINES**

8 - 9	AIR
10 - 11	DOT
12 - 15	HOME
16 - 19	HOUSE
20 - 23	ICE
24 - 26	LIVING
27 - 35	OUTLINE
36 - 39	OUTLINE LITE
40 - 43	POOL
44 - 53	SIDELINE
54 - 57	VILLA
58 - 61	XTRA

## **BESLAGSBODEN**

64 - 66	DRAWER HANDLES
67	TEMPLATE
68 - 69	KNOBS
70 - 75	HOOKS
75 - 77	RACKS
78 - 80	FREE-STANDING PRODUCTS
81	MAKE-UP MIRRORS
82	SELF-ADHESIVE BATHROOM LINE - CUBE
83	SELF-ADHESIVE BATHROOM LINE - PUCK
84 - 89	SELF-ADHESIVE ASSORTMENT
90	ACCESSORIES
91	SHOWER BASKETS, SELF-ADHESIVE
92 - 93	DOOR HARDWARE
94 - 98	HOUSE NUMBERS
99	MAILBOX NUMBERS
100	DISPLAY BOARDS
101	BROCHURES

# SYMBOLS / INFO

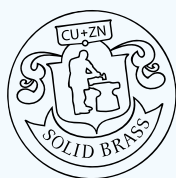

## Products with Solid Brass core

	POLISHED CHROME	BRUSHED CHROME	BRUSHED NICKEL	POLISHED BRASS *	BRUSHED BRASS *	BLACK	WHITE
AIR	●						
HOME	●	●	●		●	●	
HOUSE	●	●		●		●	●
ICE	●						
POOL	●						
VILLA	●			●			
SIDELINE	●	●	●	●	●	●	●
OUTLINE	●				●	●	●

\* Differences in colour shading may occur



## Products with Stainless Steel core

	POLISHED STAINLESS STEEL	BRUSHED STAINLESS STEEL	CHROMED STAINLESS STEEL	BLACK	WHITE
DOT			●	●	
LIVING	●		●		
SIDELINE	●		●		
OUTLINE	●	●			
OUTLINE LITE	●			●	●



All Smedbo bathroom series have a 10-year warranty, except OUTLINE LITE Pedal Bins, which have a 5-year warranty.

# SYMBOLS / INFO



**PMMA** = Polymethyl methacrylate. PMMA belongs to the group of acrylic resin plastics. The material is recyclable. PMMA is sensitive to solvents such as acetone.



**USB** - Rechargeable battery, charge with USB (battery and cord included)



**Battery operated** - Battery operated with 4 pcs, AA battery 1.5 V batteries (not included)



**Sensor Activated Quality Light** - An automatic motion sensor turns on the LED lights when detecting movement at 15 cm distance. Lights are turned off automatically after 12 seconds without movement.



**Dual Light** - Warm or cool light



**"easy to remove and clean"**. It is easy to remove the shower basket from the wall and clean it.



**Note that the surface to be glued** must be well cleaned and dry and that the self-adhesive glue must be allowed to harden for 24 hours before using the product.











**Self-adhesive products** are NOT recommended to be installed on wet room wallpaper as plasticizers in the wet room wallpaper adversely affect the adhesive and the product can detach from the wall.

Smedbo products should only be cleaned with a soft cloth and a mild soapy solution. Do not polish.



Article No.	Bath Accessories in Solid Brass	Sug. Ret. \$ EA
AK320	<b>Spare Toilet Roll Holder</b> Height 6 3/4" Polished Chrome	111.00
AK323	<b>Holder for Hairdryer and Straightener</b> 4 3/4" W x 4" D x 3/4" H Polished Chrome	130.00
AK325	<b>Grab Bar</b> Total Length 11 7/8". Diameter 1" Polished Chrome	218.00
AK326	<b>Swing Arm Towel Rail</b> Length 17" Polished Chrome	203.00
AK327	<b>Swing Arm Triple Hook</b> Length 5" Height 3 3/4" Polished Chrome	148.00
AK333 * H233N H234N N334	<b>Toilet Brush incl. Container</b> Height 15" Wall mounted Polished Chrome/Frosted Glass <i>Spare Brush Black</i> <i>Spare Brush White</i> <i>Spare Frosted Glass Container</i>	224.00 48.00 48.00 106.00
AK3364	<b>Double Towel Rail</b> Length 24". cc 21 3/4" Polished Chrome	275.00
AK341	<b>Toilet Roll Holder</b> Polished Chrome	130.00
AK3414	<b>Toilet Roll Holder with Cover</b> Polished Chrome	164.00
AK3411	<b>Toilet Roll Holder</b> Polished Chrome	143.00

Article No.	Bath Accessories in Solid Brass	Sug. Ret. \$ EA
 AK342 * L348	<b>Holder with Soap Dish</b> Polished Chrome/Frosted Glass <i>Spare Frosted Glass Soap Dish</i>	141.00 44.00
 AK343 L349	<b>Holder with Tumbler</b> Polished Chrome/Frosted Glass <i>Spare Frosted Glass Tumbler</i>	148.00 44.00
 AK344	<b>Towel Ring</b> 8" x 6 3/4" Polished Chrome	164.00
 AK3455	<b>Multi-purpose Hook. Pair</b> Depth 1 1/2". Diameter 3/4" Polished Chrome	69.00
 AK3464	<b>Single Towel Rail</b> Length 24". cc 21 3/4" Polished Chrome	218.00
 AK347 * P350	<b>Glass Shelf</b> Length 24" Polished Chrome <i>Spare Frosted Glass Shelf</i>	208.00 77.00
 AK355	<b>Towel Hook</b> Height 1 7/8" Polished Chrome	69.00
 AK369 H351	<b>Holder with Glass Soap Dispenser</b> Pumphead of Solid Brass Height 7" Volume 200 ml Wall mounted Polished Chrome <i>Spare Frosted Glass Soap Container</i>	235.00 111.00
 AK374 *	<b>Soap Basket</b> 10" W x 4" D Height 2 1/2" Polished Chrome	156.00



\* Discontinued during 2024



Article No.	Bath Accessories in Stainless Steel	Sug. Ret. \$ EA
-------------	-------------------------------------	-----------------

**Toilet Brush incl. Container  
Self-adhesive**

Height 17"  
Wall mounted

TB332	Black	235.00
TK332	Polished Chrome	215.00
H233N	Spare Brush Black	48.00
H234N	Spare Brush White	48.00



**Toilet Roll Holder  
Self-adhesive**

Length 5.5"

TB3411	Black	86.00
TK3411	Polished Chrome	79.00



**Toilet Roll Holder  
Self-adhesive**

TB341	Black	81.00
TK341	Polished Chrome	79.00



**Toilet Roll Holder with Cover  
Self-adhesive**

TB3414	Black	117.00
TK3414	Polished Chrome	106.00



**Towel Ring  
Self-adhesive**

8" x 4.5"

TB344	Black	99.00
TK344	Polished Chrome	90.00



Article No.	Bath Accessories in Stainless Steel	Sug. Ret. \$ EA
	<b>Towel Hook, Pair Self-adhesive</b> Diameter 1.5"	
TB3455	Black	36.00
TK3455	Polished Chrome	36.00



	<b>Towel Hook Self-adhesive</b> Diameter 1.75"	
TB355	Black	76.00
TK355	Polished Chrome	63.00



	<b>Double Towel Hook Self-adhesive</b> Length 5"	
TB356	Black	78.00
TK356	Polished Chrome	75.00



	<b>Triple Hook Self-adhesive</b> Length 7.5"	
TB359	Black	118.00
TK359	Polished Chrome	113.00



	<b>Holder with Soap Dispenser Self-adhesive</b> Height 4.25" Volume 200 ml Wall mounted	
TB361	Black/Black container	207.00
TK361	Polished Chrome/White container	189.00



	<b>Single Towel Rail Self-adhesive</b> Length 24.5"	
TB3464	Black	161.00
TK3464	Polished Chrome	145.00

Article No.	Bath Accessories in Solid Brass	Sug. Ret. \$ EA
		
	<b>Spare Toilet Roll Holder</b> Height 5"	
HB320	Black	100.00
HK320	Polished Chrome	90.00
HS320	Brushed Chrome	105.00
HV320	Brushed Brass	116.00
H320N	Brushed Nickel	105.00
		
	<b>Holder for Hairdryer</b> Height 6" Diameter 3 1/2"/2 1/2"	
HK323	Polished Chrome	118.00
HS323 *	Brushed Chrome	124.00
		
	<b>Holder for Hairdryer and Straightener</b> Height 5"	
HK3231	Polished Chrome	123.00
HS3231	Brushed Chrome	125.00
		
	<b>Grab Bar</b> Total Length 11 1/4" Diameter 1"	
HK325	Polished Chrome	191.00
H325N	Brushed Nickel	213.00
		
	<b>Swing Arm Towel Rail</b> Length 17 1/2"	
HK326	Polished Chrome	152.00
HS326	Brushed Chrome	172.00
		
	<b>Swing Arm Triple Hook</b> Height 3 1/2"	
HK327	Polished Chrome	145.00
HS327	Brushed Chrome	152.00
		
	<b>Fixed Towel Rail</b> Length 16 1/2"	
HK328	Polished Chrome	130.00
HS328	Brushed Chrome	138.00
		
	<b>Toilet Brush</b> Height 15 3/8" Wall mounted	
HB332	Black/Plastic insert	312.00
HK332	Polished Chrome/Plastic insert	284.00
HS332	Brushed Chrome/Plastic insert	299.00
HV332	Brushed Brass	364.00
H332N	Brushed Nickel	312.00
H233N	Spare Brush Black	48.00
H234N	Spare Brush White	48.00

Article No.	Bath Accessories in Solid Brass	Sug. Ret. \$ EA
<b>Toilet Brush incl. Container</b>		
Height 15"		
Wall mounted		
HK333	Polished Chrome/Frosted Glass	168.00
HS333	Brushed Chrome/Frosted Glass	191.00
H233N	Spare Brush Black	48.00
H234N	Spare Brush White	48.00
N334	Spare Frosted Glass Container	106.00
<b>Toilet Brush incl. Container</b>		
Height 15"		
Wall mounted		
HB333P	Black/Porcelain	244.00
HK333P	Polished Chrome/Porcelain	221.00
HV333P	Brushed Brass/Porcelain	283.00
H233N	Spare Brush Black	48.00
H234N	Spare Brush White	48.00
O334	Spare Porcelain Container	123.00
<b>Double Towel Rail</b>		
Length 25 1/2". cc 24"		
HB3364	Black	258.00
HK3364	Polished Chrome	234.00
HS3364	Brushed Chrome	257.00
HV3364	Brushed Brass	301.00
<b>Toilet Roll Holder</b>		
HB341	Black	100.00
HK341	Polished Chrome	90.00
HS341	Brushed Chrome	101.00
HV341	Brushed Brass	116.00
H341N	Brushed Nickel	101.00
<b>Toilet Roll Holder</b>		
HB3411	Black	111.00
HK3411	Polished Chrome	102.00
HS3411	Brushed Chrome	110.00
HV3411	Brushed Brass	130.00
H3411N	Brushed Nickel	112.00
<b>Toilet Roll Holder with Cover</b>		
HK3414	Polished Chrome	130.00
HS3414	Brushed Chrome	144.00
<b>Holder with Soap Dish</b>		
HK342	Polished Chrome/Frosted Glass	90.00
HS342 *	Brushed Chrome/Frosted Glass	96.00
H342N	Brushed Nickel/Frosted Glass	101.00
L348	Spare Frosted Glass Soap Dish	44.00
<b>Holder with Soap Dish</b>		
HB342P	Black/Porcelain	141.00
HK342P	Polished Chrome/Porcelain	110.00
HV342P	Brushed Brass/Porcelain	61.00
O348	Spare Porcelain Soap Dish	50.00

\* Discontinued during 2024

Article No.	Bath Accessories in Solid Brass	Sug. Ret. \$ EA
	<b>Holder with Tumbler</b>	
HK343	Polished Chrome/Frosted Glass	90.00
HS343	Brushed Chrome/Frosted Glass	101.00
H343N	Brushed Nickel/Frosted Glass	101.00
L349	<i>Spare Frosted Glass Tumbler</i>	46.00
	<b>Holder with Tumbler</b>	
HB343P	Black/Porcelain	122.00
HK343P	Polished Chrome/Porcelain	110.00
HV343P	Brushed Brass/Porcelain	141.00
O349	<i>Spare Porcelain Tumbler</i>	50.00
	<b>Towel Ring</b>	
	Diameter 6 3/4"	
HB344	Black	117.00
HK344	Polished Chrome	106.00
HS344	Brushed Chrome	118.00
HV344	Brushed Brass	141.00
H344N	Brushed Nickel	118.00
	<b>Multi-purpose Hook. Pair</b>	
	Depth 1". Diameter 3/4"	
HB3455	Black	55.00
HK3455	Polished Chrome	50.00
HS3455	Brushed Chrome	53.00
HV3455	Brushed Brass	64.00
H3455N	Brushed Nickel	57.00
	<b>Single Towel Rail</b>	
	Length 25 1/2". cc 24"	
HB3464	Black	187.00
HK3464	Polished Chrome	170.00
HS3464	Brushed Chrome	191.00
HV3464	Brushed Brass	218.00
H3464N	Brushed Nickel	191.00
	<b>Glass Shelf</b>	
	Length 24"	
HK347	Polished Chrome/Frosted Glass	170.00
HS347 *	Brushed Chrome/Frosted Glass	182.00
H347N	Brushed Nickel/Frosted Glass	191.00
H350	<i>Spare Frosted Glass Shelf</i>	78.00
	<b>Towel Hook</b>	
	Diameter 1 7/8"	
HB355	Black	66.00
HK355	Polished Chrome	61.00
HS355	Brushed Chrome	69.00
HV355	Brushed Brass	78.00
H355N	Brushed Nickel	69.00
	<b>Double Towel Hook</b>	
	Length 3 1/2"	
HB356	Black	100.00
HK356	Polished Chrome	90.00
HS356	Brushed Chrome	101.00
HV356	Brushed Brass	116.00
H356N	Brushed Nickel	101.00











Article No.	Bath Accessories in Solid Brass	Sug. Ret. \$ EA
	<b>Bath Robe Hook</b> Height 5 1/3"	
HK358	Polished Chrome	101.00
HS358	Brushed Chrome	109.00
H358N	Brushed Nickel	109.00
	<b>Quadruple Hook</b> Length 7"	
HB359	Black	143.00
HK359	Polished Chrome	130.00
HS359	Brushed Chrome	140.00
HV359	Brushed Brass	167.00
	<b>Holder with Glass Soap Pump</b> Pumphead of Solid Brass Height 4 3/4" Volume 150 ml Wall mounted	
HB361	Black/Frosted Glass	414.00
HK361	Polished Chrome/Frosted Glass	376.00
HV361	Brushed Brass/Frosted Glass	283.00
	<b>Holder with Glass Soap Pump</b> Pumphead of Solid Brass Height 7" Volume 200 ml Wall mounted	
HK369	Polished Chrome/Frosted Glass	168.00
HS369	Brushed Chrome/Frosted Glass	191.00
H369N	Brushed Nickel/Frosted Glass	191.00
H351	<i>Spare Frosted Glass Soap Container</i>	111.00
	<b>Holder with Porcelain Pump</b> Pumphead of Solid Brass Height 7" Volume 200 ml Wall mounted	
HB369P	Black/Porcelain	243.00
HK369P	Polished Chrome/Porcelain	221.00
HV369P	Brushed Brass/Porcelain	119.00
O351	<i>Spare Porcelain Soap Container</i>	123.00
	<b>Soap Dispenser</b> Pumphead of Solid Brass Height 6 1/4" Volume 150 ml Wall mounted	
HB370	Black	258.00
HK370	Polished Chrome	234.00
HS370	Brushed Chrome	237.00
HV370	Brushed Brass	301.00
H370N	Brushed Nickel	258.00
	<b>Corner Soap Basket, Double</b> 8 1/8" x 8 1/8" Height 11 5/8"	
HS377 *	Brushed Chrome	223.00

\* Discontinued during 2024

Article No.	Bath Accessories in Solid Brass	Sug. Ret. \$ EA
<b>Spare Toilet Roll Holder</b>		
	Height 5"	
RB320	Black	110.00
RK320	Polished Chrome	100.00
RS320	Brushed Chrome	105.00
RV320	Polished Brass	105.00
RX320	White	110.00
<b>Holder for Hairdryer</b>		
	Height 6"	
	Diameter 3 1/2"/2 1/2"	
RK323 *	Polished Chrome	124.00
RS323 *	Brushed Chrome	131.00
<b>Holder for Hairdryer and Straightener</b>		
	Length 5"	
RK3231	Polished Chrome	125.00
<b>Grab Bar</b>		
	Total Length 11 1/4"	
	Diameter 1"	
RK325	Polished Chrome	216.00
RS325 *	Brushed Chrome	218.00
<b>Swing Arm Towel Rail</b>		
	Length 17 1/2"	
RK326	Polished Chrome	173.00
RS326 *	Brushed Chrome	185.00
<b>Swing Arm Triple Hook</b>		
	Height 3 1/2"	
RK327	Polished Chrome	164.00
RS327 *	Brushed Chrome	166.00
<b>Fixed Towel Rail</b>		
	Length 16 1/2"	
RK328	Polished Chrome	145.00
RS328 *	Brushed Chrome	149.00
<b>Toilet Brush</b>		
	Height 15 3/8"	
	Wall mounted	
RB332	Black/Plastic insert	352.00
RK332	Polished Chrome/Plastic insert	301.00
RX332	White/Plastic insert	352.00
H233N	Spare Brush Black	48.00
H234N	Spare Brush White	48.00

	Article No.	Bath Accessories in Solid Brass	Sug. Ret. \$ EA
		<b>Toilet Brush incl. Container</b> Height 15" Wall mounted	
	RK333	Polished Chrome/Frosted Glass	194.00
	RS333 *	Brushed Chrome/Frosted Glass	193.00
	RX333	White/Frosted Glass	213.00
	H233N	Spare Brush Black	48.00
	H234N	Spare Brush White	48.00
	N334	Spare Frosted Glass Container	106.00
		<b>Toilet Brush incl. Container</b> Height 15" Wall mounted	
	RB333P	Black/Porcelain	227.00
	RK333P	Polished Chrome/Porcelain	238.00
	RV333P	Polished Brass/Porcelain	227.00
	H233N	Spare Brush Black	48.00
	H234N	Spare Brush White	48.00
	O334	Spare Porcelain Container	123.00
		<b>Double Towel Rail</b> Length 25 1/2", cc 24"	
	RB3364	Black	266.00
	RK3364	Polished Chrome	242.00
		<b>Toilet Roll Holder</b>	
	RB341	Black	106.00
	RK341	Polished Chrome	100.00
	RS341 *	Brushed Chrome	101.00
	RV341	Polished Brass	105.00
	RX341	White	106.00
		<b>Toilet Roll Holder</b>	
	RB3411	Black	121.00
	RK3411	Polished Chrome	110.00
	RS3411 *	Brushed Chrome	116.00
		<b>Toilet Roll Holder with Cover</b>	
	RK3414	Polished Chrome	140.00
	RS3414 *	Brushed Chrome	145.00
		<b>Holder with Soap Dish</b>	
	RK342	Polished Chrome/Frosted Glass	100.00
	RS342 *	Brushed Chrome/Frosted Glass	101.00
	RX342	White/Frosted Glass	109.00
	L348	Spare Frosted Glass Soap Dish	44.00
		<b>Holder with Soap Dish</b>	
	RB342P	Black/Porcelain	113.00
	RK342P	Polished Chrome/Porcelain	126.00
	RV342P	Polished Brass/Porcelain	113.00
	O348	Spare Porcelain Soap Dish	50.00

\* Discontinued during 2024







Article No.	Bath Accessories in Solid Brass	Sug. Ret. \$ EA
	<b>Holder with Tumbler</b>	
RK343	Polished Chrome/Frosted Glass	100.00
RS343 *	Brushed Chrome/Frosted Glass	101.00
RX343	White/Frosted Glass	109.00
L349	<i>Spare Frosted Glass Tumbler</i>	44.00
	<b>Holder with Tumbler</b>	
RB343P	Black/Porcelain	113.00
RK343P	Polished Chrome/Porcelain	126.00
RV343P	Polished Brass/Porcelain	113.00
O349	<i>Spare Porcelain Tumbler</i>	50.00
	<b>Towel Ring</b>	
	Diameter 6 <sup>3</sup> / <sub>4</sub> "	
RB344	Black	133.00
RK344	Polished Chrome	118.00
RS344 *	Brushed Chrome	127.00
RV344	Polished Brass	125.00
RX344	White	133.00
	<b>Multi-purpose Hook. Pair</b>	
	Depth 1". Diameter <sup>3</sup> / <sub>4</sub> "	
RB3455	Black	53.00
RK3455	Polished Chrome	50.00
RS3455 *	Brushed Chrome	50.00
RV3455	Polished Brass	50.00
RX3455	White	53.00
	<b>Single Towel Rail</b>	
	Length 25 <sup>1</sup> / <sub>2</sub> ". cc 24"	
RB3464	Black	209.00
RK3464	Polished Chrome	194.00
RS3464 *	Brushed Chrome	199.00
RV3464	Polished Brass	206.00
RX3464	White	209.00
	<b>Glass Shelf</b>	
	Length 24"	
RK347	Polished Chrome/Frosted Glass	194.00
RS347 *	Brushed Chrome/Frosted Glass	199.00
H350	<i>Spare Frosted Glass Shelf</i>	78.00
	<b>Towel Hook</b>	
	1 <sup>7</sup> / <sub>8</sub> " x 1 <sup>7</sup> / <sub>8</sub> "	
RB355	Black	76.00
RK355	Polished Chrome	63.00
RS355 *	Brushed Chrome	72.00
RV355	Polished Brass	74.00
RX355	White	76.00
	<b>Double Towel Hook</b>	
	Length 3 <sup>1</sup> / <sub>2</sub> "	
RB356	Black	106.00
RK356	Polished Chrome	100.00
RS356 *	Brushed Chrome	101.00
RV356	Polished Brass	101.00
RX356	White	106.00



Article No.	Bath Accessories in Solid Brass	Sug. Ret. \$ EA
	<b>Bath Robe Hook</b> Height 5 1/3"	
RK358	Polished Chrome	110.00
RS358 *	Brushed Chrome	116.00
	<b>Quadruple Hook</b> Length 7"	
RB359	Black	160.00
RK359	Polished Chrome	144.00
RS359 *	Brushed Chrome	152.00
RV359	Polished Brass	152.00
RX359	White	160.00
	<b>Holder with Glass Soap Pump</b> Pumphead of Solid Brass Height 4 3/4" Volume 150 ml Wall mounted	
RB361	Black/Frosted Glass	437.00
RK361	Polished Chrome/Frosted Glass	349.00
	<b>Holder with Glass Soap Pump</b> Pumphead of Solid Brass Height 7" Volume 200 ml Wall mounted	
RK369	Polished Chrome/Frosted Glass	194.00
RS369 *	Brushed Chrome/Frosted Glass	199.00
RX369	White	213.00
H351	<i>Spare Frosted Glass Soap Container</i>	111.00
	<b>Holder with Glass Soap Pump</b> Pumphead of Solid Brass Height 7" Volume 200 ml Wall mounted	
RB369P	Black/Porcelain	227.00
RK369P	Polished Chrome/Porcelain	239.00
RV369P	Polished Brass/Porcelain	227.00
O351	<i>Spare Porcelain Soap Container</i>	123.00
	<b>Soap Dispenser</b> Pumphead of Solid Brass Height 6 1/4" Volume 150 ml Wall mounted	
RB370	Black	287.00
RK370	Polished Chrome	237.00
RS370 *	Brushed Chrome	246.00
RX370	White	287.00
	<b>Corner Soap Basket, Double</b> 8 1/8" x 8 1/8" Height 11 5/8"	
RK377 *	Polished Chrome	203.00
RS377 *	Brushed Chrome	223.00







\* Discontinued during 2024

Article No.	Bath Accessories in Solid Brass	Sug. Ret. \$ EA
OK320	 <p><b>Spare Toilet Roll Holder</b> Height 6" Polished Chrome</p>	104.00
OK323	 <p><b>Holder for Hairdryer and Straightener</b> Height 3/4" backplate Length 5" Depth 3 1/2" Polished Chrome</p>	123.00
OK325 *	 <p><b>Grab Bar</b> Total Length 10 5/8" Diameter 1" Polished Chrome</p>	226.00
OK326	 <p><b>Swing Arm Towel Rail</b> Length 16" Polished Chrome</p>	182.00
OK327	 <p><b>Swing Arm Triple Hook</b> Length 4 3/8" Height 3" Polished Chrome</p>	160.00
OK333P H233N H234N O334	 <p><b>Toilet Brush incl. Container</b> Height 15" Wall mounted Polished Chrome/Porcelain <i>Spare Brush Black</i> <i>Spare Brush White</i> <i>Spare Porcelain Container</i></p>	235.00 48.00 48.00 123.00

Article No.	Bath Accessories in Solid Brass	Sug. Ret. \$ EA
OK341	 <b>Toilet Roll Holder</b> Polished Chrome	106.00
OK3411	 <b>Toilet Roll Holder</b> Polished Chrome	106.00
OK3414	 <b>Toilet Roll Holder with Cover</b> Polished Chrome	150.00
OK342P O348	 <b>Holder with Soap Dish</b> Polished Chrome/Porcelain <i>Spare Porcelain Soap Dish</i>	114.00 50.00
OK343P O349	 <b>Holder with Tumbler</b> Polished Chrome/Porcelain <i>Spare Porcelain Tumbler</i>	114.00 50.00
OK344	 <b>Towel Ring</b> Length 7 <sup>7</sup> / <sub>8</sub> " Polished Chrome	126.00
OK3455	 <b>Multi-purpose Hook. Pair</b> Depth 1" Diameter <sup>3</sup> / <sub>4</sub> " Polished Chrome	53.00

	Article No.	Bath Accessories in Solid Brass	Sug. Ret. \$ EA
	OK3464	<b>Single Towel Rail</b> Length 25 <sup>4</sup> / <sub>5</sub> ". cc 24" Polished Chrome	206.00
	OK3465	<b>Single Towel Rail</b> Length 33 <sup>1</sup> / <sub>4</sub> ". cc 31 <sup>1</sup> / <sub>2</sub> " Polished Chrome	253.00
	OK347 * O350 *	<b>Glass Shelf</b> Length 24" Polished Chrome/Frosted Glass <i>Spare Frosted Glass Shelf</i>	196.00 95.00
	OK355	<b>Towel Hook</b> 1 <sup>7</sup> / <sub>8</sub> " x 1 <sup>7</sup> / <sub>8</sub> " Polished Chrome	69.00
	OK356	<b>Double Towel Hook</b> Length 3 <sup>1</sup> / <sub>2</sub> " Polished Chrome	106.00
	OK358	<b>Bath Robe Hook</b> Height 5 <sup>1</sup> / <sub>8</sub> " Polished Chrome	118.00
	OK359	<b>Quadruple Hook</b> Length 6 <sup>7</sup> / <sub>8</sub> " Polished Chrome	156.00
	OK369P O351	<b>Holder with Soap Dispenser</b> Pumphead of Solid Brass Height 7" Volume 200 ml Wall mounted Polished Chrome/Porcelain <i>Spare Porcelain Soap Container</i>	235.00 123.00
	OK374 *	<b>Corner Soap Basket</b> 7 <sup>7</sup> / <sub>8</sub> " x 7 <sup>7</sup> / <sub>8</sub> " Height 2 <sup>3</sup> / <sub>4</sub> " Polished Chrome	212.00

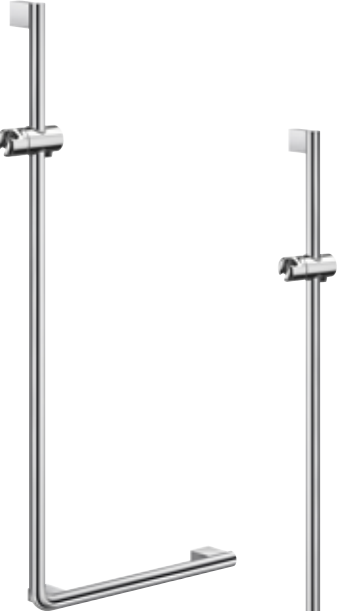
Article No.	Bath Accessories in Solid Brass	Sug. Ret. \$ EA
	<p><b>Toilet Brush incl. Container</b>                      Height 15"                      Wall mounted                      Polished Chrome/Porcelain</p>	355.00
	<p><b>Holder with Soap Dish</b>                      Polished Chrome/Porcelain</p>	179.00
	<p><b>Holder with Tumbler</b>                      Polished Chrome/Porcelain</p>	179.00
	<p><b>Holder with Soap Dispenser</b>                      Pumphead of Solid Brass                      Height 4 1/2"                      Volume 200 ml                      Wall mounted                      Polished Chrome/Porcelain</p>	454.00
	<p><b>Holder with Soap Dispenser</b>                      Pumphead of Solid Brass                      Height 7"                      Volume 350 ml                      Wall mounted                      Polished Chrome/Porcelain</p>	260.00
	<p><b>Soap Dispenser</b>                      Pumphead of Solid Brass                      Height 7"                      Volume 350 ml                      Free Standing                      Polished Chrome/Porcelain</p>	176.00

Article No.	Bath Accessories in Stainless Steel/Zinc	Sug. Ret. \$ EA
FK810	 <p><b>Single Grab Bar</b> Total Length 16" Diameter 1" Chromed</p>	198.00
FK811	 <p><b>Double Grab Bar</b> Total Length 35 1/2" Diameter 1" Chromed</p>	350.00
FK812	 <p><b>Grab Bar, V-shape, Left</b> 16" x 16" Diameter 1" Chromed</p>	350.00
FK813	 <p><b>Grab Bar, V-shape, Right</b> 16" x 16" Diameter 1" Chromed</p>	351.00
FK815	 <p><b>Grab Bar, Corner</b> 28 3/4" x 28 3/4" Diameter 1" Chromed</p>	442.00
FK814	 <p><b>Shower Bar, L-shape, Left</b> 48 1/2" x 21" Diameter 1" Chromed</p>	541.00
FK816	 <p><b>Shower Bar, L-shape, Right</b> 48 1/2" x 21" Diameter 1" Chromed</p>	541.00
FK817	 <p><b>Grab Bar, T-connection</b> Height 4" Diameter 1" Chromed</p>	279.00

Article No.	Bath Accessories in Stainless Steel/Zinc	Sug. Ret. \$ EA
FK820	<b>Fixing Point, Short</b> Length 15 3/4", Diameter 1" Chromed	134.00
FK821	<b>Fixing Point, Long</b> Length 23 1/2", Diameter 1" Chromed	183.00
FK830	<b>Connection, T-shape</b> Length 4", Diameter 1" Chromed	85.00
FK831	<b>Connection, L-shape, Right</b> 5" x 5", Diameter 1" Chromed	106.00
FK833	<b>Connection, L-shape, Left</b> 5" x 5", Diameter 1" Chromed	106.00
FK832	<b>Connection, Corner</b> 5" x 5", Diameter 1" Chromed	106.00
FK834	<b>Fixing Point, End-part</b> Length 4", Diameter 1" Chromed	45.00
FK835	<b>Connection Bar</b> Length 15 3/4", Diameter 1" Chromed	85.00
FK851	<b>Hook for LIVING Grab Bar</b> Height 3.25" Diameter 1" Polished Chrome	96.00
FK855	<b>Toilet Roll Holder for LIVING Grab Bar</b> Length 5" Diameter 1" Polished Chrome	116.00
FK850	<b>Bathroom Shelf for LIVING Grab Bar</b> Length 14.25" Depth 2.25" Polished Chrome	163.00
FK856	<b>Shower Basket for Shower Bar</b> 10" x 4" Fits Bar Diameter 1" Polished Chrome	235.00



Article No.	Bath Accessories in Stainless Steel	Sug. Ret. \$ EA
FK806	<b>Grab Bar. Short</b> Total Length 12" Diameter 1" Polished Stainless Steel	187.00
FK807	<b>Grab Bar. Long</b> Total Length 24" Diameter 1" Polished Stainless Steel	225.00
FK808	<b>Grab Bar, Long V-form 135°</b> Total Length 19 1/2" Diameter 1" Polished Stainless Steel	225.00
FK404	<b>Folding Wall mounted shower seat</b> Seat 14 5/8" x 12 1/2" Zinc Chromed/Aluminium White seat	642.00
FK414	Dark grey seat	642.00
FK406	<b>Shower Chair</b> Stain Resistant Anti-Bacterial Composite Seat Total Height 19" Polished Chrome on aluminium/ White Seat in polypropylene	673.00
FK416	Polished Chrome on aluminium/ Dark grey Seat in polypropylene	673.00
FB407	<b>Shower Chair</b> Plexi Glass Total Height 17.25" Matt Black	330.00
FX407	Shiny White	330.00
FK840	<b>Hinged Grab Bar</b> Length 27.5" Wall Plate 4" x 9" Chromed Stainless Steel	895.00
FK841	<b>Foot Rest for Corner</b> Length 11 1/2" Diameter 1" Chromed Steel/Non-slip surface	133.00





Article No.	Bath Accessories in Solid Brass	Sug. Ret. \$ EA
	<b>Toilet Brush</b>	
	Height 16"	
	Frosted Glass inset in lid	
	Free Standing	
FK103 *	Polished Chrome/Plastic insert	258.00
H233N	Spare Brush Black	48.00
H234N	Spare Brush White	48.00
	<b>Soap Dispenser</b>	
	Pumphead of Solid Brass	
	Height 7 1/2"	
	Volume 180 ml	
	Free Standing	
FK254	Polished Chrome/Plastic insert	172.00
	<b>Cabinet Towel Bar</b>	
	Length 13 3/4"	
	Mounted with screws from the inside of the cabinet	
	Polished Chrome	
FK210		160.00
	<b>Guest Towel Rail/Towel Rail</b>	
	Length 16"	
	Can be mounted vertically or horizontally	
	Wall mount	
	Polished Chrome	
FK300		153.00
	<b>Towel Rail</b>	
	Length 15"	
	Wall mount	
FB211	Matte Black	156.00
FK211	Polished Chrome	143.00
	<b>Double Towel Rail</b>	
	Length 15"	
	Wall mount	
FB212	Matte Black	237.00
FK212	Polished Chrome	228.00
	<b>Towel Rail. Free Standing</b>	
	Height 35"	
	Length 24"	
	Depth 10"	
FK309	Polished Chrome	675.00

Article No.	Bath Accessories in Solid Brass	Sug. Ret. \$ EA
	<p><b>Soap Dispenser</b>                      Pumphead of Solid Brass                      Height 8 1/2"                      Holder in Chrome 2 1/2" x 2 1/2"                      Container holds 250 ml                      Wall mounted                      Polished Chrome</p>	216.00
	<p><b>Soap Dispenser with 2 Containers</b>                      Pumphead of Solid Brass                      Height 8 1/2"                      Holder in Chrome 4 1/5" x 2 1/2"                      Each container holds 250 ml                      Wall mounted                      Polished Chrome</p>	309.00
	<p><b>Soap Dispenser with 3 Containers</b>                      Pumphead of Solid Brass                      Height 8 1/2"                      Holder in Chrome 6 3/5" x 2 1/2"                      Each container holds 250 ml                      Wall mounted                      Polished Chrome</p>	412.00
	<p><b>Soap Dispenser</b>                      Height 6.5"                      Volume 300 ml                      Wall mounted                      Polished Chrome</p>	399.00
	<p><b>Retractable Clothes Line</b>                      Diameter 3 1/2"                      Rope Length 8 ft                      Max load 6 lbs                      Polished Chrome</p>	130.00
	<p><b>Toilet Roll Holder with Shelf</b>                      Shelf 3.75" x 6.75"                      Total Length 10.5"                      Wall mounted                      Matte Black                      Polished Chrome</p>	178.00 162.00

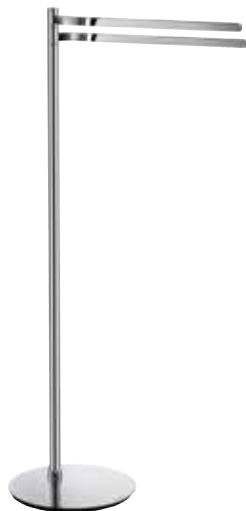

Article No.	Bath Accessories in Solid Brass	Sug. Ret. \$ EA
-------------	---------------------------------	-----------------

**Toilet Brush incl. Container**

	Round	
	Height 16"	
FK311P	Polished Chrome/Porcelain	229.00
FK311	Polished Chrome/Frosted Glass	195.00
H233N	Spare Brush Black	48.00
H234N	Spare Brush White	48.00
N334	Spare Frosted Glass Container	106.00
O334	Spare Porcelain Container	123.00

**Toilet Roll Holder Free Standing/  
Toilet Brush incl. Container**

	Round	
	Height 31"	
	Base plate diameter 9"	
FK312P	Polished Chrome/Porcelain	522.00
FK312	Polished Chrome/Frosted Glass	490.00
H233N	Spare Brush Black	48.00
H234N	Spare Brush White	48.00
N334	Spare Frosted Glass Container	106.00
O334	Spare Porcelain Container	123.00

**Spare Toilet Roll Holder**

	Round	
	Holds 3 rolls	
	Height 15 3/8"	
FK313 *	Polished Chrome	156.00

**Double Towel Rail. Free Standing**

	Round	
	Height 34 1/4"	
	Base plate diameter 9"	
	Length of Rails 14"	
FK315	Polished Chrome	438.00

Article No.	Bath Accessories in Solid Brass	Sug. Ret. \$ EA
-------------	---------------------------------	-----------------



	<b>Toilet Brush incl. Container</b>	
	Square	
	Height 16"	
FK321P	Polished Chrome/Porcelain	231.00
H233N	<i>Spare Brush Black</i>	48.00
H234N	<i>Spare Brush White</i>	48.00
O334	<i>Spare Porcelain Container</i>	123.00

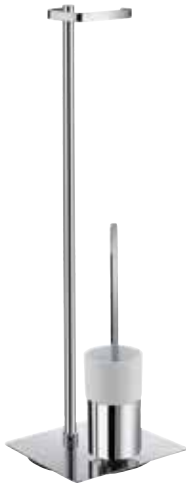

	<b>Toilet Roll Holder Free Standing/ Toilet Brush incl. Container</b>	
	Square	
	Height 31"	
	Base plate 9" x 9"	
FK322P	Polished Chrome/Porcelain	583.00
H233N	<i>Spare Brush Black</i>	48.00
H234N	<i>Spare Brush White</i>	48.00
O334	<i>Spare Porcelain Container</i>	123.00



	<b>Spare Toilet Roll Holder</b>	
	Square	
	Holds 3 rolls	
	Height 15 3/8"	
FK323 *	Polished Chrome	156.00



	<b>Double Towel Rail. Free Standing</b>	
	Square	
	Height 34 1/4"	
	Base plate 9" x 9"	
	Length of Rails 14"	
FK325	Polished Chrome	490.00

\* Discontinued during 2024

Article No.	Bath Accessories in Solid Brass	Sug. Ret. \$ EA
	<p><b>Magnetic Shaving/Make-up Mirror - Self-Adhesive wall plate</b>                      Diameter 6"                      Wall mounted                      Detachable                      Magnifies 5 times                      Polished Chrome</p>	177.00
	<p><b>Shaving/Make-up Mirror - Travel Mirror with swivel stand</b>                      Diameter 6"                      Magnifies 5 times                      With neoprene protective travel case                      Polished Chrome</p>	114.00
	<p><b>Make-up Mirror/Table mirror LED</b>                      Free Standing with swivel stand                      Rechargeable battery, charge with USB (Battery and USB cord included)                      Diameter 7"                      Normal and Magnifies 7 times                      Matte Black                      Polished Chrome</p>	158.00 158.00
	<p><b>Swing arm Shaving/Make-up Mirror</b>                      Wall mounted                      Mirror Diameter 7 7/8"                      Arm length 13 1/2"                      Two sides - normal and magnifies 5 times                      Matte Black                      Polished Chrome                      Two sides - normal and magnifies 7 times                      Polished Chrome                      Brushed Brass</p>	372.00 337.00 360.00 500.00
	<p><b>Swing arm Shaving/Make-up Mirror</b>                      Wall mounted                      Mirror Diameter 7 7/8"                      Arm length 6 3/4"                      Two sides - normal and magnifies 7 times                      Polished Chrome</p>	365.00

Article No.	Bath Accessories in Solid Brass	Sug. Ret. \$ EA
	<p><b>Shaving/Make-up Mirror</b>                      Free Standing                      Mirror Diameter 7 7/8"                      Height 15"                      Two sides - normal and magnifies 3 times                      Polished Chrome</p>	291.00
	<p><b>Shaving/Make-up Mirror with LED-technology, Dual Light</b> (warm and cool light)                      Free Standing                      Battery operated with 4 pcs, AA battery 1.5V batteries (not included)                      Two sides - normal and magnifies 5 times                      Diameter 7"                      Height 13 3/5"                      Polished Chrome</p>	306.00
	<p><b>Shaving/Make-up Mirror with LED-technology, Dual Light</b> (warm and cool light)                      PMMA Frame                      Free Standing                      Battery operated with 4 pcs, AA battery 1.5V batteries (not included)                      Magnifies 5 times                      Mirror Diameter 7 7/8"                      Height 15 3/8"</p> <p>FK484EP Polished Chrome                      FK484EBP Matte Black                      FK484EWP Matte White</p>	362.00 362.00 362.00
	<p><b>Shaving/Make-up Mirror with Rechargeable LED</b>                      PMMA Frame                      Free Standing                      Sensor Activated LED Light                      Rechargeable battery, charge with USB (Battery and USB cord included)                      Magnifies 7 times                      Mirror Diameter 9"                      Height 15 3/8"                      Polished Chrome</p>	658.00

\* Discontinued during 2024





Article No.

Bath Accessories in Solid Brass

Sug. Ret. \$ EA

**Shaving/Make-up Mirror with LED-technology, Dual Light** (warm and cool light)

PMMA Frame  
Wall mounted  
Battery operated with 4 pcs, AA battery 1.5V batteries (not included)  
Magnifies 5 times  
Mirror Diameter 7 7/8"  
Arm length 13 1/2"

FK485EBP  
FK485EP

Matte Black  
Polished Chrome

696.00  
557.00



**Shaving/Make-up Mirror with Rechargeable LED**

PMMA Frame  
Wall mounted  
Sensor Activated LED Light  
Rechargeable battery, charge with USB (Battery and USB cord included)  
Magnifies 7 times  
Mirror Diameter 9"  
Arm length 13 1/2"

FK487EP

Polished Chrome

875.00



**Shaving/Make-up Mirror with Rechargeable LED**

PMMA Frame  
Wall mounted  
Sensor Activated LED Light  
Rechargeable battery, charge with USB (Battery and USB cord included)  
Magnifies 7 times  
Mirror Diameter 7 7/8"  
Arm length 15"

FK491EP

Polished Chrome

936.00



**Shaving/Make-up Mirror with Rechargeable LED**

PMMA Frame  
Wall mounted  
Sensor Activated LED Light  
Rechargeable battery, charge with USB (Battery and USB cord included)  
Magnifies 7 times  
Mirror 7 7/8" x 7 7/8"  
Arm length 15"

FK492EP

Polished Chrome

1 028.00

Article No.	Bath Accessories in Stainless Steel	Sug. Ret. \$ EA
-------------	-------------------------------------	-----------------

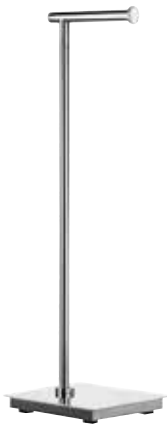

FK602	<b>Toilet Roll Holder</b> Height 24" Baseplate 7" x 7" Square Free Standing (10 lbs) Stainless Steel Polished	333.00
-------	---	--------



FK603 H233N H234N N334	<b>Toilet Roll Holder/                      Toilet Brush incl. Container</b> Height 24" Baseplate 7" x 7" Square Free Standing (14 lbs) Stainless Steel Polished/Frosted Glass <i>Spare Brush Black</i> <i>Spare Brush White</i> <i>Spare Frosted Glass Container</i>	487.00 48.00 48.00 106.00
---------------------------------	--	------------------------------------



FK604	<b>Triple Swing Arm Towel Rail</b> Height 31" Baseplate 7" x 7" Length of Rails 12" Square Free Standing (11 lbs) Stainless Steel Polished	369.00
-------	---	--------

Article No.	Bath Accessories in Stainless Steel	Sug. Ret. \$ EA
-------------	-------------------------------------	-----------------



	<b>Toilet Brush</b>	
	Height 17 3/4"	
	Round	
	Free Standing	
FK605	Stainless Steel Polished/Plastic insert	214.00
H233N	Spare Brush Black	48.00
H234N	Spare Brush White	48.00



	<b>Toilet Roll Holder</b>	
	Height 24"	
	Base plate 7"	
	Round	
	Free Standing	
	(9 lbs)	
FK606	Stainless Steel Polished	293.00



	<b>Toilet Roll Holder/ Toilet Brush incl. Container</b>	
	Height 24"	
	Base plate 7"	
	Round	
	Free Standing	
	(12 lbs)	
FK607	Stainless Steel Polished/Frosted Glass	399.00
H233N	Spare Brush Black	48.00
H234N	Spare Brush White	48.00
N334	Spare Frosted Glass Container	106.00



	<b>Triple Swing Arm Towel Rail</b>	
	Height 31"	
	Base plate 7"	
	Length of Rails 12"	
	Round	
	Free Standing	
	(10 lbs)	
FK608	Stainless Steel Polished	375.00



Article No.	Bath Accessories in Stainless Steel	Sug. Ret. \$ EA
-------------	-------------------------------------	-----------------

**Swivel Hooks**

Seven swing hooks  
 Height 25"  
 Depth Rail 2 1/2"  
 Maximum Length Hooks included 3 3/4"  
 Mounted vertically with concealed fixings  
 Not suitable for use in the shower!  
 Stainless Steel Polished

FK630		293.00
-------	--	--------

**Towel Bar, 4 Swivel Arms for Towels**

Height 24 3/4". Length 15 3/4"  
 Depth rod 2 1/2"  
 Maximum Length included Rails 17 4/6"  
 Mounted vertically with concealed fixings  
 Not suitable for use in the shower!  
 Stainless Steel Polished

FK634		306.00
-------	--	--------

**Toilet Roll Holder/Spare Toilet Roll Holder**

Height 24 1/3"  
 Base plate 6 3/4"  
 Round  
 Free Standing  
 Matte Black  
 Stainless Steel Polished  
 Matte White

FB635	Matte Black	218.00
FK635	Stainless Steel Polished	201.00
FX635	Matte White	218.00



**Toilet Roll Holder/Spare Toilet Roll Holder**

Height 24 1/3"  
 Base plate 6 3/4" x 6 3/4"  
 Square  
 Free Standing  
 Matte Black  
 Stainless Steel Polished  
 Matte White

FB636	Matte Black	288.00
FK636	Stainless Steel Polished	201.00
FX636	Matte White	218.00

**Step can 1 1/2 gallon. Soft Close**





Stainless Steel  
 Height 12"  
 Diameter 8.5"  
 Matte Black  
 Matte White  
 Bin liner 1 1/2 gallons. (40 pcs)

FB668	Matte Black	104.00
FX668	Matte White	104.00
F971	Bin liner 1 1/2 gallons. (40 pcs)	20.00









Article No.	Bath Accessories in Stainless Steel	Sug. Ret. \$ EA
	<b>Plastic Mirror with self-adhesive Hook</b> 6" x 8 1/3" Height with Hook 10 1/4" Chromed Stainless Steel	35.00
	<b>Make-up Mirror with Suction Cups</b> Magnifies 12 times Diam 3 1/2"	19.00
	FB621 Matte Black ABS/Mirror Glass FS621 Silver ABS/Mirror Glass	19.00
	<b>Travel-/Make-up Mirror with Rechargeable LED</b> Normal and magnifies 7 times Rechargeable battery, charge with USB (Battery and USB cord included) Diam 4 3/4"	68.00
	FB627 Matte Black ABS FX627 Matte White ABS	68.00
	<b>Travel-/Make-up Mirror</b> Normal and Magnifies 5 and 12 times Diam 4" (each mirror)	48.00
FB623 Matte Black ABS FX623 Matte White ABS	48.00	
	<b>Make-up Mirror with Suction Cups</b> <b>LED-technology</b> Normal and Magnifies 7 times Rechargeable battery, charge with USB (battery and cord included) Diam 5"	74.00
	FB625 Matte Black ABS FX625 Matte White ABS	74.00
	<b>Step can 1 1/2 gallon. Soft Close</b> Stainless Steel 9 1/2" x 12 1/2" x 9"	138.00
FK662	Matte White	138.00
FK663	Brushed	138.00
FK665	Matte Black	138.00
F971	Bin liner 1 1/2 gallons. (40 pcs)	20.00



Article No.	Bath Accessories in Solid Brass	Sug. Ret. \$ EA
	<b>Spare Toilet Roll Holder</b> Length 10" Polished Chrome	106.00
	<b>Grab Bar</b> Total Length 10" Polished Chrome	230.00
	<b>Swing Arm Towel Rail</b> Length 17 1/2" Polished Chrome	182.00
	<b>Swing Arm Triple Hook</b> Length 5" Height 3 3/4" Polished Chrome	164.00
	<b>Toilet Brush on a hinge pivots outward</b> Height 17 1/4" Wall mounted Polished Chrome/Plastic insert <i>Spare Brush Black</i> <i>Spare Brush White</i>	328.00 48.00 48.00
	<b>Toilet Brush incl. Container</b> Height 15" Wall mounted Polished Chrome/Frosted Glass <i>Spare Brush Black</i> <i>Spare Brush White</i> <i>Spare Frosted Glass Container</i>	173.00 48.00 48.00 106.00
	<b>Double Towel Rail</b> Length 24 4/5". cc 23 3/4" Polished Chrome	306.00

\* Discontinued during 2024

Article No.	Bath Accessories in Solid Brass	Sug. Ret. \$ EA
ZK341	<b>Toilet Roll Holder</b> Polished Chrome	106.00
ZK3414	<b>Toilet Roll Holder with Cover</b> Polished Chrome	145.00
ZK342 * L348	<b>Holder with Soap Dish</b> Polished Chrome/Frosted Glass <i>Spare Frosted Glass Soap Dish</i>	104.00 44.00
ZK343 L349	<b>Holder with Tumbler</b> Polished Chrome/Frosted Glass <i>Spare Frosted Glass Tumbler</i>	109.00 44.00
ZK344	<b>Towel Ring</b> 7 7/8" x 4 3/4" Polished Chrome	109.00
ZK3455	<b>Multi-purpose Hook. Pair</b> Depth 1 1/4". Diameter 1/2" Polished Chrome	50.00
ZK346	<b>Single Towel Rail</b> Length 17". cc 16" Polished Chrome	206.00

	<b>Article No.</b>	<b>Bath Accessories in Solid Brass</b>	<b>Sug. Ret. \$ EA</b>
	ZK3464	<b>Single Towel Rail</b> Length 24 4/5". cc 23 3/4" Polished Chrome	234.00
	ZK347 * P350	<b>Glass Shelf</b> Length 24" Polished Chrome/Frosted Glass <i>Spare Frosted Glass Shelf</i>	206.00 77.00
	ZK356	<b>Double Towel Hook</b> Height 1 3/5" Length 3 1/6" Polished Chrome	103.00
	ZK359	<b>Triple Hook</b> Height 1 3/5" Length 6 1/2" Polished Chrome	130.00
	ZK369 H351	<b>Holder with Glass Soap Dispenser</b> Pumphead of Solid Brass Height 7" Volume 200 ml Wall mounted Polished Chrome/Frosted Glass <i>Spare Frosted Glass Soap Container</i>	182.00 111.00
	ZK370	<b>Soap Dispenser</b> Pumphead of Solid Brass Height 6 1/2" Volume 150 ml Wall mounted Polished Chrome	242.00
	ZK374 *	<b>Soap Basket</b> 10" x 4" Height 2 3/4" Polished Chrome	230.00



\* Discontinued during 2024



Article No.	Bath Accessories in Solid Brass	Sug. Ret. \$ EA
DK1001	<b>Basic Soap Basket</b> 8 1/2" x 4 3/4" Height 2 1/2" Polished Chrome	85.00
DK1002	<b>Basic Soap Basket</b> 10 1/2" x 4 3/4" Height 4 1/2" Polished Chrome	90.00
DK1005	<b>Basic Soap Basket</b> 5 1/2" x 3 1/4" Height 7/8" Polished Chrome	69.00
DK1021	<b>Basic Corner Soap Basket, Double</b> 6 1/2" x 6 1/2" Height 11 1/2" Polished Chrome	172.00
DK1022	<b>Basic Corner Soap Basket, Double</b> 8 1/4" x 8 1/4" Height 11 1/2" Polished Chrome	213.00
DK1031	<b>Basic Soap Basket, Double</b> 8 1/2" x 4 1/2" Height 12 1/2" Polished Chrome	172.00

Article No.	Bath Accessories in Solid Brass	Sug. Ret. \$ EA
-------------	---------------------------------	-----------------



DK1101 *	<b>Shower Basket</b> 10" x 4" Height 3" Polished Chrome	136.00
----------	--	--------



DK1106	<b>Shower Basket for Shower Riser Rail</b> Fits rail thickness Fits rail thickness 3/4" - 1" 10" x 4" Height 3" Polished Chrome	189.00
--------	---	--------

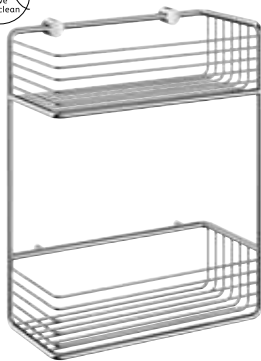

DK1111 *	<b>Shower Basket, Double</b> Basket size 10" x 4" Height of Baskets 3" Total Height 12" Polished Chrome	243.00
----------	---	--------

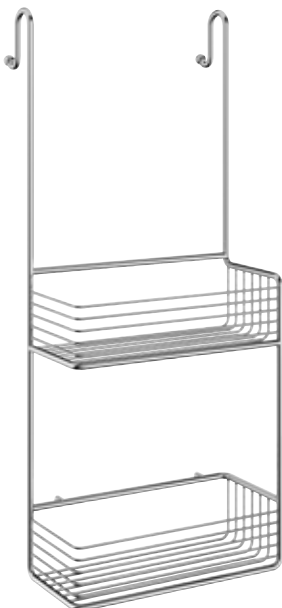

DK1141 *	<b>Shower Basket, Double</b> Basket size 10" x 4" Height of Baskets 3" Total Height 12 1/2" Polished Chrome	314.00
----------	---	--------

Article No.	Bath Accessories in Solid Brass	Sug. Ret. \$ EA
-------------	---------------------------------	-----------------

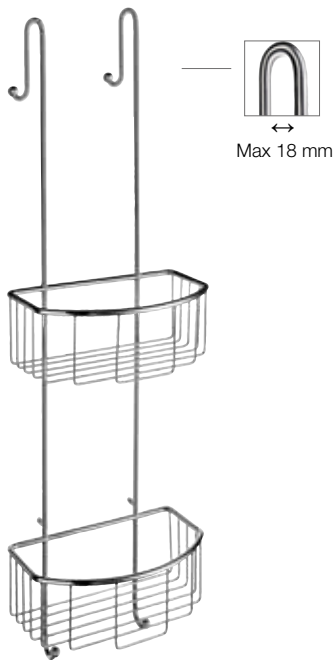

DK1041	<b>Basic Shower Basket, Double</b>	
	Basket size 8 1/8" x 5 1/8"	
	Height 3 1/8"	
	Total Height 30"	
	Polished Chrome	306.00



DK2001 DS2001	<b>Design Soap Basket</b>	
	10" x 4 3/8"	
	Height 2 1/2"	
	Polished Chrome	110.00
	Brushed Chrome	118.00

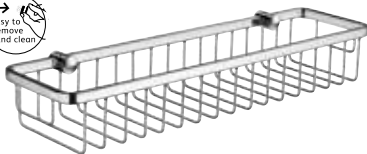

DK2005 *	<b>Design Soap Basket</b>	
	15 1/2" x 4 1/2"	
	Height 2 1/2"	
	Polished Chrome	165.00



DK2041	<b>Design Corner Soap Basket, Double</b>	
	7 4/6" x 7 4/6"	
	Basket Height 2 1/2"	
	Total Height 11 3/4"	
	Polished Chrome	234.00



V274	<b>Corner Soap Basket</b>	
	Diameter 7 7/8"	
	Height 2 1/2"	
	Polished Brass	192.00

\* Discontinued during 2024

**Article No. Bath Accessories in Solid Brass Sug. Ret. \$ EA**

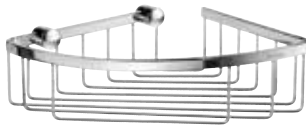

	<b>Design Corner Soap Basket</b>	
	7 1/2" x 7 1/2"	
	Height 2 1/2"	
DK2021	Polished Chrome	130.00
DS2021	Brushed Chrome	140.00



	<b>Design Corner Soap Basket with Hooks, Double</b>	
	7 1/2" x 7 1/2"	
	Basket Height 2 1/2"	
	Total Height 13 1/2"	
DK2031	Polished Chrome	234.00
DS2031	Brushed Chrome	242.00



	<b>Soap Baskets Hook, Pair</b>	
	Height 1 5/8"	
	Suitable for use with most Smedbo baskets	
DK2100	Polished Chrome on Stainless Steel	45.00



	<b>Hook for Baskets</b>	
	Height 3 3/4"	
	For Shower Squeegee, Razor, Towels etc	
DK2111	Polished Chrome	68.00



	<b>Self-Adhesive Hook for DK2130 etc.</b>	
	Diameter 1 7/8"	
DK2113	Polished Chrome on Stainless Steel	23.00



	<b>Shower Squeegee with easy-grip Handle</b>	
	Can be used with Hook DK2113	
	Silicone Blade	
	Length 9 1/2"	
DK2130	Black ABS/Polished Chrome/Silicone	100.00



	<b>Shower Squeegee with easy-grip Handle</b>	
	Can be used with Hook DK2113	
	Silicone Blade	
	Length 9 1/2"	
DB2145	Black ABS/Silicone	48.00
DX2145	White ABS/Silicone	48.00



Article No.	Bath Accessories in Solid Brass	Sug. Ret. \$ EA
-------------	---------------------------------	-----------------

**Shower Squeegee with Self-adhesive Hook**

Silicone Blade  
9 1/2" x 8 1/2"

DB2140	Matte Black Stainless Steel	85.00
DK2140	Chromed Stainless Steel	77.00

**Shower Squeegee with Self-adhesive Hook**

Silicone Blade  
9 1/2" x 8 1/2"

DK2150	Polished Stainless Steel	83.00
--------	--------------------------	-------

**Shower Squeegee with Self-adhesive Hook**

Silicone Blade  
15.75" x 8.5"

DB2142	Matte Black Stainless Steel	160.00
DK2142	Chromed Stainless Steel	145.00

**Shower Squeegee with Self-adhesive Hook**

Silicone Blade  
9 1/2" x 19 1/2"

DK2165	Chromed Stainless Steel	160.00
--------	-------------------------	--------

**Floor Squeegee with Self-adhesive Hook**

Silicone Blade  
15.5" x 52.25"

DB2170	Matte Black Stainless Steel	289.00
DK2170	Chromed Stainless Steel	237.00

**Article No.**      **Bath Accessories in Solid Brass**      **Sug. Ret. \$ EA**

---



**Design Soap Basket  
Solid Brass Construction**

10" x 4"  
Height 2 1/2"

D3001N	Brushed Nickel	186.00
DB3001	Matte Black	190.00
DK3001	Polished Chrome	173.00
DV3001	Polished Brass	195.00
DV3001S	Brushed Brass	173.00
DX3001	Matte White	182.00



**Basic Soap Basket, Double**

10" x 4"  
Height 12 1/2"

DK3012	Polished Chrome	309.00
--------	-----------------	--------



**Design Soap Basket  
Solid Brass Construction**

16" x 4"  
Height 3"

DK3005	Polished Chrome	242.00
--------	-----------------	--------

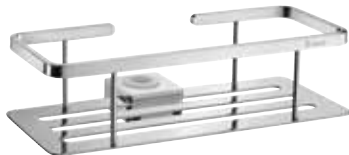

**Shower Basket for Shower Riser Rail**

Fits rail thickness 3/4", 7/8", 1"  
Basket 10" x 4"  
Height 2 1/2"

DB3006	Matte Black	305.00
DK3006	Polished Chrome	291.00



**Shower Basket for Shower Riser Rail**

Fits rail thickness 3/4", 7/8", 1"  
Basket 200 x 110 mm  
Height 70 mm

DB3008	Matte Black	304.00
DK3008	Polished Chrome	277.00

Article No.	Bath Accessories in Solid Brass	Sug. Ret. \$ EA
-------------	---------------------------------	-----------------



DK3025	<b>Design Corner Soap Basket</b> <b>Solid Brass Construction</b> 7 7/8" x 7 7/8" Height 3" Polished Chrome	292.00
--------	--	--------



DK3032	<b>Design Corner Soap Basket, Double</b> 200 x 200 mm Basket Height 2 1/2" Total Height 12 1/2" Polished Chrome	390.00
--------	---	--------



D3031N	<b>Design Corner Soap Basket</b> <b>Solid Brass Construction</b> 7 7/8" x 7 7/8" Height 3" Brushed Nickel	232.00
DB3031	Matte Black	221.00
DK3031	Polished Chrome	210.00



DB3041	<b>Shower Basket, Double</b> <b>Solid Brass Construction</b> Total Height 30" Basket size 8 1/8" x 5 1/8" Height 3" Matte Black	468.00
DK3041	Polished Chrome	446.00

**Article No.**      **Bath Accessories in Solid Brass**      **Sug. Ret. \$ EA**

---



**No Drill Towel Rack for Glass Shower Panel**  
 Fits Glass size  $\frac{3}{8}$ " or less  
 Length 24"  
 Height 12  $\frac{7}{8}$ "  
 Depth 2  $\frac{3}{4}$ "  
 DK3101      Polished Chrome      277.00

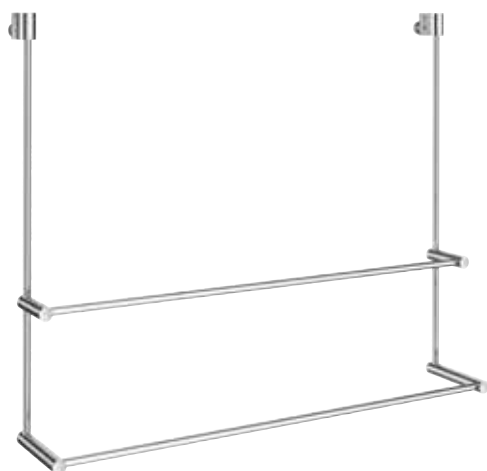

**No Drill Double Towel Rack for Glass Shower Panel**  
 Fits Glass size  $\frac{3}{8}$ " or less  
 Length 24"  
 Height 19  $\frac{1}{4}$ "  
 Depth 2  $\frac{3}{4}$ " x 4  $\frac{3}{8}$ "  
 DK3102      Polished Chrome      419.00



**No Drill Hook for Glass Shower Panel**  
 Fits Glass size  $\frac{3}{8}$ " or less  
 Height 3  $\frac{1}{8}$ "  
 Depth 1  $\frac{3}{5}$ "  
 DK3111      Polished Chrome      75.00



**Shower Shelf, "Hide"**  
 8.25" x 8.25"  
 Height 10.25"  
 DB5020      Matte Black Aluminium      158.00









**Shower Shelf, "Cube"**  
 10" x 10"  
 Depth 4.25"  
 DB5021      Matte Black Aluminium      179.00

	<b>Article No.</b>	<b>Bath Accessories in Stainless Steel</b>	<b>Sug. Ret. \$ EA</b>
	DK3055	<b>Corner Shower Basket</b> One wall mount 7 7/8" x 7 7/8" Height 2 1/2" Chromed Stainless Steel	234.00
	DB3060 DK3060	<b>Grout Line Corner Shelf</b> With built-in Razor hole and hook 7 7/8" x 7 7/8" Black Stainless Steel Polished Stainless Steel	121.00 110.00
	DB3061 DK3061	<b>Grout Line Shelf, with holes</b> 10" x 4" Black Stainless Steel Polished Stainless Steel	75.00 67.00
	DB3062 DK3062	<b>Grout Line Shelf, with lines</b> 10" x 4" Black Stainless Steel Polished Stainless Steel	75.00 67.00
	DB3063 DK3063	<b>Grout Line Corner Shelf, with holes</b> 7 7/8" x 7 7/8" Black Stainless Steel Polished Stainless Steel	75.00 67.00
	DB3064 DK3064	<b>Grout Line Corner Shelf, with lines</b> 7 7/8" x 7 7/8" Black Stainless Steel Polished Stainless Steel	75.00 67.00
	DB5001 DK5001	<b>Shower Shelf</b> 10" x 4.5" Wallplate Height 2" Removeable Black Stainless Steel Polished Stainless Steel	218.00 252.00
	DB5011 DK5011	<b>Shower Corner Shelf</b> 8.25" x 8.25" Wallplate Height 2" Removeable Black Stainless Steel Polished Stainless Steel	279.00 309.00



Article No.	Bath Accessories in Solid Brass	Sug. Ret. \$ EA
	<p><b>Spare Toilet Roll Holder</b>                      Height 6 7/8"                      Polished Chrome                      V220 Polished Brass</p>	<p>122.00                      140.00</p>
	<p><b>Grab Bar</b>                      Total Length 10 2/3"                      Diameter 1"                      Polished Chrome                      V225 Polished Brass</p>	<p>191.00                      203.00</p>
	<p><b>Swing Arm Towel Rail</b>                      Length 16"                      Polished Chrome                      V226 Polished Brass</p>	<p>195.00                      203.00</p>
	<p><b>Toilet Brush</b>                      Height 16 3/4"                      Free Standing                      Polished Chrome/Plastic insert                      V233 Polished Brass/Plastic insert                      H233N Spare Brush Black                      H234N Spare Brush White</p>	<p>229.00                      233.00                      48.00                      48.00</p>
	<p><b>Double Towel Rail</b>                      Length 24 4/5". cc 24"                      Polished Chrome                      V2364 Polished Brass</p>	<p>230.00                      233.00</p>
	<p><b>Toilet Roll Holder</b>                      Polished Chrome                      V241 Polished Brass</p>	<p>114.00                      121.00</p>

	Article No.	Bath Accessories in Solid Brass	Sug. Ret. \$ EA
	K242 *	Polished Chrome/Clear Glass	95.00
	V242 *	Polished Brass/Clear Glass	104.00
	V248G *	Spare Clear Glass Soap Dish	46.00
	K243	Polished Chrome/Clear Glass	106.00
	V243	Polished Brass/Clear Glass	109.00
	V249G	Spare Clear Glass Tumbler	48.00
	K244	Polished Chrome Diameter 6"	100.00
	V244	Polished Brass	100.00
	K245	Polished Chrome Diameter 2 1/6"	44.00
	V245	Polished Brass	50.00
	K2464	Polished Chrome Length 24 4/8" . cc 24"	170.00
	V2464	Polished Brass	177.00
	K247 *	Polished Chrome/Clear Glass Length 24"	174.00
	V247 *	Polished Brass/Clear Glass	182.00
	N350 *	Spare Clear Glass Shelf	75.00

Article No.	Bath Accessories in Solid Brass	Sug. Ret. \$ EA
	<p><b>Towel Hook</b>                      Diameter 2 3/4"                      Polished Chrome                      Polished Brass</p>	<p>61.00                      64.00</p>
	<p><b>Double Towel Hook</b>                      Diameter 2 3/4"                      Polished Chrome                      Polished Brass</p>	<p>76.00                      82.00</p>
	<p><b>Quadruple Hook</b>                      Length 9"                      Polished Chrome                      Polished Brass</p>	<p>145.00                      151.00</p>
	<p><b>Holder with Glass Soap Dispenser</b>                      Pumphead of Solid Brass                      Height 6 1/4"                      Volume 250 ml                      Wall mounted                      Polished Chrome/Frosted Glass  <i>Spare Frosted Glass Soap Container</i></p>	<p>229.00                      109.00</p>
	<p><b>Corner Soap Basket</b>                      Diameter 7 7/8"                      Height 2 1/2"                      Polished Chrome</p>	<p>183.00</p>

\* Discontinued during 2024



Article No.	Bath Accessories	Sug. Ret. \$ EA
N334	<b>Spare Frosted Glass Container</b> for Air/Home/House/Pool 333, FK101/311/312, FK302/306, FK603/607	106.00
		
O334	<b>Spare Porcelain Container</b> for Air/Art/Home/House/Ice/ Outline/Pool 333	123.00
		
L348	<b>Spare Frosted Glass Soap Dish</b> for Air/Home/House/Pool 342	44.00
		
V248G *	<b>Spare Clear Glass Soap Dish</b> for Villa 242	46.00
		
O348	<b>Spare Porcelain Soap Dish</b> for Air/Home/House/Ice/ Pool 342	50.00
		
L349	<b>Spare Frosted Glass Tumbler</b> for Air/Home/House/Pool 343	44.00
		
V249G	<b>Spare Clear Glass Tumbler</b> for Villa 243	48.00
		
O349	<b>Spare Porcelain Tumbler</b> for Air/Home/House/Ice/ Pool 343	50.00
		

\* Discontinued during 2024

Article No.	Bath Accessories	Sug. Ret. \$ EA
	N350 * <b>Spare Clear Glass Shelf</b> for Villa 247	75.00
	H350 * <b>Spare Frosted Glass Shelf</b> for Home/House 347	78.00
	P350 * <b>Spare Frosted Glass Shelf</b> for Air/Pool 347	77.00
	O350 * <b>Spare Frosted Glass Shelf</b> for Ice	95.00
	H351 <b>Spare Frosted Glass Soap Container</b> for Air/Home/House/Pool 369	111.00
	O351 <b>Spare Porcelain Soap Container</b> for Air/Home/House/Ice/Pool 369	123.00
	N3351 <b>Spare Frosted Glass Soap Container</b> for Outline 201, Villa 269	109.00
	H233N <b>Spare Brush Black</b> Air/Home/House/Ice/Outline/Outline Lite/ Pool/Villa	48.00
	H234N <b>Spare Brush White</b> Air/Home/House/Ice/Outline/Outline Lite/ Pool/Villa	48.00
	H235S <b>Spare Brush Black - TPR</b> <i>(Thermo Plastic Rubber)</i> Air/Home/House/Ice/Outline/Outline Lite/ Pool/Villa	48.00

Article No.	Bath Accessories	Sug. Ret. \$ EA
-------------	------------------	--------------------



	<b>Spare Brush with Handle</b> Can only be used in open Toilet Brush Glass	
HK237	Stainless Steel Polished	75.00
HS237	Stainless Steel Brushed	80.00



	<b>WC Sign Lady</b> Self-adhesive	
FS956	Stainless Steel Brushed	28.00



	<b>WC Sign Gentleman</b> Self-adhesive	
FS957	Stainless Steel Brushed	28.00



	<b>WC Sign Water closet</b> Self-adhesive	
FS958	Stainless Steel Brushed	28.00



	<b>WC Sign Disabled</b> Self-adhesive	
FS959	Stainless Steel Brushed	28.00



	<b>Bottle opener</b>	
FK970	Chrome	59.00



F971	<b>Step Bin liners</b> (FK662 - FK665, FB/FX668, see page 38 - 39) Trash bags for bin 6 liter (40 pcs)	20.00
------	---	-------



	<b>Clock</b> Diameter 2 1/2" Recommended Duracell Battery 395/399 (1.5V) One battery included	
YX380	Chrome/White	139.00
YK380	Chrome/Black	139.00





# CONTENT



	<b>BESLAGSBODEN</b>
64 - 66	DRAWER HANDLES
67	TEMPLATE
68 - 69	KNOBS
70 - 75	HOOKS
75 - 77	RACKS
78 - 80	FREE-STANDING PRODUCTS
81	MAKE-UP MIRRORS
82	SELF-ADHESIVE BATHROOM LINE - CUBE
83	SELF-ADHESIVE BATHROOM LINE - PUCK
84 - 89	SELF-ADHESIVE ASSORTMENT
90	ACCESSORIES
91	SHOWER BASKETS, SELF-ADHESIVE
92 - 93	DOOR HARDWARE
94 - 98	HOUSE NUMBERS
99	MAILBOX NUMBERS
100	DISPLAY BOARDS
101	BROCHURES









**Note** that the surface to be bonded must be well cleaned and dry. Please allow the adhesive 24 hours to harden before using.



**Self-adhesive products** are NOT recommended to be installed on wet room wallpaper as plasticizers in the wet room wallpaper adversely affect the adhesive and the product can detach from the wall.

	Article No.	Cabinet Hardware DRAWER HANDLES - Zinc	Sug. Ret. \$ EA
	B265	<b>Pulls in Zinc</b> Brushed Chrome, cc 3 7/8"	11.00
	B535 B5351	<b>Pulls in Zinc</b> Brushed Chrome, cc 3 7/8" Brushed Chrome, cc 5"	11.00 12.00
	B609 B6091	<b>Pulls in Zinc</b> Brushed Chrome, cc 3 7/8" Brushed Chrome, cc 5"	11.00 12.00
	B542 BB542 B543 B545	<b>Pulls in Zinc</b> Antique Brass Finish, cc 3 7/8" Black, cc 3 7/8" Pewter, cc 3 7/8" Brushed Nickel, cc 3 7/8"	8.00 8.00 8.00 8.00
	B570 B571 B573 B574 B577	<b>Pull in Zinc</b> Length 3 1/2", cc 2 1/2" Antique Brass Finish Pewter Brushed Nickel Black Antique Copper Finish	15.00 15.00 15.00 15.00 15.00
	B5851	<b>Pulls in Zinc</b> Brushed Nickel, cc 5"	11.00
	B590 B5901 B5902 B5903	<b>Pulls in Zinc</b> Brushed Nickel, cc 3 7/8" Brushed Nickel, cc 5" Brushed Nickel, cc 6 3/8" Brushed Nickel, cc 9"	12.00 15.00 18.00 23.00
	B631 B6311 B6312	<b>Pulls in Zinc</b> Brushed Nickel, cc 3 7/8" Brushed Nickel, cc 5" Brushed Nickel, cc 6 3/8"	9.00 13.00 17.00

	Article No.	Cabinet Hardware DRAWER HANDLES - Zinc	Sug. Ret. \$ EA
		<b>Pulls in Zinc</b>	
	B617	Brushed Chrome, cc 3 7/8"	17.00
	B6171	Brushed Chrome, cc 5"	18.00
	BB617	Black, cc 3 7/8"	15.00
	BB6171	Black, cc 5"	17.00
	BC617	Polished Copper Finish, cc 3 7/8"	17.00
	BC6171	Polished Copper Finish, cc 5"	18.00
	BV617	Polished Brass Finish, cc 3 7/8"	17.00
BV6171	Polished Brass Finish, cc 5"	18.00	
		<b>Pulls in Zinc</b>	
	BB627	Black, cc 3 7/8"	13.00
	BC627	Polished Copper Finish, cc 3 7/8"	15.00
	BK627	Polished Chrome, cc 3 7/8"	13.00
	BV627	Polished Brass Finish, cc 3 7/8"	15.00
		<b>Pulls in Zinc/Ceramics</b>	
	BA6291	Antique Brass Finish/White, cc 5"	13.00
	BB6291	Black/White, cc 5"	13.00
	BC6291	Antique Copper Finish/White, cc 5"	13.00
	BG6291	Pewter/White, cc 5"	13.00
		<b>Pulls in Zinc</b>	
	BA630	Antique Brass Finish, cc 3 7/8"	11.00
	BA6303	Antique Brass Finish, cc 10 1/8"	26.00
	BB630	Black, cc 3 7/8"	11.00
	BB6303	Black, cc 10 1/8"	26.00
	BG630	Pewter, cc 3 7/8"	11.00
	BG6303	Pewter, cc 10 1/8"	26.00
	BN630	Brushed Nickel, cc 3 7/8"	11.00
BN6303	Brushed Nickel, cc 10 1/8"	26.00	
		<b>Pulls in Zinc</b>	
	BB632	Black, cc 3 7/8"	12.00
	BK632	Polished Chrome, cc 3 7/8"	12.00
	BV632	Polished Brass Finish, cc 3 7/8"	12.00
		<b>Pull in Zinc</b>	
		Length 3 7/8", cc 2 1/2"	
	BB633	Black	13.00
	BK633	Polished Chrome	13.00
BV633	Polished Brass Finish	13.00	
		<b>Pulls in Zinc/Wood</b>	
	BK6351B	Polished Chrome/Black wood, cc 5"	21.00
	BK6351X	Polished Chrome/White wood, cc 5"	21.00

Article No.	Cabinet Hardware DRAWER HANDLES - Aluminium	Sug. Ret. \$ EA
-------------	--	--------------------



<b>Pulls in Aluminium</b>		
BB628	Black, cc 3 7/8"	11.00
BB6281	Black, cc 5"	11.00
BB6282	Black, cc 6 3/8"	12.00
BB6283	Black, cc 7 7/8"	15.00



<b>Pulls in Aluminium</b>		
BB6361	Black/Knurled, cc 5"	35.00



<b>Pulls in Aluminium</b>		
BK6361	Polished Chrome/Knurled, cc 5"	35.00

Cabinet Hardware DRAWER HANDLES - Wrought Iron		
---	--	--



<b>Pulls in Black Wrought Iron</b>		
B598	Black Wrought Iron, cc 3 7/8"	11.00



<b>Pulls in Black Wrought Iron</b>		
B599	Black Wrought Iron, cc 3 7/8"	15.00

Cabinet Hardware DRAWER HANDLES - Stainless Steel		
--	--	--



<b>Pulls in Stainless Steel</b>		
B5780	Brushed, cc 3 1/2"	19.00
B578	Brushed, cc 3 7/8"	19.00
B5781	Brushed, cc 5"	22.00
B5782	Brushed, cc 6 3/8"	25.00
B5783	Brushed, cc 9"	30.00



<b>Pulls in Stainless Steel</b>		
B621	Brushed, cc 3 7/8"	16.00
B6211	Brushed, cc 5"	17.00

Article  
No.

Cabinet Hardware  
Accessories

Sug. Ret.  
\$ EA

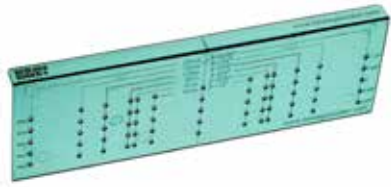













B699

**Mounting Template** for  
Knobs and Drawer Handles  
Measure between:  
cc 2 1/2"-9 5/8"

12.00



Article No.	Cabinet Hardware KNOBS Prices for Knobs are for one only	Sug. Ret. \$ EA
	<b>Knob in Zinc</b> Diameter 1 1/4" B080 Antique Brass Finish BB080 Black B081 Pewter	8.00 8.00 8.00
	<b>Knob in Zinc</b> Diameter 1 1/8" B084 Antique Brass Finish BB084 Black BN084 Brushed Nickel B085 Pewter	8.00 8.00 8.00 8.00
	<b>Knob in Zinc</b> Diameter 1 1/2" BK207M Brushed Chrome	17.00
	<b>Knob in Aluminium</b> Diameter 3/4" BB216 Black <b>Knob in Zinc</b> BK216 Polished Chrome BK216M Brushed Chrome	11.00 11.00 11.00
	<b>Knob in Zinc/Ceramics</b> Diameter 1 1/2" BA430 Antique Brass Finish/White Ceramics BB430 Black/White Ceramics BC430 Antique Copper Finish/White Ceramics BG430 Pewter/White Ceramics	9.00 9.00 9.00 9.00
	<b>Knob in Zinc</b> Diameter 1" BN431 Brushed Nickel	13.00

	Article No.	Cabinet Hardware KNOBS Prices for Knobs are for one only	Sug. Ret. \$ EA
		<b>Knob in Zinc</b> Diameter 1"	
	BB435	Black	9.00
	BC435	Polished Copper Finish	9.00
	BK435	Polished Chrome	8.00
	BV435	Polished Brass Finish	9.00
		<b>Knob in Zinc</b> Diameter 1 3/8"	
	BB464	Black	8.00
	BC464	Polished Copper Finish	9.00
	BK464	Polished Chrome	8.00
	BV464	Polished Brass Finish	9.00
	BN467 *	<b>Knob in Zinc</b> 1 1/4" x 1 1/8" Brushed Nickel	8.00
		<b>Knob in Zinc</b> Diameter 1 1/16"	
	B496	Brushed Chrome	8.00
	BB496	Black	8.00
	BC496	Polished Copper Finish	9.00
	BV496	Polished Brass Finish	9.00
	B497	<b>Knob in Zinc</b> Diameter 1" Stainless Steel	9.00
		<b>Knob in Aluminium</b> Diameter 3/4"	
	BB451	Black/Knurled	19.00
	BK451	Polished Chrome/Knurled	19.00

\* Discontinued during 2024



Article No.	Interior Hardware HOOKS	Sug. Ret. \$ EA	
	<b>Double Shelf Hook in Zinc</b>		
	Height 2 1/4"		
	BB070	Black	23.00
	BK070	Polished Chrome	23.00
BK070M	Brushed Chrome	24.00	
	<b>Triple Spinning Hook in Zinc</b>		
	Height 1 7/8"		
	BB071	Black	33.00
	BK071	Polished Chrome	33.00
	<b>Single Hook in Stainless Steel</b>		
	Height 1 3/8". Depth 1 3/8"		
	BB072	Black	17.00
	BK072	Chrome Stainless Steel	17.00
BN072M	Brushed Stainless Steel	17.00	
	<b>Single Hook in Stainless Steel</b>		
	Height 1 3/8"		
	BB073	Black	17.00
	BK073	Chrome Stainless Steel	17.00
BN073M	Brushed Stainless Steel	17.00	
	<b>Single Hook in Zinc</b>		
	Height 3/4". Pair		
	B231	Polished Brass Finish	13.00
	BB231	Black	15.00
	BK231	Polished Chrome	17.00
	Height 1 3/8"		
B232	Polished Brass Finish	9.00	
BB232	Black	9.00	
BK232	Polished Chrome	11.00	
Height 1 5/8"			
B233	Polished Brass Finish	10.00	
BB233	Black	11.00	
BK233	Polished Chrome	11.00	
	<b>Single Hook in Zinc</b>		
	Height 1 1/2"		
	B245	Polished Brass Finish	8.00
	BA245	Antique Brass Finish	9.00
	BB245	Black	8.00
	BK245	Chrome	8.00
	BK245M	Brushed Chrome	9.00
BX245	White Lacquer	8.00	

Article No.	Interior Hardware HOOKS	Sug. Ret. \$ EA
-------------	-------------------------	-----------------



**Double Towel Hook in Zinc**

Height 1 5/8"

B246	Polished Brass Finish	15.00
BA246	Antique Brass Finish	17.00
BB246	Black	15.00
BK246	Chrome	15.00
BK246M	Brushed Chrome	17.00
BX246	White Lacquer	15.00



**Hat and Coat Hook in Zinc**

Height 4 3/8"

B247	Polished Brass Finish	23.00
BA247	Antique Brass Finish	23.00
BB247	Black	23.00
BK247	Chrome	23.00
BK247M	Brushed Chrome	23.00
BX247	White Lacquer	23.00

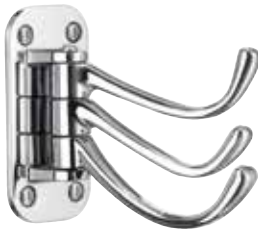

**Coat Hook, Triple in Zinc, Swing**

Height 3 1/4"

B248	Polished Brass Finish	48.00
BA248	Antique Brass Finish	51.00
BB248	Black	48.00
BK248	Chrome	50.00
BK248M	Brushed Chrome	51.00



Article No.	Interior Hardware HOOKS	Sug. Ret. \$ EA
	<b>Coat Hook</b> Height 2 1/2"	
	B1043 Aluminium	17.00
	BB1043 Black Aluminium	17.00
BX1043 White Aluminium	17.00	
	<b>Coat and Hat Hook</b> Height 5 1/2"	
	B1044 Aluminium	28.00
	BB1044 Black Aluminium	28.00
BX1044 White Aluminium	28.00	
	<b>Coat and Hat Hook</b> Height 4"	
	B1045 Satin Aluminium	23.00
BB1045 Black Aluminium	23.00	
	<b>Coat and Hat Hook</b> Height 5 1/2"	
	B1046 Satin Aluminium	28.00
BB1046 Black Aluminium	28.00	
	<b>Single Hook</b> Height 1 3/4"	
	B1047 Satin Aluminium	15.00
BB1047 Black Aluminium	15.00	
	<b>Coat and Hat Hook</b> Height 2 7/8"	
	B1048 Satin Aluminium	20.00
BB1048 Black Aluminium	20.00	





Article No.	Interior Hardware HOOKS	Sug. Ret. \$ EA
-------------	-------------------------	-----------------

B051	<b>Coat Hook</b> Height 2 3/4" Black Wrought Iron	15.00
------	---	-------



B053	<b>Hat and Coat Hook</b> Height 5 1/2" Black Wrought Iron	24.00
------	---	-------



B054	<b>Nail Hook</b> Black Wrought Iron Height 2.75"	9.00
B055	Height 4 3/8"	19.00
B059	Height 5"	20.00



B056	<b>Rustic Single Hook</b> Black Wrought Iron Height 2 1/2". Pair	17.00
B057	Height 3"	8.00
B058	Height 3 1/4"	12.00















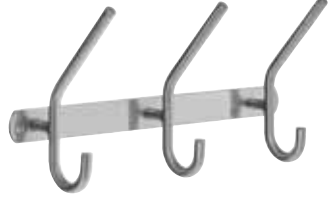
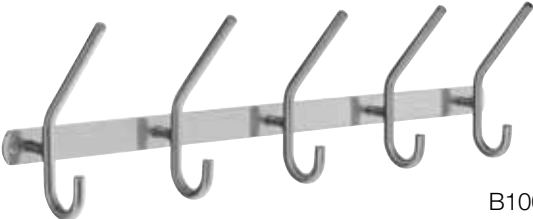

B067	<b>Rustic Single Hat and Coat Hook</b> Height 6 3/8" Black Wrought Iron	30.00
------	---	-------

Article No.	Interior Hardware RACKS	Sug. Ret. \$ EA
-------------	-------------------------	-----------------

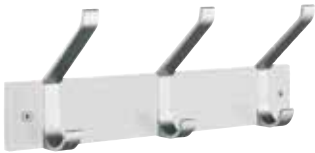

B1024	<b>Coat Rack, Quadruple</b> Length 12" Hook Height 3 1/4" Black Wrought Iron	61.00
-------	---	-------

	Article No.	Interior Hardware RACKS	Sug. Ret. \$ EA
	B1052	<b>Coat Rack, Double</b> 5 1/8" x 3/4" Brushed Stainless Steel	22.00
	B1054	<b>Coat Rack, Quadruple</b> 12 1/5" x 3/4" Brushed Stainless Steel	39.00
	B1055	<b>Coat Rack, 6 Hooks</b> 19 1/4" x 3/4" Brushed Stainless Steel	51.00
	B1062	<b>Coat Rack, Double</b> 5 1/8" x 3/4" Brushed Stainless Steel	22.00
	B1064	<b>Coat Rack, Quadruple</b> 12 1/5" x 3/4" Brushed Stainless Steel	39.00
	B1065	<b>Coat Rack, 6 Hooks</b> 19 1/4" x 3/4" Brushed Stainless Steel	51.00
	B1003	<b>Coat and Hat Rack, Triple</b> 8 1/8" x 3/4" Hook Height 4 1/2" Chrome Stainless Steel/Black	64.00
	B1005	<b>Coat and Hat Rack, 5 Hooks</b> 8 1/8" x 3/4" Hook Height 4 1/2" Chrome Stainless Steel/Black	89.00

	Article No.	Interior Hardware RACKS	Sug. Ret. \$ EA
	BX1013	<b>Coat Rack, 3 Hooks</b> 11 <sup>7</sup> / <sub>8</sub> " x 1 <sup>1</sup> / <sub>2</sub> " White/Polished Chrome	41.00
	BX1015	<b>Coat Rack, 5 Hooks</b> 21" x 1 <sup>1</sup> / <sub>2</sub> " White/Polished Chrome	54.00
	BB1073 BX1073	<b>Coat and Hat Rack, Triple</b> 13 <sup>5</sup> / <sub>8</sub> " x 2 <sup>1</sup> / <sub>2</sub> ". Hook Height 5 <sup>3</sup> / <sub>8</sub> " Black/Satin Aluminium White/Satin Aluminium	91.00 91.00
	BB1074 BX1074	<b>Coat and Hat Rack, Five</b> 23 <sup>3</sup> / <sub>4</sub> " x 2 <sup>1</sup> / <sub>2</sub> ". Hook Height 5 <sup>3</sup> / <sub>8</sub> " Black/Satin Aluminium White/Satin Aluminium	149.00 149.00
	BB1075 BX1075	<b>Coat Rack, Triple</b> 13 <sup>5</sup> / <sub>8</sub> " x 2 <sup>1</sup> / <sub>2</sub> ". Hook Height 2 <sup>1</sup> / <sub>2</sub> " Black/Satin Aluminium White/Satin Aluminium	83.00 83.00
	BB1076 BX1076	<b>Coat Rack, Five</b> 23 <sup>3</sup> / <sub>4</sub> " x 2 <sup>1</sup> / <sub>2</sub> ". Hook Height 2 <sup>1</sup> / <sub>2</sub> " Black/Satin Aluminium White/Satin Aluminium	119.00 121.00
	BX1004	<b>Coat Rack, Quadruple</b> 12" x 1 <sup>1</sup> / <sub>2</sub> " Hook Height 3 <sup>1</sup> / <sub>8</sub> " Chrome Stainless Steel/White	81.00
	BB1014 BX1014	<b>Coat and Hat Rack, Quadruple</b> 12" x 1 <sup>1</sup> / <sub>2</sub> " Hook Height 4 <sup>3</sup> / <sub>4</sub> " Chrome Stainless Steel/Black Chrome Stainless Steel/White	89.00 89.00

Article No.	BATHROOM ACCESSORIES Free Standing	Sug. Ret. \$ EA
-------------	---------------------------------------	--------------------



	<b>Soap Dish</b> Diameter 5"	
BB560	Matte Black Polyresin	26.00
BX560	Matte White Polyresin	26.00
	<b>Soap Dispenser</b> Height 5.25"	
BB561	Matte Black Polyresin	42.00
BX561	Matte White Polyresin	42.00
	<b>Tumbler</b> Height 4.25"	
BB562	Matte Black Polyresin	26.00
BX562	Matte White Polyresin	26.00
	<b>Toilet Brush</b> Height 14"	
BB563	Matte Black Polyresin	65.00
BX563	Matte White Polyresin	65.00
	<b>Pedal bin, 1 gallon</b> <b>Soft close</b> Height 10" Diameter 8"	
BB564	Matte Black Plastic	81.00
BX564	Matte White Plastic	81.00
F971	Bin liner, 1.5 gallon (40 pcs)	19.00



Article No.	BATHROOM ACCESSORIES Free Standing	Sug. Ret. \$ EA
		
	<b>Soap Dish, Plastic</b> 7" x 3.75"	
BB570	Matte Black	18.00
BE570	Sand	18.00
BG570	Eucalyptus	18.00
BX570	Matte White	18.00
		
	<b>Soap Dispenser, Plastic</b> Height 5"	
BB571	Matte Black	24.00
BE571	Sand	24.00
BG571	Eucalyptus	24.00
BX571	Matte White	24.00
		
	<b>Tumbler, Plastic</b> Height 4"	
BB572	Matte Black	18.00
BE572	Sand	18.00
BG572	Eucalyptus	18.00
BX572	Matte White	18.00
		
	<b>Toilet Brush, Plastic</b> Height 14"	
BB573	Matte Black	48.00
BE573	Sand	48.00
BG573	Eucalyptus	48.00
BX573	Matte White	48.00
		
	<b>Pedal bin, 1 gallon, Plastic</b> <b>Soft close</b> Height 10" Diameter bottom 8.5"	
BB574	Matte Black	81.00
BE574	Sand	81.00
BG574	Eucalyptus	81.00
BX574	Matte White	81.00
F971	Bin liner, 1.5 gallon (40 pcs)	19.00

Article No.	BATHROOM ACCESSORIES Free Standing	Sug. Ret. \$ EA
-------------	---------------------------------------	--------------------



	<b>Toilet Roll Holder/Spare Toilet Roll Holder</b> Free Standing Height 22"	
BB1220	Black Stainless Steel	103.00
BK1220	Chromed Stainless Steel	98.00



	<b>Toilet Roll Holder/Spare Toilet Roll Holder</b> Free Standing Height 22" Base Plate diameter 7"	
BB1230	Black Steel	113.00
BX1230	White Steel	108.00

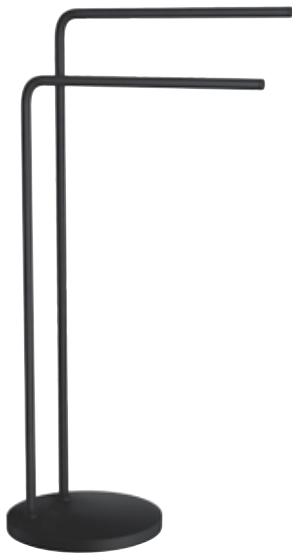

	<b>Double Towel Rail</b> Free Standing Height 31.5" Base Plate diameter 10" Length of Rails 16"	
BB1231	Black Steel	172.00
BX1231	White Steel	161.00



	<b>Toilet Brush</b> Free Standing Height 14 1/2"	
BB1233	Black Steel	103.00
BX1233	White Steel	98.00
B3330B	Spare Brush Black	20.00



	<b>Pedal bin, 1 gallon, Soft close</b> Height 9" 8.25" x 8.25"	
BB575	Matte Black Plastic	81.00
BX575	Matte White Plastic	81.00
F971	Bin liner, 1.5 gallon (40 pcs)	19.00

Article No.	BATHROOM ACCESSORIES Make-up Mirrors	Sug. Ret. \$ EA
-------------	---	--------------------



Z625	<p><b>Make-up Mirror</b> Free Standing LED Light Rechargeable battery, charge with USB (battery and cord included) Magnifies 7 times Mirror Diameter 8" Height 13" Chromed</p>	139.00
------	--	--------



Z626	<p><b>Make-up Mirror</b> Wall mounted LED Light Rechargeable battery, charge with USB (battery and cord included) Magnifies 7 times Mirror Diameter 8" Arm length 13" Chromed</p>	207.00
------	---	--------



Z627	<p><b>Make-up Mirror</b> Free Standing Two sides - Normal and magnifies 7 times Mirror Diameter 7" Height 14" Chromed</p>	78.00
------	---	-------



Z628	<p><b>Make-up Mirror</b> Wall mounted Two sides - Normal and magnifies 7 times Mirror Diameter 7" Arm Length 8.5" Chromed</p>	154.00
------	---	--------



Article No.	BATHROOM LINE - CUBE Stainless Steel	Sug. Ret. \$ EA
	<b>Toilet Roll Holder</b> Length 142 mm	
BB4411	Matte Black	35.00
BK4411	Polished Stainless Steel	35.00
	<b>Toilet Roll Holder</b>	
BB441	Matte Black	48.00
BK441	Polished Stainless Steel	48.00
	<b>Toilet Brush</b> Height 370 mm	
BB1035	Matte Black	98.00
BK1035	Polished Stainless Steel	102.00
B3330B	<i>Spare Black Brush</i>	20.00
	<b>Single Hook, mini</b> 30 x 30 mm	
BB4455	Matte Black	18.00
BK4455	Polished Stainless Steel	18.00
	<b>Single Hook</b> 48 x 48 mm	
BB455	Matte Black	22.00
BK455	Polished Stainless Steel	22.00
	<b>Double Hook</b> Length 96 mm	
BB456	Matte Black	35.00
BK456	Polished Stainless Steel	35.00
	<b>Triple Hook</b> Length 192 mm	
BB459	Matte Black	55.00
BK459	Polished Stainless Steel	55.00
	<b>Single Towel Rail</b> Total Length 633 mm	
BB4464	Matte Black	71.00
BK4464	Polished Stainless Steel	71.00



**Note** that the surface to be bonded must be well cleaned and dry. Please allow the adhesive 24 hours to harden before using.





Article No.	HOOKS Stainless Steel	Sug. Ret. \$ EA
-------------	--------------------------	--------------------



	<b>Design Single Hook mini</b> Diameter 1 1/8"	
B1080	Brushed Stainless Steel	9.00
B1080/4	Brushed Stainless Steel, 4 pcs	35.00
BB1080	Black	9.00
BB1080/4	Black, 4 pcs	35.00
BK1080	Polished Stainless Steel	9.00
BK1080/4	Polished Stainless Steel, 4 pcs	35.00
BX1080	White	9.00
BX1080/4	White, 4 pcs	35.00



	<b>Design Single Hook mini</b> 1 1/8" x 1 1/8"	
B1082	Brushed Stainless Steel	9.00
BB1082	Black Stainless Steel	9.00
BK1082	Polished Stainless Steel	9.00



	<b>Design Double Hook mini</b> 3 1/2" x 1 1/8"	
B1081	Brushed Stainless Steel	21.00
BK1081	Polished Stainless Steel	22.00



	<b>Design Quadruple Hook mini</b> 8 1/2" x 1 1/8"	
B1083	Brushed Stainless Steel	33.00
BK1083	Polished Stainless Steel	35.00



	<b>Design Single Hook</b> Diameter 2"	
B1090	Brushed Stainless Steel	17.00
BB1090	Black	18.00
BK1090	Polished Stainless Steel	18.00
BX1090	White	18.00



	<b>Design Double Hook</b> Length 3 1/2"	
B1091	Brushed Stainless Steel	28.00
BB1091	Black	30.00
BK1091	Polished Stainless Steel	30.00
BX1091	White	30.00



	<b>Design Quadruple Hook</b> Length 7 3/5"	
B1094	Brushed Stainless Steel	49.00
BB1094	Black	51.00
BK1094	Polished Stainless Steel	51.00
BX1094	White	51.00



	<b>Design Toilet Roll Holder</b>	
B1097	Brushed Stainless Steel	55.00
BB1097	Black	55.00
BK1097	Polished Stainless Steel	55.00
BX1097	White	55.00



Article No.	BATHROOM ACCESSORIES Stainless Steel	Sug. Ret. \$ EA
-------------	---	--------------------



	<b>Towel Rail</b> Length 22 1/2"	
B1026	Brushed Stainless Steel	85.00
BB1026	Black Stainless Steel	70.00
BK1026	Chromed Stainless Steel	85.00



	<b>Toilet Roll Holder</b> Length 6.25"	
B1029	Brushed Stainless Steel	40.00
BB1029	Black Stainless Steel	40.00
BK1029	Chromed Stainless Steel	40.00



	<b>Towel Ring</b> Ring Diameter 6 1/2"	
B1028	Brushed Stainless Steel	102.00
BB1028	Black Stainless Steel	83.00
BK1028	Chromed Stainless Steel	102.00



	<b>Toilet Brush</b> Height 14 1/2"	
B1035	Brushed Stainless Steel	107.00
BB1035	Black Stainless Steel	103.00
BK1035	Polished Stainless Steel	107.00
B3330B	<i>Spare Brush Black</i>	21.00



Article No.	HOOKS Stainless Steel	Sug. Ret. \$ EA
-------------	--------------------------	--------------------

	<b>Single Hook, Hexagon</b> 1 3/4" x 2"	
BB1160	Black	18.00
BK1160	Polished Stainless Steel	18.00



	<b>Design Single Hook</b> 1 3/4" x 1 3/4"	
B1092	Brushed Stainless Steel	17.00
BB1092	Black	18.00
BK1092	Polished Stainless Steel	18.00
BX1092	White	18.00



	<b>Design Double Towel Hook</b> Length 3 1/2"	
B1093	Brushed Stainless Steel	28.00
BB1093	Black	30.00
BK1093	Polished Stainless Steel	30.00
BX1093	White	30.00



	<b>Design Quadruple Hook</b> Length 7"	
B1096	Brushed Stainless Steel	49.00
BB1096	Black	51.00
BK1096	Polished Stainless Steel	55.00
BX1096	White	51.00



	<b>Design Toilet Roll Holder</b>	
B1098	Brushed Stainless Steel	55.00
BB1098	Black	55.00
BK1098	Polished Stainless Steel	55.00
BX1098	White	55.00



	<b>Design Single Hook</b> 1 3/4" x 1 3/4"	
B1105	Brushed Stainless Steel	21.00
BB1105	Black	26.00
BK1105	Polished Stainless Steel	22.00



	<b>Design Double Hook</b> 3 1/2" x 1 3/4"	
B1106	Brushed Stainless Steel	33.00
BB1106	Black	40.00
BK1106	Polished Stainless Steel	35.00



	<b>Design Triple Hook</b> 7" x 1 3/4"	
B1107	Brushed Stainless Steel	49.00
BB1107	Black	54.00
BK1107	Polished Stainless Steel	50.00



Article No.	BATHROOM ACCESSORIES Stainless Steel	Sug. Ret. \$ EA
-------------	---	--------------------



	<b>Towel Rail</b> Length 22 1/2"	
B1036	Brushed Stainless Steel	85.00
BB1036	Black Stainless Steel	70.00
BK1036	Polished Stainless Steel	85.00



	<b>Toilet Roll Holder</b> Length 6.25"	
B1039	Brushed Stainless Steel	40.00
BB1039	Black Stainless Steel	40.00
BK1039	Polished Stainless Steel	40.00



	<b>Towel Ring</b> Ring 6 1/2" x 6 1/2"	
B1038	Brushed Stainless Steel	102.00
BB1038	Black Stainless Steel	83.00
BK1038	Chromed Stainless Steel	102.00



	<b>Toilet Brush</b> Height 14 1/2"	
B1035	Brushed Stainless Steel	107.00
BB1035	Black Stainless Steel	103.00
BK1035	Polished Stainless Steel	107.00
B3330B	<i>Spare Brush Black</i>	21.00



Self-adhesive



Article No.	HOOKS Stainless Steel	Sug. Ret. \$ EA
	<b>Design Single Hook</b> Diameter 2"	
B1084	Brushed/Black Knob	20.00
BK1084	Polished/Black Knob	21.00
BK1085	Polished/White Knob	21.00
	<b>Design Single Hook</b> Diameter 2"	
B1101	Brushed Stainless Steel	21.00
BB1101	Black Stainless Steel	26.00
BK1101	Polished Stainless Steel	22.00
	<b>Design Double Towel Hook</b> Length 3 1/2"	
B1102	Brushed Stainless Steel	33.00
BB1102	Black Stainless Steel	40.00
BK1102	Polished Stainless Steel	35.00
	<b>Design Triple Hook</b> Length 7 3/4"	
B1103	Brushed Stainless Steel	49.00
BB1103	Black Stainless Steel	54.00
BK1103	Polished Stainless Steel	50.00
	<b>Design Single Hook</b> Diameter 2"	
BA1120	Antique Brass Finish	18.00
BG1120	Pewter	18.00
BK1120	Polished Chrome	18.00
	<b>Design Double Hook</b> 3 1/2" x 2"	
BA1121	Antique Brass Finish	30.00
BG1121	Pewter	30.00
BK1121	Polished Chrome	30.00
	<b>Design Triple Hook, Swingable</b> 2" x 3 1/2"	
BK1123	Polished Chrome	57.00
	<b>Design Quadruple Hook</b> Length 7 3/5"	
BA1124	Antique Brass Finish	51.00
BG1124	Pewter	51.00
BK1124	Polished Chrome	51.00
	<b>Design Toilet Roll Holder</b>	
BA1127	Antique Brass Finish	55.00
BG1127	Pewter	55.00
BK1127	Polished Chrome	55.00

**Note** that the surface to be bonded must be well cleaned and dry. Please allow the adhesive 24 hours to harden before using.

Article No.	BATHROOM ACCESSORIES Stainless Steel	Sug. Ret. \$ EA
-------------	---	--------------------



	<b>Toilet Roll Holder</b>	
B1130	Brushed Stainless Steel	37.00
BB1130	Black Stainless Steel	37.00
BK1130	Chromed Stainless Steel	37.00



	<b>Toilet Roll Holder</b>	
B1132	Brushed Stainless Steel	37.00
BB1132	Black Stainless Steel	37.00
BK1132	Chromed Stainless Steel	37.00



	<b>Tea Light Candle Holder</b> 1 3/4" x 2 3/4"	
B1180	Brushed Stainless Steel	33.00
BK1180	Polished Stainless Steel	35.00

## ACCESSORIES



	<b>Door Hook,</b> Depth 1 1/8" 3 1/4" x 2 1/2" Inside measurement 1 3/4"	
B1095	Brushed Stainless Steel	28.00
BK1095	Polished Stainless Steel	29.00



	<b>Self-adhesive sheets</b> for adhesive products 3M Adhesive Sheets (2 pcs) 6" x 7 7/8"	
B698	3M White	18.00



	<b>Spare Brush Black</b> For Toilet Brush B/BB/BK1035, BB/BK333 and BB/BX1233	
B3330B	Black Plastic PP	21.00



Article No.	BASKETS Stainless Steel	Sug. Ret. \$ EA
-------------	----------------------------	--------------------

**Shower Basket**

10" x 4 3/4"

Height 3"

Holder 2 1/2"

B1200	Polished Chrome on Stainless Steel	64.00
BB1200	Black Stainless Steel	71.00

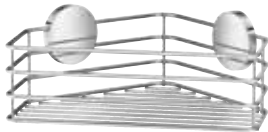

**Single Corner Shower Basket**

10" x 8"

Height 3"

Holder 2 1/2"

B1201	Polished Chrome on Stainless Steel	64.00
BB1201	Black Stainless Steel	71.00



**Double Shower Basket**

10" x 4 3/4"

Height 12 1/2"

Holder 2 1/2"

B1202	Polished Chrome on Stainless Steel	123.00
BB1202	Black Stainless Steel	126.00



**Double Corner Shower Basket**

10" x 8"

Height 12 1/2"

Holder 2 1/2"

B1203	Polished Chrome on Stainless Steel	123.00
BB1203	Black Stainless Steel	126.00



**Spare Brackets, Pair**

Diameter 2 1/2"

B12SP	Polished Chrome on Stainless Steel	40.00
BB12SP	Black Stainless Steel	40.00



**Shower Squeegee with Hook**

To hang on Shower baskets or  
Glass Shower Panel

8.25" x 10"

BB1310	Black Silicone	78.00
BG1310	Grey Silicone	78.00

**Article No.      EXTERIOR HARDWARE  
Bell Push in Metal**

**Sug. Ret.  
\$ EA**



Article No.	EXTERIOR HARDWARE Bell Push in Zinc	Sug. Ret. \$ EA
	<b>Bell Push in Zinc</b> 1 1/8" x 2 1/2"	
B110M	Brushed Brass Finish	60.00
B111KM	Brushed Chrome	60.00
B112	Black	60.00

**EXTERIOR HARDWARE  
Door Knocker in Metal**



Article No.	EXTERIOR HARDWARE Door Knocker in Zinc	Sug. Ret. \$ EA
	<b>Door Knocker in Zinc</b> Format 4 1/2" x 5"	
	Wood screw mounting	
B098M	Brushed Brass Finish	109.00
B098KM	Brushed Chrome	109.00
B099	Black	109.00



Article No.	EXTERIOR HARDWARE Door Stop	Sug. Ret. \$ EA
	<b>Door Stop in Stainless Steel</b> Length 1 <sup>3</sup> / <sub>4</sub> "	
	BK147 Stainless Steel Polished/Black rubber 29.00 BK147M Stainless Steel Brushed/Black rubber 29.00	
	<b>Door Stop in Stainless Steel</b> Length 3"	
	BK148 Stainless Steel Polished/Black rubber 38.00 BK148M Stainless Steel Brushed/Black rubber 38.00	
	<b>Door Stop for Floor</b> Length 4 <sup>3</sup> / <sub>4</sub> " Height 1 <sup>1</sup> / <sub>4</sub> "	
	BB150 Black rubber 19.00	
	BG150 Grey rubber 19.00	
	B150C Orange rubber - Clementine 19.00	
	B150D Bluegrey rubber - Dusk 19.00 B150L Green rubber - Lime 19.00	
	<b>Door Stop for Handle, Pair</b> Length 1 <sup>1</sup> / <sub>4</sub> " Height <sup>3</sup> / <sub>4</sub> "	
	BB151 Black rubber 15.00	
	BG151 Grey rubber 15.00	
	B151C Orange rubber - Clementine 15.00	
	B151D Bluegrey rubber - Dusk 15.00 B151L Green rubber - Lime 15.00	
	<b>Door Stop for Floor</b> Height 1" Diameter 2" Mounting: Screw and/or Self-adhesive	
	BB152 Black rubber/Brushed Stainless 33.00 BG152 Grey rubber/Brushed Stainless 33.00	
	<b>Door Stop for Wall</b> Self-adhesive Depth <sup>1</sup> / <sub>2</sub> " Diameter 1 <sup>1</sup> / <sub>2</sub> "	
	BB153 Black rubber/Brushed Stainless 24.00 BG153 Grey rubber/Brushed Stainless 24.00	
	<b>Door Stop for Floor or Wall</b> Height 3" Diameter 2" Mounting: Screw and/or Self-adhesive	
	BB154 Black rubber/Brushed Stainless 43.00 BG154 Grey rubber/Brushed Stainless 43.00	



Article No.	NORDIC House Number Stainless Steel	Sug. Ret. \$ EA
-------------	-------------------------------------	-----------------

**BESLAGSBODEN Numbers and Letters i Stainless Steel.**

Complete with screws, spacers and plugs.



<b>Matte Black</b>		
BB780	Number 0	58.00
BB781	Number 1	58.00
BB782	Number 2	58.00
BB783	Number 3	58.00
BB784	Number 4	58.00
BB785	Number 5	58.00
BB786	Number 6	58.00
BB787	Number 7	58.00
BB788	Number 8	58.00
BB789	Number 9	58.00
BB790	Letter A	58.00
BB791	Letter B	58.00
BB792	Letter C	58.00

<b>Matte Grey</b>		
BG780	Number 0	58.00
BG781	Number 1	58.00
BG782	Number 2	58.00
BG783	Number 3	58.00
BG784	Number 4	58.00
BG785	Number 5	58.00
BG786	Number 6	58.00
BG787	Number 7	58.00
BG788	Number 8	58.00
BG789	Number 9	58.00
BG790	Letter A	58.00
BG791	Letter B	58.00
BG792	Letter C	58.00

Height of number: 9.25"

Height of letter: 6.25"

0123456789ABC

Article No.	VILLA House Number Stainless Steel	Sug. Ret. \$ EA
-------------	---------------------------------------	--------------------



BESLAGSBODEN Numbers and Letters in Zinc Alloy. Complete with screws, spacers and plugs.

<b>Brushed Brass</b>		
V000	Number 0	30.00
V001	Number 1	30.00
V002	Number 2	30.00
V003	Number 3	30.00
V004	Number 4	30.00
V005	Number 5	30.00
V006	Number 6	30.00
V007	Number 7	30.00
V008	Number 8	30.00
V009	Number 9	30.00
V010	Letter A	30.00
V011	Letter B	30.00
V012	Letter C	30.00
<b>Black</b>		
V020	Number 0	35.00
V021	Number 1	35.00
V022	Number 2	35.00
V023	Number 3	35.00
V024	Number 4	35.00
V025	Number 5	35.00
V026	Number 6	35.00
V027	Number 7	35.00
V028	Number 8	35.00
V029	Number 9	35.00
V030	Letter A	35.00
V031	Letter B	35.00
V032	Letter C	35.00
<b>Brushed Chrome</b>		
V980 *	Number 0	39.00
V981 *	Number 1	39.00
V982 *	Number 2	39.00
V983 *	Number 3	39.00
V984 *	Number 4	39.00
V985 *	Number 5	39.00
V986 *	Number 6	39.00
V987 *	Number 7	39.00
V988 *	Number 8	39.00
V989 *	Number 9	39.00
V990 *	Letter A	39.00
V991 *	Letter B	39.00
V992 *	Letter C	39.00

Height of number: 4 3/4"  
Height of letter: 4 1/8"

# 1234567890 ABC

Article No.	SMEDBO House Number Wrought Iron	Sug. Ret. \$ EA
-------------	-------------------------------------	--------------------

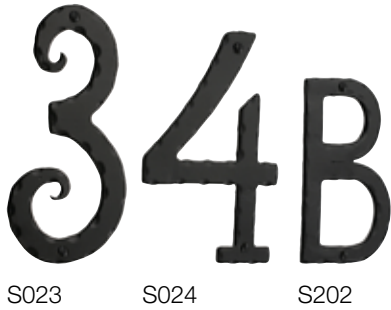

**BESLAGSBODEN Numbers and Letters in Wrought Iron.**

Complete with screws, spacers and plugs.

<b>Black</b>		
S020	Number 0	51.00
S021	Number 1	51.00
S022	Number 2	51.00
S023	Number 3	51.00
S024	Number 4	51.00
S025	Number 5	51.00
S026	Number 6	51.00
S027	Number 7	51.00
S028	Number 8	51.00
S029	Number 9	51.00
S201	Letter A	51.00
S202	Letter B	51.00
S203	Letter C	51.00

Height of number: 6"  
Height of letter: 4 3/4"

1234567890 ABC



Article No.	House Number Stainless Steel	Sug. Ret. \$ EA
-------------	---------------------------------	--------------------

**BESLAGSBODEN Numbers and Letters i Stainless Steel.**

Complete with screws, spacers and plugs.

<b>Brushed Stainless Steel</b>		
B940	Number 0	39.00
B941	Number 1	39.00
B942	Number 2	39.00
B943	Number 3	39.00
B944	Number 4	39.00
B945	Number 5	39.00
B946	Number 6	39.00
B947	Number 7	39.00
B948	Number 8	39.00
B949	Number 9	39.00
B950	Letter A	39.00
B951	Letter B	39.00
B952	Letter C	39.00
B953	Letter D	39.00

<b>Black Stainless Steel</b>		
BB940	Number 0	41.00
BB941	Number 1	41.00
BB942	Number 2	41.00
BB943	Number 3	41.00
BB944	Number 4	41.00
BB945	Number 5	41.00
BB946	Number 6	41.00
BB947	Number 7	41.00
BB948	Number 8	41.00
BB949	Number 9	41.00
BB950	Letter A	41.00
BB951	Letter B	41.00
BB952	Letter C	41.00

Height of number: 6"  
Height of letter: 4 3/4"

# 0123456789 ABCD

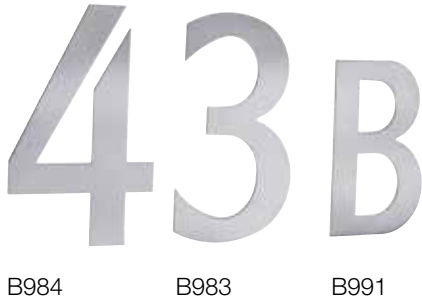

Article No.	Mailbox Number Stainless Steel	Sug. Ret. \$ EA
-------------	-----------------------------------	--------------------

BESLAGSBODEN Numbers and Letters in Stainless Steel.

**Brushed Stainless Steel**

B980	Number 0	21.00
B981	Number 1	21.00
B982	Number 2	21.00
B983	Number 3	21.00
B984	Number 4	21.00
B985	Number 5	21.00
B986	Number 6	21.00
B987	Number 7	21.00
B988	Number 8	21.00
B989	Number 9	21.00
B990	Letter A	21.00
B991	Letter B	21.00
B992	Letter C	21.00
B993	Letter D	21.00

**Black Stainless Steel**

BB980	Number 0	21.00
BB981	Number 1	21.00
BB982	Number 2	21.00
BB983	Number 3	21.00
BB984	Number 4	21.00
BB985	Number 5	21.00
BB986	Number 6	21.00
BB987	Number 7	21.00
BB988	Number 8	21.00
BB989	Number 9	21.00
BB990	Letter A	21.00
BB991	Letter B	21.00
BB992	Letter C	21.00

Height of number: 2"  
Height of letter: 1 3/4"

# 0123456789 ABCD

# DISPLAY BOARDS



Board Item #	Description Mixed Finishes	Display Price	Board Item #	Description Mixed Finishes	Display Price
<i>This is an average price and we run specials</i>			<i>This is an average price and we run specials</i>		
<b>AIR Bath Line</b>			<b>POOL Bath Line</b>		
X377/4		207.00	X379/4		207.00
X377/6		414.00	X379/6		414.00
<b>HOME Bath Line</b>			<b>VILLA Bath Line</b>		
X395/4		207.00	X362/4		207.00
X395/6		414.00	X362/6		414.00
<b>HOUSE Bath Line</b>			<b>SIDELINE &amp; COLLECTION baskets</b>		
X398/4		207.00	Sideline Design All Finishes		
X398/6		414.00	X981S		207.00
<b>ICE Bath Line Mixed Board</b>			X981		414.00
X399/4		207.00	<b>Hardware Boards - Displays</b>		
X399/6		414.00	X995V	Numeral, Knocker, Bell Push	414.00
<b>LIVING Bath Line Mixed Board</b>			X996VS	Cabinet Hardware	207.00
X278/6		414.00	X996V	Cabinet Hardware	414.00
			X997VS	Decorative Hooks	207.00
			X997V	Decorative Hooks	414.00
			X998V	Mixed Hook Racks	414.00
			X999	Self-adhesive Bath	414.00

**DISPLAY BOARDS:**

White 32" x 18"

White 16" x 18"

## BROCHURES SMEDBO

---



X117



X124



X1060 (+X40)

- X40 Life in your bathroom
- X115 BLACK by Smedbo
- X117 WHITE by Smedbo
- X121 LIVING by Smedbo
- X123 HOME Black by Smedbo
- X124 MIRRORS by Smedbo
- X127 BRUSHED BRASS by Smedbo
- X135 DOT by Smedby

- X1060 Magazine Rack (Polished Chrome)

## BROCHURES BESLAGSBODEN

---



X107



X114

- X107 Self-adhesive
- X108 Knobs / Drawer Handles
- X114 Hooks / Racks
- X120 NORDIC House Numbers
- X135 CUBE by Beslagsboden





# Warranty

---

## Product Warranty

Smedbo products are manufactured and tested to the highest quality standards. All Smedbo bath accessory products are warranted to the original consumer purchaser to be free from tarnishing and defects in material and workmanship for as long as the original consumer owns the home in which the products are installed. The Smedbo 10 Year Limited Consumer Warranty applies to all finishes in the following lines:

Air, Dot, Home, House, Ice, Living, Pool, Outline, Outline Lite, Villa and Xtra.

The following Smedbo items carry a 5 Year Warranty to be free from tarnishing and defects in material and workmanship for as long as the original consumer owns the home in which the products are installed:

Knobs  
Hooks  
Drawer Handles  
House & Mailbox Numbers  
Door Knockers  
Door stops  
Bell Pushes  
Beslagsboden Bath Self-adhesive  
Outline Lite only Step Cans

## WARRANTY DOES NOT COVER:

This warranty does not cover glass, squeegees, blades, soap pumps after 1 year, installation or any other labor charges associated with the repair or reinstallation of Smedbo products. This warranty does not cover damage caused by accident, fire, Acts of God, alterations, misuse, abuse, improper installation, hard water, exposure to corrosive materials, or use in any manner contrary to the printed instructions. Installation compounds are harmful to brass and metal finishes. The use of any lead based acidic curing adhesive, silicone, mastic, or plumber's putty on or near Smedbo brass products will void the finish warranty. If sealants are required, use sealants that are neutral curing and are not reactive with metal and brass finishes.

Smedbo will repair or replace, at its option, free of charge during the warranty period, any part which proves to be defective. If Smedbo is unable to provide a replacement and repair is not practical or cannot be made in a timely manner, Smedbo will refund the purchase price in exchange for return of the product. This warranty only covers defective parts and finishes. Labor charges and/or damage incurred in the installation, removal, repair or replacement as well as any other kind of loss or damage is excluded. This warranty is extended in lieu of all other expressed or implied warranties, whether oral or written.

Smedbo does not make any other warranty of any kind, including the implied warranty of merchantability. This warranty excludes all industrial, commercial and business usage, whose purchases are extended a commercial warranty on a per project basis (contact your local Smedbo dealer for details).

Some states do not allow the exclusion or limitation of the incidental or consequential damages, so the abuse limitation or exclusion may not apply to you. This warranty gives you specific legal rights, and you may also have other rights which may vary from state to state. Unless otherwise contrary to state law governing the purchase, Smedbo liability will not exceed the contract price for the product claimed to be defective or unsuitable and is applicable only to products purchased through Smedbo, and installed in the United States or Canada.

For all warranty inquiries, please contact SMEDBO, Inc. at [customerservice@smedbo.com](mailto:customerservice@smedbo.com)



*Worldwide Headquarters:*

**Smedbo AB**  
Box 13063  
S-250 13 HELSINGBORG  
Sweden  
Phone: +46 42-25 15 00  
E-mail: [info@smedbo.se](mailto:info@smedbo.se)

**USA**  
Smedbo Inc  
Phone: 847-615-0000  
Fax: 847-615-1001  
E-mail: [customerservice@smedbo.com](mailto:customerservice@smedbo.com)  
[www.smedbo.com](http://www.smedbo.com)  
[www.beslagsboden.com](http://www.beslagsboden.com)