

Valli.

handle creators

2023 USA

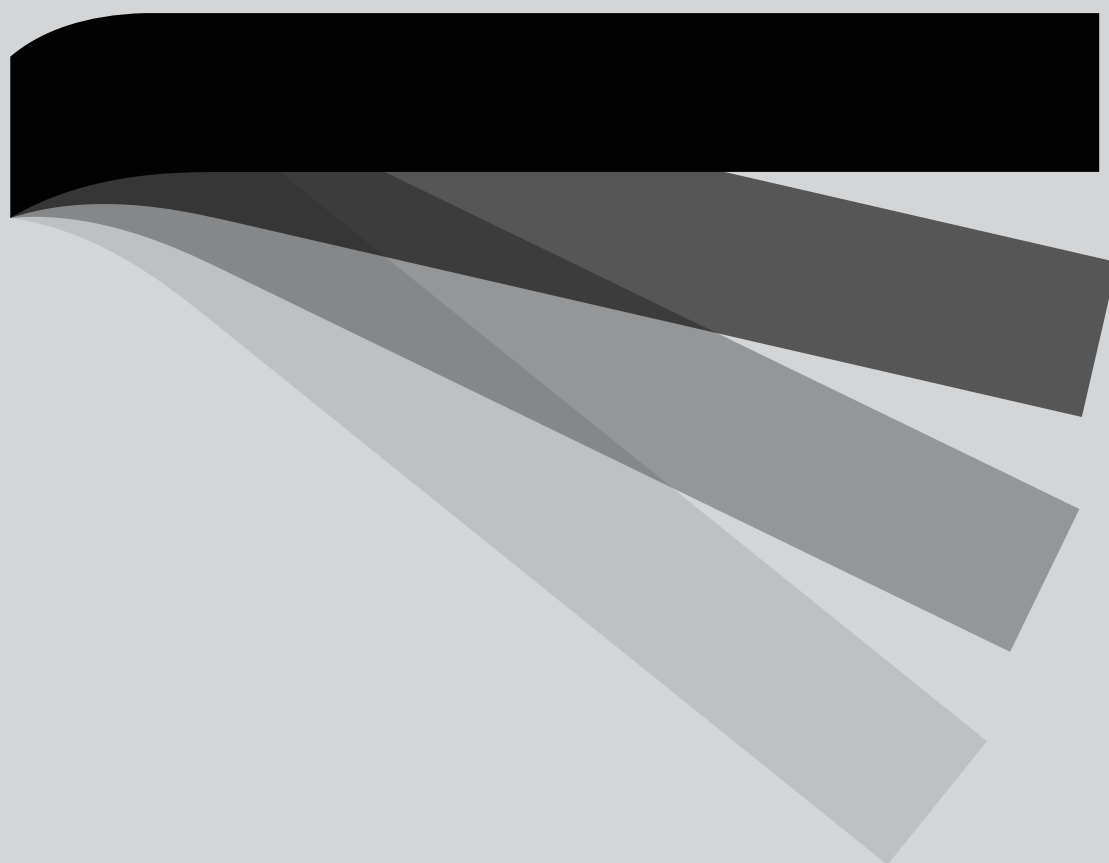

Price list

Valli.
handle creators

USA Price list 2023

Finishes [p. 12](#)
PRESTO / Quick ship [p. 18](#)
Affordable luxury [p. 19](#)
4 You [p. 16](#)











































Door levers [p. 20](#)

Door accessories

Door knobs [p. 106](#)
Door pulls [p. 120](#)
Entry handlesets [p. 136](#)
Pocket doors [p. 140](#)
Deadlock [p. 150](#)
Deadbolts [p. 152](#)
Privacy bolts [p. 154](#)
Escutcheon with deadbolts [p. 156](#)
Multipoint [p. 160](#)
Mortise locks [p. 168](#)
Coat hooks [p. 185](#)
Door stoppers [p. 184](#)
Miscellaneous parts [p. 186](#)



























Door thicknesses [p. 200](#)
Certifications [p. 203](#)
General sales terms and conditions [p. 204](#)

Fusital collection

| | | | | | |
|--|--|---|---|--|--|
| H 198 Eero Aarnio p. 28  | H 311 Mario Bellini p. 29  | H 315 Pierluigi Cerri p. 30  | H 317 Antonio Citterio p. 31  | H 327 Antonio Citterio p. 32  | H 329 Taller Design Ricardo Bofill p. 33  |
| H 330 Matteo Thun p. 34  | H 334 Foster + Partners p. 35  | H 335 Richard Meier p. 36  | H 338 Yoshimi Kono p. 37  | H 343 John Pawson p. 38  | H 348 David Chipperfield p. 39  |
| H 356 Zaha Hadid p. 40  | H 359 SOM - Skidmore, Owings & Merrill p. 41  | H 361 Antonio Citterio with Toan Nguyen p. 42  | H 364 Mario Bellini p. 43  | H 367 Giancarlo Vegni p. 44  | H 368 Cerri & Associati p. 45  |
| H 370 Doriane e Massimiliano Fuksas p. 46  | H 372 Eri Goshen p. 47  | H 376 Giancarlo Vegni p. 48  | H 377 Steve Leung p. 49  | H 378 Yabu Pushelberg p. 50  | H 379 Antonio Citterio p. 51  |
| H 380 Antonio Citterio p. 52  | H 381 Khalid Al Najjar p. 53  | H 382 Joe Cheng p. 54  | H 383 Perkins & Will p. 55  | H 384 CetraRuddy Architecture D.P.C. p. 56  | H 385 Federica Biasi p. 57  |
| H 386 Meneghello Paolelli p. 58  | H 1003 Matteo Thun p. 64  | H 1026 Antonio Bullo p. 69  | H 1039 Jean-Baptiste Sibertin Blanc p. 72  | H 1040 Gabriele e Oscar Buratti p. 73  | H 1043 Matteo Thun p. 74  |
| H 1044 Vincent Van Duysen p. 75  | H 1044 U Vincent Van Duysen p. 76  | H 1045 Yoshimi Kono p. 77  | H 1052 Mikhail Leykin p. 81  | H 1060 SOM - Skidmore, Owings & Merrill p. 86  | H 1061 Di Virgilio Veneziano p. 87  |

| | | | | | |
|--|--|---|---|---|---|
| H 1066 Bertone Design p. 89  | H 1068 Pembroke & Ives p. 90  | H 5008 Taller Design Ricardo Bofill p. 95  | H 5014 Bernina p. 96  | H 5015 Antonio Citterio H 5015 with leather p. 97-98  | H 5017 Hans Kollhoff p. 99  |
|--|--|---|---|---|---|

Lab collection

| | | | | | |
|--|--|--|---|--|--|
| H 163 Sarissa p. 24  | H 165 Germana p. 25  | H 176 Spiga p. 26  | H 192 Prunus p. 27  | H 1004 Antares p. 65  | H 1016 Nabucco p. 66  |
| H 1022 Ernani p. 67  | H 1024 Lolita p. 68  | H 1027 Dafne p. 70  | H 1037 Teseo p. 71  | H 1046 Nais p. 78  | H 1049 Divara p. 79  |
| H 1050 Giasone p. 80  | H 1054 W.W. p. 82  | H 1056 Quadra p. 83  | H 1057 Retrò p. 84  | H 1058 Amica p. 85  | H 1062 Carmen p. 88  |
| H 1069 Susannah p. 91  | H 1748 Estrella p. 92  | H 411 Leila p. 59  | H 414 Amber p. 60  | H 415 Scarlet p. 61  | H 416 Garnet p. 62  |
| H 419 Bordeaux p. 63  | H 4730 White p. 93  | H 4742 Coral p. 94  | | | |

Door pulls Fusital collection

K 352 Richard Meier
p. 120



K 353 Taller Design
Ricardo Bofill
p. 120



K 356 John Pawson
p. 121



K 358 Cerri & Associati
p. 121



K 368 Antonio Citterio
with Toan Nguyen
p. 122



K 377 Steve Leung
p. 122



K 1228 Yoshimi Kono
p. 132



P 5405 Taller Design
Ricardo Bofill
p. 133



P 5406 Antonio Citterio
p. 134



P 5408 Antonio Citterio
p. 135



K 378 Yabu Pushelberg
p. 123

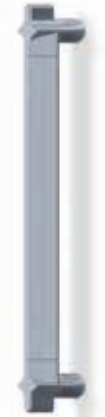

K 379 Antonio Citterio
p. 123



K 380 Antonio Citterio
p. 124



K 381 Khalid Al Najjar
p. 124



K 383 Perkins&Will
p. 125



K 385 Federica Biasi
p. 125



K 1054 W.W.
p. 126



K 1056 Quadra
p. 127



K 1069 Susannah
p. 129



K 1188
p. 129



K 1219
p. 130



K 1224
p. 131



Door pulls Lab collection

K 386 Meneghello
Paolelli
p. 126



K 1060 SOM - Skidmore,
Owings & Merrill
p. 127



K 1061 Di Virgilio
Veneziano
p. 128



K 1068 Pembroke
& Ives
p. 128



K 1210 Eero Aarnio
p. 130



K 1226 Jean-Baptiste
Sibertin Blanc
p. 131



K 1231
p. 132



K 1235
p. 133



Door knobs Fusital collection



Door knobs Lab collection



Handlesets



Pocket doors Fusital collection

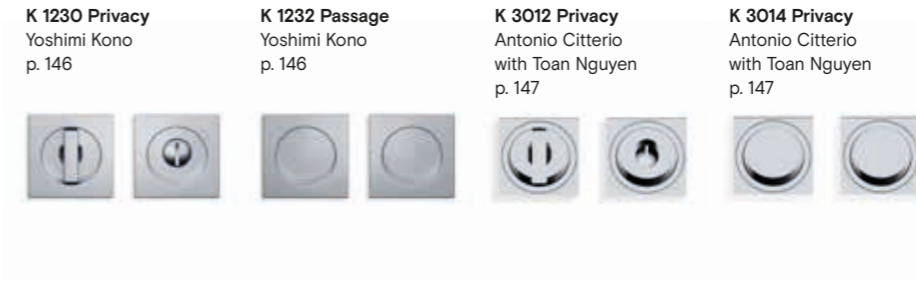

Pocket doors Lab collection



Finishes



32 Polished stainless steel
N1



32D Satin stainless steel
N2

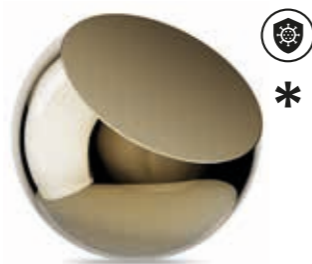

03 Polished brass
A



03D Satin brass
AB



03M Matt brass
AC



Unlaquered brass
B



Antique natural brass
BA



06B Brunito
(Dark brown - hand made)
BC



06A Anticato
(Antique brass)
BD



26 Polished chrome
C



26D Satin chrome
CA



14 Polished nickel
D



15 Satin nickel
DA



18 Satin black nickel
DC



10S Satin bronze
E



06M Matt bronze
EA



56 Dark bronze
ED



16 Dull black
F



22M Matt white
FB



55 Titanium PVD
H



17A Polished black nickel
L

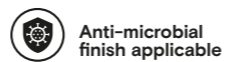

Anti-microbial
finish applicable



Available also
in PVD finish

Finishes of matching components

| Levers and knobs | | Corresponding face and strike | |
|------------------|--------------------------|-------------------------------|-----------------|
| 26 | Polished chrome | 26 | Polished chrome |
| 26D | Satin chrome | 26D | Satin chrome |
| 03 | Polished brass | 03 | Polished brass |
| 03D | Satin brass | 03D | Satin brass |
| 03D-PVD | Satin brass PVD | 03D | Satin brass |
| 03M | Matt brass | 03D | Satin brass |
| 06B | Brunito (Dark brown) | 06B | Brunito |
| 06A | Anticato (Antique brass) | 06 | Antique brass |
| 26-PVD | Polished chrome PVD | 26 | Polished chrome |
| 26D-PVD | Satin chrome PVD | 26D | Satin chrome |
| 17A | Polished black nickel | 14 | Polished nickel |
| 18 | Satin black nickel | 15 | Satin nickel |
| 32D | Satin stainless steel | 15 | Satin nickel |
| 14 | Nickel | 14 | Polished nickel |
| 15 | Satin nickel | 15 | Satin nickel |
| 10S-PVD | Satin bronze PVD | 06B | Brunito |
| 10S | Satin bronze | 06B | Brunito |
| 06M | Matt bronze | 06B | Brunito |
| 56 | Dark bronze | 06B | Brunito |
| 32 | Polished stainless steel | 14 | Polished nickel |
| 16 | Dull black | 16 | Dull black |
| 22M | Matt white | 22M | Matt white |
| 55-PVD | Titanium PVD | 15 | Satin nickel |
| B | Unlaquered brass | 03 | Polished brass |
| BA | Antique natural brass | 03D | Satin brass |
| BB | Antique brass | 06 | Antique brass |

BioCote® is an International approved technology that drastically reduces bacteria on the levers by up to 99.5% and the proliferation of microbes by up to 99.9%. PVD finishes may have slight tone differences compared to the corresponding traditional finishes.

Finishes matrix

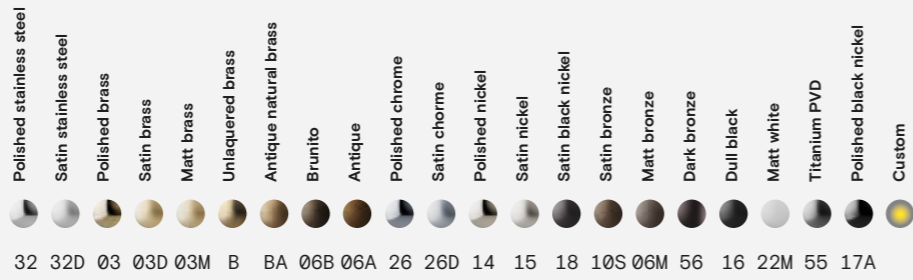

| | | 32 | 32D | 03 | 03D | 03M | B | BA | 06B | 06A | 26 | 26D | 14 | 15 | 18 | 10S | 06M | 56 | 16 | 22M | 55 | 17A | |
|-------|-----------------------------------|----|-----|----|-----|-----|---|----|-----|-----|----|-----|----|----|----|-----|-----|----|----|-----|----|-----|---|
| H 163 | Sarissa | | | | | | | | | | • | • | | | | | | | | | | | • |
| H 165 | Germana | | | • | • | | | | | • | | | | | | | | | | | | | • |
| H 176 | Spiga | | | • | | | | • | | | | | | | | | | | | | | | • |
| H 192 | Prunus | | | | | | | | | | | | | | • | | | | | | | | • |
| H 198 | Eero Aarnio | | | • | | | | | | • | | • | | • | | | | | | | | | • |
| H 311 | Mario Bellini | | | | | | | | | | • | • | • | • | | | | | | | | | • |
| H 315 | Pierluigi Cerri | | | • | | | | | | | • | | | | | | | | | | | | • |
| H 317 | Antonio Citterio | | | | | | | | | | • | • | | | | | | | | | | | • |
| H 327 | Antonio Citterio | | | • | | | | | | | • | | | | | | | | | | | | • |
| H 329 | Taller Design Ricardo Bofill | | | | | | | | | | • | | | | | | | • | | | | | • |
| H 330 | Matteo Thun | | | | | | | | | | | • | | | | | • | | | | | | • |
| H 334 | Foster + Partners | | | • | | | | | | | | • | | | | | | | | | | | • |
| H 335 | Richard Meier | | | | | | | | | | • | • | | | | | | | | | | | • |
| H 338 | Yoshimi Kono | | | | | | | | | | | • | | • | | | | | • | | | | • |
| H 343 | John Pawson | | | | | | | | | | • | • | • | • | | | | | | | | | • |
| H 348 | David Chipperfield | | | | | | | | | | • | • | • | • | | | | | | | | | • |
| H 356 | Zaha Hadid | | | | | | | | | | • | • | | | | | | | | | | | • |
| H 359 | SOM - Skidmore, Owings & Merrill | | | | | | | | | | • | • | • | • | | | • | | | | | | • |
| H 361 | Antonio Citterio with Toan Nguyen | | | | | | | | | | • | • | • | • | | | | | | | | | • |
| H 364 | Mario Bellini | | | | | | | | | | • | • | | • | | | | | | | | | • |
| H 367 | Giancarlo Vegni | | | | | | | | | | • | • | | | | | | | | | | | • |
| H 368 | Cerri & Associati | | | | | | | | | | • | • | | | | | | | | | | | • |
| H 370 | Doriana e Massimiliano Fuksas | | | | | | | | | | • | • | | | | | | | | | | | • |
| H 372 | Eri Goshen | | | | | | | | | | • | • | | | | | | | | | | • | • |
| H 376 | Giancarlo Vegni | | | | | | | | | | • | • | | | | | | | | | | | • |
| H 377 | Steve Leung | | | | | • | | | | | | | | | | | | • | • | | | | • |
| H 378 | Yabu Pushelberg | | | | | | | | | | • | • | | | | | | | | | | • | • |
| H 379 | Antonio Citterio | | | | | • | | | | | | • | | | | | • | | | | | | • |
| H 380 | Antonio Citterio | | | | | | | | | | | • | • | | | | | • | | | | | • |
| H 381 | Khalid Al Najjar | | | | | • | | | | | | • | | • | | | | | | | | • | • |
| H 382 | Joe Cheng | | | | | | • | | | • | | • | | | | | | | | | | | • |
| H 383 | Perkins&Will | | | | | | | | | | | • | | • | | | | • | • | | | | • |
| H 384 | CetraRuddy Architecture D.P.C. | | | | | | | | | | • | • | | | | | | • | | | | • | • |
| H 385 | Federica Biasi | | | | | | | | | | • | • | | • | | | | | • | | | | • |
| H 386 | Meneghello Paoletti | | | | | | | | | | • | • | | • | | | | | | | | • | • |
| H 411 | Leila | | | | | | | | | | • | • | | | | | | | • | | | | • |
| H 414 | Amber | | | • | | | | | | | | | | | | | | | | | | | • |
| H 415 | Scarlet | | | • | | | | | | | | | | | | | | | | | | | • |

32 32D 03 03D 03M B BA 06B 06A 26 26D 14 15 18 10S 06M 56 16 22M 55 17A !

| | | | | | | | | | | | | | | | | | | | | | | | |
|-------------------------|--|--|---|---|---|--|---|---|---|--|---|---|---|---|---|---|---|---|---|---|---|---|---|
| Available in PVD finish | | | • | • | | | | | | | • | • | | | | • | • | • | | | | | |
| Anti-microbial finish | | | • | • | • | | • | • | • | | | • | • | • | • | • | • | • | • | • | • | • | • |

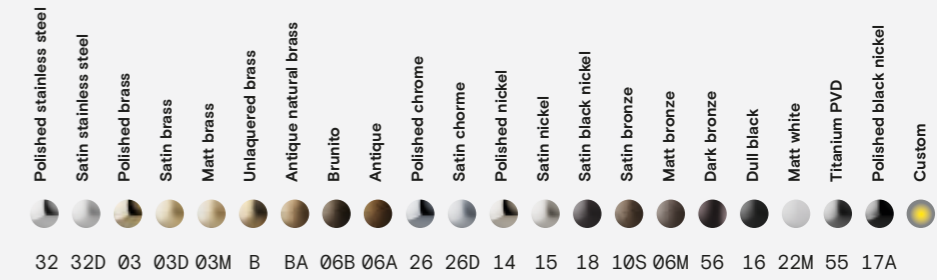

| | | 32 | 32D | 03 | 03D | 03M | B | BA | 06B | 06A | 26 | 26D | 14 | 15 | 18 | 10S | 06M | 56 | 16 | 22M | 55 | 17A | |
|----------|----------------------------------|----|-----|----|-----|-----|---|----|-----|-----|----|-----|----|----|----|-----|-----|----|----|-----|----|-----|---|
| H 416 | Garnet | | | • | | | | | | | | | | | | | | | | | | | • |
| H 419 | Bordeaux | | | • | | | | | | | | | | | | | | | | | | | • |
| H 1003 | Matteo Thun | | | | • | | | | • | | | • | | • | | | | | | | | | • |
| H 1004 | Antares | | | | | • | | | | | | | | | | | | | | | | | • |
| H 1016 | Nabucco | | | | | | | | | | | • | | | • | | | | | | | | • |
| H 1022 | Ernani | | | | | • | | | | | | | • | | | | | | | | | | • |
| H 1024 | Lolita | | | | | • | | | | | | • | • | | | | | | | | | | • |
| H 1026 | Antonio Bullo | | | | | • | | | | | | • | | | | | | | | | | | • |
| H 1027 | Dafne | | | | | • | | | | | | | • | | | | | | | | | | • |
| H 1037 | Teseo | | | | | • | | | | | | | | • | • | | | | | | | | • |
| H 1039 | Jean-Baptiste Sibertin Blanc | | | | | | | | | | | • | | • | • | | | | | | | | • |
| H 1040 | Gabriele e Oscar Buratti | | | | | | | | | | | • | | | • | | | | | | | | • |
| H 1043 | Matteo Thun | | | | | | | | | | | • | | | • | | | | | | | | • |
| H 1044 | Vincent Van Duysen | | | | | | | | | | | • | • | • | • | | | | • | | | | • |
| H 1044 U | Vincent Van Duysen | | | | | | | | | | | • | | | • | | | | • | | | | • |
| H 1045 | Yoshimi Kono | | | | | | | | | | | • | • | • | • | | | | • | | | | • |
| H 1046 | Nais | | | | | | | | | | | • | • | | • | | | | • | | | | • |
| H 1049 | Divara | | | | | | | | | | | • | • | | | | | | • | | | • | • |
| H 1050 | Giasone | | | | | | | | | | | • | • | | | | | | | | | | • |
| H 1052 | Mikhail Leykin | | | | | | | | | | | • | • | | | | • | | • | | | | • |
| H 1054 | W.W. | | | | | | | | | | | | • | • | | • | | | • | | | | • |
| H 1056 | Quadra | | | | | | | | | | | • | • | | | | | | | | | | • |
| H 1057 | Retrò | | | | | • | | | | | | | | | | | | | | | | | • |
| H 1058 | Amica | | | | | | | | | | | • | | | | | | | | | | • | • |
| H 1060 | SOM - Skidmore, Owings & Merrill | | | | | | | | | | | • | • | | | | | | • | | | | • |
| H 1061 | Di Virgilio Veneziano | | | | | | | | | | | | | | • | | | • | | | | • | • |
| H 1062 | Carmen | | | | | | | | | | | | • | | • | | | | • | • | | | • |
| H 1066 | Bertone Design | | | | | | | | | | | • | | | | | | | | | | | • |
| H 1068 | Pembroke & Ives | | | | | • | | | | | | | • | | | | | | • | | | | • |
| H 1069 | Susannah | | | | | | | | | | | • | • | | • | | | | | | | • | • |
| H 1748 | Estrella | | | | | | | | | | | | • | • | • | • | | | | | | | • |
| H 4730 | White | | | | | | | | | | | | • | | | | | | | | | | • |
| H 4742 | Coral | | | | | | | | | | | • | | | | | | | | | | | • |
| H 5008 | Taller Design Ricardo Bofill | | | | | | | | | | | • | | | | | | | | | | | • |
| H 5014 | Bernina | | | • | • | | | | | | | | | | | | | | | | | | • |
| H 5015 | Antonio Citterio | | | • | • | | | | | | | | | | | | | | | | | | • |
| H 5015 L | Antonio Citterio | | | • | • | | | | | | | | | | | | | | | | | | • |
| H 5017 | Hans Kollhoff | | | • | • | | | | | | | | | | | | | | | | | | • |

32 32D 03 03D 03M B BA 06B 06A 26 26D 14 15 18 10S 06M 56 16 22M 55 17A !

| | | | | | | | | | | | | | | | | | | | | | | | |
|-------------------------|--|--|---|---|---|--|---|---|---|--|--|---|---|---|---|---|---|---|---|---|---|---|---|
| Available in PVD finish | | | • | • | | | | | | | | • | • | | | | | • | • | • | | | |
| Anti-microbial finish | | | • | • | • | | • | • | • | | | • | • | • | • | • | • | • | • | • | • | • | • |

4 you

The artisanal expertise of Valli allows to create unique and personal pieces.



H 377
Titanium



H 377
Titanium + brown braided leather



H 377
Titanium + knurling



H 377
Titanium + dark leather



H 377
Titanium + marble

Customization options

Any lever in this catalog can be customized to customers' request and it will be especially manufactured 4 You.

Rosette

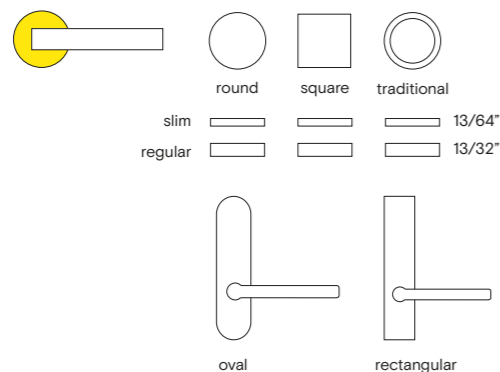

Finish

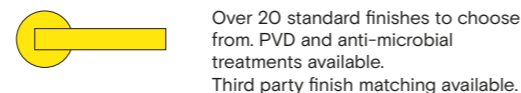

Special materials

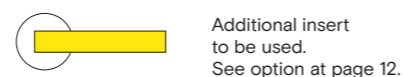

Texture and shapes



Upcharges

Standard configurations

The configuration on each catalog page is considered Standard.

Tubular latches standard backsets: 2.3/4" and 2.3/8".

Mortise lock standard backsets: 2.3/4" and 2.1/2".

Standard door thickness: 1.3/4".

The tubular sets are supplied with T-strikes.

If the requested configuration is not included, it might be produced upon special request and upcharges.

All customizations need to be approved by R&D Department in Italy.

| | | |
|----|---|---|
| 1 | Keying charges | KA - keyed alike (5 pins) - NO CHARGE (KA is not available on Multi-Point cylinders). |
| 2 | Drop ship charges | \$ 5.00 NET applies to drop ship orders |
| 3 | Rush delivery charges | \$ 30.00 NET applies to all orders requested to be shipped within 48 hours |
| 4 | Finishes | Split finishes: + \$ 20.00 NET to the highest priced finish indicated. Non-standard finishes: + \$ 100.00 NET to the highest priced finish for levers, deadbolts, privacy bolts, pulls, multi point and pocket door trims + \$ 50.00 NET to the highest priced finish for single dummies and deadlocks Anti-microbial finishes (BIOCOTE details at page 14): + \$ 150.00 NET to the highest priced finish for levers, deadbolts, privacy bolts, pulls, multi point and pocket door trims + \$ 70.00 NET to the highest priced finish for single dummies and deadlocks |
| 5 | Backset | Narrow mortise lock backset (< 2.1/2"): + \$ 250.00 LIST to the price of the standard sets Special backset request: call for details and pricing |
| 6 | Upside down mortise lock | + \$ 100.00 LIST to the price of the standard mortise lock sets |
| 7 | Magnetic locks | Tubular latches: + \$ 30.00 LIST to the price of the standard sets American mortise locks: + \$ 200.00 LIST for no thumb-turn functions + \$ 250.00 LIST for thumb-turn functions |
| 8 | Door thickness | Tubular latches and bolts: 2.1/4" Thick door: + \$ 50.00 LIST 2.1/2" Thick door: + \$ 70.00 LIST 3" Thick door: + \$ 90.00 LIST Mortise lock and multi-point (Multi-point only accommodates up to 2.1/4" thick door): 2.1/4" Thick door: + \$ 70.00 LIST 2.1/2" Thick door: + \$ 90.00 LIST 3" Thick door: + \$ 120.00 LIST > 3" Thick door: + \$ 150.00 LIST |
| 9 | Non standard rosettes | Single Dummy Non-listed RQ and RQS (square rosette): + \$ 55.00 LIST to the RP/RPS price Full set Non listed RQ and RQS (square rosette): + \$ 110.00 LIST to the RP/RPS price RS = Small European rosettes - Same price as standard American rosettes RS/Round rosettes (45mm, 50mm, 55mm) - Same price as RP RSQ/Square rosettes (45mm, 50mm, 55mm) - Same price as RQ Privacy function on small rosette = Requires the purchase of a Passage set and an additional Privacy Bolt RSB = Slim rosettes - full pricing at pages 102-103. RE = Rectangular rosettes (for tubular latches only) + \$ 30.00 LIST to the RQ prices |
| 10 | Non standard plates and thumb pieces | Narrow plates NEP, NES, NER and NERS = Same price as standard plates EP, EPS, ER, ERS Thumb piece change on ER/Rectangular plate and EP/Oval plate (ex. use of the K1225): + \$ 100.00 LIST |
| 11 | Dummy set adaptor (For 2.1/8" Pre-drilled doors only) | X003/1 back to back application: + \$ 75.00 LIST to DMY price X003/2 single application: + \$ 90.00 LIST to DMY price |
| 12 | Strike plates | ASA Strike plates: + \$ 60.00 LIST Custom strike plates available upon request. Call for pricing. |

PRESTO / Quick ship

PRESTO

Valli has selected some of the most popular levers in its collection to be **continuously in stock** for quick shipment.

These levers are recognized throughout the catalog by the PRESTO writing indicated on corresponding page.

The levers of the PRESTO Collection are meant to ship **within 3-5 business days** from the order confirmation. Contact our customer service for more information.

The PRESTO items are available under the following conditions:

- Maximum 10 sets per order. Contact our customer service for any request higher than this quantity.
- Available functions: Tubular passage, privacy and dummy (mix of different functions per order). Entry mortise lock 2.3/4" backset.
- Presto stock is available in the following standard finishes only: 14, 15, 26 & 26D and 32D (as indicated per lever page).

Fusital

H 311 Mario Bellini
p. 29



H 361 Antonio Citterio
with Toan Nguyen
p. 42



H 1044 Vincent
Van Duysen
p. 75



H 1045 Yoshimi Kono
p. 77



Lab

H 1046 Nais
p. 78



H 1049 Divara
p. 79



H 1054 W.W.
p. 82



H 1748 Estrella
p. 92



H 411 Leila
p. 59



Affordable luxury

AFFORDABLE LUXURY

The Affordable Luxury collection groups our high quality products with unbeatable prices, within \$250 LIST price for a passage lever on a round rosette.

No compromise on quality. The levers in this range have the standard high quality materials and mechanisms used in every other product, but with a more affordable price tag!

Fusital

H 1043 Matteo Thun
p. 74



H 1044 Vincent
Van Duysen
p. 75



Lab

H 163 Sarissa
p. 24



H 192 Prunus
p. 27



H 1004 Antares
p. 65



H 1037 Teseo
p. 71



H 1058 Amica
p. 85



H 411 Leila
p. 59



H 414 Amber
p. 60



H 415 Scarlet
p. 61



H 416 Garnet
p. 62



H 419 Bordeaux
p. 63



Door levers

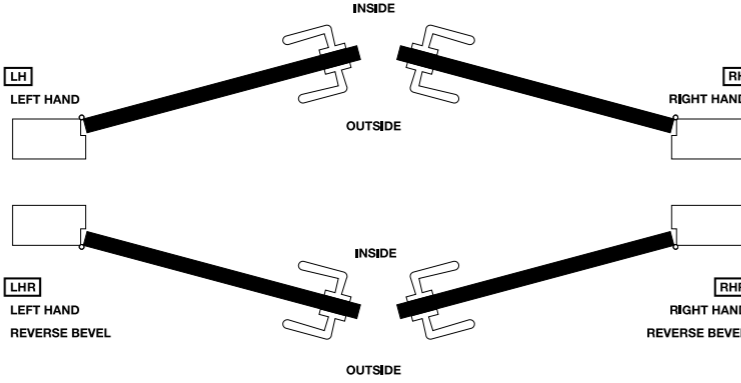

How to specify

| | |
|---------------------------|---|
| 1 Lever/knob model | Choose from our collection of levers / knobs (ex. H 1062 or K 377). |
| 2 Trim option | Choose among the options at page 23. |
| 3 Function | PGE Passage PCY Privacy DMY Dummy ML-XXX Mortise lock (Different functions available. Check details at page 168) 101 Deadbolt single cylinder 102 Deadbolt double cylinder 105 Privacy bolt |
| 4 Handing | RH, LH, RHR or LHR. The hand of the door is always determined from the outside. Follow the diagram below.  |
| 5 Finish | Standard finishes are indicated on each lever page. Special finishes are available upon request for an upcharge. Choose one of the finishes at pages 12-13. |
| 6 Backset | Choose between these standard options: 2.3/8" or 2.3/4" for tubular application 2.1/2" or 2.3/4" for mortise application |
| 7 Door thickness | To be specified. 1.3/4" is considered standard. Up to 3" thick door available (Upcharges apply). |
| 8 Miscellaneous | Note any special keying information, or special instruction. |

| Examples | 1 | 2 | 3 | 4 | 5 | 6 | 7 | 8 |
|------------------------------|--|------|------|-----|-----|--------|--------|-----------------|
| Tubular set | H 1068 | RP | PCY | RH | 26 | 2.3/8" | 1.3/4" | Full lip strike |
| Mortise lock | H 1066 | RS50 | ML-F | LHR | 16 | 2.3/4" | 2.1/4" | KA Cylinders |
| Deadbolt/Privacy bolt | 105 | RQ | - | - | 26D | 2.3/4" | 1.3/4" | Less exterior |
| Multipoint | See specification details at page 160. | | | | | | | |

Trim options

Any lever/knob in the catalog can be matched with any type of rosette and escutcheon plates. Choose from the options below:

Configurations for Pre - drilled doors (2.1/8" BORE)

Rosettes

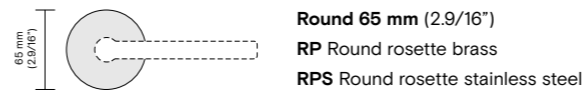

Round 65 mm (2.9/16")
RP Round rosette brass
RPS Round rosette stainless steel

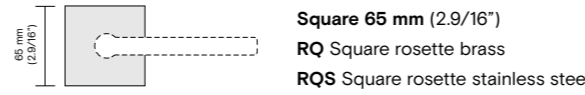

Square 65 mm (2.9/16")
RQ Square rosette brass
RQS Square rosette stainless steel

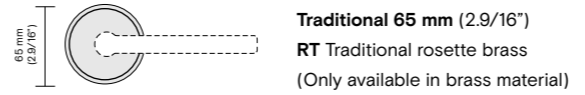

Traditional 65 mm (2.9/16")
RT Traditional rosette brass
 (Only available in brass material)

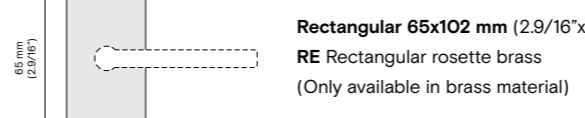

Rectangular 65x102 mm (2.9/16"x4")
RE Rectangular rosette brass
 (Only available in brass material)

Escutcheon - Plates

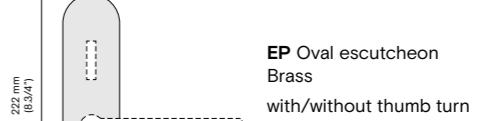

EP Oval escutcheon
 Brass
 with/without thumb turn

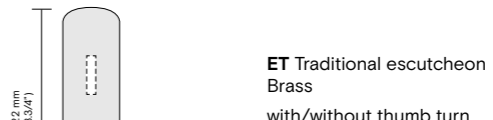

ET Traditional escutcheon
 Brass
 with/without thumb turn

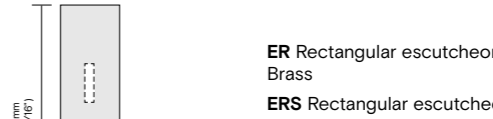

ER Rectangular escutcheon
 Brass
ERS Rectangular escutcheon
 Stainless steel

Configurations for Non pre - drilled doors

Rosettes



Round 55 mm (2.1/4")
RS55 Round rosette brass



Round 50 mm (2")
RS50 Round rosette brass
RSS50 Round rosette stainless steel

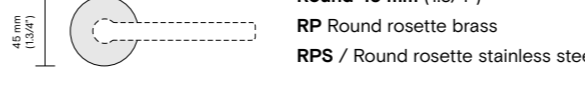

Round 45 mm (1.3/4")
RP Round rosette brass
RPS / Round rosette stainless steel

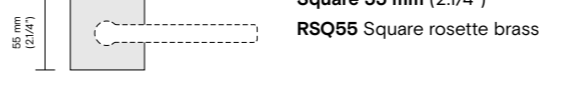

Square 55 mm (2.1/4")
RSQ55 Square rosette brass

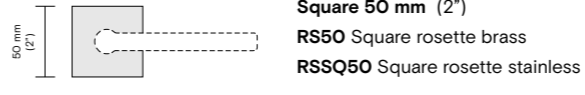

Square 50 mm (2")
RS50 Square rosette brass
RSSQ50 Square rosette stainless steel

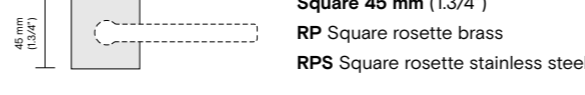

Square 45 mm (1.3/4")
RP Square rosette brass
RPS Square rosette stainless steel

Escutcheons - Narrow plates



NEP
 Narrow oval escutcheon
 Brass

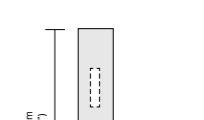

NER
 Narrow rectangular escutcheon
 Brass



NES
 Narrow escutcheon
 Stainless steel

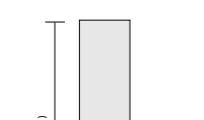

NERS
 Narrow rectangular escutcheon
 Stainless steel



H 163 Sarissa

| | | |
|----------|------------|-------|
| Material | Collection | Group |
| Brass | Lab | 4 |

Standard option (mm/inches)

RP Round rosette

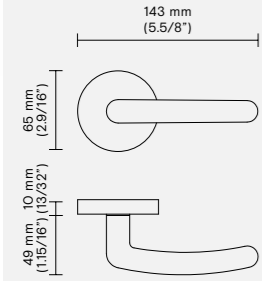

Standard option (mm/inches)

RQ Square rosette

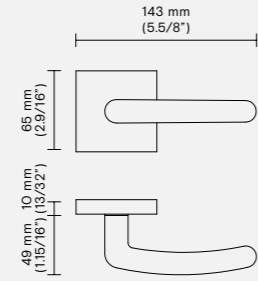

Escutcheon options (mm/inches)

EP Oval plate

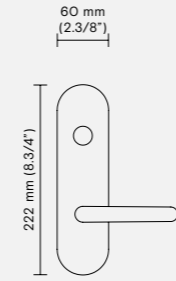

ER Rectangular plate

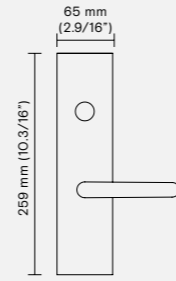

Conversions from metric to U.S. measurements are approximate.

Slim rosette available - See pages 102-103

Retail price

| Finish | Rosette | Function | | DMY R/L Single | ML-F Entry |
|--------------------|-----------|-----------|-----------|----------------|-------------|
| | | PGE | PCY | | |
| 26 Polished chrome | RP Round | \$ 223.00 | \$ 226.00 | \$ 113.00 | \$ 924.00 |
| | RQ Square | \$ 321.00 | \$ 323.00 | \$ 172.00 | \$ 1,062.00 |
| 26D Satin chrome | RP Round | \$ 223.00 | \$ 226.00 | \$ 113.00 | \$ 924.00 |
| | RQ Square | \$ 321.00 | \$ 323.00 | \$ 172.00 | \$ 1,062.00 |

Retail price

| Finish | Escutcheon | Function | | DMY R/L Single | DMY R/L Pair | ML-F Entry |
|--------------------|----------------|-----------|-----------|----------------|--------------|------------|
| | | PGE | PCY | | | |
| 26 Polished chrome | EP Oval | \$ 481.00 | \$ 494.00 | \$ 254.00 | \$ 430.00 | \$ 859.00 |
| | ER Rectangular | \$ 558.00 | \$ 570.00 | \$ 267.00 | \$ 481.00 | \$ 899.00 |
| 26D Satin chrome | EP Oval | \$ 481.00 | \$ 494.00 | \$ 254.00 | \$ 430.00 | \$ 859.00 |
| | ER Rectangular | \$ 558.00 | \$ 570.00 | \$ 267.00 | \$ 481.00 | \$ 899.00 |

The options listed above are considered standard. Non-standard options are available upon request.

For more options on Rosettes and Escutcheon plates see page 23. For more options on Finishes see pages 12-13.

RE = Rectangular rosettes available for tubular latch application only. Add + \$ 30.00 LIST to the price of the RQ

Upcharges apply for the following special options:

- Extra thick door (> 2")
- Non-standard rosettes (rosettes not listed above)
- Non-standard finishes (finishes not listed above)
- Split finishes

See page 17 for pricing. Exclusions may apply.

Matching elements

- Pg 168 Mortise lock functions
- Pg 152 Deadbolts
- Pg 154 Privacy Bolts
- Pg 156 Escutcheons with deadbolts
- Pg 160 Multi-Point Trim functions

Window lever available in the same design. Call for pricing.



H 165 Germana

| | | |
|----------|------------|-------|
| Material | Collection | Group |
| Brass | Lab | 2 |

Standard option (mm/inches)

RT Traditional rosette

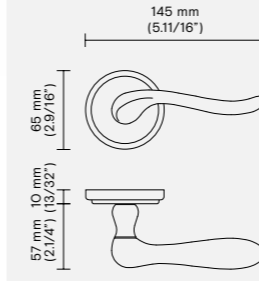

Standard option (mm/inches)

RQ Square rosette

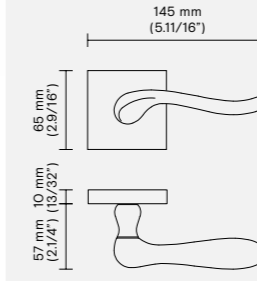

Escutcheon options (mm/inches)*

EP Oval plate

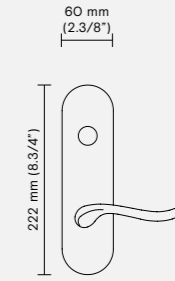

ER Rectangular plate

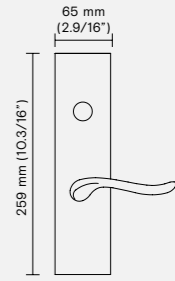

*Only available on request

Conversions from metric to U.S. measurements are approximate.

Retail price

| Finish | Rosette | Function | | DMY R/L Single | ML-F Entry |
|-------------------|----------------|-----------|-----------|----------------|-------------|
| | | PGE | PCY | | |
| O3 Polished brass | RT Traditional | \$ 368.00 | \$ 389.00 | \$ 170.00 | \$ 1,037.00 |
| | RQ Square | \$ 486.00 | \$ 508.00 | \$ 229.00 | \$ 1,176.00 |
| O3D Satin brass | RT Traditional | \$ 368.00 | \$ 389.00 | \$ 170.00 | \$ 1,037.00 |
| | RQ Square | \$ 486.00 | \$ 508.00 | \$ 229.00 | \$ 1,176.00 |
| O6A Anticato | RT Traditional | \$ 384.00 | \$ 401.00 | \$ 180.00 | \$ 1,037.00 |
| | RQ Square | \$ 503.00 | \$ 520.00 | \$ 239.00 | \$ 1,176.00 |

Note: This lever is also available with RP Round Rosette. Same price as RT Traditional Rosette.

Matching elements

- Pg 168 Mortise lock functions
- Pg 152 Deadbolts
- Pg 154 Privacy Bolts
- Pg 156 Escutcheons with deadbolts
- Pg 160 Multi-Point Trim functions

European window lever style available in the same design. Call for pricing.

Upcharges apply for the following special options:

- Extra thick door (> 2")
- Non-standard rosettes (rosettes not listed above)
- Non-standard finishes (finishes not listed above)
- Split finishes

See page 17 for pricing. Exclusions may apply.

The options listed above are considered standard. Non-standard options are available upon request.

For more options on Rosettes and Escutcheon plates see page 23. For more options on Finishes see pages 12-13.

RE = Rectangular rosettes available for tubular latch application only. Add + \$ 30.00 LIST to the price of the RQ. For slim rosette and European version see pages 100-103.



H 176 Spiga

| | | |
|-------------------|------------|-------|
| Material | Collection | Group |
| Brass + Porcelain | Lab | 2 |

Standard option (mm/inches) RT Traditional rosette

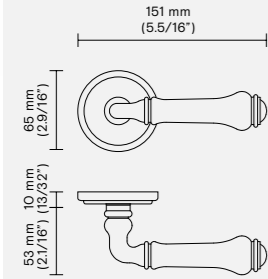

Standard option (mm/inches) RQ Square rosette

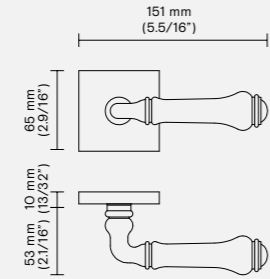

Escutcheon options (mm/inches)*

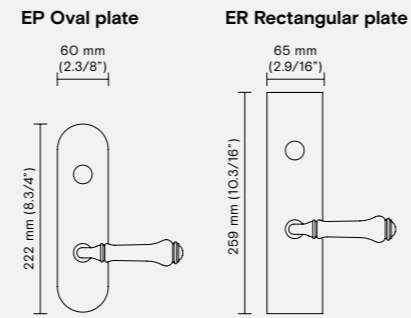

Conversions from metric to U.S. measurements are approximate.

*Only available on request

Retail price

| Finish | Rosette | Function | | DMY R/L Single | ML-F Entry |
|---------------------------------|----------------|-----------|-----------|----------------|-------------|
| | | PGE | PCY | | |
| 03/White Polished brass / White | RT Traditional | \$ 436.00 | \$ 459.00 | \$ 207.00 | \$ 1,037.00 |
| | RQ Square | \$ 555.00 | \$ 578.00 | \$ 266.00 | \$ 1,176.00 |
| 06B/Ivory Brunito / Ivory | RT Traditional | \$ 453.00 | \$ 459.00 | \$ 215.00 | \$ 1,037.00 |
| | RQ Square | \$ 572.00 | \$ 602.00 | \$ 275.00 | \$ 1,176.00 |

Note: The insert is made of porcelain, not suitable for commercial use. This lever is also available with RP Round Rosette. Same price as RT Traditional Rosette.

The options listed above are considered standard. Non-standard options are available upon request.

For more options on Rosettes and Escutcheon plates see page 23. For more options on Finishes see pages 12-13.

RE = Rectangular rosettes available for tubular latch application only. Add + \$ 30.00 LIST to the price of the RQ. For slim rosette and European version see pages 100-103.

Upcharges apply for the following special options:

- Extra thick door (> 2")
- Non-standard rosettes (rosettes not listed above)
- Non-standard finishes (finishes not listed above)
- Split finishes

See page 17 for pricing. Exclusions may apply.

Matching elements

- Pg 168 Mortise lock functions
- Pg 152 Deadbolts
- Pg 154 Privacy Bolts
- Pg 156 Escutcheons with deadbolts
- Pg 160 Multi-Point Trim functions

European window lever style available in the same design. Call for pricing.



H 192 Prunus

| | | |
|----------|------------|-------|
| Material | Collection | Group |
| Brass | Lab | 4 |

Standard option (mm/inches) RP Round rosette

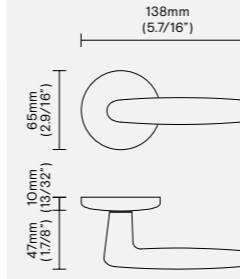

Standard option (mm/inches) RQ Square rosette

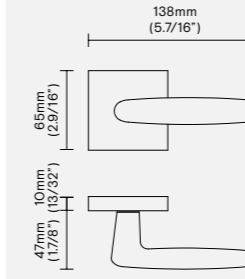

Escutcheon options (mm/inches)

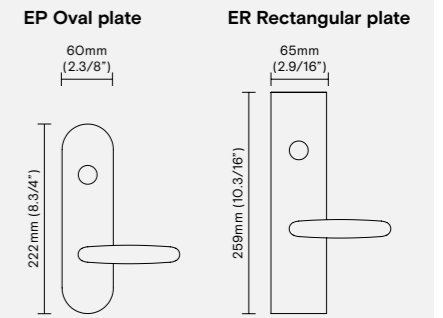

Slim rosette available - See pages 102-103

*Only available on request
Conversions from metric to U.S. measurements are approximate.

Retail price

| Finish | Rosette | Function | | DMY R/L Single | ML-F Entry |
|-----------------|-----------|-----------|-----------|----------------|-------------|
| | | PGE | PCY | | |
| 15 Satin nickel | RP Round | \$ 223.00 | \$ 226.00 | \$ 113.00 | \$ 924.00 |
| | RQ Square | \$ 321.00 | \$ 323.00 | \$ 172.00 | \$ 1,062.00 |

The options listed above are considered standard. Non-standard options are available upon request.

For more options on Rosettes and Escutcheon plates see page 23. For more options on Finishes see pages 12-13.

RE = Rectangular rosettes available for tubular latch application only. Add + \$ 30.00 LIST to the price of the RQ.

Upcharges apply for the following special options:

- Extra thick door (> 2")
- Non-standard rosettes (rosettes not listed above)
- Non-standard finishes (finishes not listed above)
- Split finishes

See page 17 for pricing. Exclusions may apply.

Matching elements

- Pg 168 Mortise lock functions
- Pg 152 Deadbolts
- Pg 154 Privacy Bolts
- Pg 156 Escutcheons with deadbolts
- Pg 160 Multi-Point Trim functions

Window lever available in the same design. Call for pricing.



H 198 Eero Aarnio

| | | |
|----------|------------|-------|
| Material | Collection | Group |
| Brass | Fusital | 1 |

Standard option (mm/inches)

RP Round rosette

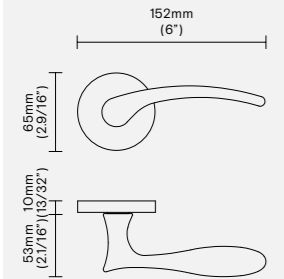

Standard option (mm/inches)

RQ Square rosette

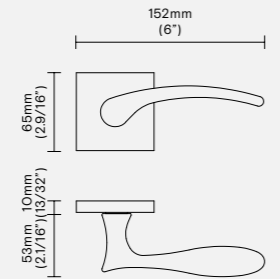

Escutcheon options (mm/inches)

EP Oval plate

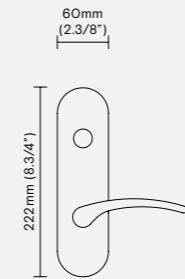

ER Rectangular plate

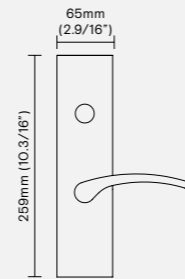

Conversions from metric to U.S. measurements are approximate.

Slim rosette available - See pages 102-103

Retail price

| Finish | Rosette | Function | | DMY R/L Single | ML-F Entry |
|-------------------|-----------|-----------|-----------|----------------|-------------|
| | | PGE | PCY | | |
| O3 Polished brass | RP Round | \$ 336.00 | \$ 361.00 | \$ 157.00 | \$ 961.00 |
| | RQ Square | \$ 455.00 | \$ 480.00 | \$ 216.00 | \$ 1,100.00 |
| O6A Anticato | RP Round | \$ 377.00 | \$ 401.00 | \$ 180.00 | \$ 961.00 |
| | RQ Square | \$ 496.00 | \$ 516.00 | \$ 239.00 | \$ 1,100.00 |
| 15 Satin nickel | RP Round | \$ 362.00 | \$ 375.00 | \$ 168.00 | \$ 961.00 |
| | RQ Square | \$ 481.00 | \$ 494.00 | \$ 227.00 | \$ 1,100.00 |
| 26D Satin chrome | RP Round | \$ 353.00 | \$ 370.00 | \$ 166.00 | \$ 961.00 |
| | RQ Square | \$ 471.00 | \$ 489.00 | \$ 225.00 | \$ 1,100.00 |

Retail price

| Finish | Escutcheon | Function | | DMY R/L Single | DMY R/L Pair | ML-F Entry |
|------------------|----------------|-----------|-----------|----------------|--------------|------------|
| | | PGE | PCY | | | |
| 26D Satin chrome | EP Oval | \$ 520.00 | \$ 545.00 | \$ 254.00 | \$ 455.00 | \$ 899.00 |
| | ER Rectangular | \$ 570.00 | \$ 596.00 | \$ 279.00 | \$ 506.00 | \$ 935.00 |

The options listed above are considered standard. Non-standard options are available upon request.

For more options on Rosettes and Escutcheon plates see page 23. For more options on Finishes see pages 12-13.

RE = Rectangular rosettes available for tubular latch application only. Add + \$ 30.00 LIST to the price of the RQ. For slim rosette and European version see pages 100-103.

Upcharges apply for the following special options:

- Extra thick door (> 2")
- Non-standard rosettes (rosettes not listed above)
- Non-standard finishes (finishes not listed above)
- Split finishes

See page 17 for pricing. Exclusions may apply.

Matching elements

- Pg 168 Mortise lock functions
- Pg 152 Deadbolts
- Pg 154 Privacy Bolts
- Pg 156 Escutcheons with deadbolts
- Pg 160 Multi-Point Trim functions

European window lever style available in the same design. Call for pricing.

H 311 Mario Bellini

| | | |
|----------|------------|-------|
| Material | Collection | Group |
| Brass | Fusital | 6 |

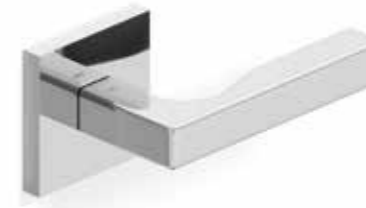

Standard option (mm/inches)

RQ Square rosette

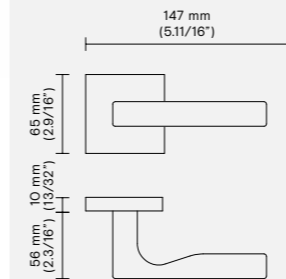

Standard option (mm/inches)

RP Round rosette

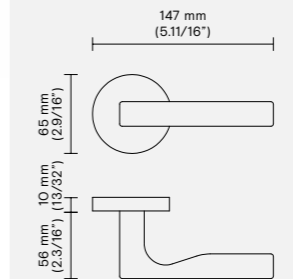

Escutcheon options (mm/inches)

EP Oval plate

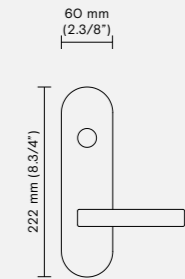

ER Rectangular plate

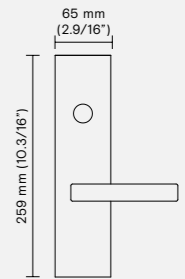

Conversions from metric to U.S. measurements are approximate.

Slim rosette available - See pages 102-103

Retail price

| Finish | Rosette | Function | | DMY R/L Single | ML-F Entry |
|--------------------|-----------|-----------|-----------|----------------|-------------|
| | | PGE | PCY | | |
| 14 Polished nickel | RP Round | \$ 677.00 | \$ 699.00 | \$ 329.00 | \$ 1,213.00 |
| | RQ Square | \$ 815.00 | \$ 836.00 | \$ 406.00 | \$ 1,389.00 |
| 15 Satin nickel | RP Round | \$ 685.00 | \$ 705.00 | \$ 332.00 | \$ 1,213.00 |
| | RQ Square | \$ 766.00 | \$ 778.00 | \$ 408.00 | \$ 1,389.00 |
| 26 Polished chrome | RP Round | \$ 599.00 | \$ 612.00 | \$ 293.00 | \$ 1,213.00 |
| | RQ Square | \$ 714.00 | \$ 733.00 | \$ 358.00 | \$ 1,389.00 |
| 26D Satin chrome | RP Round | \$ 632.00 | \$ 647.00 | \$ 306.00 | \$ 1,213.00 |
| | RQ Square | \$ 755.00 | \$ 777.00 | \$ 383.00 | \$ 1,389.00 |

Retail price

| Finish | Escutcheon | Function | | DMY R/L Single | DMY R/L Pair | ML-F Entry |
|--------------------|----------------|-----------|-----------|----------------|--------------|-------------|
| | | PGE | PCY | | | |
| 26 Polished chrome | EP Oval | \$ 785.00 | \$ 796.00 | \$ 387.00 | \$ 724.00 | \$ 1,163.00 |
| | ER Rectangular | \$ 819.00 | \$ 833.00 | \$ 410.00 | \$ 772.00 | \$ 1,200.00 |
| 26D Satin chrome | EP Oval | \$ 785.00 | \$ 796.00 | \$ 387.00 | \$ 724.00 | \$ 1,163.00 |
| | ER Rectangular | \$ 819.00 | \$ 833.00 | \$ 410.00 | \$ 772.00 | \$ 1,200.00 |

The options listed above are considered standard. Non-standard options are available upon request.

For more options on Rosettes and Escutcheon plates see page 23. For more options on Finishes see pages 12-13.

RE = Rectangular rosettes available for tubular latch application only. Add + \$ 30.00 LIST to the price of the RQ. For slim rosette and European version see pages 100-103.

Upcharges apply for the following special options:

- Extra thick door (> 2")
- Non-standard rosettes (rosettes not listed above)
- Non-standard finishes (finishes not listed above)
- Split finishes

See page 17 for pricing. Exclusions may apply.

Matching elements

- Pg 168 Mortise lock functions
- Pg 152 Deadbolts
- Pg 154 Privacy Bolts
- Pg 156 Escutcheons with deadbolts
- Pg 160 Multi-Point Trim functions

European window lever style available in the same design. Call for pricing.



H 315 Pierluigi Cerri

| | | |
|-------------------|------------|-------|
| Material | Collection | Group |
| Brass + Porcelain | Fusital | 5 |

Standard option (mm/inches)

RP Round rosette

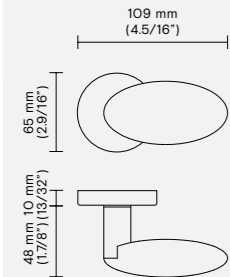

Standard option (mm/inches)

RQ Square rosette

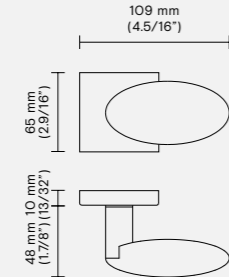

Escutcheon options (mm/inches)

EP Oval plate

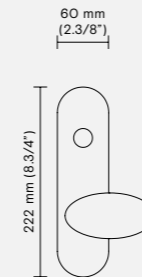

ER Rectangular plate

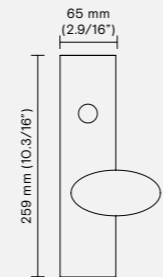

Conversions from metric to U.S. measurements are approximate.

Slim rosette available - See pages 102-103

Retail price

| Finish | Rosette | Function | | DMY R/L Single | ML-F Entry |
|----------------------------------|-----------|-----------|-----------|----------------|-------------|
| | | PGE | PCY | | |
| 03/White Polished brass / White | RP Round | \$ 483.00 | \$ 516.00 | \$ 235.00 | \$ 1,100.00 |
| | RQ Square | \$ 602.00 | \$ 634.00 | \$ 294.00 | \$ 1,238.00 |
| 26/White Polished chrome / White | RP Round | \$ 483.00 | \$ 516.00 | \$ 235.00 | \$ 1,100.00 |
| | RQ Square | \$ 602.00 | \$ 634.00 | \$ 294.00 | \$ 1,238.00 |

Note: Lever made of porcelain, not suitable for commercial use.

Retail price

| Finish | Escutcheon | Function | | DMY R/L Single | DMY R/L Pair | ML-F Entry |
|----------------------------------|----------------|-----------|-----------|----------------|--------------|-------------|
| | | PGE | PCY | | | |
| 26/White Polished chrome / White | EP Oval | \$ 683.00 | \$ 696.00 | \$ 330.00 | \$ 607.00 | \$ 1,037.00 |
| | ER Rectangular | \$ 734.00 | \$ 747.00 | \$ 369.00 | \$ 671.00 | \$ 1,075.00 |

The options listed above are considered standard. Non-standard options are available upon request.

For more options on Rosettes and Escutcheon plates see page 23. For more options on Finishes see pages 12-13.

RE = Rectangular rosettes available for tubular latch application only. Add + \$ 30.00 LIST to the price of the RQ. For slim rosette and European version see pages 100-103.

Upcharges apply for the following special options:

- Extra thick door (> 2")
- Non-standard rosettes (rosettes not listed above)
- Non-standard finishes (finishes not listed above)
- Split finishes

See page 17 for pricing. Exclusions may apply.

Matching elements

- Pg 168 Mortise lock functions
- Pg 152 Deadbolts
- Pg 154 Privacy Bolts
- Pg 156 Escutcheons with deadbolts
- Pg 160 Multi-Point Trim functions

European window lever style available in the same design. Call for pricing.



H 317 Antonio Citterio

| | | |
|----------|------------|-------|
| Material | Collection | Group |
| Brass | Fusital | 5 |

Standard option (mm/inches)

RP Round rosette

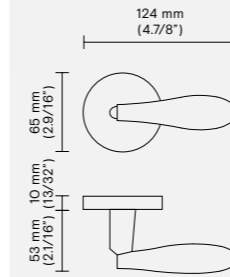

Standard option (mm/inches)

RQ Square rosette

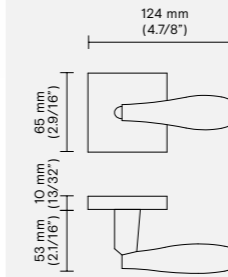

Escutcheon options (mm/inches)

EP Oval plate

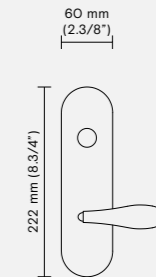

ER Rectangular plate

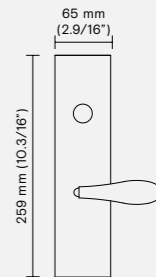

Conversions from metric to U.S. measurements are approximate.

Slim rosette available - See pages 102-103

Retail price

| Finish | Rosette | Function | | DMY R/L Single | ML-F Entry |
|--------------------|-----------|-----------|-----------|----------------|-------------|
| | | PGE | PCY | | |
| 26 Polished chrome | RP Round | \$ 483.00 | \$ 495.00 | \$ 227.00 | \$ 1,100.00 |
| | RQ Square | \$ 602.00 | \$ 614.00 | \$ 287.00 | \$ 1,238.00 |
| 26D Satin chrome | RP Round | \$ 663.00 | \$ 679.00 | \$ 321.00 | \$ 1,100.00 |
| | RQ Square | \$ 792.00 | \$ 815.00 | \$ 401.00 | \$ 1,238.00 |

Retail price

| Finish | Escutcheon | Function | | DMY R/L Single | DMY R/L Pair | ML-F Entry |
|--------------------|----------------|-----------|-----------|----------------|--------------|-------------|
| | | PGE | PCY | | | |
| 26 Polished chrome | EP Oval | \$ 683.00 | \$ 696.00 | \$ 330.00 | \$ 607.00 | \$ 1,037.00 |
| | ER Rectangular | \$ 734.00 | \$ 747.00 | \$ 369.00 | \$ 671.00 | \$ 1,075.00 |
| 26D Satin chrome | EP Oval | \$ 683.00 | \$ 696.00 | \$ 330.00 | \$ 607.00 | \$ 1,037.00 |
| | ER Rectangular | \$ 734.00 | \$ 747.00 | \$ 369.00 | \$ 671.00 | \$ 1,075.00 |

The options listed above are considered standard. Non-standard options are available upon request.

For more options on Rosettes and Escutcheon plates see page 23. For more options on Finishes see pages 12-13.

RE = Rectangular rosettes available for tubular latch application only. Add + \$ 30.00 LIST to the price of the RQ. For slim rosette and European version see pages 100-103.

Upcharges apply for the following special options:

- Extra thick door (> 2")
- Non-standard rosettes (rosettes not listed above)
- Non-standard finishes (finishes not listed above)
- Split finishes

See page 17 for pricing. Exclusions may apply.

Matching elements

- Pg 168 Mortise lock functions
- Pg 152 Deadbolts
- Pg 154 Privacy Bolts
- Pg 156 Escutcheons with deadbolts
- Pg 160 Multi-Point Trim functions

European window lever style available in the same design. Call for pricing.



H 327 Antonio Citterio

| | | |
|----------|------------|-------|
| Material | Collection | Group |
| Brass | Fusital | 5 |

Standard option (mm/inches)

RP Round rosette

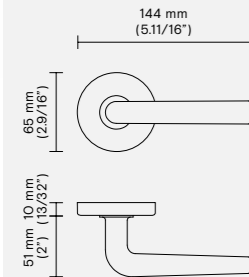

Standard option (mm/inches)

RQ Square rosette

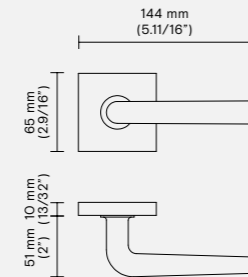

Escutcheon options (mm/inches)

EP Oval plate

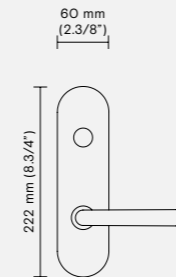

ER Rectangular plate

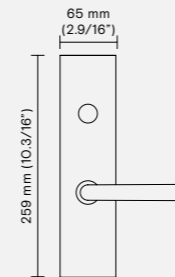

Conversions from metric to U.S. measurements are approximate.

Slim rosette available - See pages 102-103

Retail price

| Finish | Rosette | Function | | DMY R/L Single | ML-F Entry |
|-------------------|-----------|-----------|-----------|----------------|-------------|
| | | PGE | PCY | | |
| 03 Polished brass | RP Round | \$ 373.00 | \$ 397.00 | \$ 177.00 | \$ 1,100.00 |
| | RQ Square | \$ 491.00 | \$ 516.00 | \$ 236.00 | \$ 1,238.00 |
| 26D Satin chrome | RP Round | \$ 378.00 | \$ 400.00 | \$ 181.00 | \$ 1,100.00 |
| | RQ Square | \$ 497.00 | \$ 519.00 | \$ 240.00 | \$ 1,238.00 |

Retail price

| Finish | Escutcheon | Function | | DMY R/L Single | DMY R/L Pair | ML-F Entry |
|------------------|----------------|-----------|-----------|----------------|--------------|-------------|
| | | PGE | PCY | | | |
| 26D Satin chrome | EP Oval | \$ 683.00 | \$ 696.00 | \$ 330.00 | \$ 607.00 | \$ 1,037.00 |
| | ER Rectangular | \$ 734.00 | \$ 747.00 | \$ 369.00 | \$ 671.00 | \$ 1,075.00 |

The options listed above are considered standard. Non-standard options are available upon request.

For more options on Rosettes and Escutcheon plates see page 23. For more options on Finishes see pages 12-13.

RE = Rectangular rosettes available for tubular latch application only. Add + \$ 30.00 LIST to the price of the RQ. For slim rosette and European version see pages 100-103.

Upcharges apply for the following special options:

- Extra thick door (> 2")
- Non-standard rosettes (rosettes not listed above)
- Non-standard finishes (finishes not listed above)
- Split finishes

See page 17 for pricing. Exclusions may apply.

Matching elements

- Pg 168 Mortise lock functions
- Pg 152 Deadbolts
- Pg 154 Privacy Bolts
- Pg 156 Escutcheons with deadbolts
- Pg 160 Multi-Point Trim functions

European window lever style available in the same design. Call for pricing.



H 329 Taller Design Ricardo Bofill

| | | |
|----------|------------|-------|
| Material | Collection | Group |
| Brass | Fusital | 6 |

Standard option (mm/inches)

RP Round rosette

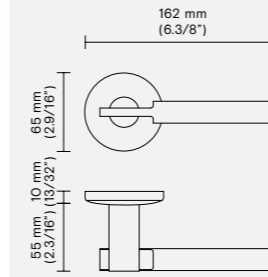

Standard option (mm/inches)

RQ Square rosette

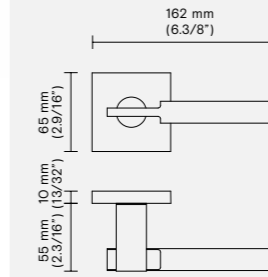

Escutcheon options (mm/inches)

EP Oval plate

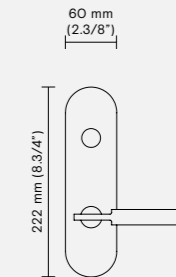

ER Rectangular plate

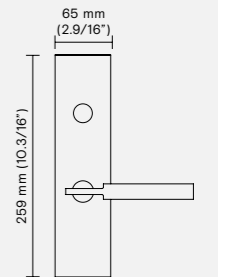

Conversions from metric to U.S. measurements are approximate.

Slim rosette available - See pages 102-103

Retail price

| Finish | Rosette | Function | | DMY R/L Single | ML-F Entry |
|--|-----------|-----------|-----------|----------------|-------------|
| | | PGE | PCY | | |
| 26/26D Polished chrome / Satin chrome* | RP Round | \$ 555.00 | \$ 581.00 | \$ 267.00 | \$ 1,213.00 |
| | RQ Square | \$ 670.00 | \$ 688.00 | \$ 336.00 | \$ 1,389.00 |
| 56 Dark bronze | RP Round | \$ 555.00 | \$ 581.00 | \$ 267.00 | \$ 1,213.00 |
| | RQ Square | \$ 670.00 | \$ 688.00 | \$ 336.00 | \$ 1,389.00 |

Retail price

| Finish | Escutcheon | Function | | DMY R/L Single | DMY R/L Pair | ML-F Entry |
|--|----------------|-----------|-----------|----------------|--------------|-------------|
| | | PGE | PCY | | | |
| 26/26D Polished chrome / Satin chrome* | EP Oval | \$ 785.00 | \$ 796.00 | \$ 387.00 | \$ 724.00 | \$ 1,163.00 |
| | ER Rectangular | \$ 819.00 | \$ 833.00 | \$ 410.00 | \$ 772.00 | \$ 1,200.00 |

* The lever grip is satin, the shank is polished. The rosette/escutcheon is polished.

The options listed above are considered standard. Non-standard options are available upon request.

For more options on Rosettes and Escutcheon plates see page 23. For more options on Finishes see pages 12-13.

RE = Rectangular rosettes available for tubular latch application only. Add + \$ 30.00 LIST to the price of the RQ. For slim rosette and European version see pages 100-103.

Upcharges apply for the following special options:

- Extra thick door (> 2")
- Non-standard rosettes (rosettes not listed above)
- Non-standard finishes (finishes not listed above)
- Split finishes

See page 17 for pricing. Exclusions may apply.

Matching elements

- Pg 168 Mortise lock functions
- Pg 152 Deadbolts
- Pg 154 Privacy Bolts
- Pg 156 Escutcheons with deadbolts
- Pg 160 Multi-Point Trim functions

European window lever style available in the same design. Call for pricing.



H 330 Matteo Thun

| | | |
|----------|------------|-------|
| Material | Collection | Group |
| Brass | Fusital | 5 |

Standard option (mm/inches)

RP Round rosette

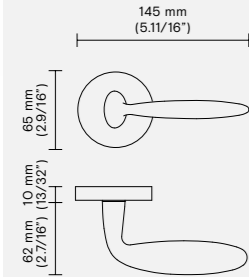

Standard option (mm/inches)

RQ Square rosette

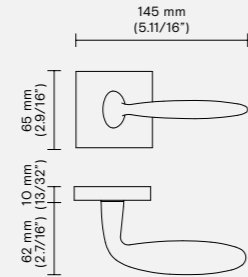

Escutcheon options (mm/inches)

EP Oval plate

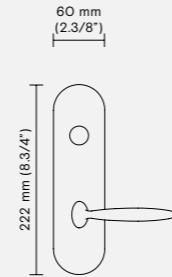

ER Rectangular plate

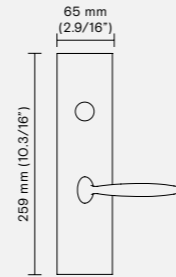

Conversions from metric to U.S. measurements are approximate.

Slim rosette available - See pages 102-103

Retail price

| Finish | Rosette | Function PGE | PCY | DMY R/L Single | ML-F Entry |
|------------------|-----------|--------------|-----------|----------------|-------------|
| 06M Matt bronze | RP Round | \$ 428.00 | \$ 449.00 | \$ 202.00 | \$ 1,100.00 |
| | RQ Square | \$ 547.00 | \$ 569.00 | \$ 262.00 | \$ 1,238.00 |
| 26D Satin chrome | RP Round | \$ 428.00 | \$ 449.00 | \$ 202.00 | \$ 1,100.00 |
| | RQ Square | \$ 547.00 | \$ 569.00 | \$ 262.00 | \$ 1,238.00 |

Retail price

| Finish | Escutcheon | Function PGE | PCY | DMY R/L Single | DMY R/L Pair | ML-F Entry |
|------------------|----------------|--------------|-----------|----------------|--------------|-------------|
| 26D Satin chrome | EP Oval | \$ 683.00 | \$ 696.00 | \$ 330.00 | \$ 607.00 | \$ 1,037.00 |
| | ER Rectangular | \$ 734.00 | \$ 747.00 | \$ 369.00 | \$ 671.00 | \$ 1,075.00 |

The options listed above are considered standard. Non-standard options are available upon request.

For more options on Rosettes and Escutcheon plates see page 23. For more options on Finishes see pages 12-13.

RE = Rectangular rosettes available for tubular latch application only. Add + \$ 30.00 LIST to the price of the RQ. For slim rosette and European version see pages 100-103.

Upcharges apply for the following special options:

- Extra thick door (> 2")
- Non-standard rosettes (rosettes not listed above)
- Non-standard finishes (finishes not listed above)
- Split finishes

See page 17 for pricing. Exclusions may apply.

Matching elements

- Pg 168 Mortise lock functions
- Pg 152 Deadbolts
- Pg 154 Privacy Bolts
- Pg 156 Escutcheons with deadbolts
- Pg 160 Multi-Point Trim functions

European window lever style available in the same design. Call for pricing.



H 334 Foster + Partners

| | | |
|----------|------------|-------|
| Material | Collection | Group |
| Brass | Fusital | 5 |

Standard option (mm/inches)

RP Round rosette

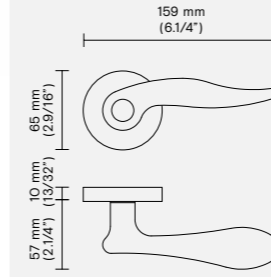

Standard option (mm/inches)

RQ Square rosette

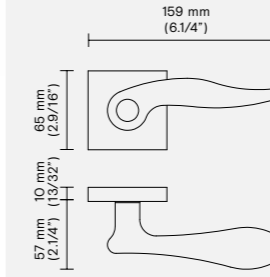

Escutcheon options (mm/inches)

EP Oval plate

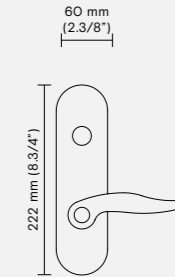

ER Rectangular plate

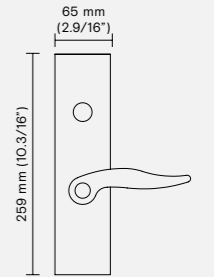

Conversions from metric to U.S. measurements are approximate.

Retail price

| Finish | Rosette | Function PGE | PCY | DMY R/L Single | ML-F Entry |
|-------------------|-----------|--------------|-----------|----------------|-------------|
| 03 Polished brass | RP Round | \$ 530.00 | \$ 548.00 | \$ 252.00 | \$ 1,100.00 |
| | RQ Square | \$ 654.00 | \$ 670.00 | \$ 312.00 | \$ 1,238.00 |
| 26D Satin chrome | RP Round | \$ 535.00 | \$ 551.00 | \$ 255.00 | \$ 1,100.00 |
| | RQ Square | \$ 654.00 | \$ 670.00 | \$ 315.00 | \$ 1,238.00 |

Retail price

| Finish | Escutcheon | Function PGE | PCY | DMY R/L Single | DMY R/L Pair | ML-F Entry |
|------------------|----------------|--------------|-----------|----------------|--------------|-------------|
| 26D Satin chrome | EP Oval | \$ 683.00 | \$ 696.00 | \$ 330.00 | \$ 607.00 | \$ 1,037.00 |
| | ER Rectangular | \$ 734.00 | \$ 747.00 | \$ 369.00 | \$ 671.00 | \$ 1,075.00 |

The options listed above are considered standard. Non-standard options are available upon request.

For more options on Rosettes and Escutcheon plates see page 23. For more options on Finishes see pages 12-13.

RE = Rectangular rosettes available for tubular latch application only. Add + \$ 30.00 LIST to the price of the RQ. For slim rosette and European version see pages 100-103.

Upcharges apply for the following special options:

- Extra thick door (> 2")
- Non-standard rosettes (rosettes not listed above)
- Non-standard finishes (finishes not listed above)
- Split finishes

See page 17 for pricing. Exclusions may apply.

Matching elements

- Pg 168 Mortise lock functions
- Pg 152 Deadbolts
- Pg 154 Privacy Bolts
- Pg 156 Escutcheons with deadbolts
- Pg 160 Multi-Point Trim functions

European window lever style available in the same design. Call for pricing.



H 335 Richard Meier

| | | |
|----------|------------|-------|
| Material | Collection | Group |
| Brass | Fusital | 6 |

Standard option (mm/inches)

RP Round rosette

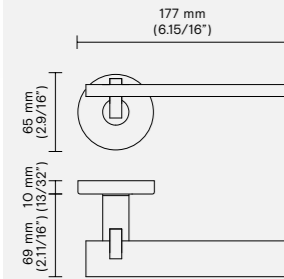

Standard option (mm/inches)

RQ Square rosette

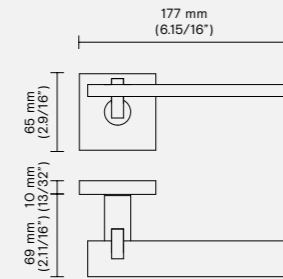

Escutcheon options (mm/inches)

EP Oval plate

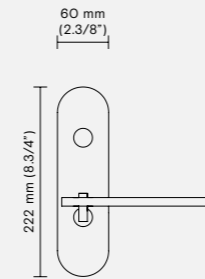

ER Rectangular plate

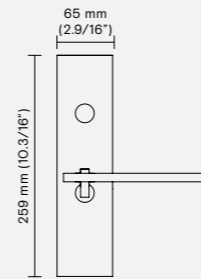

Conversions from metric to U.S. measurements are approximate.

Retail price

| Finish | Rosette | Function | | DMY R/L Single | ML-F Entry |
|--------------------|-----------|-----------|-----------|----------------|-------------|
| | | PGE | PCY | | |
| 26 Polished chrome | RP Round | \$ 710.00 | \$ 751.00 | \$ 348.00 | \$ 1,213.00 |
| | RQ Square | \$ 829.00 | \$ 870.00 | \$ 408.00 | \$ 1,389.00 |
| 26D Satin chrome | RP Round | \$ 791.00 | \$ 827.00 | \$ 386.00 | \$ 1,213.00 |
| | RQ Square | \$ 910.00 | \$ 945.00 | \$ 445.00 | \$ 1,389.00 |

Retail price

| Finish | Escutcheon | Function | | DMY R/L Single | DMY R/L Pair | ML-F Entry |
|--------------------|----------------|-----------|-----------|----------------|--------------|-------------|
| | | PGE | PCY | | | |
| 26 Polished chrome | EP Oval | \$ 785.00 | \$ 796.00 | \$ 387.00 | \$ 724.00 | \$ 1,163.00 |
| | ER Rectangular | \$ 819.00 | \$ 833.00 | \$ 410.00 | \$ 772.00 | \$ 1,200.00 |
| 26D Satin chrome | EP Oval | \$ 785.00 | \$ 796.00 | \$ 387.00 | \$ 724.00 | \$ 1,163.00 |
| | ER Rectangular | \$ 819.00 | \$ 833.00 | \$ 410.00 | \$ 772.00 | \$ 1,200.00 |

The options listed above are considered standard. Non-standard options are available upon request.

For more options on Rosettes and Escutcheon plates see page 23. For more options on Finishes see pages 12-13.

RE = Rectangular rosettes available for tubular latch application only. Add + \$ 30.00 LIST to the price of the RQ. For slim rosette and European version see pages 100-103.

Upcharges apply for the following special options:

- Extra thick door (> 2")
- Non-standard rosettes (rosettes not listed above)
- Non-standard finishes (finishes not listed above)
- Split finishes

See page 17 for pricing. Exclusions may apply.

Matching elements

- Pg 168 Mortise lock functions
- Pg 152 Deadbolts
- Pg 154 Privacy Bolts
- Pg 156 Escutcheons with deadbolts
- Pg 160 Multi-Point Trim functions

European window lever style available in the same design. Call for pricing.



H 338 Yoshimi Kono

| | | |
|----------|------------|-------|
| Material | Collection | Group |
| Brass | Fusital | 5 |

Standard option (mm/inches)

RP Round rosette

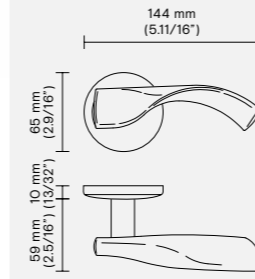

Standard option (mm/inches)

RQ Square rosette

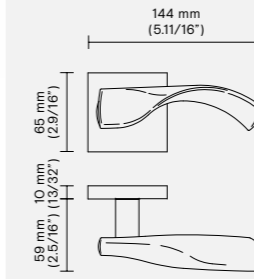

Escutcheon options (mm/inches)

EP Oval plate

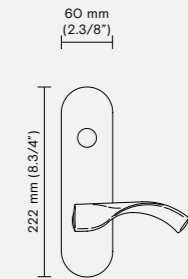

ER Rectangular plate

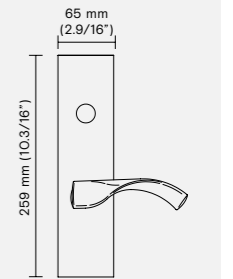

Slim rosette available - See pages 102-103

Conversions from metric to U.S. measurements are approximate.

Retail price

| Finish | Rosette | Function | | DMY R/L Single | ML-F Entry |
|------------------|-----------|-----------|-----------|----------------|-------------|
| | | PGE | PCY | | |
| 15 Satin nickel | RP Round | \$ 719.00 | \$ 739.00 | \$ 348.00 | \$ 1,100.00 |
| | RQ Square | \$ 803.00 | \$ 816.00 | \$ 428.00 | \$ 1,238.00 |
| 16 Dull black | RP Round | \$ 790.00 | \$ 813.00 | \$ 383.00 | \$ 1,100.00 |
| | RQ Square | \$ 883.00 | \$ 933.00 | \$ 470.00 | \$ 1,238.00 |
| 26D Satin chrome | RP Round | \$ 535.00 | \$ 551.00 | \$ 255.00 | \$ 1,100.00 |
| | RQ Square | \$ 654.00 | \$ 670.00 | \$ 315.00 | \$ 1,238.00 |

Retail price

| Finish | Escutcheon | Function | | DMY R/L Single | DMY R/L Pair | ML-F Entry |
|------------------|----------------|-----------|-----------|----------------|--------------|-------------|
| | | PGE | PCY | | | |
| 26D Satin chrome | EP Oval | \$ 683.00 | \$ 696.00 | \$ 330.00 | \$ 607.00 | \$ 1,037.00 |
| | ER Rectangular | \$ 734.00 | \$ 747.00 | \$ 369.00 | \$ 671.00 | \$ 1,075.00 |

The options listed above are considered standard. Non-standard options are available upon request.

For more options on Rosettes and Escutcheon plates see page 23. For more options on Finishes see pages 12-13.

RE = Rectangular rosettes available for tubular latch application only. Add + \$ 30.00 LIST to the price of the RQ. For slim rosette and European version see pages 100-103.

Upcharges apply for the following special options:

- Extra thick door (> 2")
- Non-standard rosettes (rosettes not listed above)
- Non-standard finishes (finishes not listed above)
- Split finishes

See page 17 for pricing. Exclusions may apply.

Matching elements

- Pg 168 Mortise lock functions
- Pg 152 Deadbolts
- Pg 154 Privacy Bolts
- Pg 156 Escutcheons with deadbolts
- Pg 160 Multi-Point Trim functions

European window lever style available in the same design. Call for pricing.



H 343 John Pawson

| | | |
|----------|------------|-------|
| Material | Collection | Group |
| Brass | Fusital | 6 |

Standard option (mm/inches)

RQ Square rosette

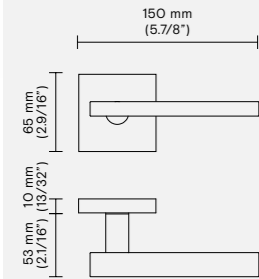

Standard option (mm/inches)

RP Round rosette

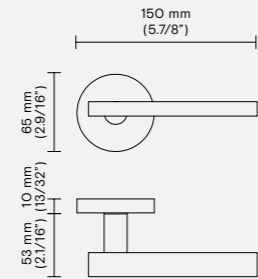

Escutcheon options (mm/inches)

EP Oval plate

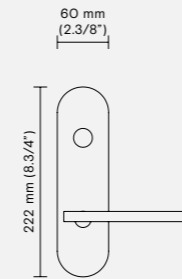

ER Rectangular plate

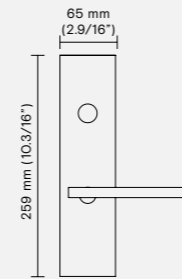

Conversions from metric to U.S. measurements are approximate.

Slim rosette available - See pages 102-103

Retail price

| Finish | Rosette | Function | | DMY R/L Single | ML-F Entry |
|--------------------|-----------|-----------|-----------|----------------|-------------|
| | | PGE | PCY | | |
| 14 Polished nickel | RP Round | \$ 642.00 | \$ 683.00 | \$ 320.00 | \$ 1,213.00 |
| | RQ Square | \$ 790.00 | \$ 827.00 | \$ 401.00 | \$ 1,389.00 |
| 15 Satin nickel | RP Round | \$ 623.00 | \$ 657.00 | \$ 308.00 | \$ 1,213.00 |
| | RQ Square | \$ 754.00 | \$ 782.00 | \$ 386.00 | \$ 1,389.00 |
| 26 Polished chrome | RP Round | \$ 571.00 | \$ 599.00 | \$ 280.00 | \$ 1,213.00 |
| | RQ Square | \$ 694.00 | \$ 728.00 | \$ 350.00 | \$ 1,389.00 |
| 26D Satin chrome | RP Round | \$ 594.00 | \$ 626.00 | \$ 293.00 | \$ 1,213.00 |
| | RQ Square | \$ 734.00 | \$ 767.00 | \$ 373.00 | \$ 1,389.00 |

Retail price

| Finish | Escutcheon | Function | | DMY R/L Single | DMY R/L Pair | ML-F Entry |
|--------------------|----------------|-----------|-----------|----------------|--------------|-------------|
| | | PGE | PCY | | | |
| 26 Polished chrome | EP Oval | \$ 785.00 | \$ 796.00 | \$ 387.00 | \$ 724.00 | \$ 1,163.00 |
| | ER Rectangular | \$ 819.00 | \$ 833.00 | \$ 410.00 | \$ 772.00 | \$ 1,200.00 |
| 26D Satin chrome | EP Oval | \$ 785.00 | \$ 796.00 | \$ 387.00 | \$ 724.00 | \$ 1,163.00 |
| | ER Rectangular | \$ 819.00 | \$ 833.00 | \$ 410.00 | \$ 772.00 | \$ 1,200.00 |

The options listed above are considered standard. Non-standard options are available upon request.

For more options on Rosettes and Escutcheon plates see page 23. For more options on Finishes see pages 12-13.

RE = Rectangular rosettes available for tubular latch application only. Add + \$ 30.00 LIST to the price of the RQ. For slim rosette and European version see pages 100-103.

Upcharges apply for the following special options:

- Extra thick door (> 2")
- Non-standard rosettes (rosettes not listed above)
- Non-standard finishes (finishes not listed above)
- Split finishes

See page 17 for pricing. Exclusions may apply.

Matching elements

- Pg 168 Mortise lock functions
- Pg 152 Deadbolts
- Pg 154 Privacy Bolts
- Pg 156 Escutcheons with deadbolts
- Pg 160 Multi-Point Trim functions

European window lever style available in the same design. Call for pricing.



H 348 David Chipperfield

| | | |
|----------|------------|-------|
| Material | Collection | Group |
| Brass | Fusital | 5 |

Standard option (mm/inches)

RP Round rosette

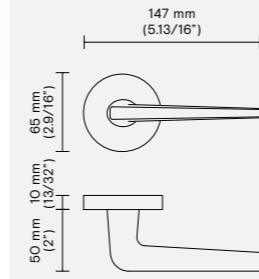

Standard option (mm/inches)

RQ Square rosette

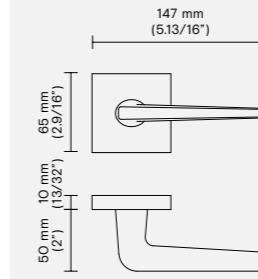

Escutcheon options (mm/inches)

EP Oval plate

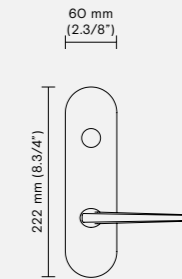

ER Rectangular plate

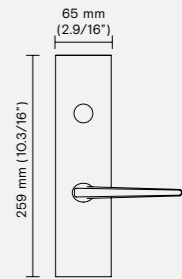

Conversions from metric to U.S. measurements are approximate.

Slim rosette available - See pages 102-103

Retail price

| Finish | Rosette | Function | | DMY R/L Single | ML-F Entry |
|--------------------|-----------|-----------|-----------|----------------|-------------|
| | | PGE | PCY | | |
| 15 Satin nickel | RP Round | \$ 547.00 | \$ 562.00 | \$ 264.00 | \$ 1,100.00 |
| | RQ Square | \$ 666.00 | \$ 681.00 | \$ 323.00 | \$ 1,238.00 |
| 16 Dull black | RP Round | \$ 505.00 | \$ 532.00 | \$ 249.00 | \$ 1,100.00 |
| | RQ Square | \$ 624.00 | \$ 651.00 | \$ 308.00 | \$ 1,238.00 |
| 26 Polished chrome | RP Round | \$ 441.00 | \$ 466.00 | \$ 211.00 | \$ 1,100.00 |
| | RQ Square | \$ 560.00 | \$ 585.00 | \$ 270.00 | \$ 1,238.00 |
| 26D Satin chrome | RP Round | \$ 445.00 | \$ 469.00 | \$ 213.00 | \$ 1,100.00 |
| | RQ Square | \$ 564.00 | \$ 588.00 | \$ 273.00 | \$ 1,238.00 |

Retail price

| Finish | Escutcheon | Function | | DMY R/L Single | DMY R/L Pair | ML-F Entry |
|--------------------|----------------|-----------|-----------|----------------|--------------|-------------|
| | | PGE | PCY | | | |
| 26 Polished chrome | EP Oval | \$ 683.00 | \$ 696.00 | \$ 330.00 | \$ 607.00 | \$ 1,037.00 |
| | ER Rectangular | \$ 734.00 | \$ 747.00 | \$ 369.00 | \$ 671.00 | \$ 1,075.00 |
| 26D Satin chrome | EP Oval | \$ 683.00 | \$ 696.00 | \$ 330.00 | \$ 607.00 | \$ 1,037.00 |
| | ER Rectangular | \$ 734.00 | \$ 747.00 | \$ 369.00 | \$ 671.00 | \$ 1,075.00 |

The options listed above are considered standard. Non-standard options are available upon request.

For more options on Rosettes and Escutcheon plates see page 23. For more options on Finishes see pages 12-13.

RE = Rectangular rosettes available for tubular latch application only. Add + \$ 30.00 LIST to the price of the RQ. For slim rosette and European version see pages 100-103.

Upcharges apply for the following special options:

- Extra thick door (> 2")
- Non-standard rosettes (rosettes not listed above)
- Non-standard finishes (finishes not listed above)
- Split finishes

See page 17 for pricing. Exclusions may apply.

Matching elements

- Pg 168 Mortise lock functions
- Pg 152 Deadbolts
- Pg 154 Privacy Bolts
- Pg 156 Escutcheons with deadbolts
- Pg 160 Multi-Point Trim functions

European window lever style available in the same design. Call for pricing.



H 356

Zaha Hadid

| | | |
|------------|------------|-------|
| Material | Collection | Group |
| Zinc alloy | Fusital | 8 |

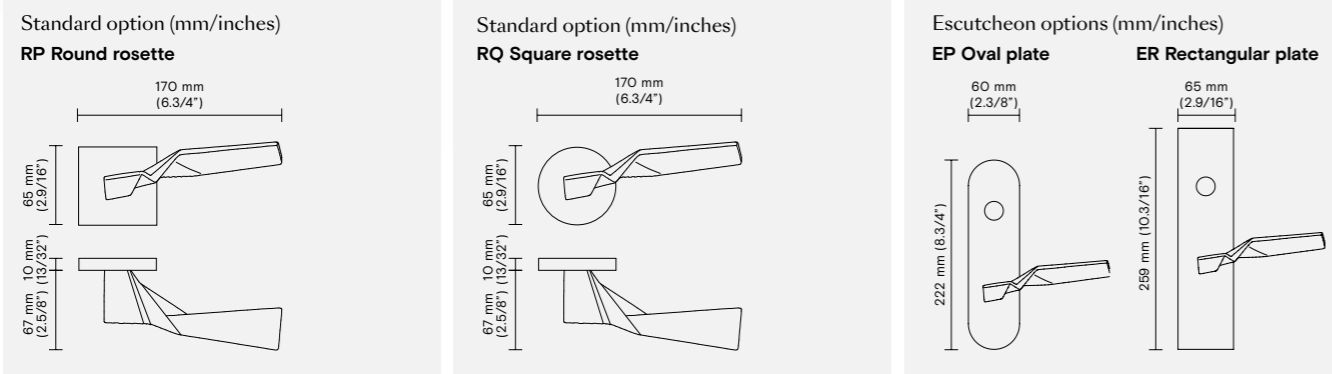

Slim rosette available - See pages 102-103

Conversions from metric to U.S. measurements are approximate.

Retail price

| Finish | Rosette | Function | | DMY R/L Single | ML-F Entry |
|---------------------------|------------------|-------------|-------------|----------------|-------------|
| | | PGE | PCY | | |
| 22M Matt white | RP Round | \$ 1,088.00 | \$ 1,116.00 | \$ 538.00 | \$ 1,668.00 |
| | RQ Square | \$ 1,208.00 | \$ 1,242.00 | \$ 610.00 | \$ 1,819.00 |
| 26 Polished chrome | RP Round | \$ 1,088.00 | \$ 1,116.00 | \$ 538.00 | \$ 1,668.00 |
| | RQ Square | \$ 1,208.00 | \$ 1,242.00 | \$ 610.00 | \$ 1,819.00 |
| 26D Satin chrome | RP Round | \$ 1,095.00 | \$ 1,125.00 | \$ 540.00 | \$ 1,668.00 |
| | RQ Square | \$ 1,230.00 | \$ 1,269.00 | \$ 626.00 | \$ 1,819.00 |

Retail price

| Finish | Escutcheon | Function | | DMY R/L Single | DMY R/L Pair | ML-F Entry |
|---------------------------|-----------------------|-------------|-------------|----------------|--------------|-------------|
| | | PGE | PCY | | | |
| 26 Polished chrome | EP Oval | \$ 1,264.00 | \$ 1,289.00 | \$ 633.00 | \$ 1,200.00 | \$ 1,617.00 |
| | ER Rectangular | \$ 1,328.00 | \$ 1,340.00 | \$ 658.00 | \$ 1,251.00 | \$ 1,655.00 |
| 26D Satin chrome | EP Oval | \$ 1,264.00 | \$ 1,289.00 | \$ 633.00 | \$ 1,200.00 | \$ 1,617.00 |
| | ER Rectangular | \$ 1,328.00 | \$ 1,340.00 | \$ 658.00 | \$ 1,251.00 | \$ 1,655.00 |

The options listed above are considered standard. Non-standard options are available upon request.

For more options on Rosettes and Escutcheon plates see page 23. For more options on Finishes see pages 12-13.

RE = Rectangular rosettes available for tubular latch application only. Add + \$ 30.00 LIST to the price of the RQ. For slim rosette and European version see pages 100-103.

Upcharges apply for the following special options:

- Extra thick door (> 2")
- Non-standard rosettes (rosettes not listed above)
- Non-standard finishes (finishes not listed above)
- Split finishes

See page 17 for pricing. Exclusions may apply.

Matching elements

- Pg 168 Mortise lock functions
- Pg 152 Deadbolts
- Pg 154 Privacy Bolts
- Pg 156 Escutcheons with deadbolts
- Pg 160 Multi-Point Trim functions

European window lever style available in the same design. Call for pricing.



H 359

SOM - Skidmore, Owings & Merrill

| | | |
|----------|------------|-------|
| Material | Collection | Group |
| Brass | Fusital | 6 |

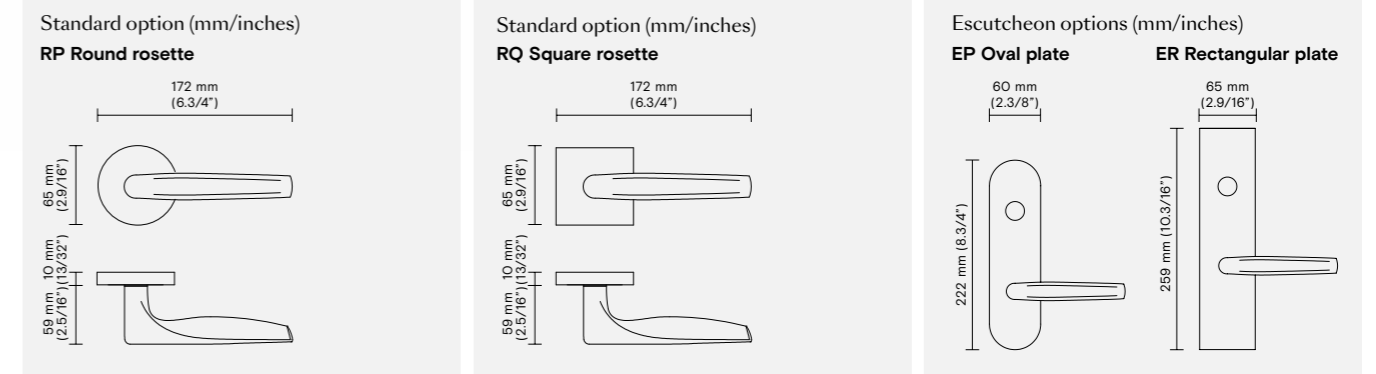

Slim rosette available - See pages 102-103

Conversions from metric to U.S. measurements are approximate.

Retail price

| Finish | Rosette | Function | | DMY R/L Single | ML-F Entry |
|---------------------------|------------------|-----------|-----------|----------------|-------------|
| | | PGE | PCY | | |
| 06M Matt bronze | RP Round | \$ 590.00 | \$ 606.00 | \$ 281.00 | \$ 1,213.00 |
| | RQ Square | \$ 709.00 | \$ 725.00 | \$ 341.00 | \$ 1,389.00 |
| 14 Polished nickel | RP Round | \$ 604.00 | \$ 623.00 | \$ 292.00 | \$ 1,213.00 |
| | RQ Square | \$ 723.00 | \$ 741.00 | \$ 351.00 | \$ 1,389.00 |
| 15 Satin nickel | RP Round | \$ 604.00 | \$ 623.00 | \$ 292.00 | \$ 1,213.00 |
| | RQ Square | \$ 723.00 | \$ 741.00 | \$ 351.00 | \$ 1,389.00 |
| 26 Polished chrome | RP Round | \$ 535.00 | \$ 549.00 | \$ 256.00 | \$ 1,213.00 |
| | RQ Square | \$ 654.00 | \$ 668.00 | \$ 316.00 | \$ 1,389.00 |
| 26D Satin chrome | RP Round | \$ 562.00 | \$ 578.00 | \$ 269.00 | \$ 1,213.00 |
| | RQ Square | \$ 681.00 | \$ 697.00 | \$ 329.00 | \$ 1,389.00 |

Retail price

| Finish | Escutcheon | Function | | DMY R/L Single | DMY R/L Pair | ML-F Entry |
|---------------------------|-----------------------|-----------|-----------|----------------|--------------|-------------|
| | | PGE | PCY | | | |
| 26 Polished chrome | EP Oval | \$ 785.00 | \$ 796.00 | \$ 387.00 | \$ 724.00 | \$ 1,163.00 |
| | ER Rectangular | \$ 819.00 | \$ 833.00 | \$ 410.00 | \$ 772.00 | \$ 1,200.00 |
| 26D Satin chrome | EP Oval | \$ 785.00 | \$ 796.00 | \$ 387.00 | \$ 724.00 | \$ 1,163.00 |
| | ER Rectangular | \$ 819.00 | \$ 833.00 | \$ 410.00 | \$ 772.00 | \$ 1,200.00 |

The options listed above are considered standard. Non-standard options are available upon request.

For more options on Rosettes and Escutcheon plates see page 23. For more options on Finishes see pages 12-13.

RE = Rectangular rosettes available for tubular latch application only. Add + \$ 30.00 LIST to the price of the RQ. For slim rosette and European version see pages 100-103.

Upcharges apply for the following special options:

- Extra thick door (> 2")
- Non-standard rosettes (rosettes not listed above)
- Non-standard finishes (finishes not listed above)
- Split finishes

See page 17 for pricing. Exclusions may apply.

Matching elements

- Pg 168 Mortise lock functions
- Pg 152 Deadbolts
- Pg 154 Privacy Bolts
- Pg 156 Escutcheons with deadbolts
- Pg 160 Multi-Point Trim functions

European window lever style available in the same design. Call for pricing.



H 361

Antonio Citterio with Toan Nguyen

PRESTO

| | | |
|------------|------------|-------|
| Material | Collection | Group |
| Zinc alloy | Fusital | 5 |

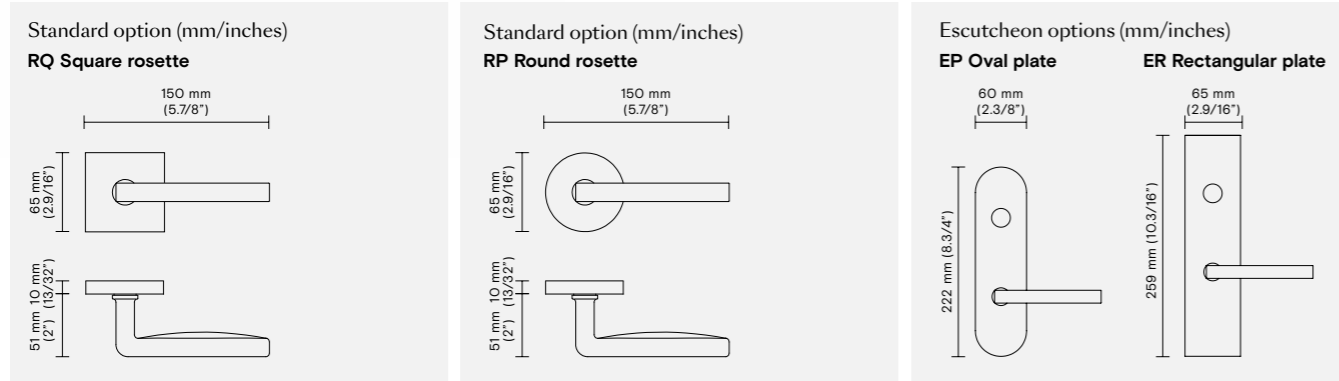

Slim rosette available - See pages 102-103

Conversions from metric to U.S. measurements are approximate.

Retail price

| Finish | Rosette | Function PGE | PCY | DMY R/L Single | ML-F Entry |
|--------------------|-----------|--------------|-----------|----------------|-------------|
| 14 Polished nickel | RP Round | \$ 462.00 | \$ 490.00 | \$ 224.00 | \$ 1,100.00 |
| | RQ Square | \$ 610.00 | \$ 628.00 | \$ 308.00 | \$ 1,238.00 |
| 15 Satin nickel | RP Round | \$ 463.00 | \$ 495.00 | \$ 224.00 | \$ 1,100.00 |
| | RQ Square | \$ 597.00 | \$ 615.00 | \$ 303.00 | \$ 1,238.00 |
| 26 Polished chrome | RP Round | \$ 409.00 | \$ 439.00 | \$ 196.00 | \$ 1,100.00 |
| | RQ Square | \$ 538.00 | \$ 555.00 | \$ 267.00 | \$ 1,238.00 |
| 26D Satin chrome | RP Round | \$ 422.00 | \$ 456.00 | \$ 207.00 | \$ 1,100.00 |
| | RQ Square | \$ 565.00 | \$ 583.00 | \$ 288.00 | \$ 1,238.00 |

Retail price

| Finish | Escutcheon | Function PGE | PCY | DMY R/L Single | DMY R/L Pair | ML-F Entry |
|--------------------|----------------|--------------|-----------|----------------|--------------|-------------|
| 26 Polished chrome | EP Oval | \$ 683.00 | \$ 696.00 | \$ 330.00 | \$ 607.00 | \$ 1,037.00 |
| | ER Rectangular | \$ 734.00 | \$ 747.00 | \$ 369.00 | \$ 671.00 | \$ 1,075.00 |
| 26D Satin chrome | EP Oval | \$ 683.00 | \$ 696.00 | \$ 330.00 | \$ 607.00 | \$ 1,037.00 |
| | ER Rectangular | \$ 734.00 | \$ 747.00 | \$ 369.00 | \$ 671.00 | \$ 1,075.00 |

The options listed above are considered standard. Non-standard options are available upon request.

For more options on Rosettes and Escutcheon plates see page 23. For more options on Finishes see pages 12-13.

RE = Rectangular rosettes available for tubular latch application only. Add + \$ 30.00 LIST to the price of the RQ. For slim rosette and European version see pages 100-103.

Upcharges apply for the following special options:

- Extra thick door (> 2")
- Non-standard rosettes (rosettes not listed above)
- Non-standard finishes (finishes not listed above)
- Split finishes

See page 17 for pricing. Exclusions may apply.

Matching elements

- Pg 168 Mortise lock functions
- Pg 152 Deadbolts
- Pg 154 Privacy Bolts
- Pg 156 Escutcheons with deadbolts
- Pg 160 Multi-Point Trim functions

European window lever style available in the same design. Call for pricing.

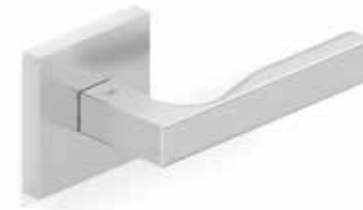

H 364

Mario Bellini

| | | |
|----------|------------|-------|
| Material | Collection | Group |
| Brass | Fusital | 5 |

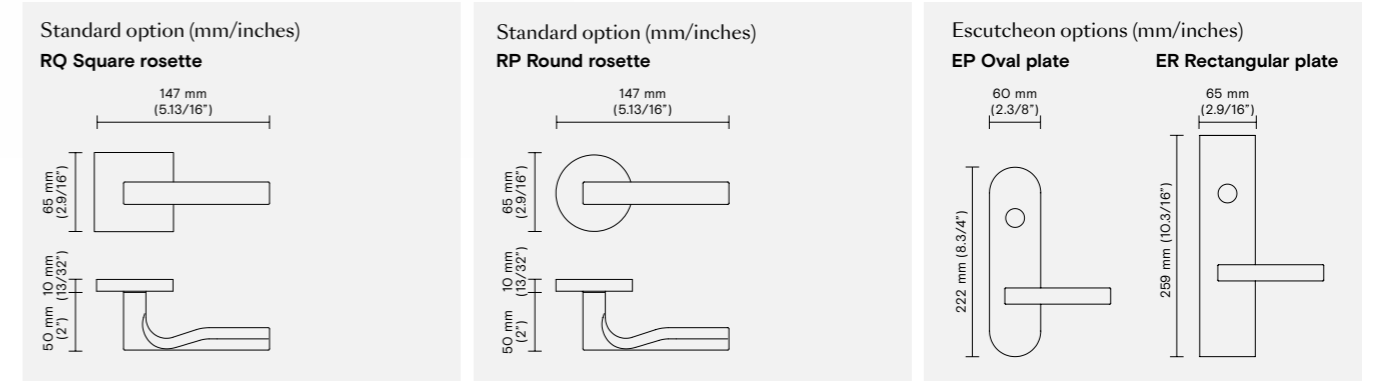

Slim rosette available - See pages 102-103

Conversions from metric to U.S. measurements are approximate.

Retail price

| Finish | Rosette | Function PGE | PCY | DMY R/L Single | ML-F Entry |
|--------------------|-----------|--------------|-----------|----------------|-------------|
| 15 Satin nickel | RP Round | \$ 535.00 | \$ 571.00 | \$ 259.00 | \$ 1,100.00 |
| | RQ Square | \$ 664.00 | \$ 712.00 | \$ 340.00 | \$ 1,238.00 |
| 26 Polished chrome | RP Round | \$ 497.00 | \$ 522.00 | \$ 236.00 | \$ 1,100.00 |
| | RQ Square | \$ 617.00 | \$ 651.00 | \$ 312.00 | \$ 1,238.00 |
| 26D Satin chrome | RP Round | \$ 502.00 | \$ 535.00 | \$ 238.00 | \$ 1,100.00 |
| | RQ Square | \$ 636.00 | \$ 668.00 | \$ 326.00 | \$ 1,238.00 |

Retail price

| Finish | Escutcheon | Function PGE | PCY | DMY R/L Single | DMY R/L Pair | ML-F Entry |
|--------------------|----------------|--------------|-----------|----------------|--------------|-------------|
| 26 Polished chrome | EP Oval | \$ 683.00 | \$ 696.00 | \$ 330.00 | \$ 607.00 | \$ 1,037.00 |
| | ER Rectangular | \$ 734.00 | \$ 747.00 | \$ 369.00 | \$ 671.00 | \$ 1,075.00 |
| 26D Satin chrome | EP Oval | \$ 683.00 | \$ 696.00 | \$ 330.00 | \$ 607.00 | \$ 1,037.00 |
| | ER Rectangular | \$ 734.00 | \$ 747.00 | \$ 369.00 | \$ 671.00 | \$ 1,075.00 |

The options listed above are considered standard. Non-standard options are available upon request.

For more options on Rosettes and Escutcheon plates see page 23. For more options on Finishes see pages 12-13.

RE = Rectangular rosettes available for tubular latch application only. Add + \$ 30.00 LIST to the price of the RQ. For slim rosette and European version see pages 100-103.

Upcharges apply for the following special options:

- Extra thick door (> 2")
- Non-standard rosettes (rosettes not listed above)
- Non-standard finishes (finishes not listed above)
- Split finishes

See page 17 for pricing. Exclusions may apply.

Matching elements

- Pg 168 Mortise lock functions
- Pg 152 Deadbolts
- Pg 154 Privacy Bolts
- Pg 156 Escutcheons with deadbolts
- Pg 160 Multi-Point Trim functions

European window lever style available in the same design. Call for pricing.



H 367 Giancarlo Vegni

| | | |
|----------|------------|-------|
| Material | Collection | Group |
| Brass | Fusital | 5 |

Standard option (mm/inches)

RQ Square rosette

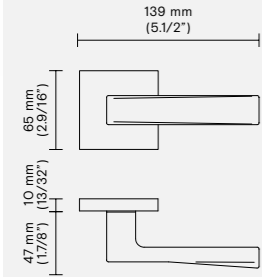

Standard option (mm/inches)

RP Round rosette

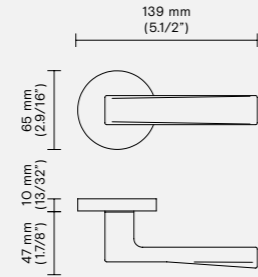

Escutcheon options (mm/inches)

EP Oval plate

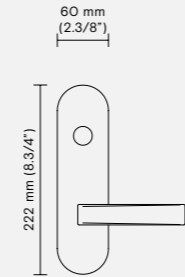

ER Rectangular plate

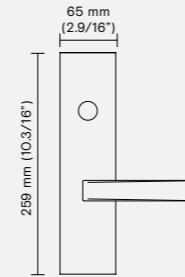

Conversions from metric to U.S. measurements are approximate.

Slim rosette available - See pages 102-103

Retail price

| Finish | Rosette | Function | | DMY R/L Single | ML-F Entry |
|--------------------|-----------|-----------|-----------|----------------|-------------|
| | | PGE | PCY | | |
| 26 Polished chrome | RP Round | \$ 502.00 | \$ 526.00 | \$ 238.00 | \$ 1,100.00 |
| | RQ Square | \$ 617.00 | \$ 651.00 | \$ 312.00 | \$ 1,238.00 |
| 26D Satin chrome | RP Round | \$ 509.00 | \$ 509.00 | \$ 240.00 | \$ 1,100.00 |
| | RQ Square | \$ 636.00 | \$ 668.00 | \$ 326.00 | \$ 1,238.00 |

Retail price

| Finish | Escutcheon | Function | | DMY R/L Single | DMY R/L Pair | ML-F Entry |
|--------------------|----------------|-----------|-----------|----------------|--------------|-------------|
| | | PGE | PCY | | | |
| 26 Polished chrome | EP Oval | \$ 683.00 | \$ 696.00 | \$ 330.00 | \$ 607.00 | \$ 1,037.00 |
| | ER Rectangular | \$ 734.00 | \$ 747.00 | \$ 369.00 | \$ 671.00 | \$ 1,075.00 |
| 26D Satin chrome | EP Oval | \$ 683.00 | \$ 696.00 | \$ 330.00 | \$ 607.00 | \$ 1,037.00 |
| | ER Rectangular | \$ 734.00 | \$ 747.00 | \$ 369.00 | \$ 671.00 | \$ 1,075.00 |

The options listed above are considered standard. Non-standard options are available upon request.

For more options on Rosettes and Escutcheon plates see page 23. For more options on Finishes see pages 12-13.

RE = Rectangular rosettes available for tubular latch application only. Add + \$ 30.00 LIST to the price of the RQ. For slim rosette and European version see pages 100-103.

Upcharges apply for the following special options:

- Extra thick door (> 2")
- Non-standard rosettes (rosettes not listed above)
- Non-standard finishes (finishes not listed above)
- Split finishes

See page 17 for pricing. Exclusions may apply.

Matching elements

- Pg 168 Mortise lock functions
- Pg 152 Deadbolts
- Pg 154 Privacy Bolts
- Pg 156 Escutcheons with deadbolts
- Pg 160 Multi-Point Trim functions

European window lever style available in the same design. Call for pricing.



H 368 Cerri & Associati

| | | |
|----------|------------|-------|
| Material | Collection | Group |
| Brass | Fusital | 5 |

Standard option (mm/inches)

RP Round rosette

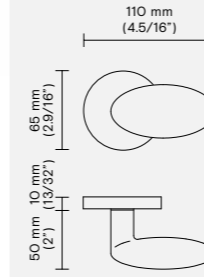

Standard option (mm/inches)

RQ Square rosette

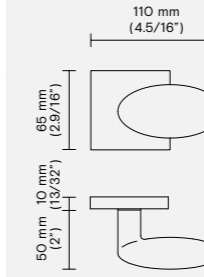

Escutcheon options (mm/inches)

EP Oval plate

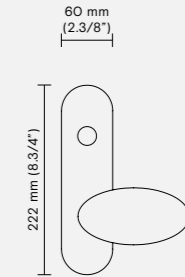

ER Rectangular plate

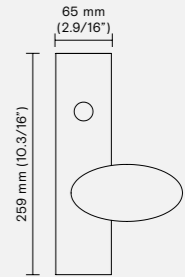

Conversions from metric to U.S. measurements are approximate.

Slim rosette available - See pages 102-103

Retail price

| Finish | Rosette | Function | | DMY R/L Single | ML-F Entry |
|--------------------|-----------|-----------|-----------|----------------|-------------|
| | | PGE | PCY | | |
| 26 Polished chrome | RP Round | \$ 459.00 | \$ 484.00 | \$ 216.00 | \$ 1,100.00 |
| | RQ Square | \$ 578.00 | \$ 603.00 | \$ 276.00 | \$ 1,238.00 |
| 26D Satin chrome | RP Round | \$ 474.00 | \$ 499.00 | \$ 224.00 | \$ 1,100.00 |
| | RQ Square | \$ 592.00 | \$ 618.00 | \$ 283.00 | \$ 1,238.00 |

Retail price

| Finish | Escutcheon | Function | | DMY R/L Single | DMY R/L Pair | ML-F Entry |
|--------------------|----------------|-----------|-----------|----------------|--------------|-------------|
| | | PGE | PCY | | | |
| 26 Polished chrome | EP Oval | \$ 683.00 | \$ 696.00 | \$ 330.00 | \$ 607.00 | \$ 1,037.00 |
| | ER Rectangular | \$ 734.00 | \$ 747.00 | \$ 369.00 | \$ 671.00 | \$ 1,075.00 |
| 26D Satin chrome | EP Oval | \$ 683.00 | \$ 696.00 | \$ 330.00 | \$ 607.00 | \$ 1,037.00 |
| | ER Rectangular | \$ 734.00 | \$ 747.00 | \$ 369.00 | \$ 671.00 | \$ 1,075.00 |

The options listed above are considered standard. Non-standard options are available upon request.

For more options on Rosettes and Escutcheon plates see page 23. For more options on Finishes see pages 12-13.

RE = Rectangular rosettes available for tubular latch application only. Add + \$ 30.00 LIST to the price of the RQ. For slim rosette and European version see pages 100-103.

Upcharges apply for the following special options:

- Extra thick door (> 2")
- Non-standard rosettes (rosettes not listed above)
- Non-standard finishes (finishes not listed above)
- Split finishes

See page 17 for pricing. Exclusions may apply.

Matching elements

- Pg 168 Mortise lock functions
- Pg 152 Deadbolts
- Pg 154 Privacy Bolts
- Pg 156 Escutcheons with deadbolts
- Pg 160 Multi-Point Trim functions

European window lever style available in the same design. Call for pricing.

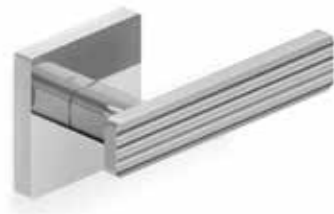

H 370

Doriana e Massimiliano Fuksas

| | | |
|----------|------------|-------|
| Material | Collection | Group |
| Brass | Fusital | 5 |

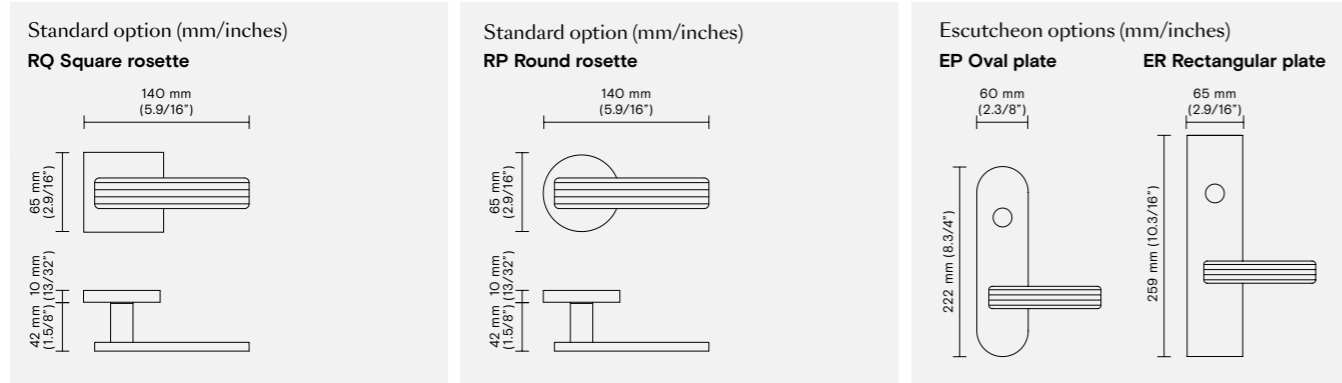

Conversions from metric to U.S. measurements are approximate.

Slim rosette available - See pages 102-103

Retail price

| Finish | Rosette | Function | | DMY R/L Single | ML-F Entry |
|--------------------|-----------|-----------|-----------|----------------|-------------|
| | | PGE | PCY | | |
| 26 Polished chrome | RP Round | \$ 389.00 | \$ 417.00 | \$ 194.00 | \$ 1,100.00 |
| | RQ Square | \$ 518.00 | \$ 552.00 | \$ 268.00 | \$ 1,238.00 |
| 26D Satin chrome | RP Round | \$ 401.00 | \$ 428.00 | \$ 202.00 | \$ 1,100.00 |
| | RQ Square | \$ 536.00 | \$ 573.00 | \$ 288.00 | \$ 1,238.00 |

Retail price

| Finish | Escutcheon | Function | | DMY R/L Single | DMY R/L Pair | ML-F Entry |
|--------------------|----------------|-----------|-----------|----------------|--------------|-------------|
| | | PGE | PCY | | | |
| 26 Polished chrome | EP Oval | \$ 683.00 | \$ 696.00 | \$ 330.00 | \$ 607.00 | \$ 1,037.00 |
| | ER Rectangular | \$ 734.00 | \$ 747.00 | \$ 369.00 | \$ 671.00 | \$ 1,075.00 |
| 26D Satin chrome | EP Oval | \$ 683.00 | \$ 696.00 | \$ 330.00 | \$ 607.00 | \$ 1,037.00 |
| | ER Rectangular | \$ 734.00 | \$ 747.00 | \$ 369.00 | \$ 671.00 | \$ 1,075.00 |

The options listed above are considered standard. Non-standard options are available upon request.

For more options on Rosettes and Escutcheon plates see page 23. For more options on Finishes see pages 12-13.

RE = Rectangular rosettes available for tubular latch application only. Add + \$ 30.00 LIST to the price of the RQ. For slim rosette and European version see pages 100-103.

Upcharges apply for the following special options:

- Extra thick door (> 2")
- Non-standard rosettes (rosettes not listed above)
- Non-standard finishes (finishes not listed above)
- Split finishes

See page 17 for pricing. Exclusions may apply.

Matching elements

- Pg 168 Mortise lock functions
- Pg 152 Deadbolts
- Pg 154 Privacy Bolts
- Pg 156 Escutcheons with deadbolts
- Pg 160 Multi-Point Trim functions

European window lever style available in the same design. Call for pricing.



H 372

Eri Goshen

| | | |
|----------|------------|-------|
| Material | Collection | Group |
| Brass | Fusital | 5 |

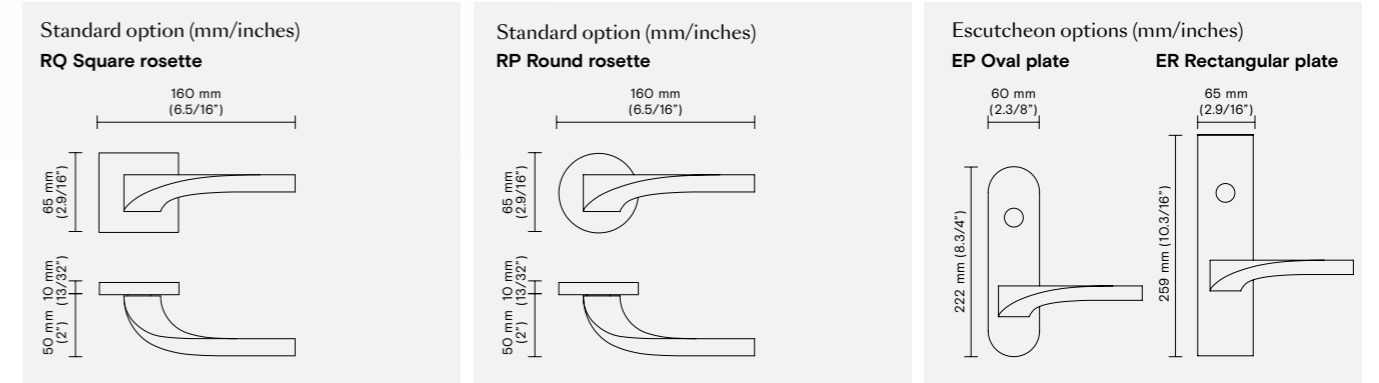

Conversions from metric to U.S. measurements are approximate.

Slim rosette available - See pages 102-103

Retail price

| Finish | Rosette | Function | | DMY R/L Single | ML-F Entry |
|---------------------------|-----------|-----------|-----------|----------------|-------------|
| | | PGE | PCY | | |
| 17A Polished black nickel | RP Round | \$ 454.00 | \$ 485.00 | \$ 228.00 | \$ 1,100.00 |
| | RQ Square | \$ 602.00 | \$ 640.00 | \$ 321.00 | \$ 1,238.00 |
| 26 Polished chrome | RP Round | \$ 398.00 | \$ 423.00 | \$ 199.00 | \$ 1,100.00 |
| | RQ Square | \$ 518.00 | \$ 552.00 | \$ 272.00 | \$ 1,238.00 |
| 26D Satin chrome | RP Round | \$ 414.00 | \$ 443.00 | \$ 209.00 | \$ 1,100.00 |
| | RQ Square | \$ 549.00 | \$ 583.00 | \$ 293.00 | \$ 1,238.00 |

Retail price

| Finish | Escutcheon | Function | | DMY R/L Single | DMY R/L Pair | ML-F Entry |
|--------------------|----------------|-----------|-----------|----------------|--------------|-------------|
| | | PGE | PCY | | | |
| 26 Polished chrome | EP Oval | \$ 683.00 | \$ 696.00 | \$ 330.00 | \$ 607.00 | \$ 1,037.00 |
| | ER Rectangular | \$ 734.00 | \$ 747.00 | \$ 369.00 | \$ 671.00 | \$ 1,075.00 |
| 26D Satin chrome | EP Oval | \$ 683.00 | \$ 696.00 | \$ 330.00 | \$ 607.00 | \$ 1,037.00 |
| | ER Rectangular | \$ 734.00 | \$ 747.00 | \$ 369.00 | \$ 671.00 | \$ 1,075.00 |

The options listed above are considered standard. Non-standard options are available upon request.

For more options on Rosettes and Escutcheon plates see page 23. For more options on Finishes see pages 12-13.

RE = Rectangular rosettes available for tubular latch application only. Add + \$ 30.00 LIST to the price of the RQ. For slim rosette and European version see pages 100-103.

Upcharges apply for the following special options:

- Extra thick door (> 2")
- Non-standard rosettes (rosettes not listed above)
- Non-standard finishes (finishes not listed above)
- Split finishes

See page 17 for pricing. Exclusions may apply.

Matching elements

- Pg 168 Mortise lock functions
- Pg 152 Deadbolts
- Pg 154 Privacy Bolts
- Pg 156 Escutcheons with deadbolts
- Pg 160 Multi-Point Trim functions

European window lever style available in the same design. Call for pricing.



H 376 Giancarlo Vegni

| | | |
|----------|------------|-------|
| Material | Collection | Group |
| Brass | Fusital | 6 |

Standard option (mm/inches)

RQ Square rosette

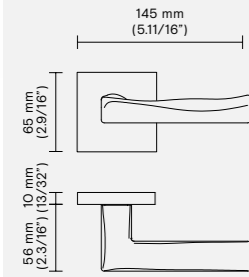

Standard option (mm/inches)

RP Round rosette

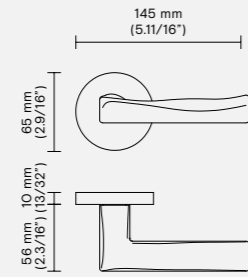

Escutcheon options (mm/inches)

EP Oval plate

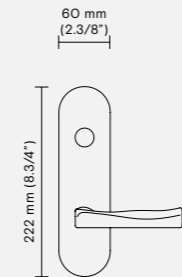

ER Rectangular plate

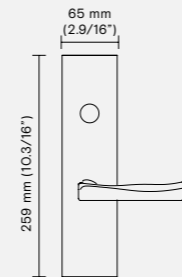

Conversions from metric to U.S. measurements are approximate.

Retail price

| Finish | Rosette | Function | | DMY R/L Single | ML-F Entry |
|--------------------|-----------|-----------|-----------|----------------|-------------|
| | | PGE | PCY | | |
| 26 Polished chrome | RP Round | \$ 517.00 | \$ 536.00 | \$ 252.00 | \$ 1,213.00 |
| | RQ Square | \$ 629.00 | \$ 668.00 | \$ 322.00 | \$ 1,389.00 |
| 26D Satin chrome | RP Round | \$ 530.00 | \$ 555.00 | \$ 266.00 | \$ 1,213.00 |
| | RQ Square | \$ 668.00 | \$ 699.00 | \$ 354.00 | \$ 1,389.00 |

Retail price

| Finish | Escutcheon | Function | | DMY R/L Single | DMY R/L Pair | ML-F Entry |
|--------------------|----------------|-----------|-----------|----------------|--------------|-------------|
| | | PGE | PCY | | | |
| 26 Polished chrome | EP Oval | \$ 683.00 | \$ 696.00 | \$ 330.00 | \$ 607.00 | \$ 1,163.00 |
| | ER Rectangular | \$ 734.00 | \$ 747.00 | \$ 369.00 | \$ 671.00 | \$ 1,200.00 |
| 26D Satin chrome | EP Oval | \$ 683.00 | \$ 696.00 | \$ 330.00 | \$ 607.00 | \$ 1,163.00 |
| | ER Rectangular | \$ 734.00 | \$ 747.00 | \$ 369.00 | \$ 671.00 | \$ 1,200.00 |

The options listed above are considered standard. Non-standard options are available upon request.

For more options on Rosettes and Escutcheon plates see page 23. For more options on Finishes see pages 12-13.

RE = Rectangular rosettes available for tubular latch application only. Add + \$ 30.00 LIST to the price of the RQ. For slim rosette and European version see pages 100-103.

Upcharges apply for the following special options:

- Extra thick door (> 2")
- Non-standard rosettes (rosettes not listed above)
- Non-standard finishes (finishes not listed above)
- Split finishes

See page 17 for pricing. Exclusions may apply.

Matching elements

- Pg 168 Mortise lock functions
- Pg 152 Deadbolts
- Pg 154 Privacy Bolts
- Pg 156 Escutcheons with deadbolts
- Pg 160 Multi-Point Trim functions

European window lever style available in the same design. Call for pricing.



H 377 Steve Leung

| | | |
|----------|------------|-------|
| Material | Collection | Group |
| Brass | Fusital | 7 |

Standard option (mm/inches)

RQ Square rosette

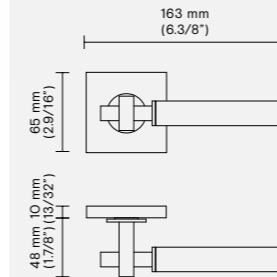

Standard option (mm/inches)

RP Round rosette

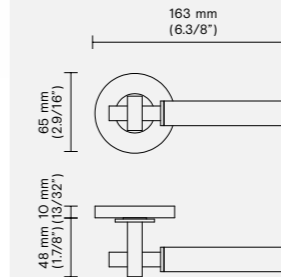

Escutcheon options (mm/inches)

EP Oval plate

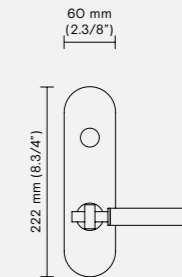

ER Rectangular plate

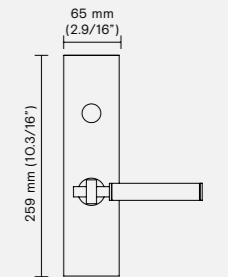

Slim rosette available - See pages 102-103

*Only available on request
Conversions from metric to U.S. measurements are approximate.

Retail price

| Finish | Rosette | Function | | DMY R/L Single | ML-F Entry |
|----------------|-----------|-----------|-----------|----------------|-------------|
| | | PGE | PCY | | |
| 03M Matt brass | RP Round | \$ 617.00 | \$ 646.00 | \$ 302.00 | \$ 1,617.00 |
| | RQ Square | \$ 726.00 | \$ 754.00 | \$ 356.00 | \$ 1,755.00 |
| 16 Dull black | RP Round | \$ 517.00 | \$ 543.00 | \$ 254.00 | \$ 1,617.00 |
| | RQ Square | \$ 651.00 | \$ 692.00 | \$ 342.00 | \$ 1,755.00 |
| 56 Dark bronze | RP Round | \$ 720.00 | \$ 774.00 | \$ 365.00 | \$ 1,617.00 |
| | RQ Square | \$ 838.00 | \$ 881.00 | \$ 425.00 | \$ 1,755.00 |

The options listed above are considered standard. Non-standard options are available upon request.

For more options on Rosettes and Escutcheon plates see page 23. For more options on Finishes see pages 12-13.

RE = Rectangular rosettes available for tubular latch application only. Add + \$ 30.00 LIST to the price of the RQ. For slim rosette and European version see pages 100-103.

Upcharges apply for the following special options:

- Extra thick door (> 2")
- Non-standard rosettes (rosettes not listed above)
- Non-standard finishes (finishes not listed above)
- Split finishes

See page 17 for pricing. Exclusions may apply.

Matching elements

- Pg 168 Mortise lock functions
- Pg 152 Deadbolts
- Pg 154 Privacy Bolts
- Pg 156 Escutcheons with deadbolts
- Pg 160 Multi-Point Trim functions

European window lever style available in the same design. Call for pricing.



H 378 Yabu Pushelberg

| | | |
|----------|------------|-------|
| Material | Collection | Group |
| Brass | Fusital | 6 |

Standard option (mm/inches)

RP Round rosette

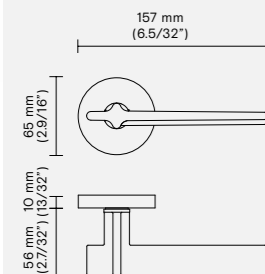

Standard option (mm/inches)

RQ Square rosette

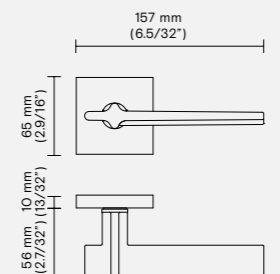

Escutcheon options (mm/inches)

EP Oval plate ER Rectangular plate

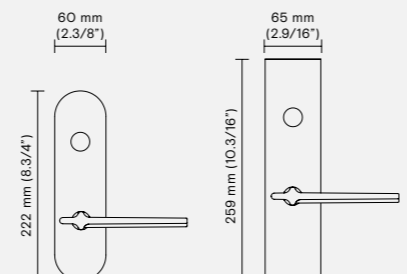

Conversions from metric to U.S. measurements are approximate.

Slim rosette available - See pages 102-103

Retail price

| Finish | Rosette | Function | | DMY R/L Single | ML-F Entry |
|---------------------------|-----------|-----------|-----------|----------------|-------------|
| | | PGE | PCY | | |
| 17A Polished black nickel | RP Round | \$ 618.00 | \$ 649.00 | \$ 298.00 | \$ 1,213.00 |
| | RQ Square | \$ 747.00 | \$ 766.00 | \$ 373.00 | \$ 1,389.00 |
| 26 Polished chrome | RP Round | \$ 590.00 | \$ 562.00 | \$ 271.00 | \$ 1,213.00 |
| | RQ Square | \$ 679.00 | \$ 697.00 | \$ 341.00 | \$ 1,389.00 |
| 56 Dark bronze | RP Round | \$ 676.00 | \$ 709.00 | \$ 325.00 | \$ 1,213.00 |
| | RQ Square | \$ 815.00 | \$ 835.00 | \$ 408.00 | \$ 1,389.00 |

Retail price

| Finish | Escutcheon | Function | | DMY R/L Single | DMY R/L Pair | ML-F Entry |
|--------------------|----------------|-----------|-----------|----------------|--------------|-------------|
| | | PGE | PCY | | | |
| 26 Polished chrome | EP Oval | \$ 785.00 | \$ 796.00 | \$ 387.00 | \$ 724.00 | \$ 1,163.00 |
| | ER Rectangular | \$ 819.00 | \$ 833.00 | \$ 410.00 | \$ 772.00 | \$ 1,200.00 |

The options listed above are considered standard. Non-standard options are available upon request.

For more options on Rosettes and Escutcheon plates see page 23. For more options on Finishes see pages 12-13.

RE = Rectangular rosettes available for tubular latch application only. Add + \$ 30.00 LIST to the price of the RQ. For slim rosette and European version see pages 100-103.

Upcharges apply for the following special options:

- Extra thick door (> 2")
- Non-standard rosettes (rosettes not listed above)
- Non-standard finishes (finishes not listed above)
- Split finishes

See page 17 for pricing. Exclusions may apply.

Matching elements

- Pg 168 Mortise lock functions
- Pg 152 Deadbolts
- Pg 154 Privacy Bolts
- Pg 156 Escutcheons with deadbolts
- Pg 160 Multi-Point Trim functions

European window lever style available in the same design. Call for pricing.



H 379 Antonio Citterio

| | | |
|----------|------------|-------|
| Material | Collection | Group |
| Brass | Fusital | 8 |

Standard option (mm/inches)

RP Round rosette

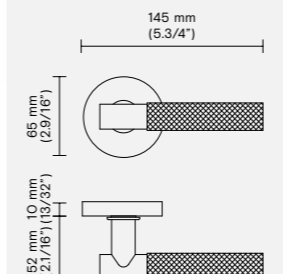

Standard option (mm/inches)

RQ Square rosette

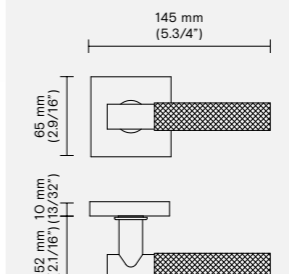

Escutcheon options (mm/inches)

EP Oval plate ER Rectangular plate

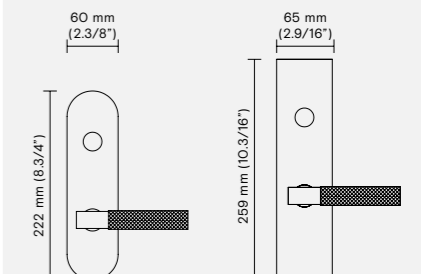

Conversions from metric to U.S. measurements are approximate.

Slim rosette available - See pages 102-103

Retail price

| Finish | Rosette | Function | | DMY R/L Single | ML-F Entry |
|------------------|-----------|-----------|-----------|----------------|-------------|
| | | PGE | PCY | | |
| 03M Matt brass | RP Round | \$ 647.00 | \$ 670.00 | \$ 270.00 | \$ 1,668.00 |
| | RQ Square | \$ 755.00 | \$ 789.00 | \$ 323.00 | \$ 1,819.00 |
| 06M Matt bronze | RP Round | \$ 759.00 | \$ 775.00 | \$ 319.00 | \$ 1,668.00 |
| | RQ Square | \$ 877.00 | \$ 894.00 | \$ 378.00 | \$ 1,819.00 |
| 26D Satin chrome | RP Round | \$ 815.00 | \$ 828.00 | \$ 340.00 | \$ 1,668.00 |
| | RQ Square | \$ 934.00 | \$ 947.00 | \$ 399.00 | \$ 1,819.00 |

Retail price

| Finish | Escutcheon | Function | | DMY R/L Single | DMY R/L Pair | ML-F Entry |
|------------------|----------------|-------------|-------------|----------------|--------------|-------------|
| | | PGE | PCY | | | |
| 26D Satin chrome | EP Oval | \$ 1,264.00 | \$ 1,289.00 | \$ 633.00 | \$ 1,200.00 | \$ 1,617.00 |
| | ER Rectangular | \$ 1,328.00 | \$ 1,340.00 | \$ 658.00 | \$ 1,251.00 | \$ 1,655.00 |

The options listed above are considered standard. Non-standard options are available upon request.

For more options on Rosettes and Escutcheon plates see page 23. For more options on Finishes see pages 12-13.

RE = Rectangular rosettes available for tubular latch application only. Add + \$ 30.00 LIST to the price of the RQ. For slim rosette and European version see pages 100-103.

Upcharges apply for the following special options:

- Extra thick door (> 2")
- Non-standard rosettes (rosettes not listed above)
- Non-standard finishes (finishes not listed above)
- Split finishes

See page 17 for pricing. Exclusions may apply.

Matching elements

- Pg 168 Mortise lock functions
- Pg 152 Deadbolts
- Pg 154 Privacy Bolts
- Pg 156 Escutcheons with deadbolts
- Pg 160 Multi-Point Trim functions

European window lever style available in the same design. Call for pricing.



H 380

Antonio Citterio

| | | |
|----------|------------|-------|
| Material | Collection | Group |
| Brass | Fusital | 8 |

Standard option (mm/inches)

RP Round rosette

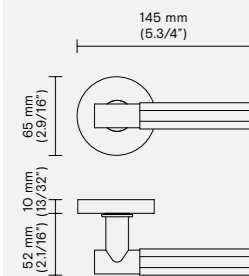

Standard option (mm/inches)

RQ Square rosette

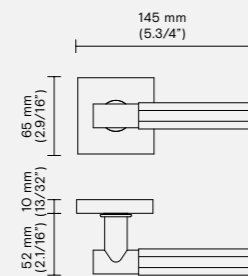

Escutcheon options (mm/inches)

EP Oval plate

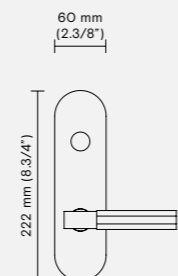

ER Rectangular plate

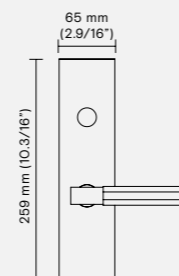

Conversions from metric to U.S. measurements are approximate.

Slim rosette available - See pages 102-103

Retail price

| Finish | Rosette | Function PGE | PCY | DMY R/L Single | ML-F Entry |
|--------------------|-----------|--------------|-----------|----------------|-------------|
| 14 Polished nickel | RP Round | \$ 724.00 | \$ 739.00 | \$ 304.00 | \$ 1,668.00 |
| | RQ Square | \$ 837.00 | \$ 852.00 | \$ 361.00 | \$ 1,819.00 |
| 26D Satin chrome | RP Round | \$ 724.00 | \$ 739.00 | \$ 304.00 | \$ 1,668.00 |
| | RQ Square | \$ 837.00 | \$ 852.00 | \$ 361.00 | \$ 1,819.00 |
| 56 Dark bronze | RP Round | \$ 724.00 | \$ 739.00 | \$ 304.00 | \$ 1,668.00 |
| | RQ Square | \$ 837.00 | \$ 852.00 | \$ 361.00 | \$ 1,819.00 |

Retail price

| Finish | Escutcheon | Function PGE | PCY | DMY R/L Single | DMY R/L Pair | ML-F Entry |
|------------------|----------------|--------------|-------------|----------------|--------------|-------------|
| 26D Satin chrome | EP Oval | \$ 1,264.00 | \$ 1,289.00 | \$ 633.00 | \$ 1,200.00 | \$ 1,617.00 |
| | ER Rectangular | \$ 1,328.00 | \$ 1,340.00 | \$ 658.00 | \$ 1,251.00 | \$ 1,655.00 |

The options listed above are considered standard. Non-standard options are available upon request.

For more options on Rosettes and Escutcheon plates see page 23. For more options on Finishes see pages 12-13.

RE = Rectangular rosettes available for tubular latch application only. Add + \$ 30.00 LIST to the price of the RQ. For slim rosette and European version see pages 100-103.

Upcharges apply for the following special options:

- Extra thick door (> 2")
- Non-standard rosettes (rosettes not listed above)
- Non-standard finishes (finishes not listed above)
- Split finishes

See page 17 for pricing. Exclusions may apply.

Matching elements

- Pg 168 Mortise lock functions
- Pg 152 Deadbolts
- Pg 154 Privacy Bolts
- Pg 156 Escutcheons with deadbolts
- Pg 160 Multi-Point Trim functions

European window lever style available in the same design. Call for pricing.



H 381

Khalid Al Najjar

| | | |
|----------|------------|-------|
| Material | Collection | Group |
| Brass | Fusital | 5 |

Standard option (mm/inches)

RP Round rosette

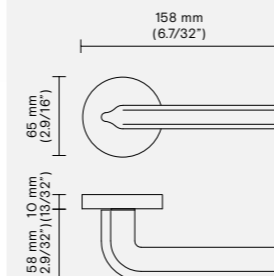

Standard option (mm/inches)

RQ Square rosette

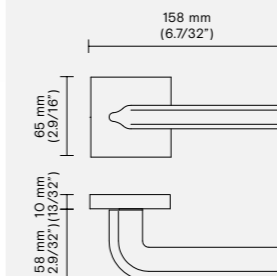

Escutcheon options (mm/inches)

EP Oval plate

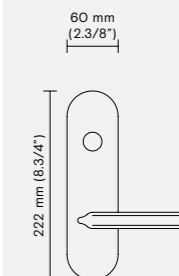

ER Rectangular plate

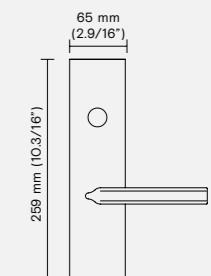

Conversions from metric to U.S. measurements are approximate.

Slim rosette available - See pages 102-103

Retail price

| Finish | Rosette | Function PGE | PCY | DMY R/L Single | ML-F Entry |
|---------------------------|-----------|--------------|-----------|----------------|-------------|
| 03M Matt brass | RP Round | \$ 441.00 | \$ 736.00 | \$ 211.00 | \$ 1,100.00 |
| | RQ Square | \$ 560.00 | \$ 855.00 | \$ 270.00 | \$ 1,238.00 |
| 15 Satin nickel | RP Round | \$ 539.00 | \$ 832.00 | \$ 264.00 | \$ 1,100.00 |
| | RQ Square | \$ 666.00 | \$ 951.00 | \$ 323.00 | \$ 1,238.00 |
| 17A Polished balck nickel | RP Round | \$ 539.00 | \$ 832.00 | \$ 264.00 | \$ 1,100.00 |
| | RQ Square | \$ 666.00 | \$ 951.00 | \$ 323.00 | \$ 1,238.00 |
| 26D Satin chrome | RP Round | \$ 539.00 | \$ 832.00 | \$ 264.00 | \$ 1,100.00 |
| | RQ Square | \$ 666.00 | \$ 951.00 | \$ 323.00 | \$ 1,238.00 |

It does not fit a privacy pin, supplied with 105 Privacy Bolt.

Retail price

| Finish | Escutcheon | Function PGE | PCY | DMY R/L Single | DMY R/L Pair | ML-F Entry |
|------------------|----------------|--------------|-----------|----------------|--------------|-------------|
| 26D Satin chrome | EP Oval | \$ 683.00 | \$ 696.00 | \$ 330.00 | \$ 607.00 | \$ 1,037.00 |
| | ER Rectangular | \$ 734.00 | \$ 747.00 | \$ 369.00 | \$ 671.00 | \$ 1,075.00 |

The options listed above are considered standard. Non-standard options are available upon request.

For more options on Rosettes and Escutcheon plates see page 23. For more options on Finishes see pages 12-13.

RE = Rectangular rosettes available for tubular latch application only. Add + \$ 30.00 LIST to the price of the RQ. For slim rosette and European version see pages 100-103.

Upcharges apply for the following special options:

- Extra thick door (> 2")
- Non-standard rosettes (rosettes not listed above)
- Non-standard finishes (finishes not listed above)
- Split finishes

See page 17 for pricing. Exclusions may apply.

Matching elements

- Pg 168 Mortise lock functions
- Pg 152 Deadbolts
- Pg 154 Privacy Bolts
- Pg 156 Escutcheons with deadbolts
- Pg 160 Multi-Point Trim functions

European window lever style available in the same design. Call for pricing.



H 382 Joe Cheng

| | | |
|----------|------------|-------|
| Material | Collection | Group |
| Brass | Fusital | 5 |

Standard option (mm/inches)

RP Round rosette

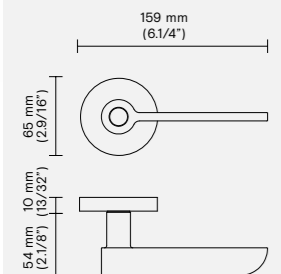

Standard option (mm/inches)

RQ Square rosette

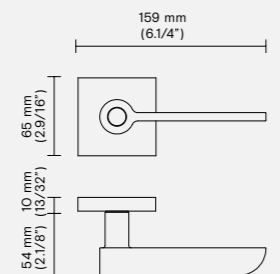

Escutcheon options (mm/inches)

EP Oval plate

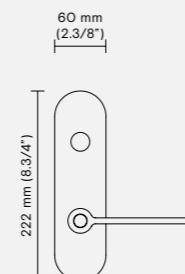

ER Rectangular plate

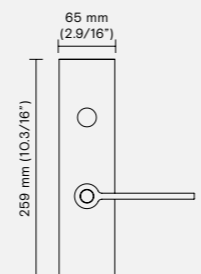

Conversions from metric to U.S. measurements are approximate.

Slim rosette available - See pages 102-103

Retail price

| Finish | Rosette | Function PGE | PCY | DMY R/L Single | ML-F Entry |
|--------------------|-----------|--------------|-----------|----------------|-------------|
| 06B Brunito | RP Round | \$ 441.00 | \$ 466.00 | \$ 211.00 | \$ 1,100.00 |
| | RQ Square | \$ 560.00 | \$ 585.00 | \$ 270.00 | \$ 1,238.00 |
| 14 Polished nickel | RP Round | \$ 539.00 | \$ 562.00 | \$ 264.00 | \$ 1,100.00 |
| | RQ Square | \$ 666.00 | \$ 681.00 | \$ 323.00 | \$ 1,238.00 |
| 26 Polished chrome | RP Round | \$ 539.00 | \$ 562.00 | \$ 264.00 | \$ 1,100.00 |
| | RQ Square | \$ 666.00 | \$ 681.00 | \$ 323.00 | \$ 1,238.00 |

Retail price

| Finish | Escutcheon | Function PGE | PCY | DMY R/L Single | DMY R/L Pair | ML-F Entry |
|--------------------|----------------|--------------|-----------|----------------|--------------|-------------|
| 26 Polished chrome | EP Oval | \$ 683.00 | \$ 696.00 | \$ 330.00 | \$ 607.00 | \$ 1,037.00 |
| | ER Rectangular | \$ 734.00 | \$ 747.00 | \$ 369.00 | \$ 671.00 | \$ 1,075.00 |

The options listed above are considered standard. Non-standard options are available upon request.

For more options on Rosettes and Escutcheon plates see page 23. For more options on Finishes see pages 12-13.

RE = Rectangular rosettes available for tubular latch application only. Add + \$ 30.00 LIST to the price of the RQ. For slim rosette and European version see pages 100-103.

Upcharges apply for the following special options:

- Extra thick door (> 2")
- Non-standard rosettes (rosettes not listed above)
- Non-standard finishes (finishes not listed above)
- Split finishes

See page 17 for pricing. Exclusions may apply.

Matching elements

- Pg 168 Mortise lock functions
- Pg 152 Deadbolts
- Pg 154 Privacy Bolts
- Pg 156 Escutcheons with deadbolts
- Pg 160 Multi-Point Trim functions

European window lever style available in the same design. Call for pricing.



H 383 Perkins&Will

| | | |
|----------|------------|-------|
| Material | Collection | Group |
| Brass | Fusital | 5 |

Standard option (mm/inches)

RP Round rosette

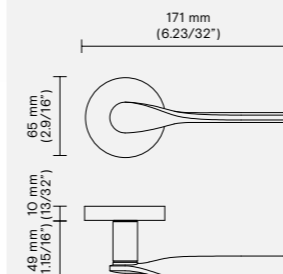

Standard option (mm/inches)

RQ Square rosette

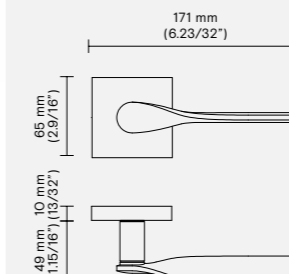

Escutcheon options (mm/inches)

EP Oval plate

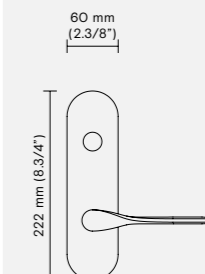

ER Rectangular plate

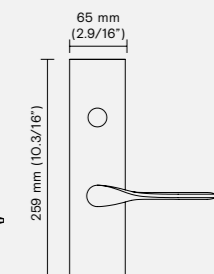

Conversions from metric to U.S. measurements are approximate.

Slim rosette available - See pages 102-103

Retail price

| Finish | Rosette | Function PGE | PCY | DMY R/L Single | ML-F Entry |
|------------------|-----------|--------------|-----------|----------------|-------------|
| 15 Satin nickel | RP Round | \$ 539.00 | \$ 562.00 | \$ 264.00 | \$ 1,100.00 |
| | RQ Square | \$ 666.00 | \$ 681.00 | \$ 323.00 | \$ 1,238.00 |
| 16 Dull black | RP Round | \$ 539.00 | \$ 562.00 | \$ 264.00 | \$ 1,100.00 |
| | RQ Square | \$ 666.00 | \$ 681.00 | \$ 323.00 | \$ 1,238.00 |
| 26D Satin chrome | RP Round | \$ 539.00 | \$ 562.00 | \$ 264.00 | \$ 1,100.00 |
| | RQ Square | \$ 666.00 | \$ 681.00 | \$ 323.00 | \$ 1,238.00 |
| 56 Dark bronze | RP Round | \$ 539.00 | \$ 562.00 | \$ 264.00 | \$ 1,100.00 |
| | RQ Square | \$ 666.00 | \$ 681.00 | \$ 323.00 | \$ 1,238.00 |

Retail price

| Finish | Escutcheon | Function PGE | PCY | DMY R/L Single | DMY R/L Pair | ML-F Entry |
|------------------|----------------|--------------|-----------|----------------|--------------|-------------|
| 26D Satin chrome | EP Oval | \$ 683.00 | \$ 696.00 | \$ 330.00 | \$ 607.00 | \$ 1,037.00 |
| | ER Rectangular | \$ 734.00 | \$ 747.00 | \$ 369.00 | \$ 671.00 | \$ 1,075.00 |

The options listed above are considered standard. Non-standard options are available upon request.

For more options on Rosettes and Escutcheon plates see page 23. For more options on Finishes see pages 12-13.

RE = Rectangular rosettes available for tubular latch application only. Add + \$ 30.00 LIST to the price of the RQ. For slim rosette and European version see pages 100-103.

Upcharges apply for the following special options:

- Extra thick door (> 2")
- Non-standard rosettes (rosettes not listed above)
- Non-standard finishes (finishes not listed above)
- Split finishes

See page 17 for pricing. Exclusions may apply.

Matching elements

- Pg 168 Mortise lock functions
- Pg 152 Deadbolts
- Pg 154 Privacy Bolts
- Pg 156 Escutcheons with deadbolts
- Pg 160 Multi-Point Trim functions

European window lever style available in the same design. Call for pricing.



H 384

CetraRuddy Architecture D.P.C.

| | | |
|----------|------------|-------|
| Material | Collection | Group |
| Brass | Fusital | 6 |

Standard option (mm/inches)

RP Round rosette

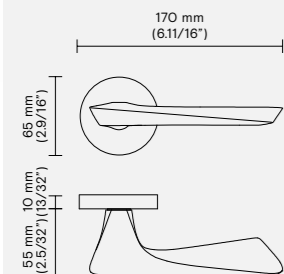

Standard option (mm/inches)

RQ Square rosette

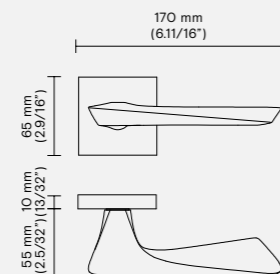

Escutcheon options (mm/inches)

EP Oval plate ER Rectangular plate

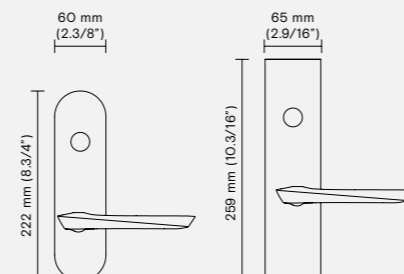

Conversions from metric to U.S. measurements are approximate.

Slim rosette available - See pages 102-103

Retail price

| Finish | Rosette | Function PGE | PCY | DMY R/L Single | ML-F Entry |
|---------------------------|-----------|--------------|-----------|----------------|-------------|
| 17A Polished black nickel | RP Round | \$ 631.00 | \$ 647.00 | \$ 308.00 | \$ 1,213.00 |
| | RQ Square | \$ 750.00 | \$ 755.00 | \$ 362.00 | \$ 1,389.00 |
| 26 Polished chrome | RP Round | \$ 562.00 | \$ 578.00 | \$ 269.00 | \$ 1,213.00 |
| | RQ Square | \$ 681.00 | \$ 697.00 | \$ 323.00 | \$ 1,389.00 |
| 26D Satin chrome | RP Round | \$ 610.00 | \$ 626.00 | \$ 292.00 | \$ 1,213.00 |
| | RQ Square | \$ 728.00 | \$ 745.00 | \$ 351.00 | \$ 1,389.00 |
| 56 Dark bronze | RP Round | \$ 610.00 | \$ 626.00 | \$ 292.00 | \$ 1,213.00 |
| | RQ Square | \$ 728.00 | \$ 745.00 | \$ 351.00 | \$ 1,389.00 |

Retail price

| Finish | Escutcheon | Function PGE | PCY | DMY R/L Single | DMY R/L Pair | ML-F Entry |
|--------------------|----------------|--------------|-----------|----------------|--------------|-------------|
| 26 Polished chrome | EP Oval | \$ 785.00 | \$ 796.00 | \$ 387.00 | \$ 724.00 | \$ 1,163.00 |
| | ER Rectangular | \$ 819.00 | \$ 833.00 | \$ 410.00 | \$ 772.00 | \$ 1,200.00 |
| 26D Satin chrome | EP Oval | \$ 785.00 | \$ 796.00 | \$ 387.00 | \$ 724.00 | \$ 1,163.00 |
| | ER Rectangular | \$ 819.00 | \$ 833.00 | \$ 410.00 | \$ 772.00 | \$ 1,200.00 |

The options listed above are considered standard. Non-standard options are available upon request.

For more options on Rosettes and Escutcheon plates see page 23. For more options on Finishes see pages 12-13.

RE = Rectangular rosettes available for tubular latch application only. Add + \$ 30.00 LIST to the price of the RQ. For slim rosette and European version see pages 100-103.

Upcharges apply for the following special options:

- Extra thick door (> 2")
- Non-standard rosettes (rosettes not listed above)
- Non-standard finishes (finishes not listed above)
- Split finishes

See page 17 for pricing. Exclusions may apply.

Matching elements

- Pg 168 Mortise lock functions
- Pg 152 Deadbolts
- Pg 154 Privacy Bolts
- Pg 156 Escutcheons with deadbolts
- Pg 160 Multi-Point Trim functions

European window lever style available in the same design. Call for pricing.



H 385

Federica Biasi

| | | |
|------------|------------|-------|
| Material | Collection | Group |
| Zinc alloy | Fusital | 5 |

Standard option (mm/inches)

RP Round rosette

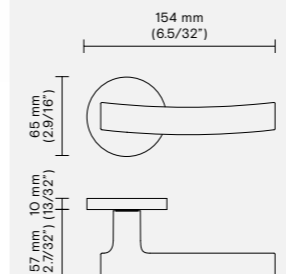

Standard option (mm/inches)

RQ Square rosette

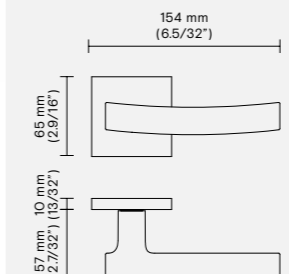

Escutcheon options (mm/inches)

EP Oval plate ER Rectangular plate

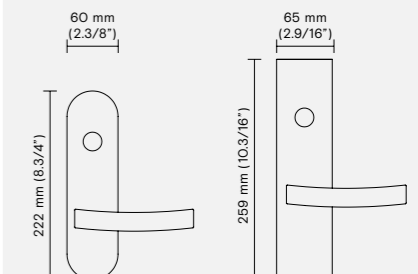

Conversions from metric to U.S. measurements are approximate.

Slim rosette available - See pages 102-103

Retail price

| Finish | Rosette | Function PGE | PCY | DMY R/L Single | ML-F Entry |
|--------------------|-----------|--------------|-----------|----------------|-------------|
| 15 Satin nickel | RP Round | \$ 378.00 | \$ 417.00 | \$ 184.00 | \$ 1,100.00 |
| | RQ Square | \$ 497.00 | \$ 536.00 | \$ 243.00 | \$ 1,238.00 |
| 16 Dull black | RP Round | \$ 357.00 | \$ 394.00 | \$ 173.00 | \$ 1,100.00 |
| | RQ Square | \$ 476.00 | \$ 512.00 | \$ 216.00 | \$ 1,238.00 |
| 26 Polished chrome | RP Round | \$ 378.00 | \$ 417.00 | \$ 184.00 | \$ 1,100.00 |
| | RQ Square | \$ 497.00 | \$ 536.00 | \$ 243.00 | \$ 1,238.00 |
| 26D Satin chrome | RP Round | \$ 378.00 | \$ 417.00 | \$ 184.00 | \$ 1,100.00 |
| | RQ Square | \$ 497.00 | \$ 536.00 | \$ 243.00 | \$ 1,238.00 |

Retail price

| Finish | Escutcheon | Function PGE | PCY | DMY R/L Single | DMY R/L Pair | ML-F Entry |
|--------------------|----------------|--------------|-----------|----------------|--------------|-------------|
| 26 Polished chrome | EP Oval | \$ 683.00 | \$ 696.00 | \$ 330.00 | \$ 607.00 | \$ 1,037.00 |
| | ER Rectangular | \$ 734.00 | \$ 747.00 | \$ 369.00 | \$ 671.00 | \$ 1,075.00 |
| 26D Satin chrome | EP Oval | \$ 683.00 | \$ 696.00 | \$ 330.00 | \$ 607.00 | \$ 1,037.00 |
| | ER Rectangular | \$ 734.00 | \$ 747.00 | \$ 369.00 | \$ 671.00 | \$ 1,075.00 |

The options listed above are considered standard. Non-standard options are available upon request.

For more options on Rosettes and Escutcheon plates see page 23. For more options on Finishes see pages 12-13.

RE = Rectangular rosettes available for tubular latch application only. Add + \$ 30.00 LIST to the price of the RQ. For slim rosette and European version see pages 100-103.

Upcharges apply for the following special options:

- Extra thick door (> 2")
- Non-standard rosettes (rosettes not listed above)
- Non-standard finishes (finishes not listed above)
- Split finishes

See page 17 for pricing. Exclusions may apply.

Matching elements

- Pg 168 Mortise lock functions
- Pg 152 Deadbolts
- Pg 154 Privacy Bolts
- Pg 156 Escutcheons with deadbolts
- Pg 160 Multi-Point Trim functions

European window lever style available in the same design. Call for pricing.



H 386

Meneghello Paolelli

NEW

Material: Zinc alloy
Collection: Fusital
Group: 5

Standard option (mm/inches)

RP Round rosette

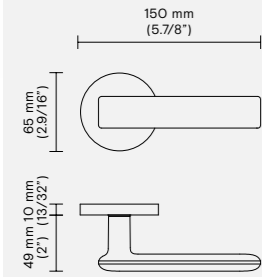

Standard option (mm/inches)

RQ Square rosette

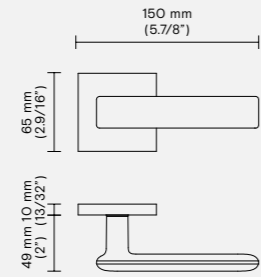

Escutcheon options (mm/inches)

EP Oval plate

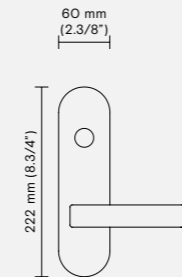

ER Rectangular plate

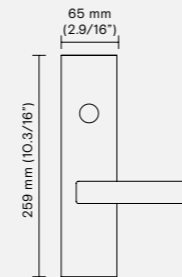

Conversions from metric to U.S. measurements are approximate.

Slim rosette available - See pages 102-103

Retail price

| Finish | Rosette | Function | | DMY R/L Single | ML-F Entry |
|---------------------------|-----------|-----------|-----------|----------------|-------------|
| | | PGE | PCY | | |
| 15 Satin nickel | RP Round | \$ 354.00 | \$ 370.00 | \$ 165.00 | \$ 1,100.00 |
| | RQ Square | \$ 479.00 | \$ 498.00 | \$ 243.00 | \$ 1,238.00 |
| 17A Polished black nickel | RP Round | \$ 360.00 | \$ 382.00 | \$ 170.00 | \$ 1,100.00 |
| | RQ Square | \$ 505.00 | \$ 518.00 | \$ 250.00 | \$ 1,238.00 |
| 26 Polished chrome | RP Round | \$ 327.00 | \$ 337.00 | \$ 148.00 | \$ 1,100.00 |
| | RQ Square | \$ 441.00 | \$ 458.00 | \$ 220.00 | \$ 1,238.00 |
| 26D Satin chrome | RP Round | \$ 332.00 | \$ 350.00 | \$ 155.00 | \$ 1,100.00 |
| | RQ Square | \$ 463.00 | \$ 480.00 | \$ 236.00 | \$ 1,238.00 |

Retail price

| Finish | Escutcheon | Function | | DMY R/L Single | DMY R/L Pair | ML-F Entry |
|--------------------|----------------|-----------|-----------|----------------|--------------|-------------|
| | | PGE | PCY | | | |
| 26 Polished chrome | EP Oval | \$ 683.00 | \$ 696.00 | \$ 330.00 | \$ 607.00 | \$ 1,037.00 |
| | ER Rectangular | \$ 734.00 | \$ 747.00 | \$ 369.00 | \$ 671.00 | \$ 1,075.00 |
| 26D Satin chrome | EP Oval | \$ 683.00 | \$ 696.00 | \$ 330.00 | \$ 607.00 | \$ 1,037.00 |
| | ER Rectangular | \$ 734.00 | \$ 747.00 | \$ 369.00 | \$ 671.00 | \$ 1,075.00 |

The options listed above are considered standard. Non-standard options are available upon request.

For more options on Rosettes and Escutcheon plates see page 23. For more options on Finishes see pages 12-13.

RE = Rectangular rosettes available for tubular latch application only. Add + \$ 30.00 LIST to the price of the RQ. For slim rosette and European version see pages 100-103.

Upcharges apply for the following special options:

- Extra thick door (> 2")
- Non-standard rosettes (rosettes not listed above)
- Non-standard finishes (finishes not listed above)
- Split finishes

See page 17 for pricing. Exclusions may apply.

Matching elements

- Pg 168 Mortise lock functions
- Pg 152 Deadbolts
- Pg 154 Privacy Bolts
- Pg 156 Escutcheons with deadbolts
- Pg 160 Multi-Point Trim functions

European window lever style available in the same design. Call for pricing.

PRESTO



H 411

Leila

Material: Brass
Collection: Lab
Group: 4

Standard option (mm/inches)

RP Round rosette

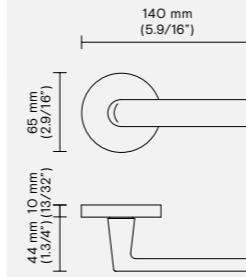

Standard option (mm/inches)

RQ Square rosette

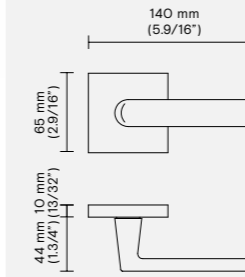

Escutcheon options (mm/inches)

EP Oval plate

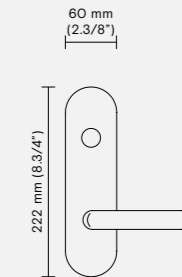

ER Rectangular plate

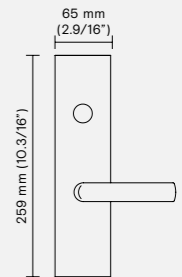

Conversions from metric to U.S. measurements are approximate.

Slim rosette available - See pages 102-103

Retail price

| Finish | Rosette | Function | | DMY R/L Single | ML-F Entry |
|--------------------|-----------|-----------|-----------|----------------|-------------|
| | | PGE | PCY | | |
| 16 Dull black | RP Round | \$ 223.00 | \$ 226.00 | \$ 113.00 | \$ 924.00 |
| | RQ Square | \$ 321.00 | \$ 323.00 | \$ 172.00 | \$ 1,062.00 |
| 26 Polished chrome | RP Round | \$ 223.00 | \$ 226.00 | \$ 113.00 | \$ 924.00 |
| | RQ Square | \$ 321.00 | \$ 323.00 | \$ 172.00 | \$ 1,062.00 |
| 26D Satin chrome | RP Round | \$ 223.00 | \$ 226.00 | \$ 113.00 | \$ 924.00 |
| | RQ Square | \$ 321.00 | \$ 323.00 | \$ 172.00 | \$ 1,062.00 |

Retail price

| Finish | Escutcheon | Function | | DMY R/L Single | DMY R/L Pair | ML-F Entry |
|--------------------|----------------|-----------|-----------|----------------|--------------|------------|
| | | PGE | PCY | | | |
| 26 Polished chrome | EP Oval | \$ 481.00 | \$ 494.00 | \$ 254.00 | \$ 430.00 | \$ 859.00 |
| | ER Rectangular | \$ 558.00 | \$ 570.00 | \$ 267.00 | \$ 481.00 | \$ 899.00 |
| 26D Satin chrome | EP Oval | \$ 481.00 | \$ 494.00 | \$ 254.00 | \$ 430.00 | \$ 859.00 |
| | ER Rectangular | \$ 558.00 | \$ 570.00 | \$ 267.00 | \$ 481.00 | \$ 899.00 |

The options listed above are considered standard. Non-standard options are available upon request.

For more options on Rosettes and Escutcheon plates see page 23. For more options on Finishes see pages 12-13.

RE = Rectangular rosettes available for tubular latch application only. Add + \$ 30.00 LIST to the price of the RQ.

Upcharges apply for the following special options:

- Extra thick door (> 2")
- Non-standard rosettes (rosettes not listed above)
- Non-standard finishes (finishes not listed above)
- Split finishes

See page 17 for pricing. Exclusions may apply.

Matching elements

- Pg 168 Mortise lock functions
- Pg 152 Deadbolts
- Pg 154 Privacy Bolts
- Pg 156 Escutcheons with deadbolts
- Pg 160 Multi-Point Trim functions

Window lever available in the same design. Call for pricing.



H 414 Amber

| | | |
|-----------------------------|------------|-------|
| Material | Collection | Group |
| Stainless steel AISI 304 | Lab | 4 |

Standard option (mm/inches)

RPS Round rosette

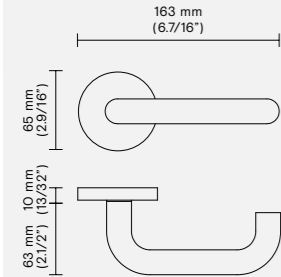

Standard option (mm/inches)

RQS Square rosette

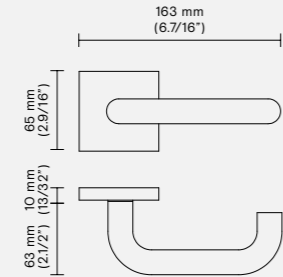

Escutcheon options (mm/inches)

EP Oval plate

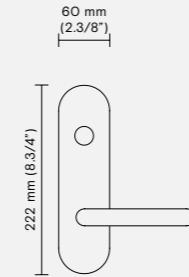

ER Rectangular plate

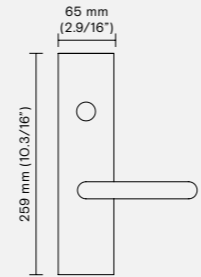

Conversions from metric to U.S. measurements are approximate.

Retail price

| Finish | Rosette | Function | | DMY R/L Single | ML-F Entry |
|---------------------------|------------|-----------|-----------|----------------|-------------|
| | | PGE | PCY | | |
| 32D Satin stainless steel | RPS Round | \$ 196.00 | \$ 214.00 | \$ 102.00 | \$ 1,176.00 |
| | RQS Square | \$ 304.00 | \$ 323.00 | \$ 161.00 | \$ 1,188.00 |

Retail price

| Finish | Escutcheon | Function | | DMY R/L Single | DMY R/L Pair | ML-F Entry |
|---------------------------|-----------------|-----------|-----------|----------------|--------------|------------|
| | | PGE | PCY | | | |
| 32D Satin stainless steel | EPS Oval | \$ 481.00 | \$ 494.00 | \$ 254.00 | \$ 430.00 | \$ 859.00 |
| | ERS Rectangular | \$ 558.00 | \$ 570.00 | \$ 267.00 | \$ 481.00 | \$ 899.00 |

The options listed above are considered standard. Non-standard options are available upon request.

For more options on Rosettes and Escutcheon plates see page 23. For more options on Finishes see pages 12-13.

RE = Rectangular rosettes available for tubular latch application only. Add + \$ 30.00 LIST to the price of the RQ

Upcharges apply for the following special options:

- Extra thick door (> 2")
- Non-standard rosettes (rosettes not listed above)
- Non-standard finishes (finishes not listed above)
- Split finishes

See page 17 for pricing. Exclusions may apply.

Matching elements

- Pg 168 Mortise lock functions
- Pg 152 Deadbolts
- Pg 154 Privacy Bolts
- Pg 156 Escutcheons with deadbolts
- Pg 160 Multi-Point Trim functions

Window lever available in the same design. Call for pricing.



H 415 Scarlet

| | | |
|-----------------------------|------------|-------|
| Material | Collection | Group |
| Stainless steel AISI 304 | Lab | 4 |

Standard option (mm/inches)

RPS Round rosette

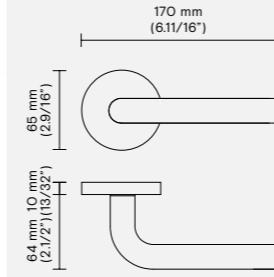

Standard option (mm/inches)

RQS Square rosette

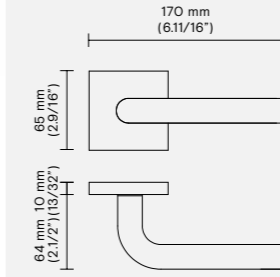

Escutcheon options (mm/inches)

EP Oval plate

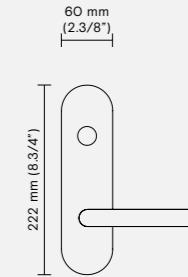

ER Rectangular plate

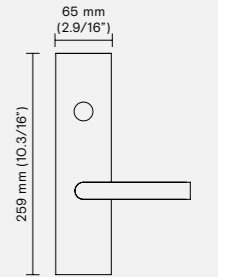

Conversions from metric to U.S. measurements are approximate.

Retail price

| Finish | Rosette | Function | | DMY R/L Single | ML-F Entry |
|---------------------------|------------|-----------|-----------|----------------|-------------|
| | | PGE | PCY | | |
| 32D Satin stainless steel | RPS Round | \$ 196.00 | \$ 214.00 | \$ 102.00 | \$ 1,176.00 |
| | RQS Square | \$ 304.00 | \$ 323.00 | \$ 161.00 | \$ 1,188.00 |

Retail price

| Finish | Escutcheon | Function | | DMY R/L Single | DMY R/L Pair | ML-F Entry |
|---------------------------|-----------------|-----------|-----------|----------------|--------------|------------|
| | | PGE | PCY | | | |
| 32D Satin stainless steel | EPS Oval | \$ 481.00 | \$ 494.00 | \$ 254.00 | \$ 430.00 | \$ 859.00 |
| | ERS Rectangular | \$ 558.00 | \$ 570.00 | \$ 267.00 | \$ 481.00 | \$ 899.00 |

The options listed above are considered standard. Non-standard options are available upon request.

For more options on Rosettes and Escutcheon plates see page 23. For more options on Finishes see pages 12-13.

RE = Rectangular rosettes available for tubular latch application only. Add + \$ 30.00 LIST to the price of the RQ

Upcharges apply for the following special options:

- Extra thick door (> 2")
- Non-standard rosettes (rosettes not listed above)
- Non-standard finishes (finishes not listed above)
- Split finishes

See page 17 for pricing. Exclusions may apply.

Matching elements

- Pg 168 Mortise lock functions
- Pg 152 Deadbolts
- Pg 154 Privacy Bolts
- Pg 156 Escutcheons with deadbolts
- Pg 160 Multi-Point Trim functions

Window lever available in the same design. Call for pricing.



H 416 Garnet

| | | |
|-----------------------------|------------|-------|
| Material | Collection | Group |
| Stainless steel AISI 304 | Lab | 4 |

Standard option (mm/inches)

RPS Round rosette

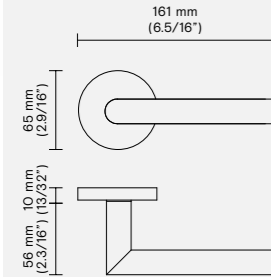

Standard option (mm/inches)

RQS Square rosette

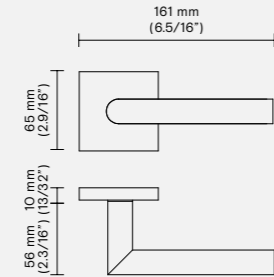

Escutcheon options (mm/inches)

EP Oval plate

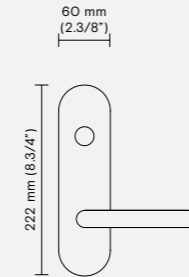

ER Rectangular plate

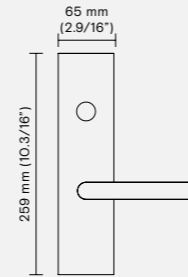

Conversions from metric to U.S. measurements are approximate.

Retail price

| Finish | Rosette | Function | | DMY R/L Single | ML-F Entry |
|---------------------------|------------|-----------|-----------|----------------|-------------|
| | | PGE | PCY | | |
| 32D Satin stainless steel | RPS Round | \$ 196.00 | \$ 214.00 | \$ 102.00 | \$ 1,176.00 |
| | RQS Square | \$ 304.00 | \$ 323.00 | \$ 161.00 | \$ 1,188.00 |

Retail price

| Finish | Escutcheon | Function | | DMY R/L Single | DMY R/L Pair | ML-F Entry |
|---------------------------|-----------------|-----------|-----------|----------------|--------------|------------|
| | | PGE | PCY | | | |
| 32D Satin stainless steel | EPS Oval | \$ 481.00 | \$ 494.00 | \$ 254.00 | \$ 430.00 | \$ 859.00 |
| | ERS Rectangular | \$ 583.00 | \$ 620.00 | \$ 293.00 | \$ 520.00 | \$ 999.00 |

The options listed above are considered standard. Non-standard options are available upon request.

For more options on Rosettes and Escutcheon plates see page 23. For more options on Finishes see pages 12-13.

RE = Rectangular rosettes available for tubular latch application only. Add + \$ 30.00 LIST to the price of the RQ

Upcharges apply for the following special options:

- Extra thick door (> 2")
- Non-standard rosettes (rosettes not listed above)
- Non-standard finishes (finishes not listed above)
- Split finishes

See page 17 for pricing. Exclusions may apply.

Matching elements

- Pg 168 Mortise lock functions
- Pg 152 Deadbolts
- Pg 154 Privacy Bolts
- Pg 156 Escutcheons with deadbolts
- Pg 160 Multi-Point Trim functions

Window lever available in the same design. Call for pricing.



H 419 Bordeaux

| | | |
|-----------------------------|------------|-------|
| Material | Collection | Group |
| Stainless steel AISI 304 | Lab | 4 |

Standard option (mm/inches)

RQS Square rosette

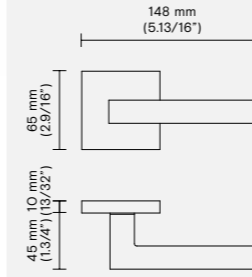

Standard option (mm/inches)

RPS Round rosette

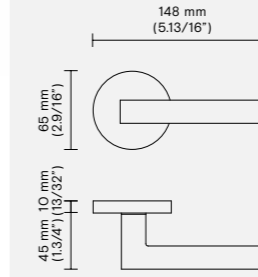

Escutcheon options (mm/inches)

EP Oval plate

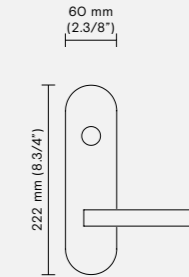

ER Rectangular plate

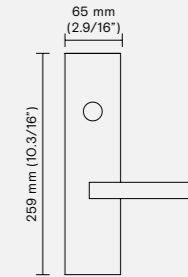

Conversions from metric to U.S. measurements are approximate.

Retail price

| Finish | Rosette | Function | | DMY R/L Single | ML-F Entry |
|---------------------------|------------|-----------|-----------|----------------|-------------|
| | | PGE | PCY | | |
| 32D Satin stainless steel | RPS Round | \$ 223.00 | \$ 226.00 | \$ 113.00 | \$ 1,176.00 |
| | RQS Square | \$ 304.00 | \$ 323.00 | \$ 175.00 | \$ 1,188.00 |

Retail price

| Finish | Escutcheon | Function | | DMY R/L Single | DMY R/L Pair | ML-F Entry |
|---------------------------|-----------------|-----------|-----------|----------------|--------------|------------|
| | | PGE | PCY | | | |
| 32D Satin stainless steel | EPS Oval | \$ 481.00 | \$ 494.00 | \$ 254.00 | \$ 430.00 | \$ 859.00 |
| | ERS Rectangular | \$ 583.00 | \$ 620.00 | \$ 293.00 | \$ 520.00 | \$ 999.00 |

The options listed above are considered standard. Non-standard options are available upon request.

For more options on Rosettes and Escutcheon plates see page 23. For more options on Finishes see pages 12-13.

RE = Rectangular rosettes available for tubular latch application only. Add + \$ 30.00 LIST to the price of the RQ

Upcharges apply for the following special options:

- Extra thick door (> 2")
- Non-standard rosettes (rosettes not listed above)
- Non-standard finishes (finishes not listed above)
- Split finishes

See page 17 for pricing. Exclusions may apply.

Matching elements

- Pg 168 Mortise lock functions
- Pg 152 Deadbolts
- Pg 154 Privacy Bolts
- Pg 156 Escutcheons with deadbolts
- Pg 160 Multi-Point Trim functions

Window lever available in the same design. Call for pricing.



H 1003 Matteo Thun

| | | |
|----------|------------|-------|
| Material | Collection | Group |
| Brass | Fusital | 1 |

Standard option (mm/inches)

RP Round rosette

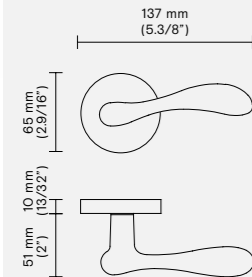

Standard option (mm/inches)

RQ Square rosette

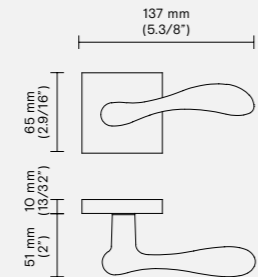

Escutcheon options (mm/inches)

EP Oval plate

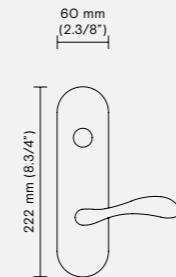

ER Rectangular plate

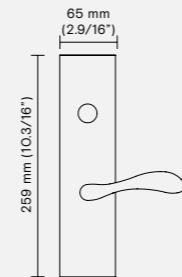

Conversions from metric to U.S. measurements are approximate.

Slim rosette available - See pages 102-103

Retail price

| Finish | Rosette | Function | | DMY R/L Single | ML-F Entry |
|--|-----------|-----------|-----------|----------------|-------------|
| | | PGE | PCY | | |
| 03 Polished brass | RP Round | \$ 310.00 | \$ 329.00 | \$ 143.00 | \$ 961.00 |
| | RQ Square | \$ 429.00 | \$ 448.00 | \$ 202.00 | \$ 1,100.00 |
| 14 Polished nickel | RP Round | \$ 342.00 | \$ 371.00 | \$ 161.00 | \$ 961.00 |
| | RQ Square | \$ 461.00 | \$ 490.00 | \$ 221.00 | \$ 1,100.00 |
| 15 Satin nickel | RP Round | \$ 332.00 | \$ 348.00 | \$ 152.00 | \$ 961.00 |
| | RQ Square | \$ 451.00 | \$ 467.00 | \$ 211.00 | \$ 1,100.00 |
| 26/26D Polished chrome / Satin chrome* | RP Round | \$ 328.00 | \$ 342.00 | \$ 151.00 | \$ 961.00 |
| | RQ Square | \$ 447.00 | \$ 461.00 | \$ 210.00 | \$ 1,100.00 |

Retail price

| Finish | Escutcheon | Function | | DMY R/L Single | DMY R/L Pair | ML-F Entry |
|--|----------------|-----------|-----------|----------------|--------------|------------|
| | | PGE | PCY | | | |
| 26/26D Polished chrome / Satin chrome* | EP Oval | \$ 520.00 | \$ 545.00 | \$ 254.00 | \$ 455.00 | \$ 899.00 |
| | ER Rectangular | \$ 570.00 | \$ 596.00 | \$ 279.00 | \$ 506.00 | \$ 935.00 |

* Note: The shank portion is polished while the length of the lever is satin. The rosette/escutcheon is polished.

The options listed above are considered standard. Non-standard options are available upon request.

For more options on Rosettes and Escutcheon plates see page 23. For more options on Finishes see pages 12-13.

RE = Rectangular rosettes available for tubular latch application only. Add + \$ 30.00 LIST to the price of the RQ. For slim rosette and European version see pages 100-103.

Upcharges apply for the following special options:

- Extra thick door (> 2")
- Non-standard rosettes (rosettes not listed above)
- Non-standard finishes (finishes not listed above)
- Split finishes

See page 17 for pricing. Exclusions may apply.

Matching elements

- Pg 168 Mortise lock functions
- Pg 152 Deadbolts
- Pg 154 Privacy Bolts
- Pg 156 Escutcheons with deadbolts
- Pg 160 Multi-Point Trim functions

European window lever style available in the same design. Call for pricing.



H 1004 Antares

| | | |
|----------|------------|-------|
| Material | Collection | Group |
| Brass | Lab | 4 |

Standard option (mm/inches)

RT Traditional rosette

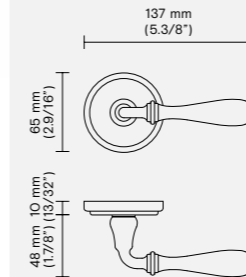

Standard option (mm/inches)

RQ Square rosette

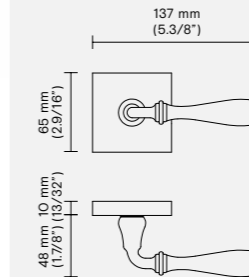

Escutcheon options (mm/inches)*

EP Oval plate

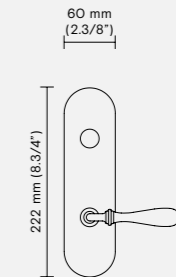

ER Rectangular plate

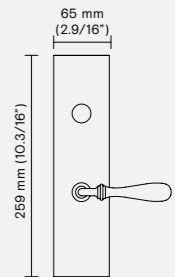

Conversions from metric to U.S. measurements are approximate.

*Only available on request

Retail price

| Finish | Rosette | Function | | DMY R/L Single | ML-F Entry |
|-----------------|----------------|-----------|-----------|----------------|-------------|
| | | PGE | PCY | | |
| 03D Satin brass | RT Traditional | \$ 223.00 | \$ 226.00 | \$ 113.00 | \$ 924.00 |
| | RQ Square | \$ 321.00 | \$ 323.00 | \$ 172.00 | \$ 1,062.00 |
| 06B Brunito | RT Traditional | \$ 223.00 | \$ 226.00 | \$ 113.00 | \$ 924.00 |
| | RQ Square | \$ 321.00 | \$ 323.00 | \$ 172.00 | \$ 1,062.00 |

Note: This lever is also available with RP Round Rosette. Same price as RT Traditional Rosette.

The options listed above are considered standard. Non-standard options are available upon request.

For more options on Rosettes and Escutcheon plates see page 23. For more options on Finishes see pages 12-13.

RE = Rectangular rosettes available for tubular latch application only. Add + \$ 30.00 LIST to the price of the RQ.

Upcharges apply for the following special options:

- Extra thick door (> 2")
- Non-standard rosettes (rosettes not listed above)
- Non-standard finishes (finishes not listed above)
- Split finishes

See page 17 for pricing. Exclusions may apply.

Matching elements

- Pg 168 Mortise lock functions
- Pg 152 Deadbolts
- Pg 154 Privacy Bolts
- Pg 156 Escutcheons with deadbolts
- Pg 160 Multi-Point Trim functions

Window lever available in the same design. Call for pricing.



H 1016 Nabucco

| | | |
|----------|------------|-------|
| Material | Collection | Group |
| Brass | Lab | 2 |

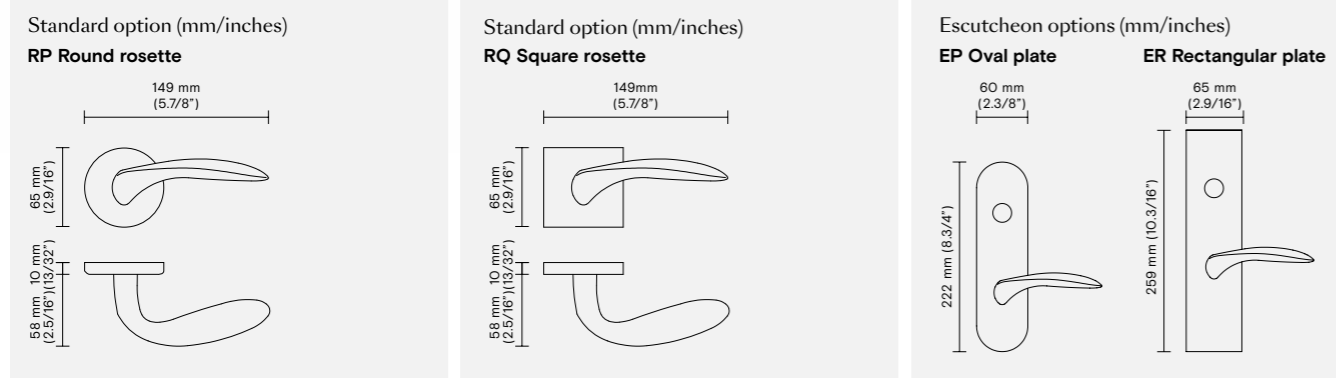

Conversions from metric to U.S. measurements are approximate.

Retail price

| Finish | Rosette | Function PGE | PCY | DMY R/L Single | ML-F Entry |
|--------------------|-----------|--------------|-----------|----------------|-------------|
| 15 Satin nickel | RP Round | \$ 396.00 | \$ 426.00 | \$ 191.00 | \$ 1,037.00 |
| | RQ Square | \$ 515.00 | \$ 545.00 | \$ 250.00 | \$ 1,176.00 |
| 26 Polished chrome | RP Round | \$ 360.00 | \$ 391.00 | \$ 172.00 | \$ 1,037.00 |
| | RQ Square | \$ 479.00 | \$ 510.00 | \$ 232.00 | \$ 1,176.00 |

Retail price

| Finish | Escutcheon | Function PGE | PCY | DMY R/L Single | DMY R/L Pair | ML-F Entry |
|--------------------|----------------|--------------|-----------|----------------|--------------|-------------|
| 26 Polished chrome | EP Oval | \$ 596.00 | \$ 633.00 | \$ 293.00 | \$ 549.00 | \$ 974.00 |
| | ER Rectangular | \$ 645.00 | \$ 658.00 | \$ 318.00 | \$ 583.00 | \$ 1,010.00 |

The options listed above are considered standard. Non-standard options are available upon request.

For more options on Rosettes and Escutcheon plates see page 23. For more options on Finishes see pages 12-13.

RE = Rectangular rosettes available for tubular latch application only. Add + \$ 30.00 LIST to the price of the RQ. For slim rosette and European version see pages 100-103.

Upcharges apply for the following special options:

- Extra thick door (> 2")
- Non-standard rosettes (rosettes not listed above)
- Non-standard finishes (finishes not listed above)
- Split finishes

See page 17 for pricing. Exclusions may apply.

Matching elements

- Pg 168 Mortise lock functions
- Pg 152 Deadbolts
- Pg 154 Privacy Bolts
- Pg 156 Escutcheons with deadbolts
- Pg 160 Multi-Point Trim functions

European window lever style available in the same design. Call for pricing.



H 1022 Ernani

| | | |
|----------|------------|-------|
| Material | Collection | Group |
| Brass | Lab | 1 |

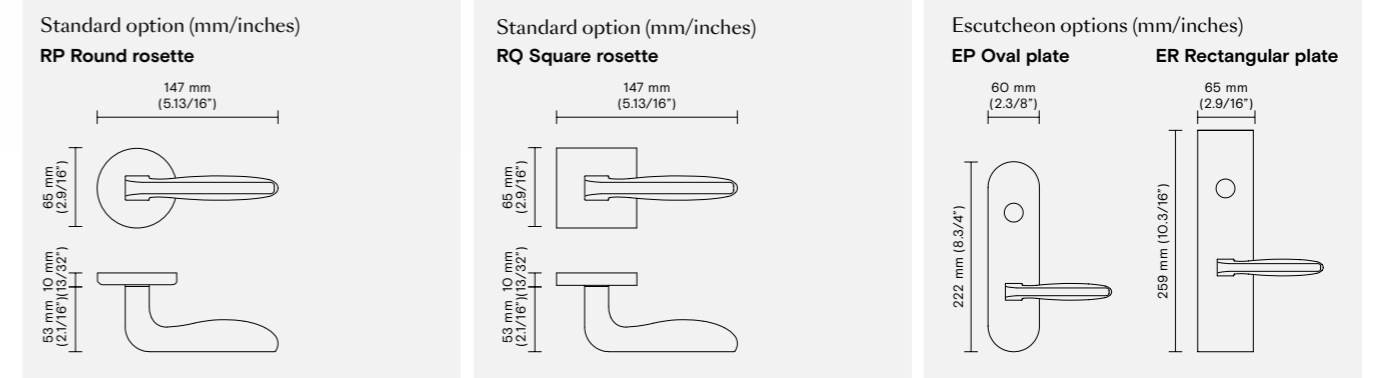

Slim rosette available - See pages 102-103

Conversions from metric to U.S. measurements are approximate.

Retail price

| Finish | Rosette | Function PGE | PCY | DMY R/L Single | ML-F Entry |
|--|-----------|--------------|-----------|----------------|-------------|
| 03/03D Polished brass / Satin brass* | RP Round | \$ 388.00 | \$ 412.00 | \$ 185.00 | \$ 961.00 |
| | RQ Square | \$ 507.00 | \$ 531.00 | \$ 245.00 | \$ 1,100.00 |
| 26D/26 Satin chrome / Polished chrome* | RP Round | \$ 376.00 | \$ 393.00 | \$ 177.00 | \$ 961.00 |
| | RQ Square | \$ 495.00 | \$ 511.00 | \$ 236.00 | \$ 1,100.00 |

Retail price

| Finish | Escutcheon | Function PGE | PCY | DMY R/L Single | DMY R/L Pair | ML-F Entry |
|--|----------------|--------------|-----------|----------------|--------------|------------|
| 26D/26 Satin chrome / Polished chrome* | EP Oval | \$ 520.00 | \$ 545.00 | \$ 254.00 | \$ 455.00 | \$ 899.00 |
| | ER Rectangular | \$ 570.00 | \$ 596.00 | \$ 279.00 | \$ 506.00 | \$ 935.00 |

* In the 03/03D version, the front and side edge of the lever are satin, while the rest of the lever is polished. The rosette/escutcheon is polished. In the 26/26D version, the front and side edge of the lever are polished, while the rest of the lever is satin. The rosette/escutcheon is satin.

The options listed above are considered standard. Non-standard options are available upon request.

For more options on Rosettes and Escutcheon plates see page 23. For more options on Finishes see pages 12-13.

RE = Rectangular rosettes available for tubular latch application only. Add + \$ 30.00 LIST to the price of the RQ. For slim rosette and European version see pages 100-103.

Upcharges apply for the following special options:

- Extra thick door (> 2")
- Non-standard rosettes (rosettes not listed above)
- Non-standard finishes (finishes not listed above)
- Split finishes

See page 17 for pricing. Exclusions may apply.

Matching elements

- Pg 168 Mortise lock functions
- Pg 152 Deadbolts
- Pg 154 Privacy Bolts
- Pg 156 Escutcheons with deadbolts
- Pg 160 Multi-Point Trim functions

European window lever style available in the same design. Call for pricing.



H 1024 Lolita

| | | |
|----------|------------|-------|
| Material | Collection | Group |
| Brass | Lab | 1 |

Standard option (mm/inches)

RP Round rosette

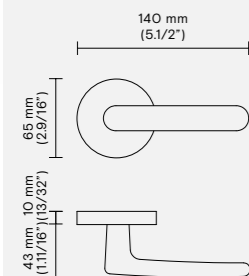

Standard option (mm/inches)

RQ Square rosette

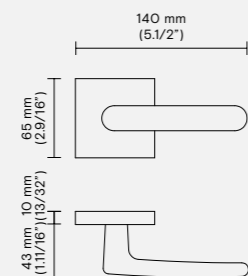

Escutcheon options (mm/inches)

EP Oval plate

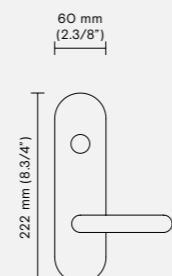

ER Rectangular plate

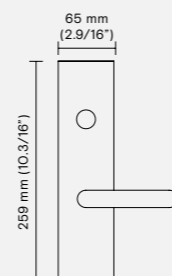

Conversions from metric to U.S. measurements are approximate.

Slim rosette available - See pages 102-103

Retail price

| Finish | Rosette | Function PGE | PCY | DMY R/L Single | ML-F Entry |
|--------------------|-----------|--------------|-----------|----------------|-------------|
| 03 Polished brass | RP Round | \$ 282.00 | \$ 310.00 | \$ 130.00 | \$ 961.00 |
| | RQ Square | \$ 401.00 | \$ 429.00 | \$ 189.00 | \$ 1,100.00 |
| 26 Polished chrome | RP Round | \$ 276.00 | \$ 292.00 | \$ 125.00 | \$ 961.00 |
| | RQ Square | \$ 395.00 | \$ 411.00 | \$ 184.00 | \$ 1,100.00 |
| 26D Satin chrome | RP Round | \$ 290.00 | \$ 308.00 | \$ 134.00 | \$ 961.00 |
| | RQ Square | \$ 409.00 | \$ 427.00 | \$ 194.00 | \$ 1,100.00 |

Retail price

| Finish | Escutcheon | Function PGE | PCY | DMY R/L Single | DMY R/L Pair | ML-F Entry |
|--------------------|----------------|--------------|-----------|----------------|--------------|------------|
| 26 Polished chrome | EP Oval | \$ 520.00 | \$ 545.00 | \$ 254.00 | \$ 455.00 | \$ 899.00 |
| | ER Rectangular | \$ 570.00 | \$ 596.00 | \$ 279.00 | \$ 506.00 | \$ 935.00 |
| 26D Satin chrome | EP Oval | \$ 520.00 | \$ 545.00 | \$ 254.00 | \$ 455.00 | \$ 899.00 |
| | ER Rectangular | \$ 570.00 | \$ 596.00 | \$ 279.00 | \$ 506.00 | \$ 935.00 |

The options listed above are considered standard. Non-standard options are available upon request.

For more options on Rosettes and Escutcheon plates see page 23. For more options on Finishes see pages 12-13.

RE = Rectangular rosettes available for tubular latch application only. Add + \$ 30.00 LIST to the price of the RQ. For slim rosette and European version see pages 100-103.

Upcharges apply for the following special options:

- Extra thick door (> 2")
- Non-standard rosettes (rosettes not listed above)
- Non-standard finishes (finishes not listed above)
- Split finishes

See page 17 for pricing. Exclusions may apply.

Matching elements

- Pg 168 Mortise lock functions
- Pg 152 Deadbolts
- Pg 154 Privacy Bolts
- Pg 156 Escutcheons with deadbolts
- Pg 160 Multi-Point Trim functions

European window lever style available in the same design. Call for pricing.



H 1026 Antonio Bullo

| | | |
|----------|------------|-------|
| Material | Collection | Group |
| Brass | Fusital | 2 |

Standard option (mm/inches)

RP Round rosette

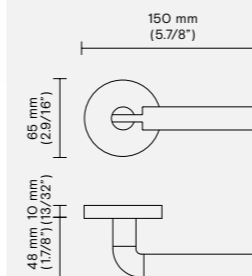

Standard option (mm/inches)

RQ Square rosette

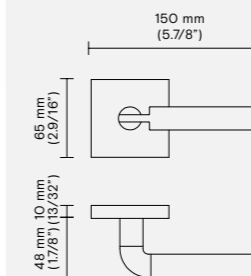

Escutcheon options (mm/inches)

EP Oval plate

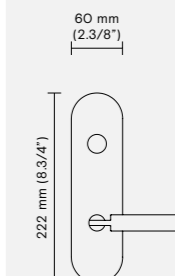

ER Rectangular plate

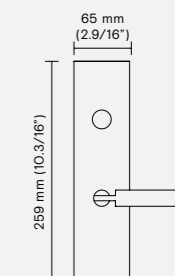

Conversions from metric to U.S. measurements are approximate.

Slim rosette available - See pages 102-103

Retail price

| Finish | Rosette | Function PGE | PCY | DMY R/L Single | ML-F Entry |
|--|-----------|--------------|-----------|----------------|-------------|
| 03/03D Polished brass / Satin brass* | RP Round | \$ 374.00 | \$ 413.00 | \$ 183.00 | \$ 1,037.00 |
| | RQ Square | \$ 493.00 | \$ 532.00 | \$ 243.00 | \$ 1,176.00 |
| 26/26D Polished chrome / Satin chrome* | RP Round | \$ 381.00 | \$ 415.00 | \$ 183.00 | \$ 1,037.00 |
| | RQ Square | \$ 499.00 | \$ 555.00 | \$ 243.00 | \$ 1,176.00 |

Retail price

| Finish | Escutcheon | Function PGE | PCY | DMY R/L Single | DMY R/L Pair | ML-F Entry |
|--|----------------|--------------|-----------|----------------|--------------|-------------|
| 26/26D Polished chrome / Satin chrome* | EP Oval | \$ 596.00 | \$ 633.00 | \$ 293.00 | \$ 549.00 | \$ 974.00 |
| | ER Rectangular | \$ 645.00 | \$ 658.00 | \$ 318.00 | \$ 583.00 | \$ 1,010.00 |

* Note: The curved shank portion is polished, while the base and the length of the grip are satin. The rosette/escutcheon is satin.

The options listed above are considered standard. Non-standard options are available upon request.

For more options on Rosettes and Escutcheon plates see page 23. For more options on Finishes see pages 12-13.

RE = Rectangular rosettes available for tubular latch application only. Add + \$ 30.00 LIST to the price of the RQ. For slim rosette and European version see pages 100-103.

Upcharges apply for the following special options:

- Extra thick door (> 2")
- Non-standard rosettes (rosettes not listed above)
- Non-standard finishes (finishes not listed above)
- Split finishes

See page 17 for pricing. Exclusions may apply.

Matching elements

- Pg 168 Mortise lock functions
- Pg 152 Deadbolts
- Pg 154 Privacy Bolts
- Pg 156 Escutcheons with deadbolts
- Pg 160 Multi-Point Trim functions

European window lever style available in the same design. Call for pricing.



H 1027 Dafne

| | | |
|----------|------------|-------|
| Material | Collection | Group |
| Brass | Lab | 2 |

Standard option (mm/inches)

RP Round rosette

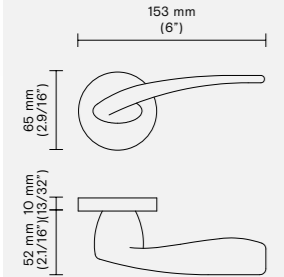

Standard option (mm/inches)

RQ Square rosette

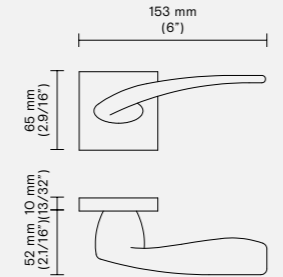

Escutcheon options (mm/inches)

EP Oval plate ER Rectangular plate

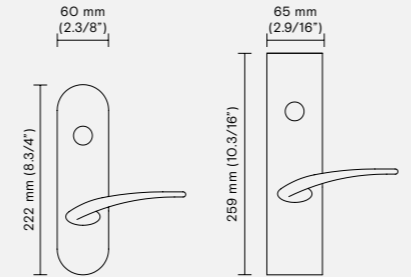

Conversions from metric to U.S. measurements are approximate.

Retail price

| Finish | Rosette | Function PGE | PCY* | DMY R/L Single | ML-F Entry |
|-------------------|-----------|--------------|-----------|----------------|-------------|
| 03 Polished brass | RP Round | \$ 369.00 | \$ 674.00 | \$ 172.00 | \$ 1,037.00 |
| | RQ Square | \$ 488.00 | \$ 793.00 | \$ 232.00 | \$ 1,176.00 |
| 26D Satin chrome | RP Round | \$ 377.00 | \$ 728.00 | \$ 175.00 | \$ 1,037.00 |
| | RQ Square | \$ 496.00 | \$ 847.00 | \$ 235.00 | \$ 1,176.00 |

* If it does not fit a privacy pin, supplied with 105 privacy bolt.

Retail price

| Finish | Escutcheon | Function PGE | PCY | DMY R/L Single | DMY R/L Pair | ML-F Entry |
|------------------|----------------|--------------|-----------|----------------|--------------|-------------|
| 26D Satin chrome | EP Oval | \$ 596.00 | \$ 633.00 | \$ 293.00 | \$ 549.00 | \$ 974.00 |
| | ER Rectangular | \$ 645.00 | \$ 658.00 | \$ 318.00 | \$ 583.00 | \$ 1,010.00 |

The options listed above are considered standard. Non-standard options are available upon request.

For more options on Rosettes and Escutcheon plates see page 23. For more options on Finishes see pages 12-13.

RE = Rectangular rosettes available for tubular latch application only. Add + \$ 30.00 LIST to the price of the RQ. For slim rosette and European version see pages 100-103.

Upcharges apply for the following special options:

- Extra thick door (> 2")
- Non-standard rosettes (rosettes not listed above)
- Non-standard finishes (finishes not listed above)
- Split finishes

See page 17 for pricing. Exclusions may apply.

Matching elements

- Pg 168 Mortise lock functions
- Pg 152 Deadbolts
- Pg 154 Privacy Bolts
- Pg 156 Escutcheons with deadbolts
- Pg 160 Multi-Point Trim functions

European window lever style available in the same design. Call for pricing.

H 1037 Teseo

| | | |
|----------|------------|-------|
| Material | Collection | Group |
| Brass | Lab | 4 |



Standard option (mm/inches)

RT Traditional rosette

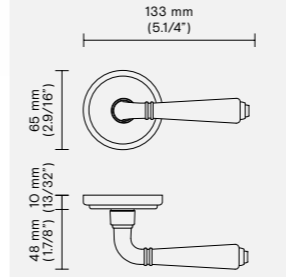

Standard option (mm/inches)

RQ Square rosette

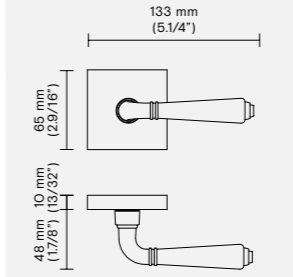

Escutcheon options (mm/inches)*

EP Oval plate ER Rectangular plate

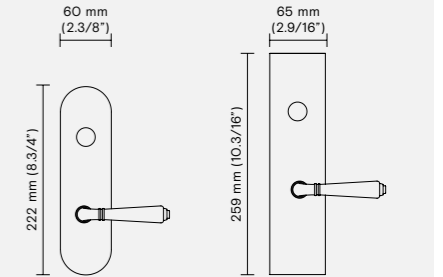

Conversions from metric to U.S. measurements are approximate.

*Only available on request

Retail price

| Finish | Rosette | Function PGE | PCY | DMY R/L Single | ML-F Entry |
|--------------------|----------------|--------------|-----------|----------------|-------------|
| 03 Polished brass | RT Traditional | \$ 223.00 | \$ 226.00 | \$ 113.00 | \$ 924.00 |
| | RQ Square | \$ 321.00 | \$ 323.00 | \$ 172.00 | \$ 1,062.00 |
| 14 Polished nickel | RT Traditional | \$ 223.00 | \$ 226.00 | \$ 113.00 | \$ 924.00 |
| | RQ Square | \$ 321.00 | \$ 323.00 | \$ 172.00 | \$ 1,062.00 |
| 15 Satin nickel | RT Traditional | \$ 223.00 | \$ 226.00 | \$ 113.00 | \$ 924.00 |
| | RQ Square | \$ 321.00 | \$ 323.00 | \$ 172.00 | \$ 1,062.00 |

Note: This lever is also available with RP Round Rosette. Same price as RT Traditional Rosette.

The options listed above are considered standard. Non-standard options are available upon request.

For more options on Rosettes and Escutcheon plates see page 23. For more options on Finishes see pages 12-13.

RE = Rectangular rosettes available for tubular latch application only. Add + \$ 30.00 LIST to the price of the RQ.

Upcharges apply for the following special options:

- Extra thick door (> 2")
- Non-standard rosettes (rosettes not listed above)
- Non-standard finishes (finishes not listed above)
- Split finishes

See page 17 for pricing. Exclusions may apply.

Matching elements

- Pg 168 Mortise lock functions
- Pg 152 Deadbolts
- Pg 154 Privacy Bolts
- Pg 156 Escutcheons with deadbolts
- Pg 160 Multi-Point Trim functions

Window lever available in the same design. Call for pricing.



H 1039

Jean-Baptiste Sibertin Blanc

| | | |
|----------|------------|-------|
| Material | Collection | Group |
| Brass | Fusital | 3 |

Standard option (mm/inches)

RP Round rosette

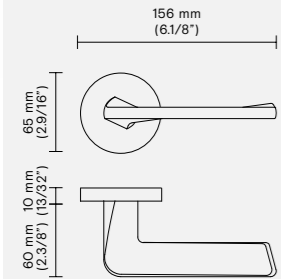

Standard option (mm/inches)

RQ Square rosette

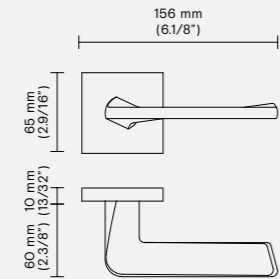

Escutcheon options (mm/inches)

EP Oval plate

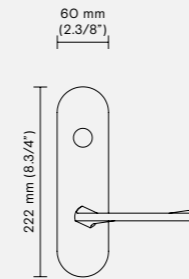

ER Rectangular plate

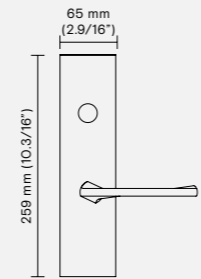

Conversions from metric to U.S. measurements are approximate.

Slim rosette available - See pages 102-103

Retail price

| Finish | Rosette | Function | | DMY R/L Single | ML-F Entry |
|--|-----------|-----------|-----------|----------------|-------------|
| | | PGE | PCY | | |
| 14 Polished nickel | RP Round | \$ 378.00 | \$ 417.00 | \$ 184.00 | \$ 1,251.00 |
| | RQ Square | \$ 497.00 | \$ 536.00 | \$ 243.00 | \$ 1,389.00 |
| 15 Satin nickel | RP Round | \$ 378.00 | \$ 417.00 | \$ 184.00 | \$ 1,251.00 |
| | RQ Square | \$ 497.00 | \$ 536.00 | \$ 243.00 | \$ 1,389.00 |
| 26/26D Polished chrome / Satin chrome* | RP Round | \$ 336.00 | \$ 372.00 | \$ 162.00 | \$ 1,251.00 |
| | RQ Square | \$ 455.00 | \$ 491.00 | \$ 222.00 | \$ 1,389.00 |

Retail price

| Finish | Escutcheon | Function | | DMY R/L Single | DMY R/L Pair | ML-F Entry |
|--|----------------|-----------|-----------|----------------|--------------|-------------|
| | | PGE | PCY | | | |
| 26/26D Polished chrome / Satin chrome* | EP Oval | \$ 809.00 | \$ 823.00 | \$ 405.00 | \$ 747.00 | \$ 1,200.00 |
| | ER Rectangular | \$ 859.00 | \$ 873.00 | \$ 430.00 | \$ 798.00 | \$ 1,226.00 |

* Note: The front and side edges are polished, while the top and bottom surfaces are satin. The rosette/escutcheon is satin.

The options listed above are considered standard. Non-standard options are available upon request.

For more options on Rosettes and Escutcheon plates see page 23. For more options on Finishes see pages 12-13.

RE = Rectangular rosettes available for tubular latch application only. Add + \$ 30.00 LIST to the price of the RQ. For slim rosette and European version see pages 100-103.

Upcharges apply for the following special options:

- Extra thick door (> 2")
- Non-standard rosettes (rosettes not listed above)
- Non-standard finishes (finishes not listed above)
- Split finishes

See page 17 for pricing. Exclusions may apply.

Matching elements

- Pg 168 Mortise lock functions
- Pg 152 Deadbolts
- Pg 154 Privacy Bolts
- Pg 156 Escutcheons with deadbolts
- Pg 160 Multi-Point Trim functions

European window lever style available in the same design. Call for pricing.

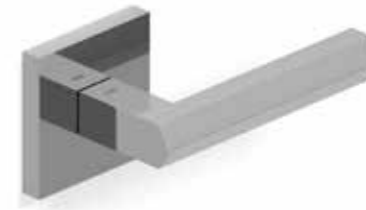

H 1040

Gabriele e Oscar Buratti

| | | |
|----------|------------|-------|
| Material | Collection | Group |
| Brass | Fusital | 3 |

Standard option (mm/inches)

RQ Square rosette

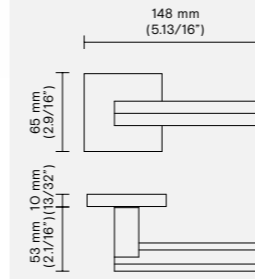

Standard option (mm/inches)

RP Round rosette

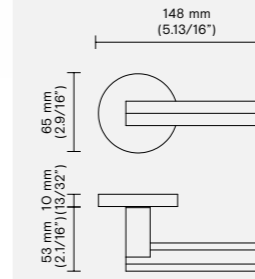

Escutcheon options (mm/inches)

EP Oval plate

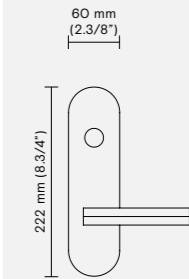

ER Rectangular plate

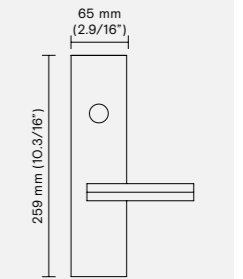

Conversions from metric to U.S. measurements are approximate.

Slim rosette available - See pages 102-103

Retail price

| Finish | Rosette | Function | | DMY R/L Single | ML-F Entry |
|--------------------|-----------|-----------|-----------|----------------|-------------|
| | | PGE | PCY | | |
| 15 Satin nickel | RP Round | \$ 672.00 | \$ 697.00 | \$ 336.00 | \$ 1,251.00 |
| | RQ Square | \$ 792.00 | \$ 828.00 | \$ 407.00 | \$ 1,389.00 |
| 26 Polished chrome | RP Round | \$ 672.00 | \$ 697.00 | \$ 336.00 | \$ 1,251.00 |
| | RQ Square | \$ 792.00 | \$ 828.00 | \$ 407.00 | \$ 1,389.00 |

Retail price

| Finish | Escutcheon | Function | | DMY R/L Single | DMY R/L Pair | ML-F Entry |
|--------------------|----------------|-----------|-----------|----------------|--------------|-------------|
| | | PGE | PCY | | | |
| 26 Polished chrome | EP Oval | \$ 809.00 | \$ 823.00 | \$ 405.00 | \$ 747.00 | \$ 1,200.00 |
| | ER Rectangular | \$ 859.00 | \$ 873.00 | \$ 430.00 | \$ 798.00 | \$ 1,226.00 |

Note: The lever grip has an octagonal shape.

The options listed above are considered standard. Non-standard options are available upon request.

For more options on Rosettes and Escutcheon plates see page 23. For more options on Finishes see pages 12-13.

RE = Rectangular rosettes available for tubular latch application only. Add + \$ 30.00 LIST to the price of the RQ. For slim rosette and European version see pages 100-103.

Upcharges apply for the following special options:

- Extra thick door (> 2")
- Non-standard rosettes (rosettes not listed above)
- Non-standard finishes (finishes not listed above)
- Split finishes

See page 17 for pricing. Exclusions may apply.

Matching elements

- Pg 168 Mortise lock functions
- Pg 152 Deadbolts
- Pg 154 Privacy Bolts
- Pg 156 Escutcheons with deadbolts
- Pg 160 Multi-Point Trim functions

European window lever style available in the same design. Call for pricing.

H 1043

Matteo Thun

| | | |
|------------|------------|-------|
| Material | Collection | Group |
| Zinc alloy | Fusital | 4 |



Standard option (mm/inches)

RP Round rosette

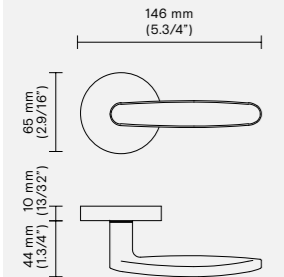

Standard option (mm/inches)

RQ Square rosette

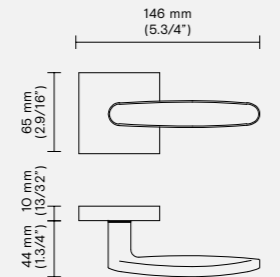

Escutcheon options (mm/inches)

EP Oval plate

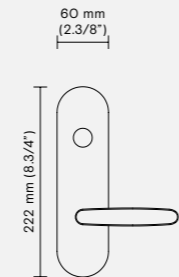

ER Rectangular plate

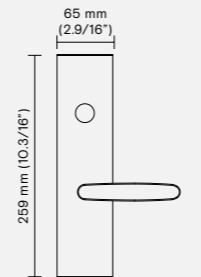

Conversions from metric to U.S. measurements are approximate.

Slim rosette available - See pages 102-103

Retail price

| Finish | Rosette | Function | | DMY R/L Single | ML-F Entry |
|--|-----------|-----------|-----------|----------------|-------------|
| | | PGE | PCY | | |
| 15 Satin nickel | RP Round | \$ 223.00 | \$ 226.00 | \$ 113.00 | \$ 924.00 |
| | RQ Square | \$ 321.00 | \$ 323.00 | \$ 172.00 | \$ 1,062.00 |
| 26/26D Polished chrome / Satin chrome* | RP Round | \$ 223.00 | \$ 226.00 | \$ 113.00 | \$ 924.00 |
| | RQ Square | \$ 321.00 | \$ 323.00 | \$ 172.00 | \$ 1,062.00 |

Retail price

| Finish | Escutcheon | Function | | DMY R/L Single | DMY R/L Pair | ML-F Entry |
|--|----------------|-----------|-----------|----------------|--------------|------------|
| | | PGE | PCY | | | |
| 26/26D Polished chrome / Satin chrome* | EP Oval | \$ 481.00 | \$ 494.00 | \$ 254.00 | \$ 430.00 | \$ 859.00 |
| | ER Rectangular | \$ 558.00 | \$ 570.00 | \$ 267.00 | \$ 481.00 | \$ 899.00 |

* Note: The lever is satin on its front face only, while the shank and the rest of the lever is polished. The rosette/escutcheon is polished.

The options listed above are considered standard. Non-standard options are available upon request.

For more options on Rosettes and Escutcheon plates see page 23. For more options on Finishes see pages 12-13.

RE = Rectangular rosettes available for tubular latch application only. Add + \$ 30.00 LIST to the price of the RQ

Upcharges apply for the following special options:

- Extra thick door (> 2")
- Non-standard rosettes (rosettes not listed above)
- Non-standard finishes (finishes not listed above)
- Split finishes

See page 17 for pricing. Exclusions may apply.

Matching elements

- Pg 168 Mortise lock functions
- Pg 152 Deadbolts
- Pg 154 Privacy Bolts
- Pg 156 Escutcheons with deadbolts
- Pg 160 Multi-Point Trim functions

Window lever available in the same design. Call for pricing.

H 1044

Vincent Van Duysen

| | | |
|------------|------------|-------|
| Material | Collection | Group |
| Zinc alloy | Fusital | 4 |



Standard option (mm/inches)

RP Round rosette

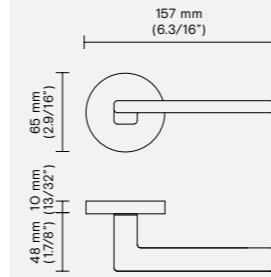

Standard option (mm/inches)

RQ Square rosette

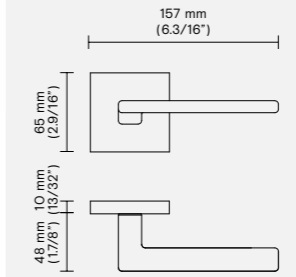

Escutcheon options (mm/inches)

EP Oval plate

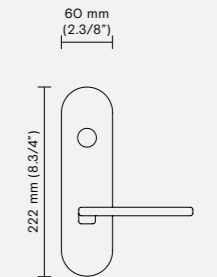

ER Rectangular plate

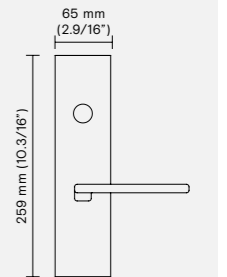

Conversions from metric to U.S. measurements are approximate.

Slim rosette available - See pages 102-103

Retail price

| Finish | Rosette | Function | | DMY R/L Single | ML-F Entry |
|--------------------|-----------|-----------|-----------|----------------|-------------|
| | | PGE | PCY | | |
| 14 Polished nickel | RP Round | \$ 202.00 | \$ 205.00 | \$ 106.00 | \$ 924.00 |
| | RQ Square | \$ 306.00 | \$ 308.00 | \$ 164.00 | \$ 1,062.00 |
| 15 Satin nickel | RP Round | \$ 202.00 | \$ 205.00 | \$ 106.00 | \$ 924.00 |
| | RQ Square | \$ 306.00 | \$ 308.00 | \$ 164.00 | \$ 1,062.00 |
| 16 Dull black | RP Round | \$ 202.00 | \$ 205.00 | \$ 106.00 | \$ 924.00 |
| | RQ Square | \$ 306.00 | \$ 308.00 | \$ 164.00 | \$ 1,062.00 |
| 26 Polished chrome | RP Round | \$ 202.00 | \$ 205.00 | \$ 106.00 | \$ 924.00 |
| | RQ Square | \$ 306.00 | \$ 308.00 | \$ 164.00 | \$ 1,062.00 |
| 26D Satin chrome | RP Round | \$ 202.00 | \$ 205.00 | \$ 106.00 | \$ 924.00 |
| | RQ Square | \$ 306.00 | \$ 308.00 | \$ 164.00 | \$ 1,062.00 |

Note: The H 1044 lever is also available with return on the smaller end, please see next page.

Retail price

| Finish | Escutcheon | Function | | DMY R/L Single | DMY R/L Pair | ML-F Entry |
|--------------------|----------------|-----------|-----------|----------------|--------------|------------|
| | | PGE | PCY | | | |
| 26 Polished chrome | EP Oval | \$ 481.00 | \$ 494.00 | \$ 254.00 | \$ 430.00 | \$ 859.00 |
| | ER Rectangular | \$ 558.00 | \$ 570.00 | \$ 267.00 | \$ 481.00 | \$ 899.00 |
| 26D Satin chrome | EP Oval | \$ 481.00 | \$ 494.00 | \$ 254.00 | \$ 430.00 | \$ 859.00 |
| | ER Rectangular | \$ 558.00 | \$ 570.00 | \$ 267.00 | \$ 481.00 | \$ 899.00 |

The options listed above are considered standard. Non-standard options are available upon request.

For more options on Rosettes and Escutcheon plates see page 23. For more options on Finishes see pages 12-13.

RE = Rectangular rosettes available for tubular latch application only. Add + \$ 30.00 LIST to the price of the RQ

Upcharges apply for the following special options:

- Extra thick door (> 2")
- Non-standard rosettes (rosettes not listed above)
- Non-standard finishes (finishes not listed above)
- Split finishes

See page 17 for pricing. Exclusions may apply.

Matching elements

- Pg 168 Mortise lock functions
- Pg 152 Deadbolts
- Pg 154 Privacy Bolts
- Pg 156 Escutcheons with deadbolts
- Pg 160 Multi-Point Trim functions

Window lever available in the same design. Call for pricing.



H 1044 U Vincent Van Duysen

| | | |
|----------|------------|-------|
| Material | Collection | Group |
| Brass | Fusital | 2 |

Standard option (mm/inches)

RP Round rosette

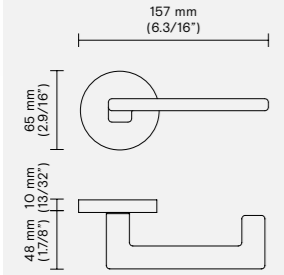

Standard option (mm/inches)

RQ Square rosette

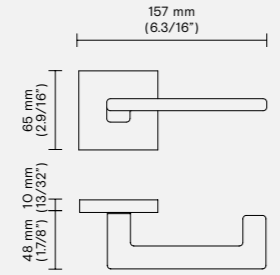

Escutcheon options (mm/inches)

EP Oval plate

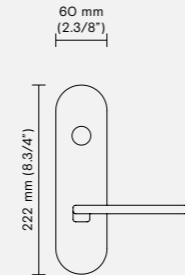

ER Rectangular plate

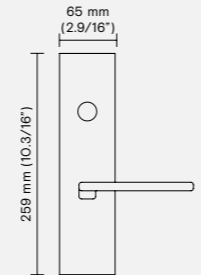

Conversions from metric to U.S. measurements are approximate.

Retail price

| Finish | Rosette | Function | | DMY R/L Single | ML-F Entry |
|--------------------|-----------|-----------|-----------|----------------|-------------|
| | | PGE | PCY | | |
| 15 Satin nickel | RP Round | \$ 443.00 | \$ 463.00 | \$ 210.00 | \$ 1,037.00 |
| | RQ Square | \$ 573.00 | \$ 592.00 | \$ 289.00 | \$ 1,176.00 |
| 16 Dull black | RP Round | \$ 443.00 | \$ 463.00 | \$ 210.00 | \$ 1,037.00 |
| | RQ Square | \$ 573.00 | \$ 592.00 | \$ 289.00 | \$ 1,176.00 |
| 26 Polished chrome | RP Round | \$ 411.00 | \$ 420.00 | \$ 211.00 | \$ 1,037.00 |
| | RQ Square | \$ 529.00 | \$ 539.00 | \$ 263.00 | \$ 1,176.00 |

Note: The H 1044 lever is also available without return, please see previous page.

Retail price

| Finish | Escutcheon | Function | | DMY R/L Single | DMY R/L Pair | ML-F Entry |
|--------------------|----------------|-----------|-----------|----------------|--------------|-------------|
| | | PGE | PCY | | | |
| 26 Polished chrome | EP Oval | \$ 596.00 | \$ 633.00 | \$ 293.00 | \$ 549.00 | \$ 974.00 |
| | ER Rectangular | \$ 645.00 | \$ 658.00 | \$ 318.00 | \$ 583.00 | \$ 1,010.00 |

The options listed above are considered standard. Non-standard options are available upon request.

For more options on Rosettes and Escutcheon plates see page 23. For more options on Finishes see pages 12-13.

RE = Rectangular rosettes available for tubular latch application only. Add + \$ 30.00 LIST to the price of the RQ

Upcharges apply for the following special options:

- Extra thick door (> 2")
- Non-standard rosettes (rosettes not listed above)
- Non-standard finishes (finishes not listed above)
- Split finishes

See page 17 for pricing. Exclusions may apply.

Matching elements

- Pg 168 Mortise lock functions
- Pg 152 Deadbolts
- Pg 154 Privacy Bolts
- Pg 156 Escutcheons with deadbolts
- Pg 160 Multi-Point Trim functions

Window lever available in the same design. Call for pricing.

H 1045 Yoshimi Kono

| | | |
|----------|------------|-------|
| Material | Collection | Group |
| Brass | Fusital | 2 |



Standard option (mm/inches)

RQ Square rosette

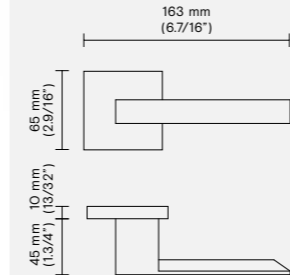

Standard option (mm/inches)

RP Round rosette

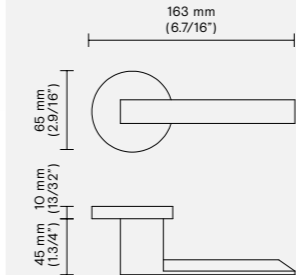

Escutcheon options (mm/inches)

EP Oval plate

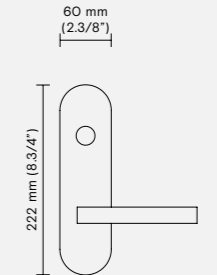

ER Rectangular plate

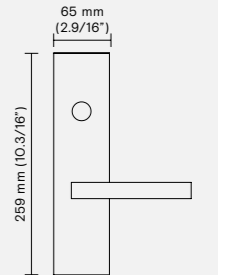

Slim rosette available - See pages 102-103

Conversions from metric to U.S. measurements are approximate.

Retail price

| Finish | Rosette | Function | | DMY R/L Single | ML-F Entry |
|--------------------|-----------|-----------|-----------|----------------|-------------|
| | | PGE | PCY | | |
| 14 Polished nickel | RP Round | \$ 437.00 | \$ 455.00 | \$ 205.00 | \$ 1,037.00 |
| | RQ Square | \$ 573.00 | \$ 586.00 | \$ 283.00 | \$ 1,176.00 |
| 15 Satin nickel | RP Round | \$ 423.00 | \$ 441.00 | \$ 200.00 | \$ 1,037.00 |
| | RQ Square | \$ 546.00 | \$ 558.00 | \$ 276.00 | \$ 1,176.00 |
| 26 Polished chrome | RP Round | \$ 392.00 | \$ 400.00 | \$ 184.00 | \$ 1,037.00 |
| | RQ Square | \$ 504.00 | \$ 521.00 | \$ 251.00 | \$ 1,176.00 |
| 26D Satin chrome | RP Round | \$ 410.00 | \$ 424.00 | \$ 195.00 | \$ 1,037.00 |
| | RQ Square | \$ 534.00 | \$ 548.00 | \$ 270.00 | \$ 1,176.00 |

Retail price

| Finish | Escutcheon | Function | | DMY R/L Single | DMY R/L Pair | ML-F Entry |
|--------------------|----------------|-----------|-----------|----------------|--------------|-------------|
| | | PGE | PCY | | | |
| 26 Polished chrome | EP Oval | \$ 596.00 | \$ 633.00 | \$ 293.00 | \$ 549.00 | \$ 974.00 |
| | ER Rectangular | \$ 645.00 | \$ 658.00 | \$ 318.00 | \$ 583.00 | \$ 1,010.00 |
| 26D Satin chrome | EP Oval | \$ 596.00 | \$ 633.00 | \$ 293.00 | \$ 549.00 | \$ 974.00 |
| | ER Rectangular | \$ 645.00 | \$ 658.00 | \$ 318.00 | \$ 583.00 | \$ 1,010.00 |

The options listed above are considered standard. Non-standard options are available upon request.

For more options on Rosettes and Escutcheon plates see page 23. For more options on Finishes see pages 12-13.

RE = Rectangular rosettes available for tubular latch application only. Add + \$ 30.00 LIST to the price of the RQ. For slim rosette and European version see pages 100-103.

Upcharges apply for the following special options:

- Extra thick door (> 2")
- Non-standard rosettes (rosettes not listed above)
- Non-standard finishes (finishes not listed above)
- Split finishes

See page 17 for pricing. Exclusions may apply.

Matching elements

- Pg 168 Mortise lock functions
- Pg 152 Deadbolts
- Pg 154 Privacy Bolts
- Pg 156 Escutcheons with deadbolts
- Pg 160 Multi-Point Trim functions

European window lever style available in the same design. Call for pricing.



H 1046

Nais

PRESTO

| | | |
|----------|------------|-------|
| Material | Collection | Group |
| Brass | Lab | 2 |

Standard option (mm/inches) RQ Square rosette

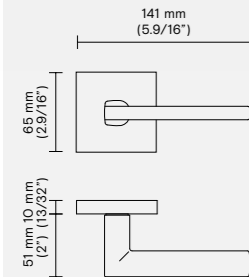

Standard option (mm/inches) RP Round rosette

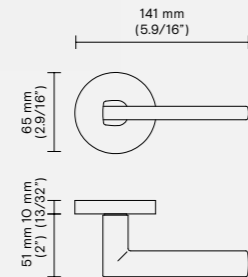

Escutcheon options (mm/inches) EP Oval plate ER Rectangular plate

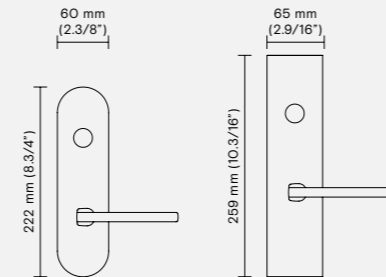

Conversions from metric to U.S. measurements are approximate.

Slim rosette available - See pages 102-103

Retail price

| Finish | Rosette | Function PGE | PCY | DMY R/L Single | ML-F Entry |
|--------------------|-----------|--------------|-----------|----------------|-------------|
| 15 Satin nickel | RP Round | \$ 354.00 | \$ 370.00 | \$ 165.00 | \$ 1,037.00 |
| | RQ Square | \$ 479.00 | \$ 498.00 | \$ 243.00 | \$ 1,176.00 |
| 16 Dull black | RP Round | \$ 332.00 | \$ 350.00 | \$ 155.00 | \$ 1,037.00 |
| | RQ Square | \$ 463.00 | \$ 480.00 | \$ 236.00 | \$ 1,176.00 |
| 26 Polished chrome | RP Round | \$ 327.00 | \$ 337.00 | \$ 148.00 | \$ 1,037.00 |
| | RQ Square | \$ 441.00 | \$ 458.00 | \$ 220.00 | \$ 1,176.00 |
| 26D Satin chrome | RP Round | \$ 332.00 | \$ 350.00 | \$ 155.00 | \$ 1,037.00 |
| | RQ Square | \$ 463.00 | \$ 480.00 | \$ 236.00 | \$ 1,176.00 |

Retail price

| Finish | Escutcheon | Function PGE | PCY | DMY R/L Single | DMY R/L Pair | ML-F Entry |
|--------------------|----------------|--------------|-----------|----------------|--------------|-------------|
| 26 Polished chrome | EP Oval | \$ 596.00 | \$ 633.00 | \$ 293.00 | \$ 549.00 | \$ 974.00 |
| | ER Rectangular | \$ 645.00 | \$ 658.00 | \$ 318.00 | \$ 583.00 | \$ 1,010.00 |
| 26D Satin chrome | EP Oval | \$ 596.00 | \$ 633.00 | \$ 293.00 | \$ 549.00 | \$ 974.00 |
| | ER Rectangular | \$ 645.00 | \$ 658.00 | \$ 318.00 | \$ 583.00 | \$ 1,010.00 |

The options listed above are considered standard. Non-standard options are available upon request.

For more options on Rosettes and Escutcheon plates see page 23. For more options on Finishes see pages 12-13.

RE = Rectangular rosettes available for tubular latch application only. Add + \$ 30.00 LIST to the price of the RQ. For slim rosette and European version see pages 100-103.

Upcharges apply for the following special options:

- Extra thick door (> 2")
- Non-standard rosettes (rosettes not listed above)
- Non-standard finishes (finishes not listed above)
- Split finishes

See page 17 for pricing. Exclusions may apply.

Matching elements

- Pg 168 Mortise lock functions
- Pg 152 Deadbolts
- Pg 154 Privacy Bolts
- Pg 156 Escutcheons with deadbolts
- Pg 160 Multi-Point Trim functions

European window lever style available in the same design. Call for pricing.

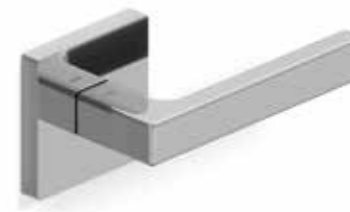

H 1049

Divara

PRESTO

| | | |
|----------|------------|-------|
| Material | Collection | Group |
| Brass | Lab | 2 |

Standard option (mm/inches) RQ Square rosette

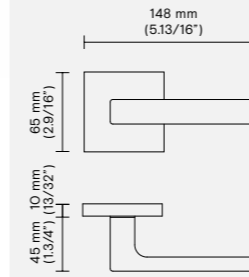

Standard option (mm/inches) RP Round rosette

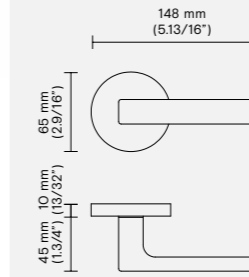

Escutcheon options (mm/inches) EP Oval plate ER Rectangular plate

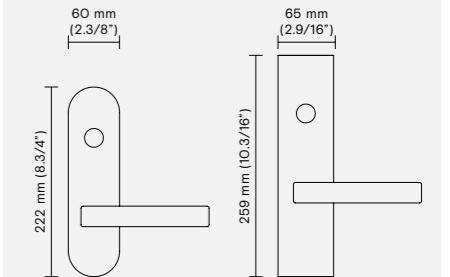

Conversions from metric to U.S. measurements are approximate.

Slim rosette available - See pages 102-103

Retail price

| Finish | Rosette | Function PGE | PCY | DMY R/L Single | ML-F Entry |
|---------------------------|-----------|--------------|-----------|----------------|-------------|
| 16 Dull black | RP Round | \$ 375.00 | \$ 404.00 | \$ 179.00 | \$ 1,037.00 |
| | RQ Square | \$ 506.00 | \$ 532.00 | \$ 256.00 | \$ 1,176.00 |
| 17A Polished black nickel | RP Round | \$ 435.00 | \$ 469.00 | \$ 208.00 | \$ 1,037.00 |
| | RQ Square | \$ 588.00 | \$ 617.00 | \$ 297.00 | \$ 1,176.00 |
| 26 Polished chrome | RP Round | \$ 393.00 | \$ 422.00 | \$ 188.00 | \$ 1,037.00 |
| | RQ Square | \$ 516.00 | \$ 548.00 | \$ 259.00 | \$ 1,176.00 |
| 26D Satin chrome | RP Round | \$ 397.00 | \$ 427.00 | \$ 189.00 | \$ 1,037.00 |
| | RQ Square | \$ 535.00 | \$ 562.00 | \$ 272.00 | \$ 1,176.00 |

Retail price

| Finish | Escutcheon | Function PGE | PCY | DMY R/L Single | DMY R/L Pair | ML-F Entry |
|--------------------|----------------|--------------|-----------|----------------|--------------|-------------|
| 26 Polished chrome | EP Oval | \$ 596.00 | \$ 633.00 | \$ 293.00 | \$ 549.00 | \$ 974.00 |
| | ER Rectangular | \$ 645.00 | \$ 658.00 | \$ 318.00 | \$ 583.00 | \$ 1,010.00 |
| 26D Satin chrome | EP Oval | \$ 596.00 | \$ 633.00 | \$ 293.00 | \$ 549.00 | \$ 974.00 |
| | ER Rectangular | \$ 645.00 | \$ 658.00 | \$ 318.00 | \$ 583.00 | \$ 1,010.00 |

The options listed above are considered standard. Non-standard options are available upon request.

For more options on Rosettes and Escutcheon plates see page 23. For more options on Finishes see pages 12-13.

RE = Rectangular rosettes available for tubular latch application only. Add + \$ 30.00 LIST to the price of the RQ. For slim rosette and European version see pages 100-103.

Upcharges apply for the following special options:

- Extra thick door (> 2")
- Non-standard rosettes (rosettes not listed above)
- Non-standard finishes (finishes not listed above)
- Split finishes

See page 17 for pricing. Exclusions may apply.

Matching elements

- Pg 168 Mortise lock functions
- Pg 152 Deadbolts
- Pg 154 Privacy Bolts
- Pg 156 Escutcheons with deadbolts
- Pg 160 Multi-Point Trim functions

European window lever style available in the same design. Call for pricing.



H 1050 Giasone

| | | |
|----------|------------|-------|
| Material | Collection | Group |
| Brass | Lab | 1 |

Standard option (mm/inches)

RP Round rosette

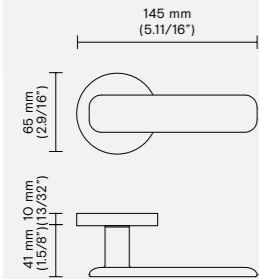

Standard option (mm/inches)

RQ Square rosette

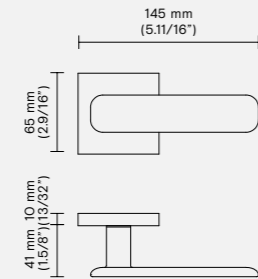

Escutcheon options (mm/inches)

EP Oval plate ER Rectangular plate

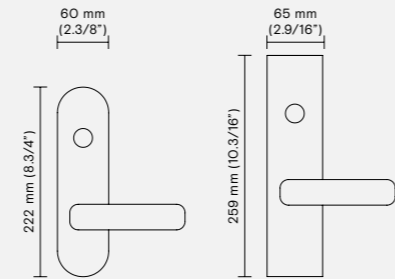

Conversions from metric to U.S. measurements are approximate.

Slim rosette available - See pages 102-103

Retail price

| Finish | Rosette | Function | | DMY R/L Single | ML-F Entry |
|--------------------|-----------|-----------|-----------|----------------|-------------|
| | | PGE | PCY | | |
| 26 Polished chrome | RP Round | \$ 374.00 | \$ 408.00 | \$ 188.00 | \$ 961.00 |
| | RQ Square | \$ 502.00 | \$ 532.00 | \$ 262.00 | \$ 1,100.00 |
| 26D Satin chrome | RP Round | \$ 374.00 | \$ 408.00 | \$ 188.00 | \$ 961.00 |
| | RQ Square | \$ 515.00 | \$ 542.00 | \$ 276.00 | \$ 1,100.00 |

Retail price

| Finish | Escutcheon | Function | | DMY R/L Single | DMY R/L Pair | ML-F Entry |
|--------------------|----------------|-----------|-----------|----------------|--------------|------------|
| | | PGE | PCY | | | |
| 26 Polished chrome | EP Oval | \$ 520.00 | \$ 545.00 | \$ 254.00 | \$ 455.00 | \$ 899.00 |
| | ER Rectangular | \$ 570.00 | \$ 596.00 | \$ 279.00 | \$ 506.00 | \$ 935.00 |
| 26D Satin chrome | EP Oval | \$ 520.00 | \$ 545.00 | \$ 254.00 | \$ 455.00 | \$ 899.00 |
| | ER Rectangular | \$ 570.00 | \$ 596.00 | \$ 279.00 | \$ 506.00 | \$ 935.00 |

The options listed above are considered standard. Non-standard options are available upon request.

For more options on Rosettes and Escutcheon plates see page 23. For more options on Finishes see pages 12-13.

RE = Rectangular rosettes available for tubular latch application only. Add + \$ 30.00 LIST to the price of the RQ. For slim rosette and European version see pages 100-103.

Upcharges apply for the following special options:

- Extra thick door (> 2")
- Non-standard rosettes (rosettes not listed above)
- Non-standard finishes (finishes not listed above)
- Split finishes

See page 17 for pricing. Exclusions may apply.

Matching elements

- Pg 168 Mortise lock functions
- Pg 152 Deadbolts
- Pg 154 Privacy Bolts
- Pg 156 Escutcheons with deadbolts
- Pg 160 Multi-Point Trim functions

European window lever style available in the same design. Call for pricing.



H 1052 Mikhail Leykin

| | | |
|----------|------------|-------|
| Material | Collection | Group |
| Brass | Fusital | 2 |

Standard option (mm/inches)

RP Round rosette

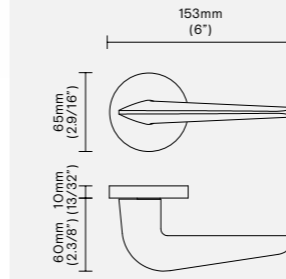

Standard option (mm/inches)

RQ Square rosette

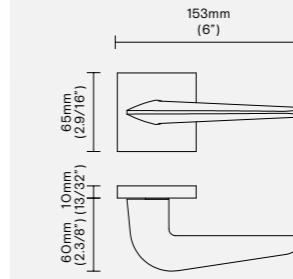

Escutcheon options (mm/inches)

EP Oval plate ER Rectangular plate

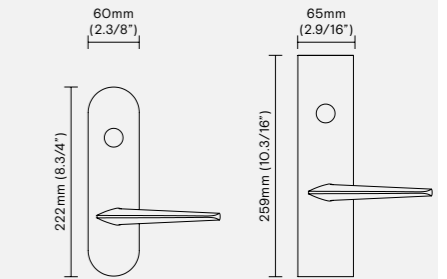

Conversions from metric to U.S. measurements are approximate.

Slim rosette available - See pages 102-103

Retail price

| Finish | Rosette | Function | | DMY R/L Single | ML-F Entry |
|--------------------|-----------|-----------|-----------|----------------|-------------|
| | | PGE | PCY | | |
| 06M Matt bronze | RP Round | \$ 477.00 | \$ 717.00 | \$ 236.00 | \$ 1,037.00 |
| | RQ Square | \$ 596.00 | \$ 857.00 | \$ 295.00 | \$ 1,176.00 |
| 16 Dull black | RP Round | \$ 396.00 | \$ 717.00 | \$ 189.00 | \$ 1,037.00 |
| | RQ Square | \$ 515.00 | \$ 857.00 | \$ 249.00 | \$ 1,176.00 |
| 26 Polished chrome | RP Round | \$ 402.00 | \$ 667.00 | \$ 198.00 | \$ 1,037.00 |
| | RQ Square | \$ 521.00 | \$ 807.00 | \$ 258.00 | \$ 1,176.00 |
| 26D Satin chrome | RP Round | \$ 421.00 | \$ 725.00 | \$ 208.00 | \$ 1,037.00 |
| | RQ Square | \$ 539.00 | \$ 855.00 | \$ 267.00 | \$ 1,176.00 |

Note: If does not fit a privacy pin, supplied with 105 privacy bolt.

Retail price

| Finish | Escutcheon | Function | | DMY R/L Single | DMY R/L Pair | ML-F Entry |
|--------------------|----------------|-----------|-----------|----------------|--------------|-------------|
| | | PGE | PCY | | | |
| 26 Polished chrome | EP Oval | \$ 596.00 | \$ 633.00 | \$ 293.00 | \$ 549.00 | \$ 974.00 |
| | ER Rectangular | \$ 645.00 | \$ 658.00 | \$ 318.00 | \$ 583.00 | \$ 1,010.00 |
| 26D Satin chrome | EP Oval | \$ 596.00 | \$ 633.00 | \$ 293.00 | \$ 549.00 | \$ 974.00 |
| | ER Rectangular | \$ 645.00 | \$ 658.00 | \$ 318.00 | \$ 583.00 | \$ 1,010.00 |

The options listed above are considered standard. Non-standard options are available upon request.

For more options on Rosettes and Escutcheon plates see page 23. For more options on Finishes see pages 12-13.

RE = Rectangular rosettes available for tubular latch application only. Add + \$ 30.00 LIST to the price of the RQ. For slim rosette and European version see pages 100-103.

Upcharges apply for the following special options:

- Extra thick door (> 2")
- Non-standard rosettes (rosettes not listed above)
- Non-standard finishes (finishes not listed above)
- Split finishes

See page 17 for pricing. Exclusions may apply.

Matching elements

- Pg 168 Mortise lock functions
- Pg 152 Deadbolts
- Pg 154 Privacy Bolts
- Pg 156 Escutcheons with deadbolts
- Pg 160 Multi-Point Trim functions

European window lever style available in the same design. Call for pricing.



H 1054

W.W.

PRESTO

| | | |
|----------|------------|-------|
| Material | Collection | Group |
| Brass | Lab | 2 |

Standard option (mm/inches)

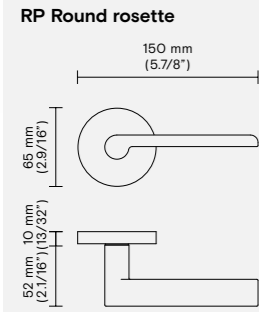

Standard option (mm/inches)

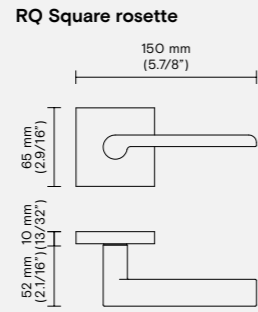

Escutcheon options (mm/inches)

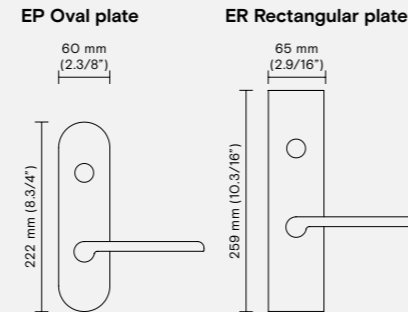

Conversions from metric to U.S. measurements are approximate.

Slim rosette available - See pages 102-103

Retail price

| Finish | Rosette | Function PGE | PCY | DMY R/L Single | ML-F Entry |
|--------------------|-----------|--------------|-----------|----------------|-------------|
| 03M Matt brass | RP Round | \$ 462.00 | \$ 488.00 | \$ 229.00 | \$ 1,037.00 |
| | RQ Square | \$ 555.00 | \$ 590.00 | \$ 287.00 | \$ 1,176.00 |
| 15 Satin nickel | RP Round | \$ 437.00 | \$ 462.00 | \$ 216.00 | \$ 1,037.00 |
| | RQ Square | \$ 560.00 | \$ 598.00 | \$ 296.00 | \$ 1,176.00 |
| 16 Dull black | RP Round | \$ 399.00 | \$ 431.00 | \$ 194.00 | \$ 1,037.00 |
| | RQ Square | \$ 521.00 | \$ 559.00 | \$ 269.00 | \$ 1,176.00 |
| 26 Polished chrome | RP Round | \$ 399.00 | \$ 431.00 | \$ 194.00 | \$ 1,037.00 |
| | RQ Square | \$ 521.00 | \$ 559.00 | \$ 269.00 | \$ 1,176.00 |

Retail price

| Finish | Escutcheon | Function PGE | PCY | DMY R/L Single | DMY R/L Pair | ML-F Entry |
|--------------------|----------------|--------------|-----------|----------------|--------------|-------------|
| 26 Polished chrome | EP Oval | \$ 596.00 | \$ 633.00 | \$ 293.00 | \$ 549.00 | \$ 974.00 |
| | ER Rectangular | \$ 645.00 | \$ 658.00 | \$ 318.00 | \$ 583.00 | \$ 1,010.00 |

The options listed above are considered standard. Non-standard options are available upon request.

For more options on Rosettes and Escutcheon plates see page 23. For more options on Finishes see pages 12-13.

RE = Rectangular rosettes available for tubular latch application only. Add + \$ 30.00 LIST to the price of the RQ. For slim rosette and European version see pages 100-103.

Upcharges apply for the following special options:

- Extra thick door (> 2")
- Non-standard rosettes (rosettes not listed above)
- Non-standard finishes (finishes not listed above)
- Split finishes

See page 17 for pricing. Exclusions may apply.

Matching elements

- Pg 168 Mortise lock functions
- Pg 152 Deadbolts
- Pg 154 Privacy Bolts
- Pg 156 Escutcheons with deadbolts
- Pg 160 Multi-Point Trim functions

European window lever style available in the same design. Call for pricing.



H 1056

Quadra

| | | |
|------------|------------|-------|
| Material | Collection | Group |
| Zinc alloy | Lab | 2 |

Standard option (mm/inches)

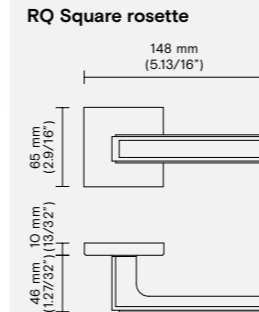

Standard option (mm/inches)

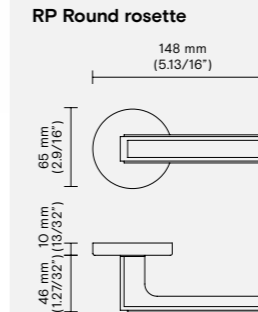

Escutcheon options (mm/inches)

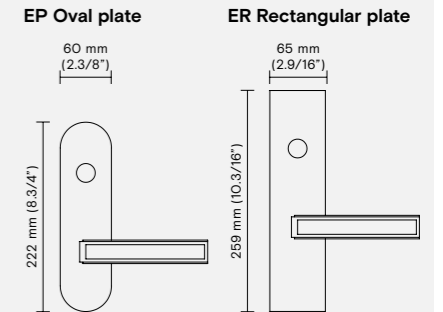

Conversions from metric to U.S. measurements are approximate.

Slim rosette available - See pages 102-103

Retail price

| Finish | Rosette | Function PGE | PCY | DMY R/L Single | ML-F Entry |
|--------------------|-----------|--------------|-----------|----------------|-------------|
| 26 Polished chrome | RP Round | \$ 403.00 | \$ 428.00 | \$ 198.00 | \$ 1,037.00 |
| | RQ Square | \$ 497.00 | \$ 534.00 | \$ 256.00 | \$ 1,176.00 |
| 26D Satin chrome | RP Round | \$ 426.00 | \$ 451.00 | \$ 233.00 | \$ 1,037.00 |
| | RQ Square | \$ 520.00 | \$ 545.00 | \$ 267.00 | \$ 1,176.00 |

Retail price

| Finish | Escutcheon | Function PGE | PCY | DMY R/L Single | DMY R/L Pair | ML-F Entry |
|--------------------|----------------|--------------|-----------|----------------|--------------|-------------|
| 26 Polished chrome | EP Oval | \$ 596.00 | \$ 633.00 | \$ 293.00 | \$ 549.00 | \$ 974.00 |
| | ER Rectangular | \$ 645.00 | \$ 658.00 | \$ 318.00 | \$ 583.00 | \$ 1,010.00 |
| 26D Satin chrome | EP Oval | \$ 596.00 | \$ 633.00 | \$ 293.00 | \$ 549.00 | \$ 974.00 |
| | ER Rectangular | \$ 645.00 | \$ 658.00 | \$ 318.00 | \$ 583.00 | \$ 1,010.00 |

The options listed above are considered standard. Non-standard options are available upon request.

For more options on Rosettes and Escutcheon plates see page 23. For more options on Finishes see pages 12-13.

RE = Rectangular rosettes available for tubular latch application only. Add + \$ 30.00 LIST to the price of the RQ. For slim rosette and European version see pages 100-103.

Upcharges apply for the following special options:

- Extra thick door (> 2")
- Non-standard rosettes (rosettes not listed above)
- Non-standard finishes (finishes not listed above)
- Split finishes

See page 17 for pricing. Exclusions may apply.

Matching elements

- Pg 168 Mortise lock functions
- Pg 152 Deadbolts
- Pg 154 Privacy Bolts
- Pg 156 Escutcheons with deadbolts
- Pg 160 Multi-Point Trim functions

European window lever style available in the same design. Call for pricing.



H 1057 Retrò

| | | |
|----------|------------|-------|
| Material | Collection | Group |
| Brass | Lab | 2 |

Standard option (mm/inches)

RP Round rosette

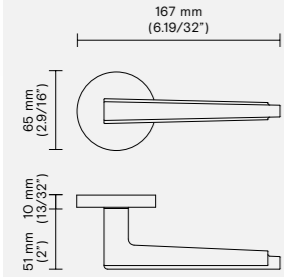

Standard option (mm/inches)

RQ Square rosette

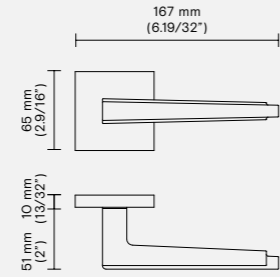

Escutcheon options (mm/inches)

EP Oval plate

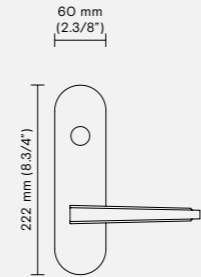

ER Rectangular plate

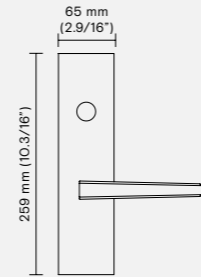

Conversions from metric to U.S. measurements are approximate.

Retail price

| Finish | Rosette | Function | | DMY R/L Single | ML-F Entry |
|--------------------|-----------|-----------|-----------|----------------|-------------|
| | | PGE | PCY | | |
| 03 Polished brass | RP Round | \$ 353.00 | \$ 375.00 | \$ 193.00 | \$ 1,037.00 |
| | RQ Square | \$ 391.00 | \$ 411.00 | \$ 260.00 | \$ 1,176.00 |
| 26 Polished chrome | RP Round | \$ 397.00 | \$ 416.00 | \$ 195.00 | \$ 1,037.00 |
| | RQ Square | \$ 511.00 | \$ 549.00 | \$ 264.00 | \$ 1,176.00 |

Retail price

| Finish | Escutcheon | Function | | DMY R/L Single | DMY R/L Pair | ML-F Entry |
|--------------------|----------------|-----------|-----------|----------------|--------------|-------------|
| | | PGE | PCY | | | |
| 26 Polished chrome | EP Oval | \$ 596.00 | \$ 633.00 | \$ 293.00 | \$ 549.00 | \$ 974.00 |
| | ER Rectangular | \$ 645.00 | \$ 658.00 | \$ 318.00 | \$ 583.00 | \$ 1,010.00 |

The options listed above are considered standard. Non-standard options are available upon request.

For more options on Rosettes and Escutcheon plates see page 23. For more options on Finishes see pages 12-13.

RE = Rectangular rosettes available for tubular latch application only. Add + \$ 30.00 LIST to the price of the RQ. For slim rosette and European version see pages 100-103.

Upcharges apply for the following special options:

- Extra thick door (> 2")
- Non-standard rosettes (rosettes not listed above)
- Non-standard finishes (finishes not listed above)
- Split finishes

See page 17 for pricing. Exclusions may apply.

Matching elements

- Pg 168 Mortise lock functions
- Pg 152 Deadbolts
- Pg 154 Privacy Bolts
- Pg 156 Escutcheons with deadbolts
- Pg 160 Multi-Point Trim functions

European window lever style available in the same design. Call for pricing.



H 1058 Amica

| | | |
|------------|------------|-------|
| Material | Collection | Group |
| Zinc alloy | Lab | 4 |

Standard option (mm/inches)

RP Round rosette

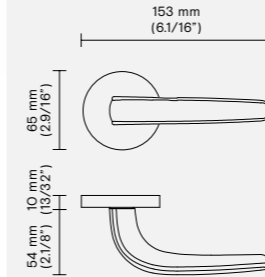

Standard option (mm/inches)

RQ Square rosette

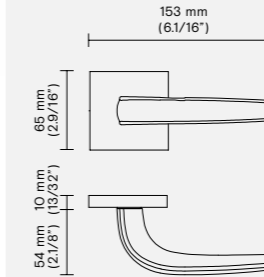

Escutcheon options (mm/inches)

EP Oval plate

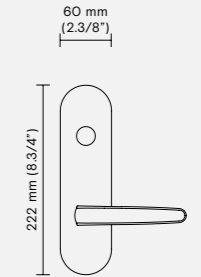

ER Rectangular plate

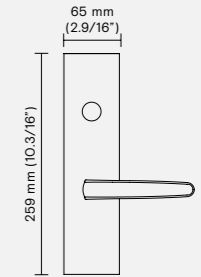

Slim rosette available - See pages 102-103

Conversions from metric to U.S. measurements are approximate.

Retail price

| Finish | Rosette | Function | | DMY R/L Single | ML-F Entry |
|---------------------------------------|-----------|-----------|-----------|----------------|-------------|
| | | PGE | PCY | | |
| 22M Matt white | RP Round | \$ 223.00 | \$ 226.00 | \$ 113.00 | \$ 924.00 |
| | RQ Square | \$ 321.00 | \$ 323.00 | \$ 172.00 | \$ 1,062.00 |
| 26/26D Polished chrome / Satin chrome | RP Round | \$ 223.00 | \$ 226.00 | \$ 113.00 | \$ 924.00 |
| | RQ Square | \$ 321.00 | \$ 323.00 | \$ 172.00 | \$ 1,062.00 |

Retail price

| Finish | Escutcheon | Function | | DMY R/L Single | DMY R/L Pair | ML-F Entry |
|---------------------------------------|----------------|-----------|-----------|----------------|--------------|------------|
| | | PGE | PCY | | | |
| 26/26D Polished chrome / Satin chrome | EP Oval | \$ 481.00 | \$ 494.00 | \$ 254.00 | \$ 430.00 | \$ 859.00 |
| | ER Rectangular | \$ 558.00 | \$ 570.00 | \$ 267.00 | \$ 481.00 | \$ 899.00 |

The options listed above are considered standard. Non-standard options are available upon request.

For more options on Rosettes and Escutcheon plates see page 23. For more options on Finishes see pages 12-13.

RE = Rectangular rosettes available for tubular latch application only. Add + \$ 30.00 LIST to the price of the RQ.

Upcharges apply for the following special options:

- Extra thick door (> 2")
- Non-standard rosettes (rosettes not listed above)
- Non-standard finishes (finishes not listed above)
- Split finishes

See page 17 for pricing. Exclusions may apply.

Matching elements

- Pg 168 Mortise lock functions
- Pg 152 Deadbolts
- Pg 154 Privacy Bolts
- Pg 156 Escutcheons with deadbolts
- Pg 160 Multi-Point Trim functions

Window lever available in the same design. Call for pricing.



H 1060

SOM - Skidmore, Owings & Merrill

| | | |
|----------|------------|-------|
| Material | Collection | Group |
| Brass | Fusital | 3 |

Standard option (mm/inches)

RQ Square rosette

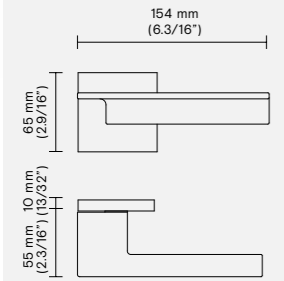

Standard option (mm/inches)

RP Round rosette

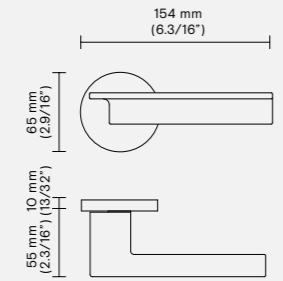

Escutcheon options (mm/inches)

EP Oval plate

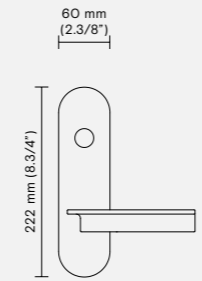

ER Rectangular plate

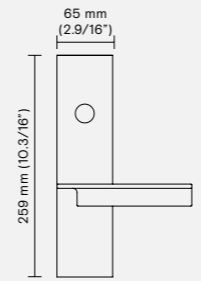

Conversions from metric to U.S. measurements are approximate.

Slim rosette available - See pages 102-103

Retail price

| Finish | Rosette | Function | | DMY R/L Single | ML-F Entry |
|--------------------|-----------|-----------|-----------|----------------|-------------|
| | | PGE | PCY | | |
| 16 Dull black | RP Round | \$ 612.00 | \$ 622.00 | \$ 297.00 | \$ 1,251.00 |
| | RQ Square | \$ 502.00 | \$ 511.00 | \$ 242.00 | \$ 1,389.00 |
| 26 Polished chrome | RP Round | \$ 638.00 | \$ 650.00 | \$ 258.00 | \$ 1,251.00 |
| | RQ Square | \$ 528.00 | \$ 540.00 | \$ 253.00 | \$ 1,389.00 |
| 26D Satin chrome | RP Round | \$ 638.00 | \$ 650.00 | \$ 258.00 | \$ 1,251.00 |
| | RQ Square | \$ 528.00 | \$ 540.00 | \$ 253.00 | \$ 1,389.00 |

Retail price

| Finish | Escutcheon | Function | | DMY R/L Single | DMY R/L Pair | ML-F Entry |
|--------------------|----------------|-----------|-----------|----------------|--------------|-------------|
| | | PGE | PCY | | | |
| 26 Polished chrome | EP Oval | \$ 772.00 | \$ 785.00 | \$ 387.00 | \$ 712.00 | \$ 1,200.00 |
| | ER Rectangular | \$ 819.00 | \$ 833.00 | \$ 410.00 | \$ 761.00 | \$ 1,226.00 |
| 26D Satin chrome | EP Oval | \$ 772.00 | \$ 785.00 | \$ 387.00 | \$ 712.00 | \$ 1,200.00 |
| | ER Rectangular | \$ 819.00 | \$ 833.00 | \$ 410.00 | \$ 761.00 | \$ 1,226.00 |

The options listed above are considered standard. Non-standard options are available upon request.

For more options on Rosettes and Escutcheon plates see page 23. For more options on Finishes see pages 12-13.

RE = Rectangular rosettes available for tubular latch application only. Add + \$ 30.00 LIST to the price of the RQ. For slim rosette and European version see pages 100-103.

Upcharges apply for the following special options:

- Extra thick door (> 2")
- Non-standard rosettes (rosettes not listed above)
- Non-standard finishes (finishes not listed above)
- Split finishes

See page 17 for pricing. Exclusions may apply.

Matching elements

- Pg 168 Mortise lock functions
- Pg 152 Deadbolts
- Pg 154 Privacy Bolts
- Pg 156 Escutcheons with deadbolts
- Pg 160 Multi-Point Trim functions

European window lever style available in the same design. Call for pricing.



H 1061

Di Virgilio Veneziano

| | | |
|----------|------------|-------|
| Material | Collection | Group |
| Brass | Fusital | 2 |

Standard option (mm/inches)

RP Round rosette

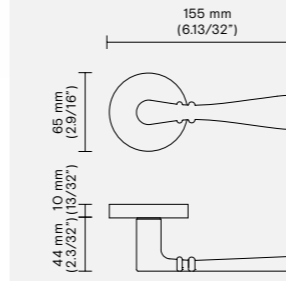

Standard option (mm/inches)

RQ Square rosette

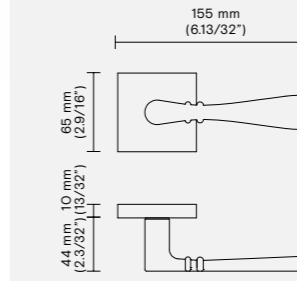

Escutcheon options (mm/inches)*

EP Oval plate

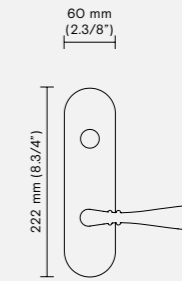

ER Rectangular plate

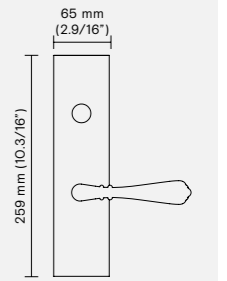

*Only available on request. Conversions from metric to U.S. measurements are approximate.

Slim rosette available - See pages 102-103

Retail price

| Finish | Rosette | Function | | DMY R/L Single | ML-F Entry |
|---------------------------|-----------|-----------|-----------|----------------|-------------|
| | | PGE | PCY | | |
| 03D Satin brass | RP Round | \$ 492.00 | \$ 516.00 | \$ 245.00 | \$ 1,037.00 |
| | RQ Square | \$ 590.00 | \$ 626.00 | \$ 305.00 | \$ 1,176.00 |
| 06M Matt bronze | RP Round | \$ 492.00 | \$ 516.00 | \$ 245.00 | \$ 1,037.00 |
| | RQ Square | \$ 590.00 | \$ 626.00 | \$ 305.00 | \$ 1,176.00 |
| 17A Polished black nickel | RP Round | \$ 522.00 | \$ 547.00 | \$ 260.00 | \$ 1,037.00 |
| | RQ Square | \$ 597.00 | \$ 664.00 | \$ 323.00 | \$ 1,176.00 |

The options listed above are considered standard. Non-standard options are available upon request.

For more options on Rosettes and Escutcheon plates see page 23. For more options on Finishes see pages 12-13.

RE = Rectangular rosettes available for tubular latch application only. Add + \$ 30.00 LIST to the price of the RQ. For slim rosette and European version see pages 100-103.

Upcharges apply for the following special options:

- Extra thick door (> 2")
- Non-standard rosettes (rosettes not listed above)
- Non-standard finishes (finishes not listed above)
- Split finishes

See page 17 for pricing. Exclusions may apply.

Matching elements

- Pg 168 Mortise lock functions
- Pg 152 Deadbolts
- Pg 154 Privacy Bolts
- Pg 156 Escutcheons with deadbolts
- Pg 160 Multi-Point Trim functions

European window lever style available in the same design. Call for pricing.



H 1062 Carmen

| | | |
|----------|------------|-------|
| Material | Collection | Group |
| Brass | Lab | 2 |

Standard option (mm/inches)

RP Round rosette

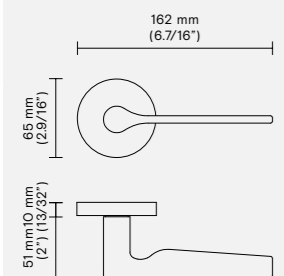

Standard option (mm/inches)

RQ Square rosette

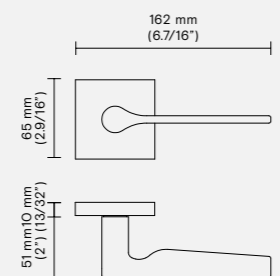

Escutcheon options (mm/inches)

EP Oval plate ER Rectangular plate

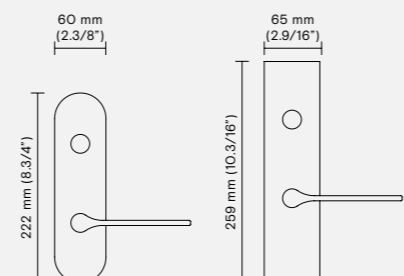

Conversions from metric to U.S. measurements are approximate.

Slim rosette available - See pages 102-103

Retail price

| Finish | Rosette | Function PGE | PCY | DMY R/L Single | ML-F Entry |
|------------------|-----------|--------------|-----------|----------------|-------------|
| 15 Satin nickel | RP Round | \$ 378.00 | \$ 417.00 | \$ 184.00 | \$ 1,037.00 |
| | RQ Square | \$ 497.00 | \$ 536.00 | \$ 243.00 | \$ 1,176.00 |
| 16 Dull black | RP Round | \$ 357.00 | \$ 394.00 | \$ 173.00 | \$ 1,037.00 |
| | RQ Square | \$ 476.00 | \$ 512.00 | \$ 216.00 | \$ 1,176.00 |
| 26D Satin chrome | RP Round | \$ 378.00 | \$ 417.00 | \$ 184.00 | \$ 1,037.00 |
| | RQ Square | \$ 497.00 | \$ 536.00 | \$ 243.00 | \$ 1,176.00 |
| 56 Dark bronze | RP Round | \$ 378.00 | \$ 417.00 | \$ 184.00 | \$ 1,037.00 |
| | RQ Square | \$ 497.00 | \$ 536.00 | \$ 243.00 | \$ 1,176.00 |

Retail price

| Finish | Escutcheon | Function PGE | PCY | DMY R/L Single | DMY R/L Pair | ML-F Entry |
|------------------|----------------|--------------|-----------|----------------|--------------|-------------|
| 26D Satin chrome | EP Oval | \$ 596.00 | \$ 633.00 | \$ 293.00 | \$ 549.00 | \$ 974.00 |
| | ER Rectangular | \$ 645.00 | \$ 658.00 | \$ 318.00 | \$ 583.00 | \$ 1,010.00 |

The options listed above are considered standard. Non-standard options are available upon request.

For more options on Rosettes and Escutcheon plates see page 23. For more options on Finishes see pages 12-13.

RE = Rectangular rosettes available for tubular latch application only. Add + \$ 30.00 LIST to the price of the RQ. For slim rosette and European version see pages 100-103.

Upcharges apply for the following special options:

- Extra thick door (> 2")
- Non-standard rosettes (rosettes not listed above)
- Non-standard finishes (finishes not listed above)
- Split finishes

See page 17 for pricing. Exclusions may apply.

Matching elements

- Pg 168 Mortise lock functions
- Pg 152 Deadbolts
- Pg 154 Privacy Bolts
- Pg 156 Escutcheons with deadbolts
- Pg 160 Multi-Point Trim functions

European window lever style available in the same design. Call for pricing.

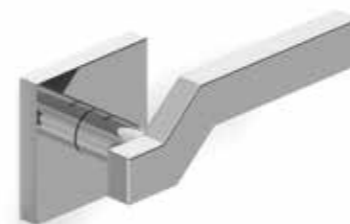

H 1066 Bertone Design

| | | |
|----------|------------|-------|
| Material | Collection | Group |
| Brass | Fusital | 2 |

Standard option (mm/inches)

RQ Square rosette

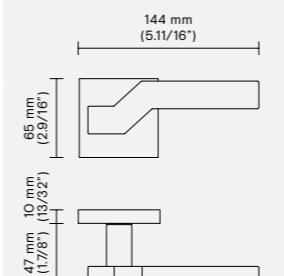

Standard option (mm/inches)

RP Round rosette

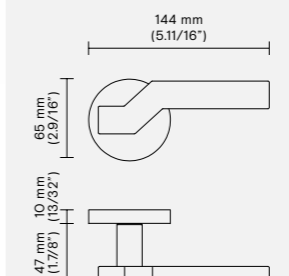

Escutcheon options (mm/inches)

EP Oval plate ER Rectangular plate

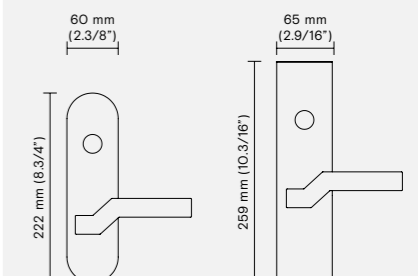

Conversions from metric to U.S. measurements are approximate.

Slim rosette available - See pages 102-103

Retail price

| Finish | Rosette | Function PGE | PCY | DMY R/L Single | ML-F Entry |
|--------------------|-----------|--------------|-----------|----------------|-------------|
| 03M Matt brass | RP Round | \$ 492.00 | \$ 516.00 | \$ 245.00 | \$ 1,037.00 |
| | RQ Square | \$ 590.00 | \$ 626.00 | \$ 305.00 | \$ 1,176.00 |
| 26 Polished chrome | RP Round | \$ 492.00 | \$ 516.00 | \$ 245.00 | \$ 1,037.00 |
| | RQ Square | \$ 590.00 | \$ 626.00 | \$ 305.00 | \$ 1,176.00 |

Retail price

| Finish | Escutcheon | Function PGE | PCY | DMY R/L Single | DMY R/L Pair | ML-F Entry |
|--------------------|----------------|--------------|-----------|----------------|--------------|-------------|
| 26 Polished chrome | EP Oval | \$ 596.00 | \$ 633.00 | \$ 293.00 | \$ 549.00 | \$ 974.00 |
| | ER Rectangular | \$ 645.00 | \$ 658.00 | \$ 318.00 | \$ 583.00 | \$ 1,010.00 |

The options listed above are considered standard. Non-standard options are available upon request.

For more options on Rosettes and Escutcheon plates see page 23. For more options on Finishes see pages 12-13.

RE = Rectangular rosettes available for tubular latch application only. Add + \$ 30.00 LIST to the price of the RQ. For slim rosette and European version see pages 100-103.

Upcharges apply for the following special options:

- Extra thick door (> 2")
- Non-standard rosettes (rosettes not listed above)
- Non-standard finishes (finishes not listed above)
- Split finishes

See page 17 for pricing. Exclusions may apply.

Matching elements

- Pg 168 Mortise lock functions
- Pg 152 Deadbolts
- Pg 154 Privacy Bolts
- Pg 156 Escutcheons with deadbolts
- Pg 160 Multi-Point Trim functions

European window lever style available in the same design. Call for pricing.



H 1068

Pembroke & Ives

| | | |
|----------|------------|-------|
| Material | Collection | Group |
| Brass | Fusital | 3 |

Standard option (mm/inches)

RQ Square rosette

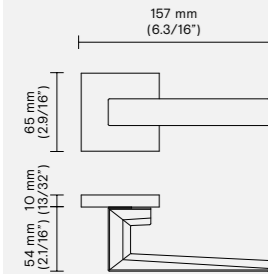

Standard option (mm/inches)

RP Round rosette

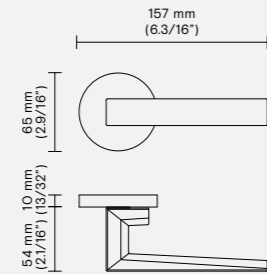

Escutcheon options (mm/inches)

EP Oval plate

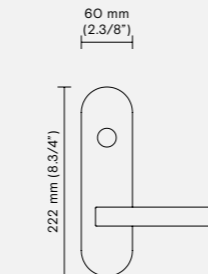

ER Rectangular plate

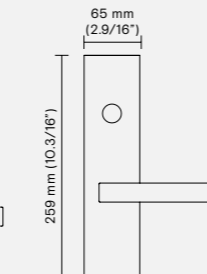

Conversions from metric to U.S. measurements are approximate.

Slim rosette available - See pages 102-103

Retail price

| Finish | Rosette | Function | | DMY R/L Single | ML-F Entry |
|--|-----------|-----------|-----------|----------------|-------------|
| | | PGE | PCY | | |
| 03/03D Polished brass / Satin brass* | RP Round | \$ 546.00 | \$ 571.00 | \$ 278.00 | \$ 1,251.00 |
| | RQ Square | \$ 757.00 | \$ 781.00 | \$ 385.00 | \$ 1,389.00 |
| 15 Satin nickel | RP Round | \$ 529.00 | \$ 553.00 | \$ 274.00 | \$ 1,251.00 |
| | RQ Square | \$ 637.00 | \$ 673.00 | \$ 337.00 | \$ 1,389.00 |
| 16 Dull black | RP Round | \$ 469.00 | \$ 492.00 | \$ 233.00 | \$ 1,251.00 |
| | RQ Square | \$ 563.00 | \$ 597.00 | \$ 291.00 | \$ 1,389.00 |
| 26/26D Polished chrome / Satin chrome* | RP Round | \$ 546.00 | \$ 571.00 | \$ 278.00 | \$ 1,251.00 |
| | RQ Square | \$ 757.00 | \$ 781.00 | \$ 385.00 | \$ 1,389.00 |

Retail price

| Finish | Escutcheon | Function | | DMY R/L Single | DMY R/L Pair | ML-F Entry |
|--|----------------|-----------|-----------|----------------|--------------|-------------|
| | | PGE | PCY | | | |
| 26/26D Polished chrome / Satin chrome* | EP Oval | \$ 772.00 | \$ 785.00 | \$ 387.00 | \$ 712.00 | \$ 1,200.00 |
| | ER Rectangular | \$ 819.00 | \$ 833.00 | \$ 410.00 | \$ 761.00 | \$ 1,226.00 |

* Note: The lever is satin on its front and side edge, while the rest is polished. The rosette/escutcheon is polished.

The options listed above are considered standard. Non-standard options are available upon request.

For more options on Rosettes and Escutcheon plates see page 23. For more options on Finishes see pages 12-13.

RE = Rectangular rosettes available for tubular latch application only. Add + \$ 30.00 LIST to the price of the RQ. For slim rosette and European version see pages 100-103.

Upcharges apply for the following special options:

- Extra thick door (> 2")
- Non-standard rosettes (rosettes not listed above)
- Non-standard finishes (finishes not listed above)
- Split finishes

See page 17 for pricing. Exclusions may apply.

Matching elements

- Pg 168 Mortise lock functions
- Pg 152 Deadbolts
- Pg 154 Privacy Bolts
- Pg 156 Escutcheons with deadbolts
- Pg 160 Multi-Point Trim functions

European window lever style available in the same design. Call for pricing.



H 1069

Susannah

| | | |
|----------|------------|-------|
| Material | Collection | Group |
| Brass | Lab | 3 |

Standard option (mm/inches)

RP Round rosette

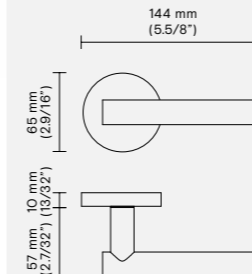

Standard option (mm/inches)

RQ Square rosette

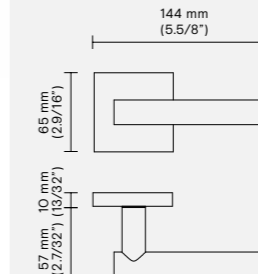

Escutcheon options (mm/inches)

EP Oval plate

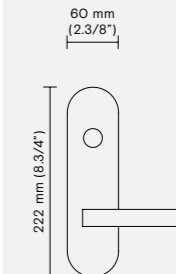

ER Rectangular plate

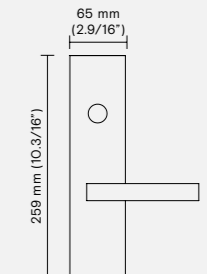

Conversions from metric to U.S. measurements are approximate.

Slim rosette available - See pages 102-103

Retail price

| Finish | Rosette | Function | | DMY R/L Single | ML-F Entry |
|--------------------|-----------|-----------|-----------|----------------|-------------|
| | | PGE | PCY | | |
| 15 Satin nickel | RP Round | \$ 597.00 | \$ 599.00 | \$ 291.00 | \$ 1,251.00 |
| | RQ Square | \$ 793.00 | \$ 819.00 | \$ 403.00 | \$ 1,389.00 |
| 26 Polished chrome | RP Round | \$ 597.00 | \$ 599.00 | \$ 291.00 | \$ 1,251.00 |
| | RQ Square | \$ 793.00 | \$ 819.00 | \$ 403.00 | \$ 1,389.00 |
| 26D Satin chrome | RP Round | \$ 597.00 | \$ 599.00 | \$ 291.00 | \$ 1,251.00 |
| | RQ Square | \$ 793.00 | \$ 819.00 | \$ 403.00 | \$ 1,389.00 |

Retail price

| Finish | Escutcheon | Function | | DMY R/L Single | DMY R/L Pair | ML-F Entry |
|--------------------|----------------|-----------|-----------|----------------|--------------|-------------|
| | | PGE | PCY | | | |
| 26 Polished chrome | EP Oval | \$ 772.00 | \$ 785.00 | \$ 387.00 | \$ 712.00 | \$ 1,200.00 |
| | ER Rectangular | \$ 819.00 | \$ 833.00 | \$ 410.00 | \$ 761.00 | \$ 1,226.00 |
| 26D Satin chrome | EP Oval | \$ 772.00 | \$ 785.00 | \$ 387.00 | \$ 712.00 | \$ 1,200.00 |
| | ER Rectangular | \$ 819.00 | \$ 833.00 | \$ 410.00 | \$ 761.00 | \$ 1,226.00 |

The options listed above are considered standard. Non-standard options are available upon request.

For more options on Rosettes and Escutcheon plates see page 23. For more options on Finishes see pages 12-13.

RE = Rectangular rosettes available for tubular latch application only. Add + \$ 30.00 LIST to the price of the RQ. For slim rosette and European version see pages 100-103.

Upcharges apply for the following special options:

- Extra thick door (> 2")
- Non-standard rosettes (rosettes not listed above)
- Non-standard finishes (finishes not listed above)
- Split finishes

See page 17 for pricing. Exclusions may apply.

Matching elements

- Pg 168 Mortise lock functions
- Pg 152 Deadbolts
- Pg 154 Privacy Bolts
- Pg 156 Escutcheons with deadbolts
- Pg 160 Multi-Point Trim functions

European window lever style available in the same design. Call for pricing.



H 1748 Estrella

PRESTO

| | | |
|----------|------------|-------|
| Material | Collection | Group |
| Brass | Lab | 3 |

Standard option (mm/inches)

RP Round rosette

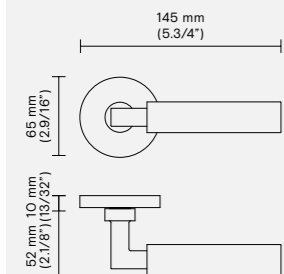

Standard option (mm/inches)

RQ Square rosette

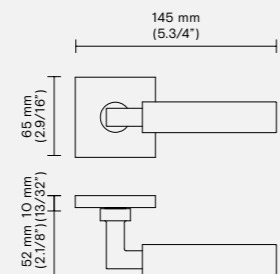

Escutcheon options (mm/inches)

EP Oval plate

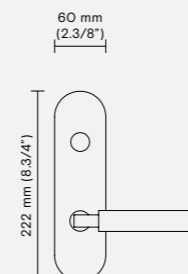

ER Rectangular plate

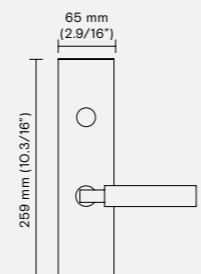

Conversions from metric to U.S. measurements are approximate.

Slim rosette available - See pages 102-103

Retail price

| Finish | Rosette | Function | | DMY R/L Single | ML-F Entry |
|--------------------|-----------|-----------|-----------|----------------|-------------|
| | | PGE | PCY | | |
| 06B Brunito | RP Round | \$ 569.00 | \$ 571.00 | \$ 278.00 | \$ 1,251.00 |
| | RQ Square | \$ 757.00 | \$ 781.00 | \$ 385.00 | \$ 1,389.00 |
| 14 Polished nickel | RP Round | \$ 569.00 | \$ 571.00 | \$ 278.00 | \$ 1,251.00 |
| | RQ Square | \$ 757.00 | \$ 781.00 | \$ 385.00 | \$ 1,389.00 |
| 15 Satin nickel | RP Round | \$ 529.00 | \$ 553.00 | \$ 274.00 | \$ 1,251.00 |
| | RQ Square | \$ 637.00 | \$ 673.00 | \$ 337.00 | \$ 1,389.00 |
| 26 Polished chrome | RP Round | \$ 569.00 | \$ 571.00 | \$ 278.00 | \$ 1,251.00 |
| | RQ Square | \$ 757.00 | \$ 781.00 | \$ 385.00 | \$ 1,389.00 |
| 26D Satin chrome | RP Round | \$ 529.00 | \$ 553.00 | \$ 274.00 | \$ 1,251.00 |
| | RQ Square | \$ 637.00 | \$ 673.00 | \$ 337.00 | \$ 1,389.00 |

Retail price

| Finish | Escutcheon | Function | | DMY R/L Single | DMY R/L Pair | ML-F Entry |
|--------------------|----------------|-----------|-----------|----------------|--------------|-------------|
| | | PGE | PCY | | | |
| 26 Polished chrome | EP Oval | \$ 772.00 | \$ 785.00 | \$ 387.00 | \$ 712.00 | \$ 1,200.00 |
| | ER Rectangular | \$ 819.00 | \$ 833.00 | \$ 410.00 | \$ 761.00 | \$ 1,226.00 |
| 26D Satin chrome | EP Oval | \$ 772.00 | \$ 785.00 | \$ 387.00 | \$ 712.00 | \$ 1,200.00 |
| | ER Rectangular | \$ 819.00 | \$ 833.00 | \$ 410.00 | \$ 761.00 | \$ 1,226.00 |

The options listed above are considered standard. Non-standard options are available upon request.

For more options on Rosettes and Escutcheon plates see page 23. For more options on Finishes see pages 12-13.

RE = Rectangular rosettes available for tubular latch application only. Add + \$ 30.00 LIST to the price of the RQ. For slim rosette and European version see pages 100-103.

Upcharges apply for the following special options:

- Extra thick door (> 2")
- Non-standard rosettes (rosettes not listed above)
- Non-standard finishes (finishes not listed above)
- Split finishes

See page 17 for pricing. Exclusions may apply.

Matching elements

- Pg 168 Mortise lock functions
- Pg 152 Deadbolts
- Pg 154 Privacy Bolts
- Pg 156 Escutcheons with deadbolts
- Pg 160 Multi-Point Trim functions

European window lever style available in the same design. Call for pricing.



H 4730 White

| | | |
|---|------------|-------|
| Material | Collection | Group |
| Zinc alloy + Stainless steel AISI 304 | Lab | 1 |

Standard option (mm/inches)

RP Round rosette

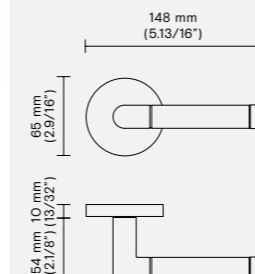

Standard option (mm/inches)

RQ Square rosette

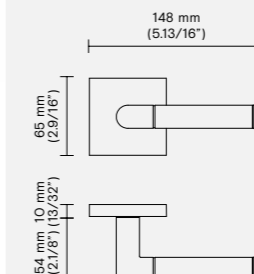

Escutcheon options (mm/inches)

EP Oval plate

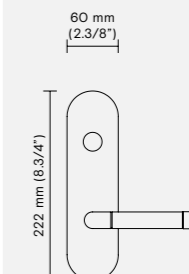

ER Rectangular plate

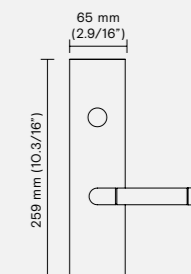

Conversions from metric to U.S. measurements are approximate.

Slim rosette available - See pages 102-103

Retail price

| Finish | Rosette | Function | | DMY R/L Single | ML-F Entry |
|--|-----------|-----------|-----------|----------------|-------------|
| | | PGE | PCY | | |
| 26/32D Polished chrome / Satin stainless steel* | RP Round | \$ 341.00 | \$ 356.00 | \$159.00 | \$ 961.00 |
| | RQ Square | \$ 459.00 | \$ 475.00 | \$219.00 | \$ 1,100.00 |

Retail price

| Finish | Escutcheon | Function | | DMY R/L Single | DMY R/L Pair | ML-F Entry |
|--|----------------|-----------|-----------|----------------|--------------|------------|
| | | PGE | PCY | | | |
| 26/32D Polished chrome / Satin stainless steel* | EP Oval | \$ 520.00 | \$ 545.00 | \$ 254.00 | \$ 455.00 | \$ 899.00 |
| | ER Rectangular | \$ 570.00 | \$ 596.00 | \$ 279.00 | \$ 506.00 | \$ 935.00 |

* Note: the shank and the end cap portions are polished while the grip is satin made of stainless steel. The rosette/escutcheon is polished.

The options listed above are considered standard. Non-standard options are available upon request.

For more options on Rosettes and Escutcheon plates see page 23. For more options on Finishes see pages 12-13.

RE = Rectangular rosettes available for tubular latch application only. Add + \$ 30.00 LIST to the price of the RQ. For slim rosette and European version see pages 100-103.

Upcharges apply for the following special options:

- Extra thick door (> 2")
- Non-standard rosettes (rosettes not listed above)
- Non-standard finishes (finishes not listed above)
- Split finishes

See page 17 for pricing. Exclusions may apply.

Matching elements

- Pg 168 Mortise lock functions
- Pg 152 Deadbolts
- Pg 154 Privacy Bolts
- Pg 156 Escutcheons with deadbolts
- Pg 160 Multi-Point Trim functions

European window lever style available in the same design. Call for pricing.



H 4742

Coral

| | | |
|---|------------|-------|
| Material | Collection | Group |
| Zinc alloy + Stainless steel AISI 304 | Lab | 1 |

Standard option (mm/inches)

RP Round rosette

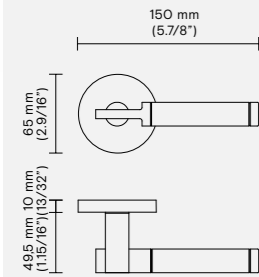

Standard option (mm/inches)

RQ Square rosette

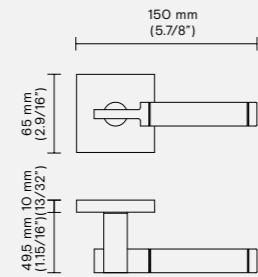

Escutcheon options (mm/inches)

EP Oval plate

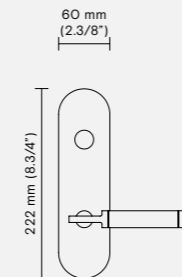

ER Rectangular plate

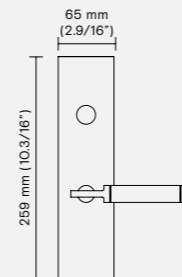

Conversions from metric to U.S. measurements are approximate.

Slim rosette available - See pages 102-103

Retail price

| Finish | Rosette | Function | | DMY R/L Single | ML-F Entry |
|--|-----------|-----------|-----------|----------------|-------------|
| | | PGE | PCY | | |
| 26/32D Polished chrome / Satin stainless steel* | RP Round | \$ 341.00 | \$ 356.00 | \$159.00 | \$ 961.00 |
| | RQ Square | \$ 459.00 | \$ 475.00 | \$219.00 | \$ 1,100.00 |

Retail price

| Finish | Escutcheon | Function | | DMY R/L Single | DMY R/L Pair | ML-F Entry |
|--|----------------|-----------|-----------|----------------|--------------|------------|
| | | PGE | PCY | | | |
| 26/32D Polished chrome / Satin stainless steel* | EP Oval | \$ 520.00 | \$ 545.00 | \$ 254.00 | \$ 455.00 | \$ 899.00 |
| | ER Rectangular | \$ 570.00 | \$ 596.00 | \$ 279.00 | \$ 506.00 | \$ 935.00 |

* Note: the base, the shank and the end cap portions are polished while the grip is satin made of stainless steel. The rosette/escutcheon is polished.

The options listed above are considered standard. Non-standard options are available upon request.

For more options on Rosettes and Escutcheon plates see page 23. For more options on Finishes see pages 12-13.

RE = Rectangular rosettes available for tubular latch application only. Add + \$ 30.00 LIST to the price of the RQ. For slim rosette and European version see pages 100-103.

Upcharges apply for the following special options:

- Extra thick door (> 2")
- Non-standard rosettes (rosettes not listed above)
- Non-standard finishes (finishes not listed above)
- Split finishes

See page 17 for pricing. Exclusions may apply.

Matching elements

- Pg 168 Mortise lock functions
- Pg 152 Deadbolts
- Pg 154 Privacy Bolts
- Pg 156 Escutcheons with deadbolts
- Pg 160 Multi-Point Trim functions

European window lever style available in the same design. Call for pricing.



H 5008

Taller Design Ricardo Bofill

| | | |
|-------------------------------|------------|-------|
| Material | Collection | Group |
| Stainless steel AISI 316 L | Fusital | 7 |

Standard option (mm/inches)

RQS Square rosette

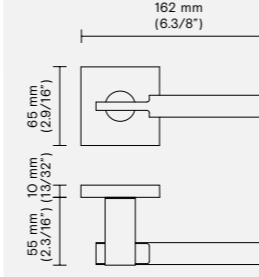

Standard option (mm/inches)

RPS Round rosette - RSS Small 2" rosette

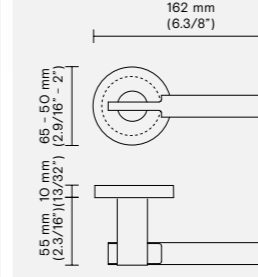

Escutcheon options (mm/inches)

NES Oval plate

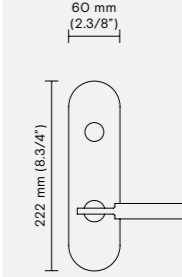

ERS Rectangular plate

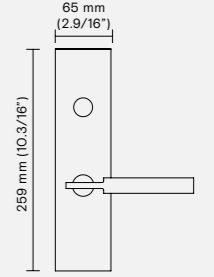

Conversions from metric to U.S. measurements are approximate.

Retail price

| Finish | Rosette | Function | | DMY R/L Single | ML-F Entry |
|-----------------------------|------------|-----------|-----------|----------------|-------------|
| | | PGE | PCY | | |
| 32 Polished stainless steel | RPS Round | \$ 779.00 | \$ 804.00 | \$ 378.00 | \$ 1,516.00 |
| | RQS Square | \$ 947.00 | \$ 987.00 | \$ 473.00 | \$ 1,542.00 |
| | RSS Round | \$ 747.00 | \$ 934.00 | \$ 358.00 | \$ 1,303.00 |
| 32D Satin stainless steel | RPS Round | \$ 715.00 | \$ 737.00 | \$ 346.00 | \$ 1,516.00 |
| | RQS Square | \$ 883.00 | \$ 923.00 | \$ 441.00 | \$ 1,542.00 |
| | RSS Round | \$ 683.00 | \$ 870.00 | \$ 324.00 | \$ 1,303.00 |

Note: The RSS Small round rosette does not fit a privacy pin. Supplied with 105. RSS Trims (2") note recommended for commercial use RSS privacy bolt.

Retail price

| Finish | Escutcheon | Function | | DMY R/L Single | DMY R/L Pair | ML-F Entry |
|---------------------------|-----------------|-----------|-----------|----------------|--------------|-------------|
| | | PGE | PCY | | | |
| 32D Satin stainless steel | NES Oval | \$ 885.00 | \$ 961.00 | \$ 444.00 | \$ 859.00 | \$ 1,340.00 |
| | ERS Rectangular | \$ 949.00 | \$ 985.00 | \$ 481.00 | \$ 899.00 | \$ 1,579.00 |

The options listed above are considered standard. Non-standard options are available upon request.

For more options on Rosettes and Escutcheon plates see page 23. For more options on Finishes see pages 12-13.

RE = Rectangular rosettes available for tubular latch application only. Add + \$ 30.00 LIST to the price of the RQ. For slim rosette and European version see pages 100-103.

Upcharges apply for the following special options:

- Extra thick door (> 2")
- Non-standard rosettes (rosettes not listed above)
- Non-standard finishes (finishes not listed above)
- Split finishes

See page 17 for pricing. Exclusions may apply.

Matching elements

- Pg 168 Mortise lock functions
- Pg 152 Deadbolts
- Pg 154 Privacy Bolts
- Pg 156 Escutcheons with deadbolts
- Pg 160 Multi-Point Trim functions

European window lever style available in the same design. Call for pricing.



H 5014 Bernina

| | | |
|-------------------------------|------------|-------|
| Material | Collection | Group |
| Stainless steel AISI 316 L | Fusital | 6 |

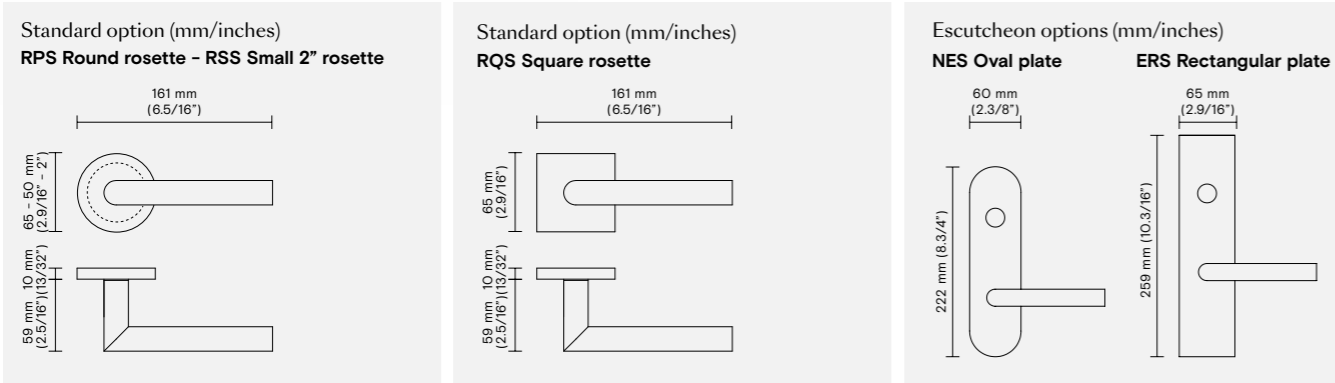

Conversions from metric to U.S. measurements are approximate.

Retail price

| Finish | Rosette | Function | | DMY R/L Single | ML-F Entry |
|-----------------------------|------------|-----------|-----------|----------------|-------------|
| | | PGE | PCY | | |
| 32 Polished stainless steel | RPS Round | \$ 467.00 | \$ 504.00 | \$ 227.00 | \$ 1,314.00 |
| | RQS Square | \$ 586.00 | \$ 623.00 | \$ 287.00 | \$ 1,340.00 |
| | RSS Round | \$ 422.00 | \$ 657.00 | \$ 192.00 | \$ 1,049.00 |
| 32D Satin stainless steel | RPS Round | \$ 403.00 | \$ 414.00 | \$ 200.00 | \$ 1,314.00 |
| | RQS Square | \$ 522.00 | \$ 533.00 | \$ 260.00 | \$ 1,340.00 |
| | RSS Round | \$ 360.00 | \$ 548.00 | \$ 166.00 | \$ 1,049.00 |

Note: The RSS Small round rosette does not fit a privacy pin. Supplied with 105. RSS Trims (2") note recommended for commercial use RSS privacy bolt.

Retail price

| Finish | Escutcheon | Function | | DMY R/L Single | DMY R/L Pair | ML-F Entry |
|---------------------------|-----------------|-----------|-----------|----------------|--------------|-------------|
| | | PGE | PCY | | | |
| 32D Satin stainless steel | NES Oval | \$ 785.00 | \$ 796.00 | \$ 387.00 | \$ 724.00 | \$ 1,163.00 |
| | ERS Rectangular | \$ 819.00 | \$ 833.00 | \$ 410.00 | \$ 772.00 | \$ 1,200.00 |

The options listed above are considered standard. Non-standard options are available upon request.

For more options on Rosettes and Escutcheon plates see page 23. For more options on Finishes see pages 12-13.

RE = Rectangular rosettes available for tubular latch application only. Add + \$ 30.00 LIST to the price of the RQ. For slim rosette and European version see pages 100-103.

Upcharges apply for the following special options:

- Extra thick door (> 2")
- Non-standard rosettes (rosettes not listed above)
- Non-standard finishes (finishes not listed above)
- Split finishes

See page 17 for pricing. Exclusions may apply.

Matching elements

- Pg 168 Mortise lock functions
- Pg 152 Deadbolts
- Pg 154 Privacy Bolts
- Pg 156 Escutcheons with deadbolts
- Pg 160 Multi-Point Trim functions

European window lever style available in the same design. Call for pricing.



H 5015 Antonio Citterio

| | | |
|-------------------------------|------------|-------|
| Material | Collection | Group |
| Stainless steel AISI 316 L | Fusital | 8 |

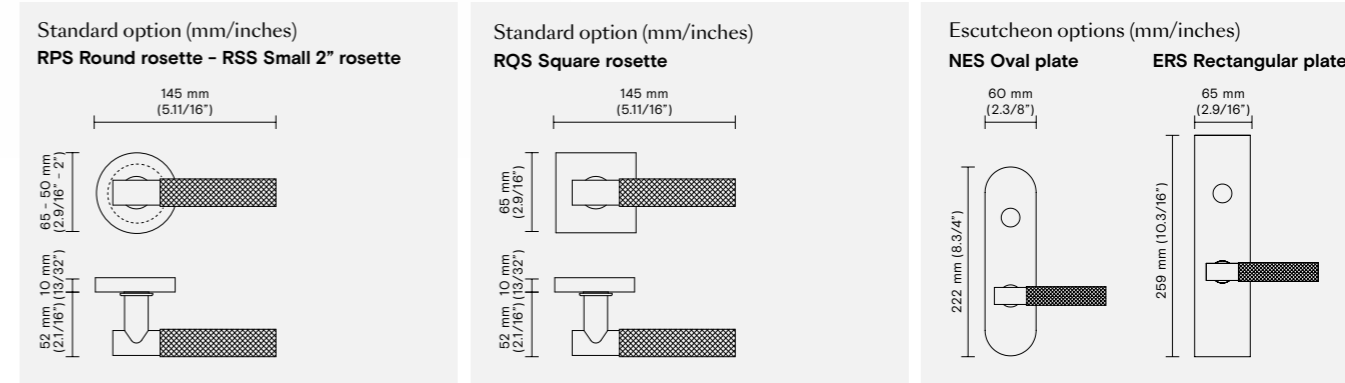

Conversions from metric to U.S. measurements are approximate.

Retail price

| Finish | Rosette | Function | | DMY R/L Single | ML-F Entry |
|-----------------------------|------------|-------------|-------------|----------------|-------------|
| | | PGE | PCY | | |
| 32 Polished stainless steel | RPS Round | \$ 1,109.00 | \$ 1,145.00 | \$ 549.00 | \$ 1,844.00 |
| | RQS Square | \$ 1,222.00 | \$ 1,258.00 | \$ 606.00 | \$ 1,869.00 |
| | RSS Round | \$ 1,070.00 | \$ 1,272.00 | \$ 517.00 | \$ 1,579.00 |
| 32D Satin stainless steel | RPS Round | \$ 880.00 | \$ 892.00 | \$ 427.00 | \$ 1,844.00 |
| | RQS Square | \$ 993.00 | \$ 1,006.00 | \$ 484.00 | \$ 1,869.00 |
| | RSS Round | \$ 852.00 | \$ 1,020.00 | \$ 408.00 | \$ 1,579.00 |

Note: The RSS Small round rosette does not fit a privacy pin. Supplied with 105. RSS Trims (2") note recommended for commercial use RSS privacy bolt.

Retail price

| Finish | Escutcheon | Function | | DMY R/L Single | DMY R/L Pair | ML-F Entry |
|---------------------------|-----------------|-------------|-------------|----------------|--------------|-------------|
| | | PGE | PCY | | | |
| 32D Satin stainless steel | NES Oval | \$ 1,264.00 | \$ 1,289.00 | \$ 633.00 | \$ 1,200.00 | \$ 1,617.00 |
| | ERS Rectangular | \$ 1,328.00 | \$ 1,340.00 | \$ 658.00 | \$ 1,251.00 | \$ 1,655.00 |

The options listed above are considered standard. Non-standard options are available upon request.

For more options on Rosettes and Escutcheon plates see page 23. For more options on Finishes see pages 12-13.

RE = Rectangular rosettes available for tubular latch application only. Add + \$ 30.00 LIST to the price of the RQ. For slim rosette and European version see pages 100-103.

Upcharges apply for the following special options:

- Extra thick door (> 2")
- Non-standard rosettes (rosettes not listed above)
- Non-standard finishes (finishes not listed above)
- Split finishes

See page 17 for pricing. Exclusions may apply.

Matching elements

- Pg 168 Mortise lock functions
- Pg 152 Deadbolts
- Pg 154 Privacy Bolts
- Pg 156 Escutcheons with deadbolts
- Pg 160 Multi-Point Trim functions

European window lever style available in the same design. Call for pricing.



H 5015 with leather Antonio Citterio

| | | |
|--|------------|-------|
| Material | Collection | Group |
| Stainless steel AISI 316 L + Leather | Fusital | 9 |

Standard option (mm/inches)
RPS Round rosette - RSS Small 2" rosette

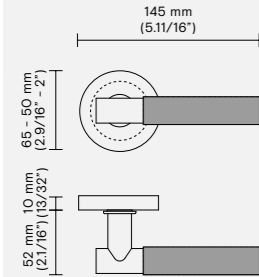

Standard option (mm/inches)
RQS Square rosette

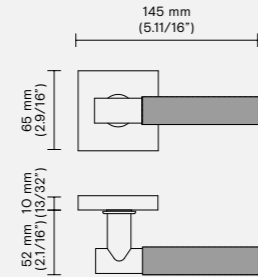

Escutcheon options (mm/inches)
NES Oval plate ERS Rectangular plate

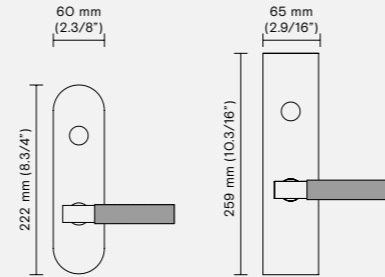

Conversions from metric to U.S. measurements are approximate.

Retail price

| Finish | Rosette | Function | | DMY R/L Single | ML-F Entry |
|---|------------|-------------|-------------|----------------|-------------|
| | | PGE | PCY | | |
| 32/BLK Polished stainless steel / Black leather | RPS Round | \$ 1,401.00 | \$ 1,440.00 | \$ 700.00 | \$ 2,299.00 |
| | RQS Square | \$ 1,515.00 | \$ 1,553.00 | \$ 757.00 | \$ 2,464.00 |
| | RSS Round | \$ 1,381.00 | \$ 1,566.00 | \$ 673.00 | \$ 2,009.00 |
| 32/ORNG Polished stainless steel / Orange leather | RPS Round | \$ 1,401.00 | \$ 1,440.00 | \$ 700.00 | \$ 2,299.00 |
| | RQS Square | \$ 1,515.00 | \$ 1,553.00 | \$ 757.00 | \$ 2,464.00 |
| | RSS Round | \$ 1,381.00 | \$ 1,566.00 | \$ 673.00 | \$ 2,009.00 |
| 32D/BLK Satin stainless steel / Black leather | RPS Round | \$ 1,337.00 | \$ 1,376.00 | \$ 668.00 | \$ 2,299.00 |
| | RQS Square | \$ 1,451.00 | \$ 1,489.00 | \$ 725.00 | \$ 2,464.00 |
| | RSS Round | \$ 1,317.00 | \$ 1,502.00 | \$ 641.00 | \$ 2,009.00 |
| 32D/ORNG Satin stainless steel / Orange leather | RPS Round | \$ 1,337.00 | \$ 1,376.00 | \$ 668.00 | \$ 2,299.00 |
| | RQS Square | \$ 1,451.00 | \$ 1,489.00 | \$ 725.00 | \$ 2,464.00 |
| | RSS Round | \$ 1,317.00 | \$ 1,502.00 | \$ 641.00 | \$ 2,009.00 |

Note: The RSS Small round rosette does not fit a privacy pin. Supplied with 105. RSS Trims (2") note recommended for commercial use RSS privacy bolt.

Retail price

| Finish | Escutcheon | Function | | DMY R/L Single | DMY R/L Pair | ML-F Entry |
|---|-----------------|-------------|-------------|----------------|--------------|-------------|
| | | PGE | PCY | | | |
| 32D/BLK Satin stainless steel / Black leather | NES Oval | \$ 1,627.00 | \$ 1,674.00 | \$ 809.00 | \$ 1,567.00 | \$ 2,059.00 |
| | ERS Rectangular | \$ 1,687.00 | \$ 1,747.00 | \$ 844.00 | \$ 1,627.00 | \$ 2,101.00 |
| 32D/ORNG Satin stainless steel / Orange leather | NES Oval | \$ 1,627.00 | \$ 1,674.00 | \$ 809.00 | \$ 1,567.00 | \$ 2,059.00 |
| | ERS Rectangular | \$ 1,687.00 | \$ 1,747.00 | \$ 844.00 | \$ 1,627.00 | \$ 2,101.00 |

The options listed above are considered standard. Non-standard options are available upon request.

For more options on Rosettes and Escutcheon plates see page 23. For more options on Finishes see pages 12-13.

RE = Rectangular rosettes available for tubular latch application only. Add + \$ 30.00 LIST to the price of the RQ. For slim rosette and European version see pages 100-103.

Upcharges apply for the following special options:

- Extra thick door (> 2")
- Non-standard rosettes (rosettes not listed above)
- Non-standard finishes (finishes not listed above)
- Split finishes

See page 17 for pricing. Exclusions may apply.

Matching elements

- Pg 168 Mortise lock functions
- Pg 152 Deadbolts
- Pg 154 Privacy Bolts
- Pg 156 Escutcheons with deadbolts
- Pg 160 Multi-Point Trim functions

European window lever style available in the same design. Call for pricing.



H 5017 Hans Kollhoff

| | | |
|-------------------------------|------------|-------|
| Material | Collection | Group |
| Stainless steel AISI 316 L | Fusital | 8 |

Standard option (mm/inches)
RPS Round rosette - RSS Small 2" rosette

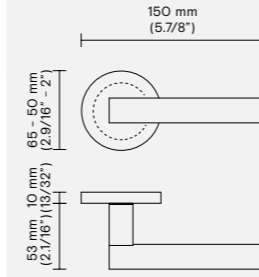

Standard option (mm/inches)
RQS Square rosette

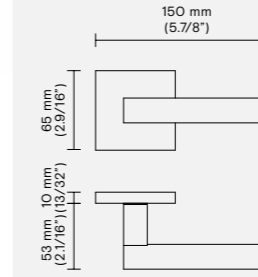

Escutcheon options (mm/inches)
NES Oval plate ERS Rectangular plate

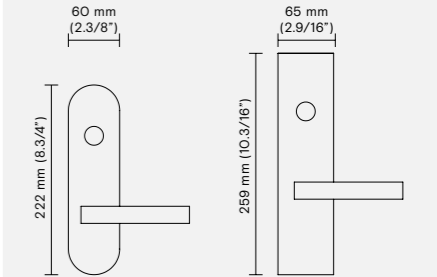

Conversions from metric to U.S. measurements are approximate.

Retail price

| Finish | Rosette | Function | | DMY R/L Single | ML-F Entry |
|-----------------------------|------------|-------------|-------------|----------------|-------------|
| | | PGE | PCY | | |
| 32 Polished stainless steel | RPS Round | \$ 1,255.00 | \$ 1,295.00 | \$ 616.00 | \$ 1,844.00 |
| | RQS Square | \$ 1,374.00 | \$ 1,414.00 | \$ 675.00 | \$ 1,869.00 |
| | RSS Round | \$ 1,207.00 | \$ 1,437.00 | \$ 577.00 | \$ 1,579.00 |
| 32D Satin stainless steel | RPS Round | \$ 987.00 | \$ 998.00 | \$ 483.00 | \$ 1,844.00 |
| | RQS Square | \$ 1,105.00 | \$ 1,117.00 | \$ 543.00 | \$ 1,869.00 |
| | RSS Round | \$ 942.00 | \$ 1,143.00 | \$ 459.00 | \$ 1,579.00 |

Note: The RSS Small round rosette does not fit a privacy pin. Supplied with 105. RSS Trims (2") note recommended for commercial use RSS privacy bolt.

Retail price

| Finish | Escutcheon | Function | | DMY R/L Single | DMY R/L Pair | ML-F Entry |
|---------------------------|-----------------|-------------|-------------|----------------|--------------|-------------|
| | | PGE | PCY | | | |
| 32D Satin stainless steel | NES Oval | \$ 1,264.00 | \$ 1,289.00 | \$ 633.00 | \$ 1,200.00 | \$ 1,617.00 |
| | ERS Rectangular | \$ 1,328.00 | \$ 1,340.00 | \$ 658.00 | \$ 1,251.00 | \$ 1,655.00 |

The options listed above are considered standard. Non-standard options are available upon request.

For more options on Rosettes and Escutcheon plates see page 23. For more options on Finishes see pages 12-13.

RE = Rectangular rosettes available for tubular latch application only. Add + \$ 30.00 LIST to the price of the RQ. For slim rosette and European version see pages 100-103.

Upcharges apply for the following special options:

- Extra thick door (> 2")
- Non-standard rosettes (rosettes not listed above)
- Non-standard finishes (finishes not listed above)
- Split finishes

See page 17 for pricing. Exclusions may apply.

Matching elements

- Pg 168 Mortise lock functions
- Pg 152 Deadbolts
- Pg 154 Privacy Bolts
- Pg 156 Escutcheons with deadbolts
- Pg 160 Multi-Point Trim functions

European window lever style available in the same design. Call for pricing.

EUROPEAN TRIM – Rosette diameter 2” (50mm), thickness 13/32” (10mm)

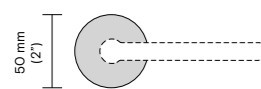

Round 50 mm (2")
RS50 Round rosette brass
RSS50 Round rosette stainless steel

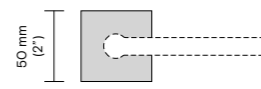

Square 50 mm (2")
RSQ50 Square rosette brass
RSQS50 Square rosette stainless steel

Conversions from metric to U.S. measurements are approximate.

Group 1

H 198, H 1003, H 1022, H 1024, H 1050, H 4730, H 4742, K 1155, K 1168, K 1170

| Model | Retail price | |
|---|---------------|----------------|
| | Round rosette | Square rosette |
| R8Y (PGE) | \$ 319.00 | \$ 444.00 |
| R8 BZG (PCY with PCY thumb turn) | \$ 680.00 | \$ 804.00 |

Group 2

H 165, H 176, H 1016, H 1026, H 1027, H 1044 U, H 1045, H 1046, H 1049, H 1052, H 1054, H 1056, H 1057, H 1061, H 1062, H 1066

| Model | Retail price | |
|---|---------------|----------------|
| | Round rosette | Square rosette |
| R8Y (PGE) | \$ 394.00 | \$ 519.00 |
| R8 BZG (PCY with PCY thumb turn) | \$ 754.00 | \$ 880.00 |

Group 3

H 1039, H 1040, H 1060, H 1068, H 1069, H 1748, K 1054, K 1056, K 1060, K 1061, K 1171, K 1730

| Model | Retail price | |
|---|---------------|----------------|
| | Round rosette | Square rosette |
| R8Y (PGE) | \$ 606.00 | \$ 741.00 |
| R8 BZG (PCY with PCY thumb turn) | \$ 967.00 | \$ 1,078.00 |

Group 4

H 163, H 192, H 1004, H 1037, H 1043, H 1044, H 1058, H 411, H 414, H 415, H 416, H 419

| Model | Retail price | |
|---|---------------|----------------|
| | Round rosette | Square rosette |
| R8Y (PGE) | \$ 280.00 | \$ 405.00 |
| R8 BZG (PCY with PCY thumb turn) | \$ 642.00 | \$ 766.00 |

Group 5

H 315, H 317, H 327, H 330, H 334, H 338, H 348, H 361, H 364, H 367, H 368, H 370, H 372, H 381, H 382, H 383, H 385, H 386, K 383

| Model | Retail price | |
|---|---------------|----------------|
| | Round rosette | Square rosette |
| R8Y (PGE) | \$ 455.00 | \$ 579.00 |
| R8 BZG (PCY with PCY thumb turn) | \$ 804.00 | \$ 929.00 |

The configuration above is only suitable for European mortise locks. The lock is not included in the prices. European mortise locks (mechanical and magnetic) can be purchased separately. Call for pricing.

The prices above are for the standard finishes of each lever listed. See corresponding catalog pages. Different finishes are available upon request. See pages 12-13 for more finish options.

The privacy sets are supplied with the European privacy thumb turn: K1704 R678 50 BZG (round) or K1225 R678 50 BZG (square).

EUROPEAN TRIM – Rosette diameter 2” (50mm), thickness 13/32” (10mm)

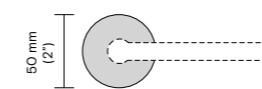

Round 50 mm (2") - Thickness 10 mm
RS50 Round rosette brass
RSS50 Round rosette stainless steel

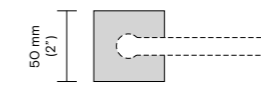

Square 50 mm (2") - Thickness 10 mm
RSQ50 Square rosette brass
RSQS50 Square rosette stainless steel

Conversions from metric to U.S. measurements are approximate.

Group 6

H 311, H 329, H 335, H 343, H 359, H 376, H 378, H 384, H 5014, K 378

| Model | Retail price | |
|---|--------------|-------------|
| | RP/RPS | RQ/RQS |
| R8Y (PGE) | \$ 580.00 | \$ 706.00 |
| R8 BZG (PCY with PCY thumb turn) | \$ 943.00 | \$ 1,068.00 |

Group 7

H 377, H 5008, K 5301, K 377

| Model | Retail price | |
|---|--------------|-------------|
| | RP/RPS | RQ/RQS |
| R8Y (PGE) | \$ 924.00 | \$ 1,048.00 |
| R8 BZG (PCY with PCY thumb turn) | \$ 1,296.00 | \$ 1,442.00 |

Group 8

H 356, H 379, H 380, H 5015/32D, H 5017

| Model | Retail price | |
|---|--------------|-------------|
| | RP/RPS | RQ/RQS |
| R8Y (PGE) | \$ 985.00 | \$ 1,079.00 |
| R8 BZG (PCY with PCY thumb turn) | \$ 1,393.00 | \$ 1,512.00 |

Group 9

H 5015 Black Leather, H 5015 Orange Leather

| Model | Retail price | |
|---|--------------|-------------|
| | RP/RPS | RQ/RQS |
| R8Y (PGE) | \$ 985.00 | \$ 1,079.00 |
| R8 BZG (PCY with PCY thumb turn) | \$ 1,393.00 | \$ 1,512.00 |

The configuration above is only suitable for European mortise locks. The lock is not included in the prices. European mortise locks (mechanical and magnetic) can be purchased separately. Call for pricing.

The prices above are for the standard finishes of each lever listed. See corresponding catalog pages. Different finishes are available upon request. See pages 12-13 for more finish options.

The privacy sets are supplied with the European privacy thumb turn: K1704 R678 50 BZG (round) or K1225 R678 50 BZG (square).

SLIM ROSETTES – Rosette diameter 2” (50mm), thickness 3/16” (5mm)



Valli offers special slim rosettes = 3/16” (5mm) exclusively for the models below. To order, select a lever/knob and use the code RSB (round) or RSBQ (square). For privacy bolt only price see page 154.

Group 1

H 198, H 1003, H 1022, H 1024, H 1050, H 4730, H 4742, K 1155, K 1168, K 1170

| Model | Retail price | |
|----------------------------------|--------------|-----------|
| | RSB | RSBQ |
| R8Y (PGE) | \$ 364.00 | \$ 490.00 |
| R8 BZG (PCY with PCY thumb turn) | \$ 776.00 | \$ 901.00 |
| Dummy RH or LH | \$ 164.00 | \$ 215.00 |

Group 2

H 1026, H 1045, H 1046, H 1049, H 1052, H 1054, H 1056, H 1061, H 1062, H 1066

| Model | Retail price | |
|----------------------------------|--------------|-----------|
| | RSB | RSBQ |
| R8Y (PGE) | \$ 439.00 | \$ 564.00 |
| R8 BZG (PCY with PCY thumb turn) | \$ 852.00 | \$ 976.00 |
| Dummy RH or LH | \$ 201.00 | \$ 264.00 |

Group 3

H 1039, H 1040, H 1060, H 1068, H 1069, H 1748, K 1054, K 1056, K 1060, K 1061, K 1171

| Model | Retail price | |
|----------------------------------|--------------|-------------|
| | RSB | RSBQ |
| R8Y (PGE) | \$ 652.00 | \$ 776.00 |
| R8 BZG (PCY with PCY thumb turn) | \$ 1,026.00 | \$ 1,078.00 |
| Dummy RH or LH | \$ 315.00 | \$ 359.00 |

Group 4

H 163, H 192, H 1043, H 1044, H 1058

| Model | Retail price | |
|----------------------------------|--------------|-----------|
| | RSB | RSBQ |
| R8Y (PGE) | \$ 324.00 | \$ 451.00 |
| R8 BZG (PCY with PCY thumb turn) | \$ 739.00 | \$ 863.00 |
| Dummy RH or LH | \$ 152.00 | \$ 213.00 |

Group 5

H 315, H 317, H 327, H 330, H 334, H 338, H 348, H 361, H 364, H 367, H 368, H 370, H 372, H 381, H 382, H 383, H 385, H 386, K 383

| Model | Retail price | |
|----------------------------------|--------------|-------------|
| | RSB | RSBQ |
| R8Y (PGE) | \$ 501.00 | \$ 626.00 |
| R8 BZG (PCY with PCY thumb turn) | \$ 901.00 | \$ 1,026.00 |
| Dummy RH or LH | \$ 238.00 | \$ 301.00 |

The configuration above is only suitable for European mortise locks. The lock is not included in the prices. European mortise locks (mechanical and magnetic) can be purchased separately. Call for pricing.

The prices above are for the standard finishes of each lever listed. See corresponding catalog pages. Different finishes are available upon request. See pages 12-13 for more finish options.

The privacy sets are supplied with the European privacy thumb turn: K1704 R678 50 BZG (round) or K1225 R678 50 BZG (square).

SLIM ROSETTES – Rosette diameter 2” (50mm), thickness 3/16” (5mm)

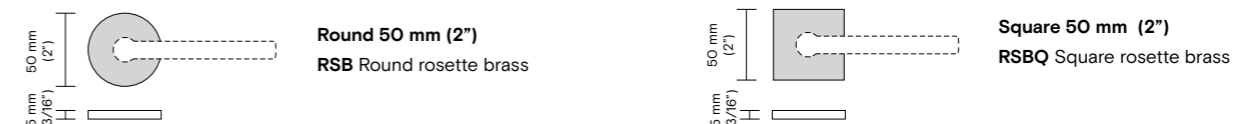

Valli offers special slim rosettes = 3/16” (5mm) exclusively for the models below. To order, select a lever/knob and use the code RSB (round) or RSBQ (square). For privacy bolt only price see page 154.

Group 6

H 311, H 329, H 343, H 359, H 378, H 384, K 378

| Model | Retail price | |
|----------------------------------|--------------|-------------|
| | RSB | RSBQ |
| R8Y (PGE) | \$ 627.00 | \$ 751.00 |
| R8 BZG (PCY with PCY thumb turn) | \$ 1,039.00 | \$ 1,164.00 |
| Dummy RH or LH | \$ 301.00 | \$ 363.00 |

Group 7

H 377, K 377

| Model | Retail price | |
|----------------------------------|--------------|-------------|
| | RSB | RSBQ |
| R8Y (PGE) | \$ 1,014.00 | \$ 1,139.00 |
| R8 BZG (PCY with PCY thumb turn) | \$ 1,413.00 | \$ 1,538.00 |
| Dummy RH or LH | \$ 490.00 | \$ 551.00 |

Group 8

H 356, H 379, H 380

| Model | Retail price | |
|----------------------------------|--------------|-------------|
| | RSB | RSBQ |
| R8Y (PGE) | \$ 1,076.00 | \$ 1,201.00 |
| R8 BZG (PCY with PCY thumb turn) | \$ 1,489.00 | \$ 1,614.00 |
| Dummy RH or LH | \$ 526.00 | \$ 588.00 |

The configuration above is only suitable for European mortise locks. The lock is not included in the prices. European mortise locks (mechanical and magnetic) can be purchased separately. Call for pricing.

The prices above are for the standard finishes of each lever listed. See corresponding catalog pages. Different finishes are available upon request. See pages 12-13 for more finish options.

The privacy sets are supplied with the European privacy thumb turn: K1704 R678 50 BZG (round) or K1225 R678 50 BZG (square).

Door accessories





K 377 Steve Leung

| | | |
|----------|------------|-------|
| Material | Collection | Group |
| Brass | Fusital | 7 |

Standard option (mm/inches) RQ Square rosette

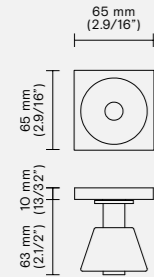

Standard option (mm/inches) RP Round rosette

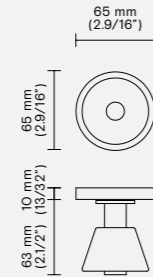

Escutcheon options (mm/inches)

EP Oval plate ER Rectangular plate

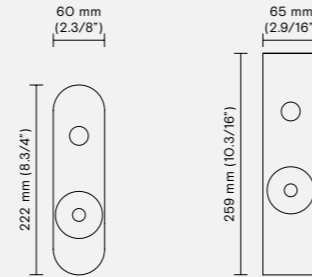

Slim rosette available - See pages 102-103

*Only available on request
Conversions from metric to U.S. measurements are approximate.

Retail price

| Finish | Rosette | Function | | DMY R/L Single | ML-F Entry |
|----------------|-----------|-----------|-----------|----------------|-------------|
| | | PGE | PCY | | |
| 03M Matt brass | RP Round | \$ 512.00 | \$ 526.00 | \$ 249.00 | \$ 1,617.00 |
| | RQ Square | \$ 643.00 | \$ 658.00 | \$ 310.00 | \$ 1,755.00 |
| 16 Dull black | RP Round | \$ 429.00 | \$ 440.00 | \$ 210.00 | \$ 1,617.00 |
| | RQ Square | \$ 539.00 | \$ 552.00 | \$ 261.00 | \$ 1,755.00 |
| 56 Dark bronze | RP Round | \$ 520.00 | \$ 547.00 | \$ 253.00 | \$ 1,617.00 |
| | RQ Square | \$ 896.00 | \$ 907.00 | \$ 442.00 | \$ 1,755.00 |

The options listed above are considered standard.
Non-standard options are available upon request.

For more options on Rosettes and Escutcheon plates see page 23.
For more options on Finishes see pages 12-13.
RE = Rectangular rosettes available for tubular latch application only.
Add + \$ 30.00 LIST to the price of the RQ.
For slim rosette (European version) see pages 100-103.

Upcharges apply for the following special options:

- Extra thick door (> 2")
- Non-standard rosettes (rosettes not listed above)
- Non-standard finishes (finishes not listed above)
- Split finishes

See page 17 for pricing. Exclusions may apply.



K 378 Yabu Pushelberg

| | | |
|----------|------------|-------|
| Material | Collection | Group |
| Brass | Fusital | 6 |

Standard option (mm/inches) RP Round rosette

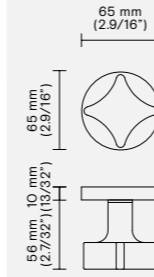

Standard option (mm/inches) RQ Square rosette

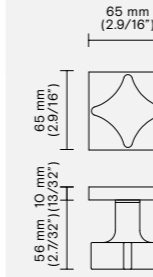

Escutcheon options (mm/inches)

EP Oval plate ER Rectangular plate

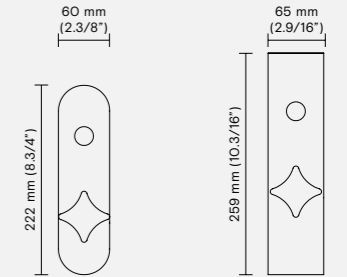

Slim rosette available - See pages 102-103

Conversions from metric to U.S. measurements are approximate.

Retail price

| Finish | Rosette | Function | | DMY R/L Single | ML-F Entry |
|---------------------------|-----------|-----------|-----------|----------------|-------------|
| | | PGE | PCY | | |
| 17A Polished black nickel | RP Round | \$ 520.00 | \$ 545.00 | \$ 252.00 | \$ 1,213.00 |
| | RQ Square | \$ 861.00 | \$ 872.00 | \$ 428.00 | \$ 1,389.00 |
| 26 Polished chrome | RP Round | \$ 451.00 | \$ 464.00 | \$ 270.00 | \$ 1,213.00 |
| | RQ Square | \$ 565.00 | \$ 579.00 | \$ 273.00 | \$ 1,389.00 |
| 56 Dark bronze | RP Round | \$ 520.00 | \$ 545.00 | \$ 252.00 | \$ 1,213.00 |
| | RQ Square | \$ 861.00 | \$ 872.00 | \$ 428.00 | \$ 1,389.00 |

Retail price

| Finish | Escutcheon | Function | | DMY R/L Single | DMY R/L Pair | ML-F Entry |
|--------------------|----------------|-----------|-----------|----------------|--------------|-------------|
| | | PGE | PCY | | | |
| 26 Polished chrome | EP Oval | \$ 785.00 | \$ 796.00 | \$ 387.00 | \$ 724.00 | \$ 1,163.00 |
| | ER Rectangular | \$ 819.00 | \$ 833.00 | \$ 410.00 | \$ 772.00 | \$ 1,200.00 |

The options listed above are considered standard.
Non-standard options are available upon request.

For more options on Rosettes and Escutcheon plates see page 23.
For more options on Finishes see pages 12-13.
RE = Rectangular rosettes available for tubular latch application only.
Add + \$ 30.00 LIST to the price of the RQ.
For slim rosette (European version) see pages 100-103.

Upcharges apply for the following special options:

- Extra thick door (> 2")
- Non-standard rosettes (rosettes not listed above)
- Non-standard finishes (finishes not listed above)
- Split finishes

See page 17 for pricing. Exclusions may apply.



K 383 Perkins&Will

| | | |
|----------|------------|-------|
| Material | Collection | Group |
| Brass | Fusital | 5 |

Standard option (mm/inches)

RP Round rosette

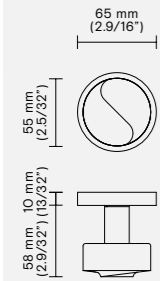

Standard option (mm/inches)

RQ Square rosette

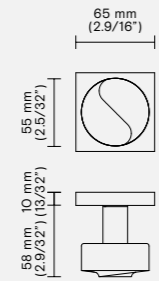

Escutcheon options (mm/inches)

EP Oval plate

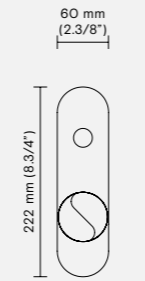

ER Rectangular plate

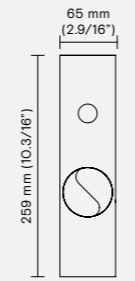

Conversions from metric to U.S. measurements are approximate.

Slim rosette available - See pages 102-103

Retail price

| Finish | Rosette | Function PGE | PCY | DMY R/L Single | ML-F Entry |
|------------------|-----------|--------------|-----------|----------------|-------------|
| 15 Satin nickel | RP Round | \$ 623.00 | \$ 683.00 | \$ 320.00 | \$ 1,213.00 |
| | RQ Square | \$ 754.00 | \$ 782.00 | \$ 386.00 | \$ 1,389.00 |
| 16 Dull black | RP Round | \$ 530.00 | \$ 573.00 | \$ 259.00 | \$ 1,213.00 |
| | RQ Square | \$ 659.00 | \$ 702.00 | \$ 323.00 | \$ 1,389.00 |
| 26D Satin chrome | RP Round | \$ 594.00 | \$ 626.00 | \$ 293.00 | \$ 1,213.00 |
| | RQ Square | \$ 734.00 | \$ 767.00 | \$ 373.00 | \$ 1,389.00 |
| 56 Dark bronze | RP Round | \$ 647.00 | \$ 702.00 | \$ 335.00 | \$ 1,213.00 |
| | RQ Square | \$ 777.00 | \$ 832.00 | \$ 465.00 | \$ 1,389.00 |

Retail price

| Finish | Escutcheon | Function PGE | PCY | DMY R/L Single | DMY R/L Pair | ML-F Entry |
|------------------|----------------|--------------|-----------|----------------|--------------|-------------|
| 26D Satin chrome | EP Oval | \$ 683.00 | \$ 696.00 | \$ 330.00 | \$ 607.00 | \$ 1,037.00 |
| | ER Rectangular | \$ 734.00 | \$ 747.00 | \$ 369.00 | \$ 671.00 | \$ 1,075.00 |

The options listed above are considered standard. Non-standard options are available upon request.

For more options on Rosettes and Escutcheon plates see page 23. For more options on Finishes see pages 12-13.
RE = Rectangular rosettes available for tubular latch application only. Add + \$ 30.00 LIST to the price of the RQ.
For slim rosette (European version) see pages 100-103.

Upcharges apply for the following special options:

- Extra thick door (> 2")
- Non-standard rosettes (rosettes not listed above)
- Non-standard finishes (finishes not listed above)
- Split finishes

See page 17 for pricing. Exclusions may apply.



K 1054 W.W.

| | | |
|----------|------------|-------|
| Material | Collection | Group |
| Aluminum | Lab | 3 |

Standard option (mm/inches)

RP Round rosette



Standard option (mm/inches)

RQ Square rosette

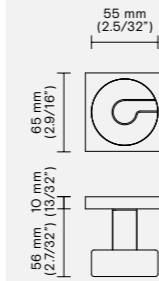

Escutcheon options (mm/inches)

EP Oval plate

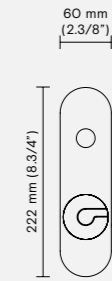

ER Rectangular plate

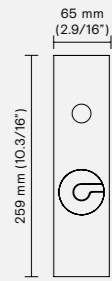

Conversions from metric to U.S. measurements are approximate.

Slim rosette available - See pages 102-103

Retail price

| Finish | Rosette | Function PGE | PCY | DMY R/L Single | ML-F Entry |
|--------------------|-----------|--------------|-----------|----------------|-------------|
| 03M Matt brass | RP Round | \$ 525.00 | \$ 551.00 | \$ 260.00 | \$ 1,251.00 |
| | RQ Square | \$ 607.00 | \$ 615.00 | \$ 290.00 | \$ 1,389.00 |
| 15 Satin nickel | RP Round | \$ 528.00 | \$ 550.00 | \$ 261.00 | \$ 1,251.00 |
| | RQ Square | \$ 645.00 | \$ 679.00 | \$ 337.00 | \$ 1,389.00 |
| 16 Dull black | RP Round | \$ 496.00 | \$ 521.00 | \$ 246.00 | \$ 1,251.00 |
| | RQ Square | \$ 575.00 | \$ 582.00 | \$ 274.00 | \$ 1,389.00 |
| 26 Polished chrome | RP Round | \$ 509.00 | \$ 528.00 | \$ 250.00 | \$ 1,251.00 |
| | RQ Square | \$ 621.00 | \$ 655.00 | \$ 318.00 | \$ 1,389.00 |

Retail price

| Finish | Escutcheon | Function PGE | PCY | DMY R/L Single | DMY R/L Pair | ML-F Entry |
|--------------------|----------------|--------------|-----------|----------------|--------------|-------------|
| 26 Polished chrome | EP Oval | \$ 809.00 | \$ 823.00 | \$ 405.00 | \$ 747.00 | \$ 1,200.00 |
| | ER Rectangular | \$ 859.00 | \$ 873.00 | \$ 430.00 | \$ 798.00 | \$ 1,226.00 |

The options listed above are considered standard. Non-standard options are available upon request.

For more options on Rosettes and Escutcheon plates see page 23. For more options on Finishes see pages 12-13.
RE = Rectangular rosettes available for tubular latch application only. Add + \$ 30.00 LIST to the price of the RQ.
For slim rosette (European version) see pages 100-103.

Upcharges apply for the following special options:

- Extra thick door (> 2")
- Non-standard rosettes (rosettes not listed above)
- Non-standard finishes (finishes not listed above)
- Split finishes

See page 17 for pricing. Exclusions may apply.



K 1056 Quadra

| | | |
|----------|------------|-------|
| Material | Collection | Group |
| Aluminum | Lab | 3 |

Standard option (mm/inches) RQ Square rosette

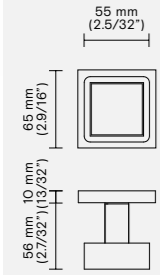

Standard option (mm/inches) RP Round rosette

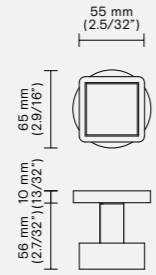

Escutcheon options (mm/inches) EP Oval plate ER Rectangular plate

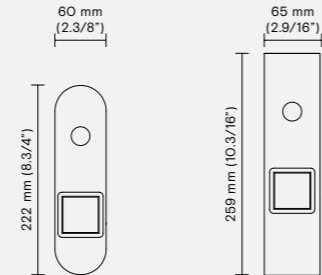

Conversions from metric to U.S. measurements are approximate.

Slim rosette available - See pages 102-103

Retail price

| Finish | Rosette | Function | | DMY R/L Single | ML-F Entry |
|--------------------|-----------|-----------|-----------|----------------|-------------|
| | | PGE | PCY | | |
| 26 Polished chrome | RP Round | \$ 556.00 | \$ 579.00 | \$ 273.00 | \$ 1,251.00 |
| | RQ Square | \$ 674.00 | \$ 698.00 | \$ 332.00 | \$ 1,389.00 |
| 26D Satin chrome | RP Round | \$ 556.00 | \$ 579.00 | \$ 273.00 | \$ 1,251.00 |
| | RQ Square | \$ 674.00 | \$ 698.00 | \$ 332.00 | \$ 1,389.00 |

Retail price

| Finish | Escutcheon | Function | | DMY R/L Single | DMY R/L Pair | ML-F Entry |
|--------------------|----------------|-----------|-----------|----------------|--------------|-------------|
| | | PGE | PCY | | | |
| 26 Polished chrome | EP Oval | \$ 809.00 | \$ 823.00 | \$ 405.00 | \$ 747.00 | \$ 1,200.00 |
| | ER Rectangular | \$ 859.00 | \$ 873.00 | \$ 430.00 | \$ 798.00 | \$ 1,226.00 |
| 26D Satin chrome | EP Oval | \$ 809.00 | \$ 823.00 | \$ 405.00 | \$ 747.00 | \$ 1,200.00 |
| | ER Rectangular | \$ 859.00 | \$ 873.00 | \$ 430.00 | \$ 798.00 | \$ 1,226.00 |

The options listed above are considered standard. Non-standard options are available upon request.

For more options on Rosettes and Escutcheon plates see page 23. For more options on Finishes see pages 12-13.
RE = Rectangular rosettes available for tubular latch application only. Add + \$ 30.00 LIST to the price of the RQ.
For slim rosette (European version) see pages 100-103.

Upcharges apply for the following special options:

- Extra thick door (> 2")
- Non-standard rosettes (rosettes not listed above)
- Non-standard finishes (finishes not listed above)
- Split finishes

See page 17 for pricing. Exclusions may apply.

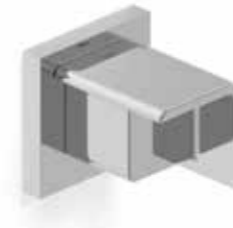

K 1060 SOM - Skidmore, Owings & Merrill

| | | |
|----------|------------|-------|
| Material | Collection | Group |
| Brass | Fusital | 3 |

Standard option (mm/inches) RQ Square rosette

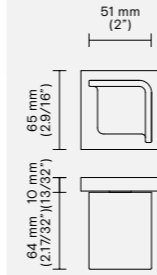

Standard option (mm/inches) RP Round rosette

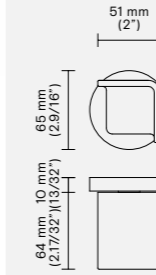

Escutcheon options (mm/inches) EP Oval plate ER Rectangular plate

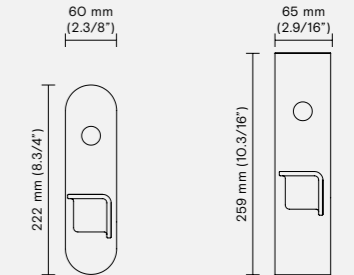

Conversions from metric to U.S. measurements are approximate.

Slim rosette available - See pages 102-103

Retail price

| Finish | Rosette | Function | | DMY R/L Single | ML-F Entry |
|--------------------|-----------|-----------|-----------|----------------|-------------|
| | | PGE | PCY | | |
| 16 Dull black | RP Round | \$ 456.00 | \$ 694.00 | \$ 240.00 | \$ 1,251.00 |
| | RQ Square | \$ 480.00 | \$ 718.00 | \$ 253.00 | \$ 1,389.00 |
| 26 Polished chrome | RP Round | \$ 570.00 | \$ 807.00 | \$ 251.00 | \$ 1,251.00 |
| | RQ Square | \$ 600.00 | \$ 837.00 | \$ 265.00 | \$ 1,389.00 |
| 26D Satin chrome | RP Round | \$ 570.00 | \$ 807.00 | \$ 251.00 | \$ 1,251.00 |
| | RQ Square | \$ 600.00 | \$ 837.00 | \$ 265.00 | \$ 1,389.00 |

Note: Due to the design of the knob, it is not possible to be installed on a round rosette or oval plate.

Retail price

| Finish | Escutcheon | Function | | DMY R/L Single | DMY R/L Pair | ML-F Entry |
|--------------------|----------------|-----------|-----------|----------------|--------------|-------------|
| | | PGE | PCY | | | |
| 26 Polished chrome | EP Oval | \$ 772.00 | \$ 785.00 | \$ 387.00 | \$ 712.00 | \$ 1,200.00 |
| | ER Rectangular | \$ 819.00 | \$ 833.00 | \$ 410.00 | \$ 761.00 | \$ 1,226.00 |
| 26D Satin chrome | EP Oval | \$ 772.00 | \$ 785.00 | \$ 387.00 | \$ 712.00 | \$ 1,200.00 |
| | ER Rectangular | \$ 819.00 | \$ 833.00 | \$ 410.00 | \$ 761.00 | \$ 1,226.00 |

Note: Due to the special design of the knob, the EP/Oval escutcheon plate option is not available on this lever.

The options listed above are considered standard. Non-standard options are available upon request.

For more options on Rosettes and Escutcheon plates see page 23. For more options on Finishes see pages 12-13.
RE = Rectangular rosettes available for tubular latch application only. Add + \$ 30.00 LIST to the price of the RQ.
For slim rosette (European version) see pages 100-103.

Upcharges apply for the following special options:

- Extra thick door (> 2")
- Non-standard rosettes (rosettes not listed above)
- Non-standard finishes (finishes not listed above)
- Split finishes

See page 17 for pricing. Exclusions may apply.



K 1061

Di Virgilio Veneziano

| | | |
|----------|------------|-------|
| Material | Collection | Group |
| Brass | Fusital | 3 |

Standard option (mm/inches)

RP Round rosette

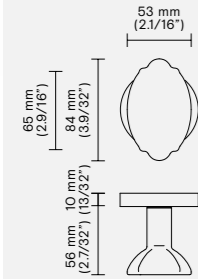

Standard option (mm/inches)

RQ Square rosette

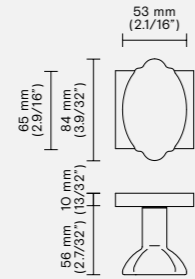

Escutcheon options (mm/inches)*

EP Oval plate

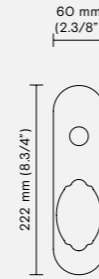

ER Rectangular plate

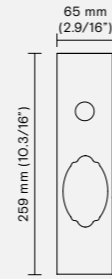

Slim rosette available - See pages 102-103

*Only available on request
Conversions from metric to U.S. measurements are approximate.

Retail price

| Finish | Rosette | Function | | DMY R/L Single | ML-F Entry |
|---------------------------|-----------|-----------|-----------|----------------|-------------|
| | | PGE | PCY | | |
| O3D Satin brass | RP Round | \$ 509.00 | \$ 519.00 | \$ 251.00 | \$ 1,251.00 |
| | RQ Square | \$ 575.00 | \$ 588.00 | \$ 282.00 | \$ 1,389.00 |
| O6M Matt bronze | RP Round | \$ 509.00 | \$ 519.00 | \$ 252.00 | \$ 1,251.00 |
| | RQ Square | \$ 575.00 | \$ 588.00 | \$ 282.00 | \$ 1,389.00 |
| 17A Polished black nickel | RP Round | \$ 636.00 | \$ 648.00 | \$ 319.00 | \$ 1,251.00 |
| | RQ Square | \$ 719.00 | \$ 736.00 | \$ 353.00 | \$ 1,389.00 |

The options listed above are considered standard. Non-standard options are available upon request.

For more options on Rosettes and Escutcheon plates see page 23. For more options on Finishes see pages 12-13.
RE = Rectangular rosettes available for tubular latch application only. Add + \$ 30.00 LIST to the price of the RQ.
For slim rosette (European version) see pages 100-103.

Upcharges apply for the following special options:

- Extra thick door (> 2")
- Non-standard rosettes (rosettes not listed above)
- Non-standard finishes (finishes not listed above)
- Split finishes

See page 17 for pricing. Exclusions may apply.



K 1155

| | | |
|----------|------------|-------|
| Material | Collection | Group |
| Brass | Lab | 1 |

Standard option (mm/inches)

RP Round rosette

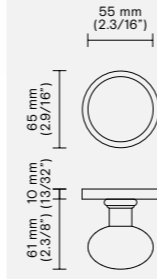

Standard option (mm/inches)

RQ Square rosette

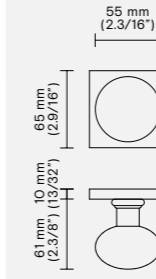

Escutcheon options (mm/inches)

EP Oval plate

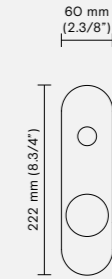

ER Rectangular plate

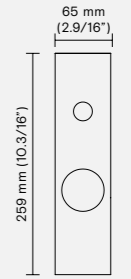

Conversions from metric to U.S. measurements are approximate.

Retail price

| Finish | Rosette | Function | | DMY R/L Single | ML-F Entry |
|--------------------|-----------|-----------|-----------|----------------|-------------|
| | | PGE | PCY | | |
| O3 Polished brass | RP Round | \$ 236.00 | \$ 239.00 | \$ 119.00 | \$ 961.00 |
| | RQ Square | \$ 355.00 | \$ 358.00 | \$ 179.00 | \$ 1,100.00 |
| O3D Satin brass | RP Round | \$ 236.00 | \$ 239.00 | \$ 119.00 | \$ 961.00 |
| | RQ Square | \$ 355.00 | \$ 358.00 | \$ 179.00 | \$ 1,100.00 |
| O6A Anticato | RP Round | \$ 236.00 | \$ 239.00 | \$ 119.00 | \$ 961.00 |
| | RQ Square | \$ 355.00 | \$ 358.00 | \$ 179.00 | \$ 1,100.00 |
| O6B Brunito | RP Round | \$ 236.00 | \$ 239.00 | \$ 119.00 | \$ 961.00 |
| | RQ Square | \$ 355.00 | \$ 358.00 | \$ 179.00 | \$ 1,100.00 |
| 26 Polished chrome | RP Round | \$ 236.00 | \$ 239.00 | \$ 119.00 | \$ 961.00 |
| | RQ Square | \$ 355.00 | \$ 358.00 | \$ 179.00 | \$ 1,100.00 |
| 26D Satin chrome | RP Round | \$ 236.00 | \$ 239.00 | \$ 119.00 | \$ 961.00 |
| | RQ Square | \$ 355.00 | \$ 358.00 | \$ 179.00 | \$ 1,100.00 |

Retail price

| Finish | Escutcheon | Function | | DMY R/L Single | DMY R/L Pair | ML-F Entry |
|--------------------|----------------|-----------|-----------|----------------|--------------|------------|
| | | PGE | PCY | | | |
| 26 Polished chrome | EP Oval | \$ 520.00 | \$ 545.00 | \$ 254.00 | \$ 455.00 | \$ 899.00 |
| | ER Rectangular | \$ 570.00 | \$ 596.00 | \$ 279.00 | \$ 506.00 | \$ 935.00 |
| 26D Satin chrome | EP Oval | \$ 520.00 | \$ 545.00 | \$ 254.00 | \$ 455.00 | \$ 899.00 |
| | ER Rectangular | \$ 570.00 | \$ 596.00 | \$ 279.00 | \$ 506.00 | \$ 935.00 |

The options listed above are considered standard. Non-standard options are available upon request.

For more options on Rosettes and Escutcheon plates see page 23. For more options on Finishes see pages 12-13.
RE = Rectangular rosettes available for tubular latch application only. Add + \$ 30.00 LIST to the price of the RQ.
For slim rosette (European version) see pages 100-103.

Upcharges apply for the following special options:

- Extra thick door (> 2")
- Non-standard rosettes (rosettes not listed above)
- Non-standard finishes (finishes not listed above)
- Split finishes

See page 17 for pricing. Exclusions may apply.



K 1168 Giasone

| | | |
|----------|------------|-------|
| Material | Collection | Group |
| Brass | Lab | 1 |

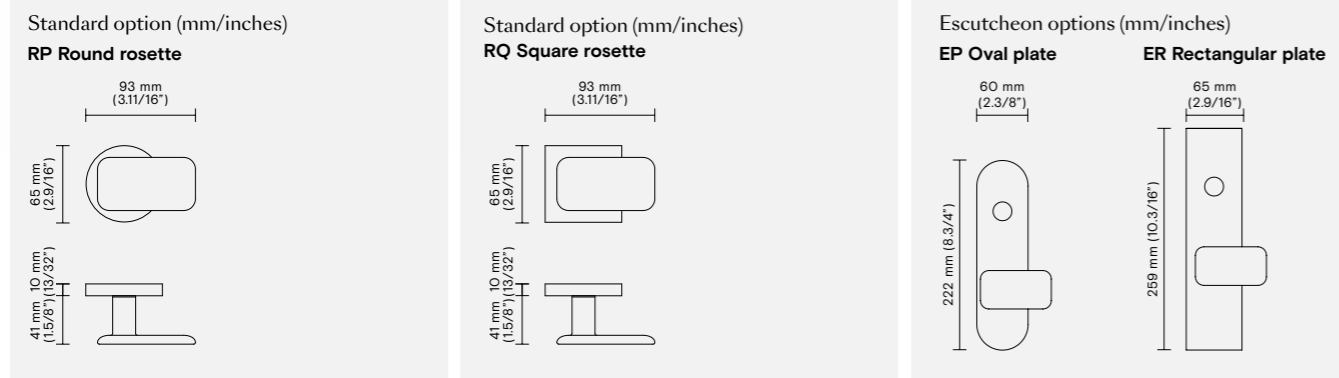

Slim rosette available - See pages 102-103

Conversions from metric to U.S. measurements are approximate.

Retail price

| Finish | Rosette | Function PGE | PCY | DMY R/L Single | ML-F Entry |
|--------------------|-----------|--------------|-----------|----------------|-------------|
| 26 Polished chrome | RP Round | \$ 384.00 | \$ 417.00 | \$ 185.00 | \$ 961.00 |
| | RQ Square | \$ 494.00 | \$ 522.00 | \$ 259.00 | \$ 1,100.00 |
| 26D Satin chrome | RP Round | \$ 377.00 | \$ 403.00 | \$ 191.00 | \$ 961.00 |
| | RQ Square | \$ 513.00 | \$ 542.00 | \$ 275.00 | \$ 1,100.00 |

Retail price

| Finish | Escutcheon | Function PGE | PCY | DMY R/L Single | DMY R/L Pair | ML-F Entry |
|--------------------|----------------|--------------|-----------|----------------|--------------|------------|
| 26 Polished chrome | EP Oval | \$ 520.00 | \$ 545.00 | \$ 254.00 | \$ 455.00 | \$ 899.00 |
| | ER Rectangular | \$ 570.00 | \$ 596.00 | \$ 279.00 | \$ 506.00 | \$ 935.00 |
| 26D Satin chrome | EP Oval | \$ 520.00 | \$ 545.00 | \$ 254.00 | \$ 455.00 | \$ 899.00 |
| | ER Rectangular | \$ 570.00 | \$ 596.00 | \$ 279.00 | \$ 506.00 | \$ 935.00 |

The options listed above are considered standard. Non-standard options are available upon request.

For more options on Rosettes and Escutcheon plates see page 23. For more options on Finishes see pages 12-13.

RE = Rectangular rosettes available for tubular latch application only. Add + \$ 30.00 LIST to the price of the RQ. For slim rosette (European version) see pages 100-103.

Upcharges apply for the following special options:

- Extra thick door (> 2")
- Non-standard rosettes (rosettes not listed above)
- Non-standard finishes (finishes not listed above)
- Split finishes

See page 17 for pricing. Exclusions may apply.



K 1170

| | | |
|----------|------------|-------|
| Material | Collection | Group |
| Aluminum | Lab | 1 |

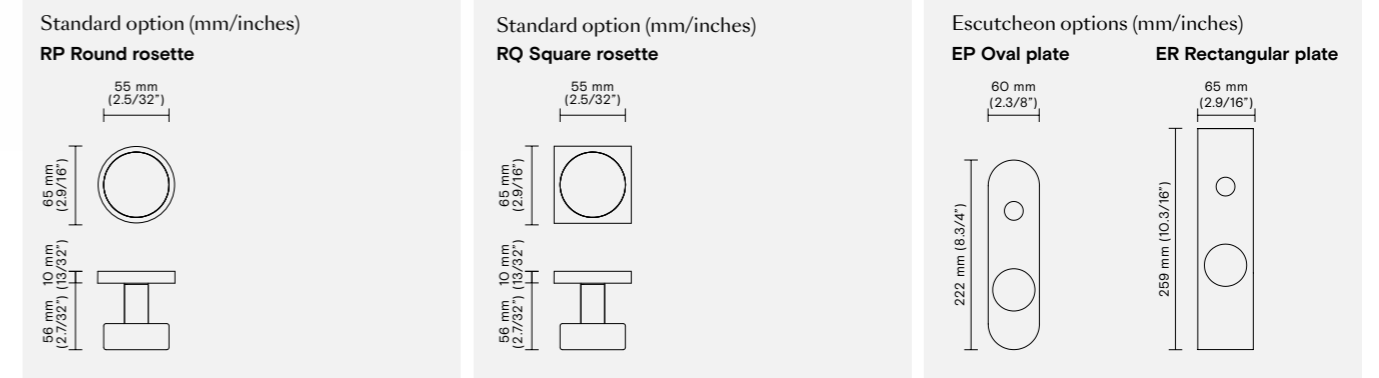

Slim rosette available - See pages 102-103

Conversions from metric to U.S. measurements are approximate.

Retail price

| Finish | Rosette | Function PGE | PCY | DMY R/L Single | ML-F Entry |
|--------------------|-----------|--------------|-----------|----------------|-------------|
| 06M Matt bronze | RP Round | \$ 397.00 | \$ 423.00 | \$ 202.00 | \$ 961.00 |
| | RQ Square | \$ 516.00 | \$ 542.00 | \$ 262.00 | \$ 1,100.00 |
| 16 Dull black | RP Round | \$ 236.00 | \$ 239.00 | \$ 119.00 | \$ 961.00 |
| | RQ Square | \$ 355.00 | \$ 358.00 | \$ 179.00 | \$ 1,100.00 |
| 22M Matt white | RP Round | \$ 397.00 | \$ 423.00 | \$ 202.00 | \$ 961.00 |
| | RQ Square | \$ 516.00 | \$ 542.00 | \$ 262.00 | \$ 1,100.00 |
| 26 Polished chrome | RP Round | \$ 236.00 | \$ 239.00 | \$ 119.00 | \$ 961.00 |
| | RQ Square | \$ 355.00 | \$ 358.00 | \$ 179.00 | \$ 1,100.00 |
| 26D Satin chrome | RP Round | \$ 236.00 | \$ 239.00 | \$ 119.00 | \$ 961.00 |
| | RQ Square | \$ 355.00 | \$ 358.00 | \$ 179.00 | \$ 1,100.00 |

Retail price

| Finish | Escutcheon | Function PGE | PCY | DMY R/L Single | DMY R/L Pair | ML-F Entry |
|--------------------|----------------|--------------|-----------|----------------|--------------|------------|
| 26 Polished chrome | EP Oval | \$ 520.00 | \$ 545.00 | \$ 254.00 | \$ 455.00 | \$ 899.00 |
| | ER Rectangular | \$ 570.00 | \$ 596.00 | \$ 279.00 | \$ 506.00 | \$ 935.00 |
| 26D Satin chrome | EP Oval | \$ 520.00 | \$ 545.00 | \$ 254.00 | \$ 455.00 | \$ 899.00 |
| | ER Rectangular | \$ 570.00 | \$ 596.00 | \$ 279.00 | \$ 506.00 | \$ 935.00 |

The options listed above are considered standard. Non-standard options are available upon request.

For more options on Rosettes and Escutcheon plates see page 23. For more options on Finishes see pages 12-13.

RE = Rectangular rosettes available for tubular latch application only. Add + \$ 30.00 LIST to the price of the RQ. For slim rosette (European version) see pages 100-103.

Upcharges apply for the following special options:

- Extra thick door (> 2")
- Non-standard rosettes (rosettes not listed above)
- Non-standard finishes (finishes not listed above)
- Split finishes

See page 17 for pricing. Exclusions may apply.

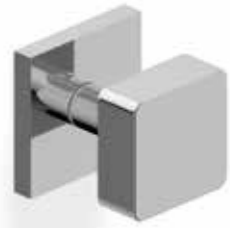

K 1171

| | | |
|----------|------------|-------|
| Material | Collection | Group |
| Aluminum | Lab | 3 |

Standard option (mm/inches)

RQ Square rosette

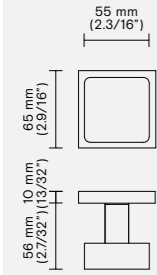

Standard option (mm/inches)

RP Round rosette

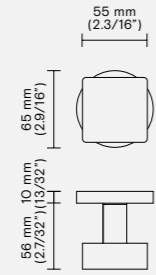

Escutcheon options (mm/inches)

EP Oval plate

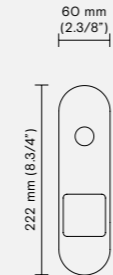

ER Rectangular plate

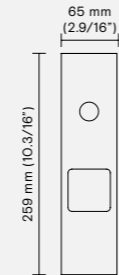

Conversions from metric to U.S. measurements are approximate.

Slim rosette available - See pages 102-103

Retail price

| Finish | Rosette | Function PGE | PCY | DMY R/L Single | ML-F Entry |
|--------------------|-----------|--------------|-----------|----------------|-------------|
| 26 Polished chrome | RP Round | \$ 416.00 | \$ 423.00 | \$ 197.00 | \$ 1,251.00 |
| | RQ Square | \$ 542.00 | \$ 548.00 | \$ 260.00 | \$ 1,389.00 |
| 26D Satin chrome | RP Round | \$ 416.00 | \$ 423.00 | \$ 197.00 | \$ 1,251.00 |
| | RQ Square | \$ 542.00 | \$ 548.00 | \$ 260.00 | \$ 1,389.00 |

Retail price

| Finish | Escutcheon | Function PGE | PCY | DMY R/L Single | DMY R/L Pair | ML-F Entry |
|--------------------|----------------|--------------|-----------|----------------|--------------|-------------|
| 26 Polished chrome | EP Oval | \$ 809.00 | \$ 823.00 | \$ 405.00 | \$ 747.00 | \$ 1,200.00 |
| | ER Rectangular | \$ 859.00 | \$ 873.00 | \$ 430.00 | \$ 798.00 | \$ 1,226.00 |
| 26D Satin chrome | EP Oval | \$ 809.00 | \$ 823.00 | \$ 405.00 | \$ 747.00 | \$ 1,200.00 |
| | ER Rectangular | \$ 859.00 | \$ 873.00 | \$ 430.00 | \$ 798.00 | \$ 1,226.00 |

The options listed above are considered standard. Non-standard options are available upon request.

For more options on Rosettes and Escutcheon plates see page 23. For more options on Finishes see pages 12-13.
RE = Rectangular rosettes available for tubular latch application only. Add + \$ 30.00 LIST to the price of the RQ.
For slim rosette (European version) see pages 100-103.

Upcharges apply for the following special options:

- Extra thick door (> 2")
- Non-standard rosettes (rosettes not listed above)
- Non-standard finishes (finishes not listed above)
- Split finishes

See page 17 for pricing. Exclusions may apply.



K 1730

| | | |
|----------|------------|-------|
| Material | Collection | Group |
| Brass | Lab | 3 |

Standard option (mm/inches)

RP Round rosette

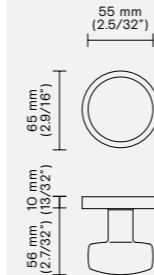

Standard option (mm/inches)

RQ Square rosette

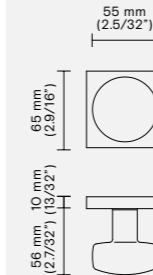

Escutcheon options (mm/inches)

EP Oval plate

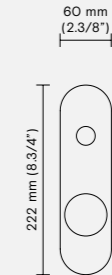

ER Rectangular plate

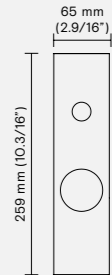

Conversions from metric to U.S. measurements are approximate.

Slim rosette available - See pages 102-103

Retail price

| Finish | Rosette | Function PGE | PCY | DMY R/L Single | ML-F Entry |
|--------------------|-----------|--------------|-----------|----------------|-------------|
| 03 Polished brass | RP Round | \$ 424.00 | \$ 435.00 | \$ 227.00 | \$ 1,251.00 |
| | RQ Square | \$ 462.00 | \$ 480.00 | \$ 293.00 | \$ 1,389.00 |
| 15 Satin nickel | RP Round | \$ 435.00 | \$ 486.00 | \$ 231.00 | \$ 1,251.00 |
| | RQ Square | \$ 584.00 | \$ 605.00 | \$ 307.00 | \$ 1,389.00 |
| 26 Polished chrome | RP Round | \$ 435.00 | \$ 486.00 | \$ 231.00 | \$ 1,251.00 |
| | RQ Square | \$ 584.00 | \$ 605.00 | \$ 307.00 | \$ 1,389.00 |
| 26D Satin chrome | RP Round | \$ 435.00 | \$ 486.00 | \$ 231.00 | \$ 1,251.00 |
| | RQ Square | \$ 584.00 | \$ 605.00 | \$ 307.00 | \$ 1,389.00 |

Retail price

| Finish | Escutcheon | Function PGE | PCY | DMY R/L Single | DMY R/L Pair | ML-F Entry |
|--------------------|----------------|--------------|-----------|----------------|--------------|-------------|
| 26 Polished chrome | EP Oval | \$ 520.00 | \$ 545.00 | \$ 254.00 | \$ 455.00 | \$ 1,200.00 |
| | ER Rectangular | \$ 570.00 | \$ 596.00 | \$ 279.00 | \$ 506.00 | \$ 1,226.00 |
| 26D Satin chrome | EP Oval | \$ 520.00 | \$ 545.00 | \$ 254.00 | \$ 455.00 | \$ 1,200.00 |
| | ER Rectangular | \$ 570.00 | \$ 596.00 | \$ 279.00 | \$ 506.00 | \$ 1,226.00 |

The options listed above are considered standard. Non-standard options are available upon request.

For more options on Rosettes and Escutcheon plates see page 23. For more options on Finishes see pages 12-13.
RE = Rectangular rosettes available for tubular latch application only. Add + \$ 30.00 LIST to the price of the RQ.
For slim rosette (European version) see pages 100-103.

Upcharges apply for the following special options:

- Extra thick door (> 2")
- Non-standard rosettes (rosettes not listed above)
- Non-standard finishes (finishes not listed above)
- Split finishes

See page 17 for pricing. Exclusions may apply.



K 5301

| | | |
|-------------------------------|------------|-------|
| Material | Collection | Group |
| Stainless steel AISI 316 L | Fusital | 7 |

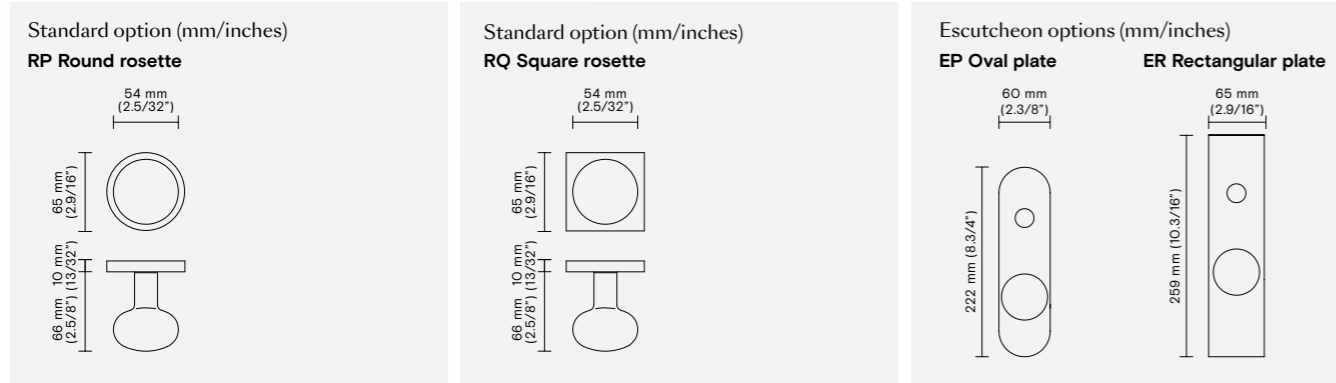

Conversions from metric to U.S. measurements are approximate.

Retail price

| Finish | Rosette | Function | | DMY R/L Single | ML-F Entry |
|-----------------------------|------------|-----------|-----------|----------------|-------------|
| | | PGE | PCY | | |
| 32 Polished stainless steel | RPS Round | \$ 737.00 | \$ 775.00 | \$ 366.00 | \$ 1,516.00 |
| | RQS Square | \$ 856.00 | \$ 894.00 | \$ 425.00 | \$ 1,542.00 |
| | RSS Round | \$ 688.00 | \$ 923.00 | \$ 329.00 | \$ 1,303.00 |
| 32D Satin stainless steel | RPS Round | \$ 589.00 | \$ 602.00 | \$ 282.00 | \$ 1,516.00 |
| | RQS Square | \$ 708.00 | \$ 721.00 | \$ 342.00 | \$ 1,542.00 |
| | RSS Round | \$ 549.00 | \$ 737.00 | \$ 266.00 | \$ 1,303.00 |

Retail price

| Finish | Escutcheon | Function | | DMY R/L Single | DMY R/L Pair | ML-F Entry |
|---------------------------|----------------|-----------|-----------|----------------|--------------|-------------|
| | | PGE | PCY | | | |
| 32D Satin stainless steel | EP Oval | \$ 885.00 | \$ 961.00 | \$ 444.00 | \$ 859.00 | \$ 1,340.00 |
| | ER Rectangular | \$ 949.00 | \$ 985.00 | \$ 481.00 | \$ 899.00 | \$ 1,579.00 |

The options listed above are considered standard. Non-standard options are available upon request.

For more options on Rosettes and Escutcheon plates see page 23.
 For more options on Finishes see pages 12-13.
 RE = Rectangular rosettes available for tubular latch application only.
 Add + \$ 30.00 LIST to the price of the RQ.
 For slim rosette (European version) see pages 100-103.

Upcharges apply for the following special options:

- Extra thick door (> 2")
- Non-standard rosettes (rosettes not listed above)
- Non-standard finishes (finishes not listed above)
- Split finishes

See page 17 for pricing. Exclusions may apply.

K 352 Richard Meier

Material Brass Collection Fusital

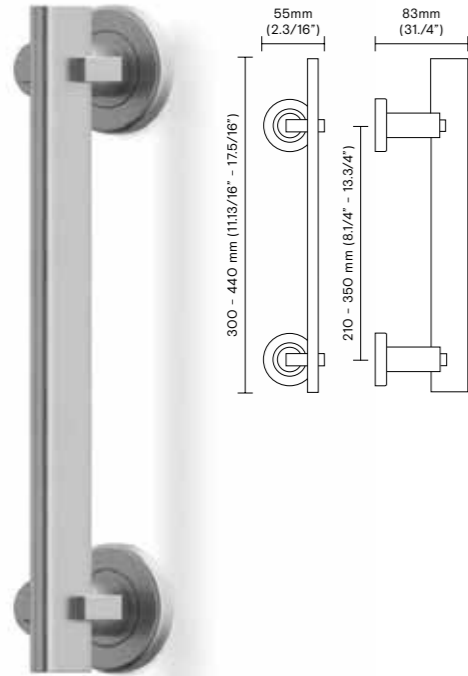

Retail price

| Finish | Center to center (mm/inches) | Single | Back to back |
|--------------------|------------------------------|-----------|--------------|
| 26 Polished chrome | 210 (8.1/4") RH | \$ 576.00 | \$ 1,198.00 |
| | 350 (13.13/4") RH | \$ 679.00 | \$ 1,404.00 |
| | 210 (8.1/4") LH | \$ 576.00 | \$ 1,198.00 |
| | 350 (13.13/4") LH | \$ 679.00 | \$ 1,404.00 |

Note: Complete with fixing systems for single and back to back mounting on wood (X 0526, X 0523) and glass doors (X 0525, X 0523).

When ordering the K 352 specify the below:
RH = Pull grip on the right side
LH = Pull grip on the left side

K 356 John Pawson

Material Brass Collection Fusital

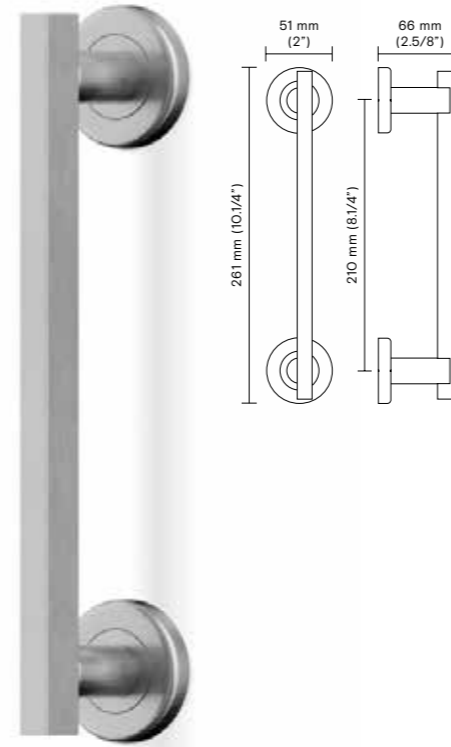

Retail price

| Finish | Center to center (mm/inches) | Single | Back to back |
|--------------------|------------------------------|-----------|--------------|
| 26 Polished chrome | 210 (8.1/4") | \$ 601.00 | \$ 1,248.00 |
| 26D Satin chrome | 210 (8.1/4") | \$ 582.00 | \$ 1,210.00 |

Note: Complete with fixing systems for single and back to back mounting on wood (X 0526, X 0523) and glass doors (X 0525, X 0523).

K 353 Taller Design Ricardo Bofill

Material Brass Collection Fusital

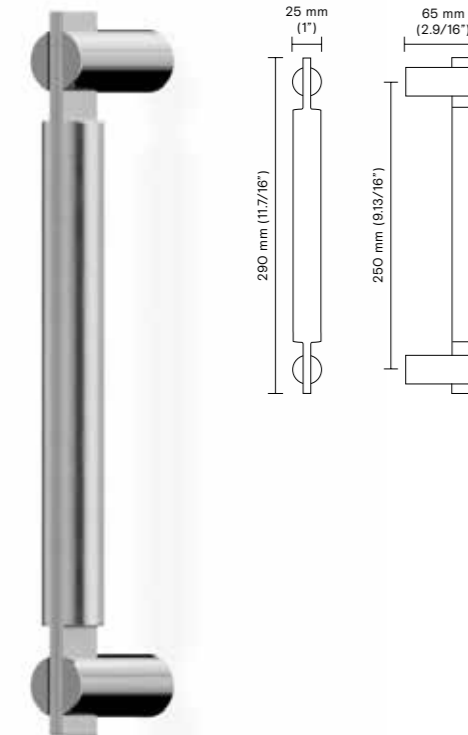

Retail price

| Finish | Center to center (mm/inches) | Single | Back to back |
|--|------------------------------|-----------|--------------|
| 26/26D Polished chrome / Satin chrome* | 250 (9.13/16") | \$ 542.00 | \$ 1,150.00 |

* The grip part is satin, the stand-off posts are polished.
The dual finish version has the posts in polished chrome and the grip in satin chrome.

Note: Complete with fixing systems for single and back to back mounting on wood (X 0526, X 0523) and glass doors (X 0525, X 0523).

K 358 Cerri & Associati

Material Brass Collection Fusital

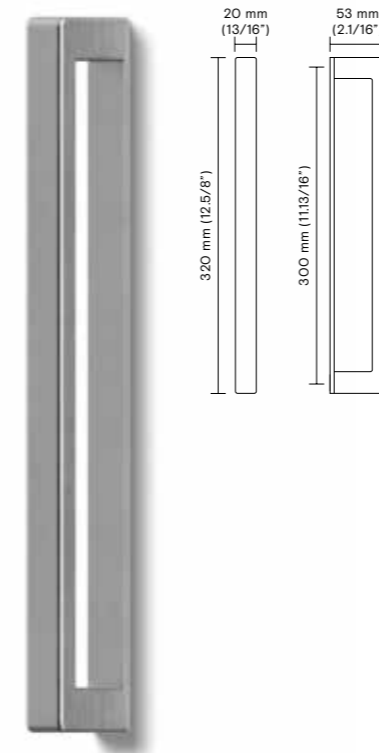

Retail price

| Finish | Center to center (mm/inches) | Single | Back to back |
|--------------------|------------------------------|-----------|--------------|
| 26 Polished chrome | 300 (11.13/16") | \$ 600.00 | \$ 1,246.00 |
| 26D Satin chrome | 300 (11.13/16") | \$ 630.00 | \$ 1,306.00 |

Note: Complete with fixing systems for single and back to back mounting on wood (X 0526, X 0523) and glass doors (X 0525, X 0523).

All the options listed in this page are considered standard.
For more options on finishes, see pages 12-13, and upcharges at page 17.

For fixing spare parts, please check at pages 194-199.

Conversions from metric to U.S. measurements are approximate.

All the options listed in this page are considered standard.
For more options on finishes, see pages 12-13, and upcharges at page 17.

For fixing spare parts, please check at pages 194-199.

Conversions from metric to U.S. measurements are approximate.

K 368 Antonio Citterio with Toan Nguyen

Material Brass Collection Fusital

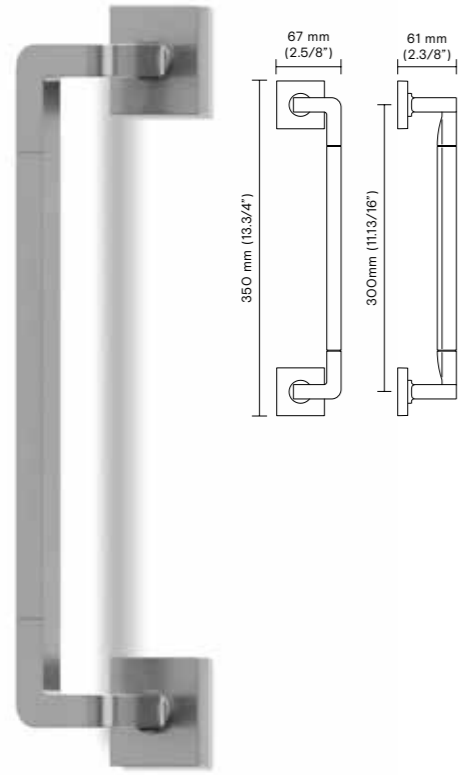

Retail price

| Finish | Center to center (mm/inches) | Single | Back to back |
|---------------------------|------------------------------|-----------|--------------|
| 26 Polished chrome | 300 (11.13/16") | \$ 700.00 | \$ 1,448.00 |
| 26D Satin chrome | 300 (11.13/16") | \$ 737.00 | \$ 1,519.00 |

Note: Complete with fixing systems for single and back to back mounting on wood (X 0526, X 0523) and glass doors (X 0525, X 0523).

K 378 Yabu Pushelberg

Material Brass Collection Fusital

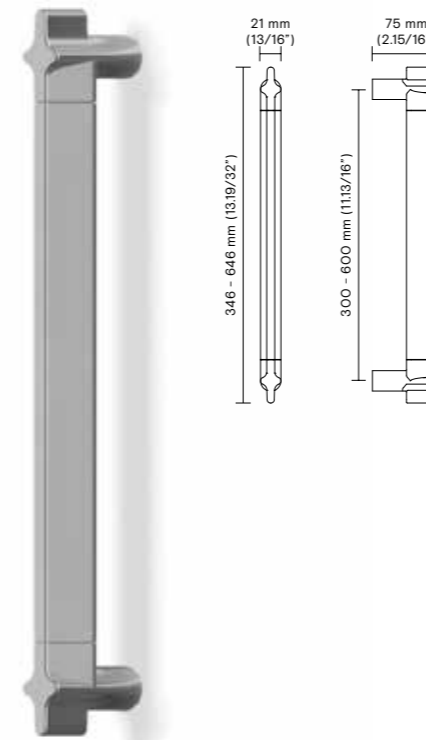

Retail price

| Finish | Center to center (mm/inches) | Single | Back to back |
|----------------------------------|------------------------------|-----------|--------------|
| 17A Polished black nickel | 300 (11.13/16") | \$ 773.00 | \$ 1,600.00 |
| 26 Polished chrome | 300 (11.13/16") | \$ 702.00 | \$ 1,454.00 |
| 56 Dark bronze | 300 (11.13/16") | \$ 843.00 | \$ 1,745.00 |

Due to its particular design, this pull cannot be produced in any satin or matt finishes. Call for details

Note: Complete with fixing systems for single and back to back mounting on wood (X 0526, X 0523) and glass doors (X 0525, X 0523).

K 377 Steve Leung

Material Brass Collection Fusital

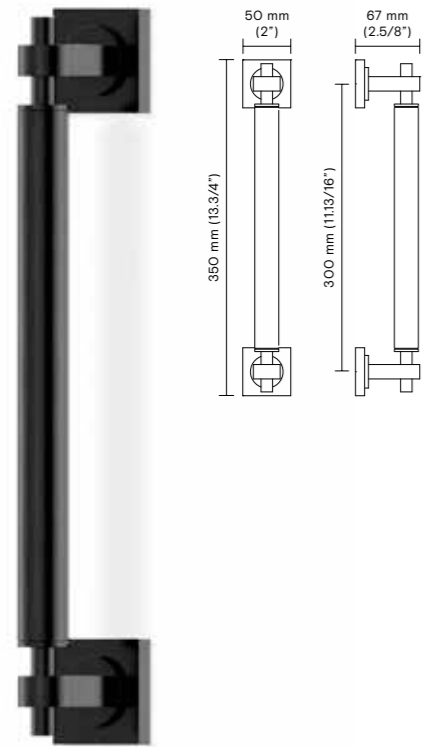

Retail price

| Finish | Center to center (mm/inches) | Single | Back to back |
|-----------------------|------------------------------|-----------|--------------|
| 03M Matt brass | 300 (11.13/16") | \$ 486.00 | \$ 1,016.00 |
| 16 Dull black | 300 (11.13/16") | \$ 389.00 | \$ 823.00 |
| 56 Dark bronze | 300 (11.13/16") | \$ 486.00 | \$ 1,016.00 |

Note: Complete with fixing systems for single and back to back mounting on wood (X 0526, X 0523) and glass doors (X 0525, X 0523).

K 379 Antonio Citterio

Material Brass Collection Fusital

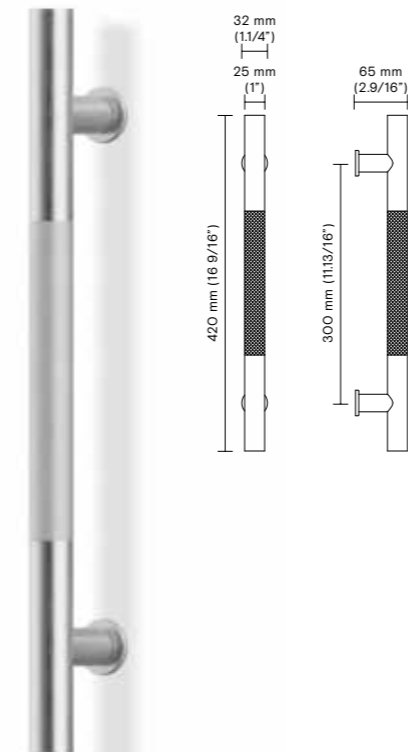

Retail price

| Finish | Center to center (mm/inches) | Single | Back to back |
|-------------------------|------------------------------|-----------|--------------|
| 03D Satin brass | 300 (11.13/16") | \$ 594.00 | \$ 1,258.00 |
| 06M Matt bronze | 300 (11.13/16") | \$ 670.00 | \$ 1,409.00 |
| 26D Satin chrome | 300 (11.13/16") | \$ 755.00 | \$ 1,579.00 |

Note: Complete with fixing systems for single and back to back mounting on wood (X 0526, X 0523) and glass doors (X 0525, X 0523).

Conversions from metric to U.S. measurements are approximate.

All the options listed in this page are considered standard. For more options on finishes, see pages 12-13, and upcharges at page 17.

For fixing spare parts, please check at pages 194-199.

Conversions from metric to U.S. measurements are approximate.

All the options listed in this page are considered standard. For more options on finishes, see pages 12-13, and upcharges at page 17.

For fixing spare parts, please check at pages 194-199.

Conversions from metric to U.S. measurements are approximate.

K 380 Antonio Citterio

Material Brass Collection Fusital

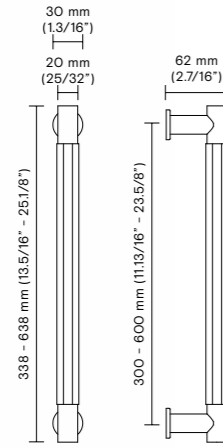

Retail price

| Finish | Center to center (mm/inches) | Single | Back to back |
|--------------------|------------------------------|-----------|--------------|
| 14 Polished nickel | 300 (11.13/16") | \$ 627.00 | \$ 1,322.00 |
| | 600 (23.5/8") | \$ 863.00 | \$ 1,795.00 |
| 26D Satin chrome | 300 (11.13/16") | \$ 594.00 | \$ 1,258.00 |
| | 600 (23.5/8") | \$ 831.00 | \$ 1,731.00 |
| 56 Dark bronze | 300 (11.13/16") | \$ 627.00 | \$ 1,322.00 |
| | 600 (23.5/8") | \$ 863.00 | \$ 1,795.00 |

Note: Complete with fixing systems for single and back to back mounting on wood (X 0526, X 0523) and glass doors (X 0525, X 0523).

K 383 Perkins&Will

Material Brass Collection Fusital

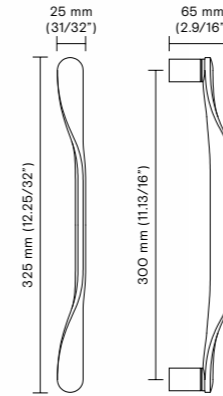

Retail price

| Finish | Center to center (mm/inches) | Single | Back to back |
|------------------|------------------------------|-----------|--------------|
| 15 Satin nickel | 300 (11.13/16") | \$ 584.00 | \$ 1,236.00 |
| 16 Dull black | 300 (11.13/16") | \$ 530.00 | \$ 1,128.00 |
| 26D Satin chrome | 300 (11.13/16") | \$ 584.00 | \$ 1,236.00 |
| 56 Dark bronze | 300 (11.13/16") | \$ 638.00 | \$ 1,344.00 |

Note: Complete with fixing systems for single and back to back mounting on wood (X 0526, X 0523) and glass doors (X 0525, X 0523).

K 381 Khalid Al Najjar

Material Brass Collection Fusital



Retail price

| Finish | Center to center (mm/inches) | Single | Back to back |
|---------------------------|------------------------------|-----------|--------------|
| 03M Matt brass | 300 (11.13/16") | \$ 431.00 | \$ 931.00 |
| | 600 (23.5/8") | \$ 604.00 | \$ 1,277.00 |
| 15 Satin nickel | 300 (11.13/16") | \$ 449.00 | \$ 966.00 |
| | 600 (23.5/8") | \$ 621.00 | \$ 1,312.00 |
| 17A Polished black nickel | 300 (11.13/16") | \$ 486.00 | \$ 1,042.00 |
| | 600 (23.5/8") | \$ 659.00 | \$ 1,387.00 |
| 26D Satin chrome | 300 (11.13/16") | \$ 449.00 | \$ 966.00 |
| | 600 (23.5/8") | \$ 621.00 | \$ 1,312.00 |

Note: Complete with fixing systems for single and back to back mounting on wood (X 0526, X 0523) and glass doors (X 0525, X 0523).

K 385 Federica Biasi

Material Brass Collection Fusital

NEW

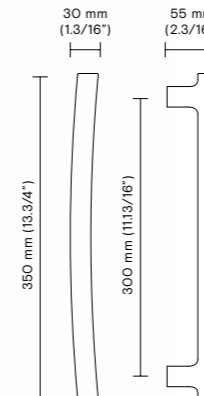

Retail price

| Finish | Center to center (mm/inches) | Single | Back to back |
|--------------------|------------------------------|-----------|--------------|
| 15 Satin nickel | 300 (11.13/16") | \$ 400.00 | \$ 830.00 |
| 16 Dull black | 300 (11.13/16") | \$ 400.00 | \$ 830.00 |
| 26 Polished chrome | 300 (11.13/16") | \$ 400.00 | \$ 830.00 |
| 26D Satin chrome | 300 (11.13/16") | \$ 400.00 | \$ 830.00 |

Note: Complete with fixing systems for single and back to back mounting on wood (X 0526, X 0523) and glass doors (X 0525, X 0523).

All the options listed in this page are considered standard. For more options on finishes, see pages 12-13, and upcharges at page 17.

For fixing spare parts, please check at pages 194-199.

Conversions from metric to U.S. measurements are approximate.

All the options listed in this page are considered standard. For more options on finishes, see pages 12-13, and upcharges at page 17.

For fixing spare parts, please check at pages 194-199.

Conversions from metric to U.S. measurements are approximate.

K 386 Meneghello Paoelli

Material Brass Collection Fusital

NEW

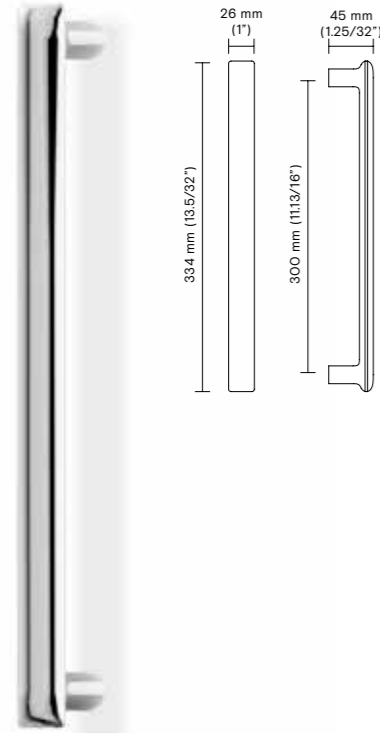

Retail price

| Finish | Center to center (mm/inches) | Single | Back to back |
|---------------------------|------------------------------|-----------|--------------|
| 15 Satin nickel | 300 (11.13/16") | \$ 400.00 | \$ 830.00 |
| 17A Polished black nickel | 300 (11.13/16") | \$ 400.00 | \$ 830.00 |
| 26 Polished chrome | 300 (11.13/16") | \$ 400.00 | \$ 830.00 |
| 26D Satin chrome | 300 (11.13/16") | \$ 400.00 | \$ 830.00 |

Note: Complete with fixing systems for single and back to back mounting on wood (X 0526, X 0523) and glass doors (X 0525, X 0523)

K 1056 Quadra

Material Aluminum Collection Lab

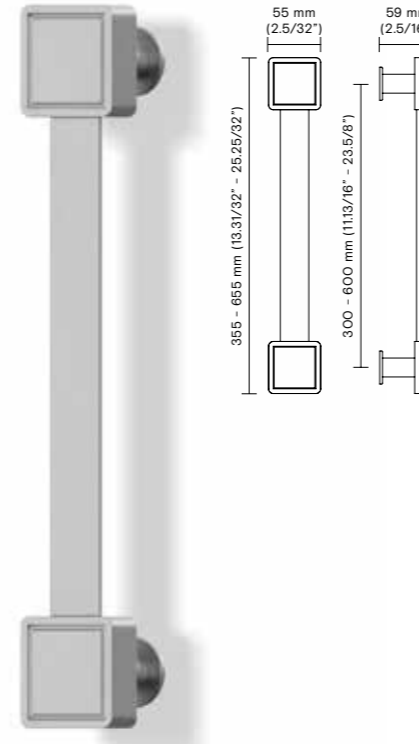

Retail price

| Finish | Center to center (mm/inches) | Single | Back to back |
|--------------------|------------------------------|-----------|--------------|
| 26 Polished chrome | 300 (11.13/16") | \$ 466.00 | \$ 976.00 |
| | 600 (23.5/8") | \$ 466.00 | \$ 976.00 |
| 26D Satin chrome | 300 (11.13/16") | \$ 512.00 | \$ 1,069.00 |
| | 600 (23.5/8") | \$ 512.00 | \$ 1,069.00 |

Note: Complete with fixing systems for single and back to back mounting on wood (X 0531, X 0528) and glass doors (X 0530, X 0528).

K 1054 W.W.

Material Aluminum Collection Lab

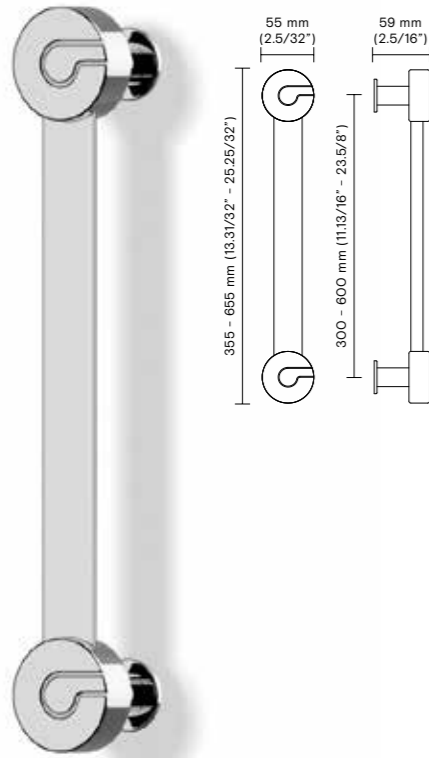

Retail price

| Finish | Center to center (mm/inches) | Single | Back to back |
|--------------------|------------------------------|-----------|--------------|
| 03M Matt brass | 300 (11.13/16") | \$ 441.00 | \$ 925.00 |
| | 600 (23.5/8") | \$ 486.00 | \$ 1,018.00 |
| 15 Satin nickel | 300 (11.13/16") | \$ 405.00 | \$ 858.00 |
| | 600 (23.5/8") | \$ 452.00 | \$ 950.00 |
| 16 Dull black | 300 (11.13/16") | \$ 393.00 | \$ 829.00 |
| | 600 (23.5/8") | \$ 438.00 | \$ 920.00 |
| 26 Polished chrome | 300 (11.13/16") | \$ 393.00 | \$ 829.00 |
| | 600 (23.5/8") | \$ 438.00 | \$ 920.00 |

Note: Complete with fixing systems for single and back to back mounting on wood (X 0531, X 0528) and glass doors (X 0530, X 0528).

K 1060 SOM - Skidmore, Owings & Merrill

Material Brass Collection Fusital

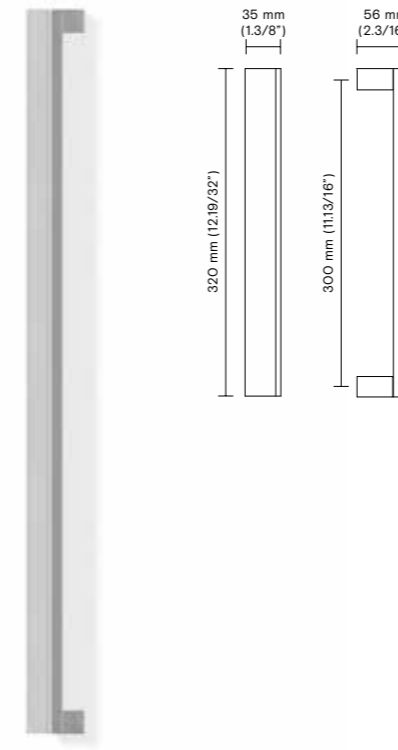

Retail price

| Finish | Center to center (mm/inches) | Single | Back to back |
|--------------------|------------------------------|-----------|--------------|
| 16 Dull black | 300 (11.13/16") | \$ 550.00 | \$ 1,167.00 |
| 26 Polished chrome | 300 (11.13/16") | \$ 578.00 | \$ 1,223.00 |
| 26D Satin chrome | 300 (11.13/16") | \$ 578.00 | \$ 1,223.00 |

Note: Complete with fixing systems for single and back to back mounting on wood (X 0531, X 0528) and glass doors (X 0530, X 0528).

All the options listed in this page are considered standard. For more options on finishes, see pages 12-13, and upcharges at page 17.

For fixing spare parts, please check at pages 194-199.

Conversions from metric to U.S. measurements are approximate.

All the options listed in this page are considered standard. For more options on finishes, see pages 12-13, and upcharges at page 17.

For fixing spare parts, please check at pages 194-199.

Conversions from metric to U.S. measurements are approximate.

K 1061 Di Virgilio Veneziano

Material Brass Collection Fusital

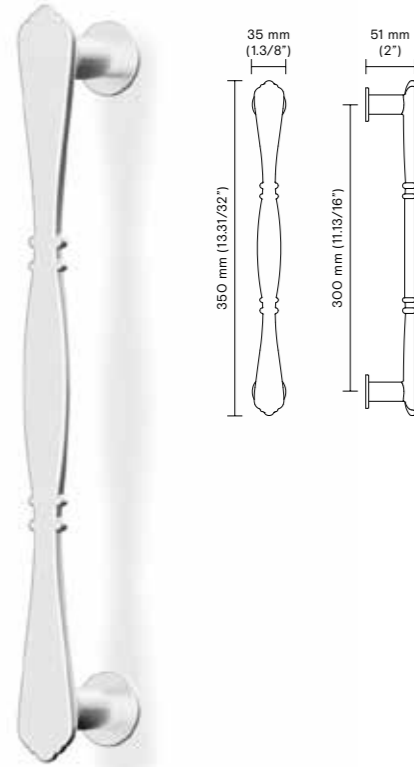

Retail price

| Finish | Center to center (mm/inches) | Single | Back to back |
|----------------------------------|------------------------------|-----------|--------------|
| 03D Satin brass | 300 (11.13/16") | \$ 442.00 | \$ 951.00 |
| 06M Bronze matt | 300 (11.13/16") | \$ 442.00 | \$ 951.00 |
| 17A Polished black nickel | 300 (11.13/16") | \$ 552.00 | \$ 1,132.00 |

Note: Complete with fixing systems for single and back to back mounting on wood (X O531, X O528) and glass doors (X O530, X O528).

K 1069 Susannah

Material Brass Collection Lab

NEW

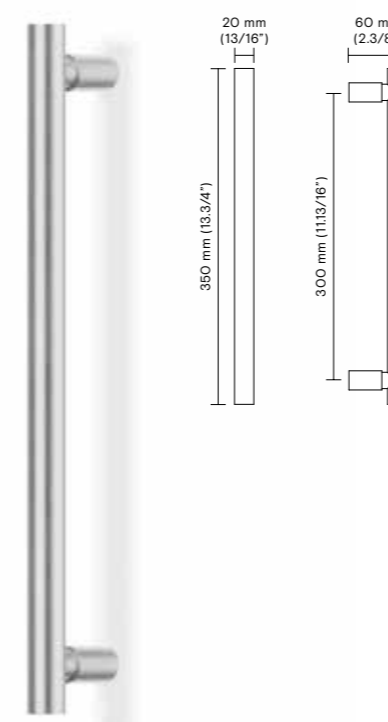

Retail price

| Finish | Center to center (mm/inches) | Single | Back to back |
|---------------------------|------------------------------|-----------|--------------|
| 15 Satin nickel | 300 (11.13/16") | \$ 648.00 | \$ 1,366.00 |
| 26 Polished chrome | 300 (11.13/16") | \$ 577.00 | \$ 1,223.00 |
| 26D Satin chrome | 300 (11.13/16") | \$ 577.00 | \$ 1,223.00 |

For different sizes, call our customer service.

Note: Complete with fixing systems for single and back to back mounting on wood (X O531, X O528) and glass doors (X O530, X O528).

K 1068 Pembroke & Ives

Material Brass Collection Lab

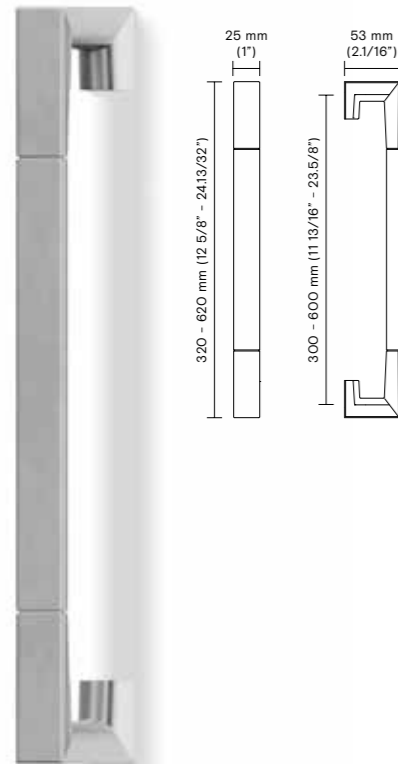

Retail price

| Finish | Center to center (mm/inches) | Single | Back to back |
|---|------------------------------|-----------|--------------|
| 03/03D Polished brass / Satin brass* | 300 (11.13/16") | \$ 700.00 | \$ 1,469.00 |
| | 600 (23.5/8") | \$ 735.00 | \$ 1,538.00 |
| 15 Satin nickel | 300 (11.13/16") | \$ 700.00 | \$ 1,469.00 |
| | 600 (23.5/8") | \$ 735.00 | \$ 1,538.00 |
| 16 Dull black | 300 (11.13/16") | \$ 700.00 | \$ 1,469.00 |
| | 600 (23.5/8") | \$ 735.00 | \$ 1,538.00 |
| 26/26D Polished chrome / Satin chrome* | 300 (11.13/16") | \$ 700.00 | \$ 1,469.00 |
| | 600 (23.5/8") | \$ 735.00 | \$ 1,538.00 |

* The pull is satin on its front and side edge, while polished on the rest.

Note: Complete with fixing systems for single and back to back mounting on wood (X O531, X O528) and glass doors (X O530, X O528).

K 1188

Material Brass Collection Lab



Retail price

| Finish | Center to center (mm/inches) | Single |
|--------------------------|------------------------------|-----------|
| 03 Polished brass | 210 (8.1/4") | \$ 246.00 |
| 03D Satin brass | 210 (8.1/4") | \$ 246.00 |
| 06B Brunito | 210 (8.1/4") | \$ 258.00 |
| 26D Satin chrome | 210 (8.1/4") | \$ 258.00 |

Note: Complete with fixing systems for single and back to back mounting on wood (X O326, X O523) and glass doors (X O525, X O523).

Possibility of mounting without cover-nut rosettes.

All the options listed in this page are considered standard. For more options on finishes, see pages 12-13, and upcharges at page 17.

For fixing spare parts, please check at pages 194-199.

Conversions from metric to U.S. measurements are approximate.

All the options listed in this page are considered standard. For more options on finishes, see pages 12-13, and upcharges at page 17.

For fixing spare parts, please check at pages 194-199.

Conversions from metric to U.S. measurements are approximate.

K 1210 Eero Aarnio

Material Brass Collection Fusital

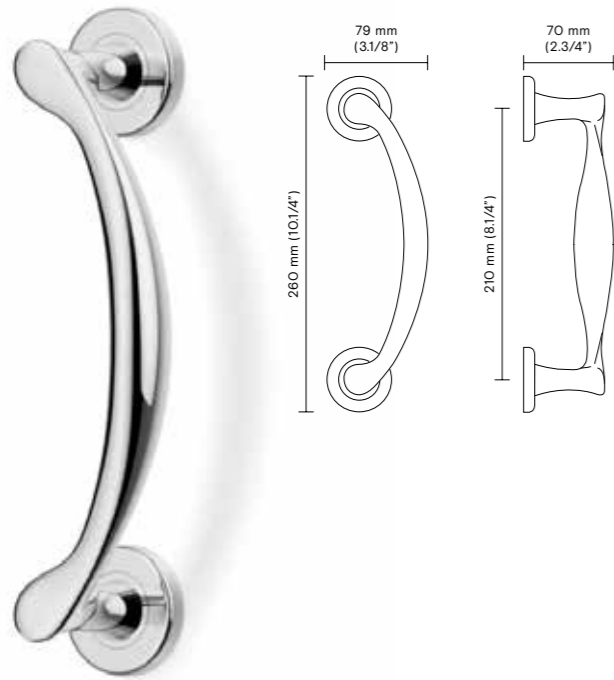

Retail price

| Finish | Center to center (mm/inches) | Single |
|--------------------------|------------------------------|------------|
| 06A Anticato | 210 (8.1/4") | \$ 279 .00 |
| 03 Polished brass | 210 (8.1/4") | \$ 279 .00 |
| 26D Satin chrome | 210 (8.1/4") | \$ 291 .00 |

Note: Complete with fixing systems for single and back to back mounting on wood (X O326, X O523) and glass doors (X O525, X O523).

Possibility of mounting without cover-nut rosettes.

K 1224

Material Stainless Steel AISI 304 Collection Lab

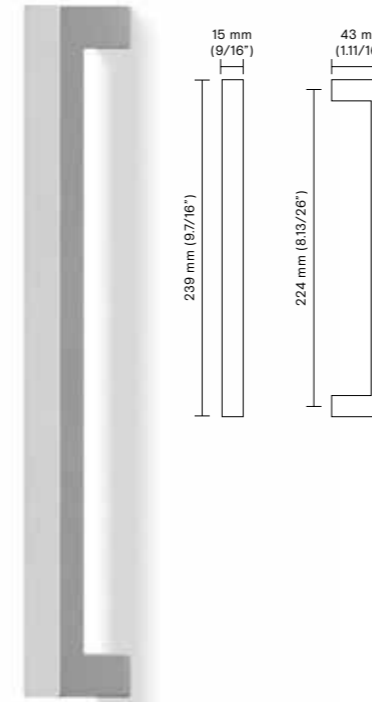

Retail price

| Finish | Center to center (mm/inches) | Single | Back to back |
|----------------------------------|------------------------------|------------|--------------|
| 32D Satin stainless steel | 224 (8.13/16") | \$ 827 .00 | \$ 258 .00 |

Note: Complete with fixing systems for single and back to back mounting on wood (X O373). For glass doors it can only be installed back to back (X O373).

K 1219

Material Stainless Steel AISI 304 Collection Lab

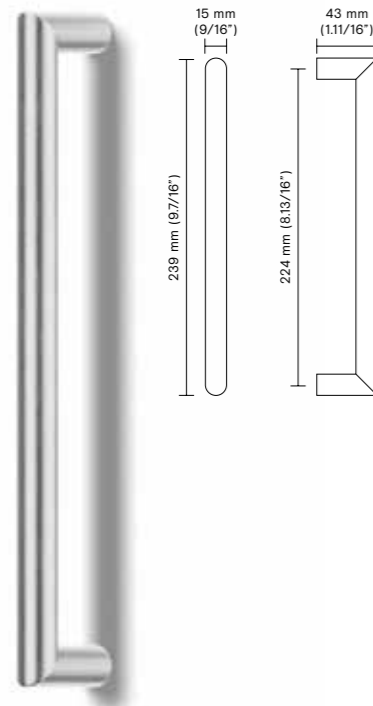

Retail price

| Finish | Center to center (mm/inches) | Single | Back to back |
|------------------------------------|------------------------------|------------|--------------|
| 32 Polished stainless steel | 224 (8.13/16") | \$ 127 .00 | \$ 258 .00 |
| 32D Satin stainless steel | 224 (8.13/16") | \$ 104 .00 | \$ 250 .00 |

Note: Complete with fixing systems for single and back to back mounting on wood (X O373). For glass doors it can only be installed back to back (X O373).

K 1226 Jean-Baptiste Sibertin Blanc

Material Brass Collection Fusital

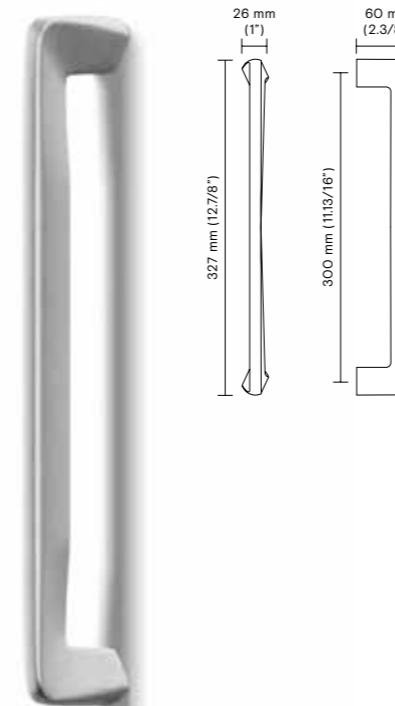

Retail price

| Finish | Center to center (mm/inches) | Single | Back to back |
|---|------------------------------|------------|--------------|
| 26D/26 Satin chrome / Polished chrome* | 300 (11.13/16") | \$ 399 .00 | \$ 827 .00 |

* The front and the side edge are polished, while the rest is satin.

Note: Complete with fixing systems for single and back to back mounting on wood (X O531, X O528) and glass doors (X O530, X O528).

All the options listed in this page are considered standard. For more options on finishes, see pages 12-13, and upcharges at page 17.

For fixing spare parts, please check at pages 194-199.

Conversions from metric to U.S. measurements are approximate.

All the options listed in this page are considered standard. For more options on finishes, see pages 12-13, and upcharges at page 17.

For fixing spare parts, please check at pages 194-199.

Conversions from metric to U.S. measurements are approximate.

K 1228 Yoshimi Kono

Material Brass Collection Fusital

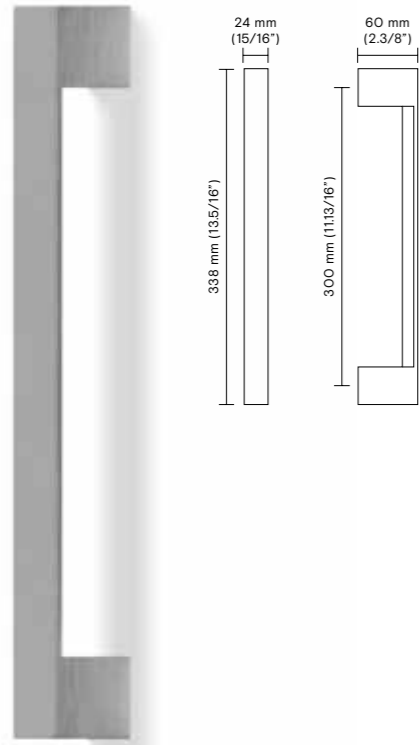

Retail price

| Finish | Center to center (mm/inches) | Single | Back to back |
|---------------------------|------------------------------|-----------|--------------|
| 26 Polished chrome | 300 (11.13/16") | \$ 386.00 | \$ 820.00 |

Note: Complete with fixing systems for single and back to back mounting on wood (X 0531, X 0528) and glass doors (X 0530, X 0528).

K 1235

Material Aluminum Collection Lab

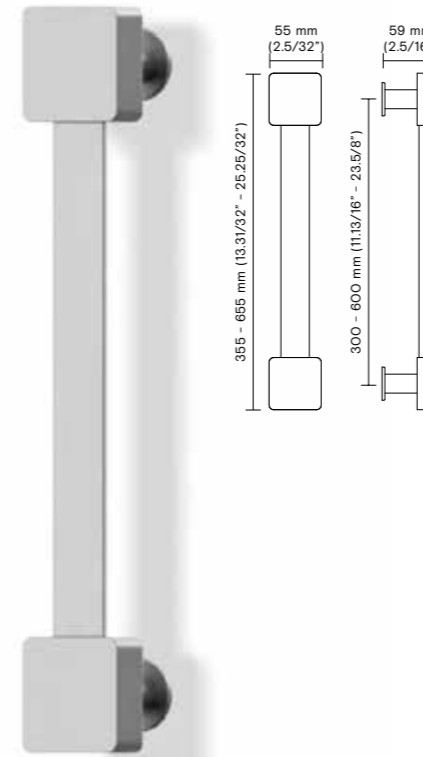

Retail price

| Finish | Center to center (mm/inches) | Single | Back to back |
|---------------------------|------------------------------|-----------|--------------|
| 26 Polished chrome | 300 (11.13/16") | \$ 389.00 | \$ 823.00 |
| | 600 (23.5/8") | \$ 389.00 | \$ 823.00 |
| 26D Satin chrome | 300 (11.13/16") | \$ 436.00 | \$ 915.00 |
| | 600 (23.5/8") | \$ 436.00 | \$ 915.00 |

Note: Complete with fixing systems for single and back to back mounting on wood (X 0531, X 0528) and glass doors (X 0530, X 0528).

K 1231

Material Brass Collection Lab

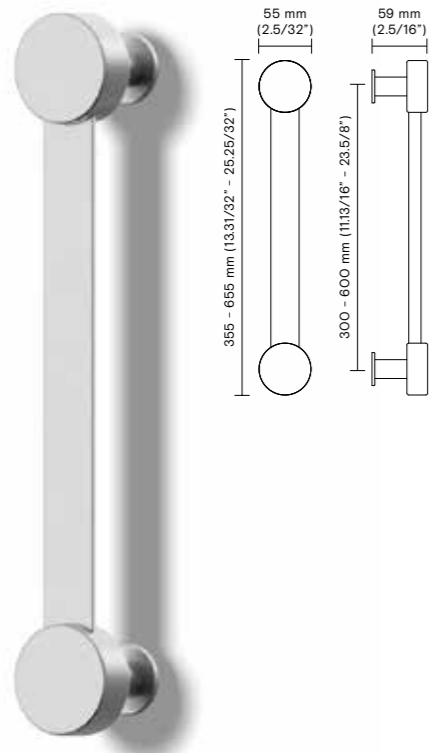

Retail price

| Finish | Center to center (mm/inches) | Single | Back to back |
|---------------------------|------------------------------|-----------|--------------|
| 06M Matt bronze | 300 (11.13/16") | \$ 371.00 | \$ 786.00 |
| | 600 (23.5/8") | \$ 441.00 | \$ 926.00 |
| 16 Dull black | 300 (11.13/16") | \$ 306.00 | \$ 657.00 |
| | 600 (23.5/8") | \$ 353.00 | \$ 749.00 |
| 22M Matt white | 300 (11.13/16") | \$ 306.00 | \$ 657.00 |
| | 600 (23.5/8") | \$ 353.00 | \$ 749.00 |
| 26 Polished chrome | 300 (11.13/16") | \$ 313.00 | \$ 670.00 |
| | 600 (23.5/8") | \$ 361.00 | \$ 767.00 |
| 26D Satin chrome | 300 (11.13/16") | \$ 313.00 | \$ 670.00 |
| | 600 (23.5/8") | \$ 361.00 | \$ 767.00 |

Note: Complete with fixing systems for single and back to back mounting on wood (X 0531, X 0528) and glass doors (X 0530, X 0528).

P 5405 Taller Design Ricardo Bofill

Material Stainless steel AISI 316 L Collection Fusital

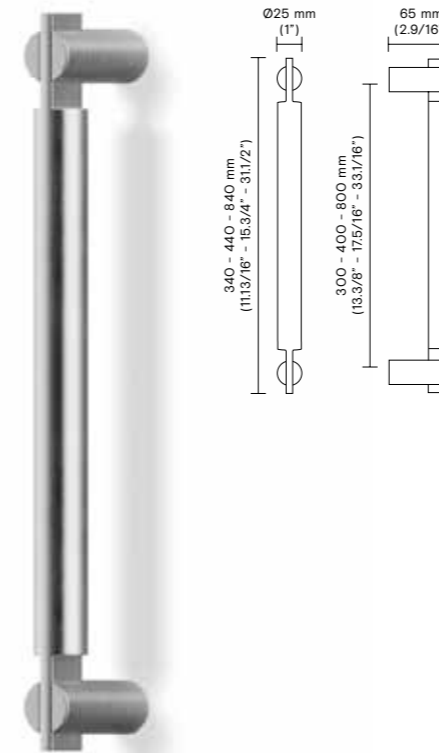

Retail price

| Finish | Center to center (mm/inches) | Single | Back to back |
|------------------------------------|------------------------------|-------------|--------------|
| 32 Polished stainless steel | 300 (11.13/16") | \$ 1,014.00 | \$ 2,139.00 |
| | 400 (15.3/4") | \$ 1,287.00 | \$ 2,683.00 |
| | 800 (31.1/2") | \$ 1,569.00 | \$ 3,246.00 |
| 32D Satin stainless steel | 300 (11.13/16") | \$ 781.00 | \$ 1,670.00 |
| | 400 (15.3/4") | \$ 984.00 | \$ 2,075.00 |
| | 800 (31.1/2") | \$ 1,199.00 | \$ 2,506.00 |

Note: Complete with fixing systems for single and back to back mounting on wood (X 0510, X 0509) and glass doors (X 0508, X 0510).

All the options listed in this page are considered standard. For more options on finishes, see pages 12-13, and upcharges at page 17.

For fixing spare parts, please check at pages 194-199.

Conversions from metric to U.S. measurements are approximate.

All the options listed in this page are considered standard. For more options on finishes, see pages 12-13, and upcharges at page 17.

For fixing spare parts, please check at pages 194-199.

Conversions from metric to U.S. measurements are approximate.

P 5406 Antonio Citterio

Material Stainless steel AISI 316 L Collection Fusital

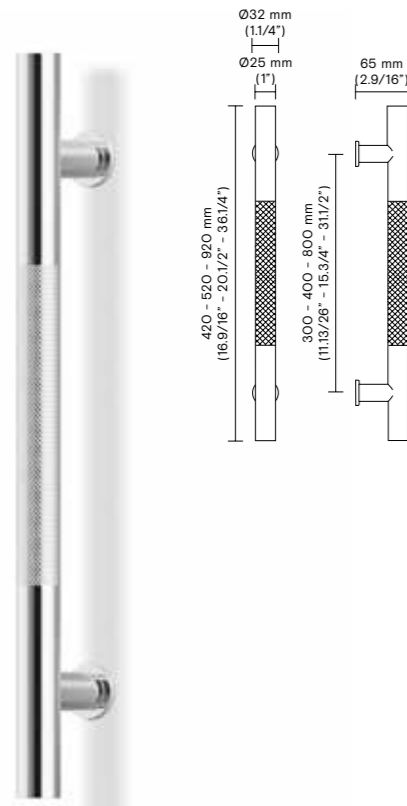

Retail price

| Finish | Center to center (mm/inches) | Single | Back to back |
|-----------------------------|------------------------------|-------------|--------------|
| 32 Polished stainless steel | 300 (11.13/16") | \$ 1,025.00 | \$ 2,160.00 |
| | 400 (15.3/4") | \$ 1,412.00 | \$ 2,934.00 |
| | 800 (31.1/2") | \$ 1,722.00 | \$ 3,552.00 |
| 32D Satin stainless steel | 300 (11.13/16") | \$ 823.00 | \$ 1,754.00 |
| | 400 (15.3/4") | \$ 1,082.00 | \$ 2,266.00 |
| | 800 (31.1/2") | \$ 1,316.00 | \$ 2,737.00 |

Note: Complete with fixing systems for single and back to back mounting on wood (X 0510, X 0509) and glass doors (X 0508, X 0510).

P 5408 Antonio Citterio

Material Stainless steel AISI 316 L Collection Fusital

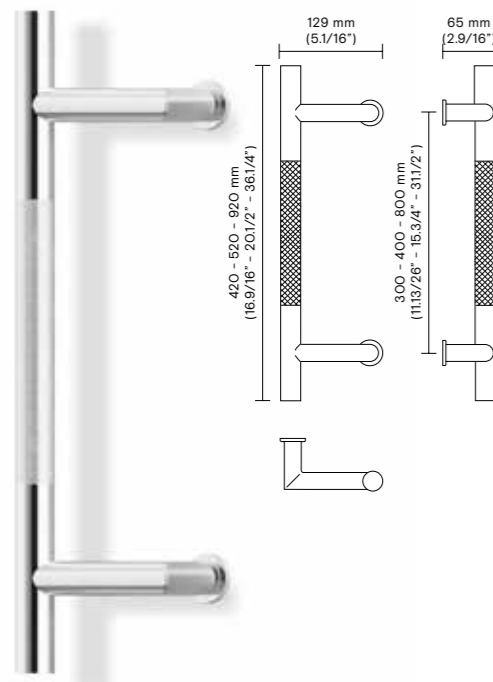

Retail price

| Finish | Center to center (mm/inches) | Single | Back to back |
|-----------------------------|------------------------------|-------------|--------------|
| 32 Polished stainless steel | 300 (11.13/16") | \$ 1,831.00 | \$ 3,773.00 |
| | 400 (15.3/4") | \$ 2,162.00 | \$ 4,433.00 |
| | 800 (31.1/2") | \$ 2,499.00 | \$ 5,106.00 |
| 32D Satin stainless steel | 300 (11.13/16") | \$ 1,413.00 | \$ 2,936.00 |
| | 400 (15.3/4") | \$ 1,658.00 | \$ 3,526.00 |
| | 800 (31.1/2") | \$ 1,916.00 | \$ 3,939.00 |

Note: Complete with fixing systems for single and back to back mounting on wood (X 0510, X 0509) and glass doors (X 0508, X 0510).

All the options listed in this page are considered standard. For more options on finishes, see pages 12-13, and upcharges at page 17.

For fixing spare parts, please check at pages 194-199.

Conversions from metric to U.S. measurements are approximate.

Each handleset can be matched with an interior lever.

Any lever can be used as interior trim.

Choose a lever model from one of the groups on the front page.

K 1810 Entry Handleset

Choose any lever as interior trim.

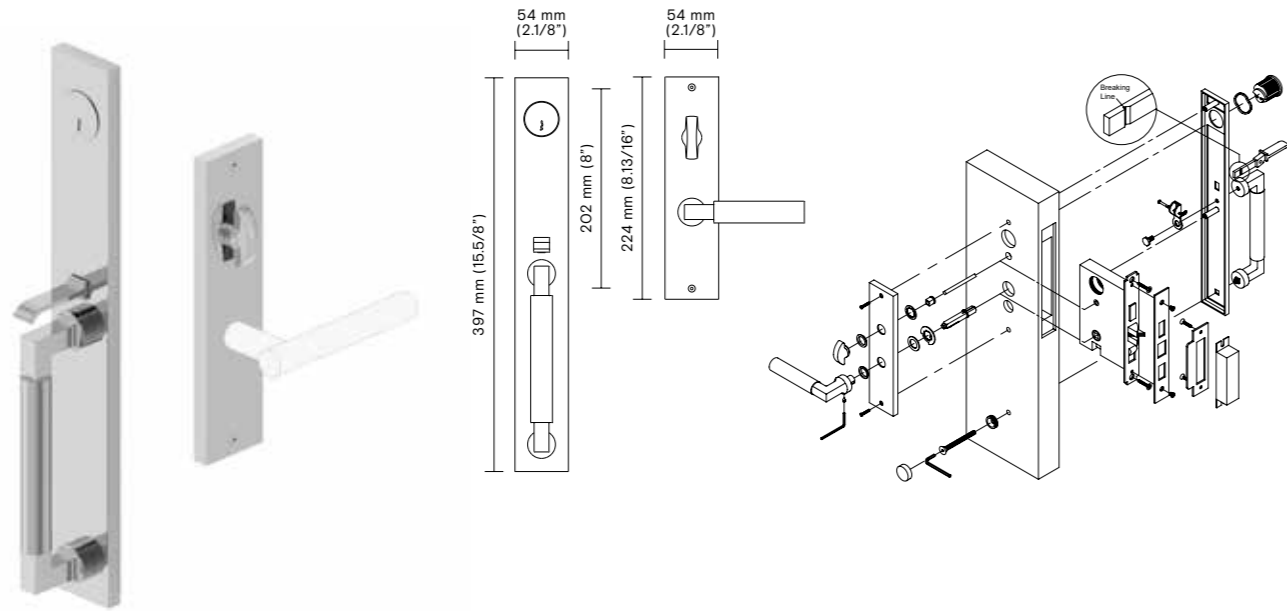

K 1869 Entry Handleset

Choose any lever as interior trim.

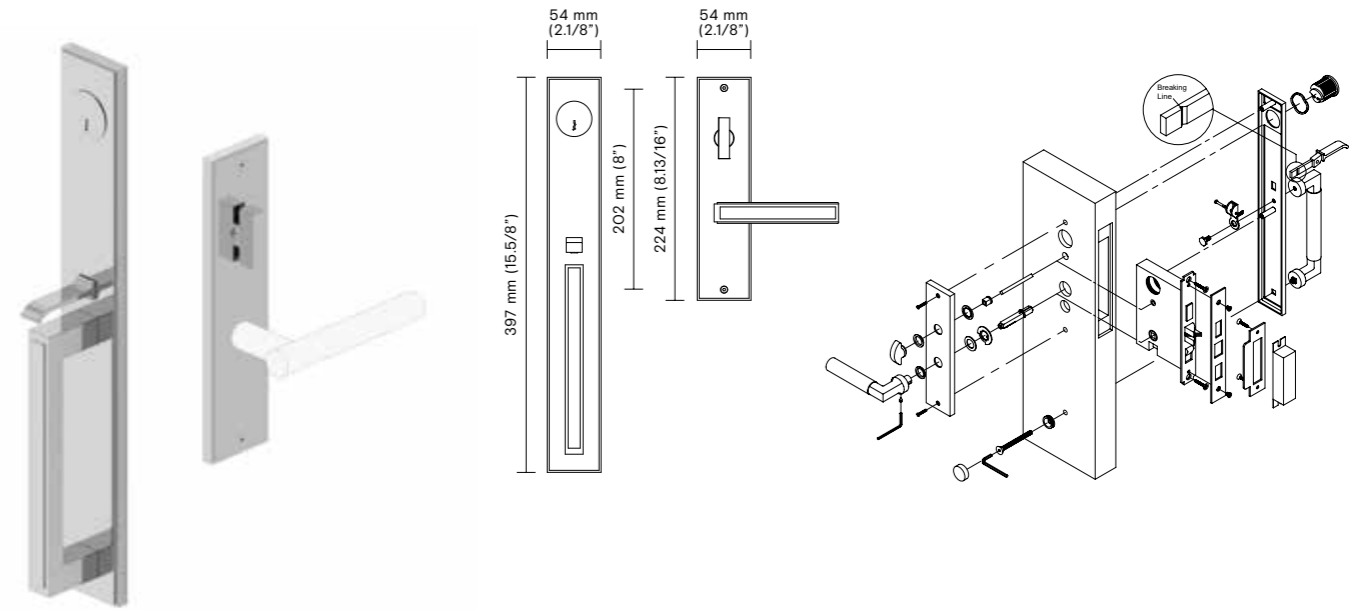

K 1868 Entry Handleset

Choose any lever as interior trim.

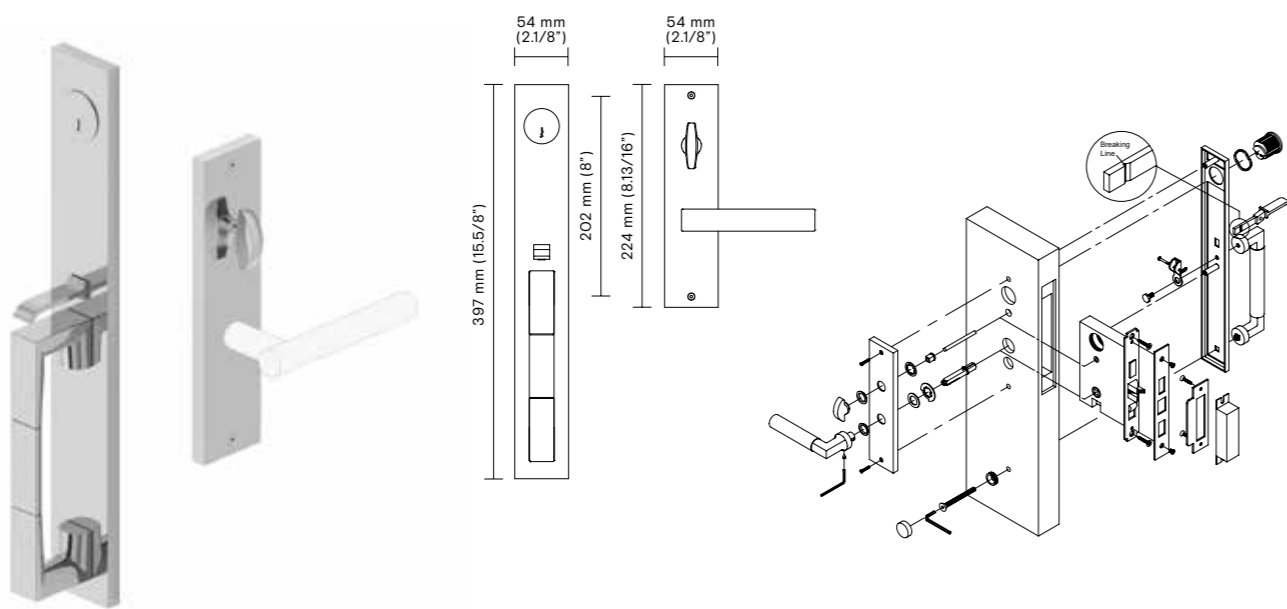

K 1870 Entry Handleset

Choose any lever as interior trim.

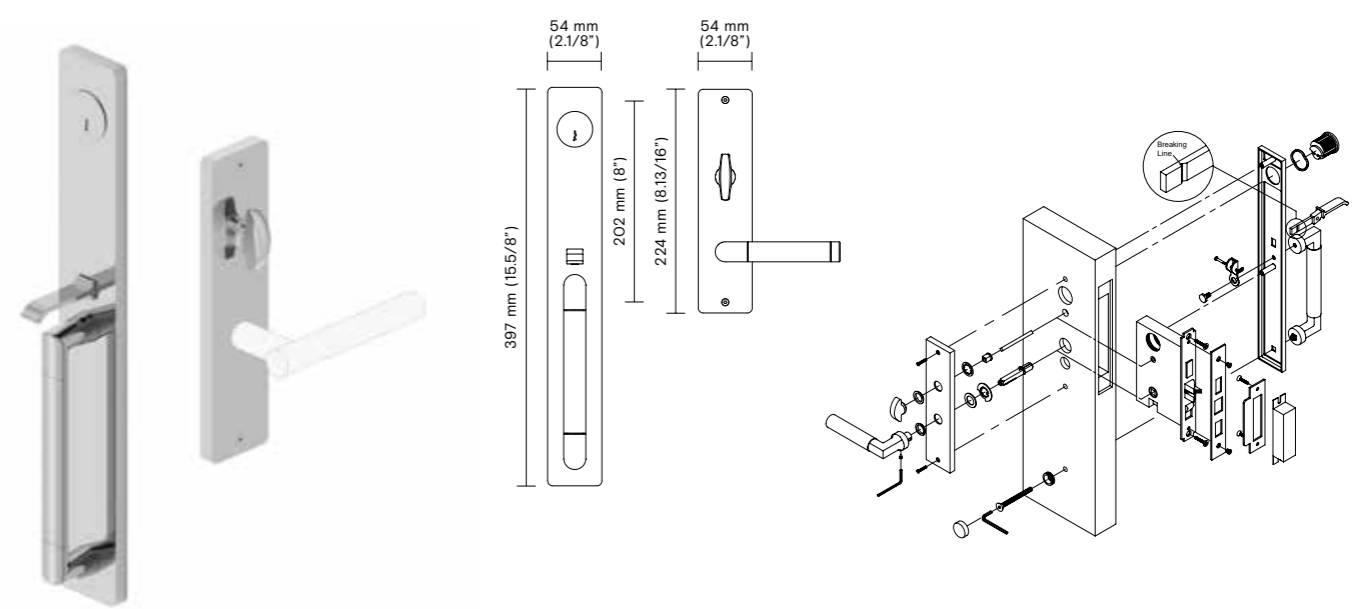

Group 1

H 198, H 1003, H 1022, H 1024, H 1050, H 4730, H 4742, K 1155, K 1168, K 1170

| Finish | K 1810 | | K 1868 | | K 1869 | | K 1870 | |
|--------------------|-------------|--------------|-------------|--------------|-------------|--------------|-------------|--------------|
| | Entry ENT | Dummy Set FD | Entry ENT | Dummy Set FD | Entry ENT | Dummy Set FD | Entry ENT | Dummy Set FD |
| 26 Polished chrome | \$ 1,454.00 | \$ 668.00 | \$ 1,599.00 | \$ 780.00 | \$ 1,454.00 | \$ 709.00 | \$ 1,454.00 | \$ 709.00 |
| 26D Satin chrome | \$ 1,491.00 | \$ 734.00 | \$ 1,640.00 | \$ 807.00 | \$ 1,491.00 | \$ 734.00 | \$ 1,491.00 | \$ 734.00 |

Group 2

H 1016, H 1026, H 1027, H 1044 U, H 1045, H 1046, H 1049, H 1052, H 1054, H 1056, H 1057, H 1062, H 1066

| Finish | K 1810 | | K 1868 | | K 1869 | | K 1870 | |
|--------------------|-------------|--------------|-------------|--------------|-------------|--------------|-------------|--------------|
| | Entry ENT | Dummy Set FD | Entry ENT | Dummy Set FD | Entry ENT | Dummy Set FD | Entry ENT | Dummy Set FD |
| 26 Polished chrome | \$ 1,479.00 | \$ 747.00 | \$ 1,627.00 | \$ 821.00 | \$ 1,479.00 | \$ 747.00 | \$ 1,479.00 | \$ 747.00 |
| 26D Satin chrome | \$ 1,504.00 | \$ 759.00 | \$ 1,655.00 | \$ 834.00 | \$ 1,504.00 | \$ 759.00 | \$ 1,504.00 | \$ 759.00 |

Group 3

H 1039, H 1040, H 1060, H 1068, H 1069, H 1748, K 1054, K 1056, K 1060, K 1171, K 1730

| Finish | K 1810 | | K 1868 | | K 1869 | | K 1870 | |
|--------------------|-------------|--------------|-------------|--------------|-------------|--------------|-------------|--------------|
| | Entry ENT | Dummy Set FD | Entry ENT | Dummy Set FD | Entry ENT | Dummy Set FD | Entry ENT | Dummy Set FD |
| 26 Polished chrome | \$ 1,627.00 | \$ 859.00 | \$ 1,752.00 | \$ 945.00 | \$ 1,592.00 | \$ 859.00 | \$ 1,592.00 | \$ 859.00 |
| 26D Satin chrome | \$ 1,655.00 | \$ 873.00 | \$ 1,778.00 | \$ 960.00 | \$ 1,617.00 | \$ 873.00 | \$ 1,617.00 | \$ 873.00 |

Group 4

H 163, H 411, H 1043, H 1044, H 1058

| Finish | K 1810 | | K 1868 | | K 1869 | | K 1870 | |
|--------------------|-------------|--------------|-------------|--------------|-------------|--------------|-------------|--------------|
| | Entry ENT | Dummy Set FD | Entry ENT | Dummy Set FD | Entry ENT | Dummy Set FD | Entry ENT | Dummy Set FD |
| 26 Polished chrome | \$ 1,415.00 | \$ 683.00 | \$ 1,556.00 | \$ 752.00 | \$ 1,415.00 | \$ 683.00 | \$ 1,415.00 | \$ 683.00 |
| 26D Satin chrome | \$ 1,454.00 | \$ 696.00 | \$ 1,599.00 | \$ 765.00 | \$ 1,454.00 | \$ 696.00 | \$ 1,454.00 | \$ 696.00 |

All the options listed in this page are considered standard.
For more options on finishes, see pages 12-13, and upcharges at page 17.

Group 5

H 315, H 317, H 327, H 330, H 334, H 338, H 348, H 361, H 364, H 367, H 368, H 370, H 372, H 381, H 382, H 383, H 385, H 386, K 383

| Finish | K 1810 | | K 1868 | | K 1869 | | K 1870 | |
|--------------------|-------------|--------------|-------------|--------------|-------------|--------------|-------------|--------------|
| | Entry ENT | Dummy Set FD | Entry ENT | Dummy Set FD | Entry ENT | Dummy Set FD | Entry ENT | Dummy Set FD |
| 26 Polished chrome | \$ 1,516.00 | \$ 773.00 | \$ 1,516.00 | \$ 773.00 | \$ 1,516.00 | \$ 773.00 | \$ 1,516.00 | \$ 773.00 |
| 26D Satin chrome | \$ 1,555.00 | \$ 785.00 | \$ 1,555.00 | \$ 785.00 | \$ 1,555.00 | \$ 785.00 | \$ 1,555.00 | \$ 785.00 |

Group 6

H 311, H 329, H 335, H 343, H 359, H 376, H 378, H 384, K 378

| Finish | K 1810 | | K 1868 | | K 1869 | | K 1870 | |
|--------------------|-------------|--------------|-------------|--------------|-------------|--------------|-------------|--------------|
| | Entry ENT | Dummy Set FD | Entry ENT | Dummy Set FD | Entry ENT | Dummy Set FD | Entry ENT | Dummy Set FD |
| 26 Polished chrome | \$ 1,579.00 | \$ 848.00 | \$ 1,579.00 | \$ 848.00 | \$ 1,579.00 | \$ 848.00 | \$ 1,579.00 | \$ 848.00 |
| 26D Satin chrome | \$ 1,617.00 | \$ 859.00 | \$ 1,617.00 | \$ 859.00 | \$ 1,617.00 | \$ 859.00 | \$ 1,617.00 | \$ 859.00 |

Group 7

H 377, K 377

| Finish | K 1810 | | K 1868 | | K 1869 | | K 1870 | |
|--------------------|-------------|--------------|-------------|--------------|-------------|--------------|-------------|--------------|
| | Entry ENT | Dummy Set FD | Entry ENT | Dummy Set FD | Entry ENT | Dummy Set FD | Entry ENT | Dummy Set FD |
| 26 Polished chrome | \$ 1,768.00 | \$ 1,037.00 | \$ 1,768.00 | \$ 1,037.00 | \$ 1,768.00 | \$ 1,037.00 | \$ 1,768.00 | \$ 1,037.00 |
| 26D Satin chrome | \$ 1,793.00 | \$ 1,049.00 | \$ 1,793.00 | \$ 1,049.00 | \$ 1,793.00 | \$ 1,049.00 | \$ 1,793.00 | \$ 1,049.00 |

Group 8

H 356, H 379, H 380

| Finish | K 1810 | | K 1868 | | K 1869 | | K 1870 | |
|--------------------|-------------|--------------|-------------|--------------|-------------|--------------|-------------|--------------|
| | Entry ENT | Dummy Set FD | Entry ENT | Dummy Set FD | Entry ENT | Dummy Set FD | Entry ENT | Dummy Set FD |
| 26 Polished chrome | \$ 1,793.00 | \$ 1,075.00 | \$ 1,793.00 | \$ 1,075.00 | \$ 1,793.00 | \$ 1,075.00 | \$ 1,793.00 | \$ 1,075.00 |
| 26D Satin chrome | \$ 1,832.00 | \$ 1,100.00 | \$ 1,832.00 | \$ 1,100.00 | \$ 1,832.00 | \$ 1,100.00 | \$ 1,832.00 | \$ 1,100.00 |

All the options listed in this page are considered standard.
For more options on finishes, see pages 12-13, and upcharges at page 17.

K 1186 Dummy

Material Brass Collection Lab



Retail price

| Finish | Door thickness 1.3/4" | Door thickness 1.3/8" |
|---------------------------|-----------------------|-----------------------|
| O3 Polished brass | \$ 78.00 | \$ 78.00 |
| O3D Satin brass | \$ 78.00 | \$ 78.00 |
| O6A Anticato | \$ 81.00 | \$ 81.00 |
| O6B Brunito | \$ 78.00 | \$ 78.00 |
| 15 Satin nickel | \$ 99.00 | \$ 99.00 |
| 26 Polished chrome | \$ 78.00 | \$ 78.00 |
| 26D Satin chrome | \$ 81.00 | \$ 81.00 |

Dummy piece.

K 1202 Passage

Material Brass Collection Lab

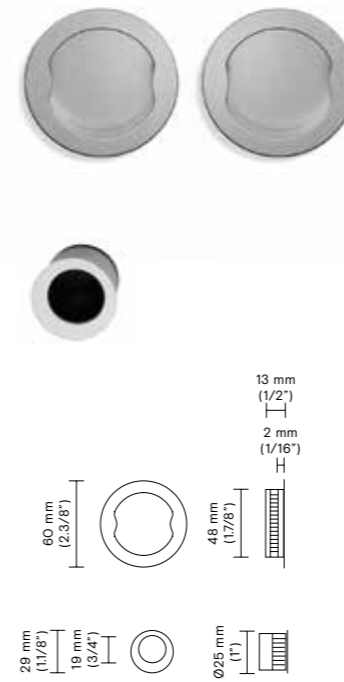

Retail price

| Finish | Door thickness 1.3/4" | Door thickness 1.3/8" |
|---------------------------|-----------------------|-----------------------|
| O3 Polished brass | \$ 127.00 | \$ 127.00 |
| O3D Satin brass | \$ 127.00 | \$ 127.00 |
| O6A Anticato | \$ 127.00 | \$ 127.00 |
| O6B Brunito | \$ 127.00 | \$ 127.00 |
| 15 Satin nickel | \$ 184.00 | \$ 184.00 |
| 26 Polished chrome | \$ 142.00 | \$ 142.00 |
| 26D Satin chrome | \$ 142.00 | \$ 142.00 |

Complete set with recessed finger pull - no lock.

K 1195 Dummy

Material Brass Collection Lab



Retail price

| Finish | Door thickness 1.3/4" | Door thickness 1.3/8" |
|---------------------------|-----------------------|-----------------------|
| 26 Polished chrome | \$ 86.00 | \$ 86.00 |
| 26D Satin chrome | \$ 90.00 | \$ 90.00 |

Dummy piece.

K 1203 Finger Pull

Material Brass Collection Lab

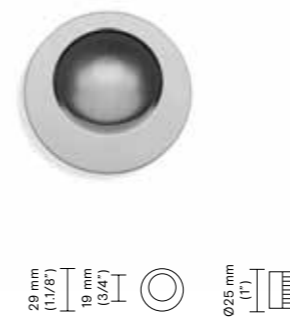

Retail price

| Finish | Door thickness 1.3/4" | Door thickness 1.3/8" |
|---------------------------|-----------------------|-----------------------|
| O3 Polished brass | \$ 33.00 | \$ 33.00 |
| O3D Satin brass | \$ 33.00 | \$ 33.00 |
| O6A Anticato | \$ 33.00 | \$ 33.00 |
| 15 Satin nickel | \$ 35.00 | \$ 35.00 |
| 26 Polished chrome | \$ 35.00 | \$ 35.00 |
| 26D Satin chrome | \$ 35.00 | \$ 35.00 |

Recessed finger pull - spare apart.

All the options listed in this page are considered standard.
For more options on finishes, see pages 12-13, and upcharges at page 17.
Conversions from metric to U.S. measurements are approximate.

The privacy flush pulls accommodate 1 3/4" and 1 3/8" door thickness.
1 3/8" door thickness requires minimum pocket width of 2 1/8",
a spacer will add 1/8" to surface on both sides of the door.
Conversions from metric to U.S. measurements are approximate.

The finishes above are considered standard.
For different finish options see pages 12-13 and pricing at page 17.

K 1204 Privacy

Material Brass Collection Lab



Retail price

| Finish | Door thickness 1.3/4" | Door thickness 1.3/8" |
|---------------------------|-----------------------|-----------------------|
| 03 Polished brass | \$ 263.00 | \$ 263.00 |
| 03D Satin brass | \$ 263.00 | \$ 263.00 |
| 06A Anticato | \$ 263.00 | \$ 263.00 |
| 15 Satin nickel | \$ 418.00 | \$ 418.00 |
| 26 Polished chrome | \$ 289.00 | \$ 289.00 |
| 26D Satin chrome | \$ 289.00 | \$ 289.00 |

Complete set with European style lock and recessed finger pull.

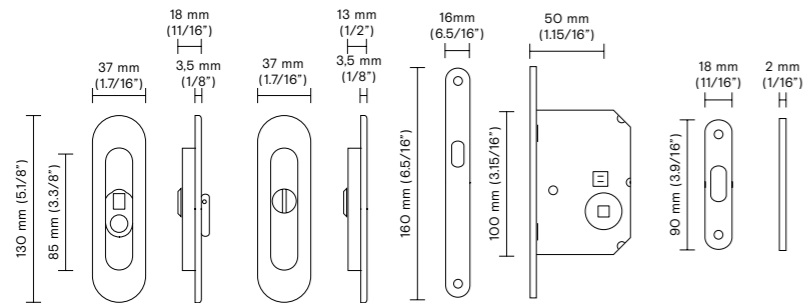

K 1211 Privacy

Material Brass Collection Lab

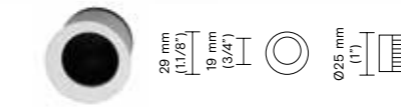

Retail price

| Finish | Function Privacy Door thickness 1.3/4" | Door thickness 1.3/8" |
|---------------------------|--|-----------------------|
| 03 Polished brass | \$ 384.00 | \$ 464.00 |
| 14 Polished nickel | \$ 437.00 | \$ 531.00 |
| 15 Satin nickel | \$ 418.00 | \$ 497.00 |
| 26 Polished chrome | \$ 399.00 | \$ 464.00 |
| 26D Satin chrome | \$ 399.00 | \$ 464.00 |

Complete set with European lock and recessed finger pull.

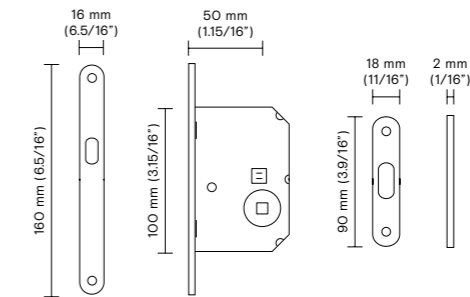
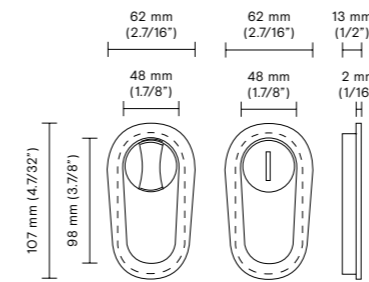

K 1206 Passage

Material Brass Collection Lab

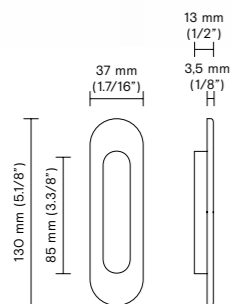
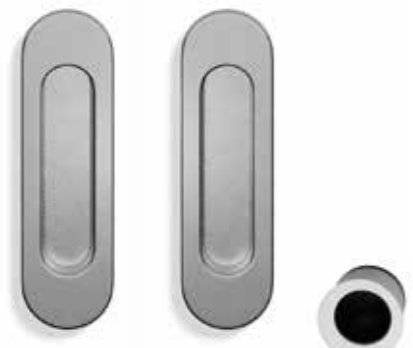

Retail price

| Finish | Door thickness 1.3/4" | Door thickness 1.3/8" |
|---------------------------|-----------------------|-----------------------|
| 03 Polished brass | \$ 158.00 | \$ 158.00 |
| 03D Satin brass | \$ 158.00 | \$ 158.00 |
| 06A Anticato | \$ 158.00 | \$ 158.00 |
| 15 Satin nickel | \$ 250.00 | \$ 250.00 |
| 26 Polished chrome | \$ 173.00 | \$ 173.00 |
| 26D Satin chrome | \$ 173.00 | \$ 173.00 |

Complete set with recessed finger pull - no lock.



The privacy flush pulls accommodate 1 3/4" and 1 3/8" door thickness. 1 3/8" door thickness requires minimum pocket width of 2 1/8", a spacer will add 1/8" to surface on both sides of the door. Conversions from metric to U.S. measurements are approximate.

The finishes above are considered standard. For different finish options see pages 12-13 and pricing at page 17. The thumb turn protrudes 7/32" from surface plate. The pocket door thumb turn does not flush complete.

Satin nickel trims are combined with Satin chrome face and strike plates. Polished nickel trims are combined with Polished chrome face and strike plates.

K 1212 Passage

Material Brass Collection Lab

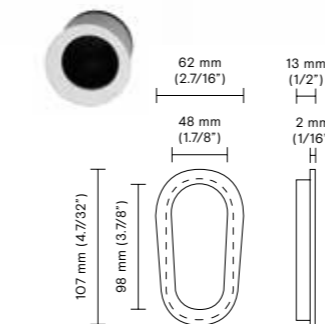

Retail price

| Finish | Door thickness 1.3/4" | Door thickness 1.3/8" |
|---------------------------|-----------------------|-----------------------|
| 03 Polished brass | \$ 198.00 | \$ 198.00 |
| 14 Polished nickel | \$ 281.00 | \$ 281.00 |
| 15 Satin nickel | \$ 227.00 | \$ 227.00 |
| 26 Polished chrome | \$ 252.00 | \$ 252.00 |
| 26D Satin chrome | \$ 215.00 | \$ 215.00 |

Complete set with recessed finger pull - no lock.



The privacy flush pulls accommodate 1 3/4" and 1 3/8" door thickness. 1 3/8" door thickness requires minimum pocket width of 2 1/8", a spacer will add 1/8" to surface on both sides of the door. Conversions from metric to U.S. measurements are approximate.

The finishes above are considered standard. For different finish options see pages 12-13 and pricing at page 17. The thumb turn protrudes 7/32" from surface plate. The pocket door thumb turn does not flush complete.

Satin nickel trims are combined with Satin chrome face and strike plates. Polished nickel trims are combined with Polished chrome face and strike plates.

K 1215 Privacy

Material Brass Collection Lab

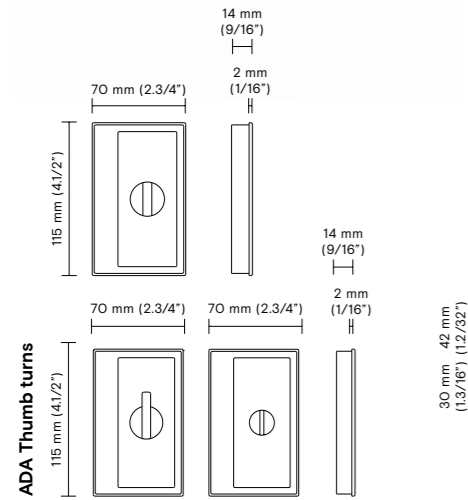

Retail price

| Finish | Privacy Standard | Privacy ADA |
|--------------------|------------------|-------------|
| 14 Polished nickel | \$ 1,367.00 | \$ 1,572.00 |
| 15 Satin nickel | \$ 1,190.00 | \$ 1,368.00 |
| 16 Dull black | \$ 1,246.00 | \$ 1,420.00 |
| 26 Polished chrome | \$ 1,190.00 | \$ 1,368.00 |
| 26D Satin chrome | \$ 1,190.00 | \$ 1,368.00 |

Complete set with interior, exterior trim and pull-out mortise lock.

Minimum door thickness: 1.3/4"
Must specify backset: 2.1/2" or 2.3/4".

Other backsets are available on special request.

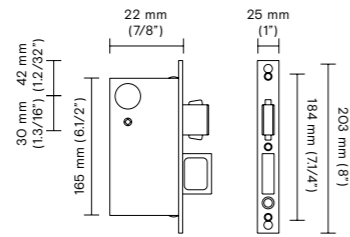

K 1215 Entry

Material Brass Collection Lab

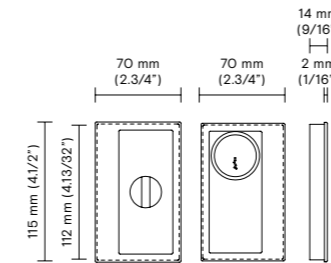

Retail price

| Finish | Door thickness 1.3/4" | Door thickness 1.3/8" |
|--------------------|-----------------------|-----------------------|
| 14 Polished nickel | \$ 1,572.00 | \$ 1,572.00 |
| 15 Satin nickel | \$ 1,368.00 | \$ 1,368.00 |
| 16 Dull black | \$ 1,420.00 | \$ 1,420.00 |
| 26 Polished chrome | \$ 1,368.00 | \$ 1,368.00 |
| 26D Satin chrome | \$ 1,368.00 | \$ 1,368.00 |

Complete set with American mortise lock.
Complete set with interior, exterior trim and pull-out mortise lock.

Minimum door thickness: 1.3/4"
Must specify backset: 2.1/2" or 2.3/4".
Other backsets are available on special request.

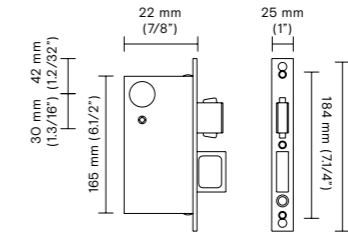

K 1215 Dummy

Material Brass Collection Lab

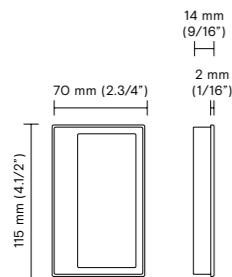

Retail price

| Finish | Door thickness 1.3/4" | Door thickness 1.3/8" |
|--------------------|-----------------------|-----------------------|
| 14 Polished nickel | \$ 164.00 | \$ 164.00 |
| 15 Satin nickel | \$ 155.00 | \$ 155.00 |
| 16 Dull black | \$ 117.00 | \$ 117.00 |
| 26 Polished chrome | \$ 164.00 | \$ 164.00 |
| 26D Satin chrome | \$ 155.00 | \$ 155.00 |

Single dummy pull.

K 1215 Passage

Material Brass Collection Lab

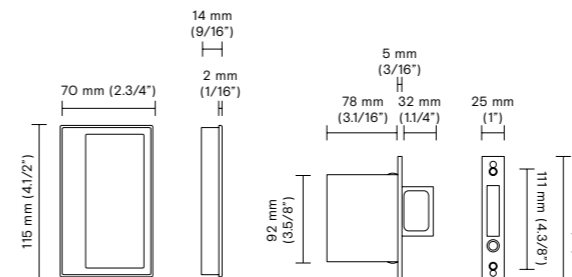

Retail price

| Finish | Function Passage Door thickness 1.3/4" | Door thickness 1.3/8" |
|--------------------|--|-----------------------|
| 14 Polished nickel | \$ 814.00 | \$ 814.00 |
| 15 Satin nickel | \$ 814.00 | \$ 814.00 |
| 16 Dull black | \$ 814.00 | \$ 814.00 |
| 26 Polished chrome | \$ 814.00 | \$ 814.00 |
| 26D Satin chrome | \$ 814.00 | \$ 814.00 |

Conversions from metric to U.S. measurements are approximate.

The finishes above are considered standard.
For different finish options see pages 12-13 and pricing at page 17.

Conversions from metric to U.S. measurements are approximate.

The finishes above are considered standard.
For different finish options see pages 12-13 and pricing at page 17.

K 1230 Privacy • Yoshimi Kono

Material Brass Collection Fusital

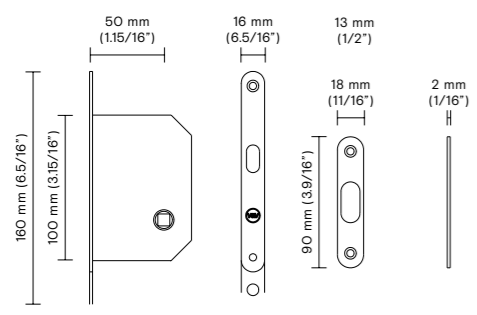
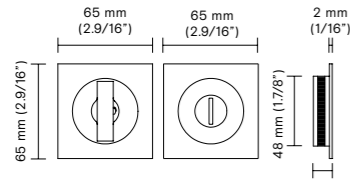
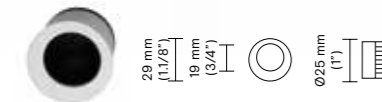

Retail price

| Finish | Door thickness 1.3/4" | Door thickness 1.3/8" |
|--------------------|-----------------------|-----------------------|
| 14 Polished nickel | \$ 374.00 | \$ 430.00 |
| 15 Satin nickel | \$ 374.00 | \$ 430.00 |
| 26 Polished chrome | \$ 326.00 | \$ 376.00 |
| 26D Satin chrome | \$ 341.00 | \$ 388.00 |

Complete set with European style lock and recessed finger pull.
Also available with American privacy lock. For details of the lock please see page 144.
For prices please contact our customer service.

K 3012 Privacy • Antonio Citterio with Toan Nguyen

Material Brass Collection Fusital

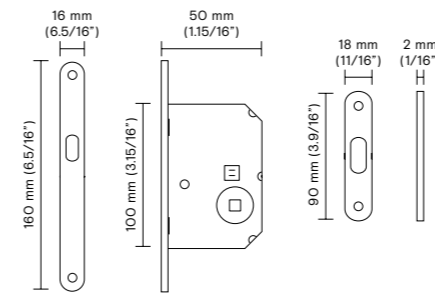
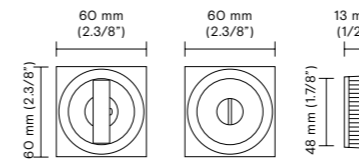
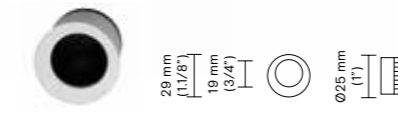

Retail price

| Finish | Door thickness 1.3/4" | Door thickness 1.3/8" |
|--------------------|-----------------------|-----------------------|
| 14 Polished nickel | \$ 428.00 | \$ 492.00 |
| 15 Satin nickel | \$ 428.00 | \$ 492.00 |
| 26 Polished chrome | \$ 378.00 | \$ 429.00 |
| 26D Satin chrome | \$ 397.00 | \$ 447.00 |

Complete set with European style lock and recessed finger pull.
Also available with American privacy lock. For details of the lock please see page 144.
For prices please contact our customer service.

K 1232 Passage • Yoshimi Kono

Material Brass Collection Fusital

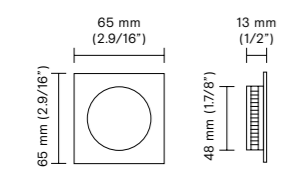

Retail price

| Finish | Door thickness 1.3/4" | Door thickness 1.3/8" |
|--------------------|-----------------------|-----------------------|
| 14 Polished nickel | \$ 189.00 | \$ 189.00 |
| 15 Satin nickel | \$ 184.00 | \$ 184.00 |
| 26 Polished chrome | \$ 165.00 | \$ 165.00 |
| 26D Satin chrome | \$ 172.00 | \$ 172.00 |

Complete set with recessed finger pull - no lock.
Also available with American passage lock. For details of the lock please see page 145.
For prices please contact our customer service.

K 3014 Passage • Antonio Citterio with Toan Nguyen

Material Brass Collection Fusital

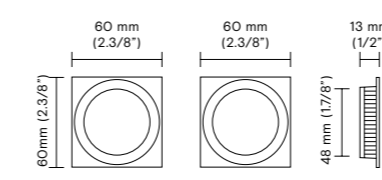

Retail price

| Finish | Door thickness 1.3/4" | Door thickness 1.3/8" |
|--------------------|-----------------------|-----------------------|
| 14 Polished nickel | \$ 247.00 | \$ 247.00 |
| 15 Satin nickel | \$ 258.00 | \$ 258.00 |
| 26 Polished chrome | \$ 221.00 | \$ 221.00 |
| 26D Satin chrome | \$ 232.00 | \$ 232.00 |

Complete set with recessed finger pull - no lock.
Also available with American passage lock. For details of the lock please see page 145.
For prices please contact our customer service.

The privacy flush pulls accommodate 13/4" and 13/8" door thickness. 13/8" door thickness requires minimum pocket width of 21/6", a spacer will add 1/8" to surface on both sides of the door.
Conversions from metric to U.S. measurements are approximate.

The finishes above are considered standard. For different finish options see pages 12-13 and pricing at page 17.
The thumb turn protrudes 7/32" from surface plate. The pocket door thumb turn does not flush complete.

Satin nickel trims are combined with Satin chrome face and strike plates.
Polished nickel trims are combined with Polished chrome face and strike plates.

The privacy flush pulls accommodate 13/4" and 13/8" door thickness. 13/8" door thickness requires minimum pocket width of 21/6", a spacer will add 1/8" to surface on both sides of the door.
Conversions from metric to U.S. measurements are approximate.

The finishes above are considered standard. For different finish options see pages 12-13 and pricing at page 17.
The thumb turn protrudes 7/32" from surface plate. The pocket door thumb turn does not flush complete.

Satin nickel trims are combined with Satin chrome face and strike plates.
Polished nickel trims are combined with Polished chrome face and strike plates.

K 4200 Privacy

Material Brass Collection Lab

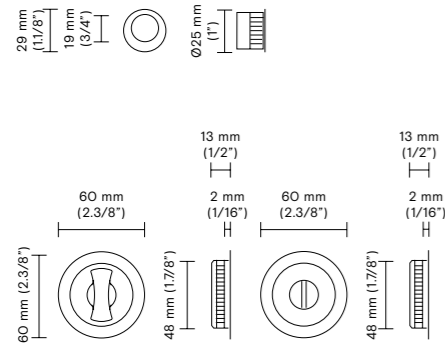

Retail price

| Finish | Door thickness 1.3/4" | Door thickness 1.3/8" |
|---------------------------|-----------------------|-----------------------|
| 03 Polished brass | \$ 133.00 | \$ 270.00 |
| 26 Polished chrome | \$ 147.00 | \$ 302.00 |
| 26D Satin chrome | \$ 147.00 | \$ 308.00 |

Complete set with European style lock and recessed finger pull. Also available with American privacy lock. For details of the lock please see page 144. For prices please contact our customer service.

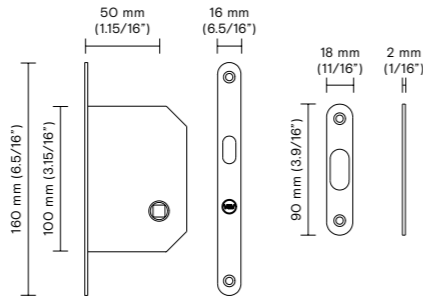

K 4202 Passage

Material Brass Collection Lab

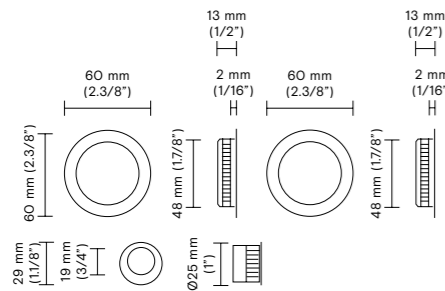

Retail price

| Finish | Door thickness 1.3/4" | Door thickness 1.3/8" |
|---------------------------|-----------------------|-----------------------|
| 03 Polished brass | \$ 71.00 | \$ 71.00 |
| 26 Polished chrome | \$ 78.00 | \$ 78.00 |
| 26D Satin chrome | \$ 78.00 | \$ 78.00 |

Complete set with recessed finger pull - no lock. Also available with American passage lock. For details of the lock please see page 145. For prices please contact our customer service.

The privacy flush pulls accommodate 1 3/4" and 1 3/8" door thickness. 1 3/8" door thickness requires minimum pocket width of 2 1/8", a spacer will add 1/8" to surface on both sides of the door.

Conversions from metric to U.S. measurements are approximate.

The finishes above are considered standard. For different finish options see pages 12-13 and pricing at page 17.

The thumb turn protrudes 7/32" from surface plate. The pocket door thumb turn does not flush complete.

Satin nickel trims are combined with Satin chrome face and strike plates. Polished nickel trims are combined with Polished chrome face and strike plates.

Deadlock - Stainless steel material trims

Retail price

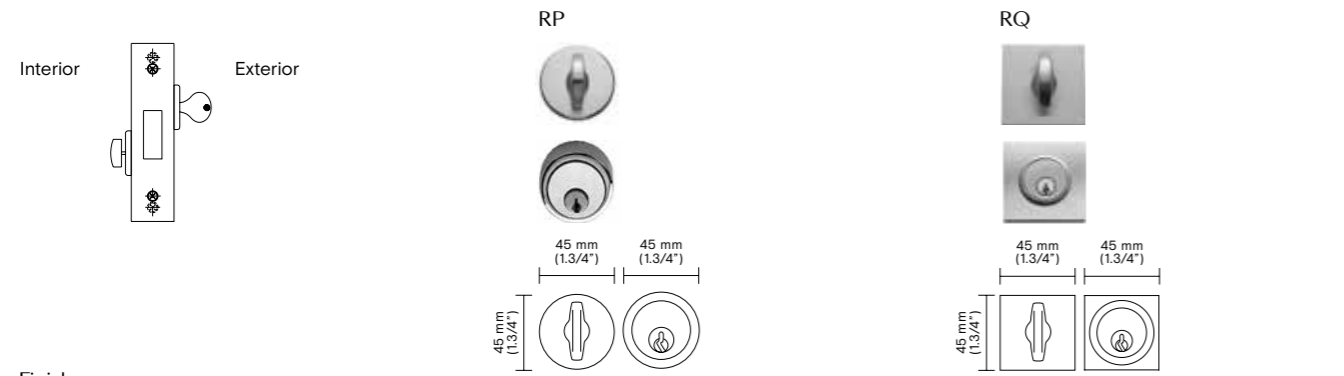

Finish

| Finish | RP | RQ |
|---------------------------|-----------|-----------|
| 03 Polished brass | \$ 390.00 | \$ 504.00 |
| 03D Satin brass | \$ 390.00 | \$ 504.00 |
| 14 Polished nickel | \$ 428.00 | \$ 552.00 |
| 15 Satin nickel | \$ 428.00 | \$ 552.00 |
| 16 Dull black | \$ 390.00 | \$ 504.00 |
| 26 Polished chrome | \$ 390.00 | \$ 504.00 |
| 26D Satin chrome | \$ 420.00 | \$ 537.00 |

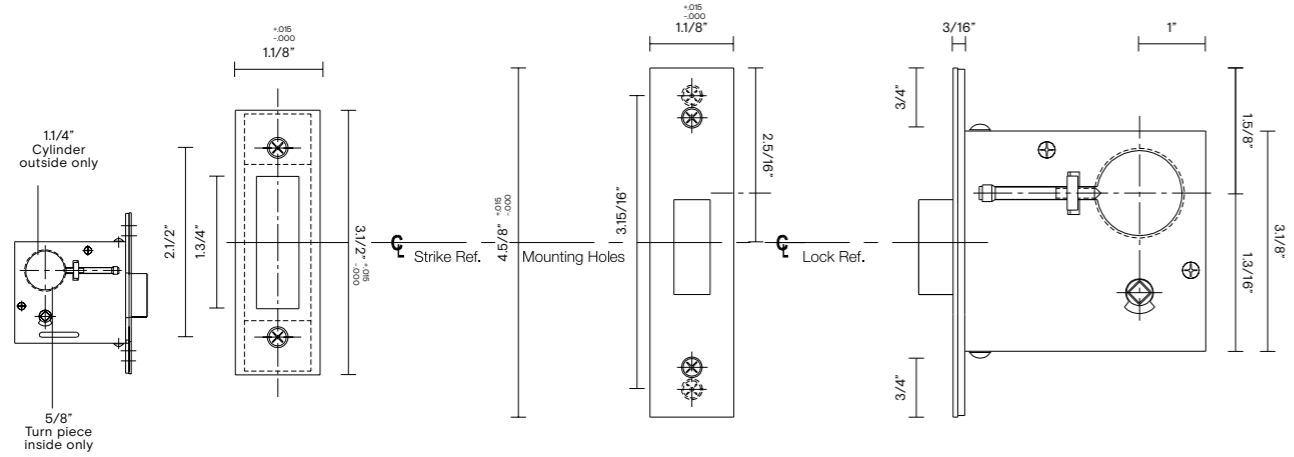

The finishes above are considered standard.
Different finishes are available upon special request.
See pages 12-13 for different finish options and page 17 for pricing.

Available in 2.3/4" and 2.1/2" for the same price.
The backset needs to be specified by the time of the order.
Cylinders are not included and priced apart.

Deadlock - Stainless steel material trims

Retail price

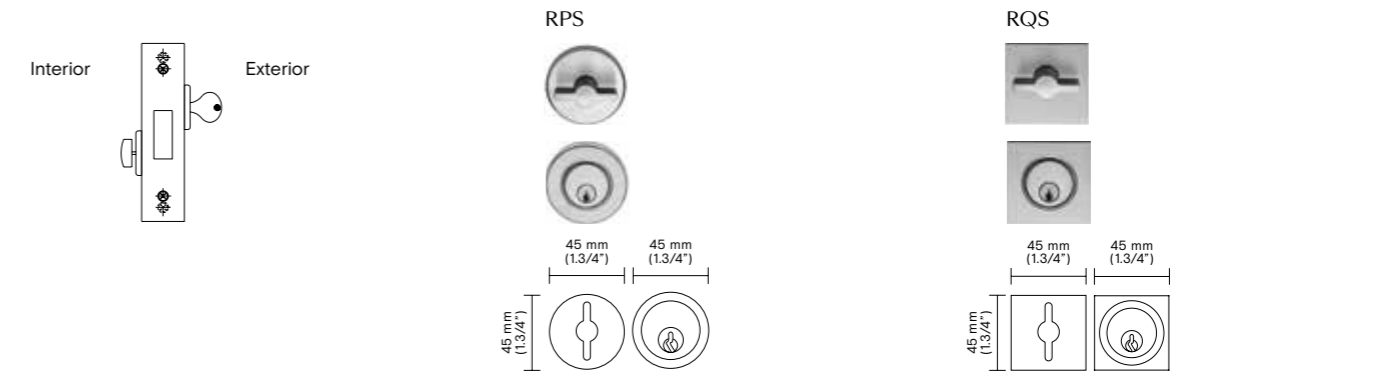

| Finish | RPS | RQS |
|------------------------------------|-----------|-----------|
| 32 Polished stainless steel | \$ 611.00 | \$ 778.00 |
| 32D Satin stainless steel | \$ 558.00 | \$ 724.00 |

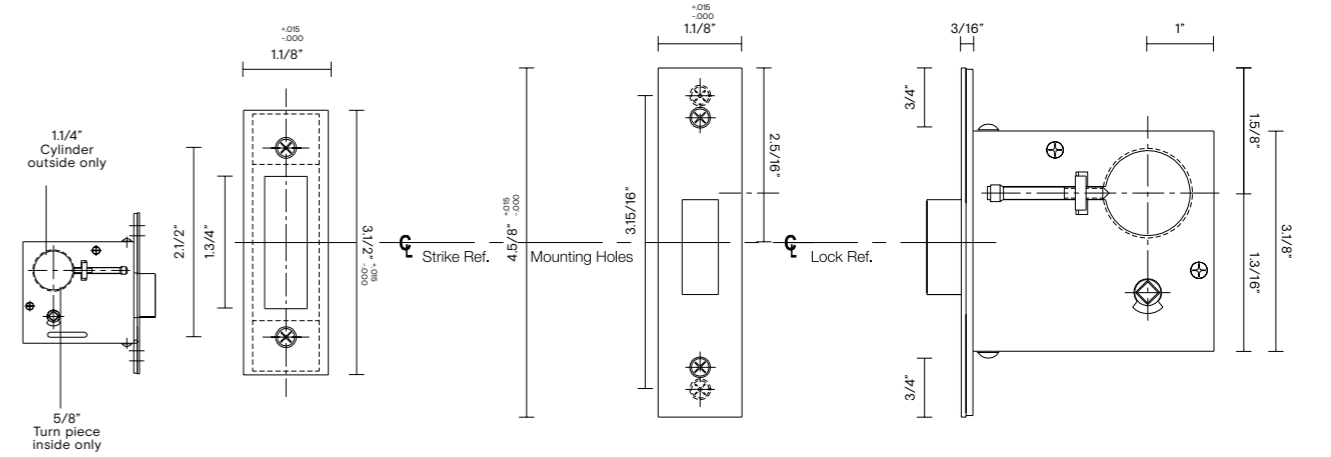

101 Single cylinder deadbolt

Brass or Stainless steel 316 L

Retail price

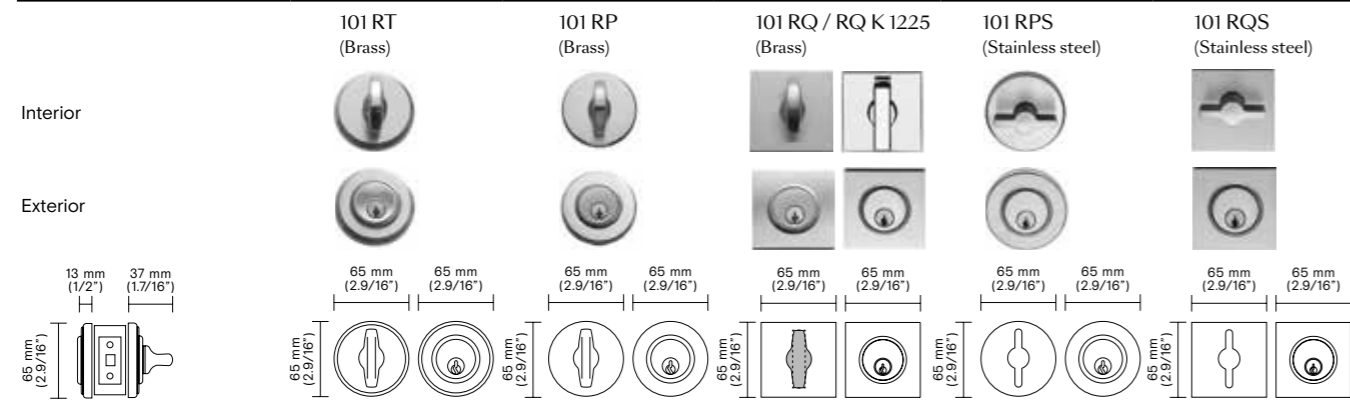

Finish

| Finish | 101 RT (Brass) | 101 RP (Brass) | 101 RQ / RQ K 1225 (Brass) | 101 RPS (Stainless steel) | 101 RQS (Stainless steel) |
|---|----------------|----------------|----------------------------|---------------------------|---------------------------|
| 03 Polished brass | - | \$ 351.00 | \$ 459.00 | \$ 459.00 | - |
| 03D Satin brass | - | \$ 348.00 | - | - | - |
| 03/03D Polished brass / Satin brass (Split finish rosette) | \$ 314.00 | - | - | - | - |
| 03M Matt brass | - | \$ 348.00 | \$ 462.00 | \$ 462.00 | - |
| 06 Antique natural brass | \$ 323.00 | - | - | - | - |
| 06A Anticato | \$ 343.00 | \$ 357.00 | - | - | - |
| 06B Brunito | \$ 327.00 | \$ 337.00 | \$ 459.00 | \$ 459.00 | - |
| 06M Matt bronze | - | \$ 368.00 | \$ 486.00 | \$ 486.00 | - |
| 10S Satin bronze | - | \$ 368.00 | \$ 486.00 | \$ 486.00 | - |
| 14 Polished nickel | \$ 344.00 | \$ 345.00 | \$ 466.00 | \$ 466.00 | - |
| 15 Satin nickel | \$ 340.00 | \$ 344.00 | \$ 472.00 | \$ 472.00 | - |
| 16 Dull black | - | \$ 327.00 | \$ 423.00 | \$ 423.00 | - |
| 17A Polished black nickel | - | \$ 368.00 | \$ 485.00 | \$ 485.00 | - |
| 22M Matt white | - | \$ 339.00 | \$ 436.00 | \$ 436.00 | - |
| 26 Polished chrome | - | \$ 331.00 | \$ 441.00 | \$ 441.00 | - |
| 26D Satin chrome | - | \$ 332.00 | \$ 462.00 | \$ 462.00 | - |
| 26/26D Polished chrome / Satin chrome (Split finish rosette) | \$ 326.00 | - | - | - | - |
| 32 Polished stainless steel | - | - | - | \$ 644.00 | \$ 668.00 |
| 32D Satin stainless steel | - | - | - | \$ 538.00 | \$ 549.00 |
| 56 Dark bronze | - | \$ 367.00 | \$ 485.00 | \$ 485.00 | - |

Conversions from metric to U.S. measurements are approximate.

Cylinder finishes are supplied as below, unless differently requested at the time of the order.

Trim finish 03 = Cylinder finish 03 / POLISHED BRASS
 Trim finishes 03D, 03M = Cylinder in 03D / SATIN BRASS
 Trim finish 06 = Cylinder finish 06 / ANTIQUE BRASS
 Trim finishes 06A, 06B, 06M, 10S, 56 = Cylinder in 10B / OIL RUBBED BRONZE

Trim finishes 14, 17A, 26, 32 = Cylinder finish 26 / POLISHED CHROME
 Trim finishes 15, 32D = Cylinder in 15 / SATIN NICKEL
 Trim finish 16 = Cylinder finish 16 / DULL BLACK
 Trim finish 22M = Cylinder in 22M / MATT WHITE
 Trim finish 26D = Cylinder in 26D / SATIN CHROME

The finishes above are considered standard.
 For different finish options see pages 12-13 and pricing at page 17.
 The deadbolt can be ordered less exterior trim.

For pricing, remove \$150.00 from the listed prices above for 32 and 32D finish, and \$75.00 for all other finishes. Specify "Less Exterior - L/E" as a note to the order.

For the pricing of the 101 RQ/K1225, consider the same price for the 101 RQ and specify as a note to the order "with K1225 thumb turn".

102 Double cylinder deadbolt

Brass or Stainless steel 316 L

Retail price

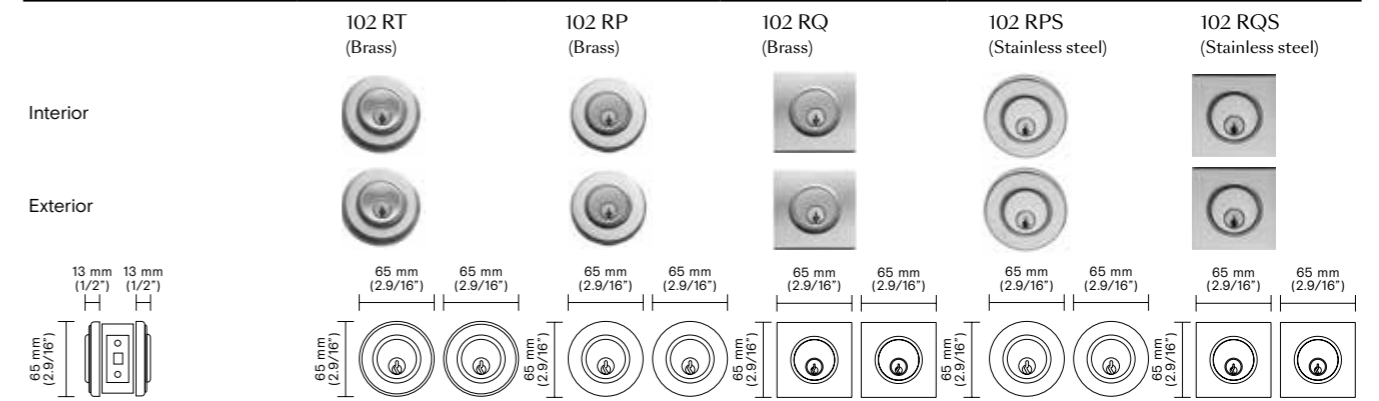

Finish

| Finish | 102 RT (Brass) | 102 RP (Brass) | 102 RQ (Brass) | 102 RPS (Stainless steel) | 102 RQS (Stainless steel) |
|---|----------------|----------------|----------------|---------------------------|---------------------------|
| 03 Polished brass | - | \$ 334.00 | \$ 437.00 | - | - |
| 03D Satin brass | - | \$ 343.00 | - | - | - |
| 03/03D Polished brass / Satin brass (Split finish rosette) | \$ 329.00 | - | - | - | - |
| 03M Matt brass | - | \$ 362.00 | \$ 443.00 | - | - |
| 06 Antique natural brass | \$ 315.00 | - | - | - | - |
| 06A Anticato | \$ 327.00 | \$ 350.00 | - | - | - |
| 06B Brunito | \$ 350.00 | \$ 369.00 | \$ 469.00 | - | - |
| 06M Matt bronze | - | \$ 369.00 | \$ 469.00 | - | - |
| 10S Satin bronze | - | \$ 369.00 | \$ 469.00 | - | - |
| 14 Polished nickel | \$ 353.00 | \$ 362.00 | \$ 443.00 | - | - |
| 15 Satin nickel | \$ 362.00 | \$ 370.00 | \$ 469.00 | - | - |
| 16 Dull black | - | \$ 334.00 | \$ 437.00 | - | - |
| 17A Polished black nickel | - | \$ 369.00 | \$ 469.00 | - | - |
| 22M Matt white | - | \$ 342.00 | \$ 443.00 | - | - |
| 26 Polished chrome | - | \$ 350.00 | \$ 422.00 | - | - |
| 26D Satin chrome | - | \$ 346.00 | \$ 443.00 | - | - |
| 26/26D Polished chrome / Satin chrome (Split finish rosette) | \$ 330.00 | - | - | - | - |
| 32 Polished stainless steel | - | - | - | \$ 623.00 | \$ 671.00 |
| 32D Satin stainless steel | - | - | - | \$ 538.00 | \$ 577.00 |
| 56 Dark bronze | - | \$ 369.00 | \$ 469.00 | - | - |

Conversions from metric to U.S. measurements are approximate.

Cylinder finishes are supplied as below, unless differently requested at the time of the order.

Trim finish 03 = Cylinder finish 03 / POLISHED BRASS
 Trim finishes 03D, 03M = Cylinder in 03D / SATIN BRASS
 Trim finish 06 = Cylinder finish 06 / ANTIQUE BRASS
 Trim finishes 06A, 06B, 06M, 10S, 56 = Cylinder in 10B / OIL RUBBED BRONZE

Trim finishes 14, 17A, 26, 32 = Cylinder finish 26 / POLISHED CHROME
 Trim finishes 15, 32D = Cylinder in 15 / SATIN NICKEL
 Trim finish 16 = Cylinder finish 16 / DULL BLACK
 Trim finish 22M = Cylinder in 22M / MATT WHITE
 Trim finish 26D = Cylinder in 26D / SATIN CHROME

The finishes above are considered standard.
 For different finish options see pages 12-13 and pricing at page 17.
 The deadbolt can be ordered less exterior trim.

For pricing, remove \$150.00 from the listed prices above for 32 and 32D finish, and \$75.00 for all other finishes. Specify "Less Exterior - L/E" as a note to the order.

For the pricing of the 101 RQ/K1225, consider the same price for the 101 RQ and specify as a note to the order "with K1225 thumb turn".

105 Privacy bolts

Brass or Stainless steel 316 L

Retail price

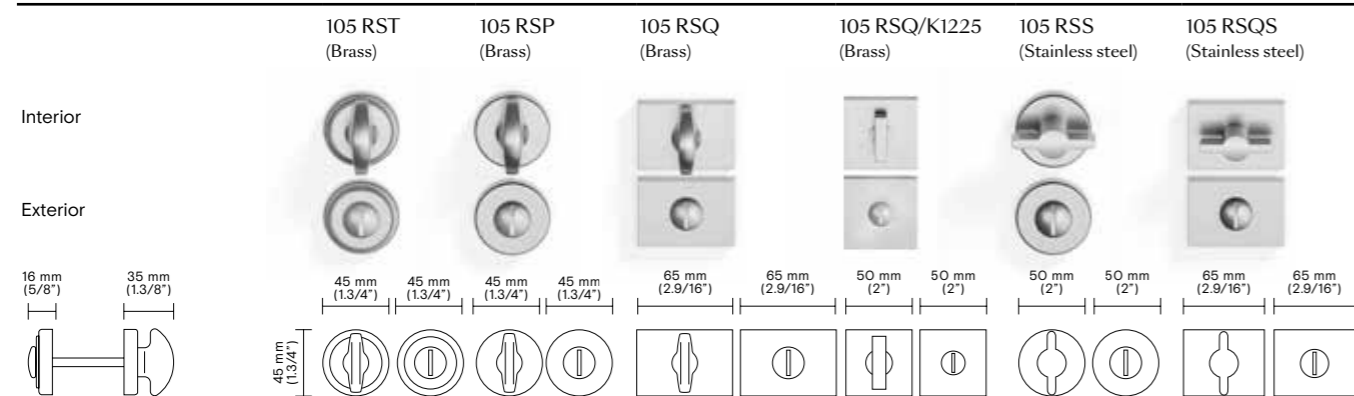

Finish

| | | | | | | |
|---|-----------|-----------|-----------|-----------|----------|-----------|
| 03 Polished brass | \$ 303.00 | \$ 272.00 | \$ 394.00 | \$ 396.00 | - | - |
| 03D Satin brass | - | \$ 272.00 | - | - | - | - |
| 03/O3D Polished brass / Satin brass (Split finish rosette) | \$ 299.00 | - | - | - | - | - |
| 03M Matt brass | - | \$ 310.00 | \$ 423.00 | \$ 436.00 | - | - |
| 06 Antique natural brass | \$ 345.00 | - | - | - | - | - |
| 06A Anticato | \$ 366.00 | \$ 303.00 | - | - | - | - |
| 06B Brunito | - | \$ 289.00 | \$ 444.00 | \$ 444.00 | - | - |
| 06M Matt bronze | - | \$ 332.00 | \$ 444.00 | \$ 471.00 | - | - |
| 10S Satin bronze | - | \$ 332.00 | \$ 444.00 | \$ 471.00 | - | - |
| 14 Polished nickel | \$ 341.00 | \$ 327.00 | \$ 471.00 | \$ 471.00 | - | - |
| 15 Satin nickel | \$ 324.00 | \$ 310.00 | \$ 430.00 | \$ 430.00 | - | - |
| 16 Dull black | - | \$ 280.00 | \$ 395.00 | \$ 403.00 | - | - |
| 17A Polished black nickel | - | \$ 332.00 | \$ 444.00 | \$ 471.00 | - | - |
| 22M Matt white | - | \$ 332.00 | \$ 395.00 | \$ 471.00 | - | - |
| 26 Polished chrome | - | \$ 276.00 | \$ 397.00 | \$ 376.00 | - | - |
| 26D Satin chrome | - | \$ 310.00 | \$ 430.00 | \$ 430.00 | - | - |
| 26/26D Polished chrome / Satin chrome (Split finish rosette) | \$ 361.00 | - | - | - | - | - |
| 32 Polished stainless steel | - | - | - | - | \$301.00 | \$ 567.00 |
| 32D Satin stainless steel | - | - | - | - | \$273.00 | \$4 56.00 |
| 56 Dark bronze | - | \$ 332.00 | \$ 444.00 | \$ 471.00 | - | - |

106 Privacy Bolts

For the 106 privacy bolt, call for pricing.

107 ADA Privacy Bolts

For the ADA compliant privacy bolt, add \$150 to the list prices above.

Conversions from metric to U.S. measurements are approximate.

The finishes above are considered standard. For different finish options see pages 12-13 and pricing at page 17. The 105 and 107 privacy bolts can be ordered less exterior trim.

For pricing, remove \$100.00 from the listed prices above for 32 and 32D finish, and \$50.00 for all other finishes. Specify "Less Exterior - L/E" as a note to the order.

For the privacy bolt with slim rosettes consider the same price of 105 RSP (round) and 105 RSQ (square).

Standard thumb turns for deadlocks, deadbolts, privacy bolts and mortise locks

K1725 (Half moon)

Brass

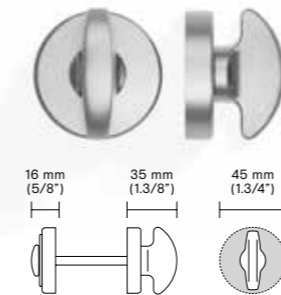

K1225 (Square)

Brass

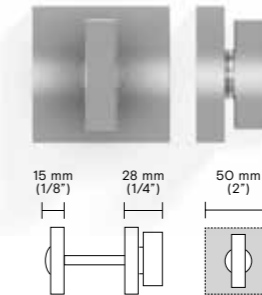

S5501 (Butterfly)

Stainless Steel (only for trims in Stainless steel)

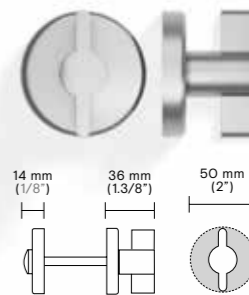

Optional thumb turns for deadlocks, deadbolts, privacy bolts and mortise locks

K 3040 (KAN)

Brass

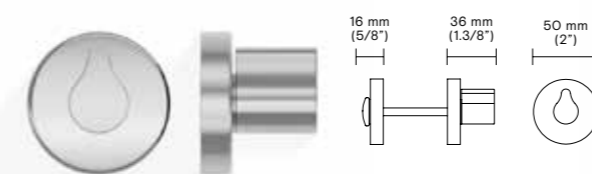

K 1704 (Euro design)

Brass

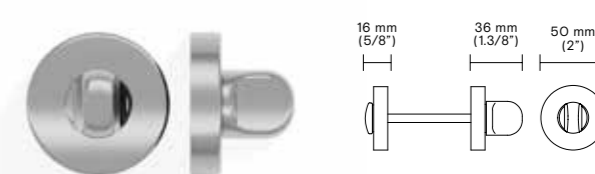

K 3041 (CCD)

Brass



K 1705 Custom **

Brass

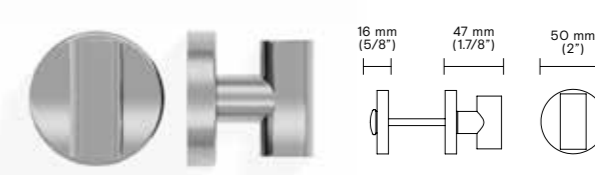

K 1818 Custom **

Brass



K 1811 (ADA)

Brass

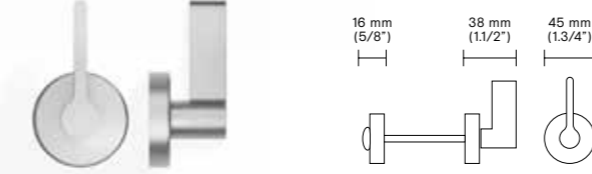

Occupancy indicator on Emergency release



The thumb turns shown in this page can be matched with either round or square rosettes, oval or rectangular plates. In brackets are the names of the series. The K1725 is provided standard on all the applications for brass levers. The S5501 is standard for stainless steel levers.

The remaining thumb turns are provided only request, with an additional cost of \$150 LIST to the price of the standard brass thumb turn. The thumb turns with (**) are only available on a Minimum order quantity. Call for details.

The brass material thumb turns can be produced in any finish. See pages 12-13 for finish options. Stainless steel thumb turn are only produced in 32/Polished stainless steel and 32D/Satin stainless steel.

Trim options

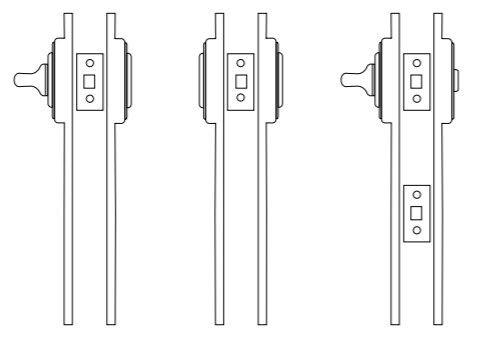
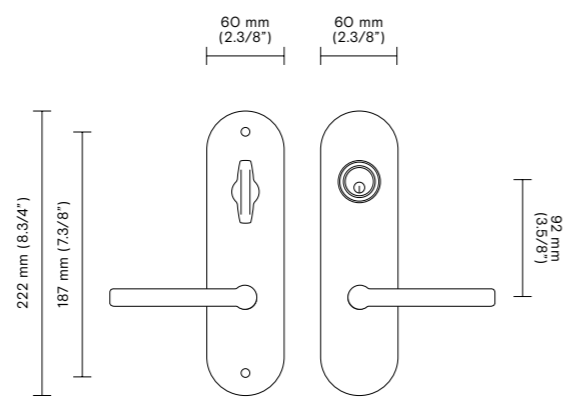

103 EP 104 EP 106 EP

EP

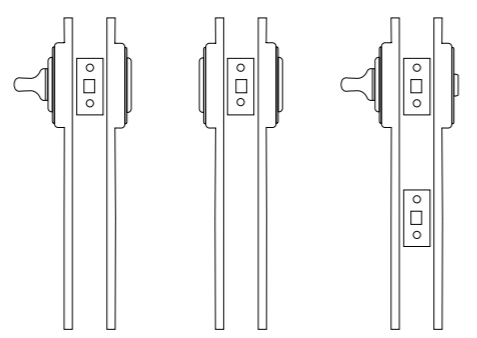
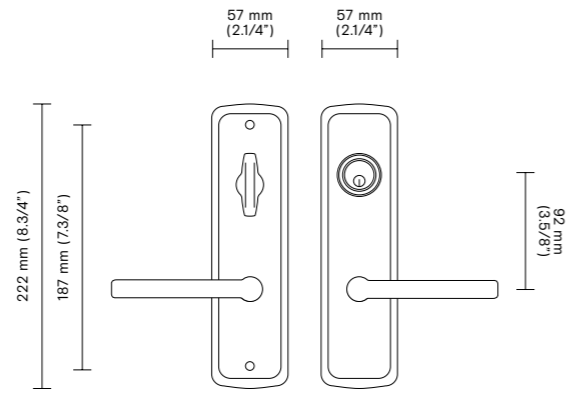

103 ET 104 ET 106 ET

ET

Specify one of the configurations:
 103 Escutcheon single cylinder
 104 Escutcheon double cylinder
 106 Escutcheon privacy bolt

EP/ET = standard finish 26 - 26D
 ER = standard finish 26 - 26D
 ERS = available only in 32D finish
 Special finishes available on request.
 For different finish options see pages 12-13 and pricing at page 17.

Trim options

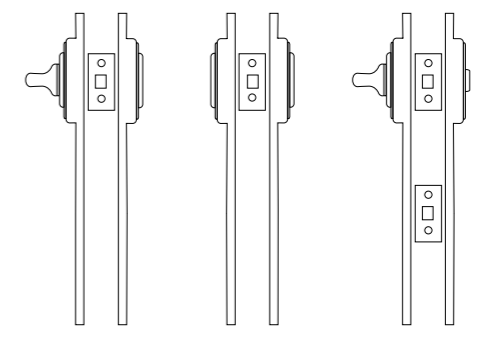
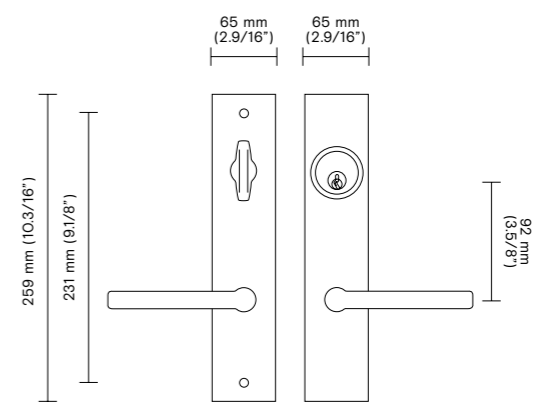

103 ER 104 ER 106 ER

ER

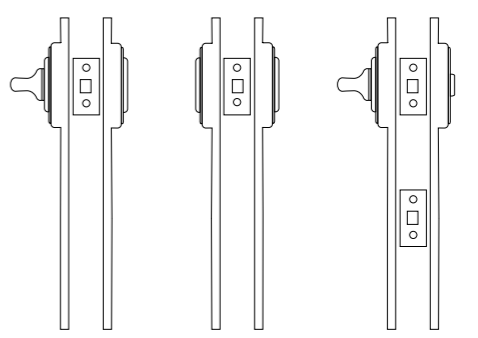
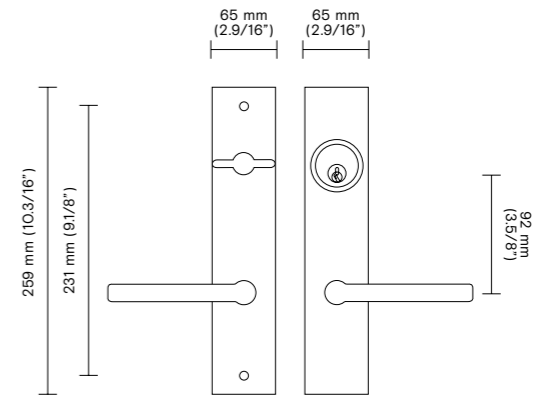

103 ERS 104 ERS 106 ERS

ERS
 (Only available for stainless steel levers)

Specify one of the configurations:
 103 Escutcheon single cylinder
 104 Escutcheon double cylinder
 106 Escutcheon privacy bolt

EP/ET = standard finish 26 - 26D
 ER = standard finish 26 - 26D
 ERS = available only in 32D finish
 Special finishes available on request.
 For different finish options see pages 12-13 and pricing at page 17.

Group 1

H 198, H 1003, H 1022, H 1024, H 1050, H 4730, H 4742, K 1155, K 1168, K 1170

| Model | Retail price | | | |
|---------------------|--------------|-----------|-----------|-----|
| | EP | ET | ER | ERS |
| 103 Single cylinder | \$ 709.00 | \$ 709.00 | \$ 759.00 | -- |
| 104 Double cylinder | \$ 709.00 | \$ 709.00 | \$ 734.00 | -- |
| 106 Privacy bolt | \$ 658.00 | \$ 658.00 | \$ 696.00 | -- |

Group 2

H 165, H 176, H 1016, H 1026, H 1027, H 1044 U, H 1045, H 1046, H 1049, H 1052, H 1054, H 1056, H 1057, H 1061, H 1062, H 1066

| Model | Retail price | | | |
|---------------------|--------------|-----------|-----------|-----|
| | EP | ET | ER | ERS |
| 103 Single cylinder | \$ 773.00 | \$ 773.00 | \$ 823.00 | -- |
| 104 Double cylinder | \$ 759.00 | \$ 759.00 | \$ 823.00 | -- |
| 106 Privacy bolt | \$ 721.00 | \$ 721.00 | \$ 785.00 | -- |

Group 3

H 1039, H 1040, H 1060, H 1068, H 1748, K 1054, K 1056, K 1060, K 1061, K 1171, K 1730

| Model | Retail price | | | |
|---------------------|--------------|-----------|-------------|-----|
| | EP | ET | ER | ERS |
| 103 Single cylinder | \$ 999.00 | \$ 999.00 | \$ 1,024.00 | -- |
| 104 Double cylinder | \$ 985.00 | \$ 985.00 | \$ 929.00 | -- |
| 106 Privacy bolt | \$ 935.00 | \$ 935.00 | \$ 985.00 | -- |

Group 4

H 163, H 192, H 1004, H 1037, H 1043, H 1044, H 1058, H 411, H 414, H 415, H 416, H 419

| Model | Retail price | | | |
|---------------------|--------------|-----------|-----------|-----------|
| | EP | ET | ER | ERS |
| 103 Single cylinder | \$ 645.00 | \$ 645.00 | \$ 709.00 | \$ 809.00 |
| 104 Double cylinder | \$ 550.00 | \$ 550.00 | \$ 696.00 | \$ 785.00 |
| 106 Privacy bolt | \$ 607.00 | \$ 607.00 | \$ 645.00 | \$ 645.00 |

Group 5

H 315, H 317, H 327, H 330, H 334, H 338, H 348, H 361, H 364, H 367, H 368, H 370, H 372, H 381, H 382, H 383, H 385, H 386, K 383

| Model | Retail price | | | |
|---------------------|--------------|-----------|-----------|-----|
| | EP | ET | ER | ERS |
| 103 Single cylinder | \$ 885.00 | \$ 885.00 | \$ 924.00 | -- |
| 104 Double cylinder | \$ 859.00 | \$ 859.00 | \$ 910.00 | -- |
| 106 Privacy bolt | \$ 798.00 | \$ 798.00 | \$ 859.00 | -- |

EP/ET = standard finish 26 - 26D
ER = standard finish 26 - 26D
ERS = available only in 32D finish

Special finishes available on request.
For different finish options see pages 12-13 and pricing at page 17.

Group 6

H 311, H 329, H 335, H 343, H 359, H 376, H 378, H 384, H 5014, K 378,

| Model | Retail price | | | |
|---------------------|--------------|-----------|-------------|-----------|
| | EP | ET | ER | ERS |
| 103 Single cylinder | \$ 999.00 | \$ 999.00 | \$ 1,037.00 | \$ 924.00 |
| 104 Double cylinder | \$ 985.00 | \$ 985.00 | \$ 1,024.00 | \$ 961.00 |
| 106 Privacy bolt | \$ 935.00 | \$ 935.00 | \$ 985.00 | \$ 798.00 |

Group 7

H 377, H 5008, K 5301, K 377

| Model | Retail price | | | |
|---------------------|--------------|-------------|-------------|-------------|
| | EP | ET | ER | ERS |
| 103 Single cylinder | \$ 1,365.00 | \$ 1,365.00 | \$ 1,415.00 | \$ 1,163.00 |
| 104 Double cylinder | \$ 1,353.00 | \$ 1,353.00 | \$ 1,389.00 | \$ 1,188.00 |
| 106 Privacy bolt | \$ 1,303.00 | \$ 1,303.00 | \$ 1,353.00 | \$ 1,037.00 |

Group 8

H 356, H 379, H 380, H 5015/32D, H 5017

| Model | Retail price | | | |
|---------------------|--------------|-------------|-------------|-------------|
| | EP | ET | ER | ERS |
| 103 Single cylinder | \$ 1,454.00 | \$ 1,454.00 | \$ 1,516.00 | \$ 1,516.00 |
| 104 Double cylinder | \$ 1,440.00 | \$ 1,440.00 | \$ 1,504.00 | \$ 1,579.00 |
| 106 Privacy bolt | \$ 1,389.00 | \$ 1,389.00 | \$ 1,465.00 | \$ 1,389.00 |

Group 9

H 5015 Black leather, H 5015 Orange leather

| Model | Retail price | | | |
|---------------------|--------------|----|----|-------------|
| | EP | ET | ER | ERS |
| 103 Single cylinder | -- | -- | -- | \$ 1,934.00 |
| 104 Double cylinder | -- | -- | -- | \$ 1,959.00 |
| 106 Privacy bolt | -- | -- | -- | \$ 1,768.00 |

How to specify

Valli provides different configurations of Multipoint trim.

In order to select the right configuration you should identify the following:

- 1. The name of the manufacturer of the door and of the multi-point lock.** Each manufacturer uses different templates for door drilling and different configurations are needed according to the manufacturer of the lock. Valli covers the main configurations of the following manufacturers: Weathershield®, Sierra Pacific®, PGT®, Pella®, Paddock®, Milgard®, Marvin®, Loewen®, KJV®, Jeld-Wen®, Hoppe®, G-U®, Crestline®, BiltBest®, Atrium®, Ashland®, Andersen®.
- 2. The distance between the lever and the cylinder (center to center).** Valli accommodates CTC distance of 92mm (3.5/8") standard only.
- 3. The lever position on the plate if above or below the cylinder.** This determines the different functions – see page 163 for details.
- 4. The cylinder used in the door: if American or Euro profile cylinder.** The cylinder is always included in the configuration and pricing, unless differently specified.

When all these 4 questions are answered, it is possible to proceed with the specification.

| | |
|----------------------------|---|
| 1 Lever model | Chose from all our collection of levers, ex H 1054 |
| 2 Trim options | Chose among the options ar page 161, narrow long escutcheon plates or rosettes: Plates: NEP, NES, NER, NERS Rosettes: RSM, RSSM |
| 3 Door configuraton | Please specify one of the 5 configurations from page 162. |
| 4 Function | See page 163 to determine |
| 5 Handing | Follow the diagram at page 22 to determine RH, LH, RHR, or LHR |
| 6 Finish | NEP Available standard in 26 and 26D NER Available standard in 26 and 26D RSM Available standard in 26 and 26D NES, NERS and RSSM Available standard in 32D Different finishes available upon request. Choose from pages 12-13, pricing at page 17. |
| 7 Door thickness | 1.3/4" is considered standard. Accomodates up to 2.1/4" thick door. Upcharges apply. See page 17. |
| 8 Miscellaneous | Note any special keying information or special instructions |

| Example | 1 | 2 | 3 | 4 | 5 | 6 | 7 | 8 |
|---------|--------|-----|----|----|----|----|--------|------------------|
| | H 1054 | NEP | #1 | EE | RH | 26 | 1.3/4" | Off-set 55x47 |

Trim options Multipoint trim

Plates

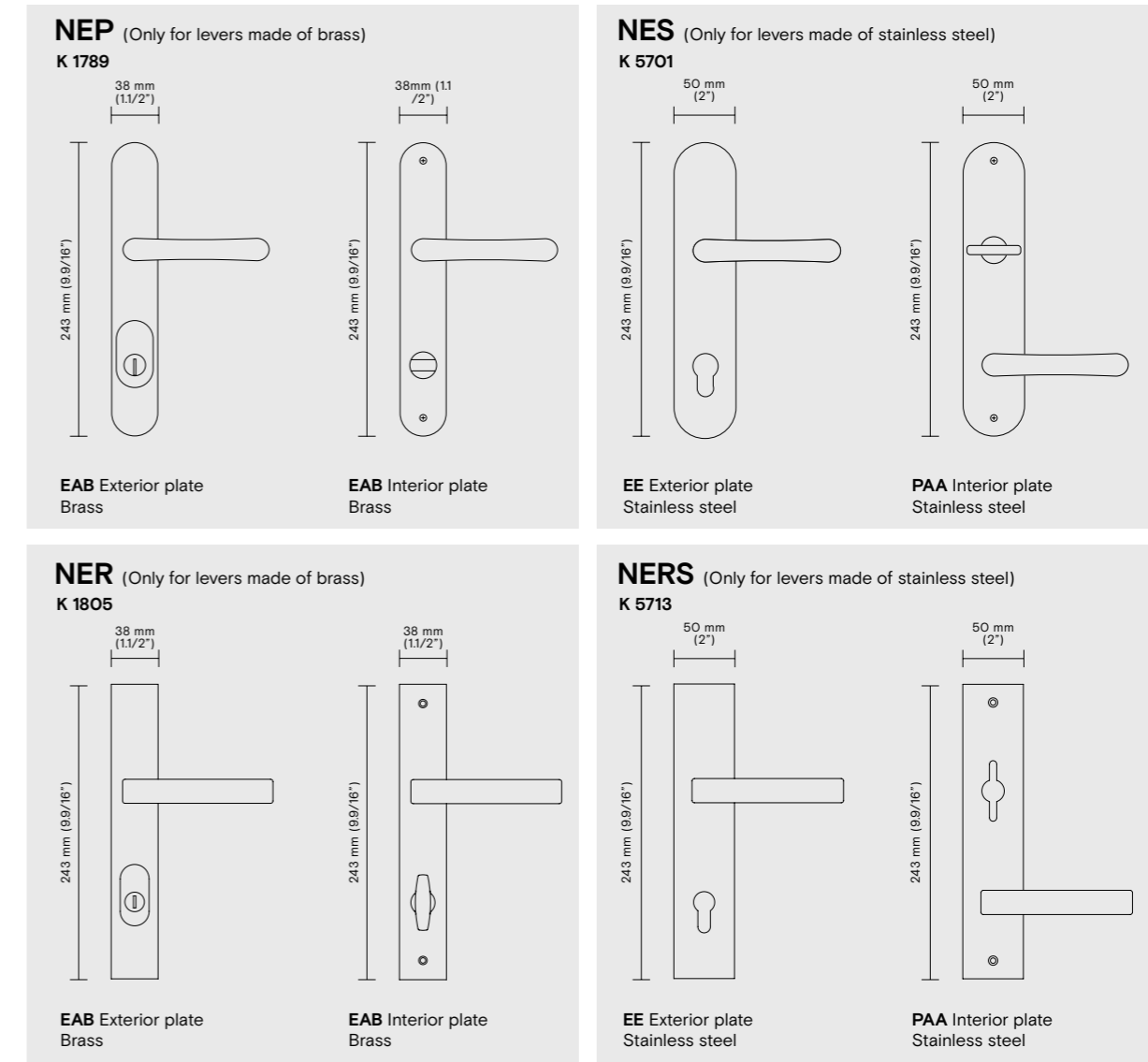

Rosettes

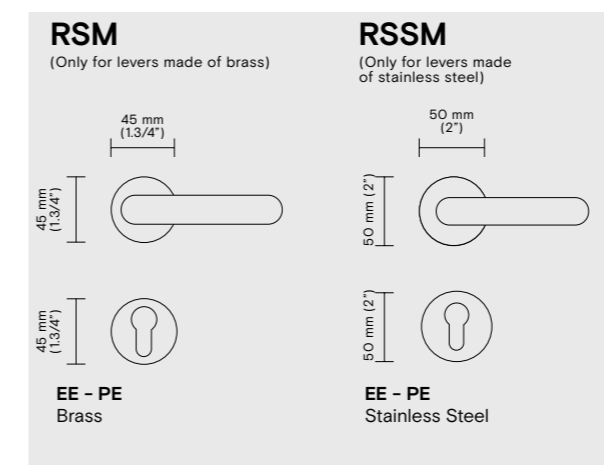

Door configuration Multipoint trim

Standard Valli configuration

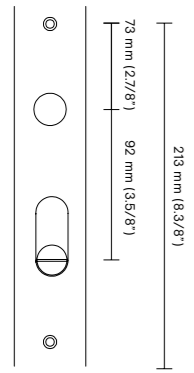

Door configuration #1
American cylinder below handle
3.5/8" (92mm) center to center

Accommodates: Pella®, Milgard®, Marvin®

Additional configurations (to be approved by the R&D department)

All the configurations below can also be accommodated for non-pre-drilled doors. The doors must be drilled as per the dimensions in our standard configuration.

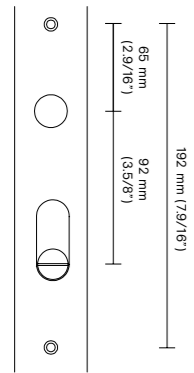

Door configuration #2
American cylinder below handle
3.5/8" (92mm) CTC
Accommodates: Superior®, Paddock®, G-U®, Atrium®, Andersen®

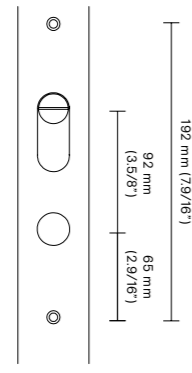

Door configuration #3
American cylinder above handle
3.5/8" (92mm) CTC
Accommodates: Hurd®, G-U®, BiltBest®, Andersen®

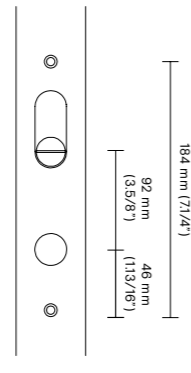

Door configuration #4
American cylinder above handle
3.5/8" (92mm) CTC
Accommodates: Weathershield®, PGT®, Marvin®, JELD-WEN®, G-U®, Caradco®, Ashland®

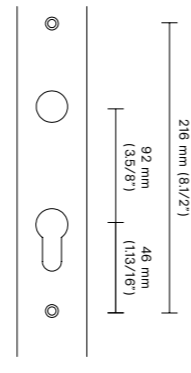

Door configuration #5
European profile cylinder
3.5/8" (92mm) CTC
Accommodates: Windsor®, Willmar®, Weathershield®, Vetter®, Thermo-Tru®, Simpson®, Signature®, Sierra Pacific®, Semco®, Peachtree®, Paddock®, Loewen®, Lincoln®, Kolbe&Kolbe®, KFV®, Hurd®, Hoppe®, Crestline®

Functions

EAA - Entry American Above

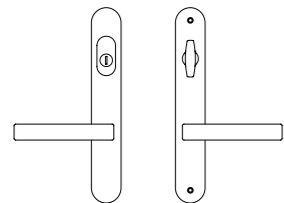

Oval trim

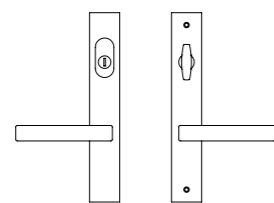

Rectangular trim

EAA Entry set
Key above
Entry function with American cylinder above the lever, 3.5/8" (92mm) center to center.

EAB - Entry American Below

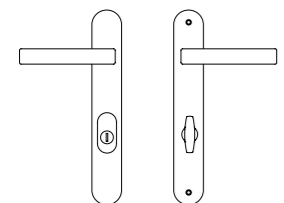

Oval trim

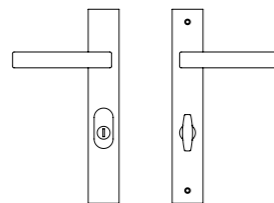

Rectangular trim

EAB Entry set
Key below
Entry function with American Cylinder below the lever, 3.5/8" (92mm) center to center.

Functions

EE - Entry European

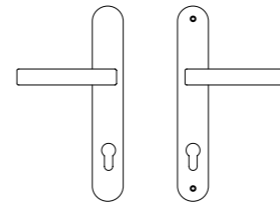

Oval trim

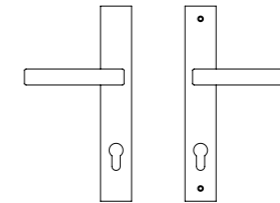

Rectangular trim

EE Entry set
With profile cylinder
Entry function with European profile cylinder.
3.5/8" (92mm) center to center.

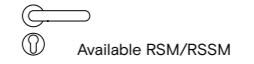

PAA - Patio American Above

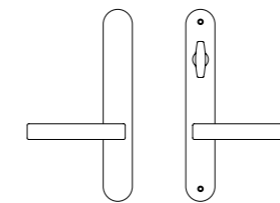

Oval trim

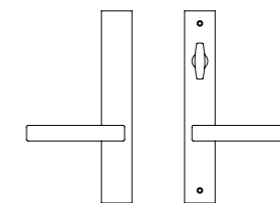

Rectangular trim

PAA Patio set
No keyway
Patio function with the interior thumb turn above the lever, no keyway on the exterior plate.

PAB - Patio American Below

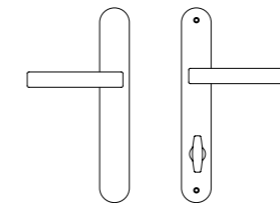

Oval trim

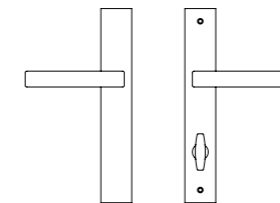

Rectangular trim

PAB Patio set
No keyway
Patio function with the interior thumb turn below the lever, no keyway on the exterior plate.

PE - Patio European

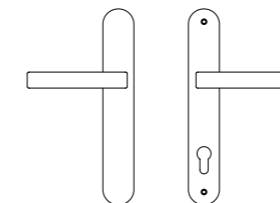

Oval trim

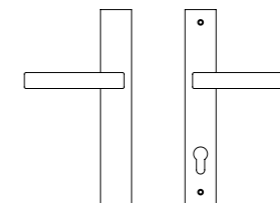

Rectangular trim

PE Patio set
Profile cylinder no key
Patio function with European half profile cylinder and thumb turn, no keyway on the exterior plate.

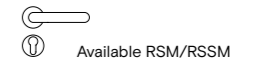

DA - Active Dummy Pair

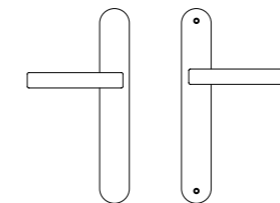

Oval trim

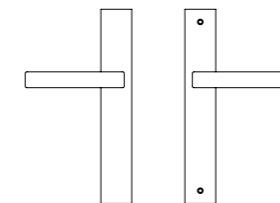

Rectangular trim

DA Active dummy pair

DS - Single Dummy Piece

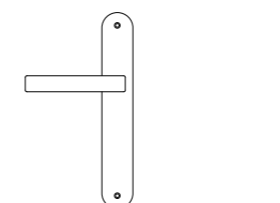

Oval trim

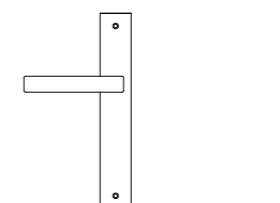

Rectangular trim

DS Single dummy piece

Conversions from metric to U.S. measurements are approximate.

Group 1

H 198, H 1003, H 1022, H 1024, H 1050, H 4730, H 4742

Retail price

| Option | NEP K 1789 | NER K 1805 | RSM |
|------------------------------------|------------------|------------------|-----------|
| EAB Entry Set - Key below | \$ 620.00 | \$ 734.00 | -- |
| PAB Patio Set - Key below | \$ 494.00 | \$ 620.00 | -- |
| EAA Entry Set - Key above | \$ 620.00 | \$ 734.00 | -- |
| PAA Patio Set - No keyway | \$ 494.00 | \$ 620.00 | -- |
| EE Entry Set - With profile cyl. | \$ 935.00 | \$ 1,037.00 | \$ 910.00 |
| PE Patio Set - Profile cyl. no key | \$ 570.00 | \$ 683.00 | \$ 469.00 |
| CE Entry Set - Custom | call for details | call for details | -- |
| DA Active Dummy | \$ 444.00 | \$ 570.00 | \$ 293.00 |

Group 2

H 1016, H 1026, H 1044 U, H 1046, H 1049, H 1054, H 1056, H 1057, H 1062, H 1066

Retail price

| Option | NEP K 1789 | NER K 1805 | RSM |
|------------------------------------|---------------|---------------|-----------|
| EAB Entry Set - Key below | \$ 683.00 | \$ 809.00 | -- |
| PAB Patio Set - Key below | \$ 570.00 | \$ 683.00 | -- |
| EAA Entry Set - Key above | \$ 683.00 | \$ 809.00 | -- |
| PAA Patio Set - No keyway | \$ 570.00 | \$ 683.00 | -- |
| EE Entry Set - With profile cyl. | \$ 999.00 | \$ 1,113.00 | \$ 974.00 |
| PE Patio Set - Profile cyl. no key | \$ 645.00 | \$ 759.00 | \$ 532.00 |
| DA Active Dummy | \$ 520.00 | \$ 645.00 | \$ 369.00 |

Group 3

H 1039, H 1040, H 1069, H 1748

Retail price

| Option | NEP K 1789 | NER K 1805 | RSM |
|------------------------------------|---------------|---------------|-------------|
| EAB Entry Set - Key below | \$ 899.00 | \$ 1,024.00 | -- |
| PAB Patio Set - Key below | \$ 785.00 | \$ 910.00 | -- |
| EAA Entry Set - Key above | \$ 899.00 | \$ 1,024.00 | -- |
| PAA Patio Set - No keyway | \$ 785.00 | \$ 910.00 | -- |
| EE Entry Set - With profile cyl. | \$ 1,226.00 | \$ 1,328.00 | \$ 1,199.00 |
| PE Patio Set - Profile cyl. no key | \$ 859.00 | \$ 974.00 | \$ 759.00 |
| DA Active Dummy | \$ 734.00 | \$ 859.00 | \$ 583.00 |

Group 4

H 163, H 1043, H 1044, H 1058, H411, H 414, H 415, H 416, H 419

Retail price

| Option | NEP K 1789 | NER K 1805 | RSM |
|------------------------------------|---------------|---------------|-----------|
| EAB Entry Set - Key below | \$ 583.00 | \$ 696.00 | -- |
| PAB Patio Set - Key below | \$ 455.00 | \$ 583.00 | -- |
| EAA Entry Set - Key above | \$ 583.00 | \$ 696.00 | -- |
| PAA Patio Set - No keyway | \$ 455.00 | \$ 583.00 | -- |
| EE Entry Set - With profile cyl. | \$ 899.00 | \$ 1,010.00 | \$ 859.00 |
| PE Patio Set - Profile cyl. no key | \$ 532.00 | \$ 645.00 | \$ 430.00 |
| DA Active Dummy | \$ 405.00 | \$ 532.00 | \$ 254.00 |

Available standard finishes:

Brass levers: Satin chrome and polished chrome

Stainless steel levers: Satin stainless steel and polished stainless steel

Different finishes are available on special request.

See pages 12-13 for more options on finishes and page 17 for pricing.

The cylinders are included in the prices of all the corresponding configurations.

Group 5

H 315, H 317, H 327, H 330, H 334, H 338, H 348, H 361, H 364, H 367, H 368, H 370, H 372, H 381, H 382, H 383, H 385, H 386

Retail price

| Option | NEP K 1789 | NER K 1805 | RSM |
|------------------------------------|---------------|---------------|-------------|
| EAB Entry Set - Key below | \$ 747.00 | \$ 873.00 | -- |
| PAB Patio Set - Key below | \$ 633.00 | \$ 759.00 | -- |
| EAA Entry Set - Key above | \$ 747.00 | \$ 873.00 | -- |
| PAA Patio Set - No keyway | \$ 633.00 | \$ 759.00 | -- |
| EE Entry Set - With profile cyl. | \$ 1,062.00 | \$ 1,176.00 | \$ 1,037.00 |
| PE Patio Set - Profile cyl. no key | \$ 709.00 | \$ 823.00 | \$ 607.00 |
| DA Active Dummy | \$ 330.00 | \$ 709.00 | \$ 430.00 |

Group 6

H 311, H 329, H 335, H 343, H 359, H 376, H 378, H 384, H 5014

Retail price

| Option | NEP/NES K 1789/K 5701 | NER/NERS K 1805/K 5713 | RSM/RSSM |
|------------------------------------|--------------------------|---------------------------|-------------|
| EAB Entry Set - Key below | \$ 1,264.00 | \$ 1,389.00 | -- |
| PAB Patio Set - Key below | \$ 1,151.00 | \$ 1,277.00 | -- |
| EAA Entry Set - Key above | \$ 1,264.00 | \$ 1,389.00 | -- |
| PAA Patio Set - No keyway | \$ 1,151.00 | \$ 1,277.00 | -- |
| EE Entry Set - With profile cyl. | \$ 1,579.00 | \$ 1,706.00 | \$ 1,555.00 |
| PE Patio Set - Profile cyl. no key | \$ 1,226.00 | \$ 1,340.00 | \$ 1,125.00 |
| DA Active Dummy | \$ 848.00 | \$ 1,226.00 | \$ 949.00 |

Group 7

H 5008

Retail price

| Option | NEP/NES K 1789/K 5701 | NER/NERS K 1805/K 5713 | RSM/RSSM |
|------------------------------------|--------------------------|---------------------------|-------------|
| EAB Entry Set - Key below | \$ 1,192.00 | \$ 1,311.00 | -- |
| PAB Patio Set - Key below | \$ 1,085.00 | \$ 1,205.00 | -- |
| EAA Entry Set - Key above | \$ 1,192.00 | \$ 1,311.00 | -- |
| PAA Patio Set - No keyway | \$ 1,085.00 | \$ 1,205.00 | -- |
| EE Entry Set - With profile cyl. | \$ 1,490.00 | \$ 1,609.00 | \$ 1,466.00 |
| PE Patio Set - Profile cyl. no key | \$ 1,156.00 | \$ 1,263.00 | \$ 1,061.00 |
| DA Active Dummy | \$ 800.00 | \$ 1,156.00 | \$ 895.00 |

Group 8

H 356, H 379, H 380, H 5015/32D, H 5017

Retail price

| Option | NEP/NES K 1789/K 5701 | NER/NERS K 1805/K 5713 | RSM/RSSM |
|------------------------------------|--------------------------|---------------------------|-------------|
| EAB Entry Set - Key below | \$ 1,328.00 | \$ 1,454.00 | -- |
| PAB Patio Set - Key below | \$ 1,213.00 | \$ 1,340.00 | -- |
| EAA Entry Set - Key above | \$ 1,328.00 | \$ 1,454.00 | -- |
| PAA Patio Set - No keyway | \$ 1,213.00 | \$ 1,340.00 | -- |
| EE Entry Set - With profile cyl. | \$ 1,643.00 | \$ 1,755.00 | \$ 1,617.00 |
| PE Patio Set - Profile cyl. no key | \$ 1,289.00 | \$ 1,415.00 | \$ 1,176.00 |
| DA Active Dummy | \$ 910.00 | \$ 1,289.00 | \$ 1,010.00 |

Available standard finishes:

Brass levers: Satin chrome and polished chrome

Stainless steel levers: Satin stainless steel and polished stainless steel

Different finishes are available on special request.

See pages 12-13 for more options on finishes and page 17 for pricing.

The cylinders are included in the prices of all the corresponding configurations.

NEP: Narrow long oval plate

NER: Narrow long rectangular plate

RSM: Small 45mm (1.3/4") rosette

NES: Long oval plate stainless steel material

NERS: Long rectangular plate stainless steel material

RSSM: Round rosette 50mm (2") Stainless steel material

Group 9

H 5015 Black leather, H 5015 Orange leather

| Option | NES | NERS | RSSM | Retail price |
|------------------------------------|-------------|-------------|-------------|--------------|
| | K 5701 | K 5713 | | |
| EAB Entry Set - Key below | \$ 1,819.00 | \$ 1,920.00 | -- | |
| PAB Patio Set - Key below | \$ 1,681.00 | \$ 1,744.00 | -- | |
| EAA Entry Set - Key above | \$ 1,819.00 | \$ 1,920.00 | -- | |
| PAA Patio Set - No keyway | \$ 1,681.00 | \$ 1,744.00 | -- | |
| EE Entry Set - With profile cyl. | \$ 2,085.00 | \$ 2,135.00 | \$ 1,844.00 | |
| PE Patio Set - Profile cyl. no key | \$ 1,731.00 | \$ 1,744.00 | \$ 1,457.00 | |
| DA Active Dummy | \$ 1,579.00 | \$ 1,643.00 | \$ 1,289.00 | |

Available standard finishes:

Brass levers: Satin chrome and polished chrome

Stainless steel levers: Satin stainless steel and polished stainless steel

Different finishes are available on special request.

See pages 12-13 for more options on finishes and page 17 for pricing.

The cylinders are included in the prices of all the corresponding configurations.

NES: Long oval plate stainless steel material
 NERS: Long rectangular plate stainless steel material
 RSSM: Round rosette 50mm (2") stainless steel material

How to specify







In order to select the right configuration you should identify the following:

| | | |
|----------|-----------------------|---|
| 1 | Lever model | Chose from all our collection of levers, ex H 1066 |
| 2 | Trim options | Chose among the options ar page 169. |
| 3 | Function | See page 171 to determine |
| 4 | Handing | Follow the diagram at page 22 to determine RH, LH, RHR, or LHR |
| 5 | Finish | See page 12-13 to determine |
| 6 | Door thickness | 1.3/4" is considered standard. Accomodates up to 2.1/4" thick door. Upcharges apply. See page 17. |
| 7 | Miscellaneous | Note any special keying information or special instruction |

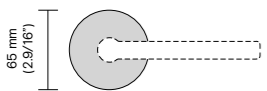
| Example | 1 | 2 | 3 | 4 | 5 | 6 | 7 |
|---------|--------|----|-------|----|----|--------|----|
| | H 1054 | RP | ML-FD | RH | 26 | 1.3/4" | -- |

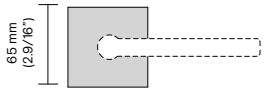

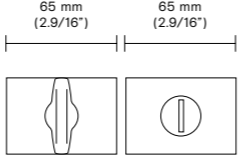
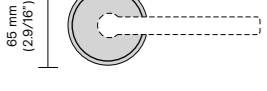

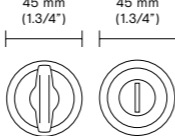



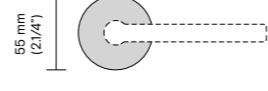

Trim options

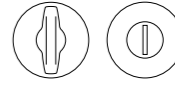
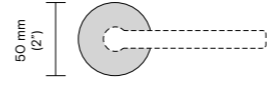
Configuration for Pre - drilled doors (2.1/8" BORE)

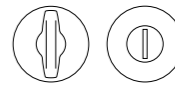
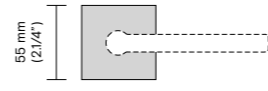
| Rosettes | Key cylinder | Thumb turn |
|---|---|---|
|  <p>Round 65 mm (2.9/16") RP Round rosette Brass RPS Round rosette Stainless steel</p> |  <p>45 mm (1.3/4")</p> |  <p>45 mm (1.3/4") 45 mm (1.3/4")</p> |
|  <p>Square 65mm (2.9/16") RQ Square rosette Brass RQS Square rosette Stainless steel</p> |  <p>45 mm (1.3/4")</p> |  <p>65 mm (2.9/16") 65 mm (2.9/16")</p> |
|  <p>Traditional 65 mm (2.9/16") RT Traditional rosette Brass (Only available in brass material)</p> |  <p>45 mm (1.3/4")</p> |  <p>45 mm (1.3/4") 45 mm (1.3/4")</p> |

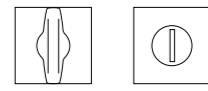
Trim options

Configuration for Non pre - drilled doors

| Rosettes | Key cylinder | Thumb turn |
|---|---|--|
|  <p>Round 55 mm (2.1/4") RS55 Round rosette Brass</p> |  <p>45 mm (1.3/4")</p> |  <p>45 mm (1.3/4") 45 mm (1.3/4")</p> |
|  <p>Round 50 mm (2") RS50 Round rosette Brass RSS50 Round rosette Stainless steel</p> |  <p>45 mm (1.3/4")</p> |  <p>45 mm (1.3/4") 45 mm (1.3/4")</p> |
|  <p>Square 55 mm (2.1/4") RSQ55 Square rosette Brass</p> |  <p>45 mm (1.3/4")</p> |  <p>50 mm (2") 50 mm (2")</p> |
|  <p>Square 50 mm (2") RS50 Square rosette Brass</p> |  <p>45 mm (1.3/4")</p> |  <p>50 mm (2") 50 mm (2")</p> |

Escutcheons plates

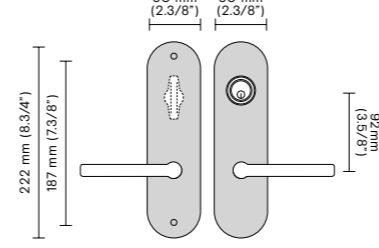
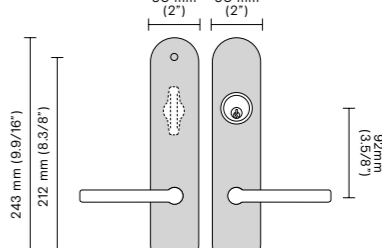
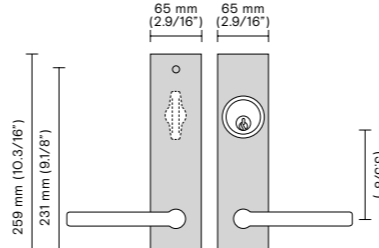
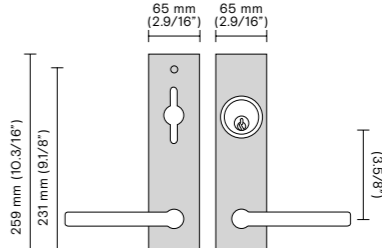
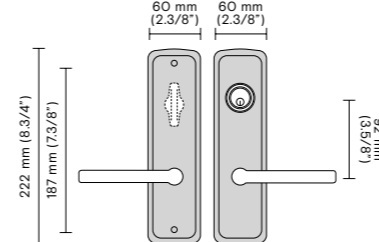
| Brass levers | Stainless steel levers |
|---|--|
|  <p>EP Oval escutcheon Brass</p> |  <p>NES Oval escutcheon Stainless steel</p> |
|  <p>ER Rectangular escutcheon Brass</p> |  <p>ERS Rectangular escutcheon Stainless steel</p> |
|  <p>ET Traditional escutcheon Brass</p> | |

Mortise locks

Each lever and knob design in this catalog is available for mortise lock application. Valli provides mortise locks of different backsets and functions.

Standard backset lock

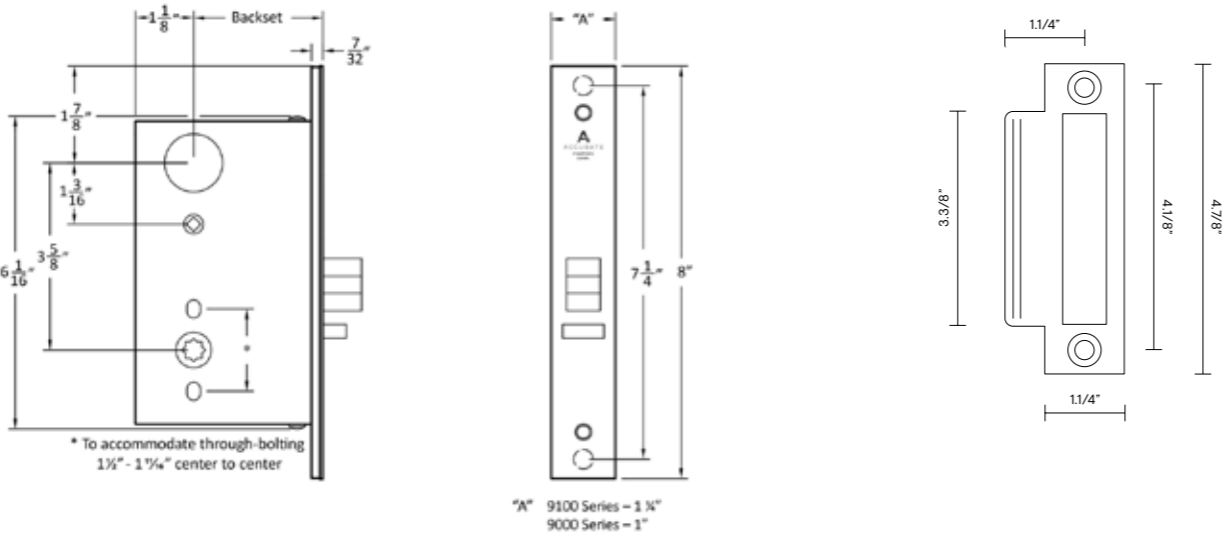

Lock body (shown ML-F function)

Lock front (shown ML-F function)

Universal strike plate

Narrow backset lock

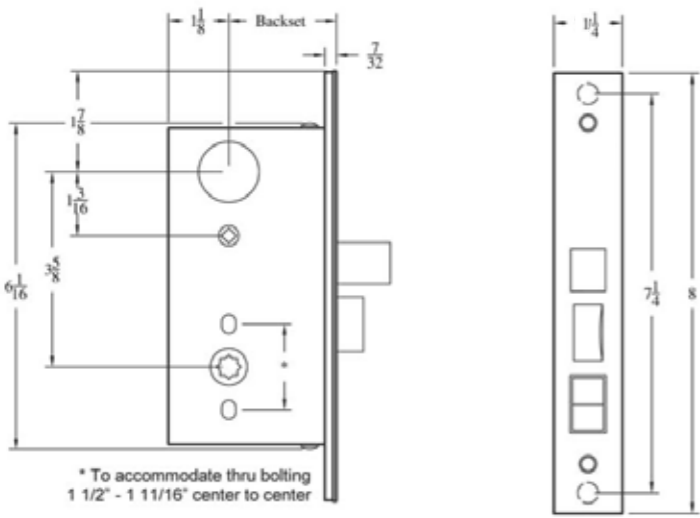

STANDARD BACKSETS: 2 3/4" - 2 1/2"
SPECIAL BACKSETS ON REQUEST:
 1 1/4" - 1 1/2" - 1 3/4" - 2" - 2 1/4" - 3" - 5"
 Different customized backsets may be produced upon special request and after technical approval.

Upcharges apply to different backset requests. See page 17 for details.
 Magnetic mortise locks also available on request. See page 17 for pricing.

Mortise lock functions

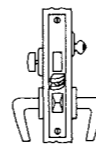

ML-F ENTRANCE
 Latch bolt by key outside and lever either side unless outside lever is locked by toggle-action stop. Dead bolt by key outside and turnpiece inside. Turning inside lever retracts latch and dead bolt simultaneously. Outside lever remains locked.

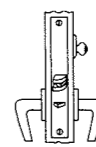

ML-ELECT ELECTRIFIED
 Must specify: EU = Fail secure or EL = Fail safe
 Voltage: 24 VDC or 12 VDC
 Latch by lever inside and key outside. Outside lever is always rigid. Auxiliary latch deadlocks latch bolt.

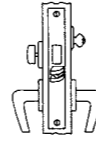

ML-FW DORMITORY
 Latch bolt by lever either side. Dead bolt by key outside and turnpiece inside. A turn of inside lever retracts latch and dead bolt simultaneously-automatically unlocking outside lever. No Toggle.

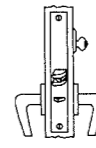

ML-J CLASSROOM
 Latch bolt by key outside and lever either side unless outside lever is locked by key outside. Auxiliary latch deadlocks latch bolt.

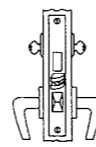

ML-AC ENTRANCE
 Latch bolt by lever either side unless outside lever is locked by toggle action stop. Dead bolt by key either side.

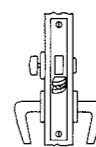

ML-LF PRIVACY
 Latch bolt by lever either side. Dead bolt by turnpiece inside and coin key outside. A turn of inside lever retracts latch and dead bolt simultaneously-automatically unlocking outside lever.

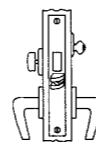

ML-B ENTRANCE
 Latch bolt by lever either side. Dead bolt by key outside and thumb turn inside. No Toggle. No emergency egress.

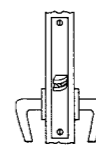

ML-N PASSAGE
 Latch bolt by lever either side.

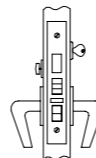

ML-FD ENTRANCE / APARTMENT LOCK
 Latch bolt by key outside and lever either side. Unless outside lever is locked by toggle-action stop. Dead bolt by key outside and turnpiece inside. Turning inside lever retracts latch and dead bolt simultaneously. Outside lever remains locked. Auxiliary latch deadlocks latch bolt and prevents manipulation of locked toggle action stop.

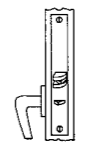

ML-NC COMMUNICATING
 Latch bolt by lever one side.

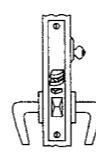

ML-E OFFICE
 Latch bolt by key outside and lever either side unless outside lever is locked by toggle-action stop. Auxiliary latch deadlocks latch bolt.



ML-LFC COMMUNICATING
 Latch bolt by lever inside only. Dead bolt by turnpiece inside only. A turn of inside lever retracts latch and dead bolt simultaneously-automatically unlocking door.

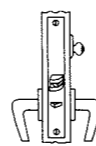

ML-EW STOREROOM
 Latch by lever inside and key outside. Outside lever is always rigid. Auxiliary latch deadlocks latch bolt.

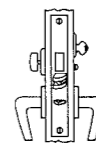

ML-H HOTEL
 Latch bolt by lever inside and guest or master key outside. Outside lever always rigid. Dead bolt by turnpiece inside and key outside. A turn of inside lever retracts latch and dead bolt simultaneously. Auxiliary latch deadlocks latch bolt.

The narrow backset mortise locks are available only in the following functions:

- ML-FW Entrance
- ML-F Entrance
- ML-N Passage
- ML-LF Privacy
- ML-J Classroom
- ML-E Office
- ML-EW Storeroom

Rosette options for mortise application

1. Keyed functions

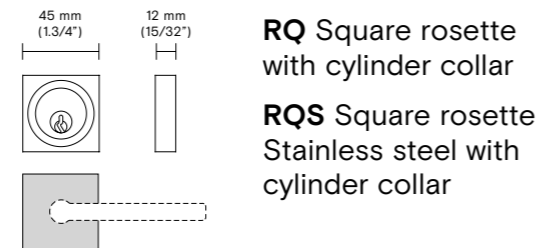
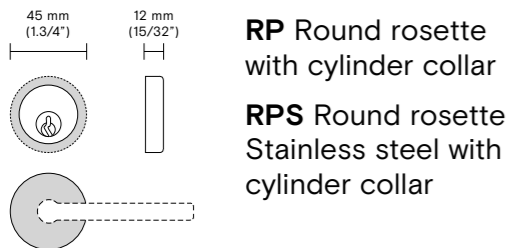

2. Privacy function with thumb turn/emergency release (Brass material)

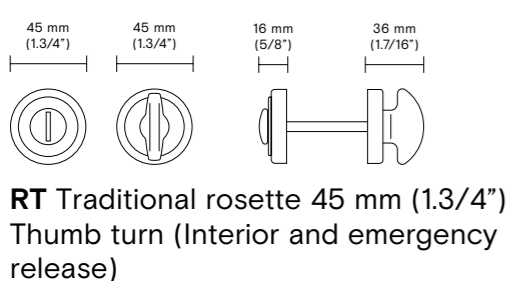
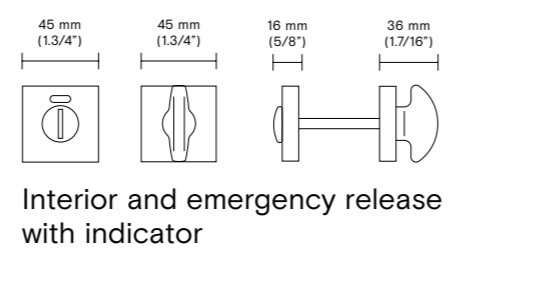
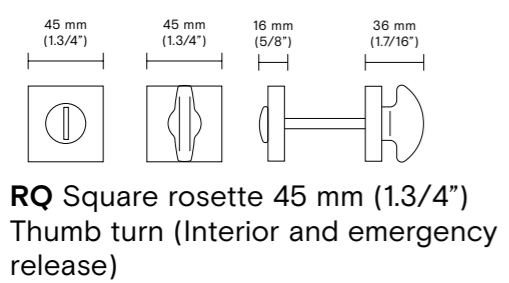
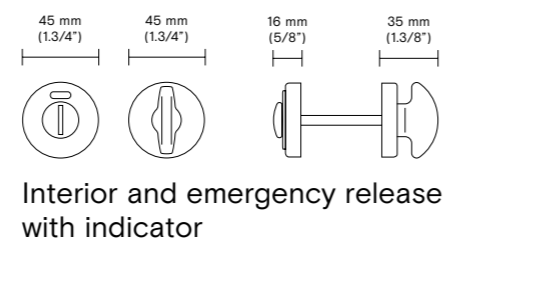
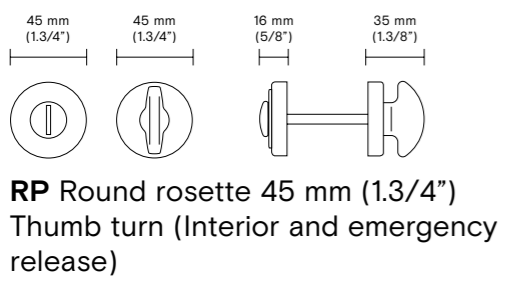

Rosette options for mortise application

3. Privacy function with thumb turn/emergency release (Stainless steel material)

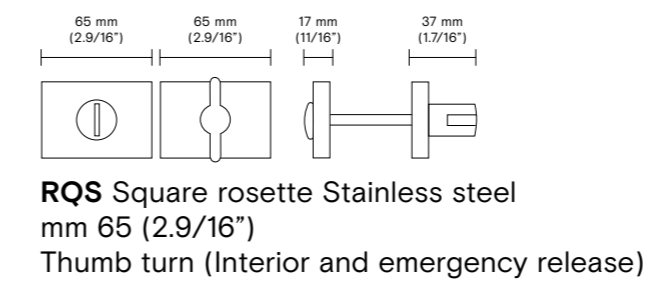
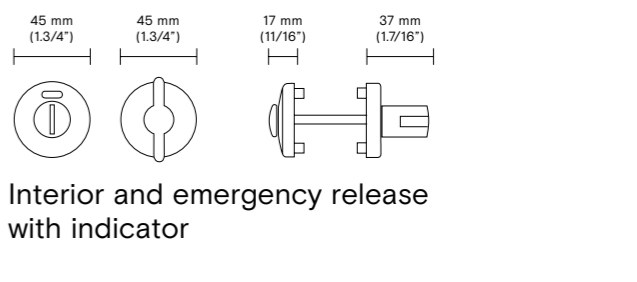
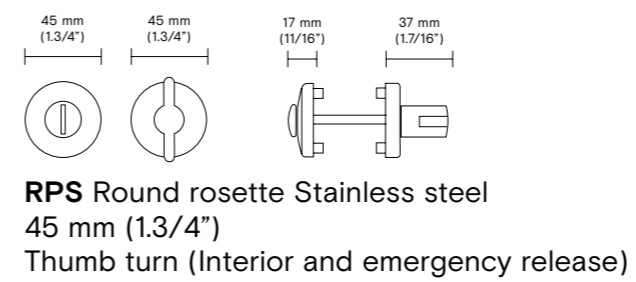

Cylinder finish options

The cylinders are supplied in the finishes below, unless differently requested at the time of the order:

- Trim finish O3 = Cylinder finish O3 / POLISHED BRASS
- Trim finishes O3D, O3M = Cylinder in O3D / SATIN BRASS
- Trim finish O6 = Cylinder in O6 / ANTIQUE BRASS
- Trim finishes O6A, O6B, O6M, 10S, 56 = Cylinders in 10B / OIL RUBBED BRONZE
- Trim finish 14, 17A, 26, 32 = Cylinder in 26 / POLISHED CHROME
- Trim finish 15, 32D = Cylinder in 15 / SATIN NICKEL
- Trim finish 16 = Cylinder in 16 / DULL BLACK
- Trim finish 22M = Cylinder in 22M / MATT WHITE
- Trim finish 26D = Cylinder in 26D / SATIN CHROME

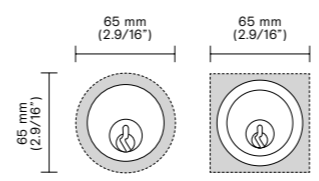

Conversions from metric to U.S. measurements are approximate.

The configurations above are considered standard with the exclusion of the emergency release with indicator, only available on special request.
 ADA compliant thumb turn is available on special request. For its design check page 155. Call for pricing.

Other thumb turns are available as optional. Check page 155 for details.

The configurations above are considered standard with the exclusion of the emergency release with indicator, available on special request.
 ADA compliant thumb turn is available on special request. For its design check page 155. Call for pricing.

Group 1 Mortise locks

Door levers _____ H 198, H 1003, H 1022, H 1024, H 1050, H 4730, H 4742
 Door knobs _____ K 1155, K 1168, K 1170

Retail price

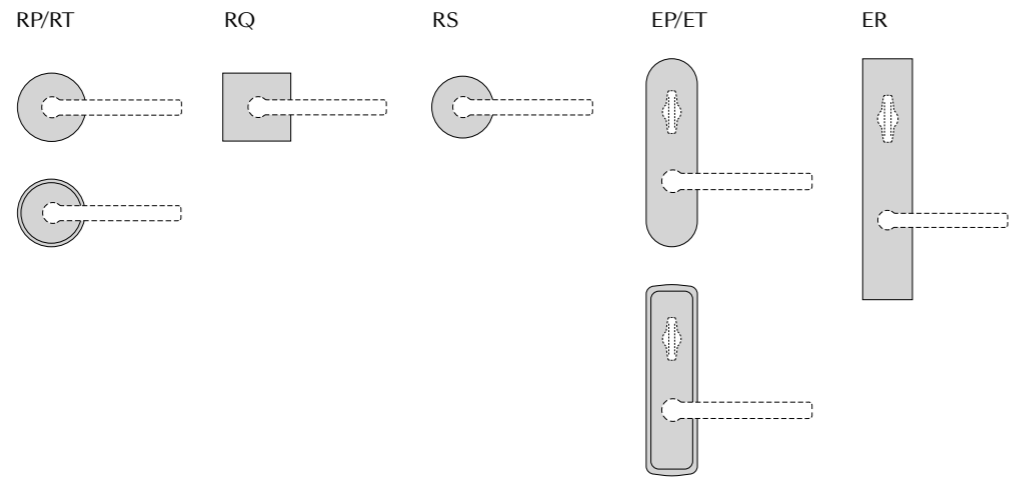

| | RP/RT | RQ | RS | EP/ET | ER |
|---------------------|-------------|-------------|-------------|-------------|-------------|
| ML F/Entrance | \$ 961.00 | \$ 1,100.00 | \$ 848.00 | \$ 899.00 | \$ 935.00 |
| ML FD/Entrance | \$ 1,010.00 | \$ 1,163.00 | \$ 910.00 | \$ 949.00 | \$ 999.00 |
| ML FW/Entrance | \$ 935.00 | \$ 1,087.00 | \$ 809.00 | \$ 873.00 | \$ 910.00 |
| ML B/Entrance | \$ 935.00 | \$ 1,087.00 | \$ 823.00 | \$ 848.00 | \$ 910.00 |
| ML AC/Entrance | \$ 935.00 | \$ 1,049.00 | \$ 809.00 | \$ 910.00 | \$ 949.00 |
| ML E/Office | \$ 899.00 | \$ 985.00 | \$ 823.00 | \$ 899.00 | \$ 949.00 |
| ML EW/Storeroom | \$ 859.00 | \$ 935.00 | \$ 747.00 | \$ 859.00 | \$ 910.00 |
| ML J/Classroom | \$ 899.00 | \$ 985.00 | \$ 823.00 | \$ 899.00 | \$ 949.00 |
| ML N/Passage | \$ 734.00 | \$ 773.00 | \$ 607.00 | \$ 759.00 | \$ 798.00 |
| ML LF/Privacy | \$ 961.00 | \$ 1,113.00 | \$ 848.00 | \$ 848.00 | \$ 885.00 |
| ML H/Hotel | \$ 961.00 | \$ 1,100.00 | \$ 848.00 | \$ 834.00 | \$ 924.00 |
| ML NC/Communicating | \$ 545.00 | \$ 545.00 | \$ 558.00 | \$ 620.00 | \$ 633.00 |
| ML ELEC/Electrified | \$ 2,210.00 | \$ 2,274.00 | \$ 2,085.00 | \$ 2,185.00 | \$ 2,236.00 |

Conversions from metric to U.S. measurements are approximate.

The prices above refer to locks of 2.3/4" and 2.1/2" backset. Upcharges apply for different backsets. See page 17.
 If requested without mortise lock, deduct \$120 retail price. For ML-ELECT without mortise lock, deduct \$120 from ML-EW retail price.

If requested without cylinder, deduct \$15 retail price. Same prices for all the standard finishes as indicated per each lever page. Special finishes are available upon request. See pages 12-13 for finish selection. Upcharges apply.

Upside Down and Magnetic Locks are available upon request. Upcharges at page 17.
 For the electrified mortise locks, the AE switch (Request to Exit) must be requested at the time of the order. Upcharges apply.

Group 2 Mortise locks

Door levers _____ H 165, H 176, H 1016, H 1018, H 1026, H 1027, H 1044 U, H 1045, H 1046, H 1049, H 1052, H 1054, H 1055, H 1056, H 1057, H 1061, H 1062, H 1066

Retail price

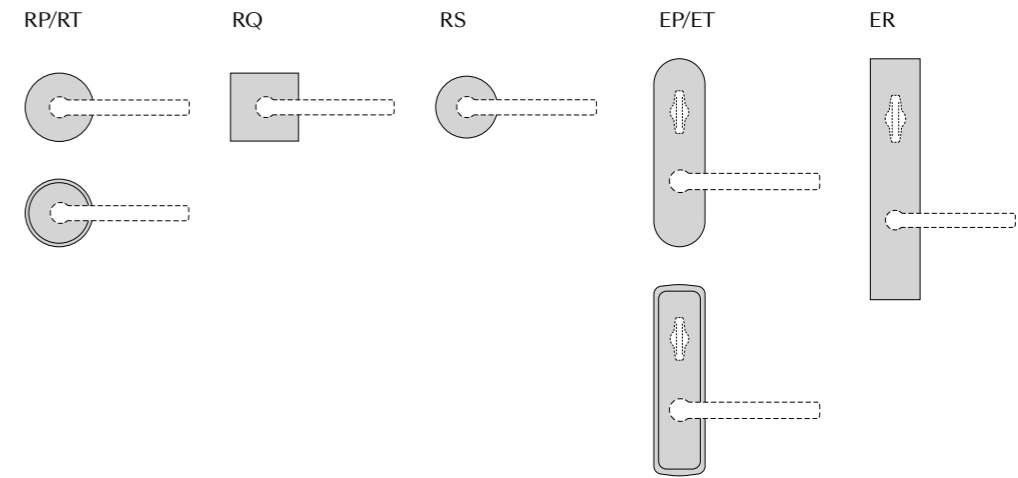

| | RP/RT | RQ | RS | EP/ET | ER |
|---------------------|-------------|-------------|-------------|-------------|-------------|
| ML F/Entrance | \$ 1,037.00 | \$ 1,176.00 | \$ 924.00 | \$ 974.00 | \$ 1,010.00 |
| ML FD/Entrance | \$ 1,087.00 | \$ 1,226.00 | \$ 974.00 | \$ 1,024.00 | \$ 1,062.00 |
| ML FW/Entrance | \$ 1,010.00 | \$ 1,163.00 | \$ 885.00 | \$ 949.00 | \$ 985.00 |
| ML B/Entrance | \$ 999.00 | \$ 1,163.00 | \$ 899.00 | \$ 924.00 | \$ 985.00 |
| ML AC/Entrance | \$ 1,010.00 | \$ 1,125.00 | \$ 899.00 | \$ 985.00 | \$ 1,024.00 |
| ML E/Office | \$ 974.00 | \$ 1,062.00 | \$ 859.00 | \$ 974.00 | \$ 1,037.00 |
| ML EW/Storeroom | \$ 935.00 | \$ 1,010.00 | \$ 823.00 | \$ 935.00 | \$ 985.00 |
| ML J/Classroom | \$ 974.00 | \$ 1,062.00 | \$ 859.00 | \$ 974.00 | \$ 1,037.00 |
| ML N/Passage | \$ 809.00 | \$ 848.00 | \$ 683.00 | \$ 834.00 | \$ 873.00 |
| ML LF/Privacy | \$ 1,037.00 | \$ 1,188.00 | \$ 924.00 | \$ 924.00 | \$ 961.00 |
| ML H/Hotel | \$ 1,037.00 | \$ 1,176.00 | \$ 924.00 | \$ 910.00 | \$ 999.00 |
| ML NC/Communicating | \$ 570.00 | \$ 583.00 | \$ 583.00 | \$ 658.00 | \$ 671.00 |
| ML ELEC/Electrified | \$ 2,274.00 | \$ 2,374.00 | \$ 2,160.00 | \$ 2,261.00 | \$ 2,313.00 |

Conversions from metric to U.S. measurements are approximate.

The prices above refer to locks of 2.3/4" and 2.1/2" backset. Upcharges apply for different backsets. See page 17.
 If requested without mortise lock, deduct \$120 retail price. For ML-ELECT without mortise lock, deduct \$120 from ML-EW retail price.

If requested without cylinder, deduct \$15 retail price. Same prices for all the standard finishes as indicated per each lever page. Special finishes are available upon request. See pages 12-13 for finish selection. Upcharges apply.

Upside Down and Magnetic Locks are available upon request. Upcharges at page 17.
 For the electrified mortise locks, the AE switch (Request to Exit) must be requested at the time of the order. Upcharges apply.

Group 3 Mortise locks

Door levers _____ H 1039, H 1040, H 1060, H 1068, H 1069, H 1748
 Door knobs _____ K 1054, K 1056, K 1060, K 1061, K 1171, K 1730

Retail price

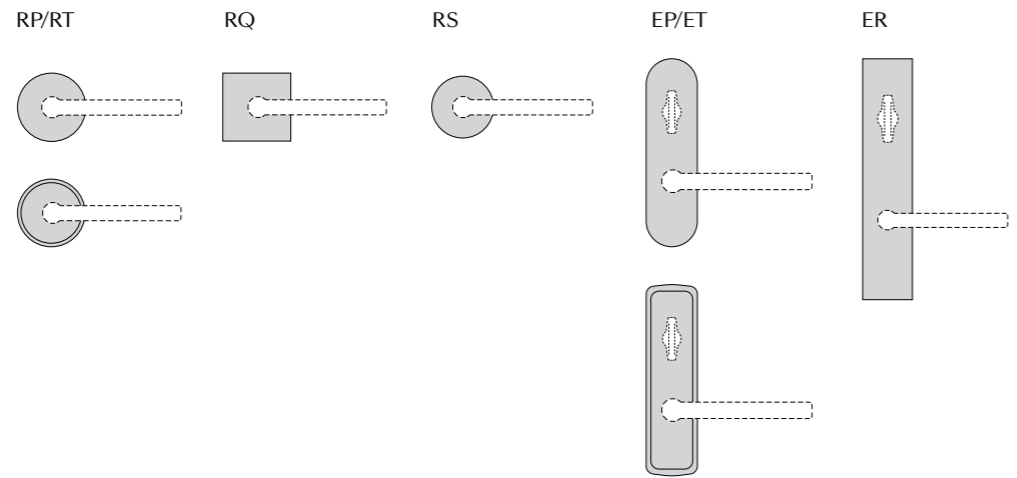

| | RP/RT | RQ | RS | EP/ET | ER |
|---------------------|-------------|-------------|-------------|-------------|-------------|
| ML F/Entrance | \$ 1,251.00 | \$ 1,389.00 | \$ 1,138.00 | \$ 1,200.00 | \$ 1,226.00 |
| ML FD/Entrance | \$ 1,314.00 | \$ 1,454.00 | \$ 1,188.00 | \$ 1,251.00 | \$ 1,289.00 |
| ML FW/Entrance | \$ 1,226.00 | \$ 1,379.00 | \$ 1,087.00 | \$ 1,163.00 | \$ 1,200.00 |
| ML B/Entrance | \$ 1,226.00 | \$ 1,389.00 | \$ 1,100.00 | \$ 1,151.00 | \$ 1,200.00 |
| ML AC/Entrance | \$ 1,251.00 | \$ 1,328.00 | \$ 1,100.00 | \$ 1,200.00 | \$ 1,238.00 |
| ML E/Office | \$ 1,188.00 | \$ 1,289.00 | \$ 1,075.00 | \$ 1,200.00 | \$ 1,251.00 |
| ML EW/Storeroom | \$ 1,151.00 | \$ 1,226.00 | \$ 1,037.00 | \$ 1,151.00 | \$ 1,200.00 |
| ML J/Classroom | \$ 1,188.00 | \$ 1,289.00 | \$ 1,075.00 | \$ 1,200.00 | \$ 1,251.00 |
| ML N/Passage | \$ 1,024.00 | \$ 1,049.00 | \$ 899.00 | \$ 1,049.00 | \$ 1,087.00 |
| ML LF/Privacy | \$ 1,251.00 | \$ 1,415.00 | \$ 1,138.00 | \$ 1,138.00 | \$ 1,188.00 |
| ML H/Hotel | \$ 1,251.00 | \$ 1,389.00 | \$ 1,138.00 | \$ 1,113.00 | \$ 1,226.00 |
| ML NC/Communicating | \$ 683.00 | \$ 696.00 | \$ 696.00 | \$ 759.00 | \$ 785.00 |
| ML ELEC/Electrified | \$ 2,464.00 | \$ 2,551.00 | \$ 2,362.00 | \$ 2,500.00 | \$ 2,526.00 |

Conversions from metric to U.S. measurements are approximate.

The prices above refer to locks of 2.3/4" and 2.1/2" backset. Upcharges apply for different backsets. See page 17.
 If requested without mortise lock, deduct \$120 retail price. For ML-ELECT without mortise lock, deduct \$120 from ML-EW retail price.

If requested without cylinder, deduct \$15 retail price. Same prices for all the standard finishes as indicated per each lever page. Special finishes are available upon request. See pages 12-13 for finish selection. Upcharges apply.

Upside Down and Magnetic Locks are available upon request. Upcharges at page 17.
 For the electrified mortise locks, the AE switch (Request to Exit) must be requested at the time of the order. Upcharges apply.

Group 4 Mortise locks

Door levers _____ H 163, H 192, H 1004, H 1037, H 1043, H 1044, H 1058, H 411, H 414, H 415, H 416, H 419

Retail price

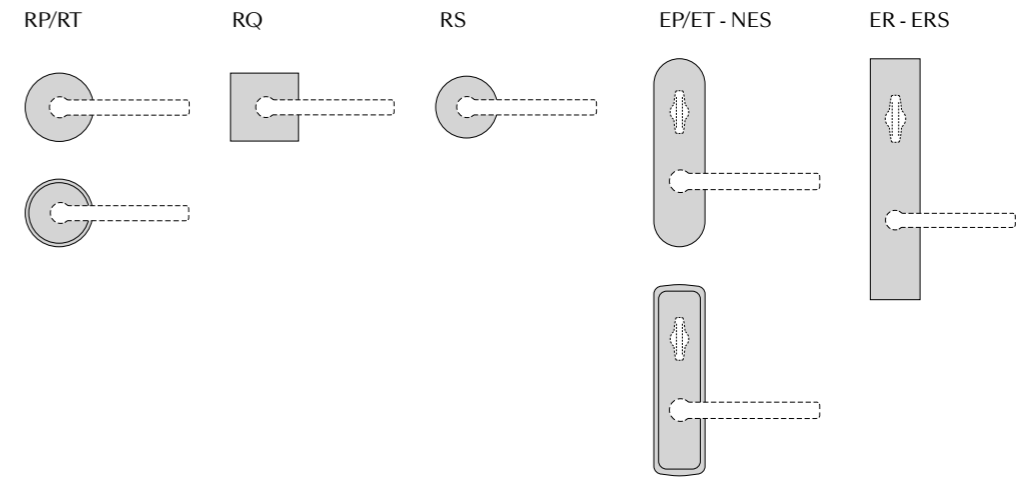

| | RP/RT | RQ | RS | EP/ET - NES | ER - ERS |
|---------------------|-------------|-------------|-------------|-------------|-------------|
| ML F/Entrance | \$ 924.00 | \$ 1,062.00 | \$ 809.00 | \$ 859.00 | \$ 899.00 |
| ML FD/Entrance | \$ 974.00 | \$ 1,125.00 | \$ 859.00 | \$ 910.00 | \$ 949.00 |
| ML FW/Entrance | \$ 899.00 | \$ 1,037.00 | \$ 773.00 | \$ 834.00 | \$ 873.00 |
| ML B/Entrance | \$ 899.00 | \$ 1,049.00 | \$ 785.00 | \$ 809.00 | \$ 873.00 |
| ML AC/Entrance | \$ 899.00 | \$ 1,010.00 | \$ 773.00 | \$ 873.00 | \$ 910.00 |
| ML E/Office | \$ 859.00 | \$ 949.00 | \$ 747.00 | \$ 873.00 | \$ 910.00 |
| ML EW/Storeroom | \$ 823.00 | \$ 910.00 | \$ 709.00 | \$ 823.00 | \$ 873.00 |
| ML J/Classroom | \$ 859.00 | \$ 949.00 | \$ 747.00 | \$ 873.00 | \$ 910.00 |
| ML N/Passage | \$ 734.00 | \$ 734.00 | \$ 721.00 | \$ 759.00 | \$ 924.00 |
| ML LF/Privacy | \$ 924.00 | \$ 1,075.00 | \$ 809.00 | \$ 809.00 | \$ 859.00 |
| ML H/Hotel | \$ 924.00 | \$ 1,062.00 | \$ 809.00 | \$ 798.00 | \$ 885.00 |
| ML NC/Communicating | \$ 520.00 | \$ 532.00 | \$ 532.00 | \$ 596.00 | \$ 620.00 |
| ML ELEC/Electrified | \$ 2,148.00 | \$ 2,248.00 | \$ 2,047.00 | \$ 2,158.00 | \$ 2,210.00 |

Conversions from metric to U.S. measurements are approximate.

The prices above refer to locks of 2.3/4" and 2.1/2" backset. Upcharges apply for different backsets. See page 17.
 If requested without mortise lock, deduct \$120 retail price. For ML-ELECT without mortise lock, deduct \$120 from ML-EW retail price.

If requested without cylinder, deduct \$15 retail price. Same prices for all the standard finishes as indicated per each lever page. Special finishes are available upon request. See pages 12-13 for finish selection. Upcharges apply.

Upside Down and Magnetic Locks are available upon request. Upcharges at page 17.
 For the electrified mortise locks, the AE switch (Request to Exit) must be requested at the time of the order. Upcharges apply.

Group 5 Mortise locks

Door levers _____ H 315, H 317, H 327, H 330, H 334, H 338, H 348, H 361, H 364, H 367, H 368, H 370, H 372, H 381, H 382, H 383, H 385, H 386

Door knobs _____ K 383

Retail price

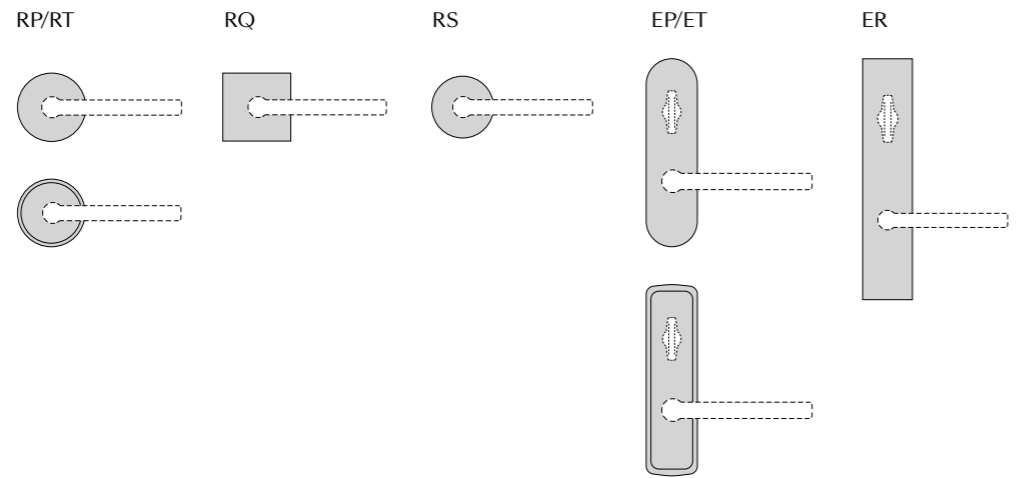

| | RP/RT | RQ | RS | EP/ET | ER |
|---------------------|-------------|-------------|-------------|-------------|-------------|
| ML F/Entrance | \$ 1,100.00 | \$ 1,238.00 | \$ 985.00 | \$ 1,037.00 | \$ 1,075.00 |
| ML FD/Entrance | \$ 1,151.00 | \$ 1,289.00 | \$ 1,037.00 | \$ 1,087.00 | \$ 1,125.00 |
| ML FW/Entrance | \$ 1,075.00 | \$ 1,213.00 | \$ 935.00 | \$ 999.00 | \$ 1,049.00 |
| ML B/Entrance | \$ 1,075.00 | \$ 1,213.00 | \$ 949.00 | \$ 999.00 | \$ 1,049.00 |
| ML AC/Entrance | \$ 1,075.00 | \$ 1,188.00 | \$ 961.00 | \$ 1,049.00 | \$ 1,087.00 |
| ML E/Office | \$ 1,037.00 | \$ 1,125.00 | \$ 924.00 | \$ 1,037.00 | \$ 1,049.00 |
| ML EW/Storeroom | \$ 999.00 | \$ 1,075.00 | \$ 873.00 | \$ 999.00 | \$ 1,006.00 |
| ML J/Classroom | \$ 1,037.00 | \$ 1,125.00 | \$ 924.00 | \$ 1,037.00 | \$ 1,049.00 |
| ML N/Passage | \$ 873.00 | \$ 910.00 | \$ 747.00 | \$ 899.00 | \$ 935.00 |
| ML LF/Privacy | \$ 1,100.00 | \$ 1,251.00 | \$ 985.00 | \$ 985.00 | \$ 1,037.00 |
| ML H/Hotel | - | - | - | \$ 974.00 | \$ 1,075.00 |
| ML NC/Communicating | \$ 607.00 | \$ 620.00 | \$ 620.00 | \$ 696.00 | \$ 721.00 |
| ML ELEC/Electrified | \$ 2,324.00 | \$ 2,425.00 | \$ 2,210.00 | \$ 2,324.00 | \$ 2,374.00 |

Conversions from metric to U.S. measurements are approximate.

The prices above refer to locks of 2.3/4" and 2.1/2" backset. Upcharges apply for different backsets. See page 17.

If requested without mortise lock, deduct \$120 retail price. For ML-ELECT without mortise lock, deduct \$120 from ML-EW retail price.

If requested without cylinder, deduct \$15 retail price.

Same prices for all the standard finishes as indicated per each lever page.

Special finishes are available upon request. See pages 12-13 for finish selection. Upcharges apply.

Upside Down and Magnetic Locks are available upon request. Upcharges at page 17.

For the electrified mortise locks, the AE switch (Request to Exit) must be requested at the time of the order. Upcharges apply.

Group 6 Mortise locks

Door levers _____ H 311, H 329, H 335, H 343, H 359, H 376, H 378, H 384, H 5014

Door knob _____ K 378

Retail price

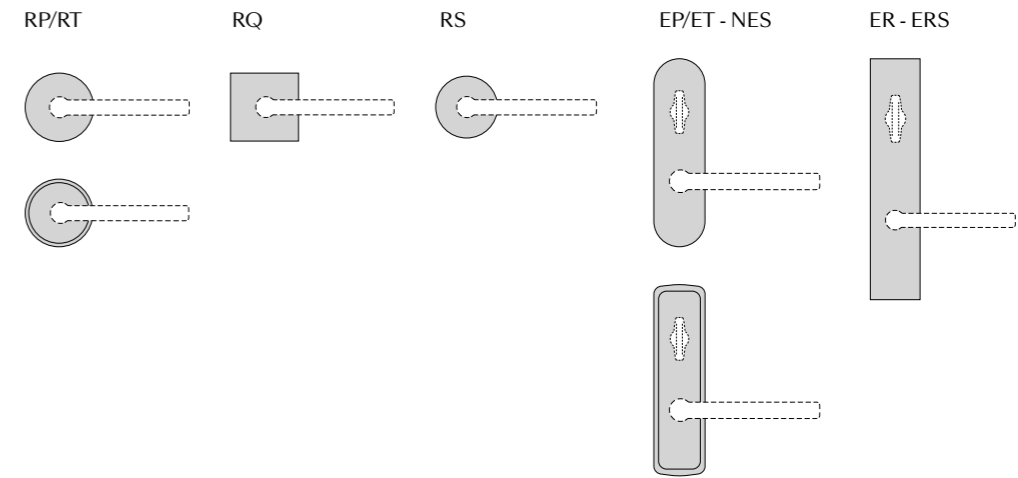

| | RP/RT | RQ | RS | EP/ET - NES | ER - ERS |
|---------------------|-------------|-------------|-------------|-------------|-------------|
| ML F/Entrance | \$ 1,213.00 | \$ 1,389.00 | \$ 1,125.00 | \$ 1,163.00 | \$ 1,200.00 |
| ML FD/Entrance | \$ 1,289.00 | \$ 1,428.00 | \$ 1,176.00 | \$ 1,226.00 | \$ 1,264.00 |
| ML FW/Entrance | \$ 1,200.00 | \$ 1,353.00 | \$ 1,075.00 | \$ 1,138.00 | \$ 1,188.00 |
| ML B/Entrance | \$ 1,213.00 | \$ 1,353.00 | \$ 1,087.00 | \$ 1,125.00 | \$ 1,176.00 |
| ML AC/Entrance | \$ 1,200.00 | \$ 1,314.00 | \$ 1,084.00 | \$ 1,188.00 | \$ 1,226.00 |
| ML E/Office | \$ 1,176.00 | \$ 1,251.00 | \$ 1,062.00 | \$ 1,176.00 | \$ 1,226.00 |
| ML EW/Storeroom | \$ 1,138.00 | \$ 1,213.00 | \$ 1,010.00 | \$ 1,125.00 | \$ 1,176.00 |
| ML J/Classroom | \$ 1,176.00 | \$ 1,251.00 | \$ 1,062.00 | \$ 1,176.00 | \$ 1,226.00 |
| ML N/Passage | \$ 1,010.00 | \$ 1,037.00 | \$ 885.00 | \$ 1,037.00 | \$ 1,075.00 |
| ML LF/Privacy | \$ 1,226.00 | \$ 1,389.00 | \$ 1,113.00 | \$ 1,113.00 | \$ 1,163.00 |
| ML H/Hotel | - | - | - | \$ 1,100.00 | \$ 1,188.00 |
| ML NC/Communicating | \$ 671.00 | \$ 683.00 | \$ 683.00 | \$ 759.00 | \$ 773.00 |
| ML ELEC/Electrified | \$ 2,464.00 | \$ 2,576.00 | \$ 2,338.00 | \$ 2,450.00 | \$ 2,500.00 |

Conversions from metric to U.S. measurements are approximate.

The prices above refer to locks of 2.3/4" and 2.1/2" backset. Upcharges apply for different backsets. See page 17.

If requested without mortise lock, deduct \$120 retail price. For ML-ELECT without mortise lock, deduct \$120 from ML-EW retail price.

If requested without cylinder, deduct \$15 retail price.

Same prices for all the standard finishes as indicated per each lever page.

Special finishes are available upon request. See pages 12-13 for finish selection. Upcharges apply.

Upside Down and Magnetic Locks are available upon request. Upcharges at page 17.

For the electrified mortise locks, the AE switch (Request to Exit) must be requested at the time of the order. Upcharges apply.

Group 7 Mortise locks

Door levers _____ H 377, H 5008
 Door knob _____ K 377, K 5301

Retail price

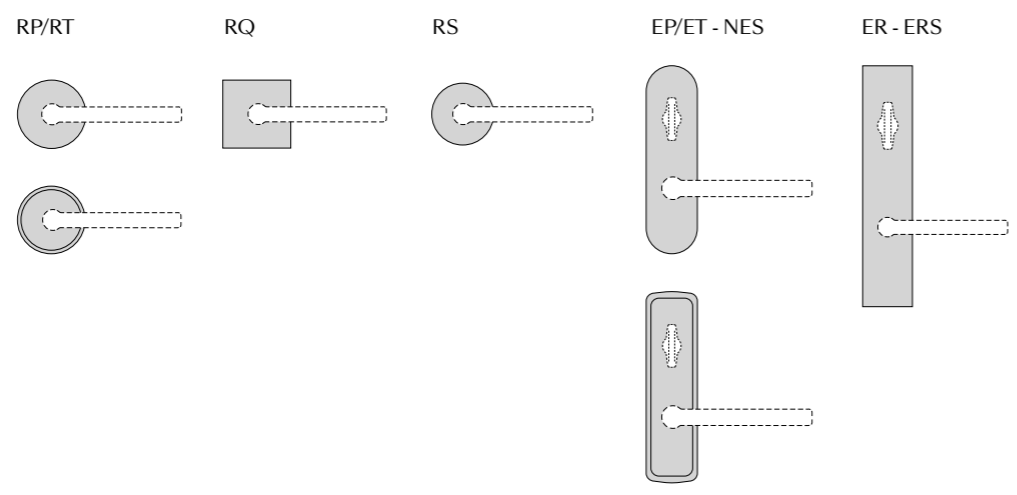

| | RP/RT | RQ | RS | EP/ET - NES | ER - ERS |
|---------------------|-------------|-------------|-------------|-------------|-------------|
| ML F/Entrance | \$ 1,617.00 | \$ 1,755.00 | \$ 1,504.00 | \$ 1,555.00 | \$ 1,592.00 |
| ML FD/Entrance | \$ 1,668.00 | \$ 1,807.00 | \$ 1,555.00 | \$ 1,605.00 | \$ 1,643.00 |
| ML FW/Entrance | \$ 1,579.00 | \$ 1,755.00 | \$ 1,454.00 | \$ 1,516.00 | \$ 1,568.00 |
| ML B/Entrance | \$ 1,579.00 | \$ 1,744.00 | \$ 1,465.00 | \$ 1,504.00 | \$ 1,568.00 |
| ML AC/Entrance | \$ 1,592.00 | \$ 1,693.00 | \$ 1,465.00 | \$ 1,568.00 | \$ 1,605.00 |
| ML E/Office | \$ 1,568.00 | \$ 1,643.00 | \$ 1,440.00 | \$ 1,555.00 | \$ 1,605.00 |
| ML EW/Storeroom | \$ 1,516.00 | \$ 1,592.00 | \$ 1,389.00 | \$ 1,516.00 | \$ 1,568.00 |
| ML J/Classroom | \$ 1,568.00 | \$ 1,643.00 | \$ 1,440.00 | \$ 1,555.00 | \$ 1,605.00 |
| ML N/Passage | \$ 1,403.00 | \$ 1,428.00 | \$ 1,264.00 | \$ 1,415.00 | \$ 1,465.00 |
| ML LF/Privacy | \$ 1,617.00 | \$ 1,668.00 | \$ 1,504.00 | \$ 1,504.00 | \$ 1,555.00 |
| ML H/Hotel | - | - | - | \$ 1,491.00 | \$ 1,579.00 |
| ML NC/Communicating | \$ 859.00 | \$ 873.00 | \$ 873.00 | \$ 949.00 | \$ 961.00 |
| ML ELEC/Electrified | \$ 2,843.00 | \$ 2,918.00 | \$ 2,727.00 | \$ 2,842.00 | \$ 2,905.00 |

Conversions from metric to U.S. measurements are approximate.

The prices above refer to locks of 2.3/4" and 2.1/2" backset. Upcharges apply for different backsets. See page 17.
 If requested without mortise lock, deduct \$120 retail price. For ML-ELECT without mortise lock, deduct \$120 from ML-EW retail price.

If requested without cylinder, deduct \$15 retail price. Same prices for all the standard finishes as indicated per each lever page. Special finishes are available upon request. See pages 12-13 for finish selection. Upcharges apply.

Upside Down and Magnetic Locks are available upon request. Upcharges at page 17.
 For the electrified mortise locks, the AE switch (Request to Exit) must be requested at the time of the order. Upcharges apply.

Group 8 Mortise locks

Door levers _____ H 356, H 379, H 380, H 5015/32D, H 5017

Retail price

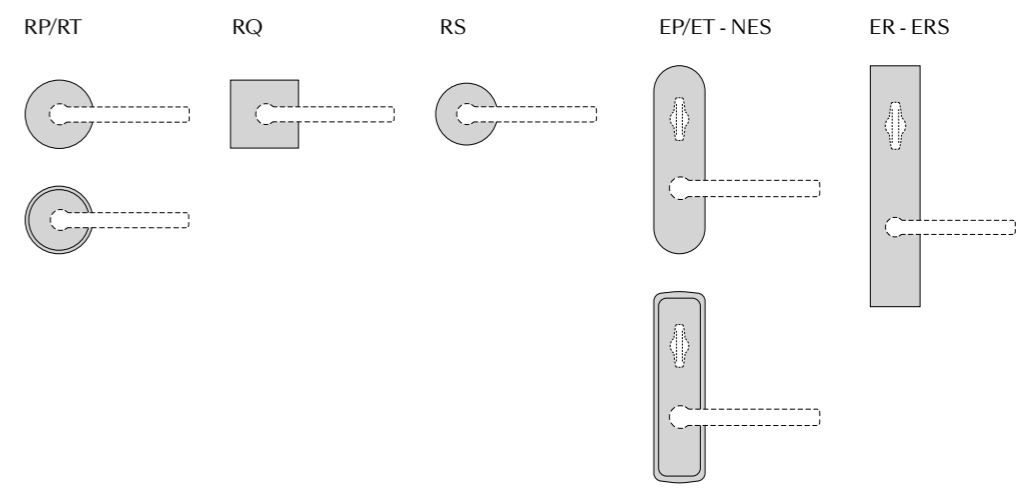

| | RP/RT | RQ | RS | EP/ET - NES | ER - ERS |
|---------------------|-------------|-------------|-------------|-------------|-------------|
| ML F/Entrance | \$ 1,668.00 | \$ 1,819.00 | \$ 1,579.00 | \$ 1,617.00 | \$ 1,655.00 |
| ML FD/Entrance | \$ 1,744.00 | \$ 1,869.00 | \$ 1,617.00 | \$ 1,668.00 | \$ 1,706.00 |
| ML FW/Entrance | \$ 1,643.00 | \$ 1,793.00 | \$ 1,516.00 | \$ 1,592.00 | \$ 1,630.00 |
| ML B/Entrance | \$ 1,643.00 | \$ 1,793.00 | \$ 1,542.00 | \$ 1,592.00 | \$ 1,630.00 |
| ML AC/Entrance | \$ 1,668.00 | \$ 1,793.00 | \$ 1,568.00 | \$ 1,655.00 | \$ 1,706.00 |
| ML E/Office | \$ 1,617.00 | \$ 1,706.00 | \$ 1,328.00 | \$ 1,617.00 | \$ 1,643.00 |
| ML EW/Storeroom | \$ 1,592.00 | \$ 1,668.00 | \$ 1,290.00 | \$ 1,579.00 | \$ 1,630.00 |
| ML J/Classroom | \$ 1,617.00 | \$ 1,706.00 | \$ 1,328.00 | \$ 1,617.00 | \$ 1,643.00 |
| ML N/Passage | \$ 1,454.00 | \$ 1,617.00 | \$ 1,238.00 | \$ 1,479.00 | \$ 1,516.00 |
| ML LF/Privacy | \$ 1,693.00 | \$ 1,819.00 | \$ 1,568.00 | \$ 1,568.00 | \$ 1,605.00 |
| ML H/Hotel | - | - | - | \$ 1,542.00 | \$ 1,643.00 |
| ML NC/Communicating | \$ 899.00 | \$ 902.00 | \$ 910.00 | \$ 985.00 | \$ 999.00 |
| ML ELEC/Electrified | \$ 2,918.00 | \$ 3,030.00 | \$ 2,778.00 | \$ 2,905.00 | \$ 2,968.00 |

Conversions from metric to U.S. measurements are approximate.

The prices above refer to locks of 2.3/4" and 2.1/2" backset. Upcharges apply for different backsets. See page 17.
 If requested without mortise lock, deduct \$120 retail price. For ML-ELECT without mortise lock, deduct \$120 from ML-EW retail price.

If requested without cylinder, deduct \$15 retail price. Same prices for all the standard finishes as indicated per each lever page. Special finishes are available upon request. See pages 12-13 for finish selection. Upcharges apply.

Upside Down and Magnetic Locks are available upon request. Upcharges at page 17.
 For the electrified mortise locks, the AE switch (Request to Exit) must be requested at the time of the order. Upcharges apply.

Group 9 Mortise locks

Door levers _____ H 5015 Black leather, H 5015 Orange leather

Retail price

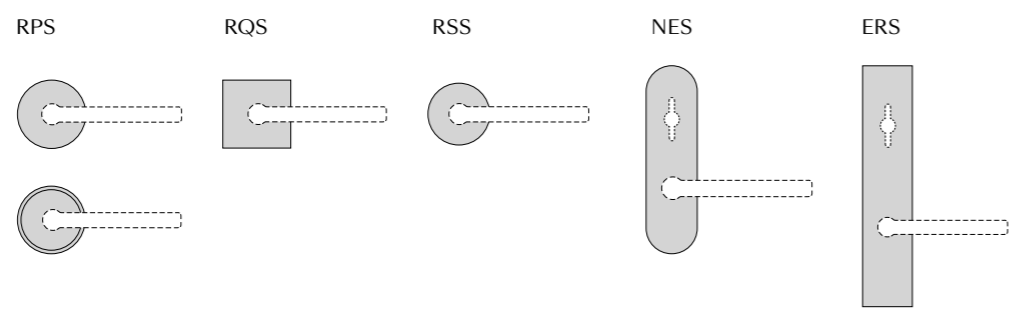

| | | | | | |
|----------------------------|-------------|-------------|-------------|-------------|-------------|
| ML F/Entrance | \$ 2,299.00 | \$ 2,464.00 | \$ 2,009.00 | \$ 2,059.00 | \$ 2,101.00 |
| ML FD/Entrance | \$ 2,349.00 | \$ 2,464.00 | \$ 2,059.00 | \$ 2,110.00 | \$ 2,148.00 |
| ML FW/Entrance | \$ 2,261.00 | \$ 2,274.00 | \$ 1,983.00 | \$ 2,047.00 | \$ 2,085.00 |
| ML B/Entrance | \$ 2,248.00 | \$ 2,274.00 | \$ 1,995.00 | \$ 2,047.00 | \$ 2,085.00 |
| ML AC/Entrance | \$ 2,210.00 | \$ 2,274.00 | \$ 1,934.00 | \$ 2,085.00 | \$ 2,172.00 |
| ML E/Office | \$ 2,123.00 | \$ 2,210.00 | \$ 1,844.00 | \$ 2,009.00 | \$ 2,110.00 |
| ML EW/Storeroom | \$ 2,085.00 | \$ 2,148.00 | \$ 1,807.00 | \$ 1,970.00 | \$ 2,059.00 |
| ML J/Classroom | \$ 2,123.00 | \$ 2,210.00 | \$ 1,844.00 | \$ 2,009.00 | \$ 2,110.00 |
| ML N/Passage | \$ 1,895.00 | \$ 1,959.00 | \$ 1,617.00 | \$ 1,832.00 | \$ 1,934.00 |
| ML LF/Privacy | \$ 2,274.00 | \$ 2,263.00 | \$ 1,995.00 | \$ 1,959.00 | \$ 2,020.00 |
| ML H/Hotel | - | - | - | \$ 2,097.00 | \$ 2,027.00 |
| ML NC/Communicating | \$ 1,138.00 | \$ 1,200.00 | \$ 1,113.00 | \$ 1,138.00 | \$ 1,213.00 |
| ML ELEC/Electrified | \$ 3,409.00 | \$ 3,535.00 | \$ 3,132.00 | \$ 3,284.00 | \$ 3,384.00 |

Conversions from metric to U.S. measurements are approximate.

The prices above refer to locks of 2.3/4" and 2.1/2" backset. Upcharges apply for different backsets. See page 17.
If requested without mortise lock, deduct \$120 retail price. For ML-ELECT without mortise lock, deduct \$120 from ML-EW retail price.

If requested without cylinder, deduct \$15 retail price. Same prices for all the standard finishes as indicated per each lever page. Special finishes are available upon request. See pages 12-13 for finish selection. Upcharges apply.

Upside Down and Magnetic Locks are available upon request. Upcharges at page 17.
For the electrified mortise locks, the AE switch (Request to Exit) must be requested at the time of the order. Upcharges apply.

L 198

Brass

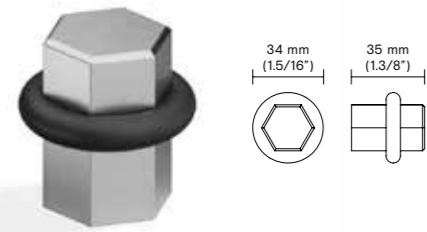

| Finish | Retail price |
|---------------------------|--------------|
| 03 Polished brass | \$ 35.00 |
| 03D Satin brass | \$ 38.00 |
| 14 Polished nickel | \$ 46.00 |
| 15 Satin nickel | \$ 49.00 |
| 26 Polished chrome | \$ 42.00 |
| 26D Satin chrome | \$ 44.00 |

L 192

Brass

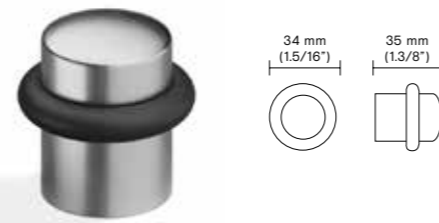

| Finish | Retail price |
|---------------------------|--------------|
| 03 Polished brass | \$ 34.00 |
| 03D Satin brass | \$ 34.00 |
| 06A Anticato | \$ 49.00 |
| 06B Brunito | \$ 49.00 |
| 14 Polished nickel | \$ 48.00 |
| 15 Satin nickel | \$ 48.00 |
| 26 Polished chrome | \$ 50.00 |
| 26D Satin chrome | \$ 39.00 |

L 190

Brass



| Finish | Retail price |
|---------------------------|--------------|
| 03 Polished brass | \$ 40.00 |
| 06B Brunito | \$ 40.00 |
| 14 Polished nickel | \$ 49.00 |
| 26 Polished chrome | \$ 40.00 |
| 26D Satin chrome | \$ 46.00 |

L 490

Stainless steel AISI 304



| Finish | Retail price |
|----------------------------------|--------------|
| 32D Satin stainless steel | \$ 35.00 |

E 183

Brass

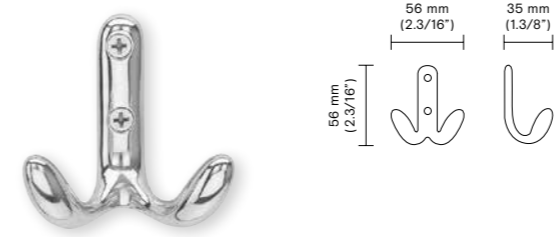

| Finish | Retail price |
|---------------------------|--------------|
| 03 Polished brass | \$ 30.00 |
| 06B Brunito | \$ 36.00 |
| 26 Polished chrome | \$ 30.00 |
| 26D Satin chrome | \$ 32.00 |

E 182

Brass

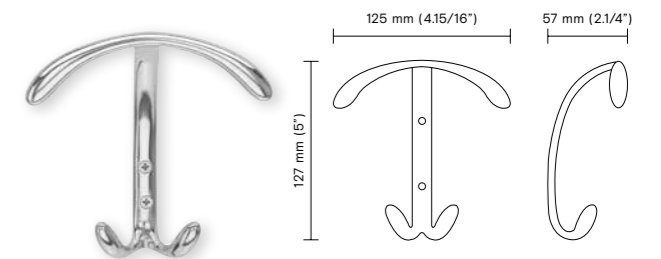

| Finish | Retail price |
|---------------------------|--------------|
| 03 Polished brass | \$ 58.00 |
| 06B Brunito | \$ 69.00 |
| 26 Polished chrome | \$ 63.00 |
| 26D Satin chrome | \$ 60.00 |

E 180

Brass

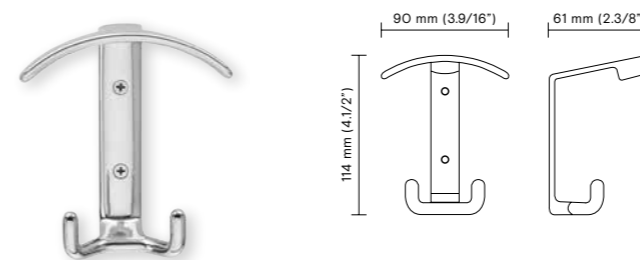

| Finish | Retail price |
|--------------------------|--------------|
| 03 Polished brass | \$ 93.00 |
| 26D Satin chrome | \$ 83.00 |

The options listed above are considered standard. Non-standard options are available upon request. For more options on Finishes see pages 12-13.

The options listed above are considered standard. Non-standard options are available upon request. For more options on Finishes see pages 12-13.

MAGNETIC TUBULAR LATCH

Every lever and knob in our range can be matched to a magnetic tubular latch. The latch is only available in 3 finishes: 26/Polished chrome, 26D/Satin chrome, 16/Dull black. The upcharge is \$ 35.00 LIST from the price of a standard tubular set. The price of the spare latches are listed below.

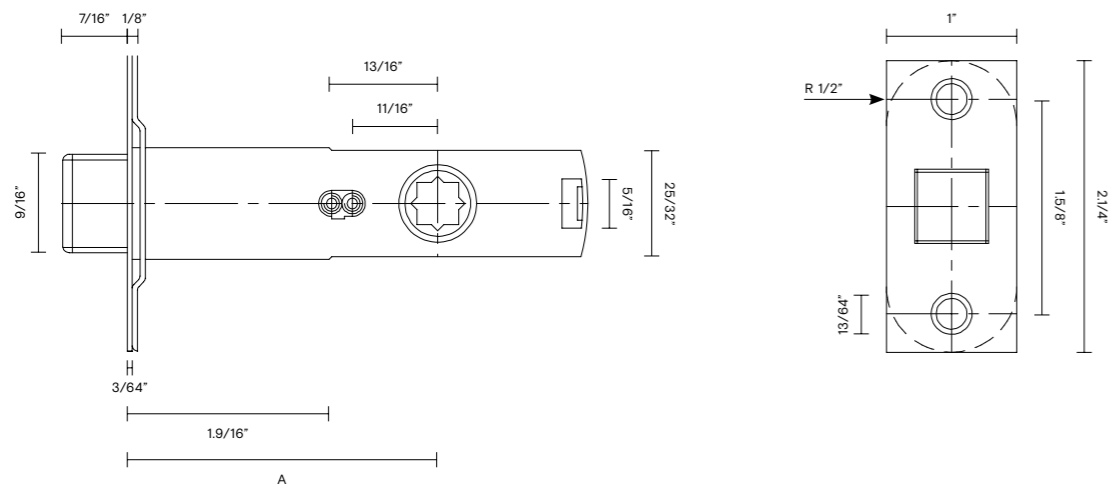

A = 2.3/8" or 2.3/4"

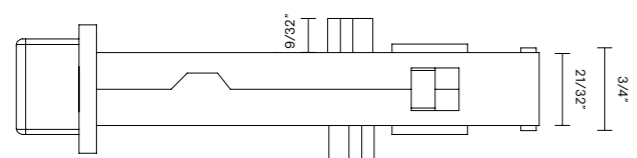

Retail price

| Part N° | Backset | Functions | Overall latch size | 26 | 26D | 16 |
|------------|---------|-----------|--------------------|----------|----------|----------|
| O1M | 2.3/8" | Passage | 3.1/2" | \$ 65.00 | \$ 65.00 | \$ 65.00 |
| O2M | 2.3/4" | Passage | 3.7/8" | \$ 65.00 | \$ 65.00 | \$ 65.00 |
| O3M | 2.3/8" | Privacy | 3.1/2" | \$ 75.00 | \$ 75.00 | \$ 75.00 |
| O4M | 2.3/4" | Privacy | 3.7/8" | \$ 75.00 | \$ 75.00 | \$ 75.00 |

TUBULAR LATCH BOLTS 28 DEGREES

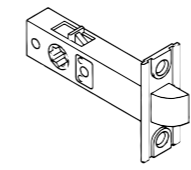

Retail price

| Part N° | Backset | Functions | Overall latch size | 03 Polished brass | 06 Antique brass | 26/14 Polished chrome/ Polished nickel | 26D/15 Satin chrome/ Satin nickel | Others |
|------------|---------|-----------|--------------------|-------------------|------------------|--|-----------------------------------|----------|
| O1L | 2.3/8" | Passage | 3.1/4" | \$ 45.00 | \$ 45.00 | \$ 45.00 | \$ 45.00 | \$ 65.00 |
| O2L | 2.3/4" | Passage | 3.5/8" | \$ 45.00 | \$ 45.00 | \$ 45.00 | \$ 45.00 | \$ 65.00 |
| O3L | 2.3/8" | Privacy | 3.1/4" | \$ 55.00 | \$ 55.00 | \$ 55.00 | \$ 55.00 | \$ 75.00 |
| O4L | 2.3/4" | Privacy | 3.5/8" | \$ 55.00 | \$ 55.00 | \$ 55.00 | \$ 55.00 | \$ 75.00 |

DEADBOLT LATCH & PRIVACY BOLTS

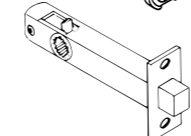
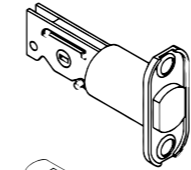

| Part N° | Backset | Functions | Overall latch size | 03 Polished brass | 06 Antique brass | 26/14 Polished chrome/ Polished nickel | 26D/15 Satin chrome/ Satin nickel | Others |
|--|---------|--------------|--------------------|-------------------|------------------|--|-----------------------------------|-----------|
| O9 | 2.3/8" | Dead bolt | 3.1/4" | \$ 90.00 | \$ 90.00 | \$ 90.00 | \$ 90.00 | \$ 100.00 |
| 10 | 2.3/4" | Dead bolt | 3.5/8" | \$ 90.00 | \$ 90.00 | \$ 90.00 | \$ 90.00 | \$ 100.00 |
| Above includes: deadbolt latch, mortise cylinder housing, strike plate for both metal and wood jambs, face plate and screws (no cylinder) | | | | | | | | |
| X 30 | 2.3/8" | Privacy bolt | 3.5/16" | \$ 55.00 | \$ 55.00 | \$ 55.00 | \$ 55.00 | \$ 60.00 |
| X 31 | 2.3/4" | Privacy bolt | 3.3/4" | \$ 55.00 | \$ 55.00 | \$ 55.00 | \$ 55.00 | \$ 60.00 |

HOUSINGS

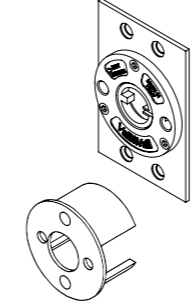

| Part N° | Description | Retail price |
|-------------------------|---|---------------|
| X 2122 / X 0436 | Housing for rosettes | \$ 27.00 each |
| X 0403 | Interior underrosette to mount interior deadbolt trim | \$ 55.00 each |
| X 1116 / X 0545 | Underrosettes for RP/Round Deadbolt | \$ 98.00 pair |
| X 0550 | Underrosettes for RQ/Square Deadbolt | \$ 17.00 side |
| X 0547 | Underrosettes for RQ Mortise lock | \$ 52.00 pair |
| X 2124M / X 0428 | Housing, spring loaded for long escutcheon plates | \$ 22.00 each |

STRIKE PLATES

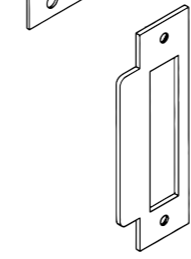
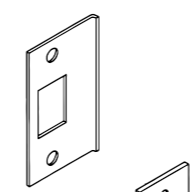
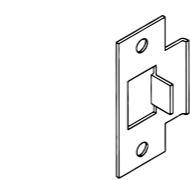

| Part N° | Description | 03 Polished brass | 06 Antique brass | 15 Satin nickel | 26 Polished chrome | 26D Satin chrome | 14 Polished nickel |
|----------------|---------------------------------|-------------------|------------------|-----------------|--------------------|------------------|--------------------|
| TS 01 | T-strikes (tubular latch) | \$ 10.00 | - | \$ 10.00 | \$ 10.00 | \$ 10.00 | \$ 10.00 |
| ETS-115 | Extended for doors 2.1/4" thick | \$ 50.00 | \$ 50.00 | \$ 50.00 | \$ 50.00 | \$ 50.00 | - |
| ETS-175 | Extended for doors 2.1/2" & up | \$ 50.00 | \$ 50.00 | \$ 50.00 | \$ 50.00 | \$ 50.00 | - |
| FL 01 | Full lip (tubular latch) | \$ 9.00 | \$ 9.00 | \$ 9.00 | \$ 9.00 | \$ 9.00 | \$ 9.00 |
| ETS-115 | Extended for doors 2.1/4" thick | \$ 50.00 | \$ 50.00 | \$ 50.00 | \$ 50.00 | \$ 50.00 | - |
| ETS-175 | Extended for doors 2.1/2" & up | \$ 50.00 | \$ 50.00 | \$ 50.00 | \$ 50.00 | \$ 50.00 | - |
| TS 01 | T-strikes (tubular latch) | \$ 10.00 | - | \$ 10.00 | \$ 10.00 | \$ 10.00 | \$ 10.00 |
| ETS-115 | Extended for doors 2.1/4" thick | \$ 50.00 | \$ 50.00 | \$ 50.00 | \$ 50.00 | \$ 50.00 | - |
| ETS-175 | Extended for doors 2.1/2" & up | \$ 50.00 | \$ 50.00 | \$ 50.00 | \$ 50.00 | \$ 50.00 | - |

Rosettes

Retail price

| RT Traditional 2.9/16" (65mtm) | 03/03D Polished brass / Satin brass | 14 Polished nickel | 15 Satin nickel | 26/26D Polished chrome/ Satin chrome | Other |
|-------------------------------------|-------------------------------------|--------------------|-----------------|--------------------------------------|----------|
| K 1749 RS (ML) threaded each | \$ 43.00 | \$ 53.00 | \$ 45.00 | \$ 44.00 | \$ 53.00 |
| K 1741 RRS PGE CP | \$ 39.00 | \$ 39.00 | \$ 49.00 | \$ 39.00 | \$ 59.00 |
| K 1741 RRS PCY CPK | \$ 54.00 | \$ 81.00 | \$ 64.00 | \$ 54.00 | \$ 81.00 |
| K 1741 RRS SF (DMY) each | \$ 19.00 | \$ 30.00 | \$ 25.00 | \$ 19.00 | \$ 29.00 |

Retail price

| RP Round 2.9/16" (65mm) | 03/03D Polished brass / Satin brass | 14 Polished nickel | 15 Satin nickel | 26 Polished chrome | 26D Satin chrome | Other |
|-------------------------------------|-------------------------------------|--------------------|-----------------|--------------------|------------------|----------|
| K 1748 RS (ML) threaded each | \$ 41.00 | \$ 54.00 | \$ 50.00 | \$ 41.00 | \$ 50.00 | \$ 54.00 |
| K 1742 RRS PGE CP | \$ 44.00 | \$ 45.00 | \$ 53.00 | \$ 42.00 | \$ 45.00 | \$ 71.00 |
| K 1742 RRS PCY CPK | \$ 54.00 | \$ 56.00 | \$ 64.00 | \$ 59.00 | \$ 56.00 | \$ 89.00 |
| K 1742 RRS SF (DMY) each | \$ 21.00 | \$ 23.00 | \$ 27.00 | \$ 19.00 | \$ 23.00 | \$ 37.00 |

Retail price

| RP Round | 03/03D Polished brass / Satin brass | 14 Polished nickel | 15 Satin nickel | 26 Polished chrome | 26D Satin chrome | Other |
|--------------------------------------|-------------------------------------|--------------------|-----------------|--------------------|------------------|----------|
| K 1112 RS 1.3/4" (45 mm) each | \$ 32.00 | \$ 35.00 | \$ 35.00 | \$ 32.00 | \$ 35.00 | \$ 37.00 |
| K 1121 RS 2" (50 mm) each | \$ 32.00 | \$ 35.00 | \$ 35.00 | \$ 32.00 | \$ 35.00 | \$ 37.00 |

Retail price

| RPS Stainless Steel Round 2.9/16" (65mm) | 32 Polished stainless steel | 32D Satin stainless steel |
|--|-----------------------------|---------------------------|
| R 5701 (ML) threaded each | \$ 146.00 | \$ 111.00 |
| R 5703 RRS PGE | \$ 117.00 | \$ 122.00 |
| R 5703 RRS PCY CPK | \$ 136.00 | \$ 122.00 |
| R 5703 RRS SF (DMY) each | \$ 59.00 | \$ 62.00 |

Retail price

| RSS Stainless Steel Round 2" (50mm) | 32 Polished stainless steel | 32D Satin stainless steel |
|-------------------------------------|-----------------------------|---------------------------|
| R 5704 RRS PGE | \$ 81.00 | \$ 58.00 |
| R 5702 RS (DMY) each | \$ 27.00 | \$ 22.00 |

Retail price

| RQ Square 2.9/16" (65mm) | 14 Polished nickel | 15 Satin nickel | 26 Polished chrome | 26D Satin chrome | Other |
|--------------------------------------|--------------------|-----------------|--------------------|------------------|-----------|
| K 1780 RS I (inside) ML each | \$ 103.00 | \$ 103.00 | \$ 85.00 | \$ 103.00 | \$ 103.00 |
| K 1780 RS E (outside) ML each | \$ 103.00 | \$ 103.00 | \$ 85.00 | \$ 103.00 | \$ 103.00 |
| K 1798 RRS PGE | \$ 192.00 | \$ 176.00 | \$ 161.00 | \$ 176.00 | \$ 192.00 |
| K 1798 RRS PCY | \$ 203.00 | \$ 187.00 | \$ 187.00 | \$ 203.00 | \$ 203.00 |
| K 1798 RRS (DMY) each | \$ 103.00 | \$ 103.00 | \$ 85.00 | \$ 103.00 | \$ 103.00 |

Retail price

| RQS Square 2" (50mm) | 26 Polished chrome | 26D Satin chrome | Other |
|-----------------------|--------------------|------------------|----------|
| K 1138 RS each | \$ 37.00 | \$ 48.00 | \$ 48.00 |

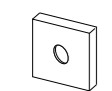
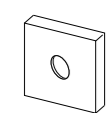
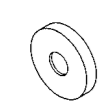
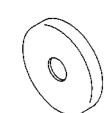
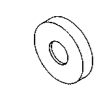
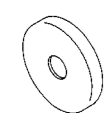
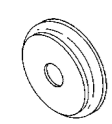

Rosettes

Retail price

| RPS Stainless steel square 2.9/16" (65mm) | 32 Polished stainless steel | 32D Satin stainless steel |
|---|-----------------------------|---------------------------|
| R 5709 RS I (inside) ML each | \$ 173.00 | \$ 132.00 |
| R 5709 RS E (outside) ML each | \$ 173.00 | \$ 132.00 |
| R 5707 RRS PGE | \$ 326.00 | \$ 252.00 |
| R 5707 RRS PCY | \$ 354.00 | \$ 272.00 |
| R 5707 RRS (DMY) each | \$ 173.00 | \$ 132.00 |

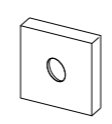

Mortise cylinder - C keyway

Retail price

| Part N° | Door thickness | 03 Polished brass | 06B Brunito | 15 Satin nickel | 26 Polished chrome | 26D Satin chrome |
|-------------------------|---------------------|-------------------|-------------|-----------------|--------------------|------------------|
| C 01 15/16" cyl. | 1.3/8" D | \$ 43.00 | \$ 43.00 | \$ 43.00 | \$ 43.00 | \$ 43.00 |
| C 02 1.1/8" cyl. | 1.3/4" D | \$ 43.00 | \$ 43.00 | \$ 43.00 | \$ 43.00 | \$ 43.00 |
| C 03 1.1/4" cyl. | 2" D - 1.3/4" M | \$ 43.00 | \$ 43.00 | \$ 43.00 | \$ 43.00 | \$ 43.00 |
| C 04 1.3/8" cyl. | 2.1/4" D - 2" M | \$ 43.00 | \$ 43.00 | \$ 43.00 | \$ 43.00 | \$ 43.00 |
| C 05 1.1/2" cyl. | 2.1/2" D - 2.1/4" M | \$ 43.00 | \$ 43.00 | \$ 43.00 | \$ 43.00 | \$ 43.00 |
| C06 1.3/4" cyl. | 3" D - 2.3/4" M | \$ 43.00 | \$ 43.00 | \$ 43.00 | \$ 43.00 | \$ 43.00 |

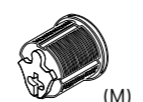
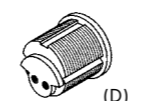

Must specify Daedbolt (D) or Mortise lock (M). Straight cam is used for mortise locks without thumb turns.

Profile cylinder - C keyway

Retail price

| Part N° | Description | Door thickness | 03 Polished brass | 26 Polished chrome | 15/26D Satin nickel / Polished chrome | 32D Satin stainless steel |
|----------------------|---|----------------|-------------------|--------------------|---------------------------------------|---------------------------|
| C 07 35 mm | Key by thumb turn | | \$ 43.00 | \$ 43.00 | \$ 43.00 | -- |
| C 08 72 mm | Key by thumb turn profile cylinder | 1.3/4" | \$ 432.00 | \$ 432.00 | \$ 432.00 | -- |
| C 09 81 mm | Key by thumb turn profile cylinder | 2.1/4" | \$ 432.00 | -- | \$ 432.00 | -- |
| C 12 45 mm | Half profile profile cylinder with thumb turn | | \$ 432.00 | \$ 432.00 | \$ 432.00 | -- |
| C 13 50 mm | Half profile profile cylinder with thumb turn | | \$ 432.00 | -- | \$ 432.00 | -- |
| C 14 45 mm | Half profile profile cylinder with keyway | | \$ 432.00 | -- | \$ 432.00 | -- |
| K 1799/6 | Thumb turn for profile cylinder (brass) | | \$ 43.00 | \$ 43.00 | \$ 43.00 | -- |
| S 5702 BZG MP | Thumb turn for profile cylinder (stainless steel) | | -- | -- | -- | \$ 85.00 |

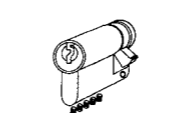
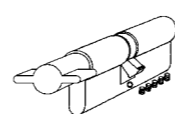
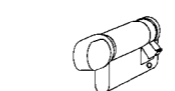

Must add price of thumb turn to profile cylinder.

Allen wrenches & set screw (metric)

| Part N° | Description | Retail price |
|---------------|---|--------------|
| X 0286 | Set screws with allen wrench for stainless steel levers and knobs | \$ 14.00 |
| W 04 | Allen wrench for deadbolt cylinder locking screw | \$ 3.00 |

Set screws with allen wrenches for brass levers and knobs: Set screws size ø=mm 6 wide x 9 long.



Dust box

Retail price

| Part N° | Description | 03 Polished brass | 26 Polished chrome | 15/26D Satin nickel / Polished chrome | Other |
|--------------|--------------------------|-------------------|--------------------|---------------------------------------|---------|
| DB-04 | Dust box T-stirke | -- | -- | -- | \$ 6.00 |
| DB-03 | Dust box full lip strike | -- | -- | -- | \$ 6.00 |
| DB-02 | Dust box mortise strike | \$ 6.00 | \$ 6.00 | \$ 12.00 | -- |

Mortise locks

Must specify 2.1/2" or 2.3/4" backset. Must specify for levers or knobs. Includes: mortise lock body, face plate, strike plate, screws and dust box (no cylinder). Custom mortise locks and other backsets available upon special request.  UL listed 3 hours fire rating.

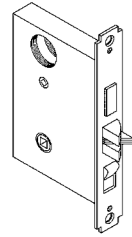

| Part N° | Description | Retail price |
|---------------|--------------------------------------|--------------|
| ML-F | Entrance (lever sets) | \$ 350.00 |
| ML-FD | Entrance | \$ 450.00 |
| ML-FW | Entrance | \$ 350.00 |
| ML-J | Classroom | \$ 450.00 |
| ML-AC | Entrance | \$ 350.00 |
| ML-N | Passage | \$ 350.00 |
| ML-B | Entrance | \$ 350.00 |
| ML-NC | Communicating | \$ 450.00 |
| ML-E | Office | \$ 450.00 |
| ML-LF | Privacy | \$ 350.00 |
| ML-ELEC | Electrified | \$ 2,150.00 |
| ML-EW | Storeroom | \$ 350.00 |
| ML-H | Hotel | \$ 350.00 |
| ML-DEADLOCK | Mortise deadlock | \$ 200.00 |
| ML-PL2000 PGE | Mortise lock for passage pocket door | \$ 400.00 |
| ML-2002 PCY | Mortise lock for privacy pocket door | \$ 450.00 |

See page 171 for details on functions.

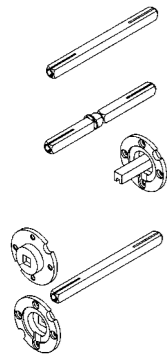

Spindles



| Part N° | Description | Overall length | Retail price |
|---------------------|---|----------------|--------------|
| X O16 | 8mm, solid spindle for doors 1.3/8" to 2.1/4" | 4.1/2" | \$ 11.00 |
| X O100/8 - 145 | 8mm, solid spindle for doors 2.3/8" to 3" | 5.5/8" | \$ 22.00 |
| X O163 / X 1119-114 | 8mm, split spindle for doors 1.3/8" to 2.1/4" | 4.1/2" | \$ 16.00 |
| X O163 / X 1119-145 | 8mm, split spindle for doors 2.3/8" to 3" | 5.3/4" | \$ 16.00 |
| X O571 | 8mm, surface mounted dummy (for round rosette) | | \$ 27.00 |
| X O571 OT SQ | 8mm, surface mounted dummy (for square rosette) | | \$ 30.00 |
| X O572 | 8mm, opposing mounted dummy plates | | \$ 29.00 |
| X 1118 | 5mm/tailpiece, for deadbolts with doors 1.3/8" to 1.3/4" | | \$ 8.00 |
| X 117/5-60 | 5mm x 60mm, for mortise lock functions with doors 1.3/4" | | \$ 4.00 |
| X 117/5-85 | 5mm x 85mm, for 105 privacy bolts with doors up to 1.3/4" | | \$ 4.00 |

Deadbolt, privacy bolt, mortise trim only

Retail price

| Part N° | 03/03D Polished brass / Satin brass | 14 Polished nickel | 15 Satin nickel | 26 Polished chrome | 26D Satin chrome | 32 Polished stainless steel | 32D Satin stainless steel | 26/26D Polished chrome / Satin chrome | Other |
|---|--|--------------------------|-----------------------|--------------------------|------------------------|--------------------------------------|------------------------------------|--|-----------|
|  K 1725 K 1724 RS BZG Interior trim for 105 RST (Traditional) | \$ 90.00 | \$ 108.00 | \$ 93.00 | -- | -- | -- | -- | \$ 118.00 | \$ 122.00 |
| K 1724 RS VBZG Exterior trim for 105 RST (Traditional) Emergency release | \$ 90.00 | \$ 108.00 | \$ 99.00 | -- | -- | -- | -- | \$ 118.00 | \$ 122.00 |
|  S 5700 K 1725 RS BZG Interior trim for 105 RSP (Round) | \$ 80.00 | \$ 103.00 | \$ 96.00 | \$ 80.00 | \$ 96.00 | -- | -- | -- | \$ 108.00 |
| K 1725 RS VBZG Exterior trim for 105 RSP (Round) Emergency release | \$ 80.00 | \$ 103.00 | \$ 96.00 | \$ 80.00 | \$ 96.00 | -- | -- | -- | \$ 80.00 |
| S 5700 RS BZG Interior trim for 105 RSS (Stainless Steel) | -- | -- | -- | -- | -- | \$ 207.00 | \$ 179.00 | -- | -- |
| S 5700 RS VBZG Exterior trim for 105 RSS (Stainless Steel) Emergency release | -- | -- | -- | -- | -- | \$ 161.00 | \$ 123.00 | -- | -- |

Deadbolt, privacy bolt, mortise trim only

Retail price

| Part N° | 03/03D Polished brass / Satin brass | 14 Polished nickel | 15 Satin nickel | 26 Polished chrome | 26D Satin chrome | 32 Polished stainless steel | 32D Satin stainless steel | 26/26D Polished chrome / Satin chrome | Other |
|---|--|--------------------------|-----------------------|--------------------------|------------------------|--------------------------------------|------------------------------------|--|-----------|
|  K 1781 K 1781 RS BZG Interior trim for 105 RSQ (Square) | -- | \$ 190.00 | \$ 174.00 | \$ 158.00 | \$ 174.00 | -- | -- | -- | \$ 174.00 |
| K 1781 RS VBZG Exterior trim for 105 RSQ (Square) Emergency release | -- | \$ 190.00 | \$ 174.00 | \$ 158.00 | \$ 174.00 | -- | -- | -- | \$ 174.00 |
|  S 5703 S 5703 RS BZG Interior trim for 105 RSQS (Square) Stainless Steel | -- | -- | -- | -- | -- | \$ 280.00 | \$ 215.00 | -- | -- |
| S 5703 RS VBZG Exterior trim for 105 RSQS (Square) Stainless Steel Emergency release | -- | -- | -- | -- | -- | \$ 200.00 | \$ 153.00 | -- | -- |
|  K 1729 K 1728 RS BZG Interior trim for traditional deadbolt (101 RT) | \$ 78.00 | \$ 89.00 | \$ 85.00 | -- | \$ 89.00 | -- | -- | -- | \$ 102.00 |
| K 1749 RSC Exterior trim for traditional deadbolt (101 RT) | \$ 43.00 | \$ 53.00 | \$ 45.00 | -- | -- | -- | -- | \$ 44.00 | \$ 53.00 |
| K 1729 RS BZG Interior trim for traditional deadbolt (101 RT) | \$ 106.00 | \$ 85.00 | \$ 85.00 | \$ 78.00 | \$ 85.00 | -- | -- | -- | \$ 106.00 |
| K 1748 RSC Exterior rosette for round deadbolt (101 RP) | \$ 47.00 | \$ 52.00 | \$ 52.00 | \$ 48.00 | \$ 52.00 | -- | -- | -- | \$ 54.00 |
| R 5701 RS BZG Interior trim for round stainless deadbolt (101 RPS) | -- | -- | -- | -- | -- | \$ 253.00 | \$ 193.00 | -- | -- |
| R 5705 RS Exterior trim for round stainless deadbolt (101 RPS) | -- | -- | -- | -- | -- | \$ 145.00 | \$ 111.00 | -- | -- |
| R 5708 RS BZG Interior trim for square stainless deadbolt (101 RQS) | -- | -- | -- | -- | -- | \$ 283.00 | \$ 218.00 | -- | -- |
| R 5709 RS Exterior trim for square stainless deadbolt (101 RQS) | -- | -- | -- | -- | -- | \$ 177.00 | \$ 136.00 | -- | -- |
| K 1778 RS BZG Interior trim for square brass deadbolt (101 RQ) | -- | \$ 208.00 | \$ 174.00 | \$ 158.00 | \$ 174.00 | -- | -- | -- | \$ 174.00 |
| K 1780 RS Exterior trim for square brass deadbolt (101 RQ) | -- | \$ 100.00 | \$ 107.00 | \$ 91.00 | \$ 107.00 | -- | -- | -- | \$ 107.00 |
| K 1726 Mortise lock cylinder collar (Traditional) | \$ 49.00 | \$ 49.00 | \$ 49.00 | \$ 40.00 | \$ 45.00 | -- | -- | -- | \$ 55.00 |
| K 1727 Mortise lock cylinder collar round (Brass) | \$ 58.00 | \$ 53.00 | \$ 53.00 | \$ 48.00 | \$ 48.00 | -- | -- | -- | \$ 58.00 |
| R 5700 Mortise lock cylinder collar round (Stainless Steel) | -- | -- | -- | -- | -- | \$ 107.00 | \$ 87.00 | -- | -- |
| K 1767 Mortise lock cylinder collar square (Brass) | -- | \$ 120.00 | \$ 109.00 | \$ 99.00 | \$ 99.00 | -- | -- | -- | \$ 109.00 |
| R 5710 Mortise lock cylinder collar square (Stainless Steel) | -- | -- | -- | -- | -- | \$ 147.00 | \$ 112.00 | -- | -- |
| X 1121 K / X O228 Cylinder collar for exterior rosette for deadbolt (Brass) | \$ 22.00 | \$ 22.00 | \$ 22.00 | \$ 22.00 | \$ 22.00 | -- | -- | -- | \$ 22.00 |
| X 1121 K / X O237 Cylinder collar for exterior rosette for deadbolt (Stainless) | -- | -- | -- | -- | -- | \$ 43.00 | \$ 43.00 | -- | -- |
| K 1806/1225 RS BZG Interior trim for K 1225 RSQ (Square) | -- | \$ 198.00 | \$ 174.00 | \$ 158.00 | \$ 174.00 | -- | -- | -- | \$ 174.00 |
| K 1806 RS VBZG Exterior trim for K 1225 RSQ (Square) Emergency release | -- | \$ 198.00 | \$ 174.00 | \$ 158.00 | \$ 174.00 | -- | -- | -- | \$ 174.00 |

Privacy pin

| Part N° | Description | Finish options | Retail price |
|---------|---|--------------------------------|--------------|
| X 0227 | Pin for tubular latch (M3 thread) | O3, O3D, O6A, O6B, 26, 26D, 16 | \$ 13.00 |
| X 0248 | Pin for tubular latch stainless steel (M3 thread) | 32, 32D | \$ 15.00 |

Fastners

| Part N° | Description | Retail price |
|---------|---|--------------|
| X 176 | Retaining ring to attach levers to rosettes and long escutcheons. Specify RH - LH | \$ 5.00 |
| X 187 | Metal washer | \$ 4.00 |
| X 184 | Retaining clip to attach thumb turns to rosettes and long escutcheons | \$ 4.00 |
| X 1161 | Locking o-ring to attach levers to rosettes and long escutcheon plates | \$ 4.00 |
| X 1162 | Stainless steel washer | \$ 4.00 |
| X 1167 | Stainless steel washer | \$ 4.00 |
| X 0326 | Nylon bushing to convert 8mm to 5mm | \$ 4.00 |
| X 0339 | Nylon bushing to convert 8mm to a flat tailpiece | \$ 4.00 |
| X 1100 | Spring for lever and rosette assembly | \$ 3.00 |
| X 1107 | Small nylon washer | \$ 3.00 |
| X 1105 | Medium nylon washer | \$ 3.00 |
| X 1106 | Large nylon washer | \$ 3.00 |

Metric screws for door sets

| Part N° | Description | Retail price |
|--------------------|---|--------------|
| X 15 | Standard pack for 1.3/8" or 1.3/4" doors (rosettes) | \$ 3.00 |
| X 17 | Standard pack for 1.3/8" or 1.3/4" doors (long escutcheons) | \$ 5.00 |
| M4 x 30mm (1.1/4") | | \$ 1.00 |
| M4 x 40mm (1.1/2") | | \$ 1.00 |
| M4 x 50mm (2") | | \$ 1.00 |
| M4 x 90mm (3.1/2") | | \$ 1.00 |

X0230 Longer screws for 2.1/4" thick doors \$8

DOOR PULL MOUNTING KITS

X 0508 - Single mount

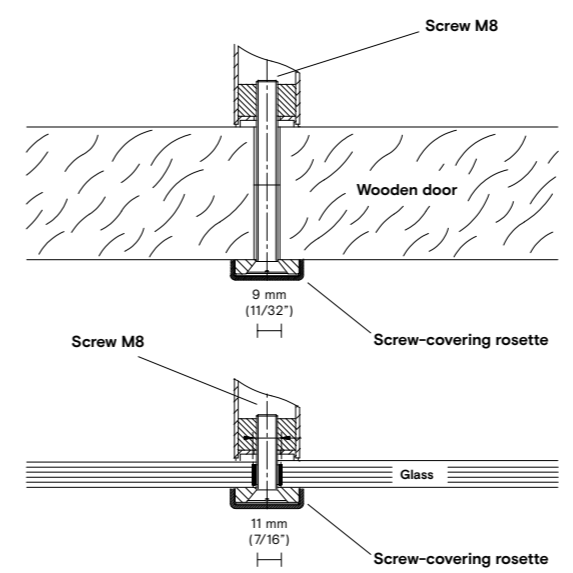

For mounting a single door pull on a wooden door, thickness:
45÷60 mm (1.25/32"÷2.3/8")
60÷75 mm (2.3/8"÷2.15/16")
75÷90 mm (2.15/16"÷3.17/32")

On a glass door, thickness:
8÷12 mm (5/16"÷15/32")

For pulls:
K 353 - P 5405 25
P 5406 25 - P 5408 25

Recommender hole diameter:
 Wooden door: **Ø 9 mm (11/32")**
 Glass door: **Ø 11 mm (7/16")**

X 0508 \$ 91.00

X 0509 - Back to back mount

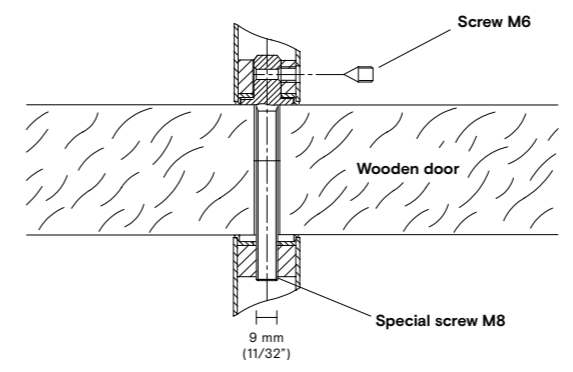

For mounting a pair of door pull on a wooden door, thickness:
45÷60 mm (1.25/32"÷2.3/8")
60÷75 mm (2.3/8"÷2.15/16")
75÷90 mm (2.15/16"÷3.17/32")

For pulls:
K 353 - P 5405 25
P 5406 25 - P 5408 25

Recommender hole diameter:
Ø 9 mm (11/32")

Part N° Retail price
 X 0509 \$ 68.00

X 0510 - Single mount

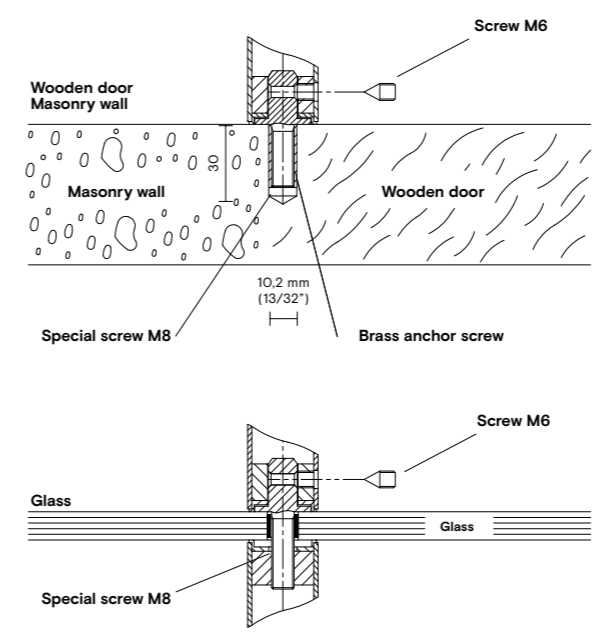

For mounting a single door pull on a wooden door on a masonry wall using a brass anchor screw.

For pulls:
K 353 S - P 5405 S 25 - P 5406 S 25 - P 5408 S 25

For mounting a pair of handle on a glass door, thickness:
8÷12 mm (5/16"÷15/32")

For pulls:
K 353 - P 5405 25 - P 5406 25 - P 5408 25

Recommender hole diameter:
 Wooden door: **Ø 10,2 mm (13/32")**
 Glass door: **Ø 11 mm (7/16")**

Part N° Retail price
 X 0510 \$ 68.00

X 0523 - Back to back mount

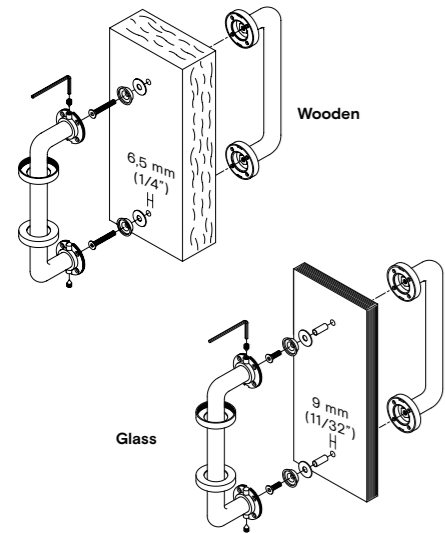

For fixing a pair of door pull with rosettes on a wooden door, thickness:
45+55 mm (1.25/32"+2.5/32")
55+65 mm (2.5/32"+2.9/16")

On a glass door, thickness:
8+12 mm (5/16"+15/32")

For pulls:
K 352 RH/LH - K 356
K 368 - K 377 - K 1188 - K 1210

Recommender hole diameter:
 Wooden door: **Ø 6,5 mm (1/4")**
 Glass door: **Ø 9 mm (11/32")**

| Part N° | Retail price |
|---------|--------------|
| X 0523 | \$ 68.00 |

X 0525 - Single mount

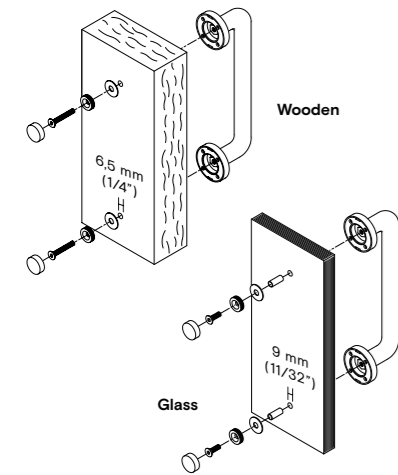

For fixing a pair of door pull with rosettes on a wooden door, thickness:
45+55 mm (1.25/32"+2.5/32")
55+65 mm (2.5/32"+2.9/16")

On a glass door, thickness:
8+12 mm (5/16"+15/32")

For pulls:
K 352 RH/LH - K 356 - K 368
K 377 - K 1188 - K 1210

Recommender hole diameter:
 Wooden door: **Ø 6,5 mm (1/4")**
 Glass door: **Ø 9 mm (11/32")**

| Part N° | Retail price |
|---------|--------------|
| X 0525 | \$ 91.00 |

X 0526 - Single mount

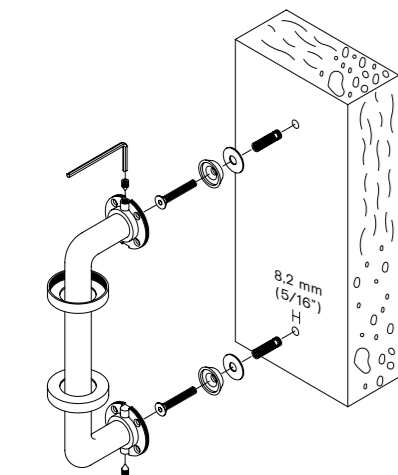

For mounting a single door pull with screw-covering rosettes on wooden door or on a masonry wall using a brass anchor screw.

For pulls:
K 352 RH/LH - K 356 - K 368
K 377 - K 1188 - K 1210

Recommender hole diameter:
Ø 8,2 mm (5/16")

| Part N° | Retail price |
|---------|--------------|
| X 0526 | \$ 57.00 |

X 0528 - Back to back mount

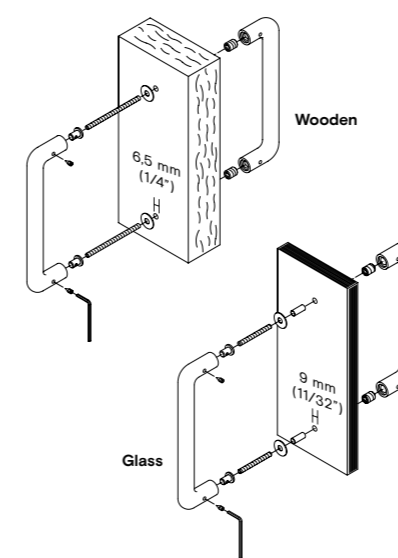

For mounting a pair of door pull without screw-covering rosettes on a wooden door, thickness:
45+55 mm (1.25/32"+2.5/32")
55+65 mm (2.5/32"+2.9/16")

On a glass door, thickness:
8+12 mm (5/16"+15/32")

For pulls:
K 358 - K 378 - K 379 - K 380 - K 381
K 383 - K 385 - K 386 - K 1226 - K 1228
K 1060 - K 1068 - K 1069

For pulls:
K352 RH/LH K 356 - K 368 - K 377
K 1054 - K 1056 - K 1061 - K 1188
K 1210 - K 1231 - K 1235
 (Before installation roses must be removed)

Recommender hole diameter:
 Wooden door: **Ø 6,5 mm (1/4")**
 Glass door: **Ø 9 mm (11/32")**

| Part N° | Retail price |
|---------|--------------|
| X 0528 | \$ 68.00 |

X 0530 - Single mount

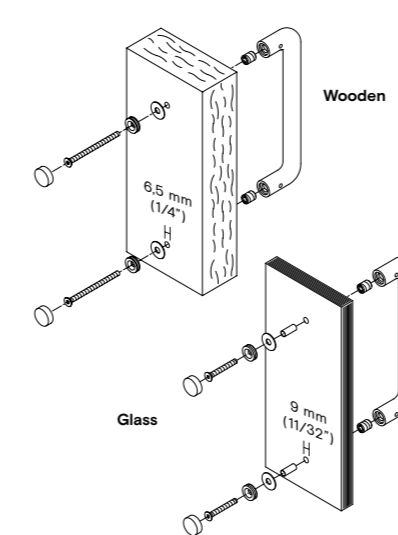

For mounting a single door pull without rosettes on a wooden door, thickness:
45+55 mm (1.25/32"+2.5/32")
55+65 mm (2.5/32"+2.9/16")

On a glass door, thickness:
8+12 mm (5/16"+15/32")

For pulls:
K 358 - K 378 - K 379 - K 380 - K 381
K 383 - K 385 - K386 - K 1226 - K 1228
K 1060 - K 1068 - K 1069

For pulls:
K 352 RH/LH - K 356 - K 368 - K 377 - K 1054
K 1056 - K 1188 - K 1210 - K 1231 - K 1235
 (Before installation roses must be removed)

Recommender hole diameter:
 Wooden door: **Ø 6,5 mm (1/4")**
 Glass door: **Ø 9 mm (11/32")**

| Part N° | Retail price |
|---------|--------------|
| X 0530 | \$ 91.00 |

X 0531 - Single mount

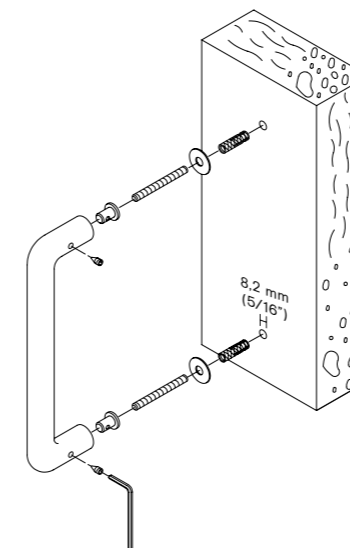

For mounting a single door pull without rosettes on a wooden door or on a masonry wall using a brass anchor screw.

For pulls:
K 358 - K 378 - K 379 - K 380 - K 381
K 383 - K 385 - K 386 - K 1226 - K 1228
K 1060 - K 1068 - K 1069

For pulls:
K 352 RH/LH - K 356 - K 368 - K 377
K 1054 - K 1056 - K 1188 - K 1210 - K 1061
K 1231 - K 1235
 (Before installation roses must be removed)

Recommended hole diameter:
Ø 8,2 mm (5/16")

| Part N° | Retail price |
|---------|--------------|
| X 0531 | \$ 57.00 |

X 0544 / 1

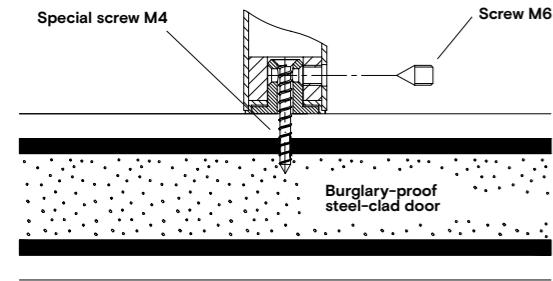

For mounting a single pull handle without rosettes on a burglary-proof steel-clad door.

For pulls:
K 353 S - P 5405 S 25
P 5406 S 25 - P 5408 S 25

| Part N° | Retail price |
|----------|--------------|
| X 0544/1 | \$ 57.00 |

X 0544

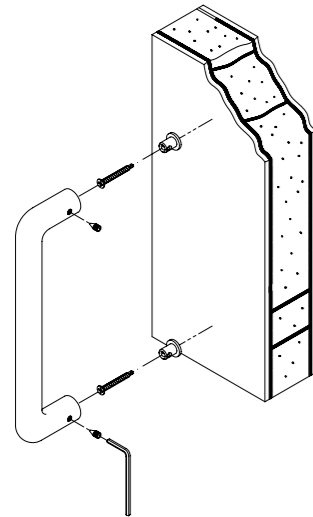

For mounting a single door pull without rosettes on a burglary-proof steel-clad door.

For pulls:
K 358 - K 378 - K 379 - K 380
K 381 - K 383 - K 385 - K 386
K 1226 - K 1228 - K 1060
K 1068 - K 1069

For pulls:
K 352 RH/LH - K 356 - K 368
K 377 - K 1054 - K 1056
K 1188 - K 1210 - K 1061
K 1231 - K 1235
 (Before installation roses must be removed)

| Part N° | Retail price |
|---------|--------------|
| X 0544 | \$ 91.00 |

X 0551

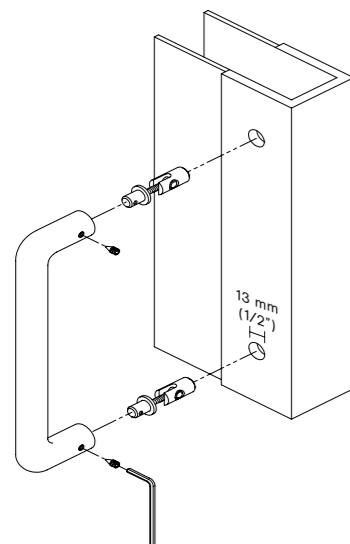

For mounting a single pull handle without screw-covering rosettes on an aluminum door.

For pulls:
K 358 - K 378 - K 379 - K 380
K 381 - K 383 - K 385 - K 386
K 1226 - K 1228 - K 1060
K 1068 - K 1069

For pulls:
K 352 RH/LH - K 356 - K 368
K 377 - K 1054 - K 1056 - K 1061
K 1188 - K 1210 - K 1231 - K 1235
 (Before installation roses must be removed)

Recommended hole diameter:
Ø 13 mm (1/2")

| Part N° | Retail price |
|---------|--------------|
| X 0551 | \$ 91.00 |

X 0552

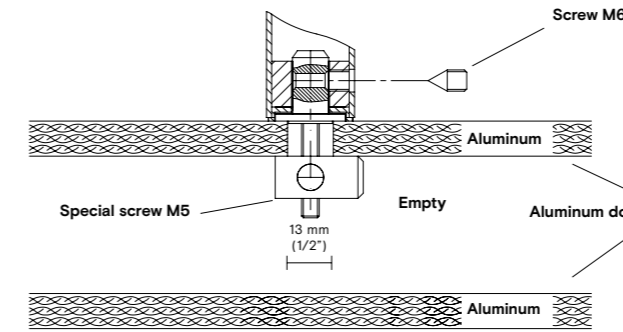

For fixing a single door pull without screw-covering rosettes on an aluminum door.

For pulls:
K 353 S - P 5405 S 25
P 5406 S 25 - P 5408 S 25

Recommended hole diameter:
Ø 13 mm (1/2")

| Part N° | Retail price |
|---------|--------------|
| X 0552 | \$ 91.00 |

DUMMY SET ADAPTORS Round rosettes - Brass

X 003/1 Double RP

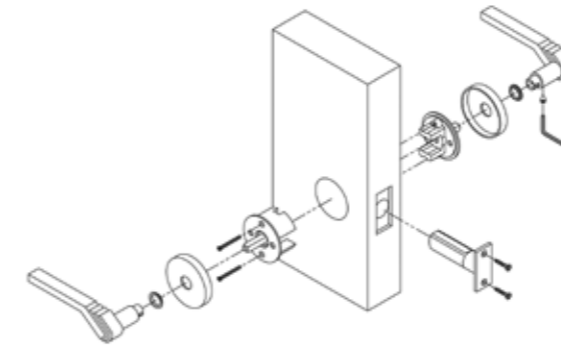

Set includes:
2 underrosettes,
1 latch bolt blank

BACKSET 2.3/4" and 2.3/8"

| Part N° | Retail price |
|---------|--------------|
| X 003/1 | \$ 85.00 |

X 003/2 Single RP

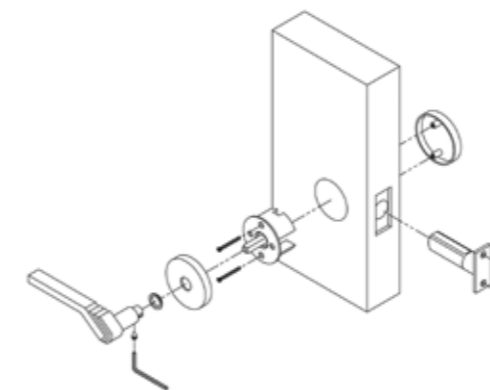

Set includes:
1 underrosette,
1 latch bolt blank,
1 blind brass rosette for opposite side.

BACKSET 2.3/4" and 2.3/8"

| Part N° | Retail price |
|---------|--------------|
| X 003/2 | \$ 103.00 |

DUMMY SET ADAPTORS Square rosettes - Brass

X 003/1 Double RQ

Part N° Retail price

X 003/1 \$ 85.00

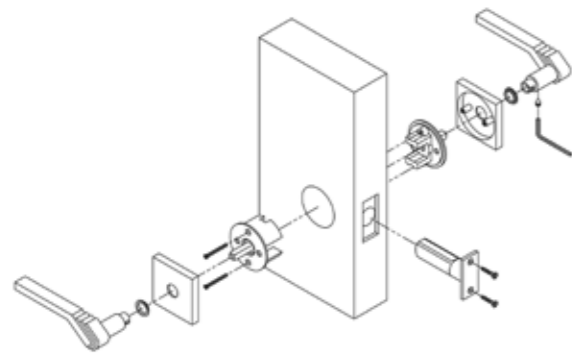

Set includes:
2 underosettes,
1 latch bolt blank
 BACKSET 2.3/4" and 2.3/8"

X 003/2 Single RQ

Part N° Retail price

X 003/2 \$ 103.00

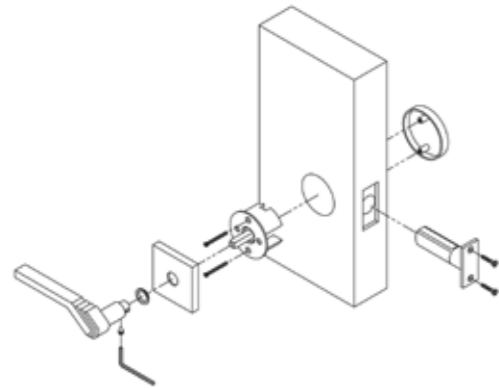

Set includes:
1 underosette,
1 latch bolt blank,
1 blind brass rosette
for opposite side.
 BACKSET 2.3/4" and 2.3/8"

DUMMY SET ADAPTORS Round rosettes - Stainless steel

X 003/1 Double RPS

Part N° Retail price

X 003/1 \$ 85.00

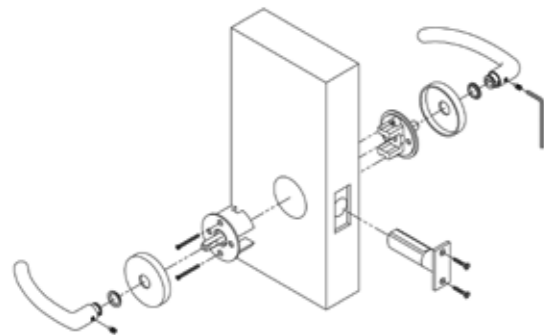

Set includes:
2 underosettes,
1 latch bolt blank
 BACKSET 2.3/4" and 2.3/8"

X 003/2 Single RPS

Part N° Retail price

X 003/2 \$ 103.00

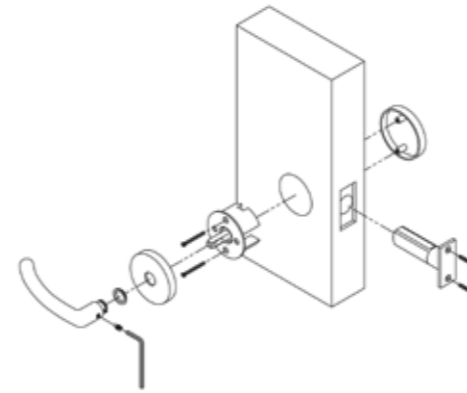

Set includes:
1 underosette,
1 latch bolt blank,
1 blind brass rosette
for opposite side.
 BACKSET 2.3/4" and 2.3/8"

DUMMY SET ADAPTORS Square rosettes - Stainless steel

X 003/1 Double RQS

Part N° Retail price

X 003/1 \$ 85.00

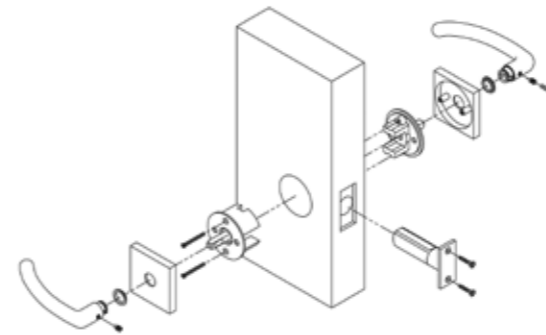

Set includes:
2 underosettes,
1 latch bolt blank
 BACKSET 2.3/4" and 2.3/8"

X 003/2 Single RQS

Part N° Retail price

X 003/2 \$ 103.00

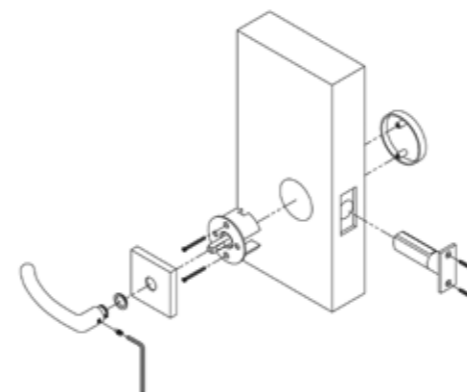

Set includes:
1 underosette,
1 latch bolt blank,
1 blind brass rosette
for opposite side.
 BACKSET 2.3/4" and 2.3/8"

List of door thickness

Each lever/knob design accommodates a different spindle length, based on the shape of the shank. See below the list of the standard spindle lengths for each model. Our set-up is for 1.3/4" thick door. Different door thicknesses must be specified at the time of the order. The below is for reference only.

| Article | Series | Thickness from / to | 1.3/4" with spindle | 1.3/8" with spindle |
|---------|-----------------------------------|-----------------------------|----------------------------|--------------------------|
| H 163 | Sarissa | 33 - 55 mm (1.1/4"x2.1/8") | 8 x 114 mm (1.1/4"x2.1/8") | |
| H 165 | Germana | 33 - 53 mm (1.1/4"x2.1/8") | 8 x 114 mm (1.1/4"x2.1/8") | |
| H 176 | Spiga | 33 - 55 mm (1.1/4"x2.1/8") | 8 x 114 mm (1.1/4"x2.1/8") | |
| H 192 | Prunus | 33 - 55 mm (1.1/4"x2.1/8") | 8 x 114 mm (1.1/4"x2.1/8") | |
| H 198 | Eero Aarnio | 33 - 55 mm (1.1/4"x2.1/8") | 8 x 114 mm (1.1/4"x2.1/8") | |
| H 311 | Mario Bellini | 30 - 60 mm (1.1/8"x2.3/8") | 8 x 114 mm (1.1/4"x2.1/8") | |
| H 315 | Pierluigi Cerri | 33 - 55 mm (1.1/4"x2.1/8") | 8 x 114 mm (1.1/4"x2.1/8") | |
| H 317 | Antonio Citterio | 33 - 55 mm (1.1/4"x2.1/8") | 8 x 114 mm (1.1/4"x2.1/8") | |
| H 327 | Antonio Citterio | 33 - 55 mm (1.1/4"x2.1/8") | 8 x 114 mm (1.1/4"x2.1/8") | |
| H 329 | Taller Design Ricardo Bofill | 33 - 55 mm (1.1/4"x2.1/8") | 8 x 114 mm (1.1/4"x2.1/8") | |
| H 330 | Matteo Thun | 33 - 55 mm (1.1/4"x2.1/8") | 8 x 114 mm (1.1/4"x2.1/8") | |
| H 334 | Foster + Partners | 33 - 55 mm (1.1/4"x2.1/8") | 8 x 114 mm (1.1/4"x2.1/8") | |
| H 335 | Richard Meier | 33 - 43 mm (1.1/4"x1.3/4") | 8 x 104 mm (3/8"x4.1/8") | 8 x 96 mm (3/8"x3.3/4") |
| H 338 | Yoshimi Kono | 33 - 55 mm (1.1/4"x2.1/8") | 8 x 114 mm (1.1/4"x2.1/8") | |
| H 343 | John Pawson | 39 - 50 mm (1.1/2"x2") | 8 x 104 mm (3/8"x4.1/8") | 8 x 96 mm (3/8"x3.3/4") |
| H 348 | David Chipperfield | 33 - 55 mm (1.1/4"x2.1/8") | 8 x 114 mm (1.1/4"x2.1/8") | |
| H 356 | Zaha Hadid | 33 - 55 mm (1.1/4"x2.1/8") | 8 x 104 mm (3/8"x4.1/8") | |
| H 359 | SOM - Skidmore, Owings & Merrill | 30 - 60 mm (1.1/8"x2.3/8") | 8 x 104 mm (3/8"x4.1/8") | |
| H 361 | Antonio Citterio with Toan Nguyen | 40 - 60 mm (1.5/8"x2.3/8") | 8 x 114 mm (1.1/4"x2.1/8") | 8 x 104 mm (3/8"x4.1/8") |
| H 364 | Mario Bellini | 40 - 60 mm (1.5/8"x2.3/8") | 8 x 114 mm (1.1/4"x2.1/8") | 8 x 104 mm (3/8"x4.1/8") |
| H 367 | Giancarlo Vegni | 40 - 60 mm (1.5/8"x2.3/8") | 8 x 114 mm (1.1/4"x2.1/8") | 8 x 104 mm (3/8"x4.1/8") |
| H 368 | Cerri & Associati | 40 - 60 mm (1.5/8"x2.3/8") | 8 x 114 mm (1.1/4"x2.1/8") | 8 x 104 mm (3/8"x4.1/8") |
| H 370 | Doriana e Massimiliano Fuksas | 33 - 55 mm (1.1/4"x2.1/8") | 8 x 114 mm (1.1/4"x2.1/8") | |
| H 372 | Eri Goshen | 38 - 48 mm (1.1/2"x1.7/8") | 8 x 104 mm (3/8"x4.1/8") | 8 x 96 mm (3/8"x3.3/4") |
| H 376 | Giancarlo Vegni | 40 - 60 mm (1.5/8"x2.3/8") | 8 x 114 mm (1.1/4"x2.1/8") | 8 x 104 mm (3/8"x4.1/8") |
| H 377 | Steve Leung | 40 - 60 mm (1.5/8"x2.3/8") | 8 x 114 mm (1.1/4"x2.1/8") | 8 x 104 mm (3/8"x4.1/8") |
| H 378 | Yabu Pushelberg | 32 - 63 mm (1.1/4"x 2.1/2") | 8 x 114 mm (1.1/4"x2.1/8") | 8 x 104 mm (3/8"x4.1/8") |
| H 379 | Antonio Citterio | 33 - 43 mm (1.1/4"x1.3/4") | 8 x 96 mm (3/8"x3.3/4") | |
| H 380 | Antonio Citterio | 33 - 43 mm (1.1/4"x1.3/4") | 8 x 96 mm (3/8"x3.3/4") | |
| H 381 | Khalid Al Najjar | 32 - 63 mm (1.1/4"x 2.1/2") | 8 x 114 mm (1.1/4"x2.1/8") | |
| H 382 | Joe Cheng | 32 - 63 mm (1.1/4"x 2.1/2") | 8 x 114 mm (1.1/4"x2.1/8") | |
| H 383 | Perkins&Will | 40 - 55 mm (1.5/8"x2.1/8") | 8 x 114 mm (1.1/4"x2.1/8") | |
| H 384 | CetraRuddy Architecture D.P.C. | 32 - 63 mm (1.1/4"x 2.1/2") | 8 x 114 mm (1.1/4"x2.1/8") | |
| H 385 | Federica Biasi | 32 - 63 mm (1.1/4"x 2.1/2") | 8 x 114 mm (1.1/4"x2.1/8") | |
| H 386 | Meneghello Paoelli | 32 - 63 mm (1.1/4"x 2.1/2") | 8 x 114 mm (1.1/4"x2.1/8") | |
| H 411 | Leila | 30 - 60 mm (1.1/8"x2.3/8") | 8 x 114 mm (1.1/4"x2.1/8") | |
| H 414 | Amber | 30 - 60 mm (1.1/8"x2.3/8") | 8 x 114 mm (1.1/4"x2.1/8") | |
| H 415 | Scarlet | 30 - 60 mm (1.1/8"x2.3/8") | 8 x 114 mm (1.1/4"x2.1/8") | |
| H 416 | Garnet | 30 - 60 mm (1.1/8"x2.3/8") | 8 x 114 mm (1.1/4"x2.1/8") | |
| H 419 | Bordeaux | 30 - 60 mm (1.1/8"x2.3/8") | 8 x 114 mm (1.1/4"x2.1/8") | |
| H 1003 | Matteo Thun | 33 - 55 mm (1.1/4"x2.1/8") | 8 x 114 mm (1.1/4"x2.1/8") | |
| H 1004 | Antares | 37 - 57 mm (1.1/2"x2.1/4") | 8 x 96 mm (3/8"x3.3/4") | |
| H 1016 | Nabucco | 37 - 57 mm (1.1/2"x2.1/4") | 8 x 104 mm (3/8"x4.1/8") | 8 x 96 mm (3/8"x3.3/4") |
| H 1022 | Ernani | 37 - 55 mm (1.1/2"x2.1/8") | 8 x 114 mm (1.1/4"x2.1/8") | 8 x 104 mm (3/8"x4.1/8") |
| H 1024 | Lolita | 30 - 55 mm (1.1/8"x2.1/8") | 8 x 114 mm (1.1/4"x2.1/8") | |
| H 1026 | Antonio Bullo | 38 - 48 mm (1.1/2"x1.7/8") | 8 x 96 mm (3/8"x3.3/4") | |
| H 1027 | Dafne | 33 - 55 mm (1.1/4"x2.1/8") | 8 x 114 mm (1.1/4"x2.1/8") | |
| H 1037 | Teseo | 38 - 50 mm (1.1/2"x2") | 8 x 104 mm (3/8"x4.1/8") | 8 x 96 mm |
| H 1039 | Jean-Baptiste Sibertin Blanc | 27 - 54 mm (1.1/8"x2.1/8") | 8 x 104 mm (3/8"x4.1/8") | |

| Article | Series | Thickness from / to | 1.3/4" with spindle | 1.3/8" with spindle |
|----------|----------------------------------|-----------------------------|----------------------------|--------------------------|
| H 1040 | Gabriele e Oscar Buratti | 32 - 50 mm (1.1/4"x2") | 8 x 104 mm (3/8"x4.1/8") | |
| H 1043 | Matteo Thun | 35 - 64 mm (1.1/4"x 2.1/2") | 8 x 114 mm (1.1/4"x2.1/8") | |
| H 1044 | Vincent Van Duysen | 40 - 55 mm (1.5/8"x2.1/8") | 8 x 104 mm (3/8"x4.1/8") | 8 x 96 mm (3/8"x3.3/4") |
| H 1044 U | Vincent Van Duysen | 40 - 55 mm (1.5/8"x2.1/8") | 8 x 104 mm (3/8"x4.1/8") | 8 x 96 mm (3/8"x3.3/4") |
| H 1045 | Yoshimi Kono | 36 - 62 mm (1.1/2"x 2.1/2") | 8 x 114 mm (1.1/4"x2.1/8") | 8 x 104 mm (3/8"x4.1/8") |
| H 1046 | Nais | 32 - 63 mm (1.1/4"x 2.1/2") | 8 x 114 mm (1.1/4"x2.1/8") | |
| H 1049 | Divara | 32 - 63 mm (1.1/4"x 2.1/2") | 8 x 114 mm (1.1/4"x2.1/8") | |
| H 1050 | Giasone | 32 - 63 mm (1.1/4"x 2.1/2") | 8 x 114 mm (1.1/4"x2.1/8") | |
| H 1052 | Mikhail Leykin | 32 - 63 mm (1.1/4"x 2.1/2") | 8 x 114 mm (1.1/4"x2.1/8") | |
| H 1054 | W.W. | 32 - 63 mm (1.1/4"x 2.1/2") | 8 x 114 mm (1.1/4"x2.1/8") | |
| H 1056 | Quadra | 32 - 63 mm (1.1/4"x 2.1/2") | 8 x 114 mm (1.1/4"x2.1/8") | |
| H 1057 | Retrò | 32 - 63 mm (1.1/4"x 2.1/2") | 8 x 114 mm (1.1/4"x2.1/8") | |
| H 1058 | Amica | 37 - 52 mm (1.1/2"x2.1/8") | 8 x 104 mm (3/8"x4.1/8") | 8 x 96 mm (3/8"x3.3/4") |
| H 1060 | SOM - Skidmore, Owings & Merrill | 37 - 52 mm (1.1/2"x2.1/8") | 8 x 104 mm (3/8"x4.1/8") | |
| H 1061 | Di Virgilio Veneziano | 32 - 63 mm (1.1/4"x 2.1/2") | 8 x 114 mm (1.1/4"x2.1/8") | |
| H 1062 | Carmen | 32 - 63 mm (1.1/4"x 2.1/2") | 8 x 114 mm (1.1/4"x2.1/8") | |
| H 1066 | Bertone Design | 37 - 52 mm (1.1/2"x2.1/8") | 8 x 104 mm (3/8"x4.1/8") | |
| H 1068 | Pembroke & Ives | 32 - 63 mm (1.1/4"x 2.1/2") | 8 x 114 mm (1.1/4"x2.1/8") | |
| H 1069 | Susannah | 37 - 52 mm (1.1/2"x2.1/8") | 8 x 114 mm (1.1/4"x2.1/8") | |
| H 1748 | Estrella | 33 - 63 mm (1.1/4"x 2.1/2") | 8 x 114 mm (1.1/4"x2.1/8") | |
| H 4730 | White | 30 - 60 mm (1.1/8"x2.3/8") | 8 x 114 mm (1.1/4"x2.1/8") | |
| H 4742 | Coral | 38 - 52 mm (1.1/2"x2.1/8") | 8 x 104 mm (3/8"x4.1/8") | 8 x 96 mm (3/8"x3.3/4") |
| H 5008 | Taller Design Ricardo Bofill | 34 - 50 mm (1.1/4"x2") | 8 x 114 mm (1.1/4"x2.1/8") | |
| H 5014 | Bernina | 30 - 60 mm (1.1/8"x2.3/8") | 8 x 114 mm (1.1/4"x2.1/8") | |
| H 5015 | Antonio Citterio | 30 - 60 mm (1.1/8"x2.3/8") | 8 x 114 mm (1.1/4"x2.1/8") | |
| H 5017 | Hans Kollhoff | 40 - 60 mm (1.5/8"x2.3/8") | 8 x 114 mm (1.1/4"x2.1/8") | |

Note: For the levers on slim rosette, the spindle is 10 mm shorter than what indicated in the list above.

| | | | | |
|--------|----------------------------------|-------------------------------|----------------------------|--|
| K 377 | Steve Leung | 40 - 60 mm (1.5/8"x2.3/8") | 8 x 114 mm (1.1/4"x2.1/8") | |
| K 378 | Yabu Pushelberg | 32 - 63 mm (1.1/4"x 2.1/2") | 8 x 114 mm (1.1/4"x2.1/8") | |
| K 383 | Perkins&Will | 40 - 60 mm (1.5/8"x2.3/8") | 8 x 114 mm (1.1/4"x2.1/8") | |
| K 1054 | W.W. | 42 - 54 mm (x1.3/4"x2.1/8") | 8 x 96 mm (3/8"x3.3/4") | |
| K 1056 | Quadra | 42 - 54 mm (x1.3/4"x2.1/8") | 8 x 96 mm (3/8"x3.3/4") | |
| K 1060 | SOM - Skidmore, Owings & Merrill | 33 - 45 mm (1.1/4"x1.3/4") | 8 x 114 mm (1.1/4"x2.1/8") | |
| K 1061 | Di Virgilio Veneziano | 20 - 55 mm (25/32" x 2.5/32") | 8 x 114 mm (1.1/4"x2.1/8") | |
| K 1155 | | 33 - 50 mm (1.1/4"x2") | 8 x 114 mm (1.1/4"x2.1/8") | |
| K 1168 | Giasone | 42 - 54 mm (x1.3/4"x2.1/8") | 8 x 114 mm (1.1/4"x2.1/8") | |
| K 1170 | | 42 - 54 mm (x1.3/4"x2.1/8") | 8 x 114 mm (1.1/4"x2.1/8") | |
| K 1171 | | 42 - 54 mm (x1.3/4"x2.1/8") | 8 x 114 mm (1.1/4"x2.1/8") | |
| K 1730 | | 33 - 50 mm (1.1/4"x2") | 8 x 114 mm (1.1/4"x2.1/8") | |
| K 5301 | Yabu Pushelberg | 34 - 50 mm (1.1/4"x2") | 8 x 114 mm (1.1/4"x2.1/8") | |



Certifications



**Environmental Management
according to UNI EN ISO 14001:2015**



**Quality Management according
to UNI EN ISO 9001:2015**



**European Norm EN 1906:2012
Product certification**



**Certificate of fire resistant
and smoke control EN 1634-1:2018**

General sales terms and conditions

These General Sales Terms and Conditions (“Terms and Conditions”) apply to all sales by Valli & Valli (U.S.A.) Inc. (“VALLI”) to the buyer (“Buyer”) of handles and related accessories distinguished by the trademark “VALLI.” (“Product/s”). All orders are accepted subject to these Terms and Conditions. Any terms and/or conditions contained in the Buyer’s purchase order or other writing pertaining to such order which are in conflict with or add to or subtract from the following Terms and Conditions shall not become part of any resulting contract unless expressly accepted in writing by VALLI.

1. GENERAL INFORMATION

(a) VALLI reserves the right to accept or reject any order for any reason. (b) No order is binding on VALLI until received in writing and approved by VALLI. VALLI agrees to sell and Buyer agrees to buy only in accordance with these Terms and Conditions which are applicable to and binding upon the sale and purchase of every Product sold by VALLI. No departure from these terms and conditions in any respect whatsoever shall be valid except when in writing and signed by an authorized officer of VALLI. Any additions, deletions or other changes to or in an order are subject to the Terms and Conditions stated herein. No salesman or agent of VALLI has the authority to make any changes in VALLI’s Terms and Conditions or sale prices.

(c) VALLI shall deliver the Products specified on an order within a reasonable time after acceptance of orders, and shall use reasonable efforts to make timely delivery subject to the ability of VALLI to ship, at the time and in the quantity specified, contingent upon strikes, floods, fires, accidents, labor or material troubles, product availability, or rules and regulations of the United States or any state, municipal or other lawful authority therein or where the Products are manufactured, or other causes beyond the control of VALLI, and VALLI shall not be liable for damages for failure to make partial or complete shipment or for any delay in making shipments. In no event shall the terms of this provision affect Buyer’s obligation to pay for goods sold and delivered.

(d) The Buyer may not cancel an order without VALLI’s consent. If VALLI is unable to make shipment of specified quantities of its standard Products within thirty (30) days of the specified time and so notifies the Buyer, the Buyer may give notice to VALLI by e-mail confirmed by letter sent registered mail of its intention to cancel that part of the order which remains unshipped at the time of VALLI’s receipt of such telefax or within fifteen (15) days after the post-marked date of such letter, whereupon such unshipped part of the order shall be cancelled.

(e) All specifications listed in our Catalog and/or Price List are subject to change without notice including packing, weights, measurements and Product designs.

2. PRICES

(a) Prices are quoted, Products are sold, and all shipments are made F.O.B. VALLI’s warehouse, unless otherwise specified. All prices are stated in U.S. currency.

(b) Each order, or any part thereof, is subject to billing and payment at VALLI’s prices in effect at the time of shipment.

(c) VALLI reserves the right to change any of the prices of an order up to the date of shipment, upon notice to the Buyer. Any orders upon which prices have been changed which are not confirmed by Buyer within fifteen (15) days of notice being sent shall be cancelled.

(d) All prices are subject to additional federal, city and state taxes, if applicable.

(e) Prices, terms and conditions of sale, and trade discounts, if any, are subject to change without prior notice at any time prior to VALLI’s acceptance of the Buyer’s order.

3. TERMS OF PAYMENT

(a) Payment terms are offered to accounts only after a review and approval of VALLI’s credit application. Incomplete applications, insufficient references or lack of credit worthiness may result in rejection of application, Prepaid or COD terms only.

Payment is not timely unless actually received by VALLI on or before the due date.

(b) A service and carrying charge of one and one half (1-1/2%) percent per month (annual percentage rate eighteen (18%) percent) will be charged on all invoices outstanding more than thirty-five (35) days. Buyer shall pay all costs and expenses (including reasonable attorney’s fees) incurred by VALLI in connection with any payments not made when due. VALLI reserves the right to stop confirmed shipments to accounts

which have invoices over sixty (60) days past due.

(c) If Buyer fails to pay an invoice at maturity or defaults on or repudiates this or any other agreement with VALLI, or becomes insolvent or calls a meeting of its creditors or if a bankruptcy, insolvency, re-organization or arrangement proceeding is commenced by or against Buyer, VALLI may (i) cancel this and/or any other contracts with Buyer, and Buyer shall remain liable for any damages to VALLI; or (ii) (a) declare all outstanding invoices under this and/or any other contracts immediately due and payable; (b) defer any shipments hereunder; (c) sell all or part of the undelivered goods at private or public sale, at which VALLI may become buyer; (d) bill at contract price all or any part of the undelivered goods to Buyer, with delivery to Buyer only after full payment is made; and (e) take possession of delivered but unpaid for goods wherever found without process of law.

(d) If, at any time, reasonable grounds for insecurity arise with respect to Buyer’s performance of its payment obligations to VALLI. VALLI may demand payment in full for the Products or such financial security which in VALLI’s sole discretion shall be equivalent to the sales price of the Products.

4. RUSH DELIVERY CHARGES

\$ 30.00 NET AND DROP SHIP CHARGES \$ 5.00

Applies to all orders requested to be shipped within 48 hrs.

5. SHIPPING AND FREIGHT ALLOWANCE

VALLI will ship the Products in any manner most satisfactory to VALLI, based upon convenience, experience and cost. Full freight allowed and prepaid to all points in the continental United States on any shipment equal to or in excess of One Thousand (\$1,000.00) Dollars net invoice value by the carrier of VALLI’s selection.

No freight allowance on shipments of less than One Thousand (\$1,000.00) Dollars net invoice value. A One (\$1.50) Dollar fifty cent service charge per shipment shall be applied for freight handling and insurance coverage.

6. RETURNS

A written request must be received by VALLI within 90 days from the date of the receipt of the order and approved by an authorized officer of VALLI in writing prior to the return of any Products.

Returns must be made within 90 days of RGA approval. Any approved returns shall be delivered at Buyers expense freight prepaid to any point designated by VALLI and a minimum of thirty-five (35%) percent handling charge will apply. A handling fee will be charged on all returned goods. All returned goods must be returned in the original factory sealed cartons and must be in saleable condition.

Merchandise may be returned for credit toward future orders only. Credit must be applied within one (1) year of the date of issuance.

7. CLAIMS

Risks of theft, loss or damage to, or destruction of, the Products shall pass to the Buyer when the Products are placed in the possession of the first carrier at VALLI’s place of shipment. Claims for damage, loss in transit and delay in delivery must be made to the carrier by the Buyer. All other claims must be reported promptly within fifteen (15) days of receipt of merchandise. Replacement deliveries shall be made or returns accepted only if VALLI’s investigation supports the claim. VALLI’s liability with respect to substantiated claims shall be limited to either replacing or accepting the return of the Products with refund of the original purchase price.

8. LIMITED WARRANTY

Valli warrants to the buyer, that the products shall be free from defects in material or workmanship for a period of one (1) year following the date of the buyer’s purchase from valli. This limited warranty is transferable during, and subject to, the above warranty period, only to third parties purchasing the products directly from the buyer. Under penalty of forfeiture, the buyer shall give written notice to valli that some or all of the products do not comply with this limited warranty within 15 business days of delivery (in case of apparent defects), or of latent defects having become apparent (within the warranty period). Valli’s sole obligation under this warranty shall be to repair or replace the products which valli determines to be defective and which, after timely notice, are returned to valli with proper documentation during the warranty period, shipping charges prepaid to valli USA, 100 Commerce Way, Suite 2, Hackensack, NJ 07601.

Valli does not assume any warranty responsibility for damages due to conditions over which valli has no control, including but not limited to improper installation, impact, tampering or abuse. Finishes cannot be guaranteed from tarnishing, excessive wear, or deterioration due to exposure to atmospheric conditions over which valli has no control.

Valli makes no other warranties, express or implied, with respect to the products delivered, including without limitation, any warranty of merchantability or fitness for a particular purpose. In no event shall valli be liable for any special, indirect, incidental or consequential damages including, but not limited to, loss of profits or damages to business or business relations. To the extent permitted by law the remedies set forth above are exclusive and in lieu of all other warranties express or implied, statutory or otherwise, and limited to the duration of the warranty period of this express warranty.

Some states do not allow limitation on how long an implied warranty lasts or the exclusion or limitation of incidental or consequential damages so these limitations or exclusions may not apply to the buyer.

This limited warranty gives you the buyer specific legal rights, and buyers qualifying as consumers buying consumer goods for personal use may have also other rights which may vary from state to state.

9. LIMITATION OF LIABILITY

Nothing in these terms and conditions shall limit or exclude a party’s liability for any matter in respect of which it would be unlawful to exclude or restrict liability.

To the extent permitted by law, valli shall not be liable toward the buyer, or any other party, whether based in contract, warranty, tort (including negligence), strict liability, indemnity or any other legal or equitable theory, for: any special, indirect, incidental, consequential or punitive damages including, but not limited to, loss of profits, revenue, reputation, opportunity, loss of, or damages to, business or goodwill. Some jurisdictions do not allow the exclusion or limitation of incidental or consequential damages, so these limitations may not apply to buyer. In no event shall valli’s total aggregate liability exceed the actual price paid by buyer for the products under the relevant order or, in case several orders, under the relevant orders of the previous 12 months, provided that in no event shall such valli’s total aggregate liability exceed the amount of \$ 250,000 (two-hundred-fifty-thousand).

10. GOVERNING LAWS AND ARBITRATION

Any controversy or claim arising out of or relating to the purchase or sale of VALLI Products shall be construed in accordance with the laws of the State of New York and shall be settled by arbitration in the City, Country and State of New York in accordance with the current Commercial Arbitration Rules of the American Arbitration Association and judgment upon the award rendered may be entered in any court of competent jurisdiction.

11. CODE OF CONDUCT

The Buyer, its directors, officers, employees, shall perform their obligations under these Terms and Conditions in full compliance with the ASSA ABLOY Code of Conduct which is accessible online at: <https://www.assaabloy.com/group/en/sustainability/code-of-conduct>

12. SIZES AND DIMENSIONS

Conversion from metric to U.S. measurements is approximate. Refer to Product for exact metric sizing.

13. PROJECTS

All project orders require a down payment. Freight FOB New Jersey Warehouse.

14. DISCONTINUED

We may discontinue the VALLI Products or alter specifications at any time without prior notification or obligation. Product will continue to be available as long as inventory remains, after which the Product will be discontinued. This program is intended to help our customers anticipate future needs and to avoid bidding or taking orders on parts which may not be available in sufficient quantities when needed.

15. INDUSTRY STANDARD

The prevailing industry standard is that the special order items, electrical products and specialty keyed products may not be returned.

16. CARE & MAINTENANCE

Door handles and their accessories are designed to open and close doors. They represent a complimentary element of the door, together with the frame, hinges, door panel, lock and cylinder.

Opening and closing a door with a handle requires certain actions, such as opening a security bolt.

Only in certain cases, such as on emergency doors, the handles serves the function of working the lock by lowering or pushing it.

Window handles too are to be considered only a complimentary part of the window. It is normally the opening system of the window that determines the hardware required and consequently the mechanism required for the working of the window handle.

Door handles, pull handles and window handles are often incorrectly used, damaging the Product and the quality standard defined by the producer.

Common errors include:

The use of the handle as a support or hook for objects which may be excessively heavy.

The use of the handle as a plaything by children.

The use of the handle as a doorstop against the wall.

VALLI Products do not require excessive maintenance

For care and cleaning, except in those cases where a specific Product is recommended for certain finishes, VALLI recommends the use of just a soft dry cloth.

VALLI discourages the use of sanitizing wipes, or sprays, which may affect the surface of the lever with possible peeling of the external coating, and consequent oxidation.

VALLI also suggests to protect the levers from any liquid or spray product used for mirror/window cleaning. It may result in the damage of the lever surface, especially on polished finishes.

To ensure a correct installation, the instructions contained in the box should be followed.

If necessary consult the retailer or specialized personnel, or the specific “HOW TO” section in the VALLI website.

In the case of Products in glass or porcelain together with brass, it should be remembered that these fragile materials are liable to break if used incorrectly.

VALLI recommends the use of doorstops fixed to the floor or the wall close to the door or its handle.

On all Products with a set screw VALLI recommends the use of a retaining compound. It is also advisable to check the position and tightness of all fixing elements at regular intervals.

The user/purchaser of the Product should ask the retailer for instructions regarding the correct installation, care and maintenance of the Product. VALLI Products are subject to a continual process of development and updating, and Production is constantly monitored by VALLI Quality Assurance.

Most VALLI Products are “tools” for opening and closing doors and windows. Inevitably, as with all artifacts, depending on the material of which they are made and where they are made and where they are used, they are subject to wear and then passing of time.

Brass, an alloy subject to oxidation, has to be covered with a protective coating if its appearance is to remain unchanged over time.

Care should be taken during use and maintenance, as improper use or poor maintenance could damage the protective coating, permitting corrosion and consequently causing an anti-aesthetic appearance.

Stainless steel is generally considered to be indestructible.

However, even this material can show the occasional scratch or spot of rust.

Such rust-spots are so-called “surface ruse”, and can be removed using an appropriate cleaner, available from specialized retailers.

The manufacturer cannot be held responsible for damage due to normal wear and tear, incorrect treatment, installation or maintenance or non-observance of the above warnings.

This terms and conditions - version 1/2023 - are published on the website <https://www.vallihandles.com/us/en/documents/general-sales-conditions/valli-us-sales.pdf> in a format which can be saved and printed.

**Valli US
Headquarters and Showroom**

22 West 21st Street, 6th floor
New York, NY 10010
Tel (212) 326 8811
Toll Free (877) 326 2565
sales.us@vallihandles.com

**Valli US
Warehouse**

100 Commerce Way, Suite 2
Hackensack, NJ 07601
Tel (973) 249 0085

**Valli Factory
and Italian offices**

via Concordia, 16
20838 Renate (MB)
Italy

vallihandles.com/us/en

This catalogue is constantly updated. We reserve the right to make any changes to the products featured herein or to discontinue them without prior notice. Images, data, measurements, and technical drawings are for information only and are not to be considered binding. Please consult the vallihandles.com/us/en website for the latest updates on the Valli product range and available finishes. Valli will not be held responsible for any misprints and/or errors in the catalogue.

Z2023 LIST V. US23 MANIG

