

KOHLER®

2022 Faucets

New Products Suggested List Price Supplement



Tone®
Tall Single-Handle Bathroom Sink Faucet K-26437-4-BMB

BATHROOM	12 – 26
RIFF®	12 – 17
TONE™	18 – 23
VENZA®	24 – 26
SHOWERING	27 – 38
ANTHEM™	27 – 28
STATEMENT®	29 – 34
RITE-TEMP®	35
MOXIE®	36
AWAKEN®	36
PURIST®	36
DRAINS	37 – 38
KITCHEN FAUCETS	39 – 41
JOLT™	39, 40
H2WISE™	41
FINISH ADDS	42 – 63
COMPONENTS®	42
ARTIFACTS®	42
AVID®	43 – 46
PARALLEL®	47 – 50
HONESTY®	51 – 53
TAUT®	54
HINT®	55, 56
PITCH®	56
ELATE®	57
STEAM	58
SHOWERING COMPONENTS	59
DRAINS	60
SIMPLICE®	61, 62
MISCELLANEOUS	63
LIGHTING COLLECTIONS	64 – 87
TRESDOUX®	64
VORLEIGH®	65
MODERN FARM	66
TERRET®	67
DAMASK®	68
SIMPALO®	69
COMPONENTS™	70
KRAGA®	71
OCCASION™	72
ARENDELA®	73
MARGAUX®	74
RIFF™	75
MEMOIRS®	76

TABLE OF CONTENTS

LIGHTING COLLECTIONS (CONTINUED)

ARTIFACTS™ 77, 78
 PAROHN® 79
 HAUKSBEE® 80, 81
 BANCROFT® 82
 BELLERA™ 83
 PURIST® 84
 TONE™ 85
 DEVONSHIRE® 86
 FORTÉ® 87

COMMERCIAL 88 – 93

COMPOSED® 88
 TAUT® 88
 TRITON® BOWE® 88
 TOUCHLESS FLUSHOMETERS 89 – 92
 MANUAL FLUSHOMETERS 93

COMMERCIAL CO-ORDINATED SOLUTIONS 94

HIGHCLIFF™ 94
 KINGSTON™ 94
 MODFLEX® 94
 WELLCOMME™ 94
 BARDON™ 94
 DEXTER™ 94
 TEND™ 94

KITCHEN & BATHROOM CLEANERS 95

TOILET CLEANER & DISINFECTANT 95
 TOILET BOWL CLEANER & DISINFECTANT 95
 WHIRLPOOL DISINFECTANT 95



All faucets displaying this symbol or stating “ADA” compliant” will comply with the applicable ADA requirements as stated in the Americans with Disabilities Act of 1990, as follows: Faucets with lever, wristblade, blade, cross/tri-/six prong or T-handles, and Touchless products, comply with the actuation force limitations of the 2010 ADA Standards for Accessible Design, Section 309 Operable Parts, of the Act, except as otherwise noted. ADA Act is not applicable in Canada.



Touchless faucets and lever, cross, wristblade, rocker, 6-prong or T-handles will comply with OBC Barrier Free Code when installed per the appropriate Clause(s).



Touchless faucets and lever, cross, wristblade, rocker, 6-prong or T-handles will comply with CSA B651 when installed per the appropriate Clause(s).

- All KOHLER sink faucets meet all State and Federal material regulations for drinking water faucets and fittings.

GALLONS LISTED IN THIS PRODUCT CATALOGUE ARE IN U.S. GALLONS.



- All products displaying this symbol comply with WaterSense requirements.
- WaterSense-labeled KOHLER faucets, showering components and flush valves offer significant water savings over standard products without sacrificing performance.
- For the most current information on KOHLER WaterSense-labeled faucets, visit us.KOHLER.com



This price book is not an offer to sell to any person who possesses it, nor to anyone else, the goods listed herein at the prices shown.
 These prices supercede previous list price books and quotations and are subject to change without notice. All prices are in **U.S.** dollars.
 These prices do not include freight or shipping.
 These prices do not include freight or shipping.

TERMS AND CONDITIONS OF SALE

Buyer’s acceptance of all or any part of goods ordered from Kohler Co. or its affiliates (“Seller”) shall constitute Buyer’s acceptance of Seller’s terms and conditions of sale set forth on the sales order confirmation or invoice unless Buyer objects in writing prior to acceptance of said goods.

Seller’s terms and conditions of sale set forth on the sales order confirmation or invoice will constitute the entire agreement between Seller and Buyer with respect to the subject matter of the sale and will supersede all prior agreements, negotiations, understandings, representations and warranties, whether written, oral or otherwise, and may not be modified except in writing signed by the parties. The terms and conditions of any document used by Buyer to communicate its order of goods and any terms or conditions that could be implied on the basis of course of performance, course of dealings, usage of trade or otherwise are expressly excluded.

All proposals, negotiations, and purchase orders, if any, will be merged into a sales order confirmation or invoice.

PRICES AND TITLE

All prices in the list price book shall be superseded by Seller’s prices in effect at the time of order entry unless Seller has given a firm quotation in writing and Buyer has given an order and the goods are released for shipment within the time periods specified in the quotation. Prices are FCA (origin) (Incoterms 2010), unless otherwise noted. With respect to shipments for destinations outside of the United States, title to the goods remains with Seller until such goods are discharged from the carrier to the Buyer in the destination country. Freight allowance, if any, is subject to Seller’s then current freight terms. All prices listed are in **U.S.** dollars.

RESIDENTIAL DELIVERY FEES

Additional shipping charges will apply on all Less than Truck Load (LTL) shipments delivered to residential addresses. The amount of the charges depend upon the third-party carrier used and the size of the shipment.

CREDIT APPROVAL

Acceptance of orders, shipments, deliveries, and performance of work shall at all times be subject to the approval of Seller’s Credit Department, Kohler, Wisconsin. Seller may at any time decline an order or decline to make any shipment or delivery or perform any work. Seller reserves the right to ship C.O.D. or C.I.A.

TERMS OF PAYMENT

The cash payment terms, if any, will be set forth on the face of the sales order confirmation or invoice. Cash discount, if any, will be shown and may be deducted from invoice total if payment is made by discount date. Discount date may be extended by four days if Buyer pays by means of Electronic Fund Transfers (“EFT”) with addenda records in accordance with Seller’s then effective EFT agreement. A delinquency charge equal to the greater of 18% per annum or the prime rate plus 1% as stated by Citibank USA (but in no event in excess of the maximum amount permitted by law), computed on the unpaid balance shall be due on all accounts not paid in full when due. Interest shall be paid with Buyer’s next remittance. In addition to late payment charges, Buyer agrees to pay any and all collection costs, including reasonable attorney fees, incurred by Seller in collecting balances not paid within the applicable payment terms.

EXPORT ADMINISTRATION

Buyer agrees to comply with all relevant export laws and regulations of the United States and any other applicable local law (“Export Laws”) to assure that no portion of the goods nor any services are exported, directly or indirectly, in violation of Export Laws, or used for purposes prohibited by the Export Laws. Seller reserves the right to cancel any quote or order, at any time, even after payment, in its sole discretion, for any perceived, potential or actual failure to comply with such Export Laws.

ANTI-CORRUPTION COMPLIANCE

Buyer agrees to comply with, and to take all reasonable measures to ensure that its subcontractors, agents or other third parties, subject to its control or determining influence, comply with all applicable laws, statutes, directives and/or regulations relating to anti-bribery and anti-corruption, including but not limited to the US Foreign Corrupt Practices Act and other applicable laws.

TAXES

Any taxes which Seller may be required to pay or collect, under any existing or future law, upon or with respect to the sale, delivery, storage, processing, use or consumption of any of the material conveyed, including taxes upon or measured by the receipts from the sale thereof, shall be for the account of Buyer, who shall promptly pay the amount thereof to Seller upon demand. Where taxes do not apply upon sale or resale, Buyer shall provide Seller with appropriate exemption certificates prior to the sale.

DESIGN CHANGES

Seller reserves the right to make revisions without notice in the design of its products or in their packaging.

DELAY

If any shipping dates have been specified, they are approximate and Seller shall not be bound thereby, but every effort will be made to ship in accordance with them. All shipments are subject to contingencies of manufacturing and other causes beyond Seller’s control such as fires, strikes, delays in transportation, or governmental regulations.

NOTICE

CANCELLATION

Orders for modified, special order, or custom product, as well as those not listed in current list price books, may not be cancelled or returned.

Orders for all other product in current list price books may be cancelled prior to shipment.

BUYER'S REMEDIES

If the goods furnished to the Buyer shall fail to conform to the contract or to any warranty, Seller shall replace such non-conforming goods at the original destination and shall furnish instructions for their disposition, provided Seller is notified of such non-conformity or defect within 60 days of shipment.

The Buyer's exclusive and sole remedy on account, or in respect, of any breach of the contract, or of any warranty, shall be to secure replacement thereof as aforesaid. Seller shall not be liable whether in contract or in tort or under any other legal theory for loss of revenue, use or profit or for the cost of any labor expended on any such goods or for any special, incidental or consequential damages to anyone by reason of any breach of this contract or of any warranty.

WARRANTY

All KOHLER Plumbing Products carry Kohler's One-Year Limited Warranty unless otherwise noted.

See below and following warranty pages for details.

Kohler Co.'s ("Seller") applicable respective warranty for the product in effect at the time of shipment shall apply. **THE LIMITED WARRANTY SUPPLIED WITH THE PRODUCT IS IN LIEU OF ALL OTHER WARRANTIES, EXPRESSOR IMPLIED, INCLUDING BUT NOT LIMITED TO THE IMPLIED WARRANTY OF MERCHANTABILITY AND FITNESS FOR A PARTICULAR PURPOSE. SELLER AND/OR DISTRIBUTOR DISCLAIM ANY LIABILITY FOR SPECIAL, INCIDENTAL OR CONSEQUENTIAL DAMAGES.** Buyer covenants and agrees that it will not remove any warranty, label, warning, tag, instruction, or manual from the product(s) and will ensure that all warranties, labels, warnings, tags, instructions, and manuals supplied with the product(s) or by Seller will be passed on to the original consumer purchaser. The limited warranty supplied with the product(s) is Seller's sole and exclusive warranty.

DAMAGE IN TRANSIT/SHORTAGE

Every reasonable precaution is taken against breakage or other damage in transit. As all goods are shipped FCA (origin) (Incoterm 2010), unless otherwise noted. Seller's risk of loss ceases at the time the goods are placed at Buyer's disposal. Claims against carriers are to be filed by the Buyer. It is Buyer's responsibility to inspect products upon delivery for transit damage and/or shortage. If damage or shortage is detected, it should be duly noted on the bill of lading before signing for merchandise. An inspection report should be requested by the Buyer of the carrier, followed by a settlement claim to the carrier.

CHOICE OF LAW

Except as expressly provided herein, the contract is subject to all the provisions of the Uniform Commercial Code of the state of Seller's principal place of business without variation, exclusion or limitation as effective and in force on the contract date. The United Nations Convention on Contracts for the International Sales of Goods ("CISG") shall not apply. Seller hereby elects to opt out of the CISG.

INVOICE MINIMUM

An order for items included in this list price book for which invoice prices aggregate less than \$50.00 net for product will be billed at \$50.00 net.

RETURNED MERCHANDISE

Merchandise which has been shipped according to Buyer's specifications cannot be returned for credit without prior written approval by Seller, fully establishing the basis for the credit. Credit will be issued only for items which are found by Seller to be of standard manufacture and in salable condition. Return shipment is at Buyer's expense and risk. Buyer must prepay freight and will incur up to a 25% restocking charge when no manufacturing defects or errors are involved.

Returned merchandise that has been discontinued will not be credited.

Returned merchandise that is not in A-1 condition will be scrapped immediately at Seller's facility.

Phase-down products will not be accepted under the return goods program.

Kohler Co. reserves the right to deny any product return request that puts Kohler Co. in an unfavorable inventory position.

SHIPPING WEIGHTS

Shipping weights are approximate and are not guaranteed, but are shown for customer convenience.

ELECTRONIC DATA INTERCHANGE ("EDI")

The terms and conditions at sale for EDI transactions shall be the same as set forth herein. Each party shall, at its own expense, provide and maintain the equipment, software, services, and testing necessary to effectively and reliably transmit and receive documents. No document shall give rise to any obligation until it is accessible and able to be read by the receiving party at its computer.

KOHLER® FAUCETS 2022 NEW PRODUCT LIST PRICE SUPPLEMENT

NUMERICAL PRICE INDEX

K-10570 to K-24434

MODEL NO.	COLOR/ FINISH	LIST PRICE	PAGE	MODEL NO.	COLOR/ FINISH	LIST PRICE	PAGE	MODEL NO.	COLOR/ FINISH	LIST PRICE	PAGE
K-10570	BLL	\$ 89.00	86	K-20999	CP	\$ 114.10	29	K-23340-PE01	BGL, BZL, CPL, SNL	\$ 349.00	68
	2GL, BML, BNL, BZL, CPL	99.00			BL, BN	165.45					
				K-21026	CP	741.65	34	K-23341-PE03	BGL, BZL, CPL, SNL	899.00	68
K-10571	BLL	119.00	86		BL, BN	1,075.40					
	2GL, BML, BNL, BZL, CPL	139.00		K-21048	CP	410.80	34	K-23463-SCLED	2GL, BLL, CPL, SNL	269.00	70
					BL, BN	595.70					
K-10572	BLL	179.00	86	K-21049-V0	CP	91.30	33	K-23464-SCLED	2GL, BLL, CPL, SNL	299.00	70
	2GL, BML, BNL, BZL, CPL	199.00			BL, BN	132.40					
				K-21050-V0	CP	106.70	33	K-23467-SCLED	2GL, BLL, CPL, SNL	389.00	70
K-106	2MB	1,326.55	60		BL, BN	154.75		K-23472-4	2MB	652.10	47
K-10TD00K10	CP	666.25	91, 94	K-21051	CP	228.20	33	K-23472-4K	2MB	652.10	47
K-10TD00N10-RF	CP	600.30	91		BL, BN	330.90		K-23472-4N	2MB	652.10	47
K-10TD00N10	CP	666.25	91, 94	K-21897	2MB	214.10	50	K-23475-4	2MB	937.45	47
K-10TH00K10	CP	832.45	91, 94	K-22033	2MB	803.55	61	K-23475-4K	2MB	937.45	47
K-10TD00R10	CP	666.25	91, 94	K-22034	2MB	446.40	62	K-23475-4N	2MB	937.45	47
K-10TD00R10-RF	CP	600.30	91	K-22035	2MB	312.55	62	K-23481	2MB	52.50	47
K-10TH00N10-RF	CP	754.25	89	K-22036	2MB	908.75	61	K-23484-4	2MB	864.10	47
K-10TH00N10	CP	832.45	89	K-22519-CHLED	BLL	2,999.00	69	K-23484-4K	2MB	864.10	47
K-10TH00R10	CP	832.75	89		SNL	3,499.00		K-23484-4N	2MB	864.10	47
K-10TH00R10-RF	CP	754.25	89	K-22520-PELED	BGL, BLL, CPL, SNL	899.00	69	K-23488-4	2MB	1,385.70	48
K-10UD00D20	CP	666.25	91					K-23510	2MB	326.05	50
K-10UD00K20	CP	672.95	91	K-22521-SFLED	BLL, CPL, SNL	1,249.00	69	K-23524	2MB	230.55	50
K-10UD00G20	CP	666.25	91					K-23525	2MB	246.95	50
K-10UH00D20	CP	832.75	89	K-22545-SC01	BGL, BZL, CPL, SNL	289.00	68	K-23526	2MB	164.75	50
K-10UH00D20-RF	CP	754.25	89					K-23527	2MB	189.45	50
K-10UH00G20	CP	832.75	89	K-22546-SC01	BGL, BZL, CPL, SNL	379.00	68	K-23528	2MB	197.60	50
K-10UH00G20-RF	CP	754.25	89					K-23529	2MB	98.85	50
K-10UH00K20	CP	841.10	89	K-22653-PE01	BLL, BNL, BVL, BZL, CPL, SNL, 2GL	199.00	77	K-23530	2MB	535.15	50
K-10UH00K30	CP	841.10	89		AFL, TTL	249.00		K-23668-SC01	WHL	149.00	66
K-10UH00K30-RF	CP	754.25	89	K-22654-PE01	BGL, BZL, CPL, SNL	299.00	78		BGL, CPL, VNL	399.00	
K-11365	BLL, BNL, CPL	89.00	87					K-23669-SC01	WHL	249.00	66
K-11366	BLL, BNL, CPL	119.00	87	K-22655-PE03	BGL, BZL, CPL, SNL	729.00	78		BGL, CPL, VNL	499.00	
K-11367	BLL, BNL, CPL	179.00	87					K-23670-FM01	WHL	299.00	66
K-11421	BNL, BZL, CPL, SNL	159.00	82	K-22656-CH03	BGL, BZL, CPL, SNL	1,799.00	78		BGL, CPL, VNL	499.00	
K-11422	BNL, BZL, CPL, SNL	269.00	82					K-23686-SC01	BGL, BNL, BZL, CPL, SNL	189.00	76
K-11423	BNL, BZL, CPL, SNL	349.00	82	K-22657-CH03	BGL, BZL, CPL, SNL	899.00	78				
								K-23687-BA02	BGL, BNL, BZL, CPL, SNL	339.00	76
K-123C36-SANA	BL	1,032.50	88	K-22659-CH03	BGL, BZL, CPL, SNL	999.00	78				
K-1388740	CP	68.70	93					K-23688-BA03	BGL, BNL, BZL, CPL, SNL	449.00	76
K-1388741	CP	68.70	93	K-23218	CP	206.55	36				
K-1388743	CP	66.50	93		2BZ, BL, BN	299.50		K-23689-BA04	BGL, BNL, BZL, CPL, SNL	599.00	76
K-1388744	CP	68.00	93	K-23218-G	CP	206.55	36				
K-1388745	CP	76.30	93		2BZ, BL, BN	299.50					
K-14531	2MB	119.00	63					K-23724	NA	10.50	95
K-16268	AFL, BNL, BVL, CPL, SNL	189.00	74	K-23219	CP	369.70	36	K-23734	NA	11.50	95
					2MB, BL, BN, BV, SN	536.10		K-23735	NA	14.50	95
					TT	591.55		K-23857	2MB	222.40	60
K-20004	BL, BN	223.25	52	K-23219-G	CP	369.70	36	K-24433	CP	12.00	16
	2MB	239.80			2MB, BL, BN, BV, SN	536.10			BL, BN, SN	16.20	
K-20005	2MB, BL, BN	69.20	52						2MB	17.40	
K-20998	CP	125.55	30		G-TT	591.55		K-24434	CP	13.00	16
	BL, BN	182.05		K-23255-4	2MB	761.50	51		BL, BN, SN	17.55	
				K-23339-PE01	BZL, CPL, SNL	299.00	68		2MB	18.85	

THE BOLD LOOK
OF **KOHLER**®

KOHLER® FAUCETS 2022 NEW PRODUCT LIST PRICE SUPPLEMENT

NUMERICAL PRICE INDEX

K-24435 to K-26348-9

MODEL NO.	COLOR/ FINISH	LIST PRICE	PAGE	MODEL NO.	COLOR/ FINISH	LIST PRICE	PAGE	MODEL NO.	COLOR/ FINISH	LIST PRICE	PAGE
K-24435	CP	\$ 15.00	16	K-26290	CP	\$ 180.00	29	K-26309	CP	\$ 90.00	33
	BL, BN, SN	20.25			2MB, BL, BN	261.00			2MB, BL, BN	130.50	
	2MB	21.75									
K-24436	CP	17.00	16	K-26290-G	CP	180.00	29	K-26310	CP	140.00	33
	BL, BN, SN	22.95			2MB, BL, BN	261.00			2MB, BL, BN	203.00	
	2MB	24.65									
K-24437	CP	12.00	22	K-26291	CP	550.00	31	K-26311	CP	20.00	33
	BL, BN	16.20			2MB, BL, BN	797.50			2MB, BL, BN	29.00	
	2MB, BMB, CBL	17.40		K-26291-G	CP	550.00	31	K-26312	CP	200.00	34
K-24438	CP	13.00	22		2MB, BL, BN	797.50			2MB, BL, BN	290.00	
	BL, BN	17.55		K-26292	CP	725.00	31	K-26313	CP	240.00	34
	2MB, BMB, CBL	18.85			2MB, BL, BN	1,051.25			2MB, BL, BN	348.00	
K-24439	CP	15.00	22	K-26293	CP	550.00	31	K-26314	CP	240.00	34
	BL, BN	20.25			2MB, BL, BN	797.50			2MB, BL, BN	348.00	
	2MB, BMB, CBL	21.75		K-26293-G	CP	550.00	31	K-26317	CP	60.00	34
K-24440	CP	17.00	22		2MB, BL, BN	797.50			2MB, BL, BN	87.00	
	BL, BN	22.95		K-26294	CP	725.00	31	K-26318	CP	150.00	32
	2MB, BMB, CBL	24.65			2MB, BL, BN	1,051.25			2MB, BL, BN	217.50	
K-24804-4	2MB	652.10	47	K-26295	CP	900.00	31	K-26319	CP	70.00	32
K-24804-4K	2MB	652.10	47		2MB, BL, BN	1,305.00			2MB, BL, BN	101.50	
K-24804-4N	2MB	652.10	47	K-26295-G	CP	900.00	31	K-26320	CP	115.00	32
K-24805	2MB	153.00	50		2MB, BL, BN	1,305.00			2MB, BL, BN	166.75	
K-24805-G	2MB	153.00	50	K-26297	CP	1,100.00	31	K-26321	CP	120.00	32
K-24857-4	2MB	761.50	51		2MB, BL, BN	1,595.00			2MB, BL, BN	174.00	
K-26148	2MB	290.45	52	K-26299	CP	200.00	31	K-26322	CP	130.00	32
K-26148-G	2MB	290.45	52		2MB, BL, BN	290.00			2MB, BL, BN	188.50	
K-26149	2MB	352.10	52	K-26299-G	CP	200.00	31	K-26325	CP	200.00	32
K-26149-G	2MB	352.10	52		2MB, BL, BN	290.00			2MB, BL, BN	290.00	
K-26282	CP	170.00	30	K-26300	CP	350.00	31	K-26326	CP	225.00	32
	2MB, BL, BN	246.50			2MB, BL, BN	507.50			2MB, BL, BN	326.25	
K-26282-G	CP	170.00	30	K-26300-G	CP	350.00	31	K-26339	NA	490.00	27
	2MB, BL, BN	246.50			2MB, BL, BN	507.50		K-26340	NA	540.00	27
K-26284	CP	170.00	30	K-26301	CP	650.00	31	K-26341	NA	600.00	27
	2MB, BL, BN	246.50			2MB, BL, BN	942.50		K-26342	NA	750.00	27
K-26284-G	CP	170.00	30	K-26305	CP	800.00	32	K-26345-9	CP	305.00	28
	2MB, BL, BN	246.50			2MB, BL, BN	1,160.00			2MB, BL, BN	442.25	
K-26286	CP	110.00	30	K-26306	CP	100.00	34	K-26346-9	CP	345.00	28
	2MB, BL, BN	159.50			2MB, BL, BN	145.00			2MB, BL, BN	500.25	
K-26286-G	CP	110.00	30	K-26307	CP	140.00	32	K-26347-9	CP	375.00	28
	2MB, BL, BN	159.50			2MB, BL, BN	203.00			2MB, BL, BN	543.75	
K-26288	CP	110.00	30					K-26348-9	CP	450.00	28
	2MB, BL, BN	159.50							2MB, BL, BN	652.50	
K-26288-G	CP	110.00	30								
	2MB, BL, BN	159.50									

KOHLER® FAUCETS 2022 NEW PRODUCT LIST PRICE SUPPLEMENT

NUMERICAL PRICE INDEX

K-26430-4 to K-27741-SC01

MODEL NO.	COLOR/ FINISH	LIST PRICE	PAGE	MODEL NO.	COLOR/ FINISH	LIST PRICE	PAGE	MODEL NO.	COLOR/ FINISH	LIST PRICE	PAGE
K-26430-4	CP	\$ 418.00	12	K-27287	2MB	\$ 66.35	57	K-27415-4N	CP	\$ 291.00	18
	BL, BN, SN	564.30		K-27288	2MB	56.55	57		BL, BN	392.85	
	2MB	606.10		K-27289	2MB	101.30	57		2MB, BMB, CBL	421.95	
K-26430-4K	CP	418.00	12	K-27290	2MB	35.20	57	K-27416-4	CP	465.00	19
	BL, BN, SN	564.30		K-27291	2MB	50.70	57		BL, BN	627.75	
	2MB	606.10		K-27292	2MB	52.65	57		2MB, BMB, CBL	674.25	
K-26430-4N	CP	418.00	12	K-27293	2MB	58.55	57	K-27416-4K	CP	465.00	19
	BL, BN, SN	564.30		K-27294	2MB	243.40	57		BL, BN	627.75	
	2MB	606.10		K-27399-4	CP	465.00	12		2MB, BMB, CBL	674.25	
K-26431-4	CP	430.00	13		BL, BN, SN	627.75			CP	465.00	19
	BL, BN, SN	580.50			2MB	674.25			BL, BN	627.75	
	2MB	623.50		K-27399-4K	CP	465.00	12	K-27416-4N	CP	465.00	19
K-26437-4	CP	418.00	18		BL, BN, SN	627.75			BL, BN	627.75	
	BL, BN	564.30			2MB	674.25			2MB, BMB, CBL	674.25	
	2MB, BMB, CNL	606.10		K-27399-4N	CP	465.00	12	K-27422	CP	80.00	21
K-26437-4K	CP	418.00	18		BL, BN, SN	627.75			BL, BN	108.00	
	BL, BN	564.30		K-27400-4	CP	291.00	12		2MB, BMB, CBL	116.00	
	2MB, BMB, CBL	606.10			BL, BN, SN	392.85		K-27423	CP	77.00	21
K-26437-4N	CP	418.00	18		2MB	421.95			BL, BN	103.95	
	BL, BN	564.30		K-27400-4K	CP	291.00	12		2MB, BMB, CBL	111.65	
	2MB, BMB, CBL	606.10			BL, BN, SN	392.85		K-27425	CP	65.00	22
K-26438-4	CBL	623.50	19	K-27400-4N	CP	291.00	12		BL, BN	87.75	
K-26441-4	CP	670.00	19		BL, BN, SN	392.85			2MB, BMB, CBL	94.25	
	BL, BN	904.50			2MB	421.95		K-27426	CP	68.00	22
	2MB, BMB	971.50		K-27406	CP	80.00	15		BL, BN	91.80	
K-26633	2MB	166.85	53		BL, BN, SN	108.00			2MB, BMB, CBL	98.60	
K-26634	2MB	171.80	53		2MB	116.00		K-27427	CP	31.00	22
K-26636	2MB	94.85	53	K-27407	CP	77.00	15		BL, BN	41.85	
K-26637	2MB	122.70	53		BL, BN, SN	103.95			2MB, BMB, CBL	44.95	
K-26638	2MB	127.55	53		2MB	111.65		K-27428	CP	46.00	22
K-26639	2MB	35.05	53	K-27409	CP	65.00	16		BL, BN	62.10	
K-26640	2MB	36.05	53		BL, BN, SN	87.75			2MB, BMB, CBL	66.70	
K-26641	2MB	39.30	53		2MB	94.25		K-27429	CP	56.00	22
K-26642	2MB	19.65	53	K-27410	CP	68.00	16		BL, BN	75.60	
K-26643	2MB	264.95	53		BL, BN, SN	91.80			2MB, BMB, CBL	81.20	
K-27121-4	2MB	1,304.15	48		2MB	98.60		K-27436-FM03	2PL, GNL, SNL	1,299.00	64
K-27262-SC01	BLL, BNL, BVL, CPL, SNL, 2GL AFL, TTL	139.00	84	K-27411	CP	31.00	16	K-27437-SF03	2PL, GNL, SNL	999.00	64
		169.00			BL, BN, SN	41.85		K-27438-SC01	2PL, GNL, SNL	499.00	64
		249.00			2MB	44.95		K-27439-PE03	2PL, GNL, SNL	1,299.00	64
K-27263-SC02	BLL, BNL, BVL, CPL, SNL, 2GL AFL, TTL	199.00	84	K-27412	CP	46.00	16	K-27441-CH06	2PL, GNL, SNL	1,999.00	64
		249.00			BL, BN, SN	62.10		K-27442-CH08	2PL, GNL, SNL	2,499.00	64
		269.00			2MB	66.70		K-27741-SC01	2GL, BVL, CPL, SNL	359.00	67
K-27264-SC02	BLL, BNL, BVL, CPL, SNL, 2GL AFL, TTL	269.00	84	K-27413	CP	56.00	16				
		339.00			BL, BN, SN	75.60					
		369.00			2MB	81.20					
K-27265-PE02	BLL, BNL, BVL, CPL, SNL, 2GL AFL, TTL	369.00	84	K-27415-4	CP	291.00	18				
		469.00			BL, BN	392.85					
		649.00			2MB, BMB, CBL	421.95					
K-27266-PE04	BLL	649.00	84	K-27415-4K	CP	291.00	18				
K-27267-CHLED	2GL, BLL	1,099.00	84		BL, BN	392.85					
K-27286	2MB	60.50	57		2MB, BMB, CBL	421.95					

THE BOLD LOOK
OF **KOHLER**®

KOHLER® FAUCETS 2022 NEW PRODUCT LIST PRICE SUPPLEMENT

NUMERICAL PRICE INDEX

K-27742-SC02 to K-31777-SC02

MODEL NO.	COLOR/ FINISH	LIST PRICE	PAGE	MODEL NO.	COLOR/ FINISH	LIST PRICE	PAGE	MODEL NO.	COLOR/ FINISH	LIST PRICE	PAGE
K-27742-SC02	2GL, BVL, CPL, SNL	\$ 599.00	67	K-28126-4	CP	\$ 218.00	24	K-30615	CP	\$ 180.00	39
K-27743-SC03	2GL, BVL, CPL, SNL	799.00	67	K-28126-4K	BL, BN	294.30	24	K-30616	CP	180.00	39
K-27744-SC04	2GL, BVL, CPL, SNL	999.00	67	K-28126-4N	CP	218.00	24	K-30617	CP	115.00	40
K-27748-CH05	2GL, BVL, SNL	2,699.00	67	K-28209	BL, BN	294.30	24	K-30618	CP	85.00	40
K-27749-CH06	2GL, BVL, SNL	2,299.00	67	K-28210	CP	218.00	24	K-30619	CP	85.00	40
K-27750-FM03	2GL, BVL, CPL, SNL	999.00	67	K-28211	BL, BN	294.30	24	K-31755-SC01	2GL, BLL, BNL, CPL, SNL	189.00	17, 75
K-27751-SC01	2GL, BVL, CPL, SNL	449.00	67	K-28212	NA	1,680.00	28	K-31756-SC02	2GL, BLL, BNL, CPL, SNL	349.00	17, 75
K-27752-SC02	2GL, BVL, CPL, SNL	599.00	67	K-28213	NA	2,204.00	28	K-31757-SC03	2GL, BLL, BNL, CPL, SNL	449.00	17, 75
K-27753-SC04	2GL, BVL, CPL, SNL	699.00	67	K-28213	NA	2,587.50	28	K-31758-CH04	2GL, SNL	799.00	17, 75
K-27858-SC01	2GL, 2PL, CPL, GNL, SNL	189.00	79	K-28241-GKA	CP	134.40	28	K-31759-CH08	2GL, SNL	1,499.00	17, 75
K-27859-FM02	2GL, 2PL, CPL, GNL, SNL	349.00	79	K-28241-GKE	2MB, BL, BN	194.90	28	K-31760-FM02	2GL, SNL	429.00	17, 75
K-27860-SC02	2GL, 2PL, CPL, GNL, SNL	329.00	79	K-28241-NKA	CP	249.00	36	K-31761-SC01	2GL, BLL, BNL, BZL, CPL	149.00	83
K-27861-PE01	2GL, 2PL, GNL, SNL	389.00	79	K-28241-NKE	BL, BN	361.05	36	K-31762-SC02	2GL, BLL, BNL, BZL, CPL	249.00	83
K-27862-CH04	2GL, 2PL, GNL, SNL	899.00	79	K-28304-K	CP	229.00	36	K-31763-SC03	2GL, BLL, BNL, BZL, CPL	349.00	83
K-27863-CH08	2GL, 2PL, GNL, SNL	1,729.00	79	K-28304-KSL	BL, BN	332.05	36	K-31764-FM02	2GL, SNL	399.00	83
K-27944-SC01	2GL, 2PL, CPL, GNL, SNL	399.00	65	K-28304-KS	CP	249.00	36	K-31766-CH10	2GL, SNL	1,199.00	83
K-27945-SC02	2GL, 2PL, CPL, GNL, SNL	719.00	65	K-28305	BL, BN	361.05	36	K-31767-CH13	2GL, SNL	1,499.00	83
K-27946-SC03	2GL, 2PL, CPL, GNL, SNL	969.00	65	K-28544-SC02	CP	249.00	36	K-31768-SC01	2GL, BLL, BML, BNL, CBL, CPL	129.00	23, 85
K-27949-CH08	2GL, 2PL, GNL, SNL	1,999.00	65	K-28545-SC02	BL, BN	361.05	36	K-31769-SC02	2GL, BLL, BML, BNL, CBL, CPL	239.00	23, 85
K-27950-CH04	2GL, 2PL, GNL, SNL	1,299.00	65	K-28987	CP	229.00	36	K-31770-SC03	2GL, BLL, BML, BNL, CBL, CPL	349.00	23, 85
K-27951-CH08	2GL, 2PL, GNL, SNL	2,999.00	65	K-29373-FM03B	NA	131.90	37	K-31771-PE01	BLL, BML, SNL	199.00	23, 85
K-28124-4	CP	190.00	24	K-29374-SF03B	2GL, BNL, CPL, SNL	379.00	73	K-31772-FM01	BLL, BML, SNL	249.00	23, 85
K-28124-4K	BL, BN	256.50	24	K-29374-SF03B	2GL, BNL, CPL, SNL	349.00	73	K-31773-CH04	BLL, BML, SNL	599.00	23, 85
K-28124-4N	CP	190.00	24	K-29375-SC01B	2GL, BNL, CPL, SNL	199.00	73	K-31774-CH08	BLL, BML, SNL	1,199.00	23, 85
K-28125-4	CP	357.00	25	K-29375-SC01B	2GL, BNL, CPL, SNL	199.00	73	K-31775-SC01	2GL, BLL, BML, BNL, CPL, SNL	199.00	72
K-28125-4K	BL, BN	481.95	25	K-29376-SC02B	2GL, BNL, CPL, SNL	299.00	73	K-31776-SC02	2GL, BLL, BML, BNL, CPL, SNL	399.00	72
K-28125-4N	CP	357.00	25	K-29376-SC02B	2GL, BNL, CPL, SNL	299.00	73	K-31777-SC02	2GL, BLL, BML, BNL, CPL, SNL	299.00	72
	BL, BN	481.95	25	K-29377-SC03B	2GL, BNL, CPL, SNL	399.00	73				
	BL, BN	481.95	25	K-29377-SC03B	2GL, BNL, CPL, SNL	399.00	73				
	CP	357.00	25	K-29378-SC04B	2GL, BNL, CPL, SNL	519.00	73				
	BL, BN	481.95	25	K-29380-CH10B	2GL, SNL	2,199.00	73				
	BL, BN	481.95	25	K-29381-CH06B	2GL, SNL	1,099.00	73				
	CP	357.00	25	K-29382-CH08B	2GL, SNL	1,399.00	73				
	BL, BN	481.95	25	K-29477	CP	222.00	15				
	BL, BN	481.95	25	K-29477	2MB, BL, BN, SN	321.90	15				
	CP	357.00	25	K-29478	CP	222.00	21				
	BL, BN	481.95	25	K-29478	2MB, BL, BMB, BN, CBL	321.90	21				
	CP	357.00	25	K-30612	CP	225.00	39				
	BL, BN	481.95	25	K-30612	VS	281.25	39				
	CP	357.00	25	K-30613	CP	145.00	39				
	BL, BN	481.95	25	K-30613	VS	181.25	39				
	CP	357.00	25	K-30614	CP	180.00	39				
	BL, BN	481.95	25	K-30614	VS	225.00	39				

KOHLER® FAUCETS 2022 NEW PRODUCT LIST PRICE SUPPLEMENT

NUMERICAL PRICE INDEX

K-31778-SC03 to K-97021

MODEL NO.	COLOR/ FINISH	LIST PRICE	PAGE	MODEL NO.	COLOR/ FINISH	LIST PRICE	PAGE	MODEL NO.	COLOR/ FINISH	LIST PRICE	PAGE
K-31778-SC03	2GL, BLL, BML, BNL, CPL, SNL	\$ 499.00	72	K-40TH00N10-RF	CP	\$ 737.75	90	K-80650	SH	\$ 299.90	37
				K-40TH00R10	CP	852.55	90		BL, BNK	404.90	
				K-40TH00R10-RF	CP	730.45	90		2MB	434.90	
K-31780-FM03	2GL, BLL, SNL	599.00	72	K-40TH00V10	CP	852.55	90	K-80651	SH	492.70	37
				K-40UD00D20	CP	673.95	92		BL, BNK	665.15	
K-31781-PE03	2GL, BLL, SNL	499.00	72	K-40UD00G20	CP	673.95	92		2MB	714.45	
				K-40UD00K20	CP	673.95	92	K-80652	SH	685.45	37
K-32281-SC01	2GL, BLL, BNL, CPL, SNL	159.00	80	K-40UH00D20	CP	852.55	90		BL, BNK	925.40	
				K-40UH00D20-RF	CP	737.75	90		2MB	993.95	
K-32282-SC02	2GL, BLL, BNL, CPL, SNL	319.00	80	K-40UH00G20	CP	852.55	90	K-80653	SH	589.05	37
				K-40UH00G20-RF	CP	730.45	90		BL, BNK	795.25	
K-32283-SC03	2GL, BLL, BNL, CPL, SNL	359.00	80	K-40UH00K20	CP	852.55	90		2MB	854.15	
				K-40UH00K20-RF	CP	723.50	90	K-80654	SH	781.85	37
K-32285-SC01	BML, CPL, WCL, WGL	299.00	80	K-46028-4	BN	241.90	88		BL, BNK	1,055.50	
				K-5548-K1	2MB, BL	1,315.45	58		2MB	1,133.70	
K-32286-SC02	BML, CPL, WCL, WGL	499.00	80	K-5549-K1	2MB, BL	1,680.30	58	K-80655	SH	974.65	38
				K-5557	2MB, BL	1,321.60	58		BL, BNK	1,315.80	
K-32287-SC03	BML, CPL, WCL, WGL	679.00	80		TT	1,458.40			2MB	1,413.25	
				K-5558	2MB, BL	1,701.95	58	K-80656	SH	428.40	38
K-32288-SC04	BML, CPL, WCL, WGL	879.00	81		TT	1,878.05			BL, BNK	578.35	
				K-596	MB	580.10	62		2MB	621.20	
K-32290-PE03	BML, CPL, WCL, WGL	539.00	81	K-597	2MB	554.85	62	K-80657	SH	621.20	38
				K-7104	2MB	1,380.30	60		BL, BNK	838.65	
K-32292-CH03	BML, CPL, WCL, WGL	1,199.00	81	K-7159	2MB	1,414.20	60		2MB	900.75	
				K-7167	2MB	1,063.10	60	K-80658	SH	814.00	38
K-32293-CH03	BML, CPL, WCL, WGL	1,199.00	81	K-7178	2MB	1,526.20	60		BL, BNK	1,098.90	
				K-72581	BLL, BNL, BVL, BZL, CPL, SNL, 2GL	399.00	77		2MB	1,180.30	
K-32294-SF03	BML, CPL, WCL, WGL	529.00	81		AFL, TTL	499.00		K-80659	SH	589.05	38
				K-72582	BLL, BNL, BVL, BZL, CPL, SNL, 2GL	299.00	77		BL, BNK	795.25	
K-32374-FM01	2PL, BLL, CPL	399.00	71		AFL, TTL	379.00			2MB	854.15	
				K-72584	BLL, BNL, BVL, BZL, CPL, SNL, 2GL	179.00	77	K-80660	SH	781.85	38
K-32375-SC01	BLL, BML, BNL, BVL, CPL, SNL, 2GL	199.00	84		AFL, TTL	219.00			BL, BNK	1,055.50	
					AFL, TTL	219.00			2MB	1,133.70	
K-32376-SC01	2PL, BLL, CPL	229.00	71	K-74013-4	2MB	452.70	54	K-80661	SH	974.65	38
				K-74021-4	2MB	470.55	54		BL, BNK	1,315.80	
K-32379-PE01	2PL, BLL	399.00	71	K-74032-4	2MB	1,122.75	54		2MB	1,413.25	
K-32380-CH05	BLL	1,999.00	71	K-76336	2MB	349.60	59	K-80662	SH	428.40	38
K-32382-CH05	BLL	1,999.00	71	K-76337	2MB	349.60	59		BL, BNK	578.35	
K-32619	NA	430.00	37	K-800T70-5AKC	CP	324.50	88		2MB	621.20	
K-32806-SC03	BLL, BNL, BVL, BZL, CPL, SNL, 2GL	369.00	77	K-80646	NA	401.65	37	K-80663	SH	621.20	38
				K-80647	SH	460.55	37		BL, BNK	838.65	
	AFL, TTL	459.00			BL, BNK	621.75			2MB	900.75	
K-33603	NA	400.00	41	K-80648	SH	653.35	37	K-80664	SH	814.00	38
K-33604	NA	666.70	41		BL, BNK	882.05			BL, BNK	1,098.90	
K-400T70-5AKC	CP	227.30	88		2MB	667.80			2MB	1,180.30	
K-40TD00K10	CP	673.95	92	K-80649	SH	846.10	37	K-80TM00K10	CP	233.95	93
					BL, BNK	947.40		K-80TM00N10	CP	233.95	93
K-40TD00N10	CP	673.95	92		2MB	947.40		K-80TM00R10	CP	233.95	93
K-40TD00N10-RF	CP	575.00	92		SH	846.10	37	K-80UM00D20	CP	233.95	93
K-40TD00R10	CP	673.95	92		BL, BNK	1,142.25		K-80UM00G20	CP	233.95	93
K-40TD00R10-RF	CP	575.00	92		2MB	1,226.85		K-8549	2MB	1,017.55	59
K-40TH00K10	CP	852.55	90		SH	846.10	37	K-9110	2MB	43.80	63
K-40TH00N10	CP	852.55	90		BL, BNK	1,142.25		K-9530	2MB	543.70	59
					2MB	1,226.85		K-97021	2MB	364.70	45

KOHLER® FAUCETS 2022 NEW PRODUCT LIST PRICE SUPPLEMENT

NUMERICAL PRICE INDEX

K-97027 to K-TS23954-4

MODEL NO.	COLOR/ FINISH	LIST PRICE	PAGE	MODEL NO.	COLOR/ FINISH	LIST PRICE	PAGE	MODEL NO.	COLOR/ FINISH	LIST PRICE	PAGE
K-97027	2MB	\$ 355.55	46	K-PR4991-T1D	NA	\$ 1,007.30	94	K-T26439-4	CP	\$ 337.00	19
K-97029	2MB	39.15	46	K-PR4991-T1H	NA	1,173.80	94		BL, BN	454.95	
K-97030	2MB	17.85	46	K-PR4991-T2D	NA	1,007.30	94		2MB, BMB	488.65	
K-97031-4	2MB	467.85	54	K-PR4991-T2H	NA	1,173.80	94	K-T26440-4	CBL	607.55	20
K-97060-4	2MB	381.75	55	K-PR5016-T2D	NA	898.40	94	K-T27120-4	2MB	815.15	48
K-97061-4	2MB	418.55	55	K-PR5016-T2DS	NA	928.40	94	K-T27405-4	CP	419.00	13
K-97070-4	2MB	995.75	55	K-PR5016-T2H	NA	1,064.90	94		BL, BN, SN	565.65	
K-97089	2MB	79.70	56	K-PR5016-T2HS	NA	1,094.90	94		2MB	607.55	
K-97093-4	2MB	522.95	55	K-PR5452-T1D	NA	899.55	94	K-T27408-4	CP	1,700.00	13
K-97094-4	2MB	301.35	55	K-PR5452-T1DS	NA	929.55	94		BL, BN, SN	2,295.00	
K-97100-4	2MB	723.15	54	K-PR5452-T1H	NA	1,066.05	94		2MB	2,465.00	
K-97345-4	2MB	729.25	43	K-PR5452-T1HS	NA	1,096.05	94	K-T27417-4	CP	419.00	20
K-97345-4K	2MB	729.25	43	K-PR84325-T3D	NA	863.75	94		BL, BN	565.65	
K-97345-4N	2MB	729.25	43	K-PR84325-T3DS	NA	893.75	94		2MB,	607.55	
K-97347-4	2MB	1,048.35	43	K-PR84325-T3H	NA	1,029.95	94		BMB, CBL		
K-97347-4K	2MB	1,048.35	43	K-PR84325-T3HS	NA	1,059.95	94	K-T27424-4	CP	1,700.00	20
K-97347-4N	2MB	1,022.00	43	K-PR84325-T4D	NA	863.75	94		BL, BN	2,295.00	
K-97352-4	2MB	941.95	43	K-PR84325-T4DS	NA	893.75	94		2MB,	2,465.00	
K-97352-4K	2MB	941.95	43	K-PR84325-T4H	NA	1,029.95	94		BMB, CBL		
K-97352-4N	2MB	941.95	43	K-PR84325-T4HS	NA	1,059.95	94	K-T28130-4	CP	85.00	26
K-97358-4	2MB	1,244.00	44	K-PR84325-T5D	NA	863.75	94		BL, BN	123.25	
K-97494	2MB	249.00	46	K-PR84325-T5DS	NA	893.75	94	K-T28131-4	CP	330.00	25
K-97495	2MB	266.75	46	K-PR96053-T3D	NA	872.35	94		BL, BN	445.50	
K-97496	2MB	373.40	46	K-PR96053-T3DS	NA	902.35	94	K-T77984-4	2MB	2,889.95	42
K-97497	2MB	577.85	46	K-PR96053-T3H	NA	1,038.55	94	K-T77984-9	2MB	3,179.00	42
K-97498	2MB	231.15	46	K-PR96053-T3HS	NA	1,068.55	94	K-T97019-4	2MB	399.80	44
K-97499	2MB	106.75	46	K-PR96053-T4D	NA	872.35	94	K-T97022-4	2MB	442.20	44
K-97500	2MB	128.05	46	K-PR96053-T4DS	NA	902.35	94	K-T97025-4	2MB	204.20	44
K-97502	2MB	204.55	46	K-PR96053-T4H	NA	1,038.55	94	K-T97026-4	2MB	255.15	44
K-97503	2MB	266.75	46	K-PR96053-T4HS	NA	1,068.55	94	K-T97091-4	2MB	247.30	56
K-98068-6HWL	CP	1,089.70	42	K-PR96053-T5D	NA	872.35	94	K-T99762-4	2MB,	328.40	52
	BN, SN	1,471.10		K-PR96053-T5DS	NA	902.35	94		BL, BN		
	2MB, BV	1,580.10		K-PR96057-T3D	NA	892.15	94	K-T99763-4	2MB,	656.30	52
K-98068-6NRO	CP	891.65	42	K-PR96057-T3DS	NA	922.15	94		BL, BN		
	BN, SN	1,203.75		K-PR96057-T3H	NA	1,058.35	94	K-T99763-4G	2MB,	656.30	52
	2MB, BV	1,292.90		K-PR96057-T3HS	NA	1,088.35	94		BL, BN		
K-98351	2MB	107.05	59	K-PR96057-T4D	NA	892.15	94	K-T99763-4L	2MB,	538.10	51
K-99491-4	2MB	471.25	57	K-PR96057-T4DS	NA	922.15	94		BL, BN		
K-99492-4	2MB	471.25	57	K-PR96057-T4H	NA	1,058.35	94	K-TLS23502-4	2MB	831.65	49
K-99760-4	2MB	634.70	51	K-PR96057-T4HS	NA	1,088.35	94	K-TLS23503-4	2MB	619.15	49
K-99760-4K	2MB	634.70	51	K-PR96057-T5D	NA	892.15	94	K-TLS97074-4	2MB	165.60	56
K-99760-4N	2MB	634.70	51	K-PR96057-T5DS	NA	922.15	94	K-TLS97077-4	2MB	120.00	56
K-EC23724	NA	10.50	95	K-T23491-4	2MB	1,059.70	48	K-TLS99764-4	2MB,	306.05	51
K-EC23734	NA	11.50	95	K-T23509-4	2MB	255.15	49		BL, BN		
K-P28304-K	NA	252.45	35	K-T23953-4	CP	122.00	14	K-TS23501-4	2MB	399.80	49
K-P28304-KS	NA	278.85	35		2MB, BL,	176.90		K-TS23502-4	2MB	977.90	49
K-P28304-KSL	NA	278.85	35		BN, SN			K-TS23502-4G	2MB	977.90	49
K-P28305	NA	194.70	35	K-T23955-4	CP	122.00	21	K-TS23503-4	2MB	765.25	49
K-PR20713-T1D	NA	917.40	94		2MB,	176.90		K-TS23503-4G	2MB	765.25	49
K-PR20713-T1H	NA	1,083.90	94		BL, BMB,			K-TS23952-4	CP	189.00	14
K-PR20713-T2D	NA	917.40	94		BN, CBL				2MB, BL,	274.05	
K-PR20713-T2H	NA	1,083.90	94	K-T26432-4	CP	337.00	13		BN, SN		
K-PR25042-T4DS	NA	1,683.25	94		BL, BN, SN	454.95		K-TS23954-4	CP	189.00	21
K-PR25042-T4DSL	NA	1,703.25	94		2MB	488.65			2MB,	274.05	
K-PR25042-T4HS	NA	1,849.45	94	K-T26436-4	CP	419.00	13		BL, BMB,		
K-PR25042-T4HSL	NA	1,869.45	94		BL, BN, SN	565.65			BN, CBL		
K-PR25042-T5DS	NA	1,683.25	94		2MB	607.55					
K-PR25042-T5DSL	NA	1,703.25	94								

MODEL NO.	COLOR/ FINISH	LIST PRICE	PAGE
K-TS27403-4	CP	\$ 356.00	14
	2MB, BL, BN, SN	516.20	
K-TS27403-4G	CP	356.00	14
	2MB, BL, BN, SN	516.20	
K-TS27404-4	CP	356.00	14
	2MB, BL, BN, SN	516.20	
K-TS27404-4G	CP	356.00	14
	2MB, BL, BN, SN	516.20	
K-TS27420-4	CP	356.00	20
	2MB, BL, BMB, BN, CBL	516.20	
K-TS27420-4G	CP	356.00	20
	2MB, BL, BMB, BN, CBL	516.20	
K-TS27421-4	CP	356.00	20
	2MB, BL, BMB, BN, CBL	516.20	
K-TS27421-4G	CP	356.00	20
	2MB, BL, BMB, BN, CBL	516.20	
K-TS28127-4G	CP	153.00	25
	BL, BN	221.85	
K-TS28128-4G	CP	116.00	25
	BL, BN	168.20	
K-TS28129-4	CP	110.00	26
	BL, BN	159.50	
K-TS74042-4	2MB	106.65	56
K-TS97018-4	2MB	399.80	44
K-TS97074-4G	2MB	209.35	56
K-TS97077-4G	2MB	152.20	56
K-TS99761-4	2MB, BL, BN	299.30	52
	2MB, BL, BN	408.00	
K-TS99764-4	2MB, BL, BN	408.00	52
	2MB, BL, BN	408.00	



RIFF

Inspired by the French and Spanish architecture of the historical American South, the Riff bathroom faucet collection offers a contemporary twist on traditional design. The distinctive, square lines will elevate your space with a timeless feel. Offering high design paired with thoughtful functionality, the Riff collection is a true modern classic.

SINGLE-HANDLE BATHROOM SINK FAUCET

Max flow rates:
1.2 gmp (4.5 lpm), 1.0 gpm (3.8 lpm) or 0.5 gpm (1.9 lpm)

PRODUCT	MODEL NO.	DESCRIPTION	COLOR/FINISH	LIST PRICE
	K-27400-4	Riff Single-Handle Bathroom Sink Faucet Spout reach: 5" (127 mm) Spout height: 4-1/4" (107 mm) (base to outlet) Aerated flow Lever handle Ladle drain install type Pop-up drain with 1-1/4" (32 mm) tailpiece For single hole installation	CP	\$ 291.00
			BL, BN SN	392.85
			2MB	421.95
	K-27400-4K	Flow rate: 1.0 gpm (3.8 lpm) Aerated flow	CP	291.00
			BL, BN SN	392.85
			2MB	421.95
	K-27400-4N	Flow rate: 0.5 gpm (1.9 lpm) Spray stream flow	CP	291.00
			BL, BN SN	392.85
			2MB	421.95

PRODUCT	MODEL NO.	DESCRIPTION	COLOR/FINISH	LIST PRICE
	K-26430-4	Riff Tall Single-Handle Bathroom Sink Faucet Spout reach: 5" (127 mm) Spout height: 6-3/4" (171 mm) (base to outlet) Aerated flow Single handle Clicker drain with integral tailpiece. For single hole installation	CP	\$ 418.00
			BL, BN SN	564.30
			2MB	606.10
	K-26430-4K	Flow rate: 1.0 gpm (3.8 lpm) Aerated flow	CP	418.00
			BL, BN SN	564.30
			2MB	606.10
	K-26430-4N	Flow rate: 0.5 gpm (1.9 lpm) Spray stream flow	CP	418.00
			BL, BN SN	564.30
			2MB	606.10

WIDESPREAD BATHROOM SINK FAUCET

Max flow rates:
1.2 gpm (4.5 lpm), 1.0 gpm (3.8 lpm) or 0.5 gpm (1.9 lpm)





PRODUCT	MODEL NO.	DESCRIPTION	COLOR/FINISH	LIST PRICE
	K-27399-4	Riff Widespread Bathroom Sink Faucet Spout reach: 4-15/16" (125 mm) Spout height: 3-13/16" (97 mm) (base to outlet) Aerated flow Lever handles Pop-up drain with 1-1/4" (32 mm) tailpiece For 8" to 16" (203 mm to 406 mm) centers	CP	\$ 465.00
			BL, BN, SN	627.75
			2MB	674.25
	K-27399-4K	Flow rate: 1.0 gpm (3.8 lpm) Aerated flow	CP	465.00
			BL, BN, SN	627.75
			2MB	674.25
	K-27399-4N	Flow rate: 0.5 gpm (1.9 lpm) Spray stream flow	CP	465.00
			BL, BN, SN	627.75
			2MB	674.25

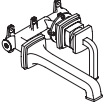

Competitive

Max flow rate:
1.2 gpm (4.5 lpm)

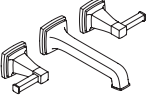
WALL-MOUNT BATHROOM FAUCET

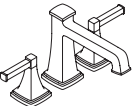

PRODUCT	MODEL NO.	DESCRIPTION	COLOR/FINISH	LIST PRICE
	K-26431-4 	Riff Wall-Mount Single-Handle Bathroom Sink Faucet Spout reach: 7-1/8" (181 mm) Laminar flow Lever handle Includes wall-mount single control valve	CP	\$ 430.00
			BL, BN SN	580.50
			2MB	623.50
	K-T26432-4 	Riff Wall-Mount Bathroom Sink Faucet Trim Spout reach: 7-1/8" (181 mm) Laminar flow Lever handles Trim only, for use with valve K-438-K	CP	337.00
			BL, BN SN	454.95
			2MB	488.65

DECK-MOUNT BATH FILLER WITH DIVERTER

PRODUCT	MODEL NO.	DESCRIPTION	COLOR/FINISH	LIST PRICE
	K-T26436-4	Riff Deck-mount Bath Faucet Trim Diverter spout Spout reach: 7-7/16" (189 mm) Spout height: 4-1/2" (114 mm) Lever handles Trim only, for use with valve K-438-K	CP	\$ 419.00
			BL, BN SN	565.65
			2MB	607.55
	K-T27405-4	Riff Bath Faucet Trim Spout reach: 7-7/16" (89 mm) Spout height: 4-1/2" (114 mm) Trim only, for use with valve K-300 or K-301	CP	419.00
			BL, BN SN	565.65
			2MB	607.55

Max flow rates:
Bath Filler: 7.5 gpm (28.4 lpm)
Handshower: 1.75 gpm (6.6 lpm)

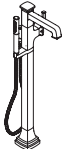
FLOOR-MOUNT BATH FILLER

PRODUCT	MODEL NO.	DESCRIPTION	COLOR/FINISH	LIST PRICE
	K-T27408-4 	Riff Floor-Mount Bath Filler Trim Single handle Spout reach: 9" (229 mm) Required: For freestanding installation K-97339 Mounting-block	CP	\$ 1,700.00
			BL, BN SN	2,295.00
			2MB	2,465.00







Lever handles comply with the actuation force limitations of the 2010 ADA Standards for Accessible Design, Section 309 Operable Parts, of the Act.

THE BOLD LOOK
OF **KOHLER**

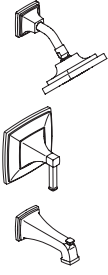
RITE-TEMP BATH & SHOWER TRIM SETS WITH SHOWERHEAD

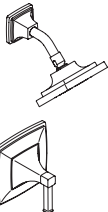
Max flow rates:
(Showerheads): 2.5 gpm (9.5 lpi) or 1.75 gpm (6.6 lpi)

PRODUCT	MODEL NO.	DESCRIPTION	COLOR/FINISH	LIST PRICE
	K-TS27403-4 	Riff Rite-Temp Pressure-Balancing Bath and Shower Trim Set 6-1/16" (154 mm) diverter spout with slip-fit connection Lever handle 2.5 gpm (9.5 lpm) Single Function Showerhead, arm and flange Trim only, for use with valve K-8304 or K-8300/K8305	CP	\$ 356.00
			BL, BN SN, 2MB	516.20
	K-TS27403-4G	With 1.75 gpm (6.61 lpm) single function showerhead	CP	356.00
			BL, BN SN, 2MB	516.20
			CP	356.00
			BL, BN SN, 2MB	516.20
	K-TS27404-4 	Riff Rite-Temp Shower Trim Set MasterClean™ sprayface Lever handle 2.5 gpm (9.5 lpm) Single Function Showerhead, arm and flange Trim only, for use with valve K-304 or K-8304 or K8300/K8305 or K2971-KS	CP	356.00
			BL, BN SN, 2MB	516.20
	K-TS27404-4G	With 1.75 gpm (6.61 lpm) single function showerhead	CP	356.00
			BL, BN SN, 2MB	516.20
			CP	356.00
			BL, BN SN, 2MB	516.20

RITE-TEMP PRESSURE-BALANCE TRIM

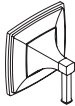
PRODUCT	MODEL NO.	DESCRIPTION	COLOR/FINISH	LIST PRICE
	K-TS23952-4	Riff Rite-Temp Pressure-Balancing Valve Trim Lever handle Trim only, for use with valve K-304 or K-8304 or K8300/K8305 or K2971-KS	CP	\$ 189.00
			BL, BN SN, 2MB	274.05

TRANSFER/DIVERTER VALVE TRIM

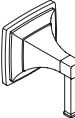
PRODUCT	MODEL NO.	DESCRIPTION	COLOR/FINISH	LIST PRICE
	K-T23953-4	Riff Transfer/Diverter Valve Trim Lever handle Trim only, for use with K-728-K or K-737-K	CP	\$ 122.00
			BL, BN SN, 2MB	176.90



BATH AND SHOWER COMPONENTS

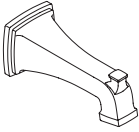
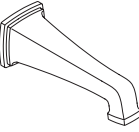



PRODUCT	MODEL NO.	DESCRIPTION	COLOR/ FINISH	LIST PRICE
	K-29477	Riff Deck- or Bath-Mount Handshower Holder with Hose Requires handshower	CP	\$ 222.00
			BL, BN SN, 2MB	321.90
	K-27406	Riff Wall-Mount Diverter Bath Spout Spout reach: 6-1/16" (154 mm) 1-1/4" (32 mm) max hole diameter	CP	80.00
			BL, BN SN	108.00
			2MB	116.00
	K-27407	Riff Wall-Mount Non-Diverter Bath Spout Spout reach: 7-13/16" (198 mm) 1-1/4" (32 mm) max hole diameter	CP	77.00
			BL, BN SN	103.95
			2MB	111.65



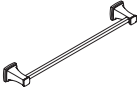

Lever handles comply with the actuation force limitations of the 2010 ADA Standards for Accessible Design, Section 309 Operable Parts, of the Act.

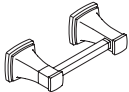
THE BOLD LOOK
OF KOHLER®

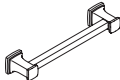
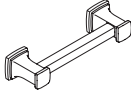
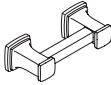

ACCESORIES

PRODUCT	MODEL NO.	DESCRIPTION	COLOR/FINISH	LIST PRICE
	K-27410	Riff 24" (610 mm) Towel Bar (26-11/16" x 4" x 2-11/16") (678 x 102 x 68 mm)	CP	\$ 68.00
			BL, BN SN	91.80
			2MB	98.60
	K-27411	Riff Double Robe Hook (4-11/16" x 3-3/8" x 2-11/16") (119 x 86 x 68 mm)	CP	\$ 31.00
			BL, BN SN	41.85
			2MB	44.95
	K-27413	Riff Pivoting Toilet Paper Holder (9-3/16" x 4" x 2-11/16") (233 x 102 x 68 mm)	CP	\$ 56.00
			BL, BN SN	75.60
			2MB	81.20
	K-24433	Riff Cabinet Knob (9/16" x 1-1/16" x 1-5/16") (14 x 27 x 33 mm)	CP	\$ 12.00
			BL, BN SN	16.20
			2MB	17.40

PRODUCT	MODEL NO.	DESCRIPTION	COLOR/FINISH	LIST PRICE
	K-27409	Riff 18" (457 mm) Towel Bar (20-11/16" x 4" x 2-11/16") (525 x 102 x 68 mm)	CP	\$ 65.00
			BL, BN SN	87.75
			2MB	94.25
	K-27412	Riff 10" (254 mm) Towel Ring (10" x 4" x 6-7/16") (254 x 102 x 163 mm)	CP	\$ 46.00
			BL, BN SN	62.10
			2MB	66.70
	K-24436	Riff 7" (178 mm) Cabinet Pull (7-5/8" x 1-5/16" x 5/8") (194 x 33 x 16 mm)	CP	\$ 17.00
			BL, BN SN	22.95
			2MB	24.65
	K-24435	Riff 5" (127 mm) Cabinet Pull (5-5/8" x 1-5/16" x 5/8") (143 x 33 x 16 mm)	CP	\$ 15.00
			BL, BN SN	20.25
			2MB	21.75
	K-24434	Riff 3" (76 mm) Cabinet Pull (3-4/8" x 1-5/16" x 5/8") (89 x 33 x 16 mm)	CP	\$ 13.00
			BL, BN SN	17.55
			2MB	18.85

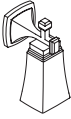
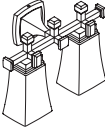
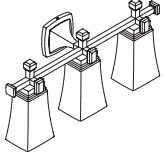
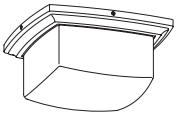

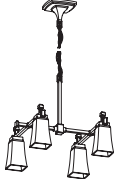
Light Sconce				
PRODUCT	MODEL NO.	DESCRIPTION	COLOR/FINISH	LIST PRICE
	K-31755-SC01	Riff 11" (284 mm) One-Light Sconce Clear, bell-shaped shades, chunky bars and square bases. Fixture: 11-3/16" (284 mm) H Shade: 8-1/2" H x 4-3/4" W x 3-15/16" D (216 x 122 x 100 mm) Backplate: 4-13/16" (122 mm) dia. Wall projection: 6-9/16" (167 mm) Medium (E26) base; T10 bulb (sold separately) Suitable for damp locations, per UL 1598	CPL, 2GL BLL, BNL SNL	\$ 189.00
	K-31756-SC02	Riff 16" (405 mm) Two-Light Sconce Clear, bell-shaped shades, chunky bars and square bases. Fixture: 11-3/16" (284 mm) H Shade: 8-1/2" H x 4-3/4" W x 3-15/16" D (216 x 122 x 100 mm) Backplate: 4-13/16" (122 mm) dia. Wall projection: 6-9/16" (167 mm) Medium (E26) base; T10 bulb (sold separately) Suitable for damp locations, per UL 1598	CPL, 2GL BLL, BNL SNL	349.00
	K-31757-SC03	Riff 25" (632 mm) Three-Light Sconce Clear, bell-shaped shades, chunky bars and square bases. Fixture: 11-3/16" H (284 mm) Shade: 8-1/2" H x 4-3/4" W x 3-15/16" D (216 x 122 x 100 mm) Backplate: 4-13/16" (122 mm) dia. Wall projection: 6-9/16" (167 mm) Medium (E26) base; T10 bulb (sold separately) Suitable for damp locations, per UL 1598	CPL, 2GL BLL, BNL SNL	449.00
	K-31760-FM02	Riff Two-Light Flush Mount Clear, bell-shaped shades, chunky bars and square bases. Fixture: 11-3/16" H (284 mm) Shade: 5-3/8" H x 10-11/16" W x 10-11/16" D (137 x 271 x 271 mm) Backplate: 14" (356 mm) Wall projection: 6-13/16" (173 mm) Medium (E26) base; G16-1/2 bulb (sold separately) Suitable for damp locations, per UL 1598	2GL SNL	429.00

Chandelier				
PRODUCT	MODEL NO.	DESCRIPTION	COLOR/FINISH	LIST PRICE
	K-31758-CH04	Riff Four-Light Chandelier - 30-9/16" x 23-15/16" (776 x 608 mm) Clear, bell-shaped shades, chunky bars and square bases. Fixture: 31-1/4" - 101-1/2" (794 mm - 2578 mm) Shade: 5-3/8" H x 10-11/16" W x 10-11/16" D (137 x 271 x 271 mm) Backplate: 7-1/2" (191 mm) dia. Medium (E26) base; T10 bulb (sold separately) Suitable for damp locations, per UL 1598	2GL SNL	\$ 799.00
	K-31759-CH08	Riff Eight-Light Chandelier - 35" x 32-1/2" (889 x 826 mm) Clear, bell-shaped shades, chunky bars and square bases. Fixture: 32" - 102-1/2" (819 - 2604 mm) Shade: 5-3/8" H x 10-11/16" W x 10-11/16" D (137 x 271 x 271 mm) Backplate: 7-1/2" (191 mm) dia. Medium (E26) base; T10 bulb (sold separately) Suitable for damp locations, per UL 1598	2GL SNL	1,499.00



Lever handles comply with the actuation force limitations of the 2010 ADA Standards for Accessible Design, Section 309 Operable Parts, of the Act.

THE BOLD LOOK
OF KOHLER®



TONE

With clean lines and a soft teardrop base, the Tone bathroom faucet collection features a fresh take on midcentury modern style. This inviting design, where minimalism meets warmth, makes for a perfect fit in any space. Paired with thoughtful functionality, the Tone collection is a dynamic beauty.

SINGLE-HANDLE BATHROOM SINK FAUCET

Max flow rates:
1.2 gpm (4.5 lpm), 1.0 gpm (3.8 lpm) or 0.5 gpm (1.9 lpm)

PRODUCT	MODEL NO.	DESCRIPTION	COLOR/FINISH	LIST PRICE
	K-27415-4 	Tone Single-Handle Bathroom Sink Faucet Spout reach: 5-7/8" (149 mm) Spout height: 4-1/4" (108 mm) Lever handle Clicker drain with integral tailpiece For both single-hole and three-hole installations Escutcheon plate included	CP	\$ 291.00
			BL, BN	392.85
			BMB, CBL 2MB	421.95
	K-27415-4K 	Flow rate: 1.0 gpm (3.8 l/min) Aerated flow	CP	291.00
			BL, BN	392.85
			BMB, CBL 2MB	421.95
	K-27415-4N	Flow rate: 0.5 gpm (1.9 l/min) Spray stream flow	CP	291.00
			BL, BN	392.85
			BMB, CBL 2MB	421.95

PRODUCT	MODEL NO.	DESCRIPTION	COLOR/FINISH	LIST PRICE
	K-26437-4 	Tone Tall Single-Handle Bathroom Sink Faucet Spout reach: 5-7/8" (149 mm) Spout height: 6-7/8" (175 mm) (base to outlet) Aerated flow Lever handle Clicker drain with integral tailpiece For both single-hole and three-hole installations Escutcheon plate included	CP	\$ 418.00
			BL, BN	564.30
			BMB, CBL 2MB	606.10
	K-26437-4K 	Flow rate: 1.0 gpm (3.8 l/min) Aerated flow	CP	418.00
			BL, BN	564.30
			BMB, CBL 2MB	606.10
	K-26437-4N	Flow rate: 0.5 gpm (1.9 l/min) Spray stream flow	CP	418.00
			BL, BN	564.30
			BMB, CBL 2MB	606.10



Competitive

Max flow rates:
1.2 gpm (4.5 lpm), 1.0 gpm (3.8 lpm) or 0.5 gpm (1.9 lpm)

WIDESPREAD BATHROOM SINK FAUCET

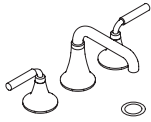
PRODUCT	MODEL NO.	DESCRIPTION	COLOR/ FINISH	LIST PRICE
	K-27416-4	Tone Widespread Bathroom Sink Faucet Spout reach: 5-15/16" (151 mm) Spout height: 4-1/16" (103 mm) (base to outlet) Aerated flow Lever handles Clicker drain with integral tailpiece 8" to 16" (203mm to 406 mm) centers	CP	\$ 465.00
			BL, BN	627.75
			BMB, CBL 2MB	674.25
	K-27416-4K	Flow rate: 1.0 gpm (3.8 l/min) Aerated flow	CP	465.00
			BL, BN	627.75
			BMB, CBL 2MB	674.25
	K-27416-4N	Flow rate: 0.5 gpm (1.9 l/min) Spray stream flow	CP	465.00
			BL, BN	627.75
			BMB, CBL 2MB	674.25

Max flow rate:
1.2 gpm (4.5 l/min)

WALL-MOUNT BATHROOM SINK FAUCET AND TRIM

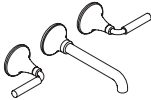
PRODUCT	MODEL NO.	DESCRIPTION	COLOR/ FINISH	LIST PRICE
	K-26438-4	Tone Wall-Mount Single-Handle Bathroom Sink Faucet Spout reach: 7-11/16" (195 mm) Laminar flow Single handle Trim only, for use with K-410 valve	CP	\$ 623.50
			BL, BN	454.95
	K-T26439-4	Tone Wall-Mount Bathroom Sink Faucet Trim Spout reach: 7-11/16" (195 mm) Laminar flow Two lever handle Trim only, for use with K-410 valve	CP	337.00
			BL, BN	454.95
			BMB, 2MB	488.65

Max flow rates:
(Bath Filler): 8.0 gpm (30.3 lpm)
(Handshower): 1.75 gpm (6.6 lpm)

DECK-MOUNT BATH FAUCET WITH HANDSHOWER

PRODUCT	MODEL NO.	DESCRIPTION	COLOR/ FINISH	LIST PRICE
	K-26441-4	Tone Deck-Mount Bath Faucet with Handshower Spout reach: 8-9/16" (217 mm) Spout height: 5-3/8" (137 mm) Slip-fit connection and diverter knob Lever handle	CP	\$ 670.00
			BL, BN	904.50
			BMB, 2MB	971.50



Lever handles comply with the actuation force limitations of the 2010 ADA Standards for Accessible Design, Section 309 Operable Parts, of the Act.

THE BOLD LOOK
OF KOHLER®

DECK-MOUNT BATH FAUCET AND TRIM

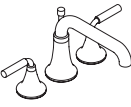
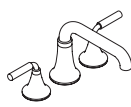
PRODUCT	MODEL NO.	DESCRIPTION	COLOR/FINISH	LIST PRICE
	K-T26440-4	Tone Bath Faucet Trim Spout reach: 8-9/16" (217 mm) Spout height: 5-3/8" (137 mm) Slip-fit connection and diverter knob Lever handle Trim only, for use with K-438-K valve	CBL	\$ 607.55
	K-T27417-4	Tone Bath Faucet Trim Spout reach: 8-9/16" (217 mm) Spout height: 5-3/8" (137 mm) Lever handle Trim only, for use with K-300-K or K-301-K valve	CP BL, BN BMB, CBL 2MB	419.00 565.65 607.55

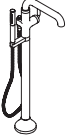

FLOOR-MOUNT BATH FILLER

Max flow rates:
(Bath Filler): 7.5 gpm (28.4 lpm)
(Handshower): 1.75 gpm (6.6 lpm)

PRODUCT	MODEL NO.	DESCRIPTION	COLOR/FINISH	LIST PRICE
	K-T27424-4	Tone Floor-Mount Bath Filler Trim Spout reach: 11-7/16" (290 mm) Single handle Required: For freestanding installation K-97339 Mounting-block	CP BL, BN BMB, CBL 2MB	\$ 1,700.00 2,295.00 2,465.00

RITE-TEMP® BATH & SHOWER FAUCET TRIM SETS WITH SHOWERHEAD

Max flow rates:
(Showerheads): 2.5 gpm (9.5 lpm)
or 1.75 gpm (6.6 lpm)

PRODUCT	MODEL NO.	DESCRIPTION	COLOR/FINISH	LIST PRICE
	K-TS27420-4	Tone Rite-Temp Pressure-Balancing Shower Faucet Trim Set Lever handle 2.5 gpm (9.5 lpm) Single-Function Showerhead, arm and flange Trim only, for use with K-8304 or K-8300/K8305	CP BL, BMB, BN CBL, 2MB SN, 2MB	\$ 356.00 516.20
	K-TS27420-4G	Single-function 1.75 gpm (6.6 lpm) showerhead	CP BL, BMB, BN CBL, 2MB SN, 2MB	356.00 516.20
	K-TS27421-4	Tone Rite-Temp Pressure-Balancing Bath and Shower Trim Set 6-9/16" (167 mm) diverter bath spout with slip-fit connection Lever handle MasterClean™ sprayface, shower arm and flange 2.5 gpm (9.5 lpm) Single-Function Showerhead Trim only, for use with K-8304 or K-8300 /K-8305	CP BL, BMB BN, CBL 2MB	356.00 516.20
	K-TS27421-4G	1.75 gpm (6.6 lpm) Single-Function Showerhead	CP BL, BMB BN, CBL 2MB	356.00 516.20



Competitive

RITE-TEMP® PRESSURE-BALANCING VALVE TRIM

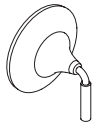
PRODUCT	MODEL NO.	DESCRIPTION	COLOR/FINISH	LIST PRICE
	K-TS23954-4	Tone Rite-Temp Pressure-balancing Valve Trim Lever handle Trim only, for use with K-304 or K-8304 or K-8300/K-8305 or K-2971-KS valve	CP	\$ 189.00
			BL, BMB BN, CBL 2MB	274.05

TRANSFER/DIVERTER VALVE TRIM

PRODUCT	MODEL NO.	DESCRIPTION	COLOR/FINISH	LIST PRICE
	K-T23955-4	Tone Transfer/Diverter Valve Trim Lever handle Trim only, for use with K-728-K or K-737-K valve	CP	\$ 122.00
			BL, BMB BN, CBL 2MB, SN 2MB	176.90

WALL-MOUNT BATH SPOUT

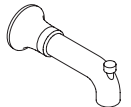
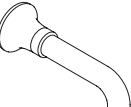
PRODUCT	MODEL NO.	DESCRIPTION	COLOR/FINISH	LIST PRICE
	K-27422	Tone Wall-Mount Diverter Bath Spout Diverter spout with slip-fit connection Spout reach: 6-9/16" (167 mm) 1/4" (31.8 mm) max hole diameter	CP	\$ 80.00
			BL, BN	108.00
			BMB, CBL, 2MB	116.00
	K-27423	Tone Wall-Mount Non-Diverter Bath Spout Non-diverter spout with slip-fit connection Nondiverter spout: 7-7/16" (189 mm) 1-1/4" (31.8 mm) max hole diameter	CP	77.00
			BL, BN	103.95
			BMB, CBL 2MB	111.65

BATH AND SHOWER COMPONENTS





PRODUCT	MODEL NO.	DESCRIPTION	COLOR/FINISH	LIST PRICE
	K-29478	Tone Deck-Mount Handshower Holder with Hose Requires handshower	CP	\$ 222.00
			BL, BMB BN, CBL 2MB	321.90





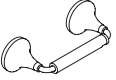

Lever handles comply with the actuation force limitations of the 2010 ADA Standards for Accessible Design, Section 309 Operable Parts, of the Act.

THE BOLD LOOK
OF **KOHLER**®



ACCESSORIES

PRODUCT	MODEL NO.	DESCRIPTION	COLOR/FINISH	LIST PRICE
	K-27426	Tone 24" (610 mm) Towel Bar (24" x 3-9/16" x 2-9/16") (522 x 90 x 65 mm)	CP	\$ 68.00
			BL, BN	91.80
			BMB, CBL 2MB	98.60
	K-27427	Tone Double Robe Hook (2-15/16" x 3-13/16" x 2-9/16") (75 x 97 x 65 mm)	CP	\$ 31.00
			BL, BN	41.85
			BMB, CBL 2MB	44.95
	K-27429	Tone Pivoting Toilet Paper Holder (9-1/16" x 3-11/16" x 2-9/16") (230 x 94 x 65 mm)	CP	\$ 56.00
			BL, BN	75.60
			BMB, CBL 2MB	81.20
	K-24437	Tone Cabinet Knob (9/16" x 1-1/16" x 1-5/16") (14 x 27 x 33 mm)	CP	\$ 12.00
			BL, BN	16.20
			BMB, CBL 2MB	17.40

PRODUCT	MODEL NO.	DESCRIPTION	COLOR/FINISH	LIST PRICE
	K-27425	Tone 18" (457 mm) Towel Bar (20 9/16" x 3-9/16" x 2-9/16") (522 x 90 x 65 mm)	CP	\$ 65.00
			BL, BN	87.75
			BMB, BL 2MB	94.25
	K-27428	Tone Towel Ring (8-5/16 x 3-9/16" x 7") (211 x 90 x 178 mm)	CP	\$ 46.00
			BL, BN	62.10
			BMB, BL 2MB	66.70
	K-24440	Tone 7" (178 mm) Cabinet Pull (7-5/8" x 1-5/16" x 5/8") (194 x 33 x 16 mm)	CP	\$ 17.00
			BL, BN	22.95
			BMB, CBL 2MB	24.65
	K-24439	Tone 5" (127 mm) Cabinet Pull (5-5/8" x 1-5/16" x 5/8") (143 x 33 x 16 mm)	CP	15.00
			BL, BN	20.25
			BMB, CBL 2MB	21.75
	K-24438	Tone 3" (76 mm) Cabinet Pull (3-5/8" x 1-5/16" x 5/8") (92 x 33 x 16 mm)	CP	13.00
			BL, BN	17.55
			BMB, CBL 2MB	18.85

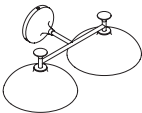
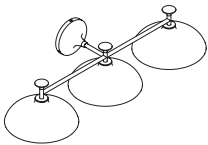

LIGHTING

PRODUCT	MODEL NO.	DESCRIPTION	COLOR/ FINISH	LIST PRICE
	K-31772-FM01	Tone One-Light Flush-Mount Domed glass shades, intersecting rods, flared metal base Fixture: 7-3/8" x 14-3/4" (187 mm x 375 mm) Plate diameter: 4-13/16" (122 mm) Candelabra (E12) base; type G bulb (sold separately) Suitable for damp locations, per UL 1598.	BLL, BML SNL	\$ 249.00
	K-31768-SC01	Tone 7" (178 mm) One-Light Sconce Domed glass shades, intersecting rods, flared metal base Fixture: 6-11/16" x 10-3/4" (170mm x 273 mm) Shade width: 9-1/16" (230 mm) Wall projection: 10-3/4" (273 mm) Plate diameter: 4-13/16" (122 mm) Candelabra (E12) base; type G bulb (sold separately) Suitable for damp locations, per UL 1598.	BLL, BML BNL, CBL CPL, 2GL	129.00
	K-31771-PE01	Tone 15" (381 mm) One-Light Pendant 24-1/2"-96-1/2" (622 mm x 2451 mm) max Domed glass shades intersecting rods, flared metal base Fixture: 19-1/2" (495 mm) Shade width: 14-3/4" (375 mm) Plate diameter: 3-13/16" x 4-13/16" (122 mm x 97 mm) Candelabra (E12) base; type G bulb (sold separately) Suitable for damp locations, per UL 1598.	BLL, BML SNL	199.00
	K-31769-SC02	Tone 20" (508 mm) Two-Light Sconce Domed glass shades, intersecting rods, flared metal base Fixture: 6-3/4" x 20-1/8" (511 mm x 171 mm) Shade width: 9-1/8" (232 mm) Wall projection: 10-3/4" (273 mm) Plate diameter: 4-13/16" (122 mm) Candelabra (E12) base; type G bulbs (sold separately) Suitable for damp locations, per UL 1598	BLL, BML BNL, CBL CPL, 2GL	239.00
	K-31770-SC03	Tone 31" (787 mm) Three-Light Sconce Domed glass shades, intersecting rods, flared metal base Fixture: 6-3/4" x 31-1/8" (171 mm x 791 mm) Shade width: 9-1/16" (230 mm) Wall projection: 10-3/4" (273 mm) Plate diameter: 4-13/16" (122 mm) Candelabra (E12) base; type G bulbs (sold separately) Suitable for damp locations, per UL 1598	BLL, BML BNL, CBL CPL, 2GL	349.00

Chandeliers

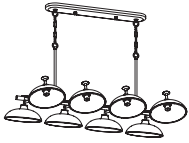
PRODUCT	MODEL NO.	DESCRIPTION	COLOR/ FINISH	LIST PRICE
	K-31773-CH04	Tone 24" (610 mm) Four-Light Chandelier 35-1/4" - 89-1/4" max (895 mm x 2267 mm) Domed glass shades, intersecting rods, flared metal base Fixture width: 26-1/2" H x 24-1/16" (673 mm x 616 mm) Shade width: 9-1/8" (232 mm) Plate height: 4-13/16" diameter x 2-7/16" (122 mm x 62 mm) Candelabra (E12) base; type G bulb (sold separately) Suitable for damp locations, per UL 1598.	BLL, BML SNL	\$ 599.00
	K-31774-CH08	Tone 41" (1041 mm) Eight-Light Chandelier 22-7/16" - 92-13/16" max (570 mm x 2357 mm) Domed glass shades, intersecting rods, flared metal base Fixture width: 18-13/16" H x 41-1/16" (478 mm x 1043 mm) Plate height: 25-11/16" L x 4-3/4" W x 15/16" (652 mm x 121 mm x 62 mm) Candelabra (E12) base; type G bulb (sold separately) Suitable for damp locations, per UL 1598.	BLL, BML SNL	1,199.00



Lever handles comply with the actuation force limitations of the 2010 ADA Standards for Accessible Design, Section 309 Operable Parts, of the Act.

THE BOLD LOOK
OF KOHLER.



VENZA

Combining simple, architectural forms with sensual lines, the Venza bathroom faucet collection blends organic design elements with crisp, minimal geometry. This transfer valve trim exemplifies the Venza collection's contours. Pair this trim with a MasterShower® transfer valve to create a personalized shower experience.

SINGLE-HANDLE BATHROOM SINK FAUCET

Max flow rates:
1.2 gpm (4.5 lpm), 1.0 gpm (3.8 lpm)
or 0.5 gpm (1.9 lpm)

PRODUCT	MODEL NO.	DESCRIPTION	COLOR/FINISH	LIST PRICE
	K-28126-4 	Venza Single-Handle Bathroom Sink Faucet Spout reach: 5-1/2" (140 mm) Spout height: 4-1/16" (103 mm) (base to outlet) Laminar flow Single-lever handle Clicker drain with 1-1/4" (32 mm) tailpiece For both single-hole or three-hole installations 6" (152 mm) Escutchen plate included	CP	\$ 218.00
			BL, BN	294.30
	K-28126-4K 	Flow rate: 1.0 gpm (3.8 lpm)	CP	218.00
			BL, BN	294.30
	K-28126-4N	Flow rate: 0.5 gpm (1.9 lpm)	CP	218.00
			BL, BN	294.30

CENTERSET BATHROOM SINK FAUCET



Max flow rates:
1.2 gpm (4.5 lpm), 1.0 gpm (3.8 lpm)
or 0.5 gpm (1.9 lpm)

PRODUCT	MODEL NO.	DESCRIPTION	COLOR/FINISH	LIST PRICE
	K-28124-4 	Venza Centerset Bathroom Sink Faucet Spout reach: 5-1/2" (140 mm) Spout height: 4-1/4" (108 mm) Laminar flow Lever handle Clicker drain with 1-1/4" (32 mm) tailpiece For 4" (102 mm) centers	CP	\$ 190.00
			BL, BN	256.50
	K-28124-4K 	Flow rate: 1.0 gpm (3.8 lpm)	CP	190.00
			BL, BN	256.50
	K-28124-4N	Flow rate: 0.5 gpm (1.9 lpm)	CP	190.00
			BL, BN	256.50

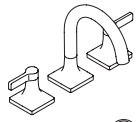

Competitive

Max flow rates:
1.2 gpm (4.5 lpm), 1.0 gpm (3.8 lpm)
or 0.5 gpm (1.9 lpm)

WIDESPREAD BATHROOM SINK FAUCET





PRODUCT	MODEL NO.	DESCRIPTION	COLOR/FINISH	LIST PRICE
	K-28125-4 	Venza Widespread Bathroom Sink Faucet Spout reach: 5-1/2" (140 mm) Spout height: 4-1/4" (108 mm) (base to outlet) Laminar flow Lever handle Clicker drain with 1-1/4" (32 mm) tailpiece For 8" to 16" (203 mm to 406 mm) centers	CP	\$ 357.00
			BL, BN	481.95
	K-28125-4K 	Flow rate: 1.0 gpm (3.8 lpm) Laminar	CP	357.00
			BL, BN	481.95
	K-28125-4N	Flow rate: 0.5 gpm (1.9 lpm) Laminar	CP	357.00
			BL, BN	481.95

DECK-MOUNT BATH FAUCET TRIM

PRODUCT	MODEL NO.	DESCRIPTION	COLOR/FINISH	LIST PRICE
	K-T28131-4 	Venza Deck-Mount Bath Faucet Trim Gooseneck non-diverter spout Spout reach: 7-1/2" (191 mm) Spout height: 6-3/8" (162 mm) (base to outlet) Lever handles Trim only, for use with valves: K-300-K/KR	CP	\$ 330.00
			BL, BN	445.50

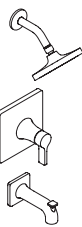
Max flow rate:
1.75 gpm (6.6 lpm)

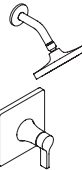
RITE-TEMP® SHOWER FAUCET TRIM SET - 1.75 GPM SHOWERHEAD

PRODUCT	MODEL NO.	DESCRIPTION	COLOR/FINISH	LIST PRICE
	K-TS28127-4G 	Venza Rite-Temp Pressure-Balancing Bath and Shower Faucet Trim Set 5" (131 mm) Diverter spout with slip-fit connection Lever handle 1.75 gpm (6.6 lpm) single-function showerhead, arm and flange Trim only, for use with valves: K-8304-K/-**	CP	\$ 153.00
			BL, BN	221.85
	K-TS28128-4G 	Venza Rite-Temp Pressure Balancing Shower Trim Set Lever handle 1.75 gpm (6.6 lpm) single-function showerhead, arm and flange Trim only, for use with valves: K-8304-K/-**	CP	116.00
			BL, BN	168.20



Lever handles comply with the actuation force limitations of the 2010 ADA Standards for Accessible Design, Section 309 Operable Parts, of the Act.

THE BOLD LOOK
OF **KOHLER**®

RITE-TEMP® PRESSURE-BALANCING VALVE TRIM

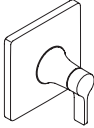
PRODUCT	MODEL NO.	DESCRIPTION	COLOR/FINISH	LIST PRICE
	K-TS28129-4	Venza Rite-Temp Pressure-Balancing Valve Trim Lever handle Trim only, for use with valves: K-8034-K/**	CP	\$ 110.00
			BL, BN	159.50

VENZA TRANSFER/DIVERTER VALVE

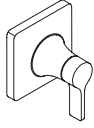
PRODUCT	MODEL NO.	DESCRIPTION	COLOR/FINISH	LIST PRICE
	K-T28130-4	Venza Transfer Valve Trim Lever handle Trim only, for use with valves: K-728-K or K-737-K	CP	\$ 85.00
			BL, BN	123.25



Premier



ANTHEM

Anthem valves and controls represent the evolution of showering. Born from a mission to go beyond industry standards, Anthem mechanical and digital controls enable superior showering performance. From expert engineering and technical exclusivity, new and innovative ways to manipulate flow, temperature, and water have been brought to life. Combined with precision controls, the functional act of showering has become a highly personalized wellbeing experience. Captured in an unexpected aesthetic, Anthem valves and controls represent a milestone in showering design and overall experience.

Max flow rate:
Up to 22 gpm (83 lpm)

MECHANICAL AND DIGITAL THERMOSTATIC VALVES

PRODUCT	MODEL NO.	DESCRIPTION	COLOR/FINISH	LIST PRICE
	K-26339	Anthem One-Outlet Mechanical Thermostatic Valve with Integral Volume Control Service stops with integral filters 3/4" (19 mm) female NPT inlet; 1/2" (13 mm) female NPT outlet Flow rate: Up to 7 gpm (26.5 lpm) maximum flow rate at 45 psi Requires one-outlet thermostatic valve control panel trim	NA	\$ 490.00
	K-26340	Anthem Two-Outlet Mechanical Thermostatic Valve with Integral Volume Control Optional Eco-mode restrictor included, for installation in field, if water conservation or CEC compliance is needed/desired. Restrictor will limit to total flow to 1.75 gpm Service stops with integral filters 3/4" (19 mm) female NPT inlet; 1/2" (13 mm) female NPT outlet Flow rate: Up to 8 gpm (30.3 lpm) @ 45 psi with maximum flow of 7 gpm Requires two-outlet thermostatic valve control panel trim	NA	540.00
	K-26341	Anthem Three-Outlet Mechanical Thermostatic Valve with Integral Volume Control Optional Eco-mode restrictor included, for installation in field, if water conservation or CEC compliance is needed/desired. Restrictor will limit to total flow to 1.75 gpm Service stops with integral filters 3/4" (19 mm) female NPT inlet; 1/2" (13 mm) female NPT outlet Flow rate: Up to 8 gpm (30.3 lpm) @ 45 psi with maximum flow of 7 gpm Requires three-outlet thermostatic valve control panel trim	NA	600.00
	K-26342	Anthem Four-Outlet Mechanical Thermostatic Valve with Integral Volume Control Optional Eco-mode restrictor included, for installation in field, if water conservation or CEC compliance is needed/desired. Restrictor will limit to total flow to 1.75 gpm Service stops with integral filters 3/4" (19 mm) female NPT inlet; 1/2" (13 mm) female NPT outlet Flow rate: Up to 8 gpm (30.3 lpm) @ 45 psi with maximum flow of 7 gpm Requires four-outlet thermostatic valve control panel trim	NA	750.00
	K-28209	Anthem Two-Port Digital Thermostatic Valve Conserve water by enabling built-in eco mode, which limits use to only one outlet at a time Two independently controllable 1/2" (13 mm) outlets; 1/2" (13 mm) inlets both with brass tube connections Flow rate: Up to 12 gpm (45.4 lpm) @ 45 psi with maximum flow of 9.5 gpm (36 lpm) from one outlet Requires Anthem Digital Control	NA	969.00



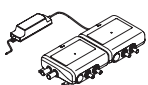
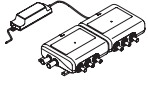

MECHANICAL AND DIGITAL THERMOSTATIC VALVES

Max flow rates:
Up to 22 gpm (83 lpm)

PRODUCT	MODEL NO.	DESCRIPTION	COLOR/FINISH	LIST PRICE
	K-28210	Anthem Three-Port Digital Thermostatic Valve Conserve water by enabling built-in eco mode, which limits use to only one outlet at a time Three independently contro Up to 12 gpm (45.4 lpm) flow rate at 45 psi with maximum flow of 9.5 gpm (36 lpm) from one outlet Requires Anthem Digital Control	NA	\$ 1,680.00
	K-28211	Anthem Four-Port Digital Thermostatic Valve Allows for two different temperature and flow zones in your shower Conserve water by enabling built-in eco mode, which limits use to only one outlet at a time Four independently controllable 1/2" (13 mm) outlets with brass tube connections Up to 22 gpm (83 lpm) flow rate at 45 psi with maximum flow of 9.5 gpm (36 lpm) from one outlet Requires Anthem Digital Control	NA	2,204.00
	K-28212	Anthem Six-Port Digital Thermostatic Valve Allows for two different temperature and flow zones in your shower Conserve water by enabling built-in eco mode, which limits use to only one outlet at a time Six independently controllable 1/2" (13 mm) outlets; 3/4" (19 mm) inlets both with brass tube connections Up to 22 gpm (83 lpm) flow rate at 45 psi with maximum flow of 9.5 gpm (36 lpm) from one outlet Requires Anthem Digital Control	NA	2,587.50

MECHANICAL AND DIGITAL THERMOSTATIC CONTROLS

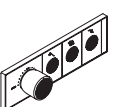
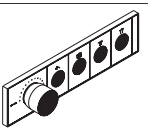
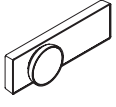
Max flow rate:
Up to 8 gpm (30.3 lpm)

PRODUCT	MODEL NO.	DESCRIPTION	COLOR/FINISH	LIST PRICE
	K-26345-9	Anthem One-Outlet Mechanical Thermostatic Valve Control with recessed push-button Allows you to maintain consistent temperature and flow control Flow rate: up to 7 gpm (26.5 lpm) flow capacity Requires one-port Anthem thermostatic valve with integral volume control	CP	\$ 305.00
			BL, BN 2MB	442.25
	K-26346-9	Anthem Two-Outlet Mechanical Thermostatic Valve Control with recessed push-button Allows you to maintain consistent temperature and flow control Flow rate: up to 8 gpm (30.3 lpm) flow capacity Requires two-port Anthem thermostatic valve with integral volume control	CP	345.00
			BL, BN 2MB	500.25
	K-26347-9	Anthem Three-Outlet Mechanical Thermostatic Valve Control with recessed push-button Allows you to maintain consistent temperature and flow control Flow rate: up to 8 gpm (30.3 lpm) flow capacity Requires three-port Anthem thermostatic valve with integral volume control	CP	375.00
			BL, BN 2MB	543.75
	K-26348-9	Anthem Four-Outlet Mechanical Thermostatic Valve Control with recessed push-button Allows you to maintain consistent temperature and flow control Flow rate: up to 8 gpm (30.3 lpm) flow capacity Requires four-port Anthem thermostatic valve with integral volume control	CP	450.00
			BL, BN 2MB	652.50
	K-28214	Anthem Digital Control One-touch control for temperature, flow, and up to six shower outlets Requires an Anthem digital thermostatic valve	CP	560.00
			BL, BN 2MB	812.00
	K-28213	Anthem Digital Valve Remote Control Auxiliary control for the Anthem digital shower system which pairs with Bluetooth wireless technology Requires an Anthem digital thermostatic valve	CP	134.40
			BL, BN 2MB	194.90

Premier







STATEMENT

At Kohler, we believe every shower is a canvas. And our Statement showering collection is the ultimate palette. Boasting exquisite forms inspired by iconic domestic objects, Statement seamlessly blends into the spaces we inhabit. Defined by unique shapes, sizes, finishes, and designs, Statement stretches our perspective and inspires boundless









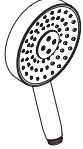

Max flow rates:
2.5 gpm (9.5 lpm), 1.75 gpm (6.6 lpm) or 1.5 gpm (5.7 lpm)

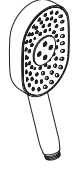
SHOWERHEADS

PRODUCT	MODEL NO.	DESCRIPTION	COLOR/FINISH	LIST PRICE
	K-26290	Statement 2.5 gpm Multifunction Showerhead Oval design Choice of 3 spray options: Catalyst full coverage, deep massage and cloud 1/2" (13 mm) - 14 NPT connection	CP	\$ 180.00
			BL, BN 2MB	261.00
	K-26290-G 	Flow rate: 1.75 gpm (6.6 lpm)	CP	180.00
			BL, BN 2MB	261.00
	K-20999 	Statement VES 1.5 gpm Single-Function Showehead with Variable-Flow Variable-flow lever lets you adjust from 1.5 gpm (5.7 lpm) down to 0.5 gpm (1.9 lpm)	CP	114.10
			BL, BN	165.45

HANDSHOWERS

Max flow rates:
2.5 gpm (9.5 lpm) 1.75 gpm (6.6 lpm) or 1.5 gpm (5.7 lpm)

PRODUCT	MODEL NO.	DESCRIPTION	COLOR/FINISH	LIST PRICE
	K-26282	Statement 2.5 gpm Multifunction Handshower Round design Choice of 3 spray options: Katalyst full coverage, deep massage and cloud G 1/2" (13 mm) inlet connection	CP	\$ 170.00
			BL, BN 2MB	246.50
	K-26282-G 	Flow rate: 1.75 gpm (6.6 lpm)	CP	170.00
			BL, BN 2MB	246.50
	K-26284	Statement 2.5 gpm (9.5 lpm) Multifunction Handshower Oval design Choice of 3 spray options: Katalyst full coverage, deep massage and cloud G 1/2" (13 mm) inlet connection	CP	170.00
			BL, BN 2MB	246.50
	K-26284-G 	Flow rate: 1.75 gpm (6.6 lpm)	CP	170.00
			BL, BN 2MB	246.50
	K-26286	Statement 2.5 gpm (9.5 lpm) Single-Function Handshower Iconic design 1/2" (13 mm) - 14 NPT connection	CP	110.00
			BL, BN 2MB	159.50
	K-26286-G 	Flow rate: 1.75 gpm (6.6 lpm)	CP	110.00
			BL, BN 2MB	159.50
	K-26288	Statement 2.5 gpm Wand Multifunction Handshower Iconic design Choice of 2 spray options: Sweep spray and cloud G 1/2" (13 mm) inlet connection	CP	110.00
			BL, BN 2MB	159.50
	K-26288-G 	Flow rate: 1.75 gpm (9.5 lpm)	CP	110.00
			BL, BN 2MB	159.50
 	K-20998 	Statement VES 1.5 gpm (5.7 lpm) Single-function Handshower with Variable-Flow Katalyst Air-Induction Variable-flow lever lets you adjust from 1.5 gpm (5.7 lpm) down to 0.5 gpm (1.9 lpm)	CP	125.55
			BL, BN	182.05









Hand Held Showers will comply with the Americans with Disabilities Act when installed per the requirements of the 2010 ADA Standards for Accessible Design, Section 309.4 Operation, and (a) Sections 607.6 and 608.6 for Shower Spray Units, (b) Section 607.5 for Bathtub locations, and (c) Sections 608.5.1 and 608.5.3 for Shower locations.

Premier

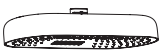

RAINHEADS

Max flow rates:
2.5 gpm (9.5 lpm) 1.75 gpm (6.6 lpm) or 1.5 gpm (5.7 lpm)





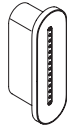

PRODUCT	MODEL NO.	DESCRIPTION	COLOR/ FINISH	LIST PRICE
	K-26301	Statement Round 2.5 gpm (9.51 lpm) Rainhead 9" (228 mm) diameter Full Coverage Rain uses gravity to deliver a soft flow of water, providing a gentle spray experience 1/2" (13 mm) - 14 NPT connection	CP	\$ 650.00
			BL, BN 2MB	942.50
	K-26291	Statement Round 2.5 gpm (9.51 lpm) Rainhead with Katalyst Spray Technology 10" (254 mm) diameter 1/2" (13 mm) - 14 NPT connection	CP	550.00
			BL, BN 2MB	797.50
	K-26291-G	Flow rate: 1.75 gpm (6.6 lpm)	CP	550.00
			BL, BN 2MB	797.50
	K-26292	Statement Round 2.5 gpm (9.51 lpm) Rainhead with Katalyst Spray Technology 12" (305 mm) diameter 1/2" (13 mm) - 14 NPT connection	CP	725.00
			BL, BN 2MB	1,051.25
	K-26293	Statement Oblong 2.5 gpm (9.51 lpm) Rainhead with Katalyst Spray Technology 10" (254 mm) diameter 1/2" (13 mm) - 14 NPT connection	CP	550.00
			BL, BN 2MB	797.50
	K-26293-G	Flow rate: 1.75 gpm (6.6 lpm)	CP	550.00
			BL, BN 2MB	797.50
	K-26294	Statement Oblong 2.5 gpm (9.51 lpm) Rainhead with Katalyst Spray Technology 12" (305 mm) diameter 1/2" (13 mm) - 14 NPT connection	CP	725.00
			BL, BN 2MB	1,051.25
	K-26295	Statement Oblong 2.5 gpm (9.51 lpm) Dual-Function Rainhead with Katalyst Spray Technology 12" (305 mm) diameter Choice of 2 spray options: Katalyst full coverage and deep massage Includes optional diverter to control which function operates on the rainhead. Not required to be used if paired with a valve with multiple outlet control. If using, customer must purchase separate trim for 737-K-NA	CP	900.00
			BL, BN 2MB	1,305.00
	K-26295-G	Flow rate: 1.75 gpm (6.6 lpm)	CP	900.00
			BL, BN 2MB	1,305.00
	K-26297	Statement Oval 2.5 gpm Dual-Function Rainhead with Katalyst Spray Technology 14" (356 mm) diameter Choice of 2 spray options: Katalyst full coverage and deep massage Includes optional diverter to control which function operates on the rainhead. Not required to be used if paired with a valve with multiple outlet control. If using, customer must purchase separate trim for 737-K-NA	CP	1,100.00
			BL, BN 2MB	1,595.00

Max flow rates:
2.5 gpm (9.5 lpm) 1.75 gpm (6.6 lpm) or 1.5 gpm (5.7 lpm)

BODYSPRAYS

PRODUCT	MODEL NO.	DESCRIPTION	COLOR/ FINISH	LIST PRICE
	K-26300	Statement Oblong Vichy 2.5 gpm (9.5 lpm) Single-Control Body Spray 1/2" (13 mm) NPT connection	CP	\$ 350.00
			BL, BN 2MB	507.50
	K-26300-G	Flow rate: 1.75 gpm (6.6 lpm)	CP	350.00
			BL, BN 2MB	507.50
	K-26299	Statement Round 2.5 gpm (9.5 lpm) Adjustable Body Spray Sprayface on semi-recessed ball joint rotates 20° in any direction for targeted hydromassage 1/2" (13 mm) - NPT connection	CP	200.00
			BL, BN 2MB	290.00
	K-26299-G	Flow rate: 1.75 gpm (6.6 lpm)	CP	200.00
			BL, BN 2MB	290.00

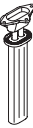
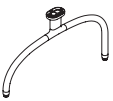
SHOWERARMS

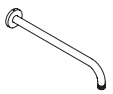
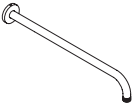

PRODUCT	MODEL NO.	DESCRIPTION	COLOR/ FINISH	LIST PRICE
	K-26319	Statement 3" Ceiling-Mount Rainhead Arm and Flange 3" (76 mm) straight shower arm 1/2" (13 mm) - 14 NPT connection Compatible only with single-function rainheads	CP	\$ 70.00
			BL, BN 2MB	101.50
	K-26320	Statement 6" Ceiling-Mount Rainhead Arm and Flange 6" (152 mm) shower arm 1/2" (13 mm) - 14 NPT connection Compatible only with single-function rainheads	CP	115.00
			BL, BN 2MB	166.75
	K-26321	Statement 12" Ceiling-Mount Rainhead Arm and Flange 12" (305 mm) straight shower arm 1/2" (13 mm) - 14 NPT connection Compatible only with single-function rainheads	CP	120.00
			BL, BN 2MB	174.00
	K-26325	Statement 5" Ceiling-Mount Rainhead Arm and Flange 5" (127 mm) rainhead arm Slip-fit connection Compatible with two dual-function rainheads	CP	200.00
			BL, BN 2MB	290.00
	K-26326	Statement 10" Ceiling-Mount Rainhead Arm and Flange 10" (254 mm) rainhead arm 1/2" (13 mm) - 14 NPT connection Compatible with two dual-function rainheads	CP	225.00
			BL, BN 2MB	326.25
	K-26305	Statement Ceiling-Mount Dual Showerarm and Flange 14-1/2" x 22" (370.5 x 563 mm) arched dual shower arm 1/2" (13 mm) - 14 NPT connection Compatible with two single-function rainheads or a single-function rainhead and a wand handshower with hose Arms can operate individually or together at the same time	CP	800.00
			BL, BN 2MB	1,160.00
	K-26318	Statement Wall-Mount Showerarm and Flange 6" (165 mm) reach 1/2" (13 mm) - 14 NPT connection	CP	150.00
			BL, BN 2MB	217.50
	K-26322	Statement Wall-Mount Showerarm and Flange 15-1/2" (394 mm) reach 1/2" (13 mm) - 14 NPT connection	CP	130.00
			BL, BN 2MB	188.50
	K-26307	Statement Wall-Mount Showerarm and Flange 19" (483 mm) reach 1/2" (13 mm) - 14 NPT connection	CP	140.00
			BL, BN 2MB	203.00

Premier





WALL-MOUNT HANDSHOWER BRACKET

PRODUCT	MODEL NO.	DESCRIPTION	COLOR/FINISH	LIST PRICE
	K-26309	Statement Adjustable Wall-Mount Bracket Bracket pivots and rotates to position handshower at desired angle	CP	\$ 90.00
			BL, BN 2MB	130.50





WALL-MOUNT HANDSHOWER SUPPLY ELBOWS

PRODUCT	MODEL NO.	DESCRIPTION	COLOR/FINISH	LIST PRICE
	K-26310	Allows handshower hose to be mounted nearly to the wall Includes check valve for backflow prevention Slip-fit connection	CP	\$ 140.00
			BL, BN 2MB	203.00
	K-21051	Statement VES Wall-Mount Supply Elbow Magnetic docking connection allows for handshower height adjustment of 2" (51 mm) and spray angle tilt of 24-58° Includes check valve for backflow prevention 1/2" (13 mm) - 14 NPT connection Requires Statement VES single-function handshower and hose	CP	228.20
			BL, BN	330.90

SHOWER HOSE

PRODUCT	MODEL NO.	DESCRIPTION	COLOR/FINISH	LIST PRICE
	K-21049-V0	Statement 60" (1524 mm) Smooth Shower Hose Swivel base	CP	\$ 91.30
			BL, BN	132.40
	K-21050-V0	Statement 72" (1829 mm) Smooth Shower Hose Swivel base	CP	106.70
			BL, BN	154.75
 	K-26311	Statement Shower Hose Adapter G 1/2" (13 mm) inlet and outlet ADA-compliant nonpositive shutoff	CP	20.00
			BL, BN 2MB	29.00

SLIDEBARS

PRODUCT	MODEL NO.	DESCRIPTION	COLOR/ FINISH	LIST PRICE
	K-26312	Statement 30-1/2" (774 mm) Shower Slidebar Metal construction	CP	\$ 200.00
			BL, BN 2MB	290.00
	K-26313	Statement 39" (991 mm) Shower Slidebar Metal construction	CP	240.00
			BL, BN 2MB	348.00
	K-26314	Statement 31-1/2" (811 mm) Shower Slidebar with Integrated Water Supply Metal construction Integrated water supply allows water to be plumbed directly through bottom bracket of slidebar and eliminates the need for a separate supply Adjustable mounting brackets	CP	240.00
			BL, BN 2MB	348.00
	K-26317	Statement Slidebar Shelf 4-1/4" x 8-1/16" x 1-5/16" (108 x 205 x 33 mm) oblong shelf with rim Fits most KOHLER® slidebars with integrated water supply as well as stand-alone supply elbows Center drain slot prevents water pooling	CP	60.00
			BL, BN 2MB	87.00

HANDSHOWER KITS

Max flow rates:
2.5 gpm (9.5 lpm) or 1.75 gpm (6.6 lpm)

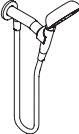
PRODUCT	MODEL NO.	DESCRIPTION	COLOR/ FINISH	LIST PRICE
	K-21026	Statement VES HydroRail-S Shower Column Kit Includes K-20999 Statement VES showerhead, K-20998 Statement VES handshower, K-45906 HydroRail-S shower column, K-21049 Statement 60" (1524 mm) handshower hose Flow rate: 1.5 gpm (6.6 lpm)	CP	\$ 741.65
			BL, BN	1,075.40
	K-21048	Statement VES Handshower Kit Includes K-20998 Statement VES handshower, K-21051 Statement VES wall-mount handshower holder and supply elbow, and K-21049 Statement 60" (1524 mm) handshower hose Flow rate: 1.5 gpm (6.6 lpm)	CP	410.80
			BL, BN	595.70

SHOWER ACCESORIES

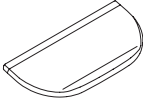
PRODUCT	MODEL NO.	DESCRIPTION	COLOR/ FINISH	LIST PRICE
	K-26306	Statement Foot Ledge 5" x 11-3/4" x 3-1/4" (127 x 300 x 83 mm) angled half-moon ledge with rim Wall-mount shower only installation	CP	\$ 100.00
			BL, BN 2MB	145.00



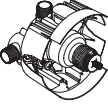
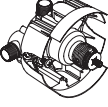
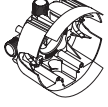
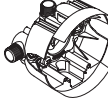
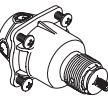

Competitive

VALVE BODIES AND CARTRIDGES

PRODUCT	MODEL NO.	DESCRIPTION	COLOR/FINISH	LIST PRICE
Rite-Temp Thermostatic Valve and Cartridge Kit Kits include rough-in body and cartridge Rite-Temp thermostatic valves feature temperature control				
	K-28304-K	Universal NPT and direct sweat connections	NA	\$ 265.75
	K-P28304-K	Project pack, twelve per case, price each	NA	252.45
	K-28304-KS	Universal NPT and direct sweat connections Service stops, supplied, installed	NA	293.50
	K-P28304-KS	Project pack, twelve per case, price each	NA	278.85
	K-28304-KSL	Universal NPT and direct sweat connections Service stops, supplied, not installed	NA	293.50
	K-P28304-KSL	Project pack, twelve per case, price each	NA	278.85
	8300-KS	Universal NPT and direct sweat connections Service stops, installed	NA	98.15
	P8300-KS	Project pack, twelve per case, price each	NA	94.10
	8300-KSL	Universal NPT and direct sweat connections Service stops supplied, not installed	NA	98.15
	P8300-KSL	Project pack, twelve per case, price each	NA	94.10
Rite-Temp Thermostatic Rite-Temp thermostatic valves feature temperature control				
	K-28305	Includes mud guard	NA	204.95
	K-P28305	Project pack, twelve per case, price each	NA	194.70

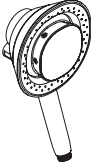



HANDSHOWERS

Max flow rate:
2.5 gpm (9.5 lpm) or 1.75 gpm (6.6 lpm)



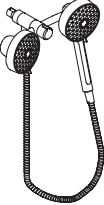

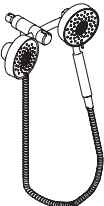

PRODUCT	MODEL NO.	DESCRIPTION	COLOR/FINISH	LIST PRICE	
	K-28241-NKA	Moxie 2.5 gpm (9.5 lpm) Single-Function Handshower and Wireless Speaker with Amazon Alexa Built in Amazon Alexa technology for hands-free voice activation Bluetooth connectivity for streaming of audio input Rechargeable speaker magnetically secures in showerhead Includes handshower, wireless speaker, charging dock, charging cable Full coverage spray produces an encompassing spray 1/2" (13 mm) NPT connection	CP	\$ 249.00	
			BL, BN	361.05	
		K-28241-GKA	Flow rate: 1.75 gpm (6.6 lpm)	CP	249.00
				BL, BN	361.05
	K-28241-NKE	Moxie 2.5 gpm (9.5 lpm) Single-Function Handshower and Wireless Speaker with Bluetooth Featuring Bluetooth connectivity for streaming of audio input Rechargeable speaker magnetically secures in showerhead Includes handshower, wireless speaker, charging dock, charging cable Full coverage spray produces an encompassing spray 1/2" (13 mm) NPT connection	CP	229.00	
			BL, BN	332.05	
		K-28241-GKE	Flow rate: 1.75 gpm (6.6 lpm)	CP	229.00
				BL, BN	332.05

SHOWERHEAD AND HANDSHOWER COMBOS

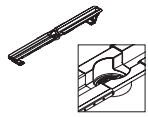
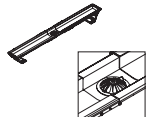
Max flow rate:
2.5 gpm (9.5 lpm) or 1.75 gpm (6.6 lpm)

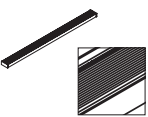
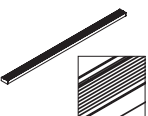
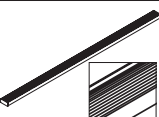



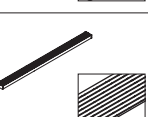
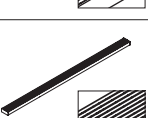

PRODUCT	MODEL NO.	DESCRIPTION	COLOR/FINISH	LIST PRICE	
	K-23218	Awaken® 2.5 gpm (9.5 lpm) Multifunction 2-IN-1 Combo Kit Choice of 3 spray options: wide coverage, intense drenching and targeted spray Pause feature temporarily pauses water flow to conserve water Includes: Shower head, handheld shower head, 60" (1524 mm) metal hose 1/2" (13 mm) NPT connection	CP	\$ 206.55	
			BL, BN 2BZ	299.50	
		K-23218-G	Flow rate: 1.75 gpm (6.6 lpm)	CP	206.55
				BL, BN 2BZ	299.50
	K-23219	Purist® 2.5 gpm Multifunction 2-IN-1 Combo Kit Choice of 3 spray options: full coverage, pulsating massage and silk spray Pause feature temporarily pauses water flow to conserve water Includes: Shower head, handheld shower head, 60" (1524 mm) metal hose 1/2" (13 mm) NPT connection	CP	369.70	
			BL, BN 2MB, BV SN	536.10	
			TT	591.55	
		K-23219-G	Flow rate: 1.75 gpm (6.6 lpm)	CP	369.70
BL, BN 2MB, BV SN				536.10	
			TT	591.55	

LINEAR DRAIN CHANNELS AND GRATES

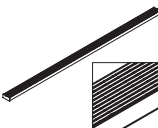
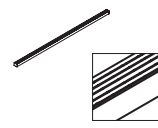
PRODUCT	MODEL NO.	DESCRIPTION	COLOR/ FINISH	LIST PRICE
	K-32619	Linear Drain Channel 1-1/4" x 36" - 60" length (32 x 946 x 1556 mm) Extend channel length for easier specification and precise wall-to-wall installation Requires KOHLER® 1-1/4" x 36", 1-1/4" x 48", or 1-1/4" x 60" linear drain grate	NA	\$ 430.00
	K-80646	Linear Drain Channel 2-1/2" x 36" - 60" length (70 x 946 x 1556 mm) Extend channel length for easier specification and precise wall-to-wall installation Requires KOHLER 2-1/2" x 36", 2-1/2" x 48", or 2-1/2" x 60" linear drain grate	NA	401.65
	K-28987	Linear Drain Adapter Side-outlet Fits K-80646 and K-32619 adjustable linear drain channels	NA	131.90
	K-80647	Linear Drain Grate with Tile-In Panel Easily field-trimmable to fit any showering space Includes universal hardware kit with mounting feet in two lengths, stainless steel lift key, and KOHLER grate end caps 2-1/2" x 36" (65 x 914 mm) anodized aluminum Requires K-80646 KOHLER 2-1/2" (64 mm) linear drain channel	SH	460.55
			BL, BNK	621.75
			2MB	667.80
	K-80648	Linear Drain Grate with Tile-In Panel Easily field-trimmable to fit any showering space Includes universal hardware kit with mounting feet in two lengths, stainless steel lift key, and KOHLER grate end caps 2-1/2" x 48" (65 x 1219 mm) anodized aluminum Requires K-80646 KOHLER 2-1/2" (64 mm) linear drain channel	SH	653.35
			BL, BNK	882.05
			2MB	947.40
	K-80649	Linear Drain Grate with Tile-In Panel Easily field-trimmable to fit any showering space Includes universal hardware kit with mounting feet in two lengths, stainless steel lift key, and KOHLER grate end caps 2-1/2" x 60" (65 x 1524 mm) anodized aluminum Requires K-80646 KOHLER 2-1/2" (64 mm) linear drain channel	SH	846.10
			BL, BNK	1,142.25
			2MB	1,226.85
	K-80650	Linear Drain Grate with Tile-In Panel Easily field-trimmable to fit any showering space Includes universal hardware kit with mounting feet in two lengths, stainless steel lift key, and KOHLER grate end caps 1-1/4" x 36" (35 x 914 mm) anodized aluminum Requires K-32619 KOHLER 1-1/4" (32 mm) linear drain channel	SH	299.90
			BL, BNK	404.90
			2MB	434.90
	K-80651	Linear Drain Grate with Tile-In Panel Easily field-trimmable to fit any showering space Includes universal hardware kit with mounting feet in two lengths, stainless steel lift key, and KOHLER grate end caps 1-1/4" x 48" (35 x 1219 mm) anodized aluminum Requires K-32619 KOHLER 1-1/4" (32 mm) linear drain channel	SH	492.70
			BL, BNK	665.15
			2MB	714.45
	K-80652	Linear Drain Grate with Tile-In Panel Easily field-trimmable to fit any showering space Includes universal hardware kit with mounting feet in two lengths, stainless steel lift key, and KOHLER grate end caps 1-1/4" x 60" (35 x 1524 mm) anodized aluminum Requires K-32619 KOHLER 1-1/4" (32 mm) linear drain channel	SH	685.45
			BL, BNK	925.40
			2MB	993.95
	K-80653	Linear Drain Grate with Lattice Pattern Easily field-trimmable to fit any showering space Includes universal hardware kit with mounting feet in two lengths, stainless steel lift key, and KOHLER grate end caps 2-1/2" x 36" (65 x 914 mm) anodized aluminum Requires K-80646 KOHLER 2-1/2" (64 mm) linear drain channel	SH	589.05
			BL, BNK	795.25
			2MB	854.15
	K-80654	Linear Drain Grate with Lattice Pattern Easily field-trimmable to fit any showering space Includes universal hardware kit with mounting feet in two lengths, stainless steel lift key, and KOHLER grate end caps 2-1/2" x 48" (65 x 1219 mm) anodized aluminum Requires K-80646 KOHLER 2-1/2" (64 mm) linear drain channel	SH	781.85
			BL, BNK	1,055.50
			2MB	1,133.70

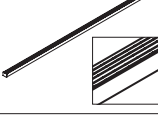
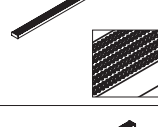
NOTE: Please consult specification sheets for exact dimensions.

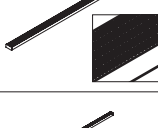
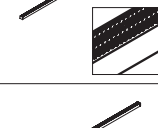
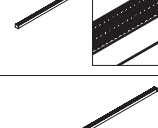
LINEAR DRAIN CHANNELS AND GRATES (CONTINUED)

PRODUCT	MODEL NO.	DESCRIPTION	COLOR/ FINISH	LIST PRICE
	K-80655	Linear Drain Grate with Lattice Pattern Easily field-trimmable to fit any showering space Includes universal hardware kit with mounting feet in two lengths, stainless steel lift key, and KOHLER grate end caps 2-1/2" x 60" (65 x 1524 mm) anodized aluminum Requires K-80646 KOHLER® 2-1/2" linear drain channel	SH	\$ 974.65
			BL, BNK	1,315.80
			2MB	1,413.25
	K-80656	Linear Drain Grate with Lattice Pattern Easily field-trimmable to fit any showering space Includes universal hardware kit with mounting feet in two lengths, stainless steel lift key, and KOHLER grate end caps 1-1/4" x 36" (35 x 914 mm) anodized aluminum Requires K-32619 KOHLER 1-1/4" linear drain channel	SH	428.40
			BL, BNK	578.35
			2MB	621.20
	K-80657	Linear Drain Grate with Lattice Pattern Easily field-trimmable to fit any showering space Includes universal hardware kit with mounting feet in two lengths, stainless steel lift key, and KOHLER grate end caps 1-1/4" x 48" (35 mm x 1219 mm) anodized aluminum Requires K-32619 KOHLER 1-1/4" linear drain channel	SH	621.20
			BL, BNK	838.65
			2MB	900.75
	K-80658	Linear Drain Grate with Lattice Pattern Easily field-trimmable to fit any showering space Includes universal hardware kit with mounting feet in two lengths, stainless steel lift key, and KOHLER grate end caps 1-1/4" x 60" (35 x 1524 mm) anodized aluminum Requires K-32619 KOHLER 1-1/4" linear drain channel	SH	814.00
			BL, BNK	1,098.90
			2MB	1,180.30
	K-80659	Linear Drain Grate with Perforated Pattern Easily field-trimmable to fit any showering space Includes universal hardware kit with mounting feet in two lengths, stainless steel lift key, and KOHLER grate end caps 2-1/2" x 36" (65 x 914 mm) anodized aluminum Requires K-80646 KOHLER 2-1/2" linear drain channel	SH	589.05
			BL, BNK	795.25
			2MB	854.15
	K-80660	Linear Drain Grate with Perforated Pattern Easily field-trimmable to fit any showering space Includes universal hardware kit with mounting feet in two lengths, stainless steel lift key, and KOHLER grate end caps 2-1/2" x 48" (65 x 1219 mm) anodized aluminum Requires K-80646 KOHLER 2-1/2" linear drain channel	SH	781.85
			BL, BNK	1,055.50
			2MB	1,133.70
	K-80661	Linear Drain Grate with Perforated Pattern Easily field-trimmable to fit any showering space Includes universal hardware kit with mounting feet in two lengths, stainless steel lift key, and KOHLER grate end caps 2-1/2" x 60" (65 x 1524 mm) anodized aluminum Requires K-80646 KOHLER 2-1/2" linear drain channel	SH	974.65
			BL, BNK	1,315.80
			2MB	1,413.25
	K-80662	Linear Drain Grate with Perforated Pattern Easily field-trimmable to fit any showering space Includes universal hardware kit with mounting feet in two lengths, stainless steel lift key, and KOHLER grate end caps 1-1/4" x 36" (35 x 914 mm) anodized aluminum Requires K-32619 KOHLER 1-1/4" linear drain channel	SH	428.40
			BL, BNK	578.35
			2MB	621.20
	K-80663	Linear Drain Grate with Perforated Pattern Easily field-trimmable to fit any showering space Includes universal hardware kit with mounting feet in two lengths, stainless steel lift key, and KOHLER grate end caps 1-1/4" x 48" (35 x 1219 mm) anodized aluminum Requires K-32619 KOHLER 1-1/4" linear drain channel	SH	621.20
			BL, BNK	838.65
			2MB	900.75
	K-80664	Linear Drain Grate with Perforated Pattern Easily field-trimmable to fit any showering space Includes universal hardware kit with mounting feet in two lengths, stainless steel lift key, and KOHLER grate end caps 1-1/4" x 60" (35 x 1524 mm) anodized aluminum Requires K-32619 KOHLER 1-1/4" linear drain channel	SH	814.00
			BL, BNK	1,098.90
			2MB	1,180.30

NOTE: Please consult specification sheets for exact dimensions.

Competitive

Max flow rate:
1.5 gpm (5.7 lpm)

PULL-OUT SPRAY KITCHEN SINK FAUCET

PRODUCT	MODEL NO.	DESCRIPTION	COLOR/FINISH	LIST PRICE
Spout Height A = Finished Surface to Highest Faucet Point Spout Height B = Finished Surface to Aerator				
	K-30612	Jolt Single-Handle Pull-Out Spray Kitchen Sink Faucet Two-function pull-out sprayhead with touch-control that allows you to switch between aerated stream and spray ProMotion® technology's light, quiet braided hose and ball-joint and MasterClean™ spraygate Swing spout: 8-3/4" (222 mm) reach 8-13/16" (224 mm) Spout height A 5-1/2" (140 mm) Spout height B (base to outlet) Lever handle Flexible supplies 10-1/8" (257mm) escutcheon plate for three-hole installation	CP	\$ 225.00
			vs	281.25

Max flow rate:
1.5 gpm (5.7 lpm)

SINGLE-HANDLE PRIMARY KITCHEN SINK FAUCET

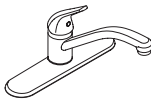
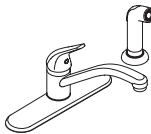
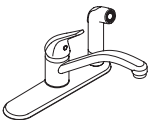
PRODUCT	MODEL NO.	DESCRIPTION	COLOR/FINISH	LIST PRICE
Spout Height A = Finished Surface to Highest Faucet Point Spout Height B = Finished Surface to Aerator				
	K-30613	Jolt Single-Handle Kitchen Sink Faucet Ceramic disc valves Swing spout: 8-1/2" (216 mm) reach 6-1/2" (165 mm) Spout height A 5-1/2" (140 mm) Spout height B (base to outlet) Aerated flow Lever handle Flexible supplies Escutcheon plate, single-hole installation 10-1/8" (257mm) escutcheon plate for single-hole installation	CP	\$ 145.00
			vs	181.25
	K-30614	Jolt Single-Handle Kitchen Sink Faucet with Sidespray Ceramic disc valves Swing spout: 8-1/2" (216 mm) reach 6-1/2" (165 mm) Spout height A 5-1/2" (140 mm) Spout height B (base to outlet) Aerated flow Lever handle Flexible supplies Escutcheon plate, two-hole installation Matching finish sidespray 10-1/8" (257mm) escutcheon plate for two-hole installation	cp	180.00
			vs	225.00
	K-30615	Jolt Single-Handle Kitchen Sink Faucet with Sidespray Ceramic disc valves Swing spout: 8-1/2" (216 mm) reach 6-1/2" (165 mm) Spout height A 5-1/2" (140 mm) Spout height B (base to outlet) Aerated flow Lever handle Flexible supplies Escutcheon plate, two-hole installation Matching finish sidespray through escutcheon 10-1/8" (257mm) escutcheon plate for two-hole installation	cp	180.00

Max flow rate:
1.5 gpm (5.7 lpm)

TWO-HANDLE KITCHEN SINK FAUCET WITH SIDESPRAY

PRODUCT	MODEL NO.	DESCRIPTION	COLOR/FINISH	LIST PRICE
Spout Height A = Finished Surface to Highest Faucet Point Spout Height B = Finished Surface to Aerator				
	K-30616	Jolt Two-Handle Kitchen Sink Faucet with Sidespray Ceramic disc valves Swing spout: 8-9/16" (217 mm) reach 5-7/8" (149 mm) Spout height A 4-13/16" (122 mm) Spout height B (base to outlet) Aerated flow Lever handle Flexible supplies Escutcheon plate, four-hole installation Matching finish sidespray 10-1/8" (257mm) escutcheon plate for four-hole installation	CP	\$ 180.00





Lever handles comply with the actuation force limitations of the 2010 ADA Standards for Accessible Design, Section 309 Operable Parts, of the Act.

THE BOLD LOOK
OF KOHLER.

TWO-HANDLE LAUNDRY AND BAR FAUCET

Max flow rates:
 (K-30617): 1.5 gpm (5.7 lpm)
 (K-30618/19): 4.0 gpm (15.1 lpm)

PRODUCT	MODEL NO.	DESCRIPTION	COLOR/FINISH	LIST PRICE
Spout Height A = Finished Surface to Highest Faucet Point Spout Height B = Finished Surface to Aerator				
	K-30617	Jolt Two-Handle Bar Sink Faucet Ceramic disc valves Gooseneck spout: 5" (127 mm) reach 11-5/16" (287 mm) Spout height A 7-7/8" (200 mm) Spout height B (base to outlet) Lever handles For 4" (102 mm) centers	CP	\$ 115.00
	K-30618	Jolt Two-Handle Laundry Sink Faucet Ceramic disc valve Swing spout: 7" (178 mm) reach 4-3/4" (121 mm) Spout height A 2-1/2" (64 mm) Spout height B (base to outlet) Lever handles For 4" (102 mm) centers Flow rate: 4.0 gpm (15.1 lpm) minimum @ 20 psi	CP	85.00
	K-30619	Jolt Two-Handle Laundry Sink Faucet Ceramic disc valves Threaded swing spout: 7" (178 mm) reach 4-3/4" (121 mm) Spout height A 2-1/2" (64 mm) Spout height B (base to outlet) Lever handles For 4" (102 mm) centers Flow rate: 4.0 gpm (15.1 lpm) minimum @ 20 psi	CP	85.00



Competitive

UNDERCOUNTER SMART HOME WATER MONITOR

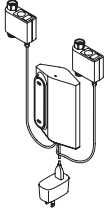
PRODUCT	MODEL NO.	DESCRIPTION	COLOR/FINISH	LIST PRICE
	K-33603	<p>H2Wise Undercounter Smart Home Water Monitor High-definition pressure sensors analyze your home's water usage and measure changes 240 times per second, quickly detecting leaks Compatible with 3/8" (9.5 mm) threaded hot and cold water supply angle stops; adapter required for other sizes (sold separately)</p> <p>Includes H2Wise device, pressure sensors, USB power adapter, and mounting hardware</p> <p>Requires Wi-Fi and an unswitched power outlet under sink</p>	NA	\$400.0

+SMART HOME WATER MONITOR AND AUTOMATIC SHUTOFF VALVE



PRODUCT	MODEL NO.	DESCRIPTION	COLOR/FINISH	LIST PRICE
	K-33604	<p>H2Wise +Smart Home Water Monitor and Automatic Shutoff Valve Fixed ultrasonic flow meter and high-definition pressure sensors analyze your home's water usage and measure changes 240 times per second, quickly detecting leaks Compatible with plumbing up to 1-1/4" (25.4 mm) Requires two 3/4" (19 mm) water meter couplings (sold separately)</p> <p>Includes H2Wise+ device and 12' (3657 mm) power cord</p> <p>Requires Wi-Fi and AC power</p>	NA	\$666.70

COMPONENTS® FLOOR-MOUNT BATH FILLER TRIM

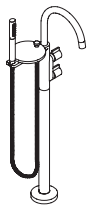
Max flow rates:
 (Bath Faucet): 8.0 gpm (30.3 lpm)
 (Handshower): 1.75 gpm (6.6 lpm)

PRODUCT	MODEL NO.	DESCRIPTION	COLOR/FINISH	LIST PRICE
	K-T77984-4	Components Floor-Mount Bath Filler Trim Spout reach: 9-5/8" (244 mm) (inlet to outlet) Spout height: 36-7/8" (937 mm) max. (base to outlet) Total spout height: 42-9/16" (1081 mm) max. Two handles offer separate control of hot and cold water Includes Shift+® Round 1.75 gpm multifunction handshower, aerator, hardware kit and escutcheon Trim only, for use with: K-97339 mounting block	2MB	\$ 2,889.95
	K-T77984-9	Components Floor-Mount Bath Filler Trim Spout reach: 9-5/8" (244 mm) (inlet to outlet) Spout height: 36-7/8" (937 mm) max. (base to outlet) Total spout height: 42-9/16" (1081 mm) max. Two handles offer separate control of hot and cold water Includes Shift+® Round 1.75 gpm multifunction handshower, aerator, hardware kit and escutcheon Trim only, for use with: K-97339 mounting block	2MB	3,179.00

ARTIFACTS® WIDESPREAD BATHROOM SINK FAUCET HANDLES

PRODUCT	MODEL NO.	DESCRIPTION	COLOR/FINISH	LIST PRICE
	K-98068-6NRO	Artifacts Sink Faucet T-Handles Nero Marquina marble handle Coordinate with your choice of Artifacts spout for a personalized design	CP	\$ 891.65
			BN, SN	1,203.75
			BV, 2MB	1,292.90
	K-98068-6HWL	Artifacts Sink Faucet T-Handles Howlite marble handles Coordinate with your choice of Artifacts spout for a personalized design	CP	1,089.70
			BN, SN	1,471.10
			BV, 2MB	1,580.10

FINISH GUIDE





- CP — Polished Chrome
- BN — Vibrant Brushed Nickel
- BV — Vibrant Brushed Bronze
- SN — Vibrant Polished Nickel
- 2BZ — Oil-Rubbed Bronze
- 2MB — Vibrant Brushed Moderne Brass







Competitive

Max flow rates:
1.2 gpm (4.5 lpm), 1.0 gpm (3.8 lpm) or 0.5 gpm (1.9 lpm)





SINGLE-HANDLE BATHROOM SINK FAUCET

PRODUCT	MODEL NO.	DESCRIPTION	COLOR/FINISH	LIST PRICE
	 K-97345-4	Avid Single-Handle Bathroom Sink Faucet Spout reach: 5-7/8" (149 mm) Spout height: 3-1/2" (89 mm) (base to outlet) Aerated flow, 1.2 gpm (4.5 lpm) Lever handle Flexible supplies Pop-up drain with 1-1/4" (32 mm) tailpiece For single-hole installation	2MB	\$ 729.25
	 K-97345-4K	Flow rate: 1.0 gpm (3.8 lpm)	2MB	729.25
	 K-97345-4N	Flow rate: 0.5 gpm (1.9 lpm)	2MB	729.25

PRODUCT	MODEL NO.	DESCRIPTION	COLOR/FINISH	LIST PRICE
	 K-97347-4	Avid Tall Single-Handle Bathroom Sink Faucet Spout reach: 5-13/16" (148 mm) Spout height: 8" (203 mm) (base to outlet) Aerated flow, 1.2 gpm (4.5 lpm) Lever handle Flexible supplies Touch activated drain with 1-1/4" (32 mm) tailpiece For single-hole installation	2MB	\$ 1,048.35
	 K-97347-4K	Flow rate: 1.0 gpm (3.8 lpm)	2MB	1,048.35
	 K-97347-4N	Flow rate: 0.5 gpm (1.9 lpm)	2MB	1,022.00

Max flow rates:
1.2 gpm (4.5 lpm), 1.0 gpm (3.8 lpm) or 0.5 gpm (1.9 lpm)

WIDESPREAD BATHROOM SINK FAUCET

PRODUCT	MODEL NO.	DESCRIPTION	COLOR/FINISH	LIST PRICE
	 K-97352-4	Avid Widespread Bathroom Sink Faucet Spout reach: 5-13/16" (148 mm) Spout height: 4-1/4" (108 mm) (base to outlet) Aerated flow, 1.2 gpm (4.5 lpm) Lever handles Flexible supplies Touch activated drain with 1-1/4" (32 mm) tailpiece For 8" to 16" centers (203 mm to 406 mm)	2MB	\$ 941.95
	 K-97352-4K	Flow rate: 1.0 gpm (3.8 lpm)	2MB	941.95
	 K-97352-4N	Flow rate: 0.5 gpm (1.9 lpm)	2MB	941.95





Lever handles comply with the actuation force limitations of the 2010 ADA Standards for Accessible Design, Section 309 Operable Parts, of the Act.

THE BOLD LOOK
OF **KOHLER**

WALL-MOUNT BATHROOM SINK FAUCET

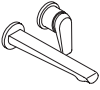
Max flow rate: 1.2 gpm (4.5 lpm)



PRODUCT	MODEL NO.	DESCRIPTION	COLOR/FINISH	LIST PRICE
	K-97358-4 	Avid Single-Handle Wall-Mount Bathroom Sink Faucet Spout reach: 8-1/4" (203 mm) Aerated flow Lever handle Valve included	2MB	\$1,244.00

BATH AND SHOWER VALVE TRIM

PRODUCT	MODEL NO.	DESCRIPTION	COLOR/FINISH	LIST PRICE
	K-T97019-4 Order valve separately	Avid Rite-Temp Pressure-Balancing Valve Trim with Push-Button Diverter Lever handle Trim only, for use with valves: K-11748-K/KS	2MB	\$ 399.80

PRODUCT	MODEL NO.	DESCRIPTION	COLOR/FINISH	LIST PRICE
	K-TS97018-4 Order valve separately	Avid Rite-Temp Pressure-Balancing Valve Trim Lever handle Trim only, for use with valves: K-8304-K/LS, K-2971-KS or K-8300-K/LS with K-8305-NA	2MB	\$ 399.80

THERMOSTATIC, VOLUME CONTROL AND TRANSFER/DIVERTER VALVE TRIM

PRODUCT	MODEL NO.	DESCRIPTION	COLOR/FINISH	LIST PRICE
	K-T97022-4 Order valve separately	Lever handle Trim only, for use with valves: K-2975-KS, K-2972-KS	2MB	\$ 442.20
	K-T97025-4 Order valve separately	Avid Volume Control Valve Trim Lever handle Trim only, for use with valves: K-2977-K, K-2974-K	2MB	204.20

PRODUCT	MODEL NO.	DESCRIPTION	COLOR/FINISH	LIST PRICE
	K-T97026-4 Order valve separately	Avid Transfer/Diverter Valve Trim Lever handle Trim only, for use with valves: K-728-K, K-737-K	2MB	\$ 255.15



Competitive

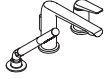

Max flow rates:
 (Bath Faucet): 8 gpm (30.3 lpm)
 (Handshower): 1.75 gpm (6.6 lpm)

DECK-MOUNT BATH

PRODUCT	MODEL NO.	DESCRIPTION	COLOR/FINISH	LIST PRICE
	K-97360-4	Avid Deck-Mount Bath Faucet with Handshower Diverter spout; Spout reach: 7-13/16" (198 mm) (inlet to outlet) Spout height: 6" (152 mm) (base to outlet) Single-control remote lever handle Shift+® Ellipse multifunction handshower Valve included	2MB	\$ 1,510.65

Max flow rates:
 (Bath Filler): 7.5 gpm (28.4 lpm)
 (Handshower): 1.75 gpm (6.6 lpm)

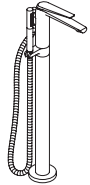





FLOOR-MOUNT BATH FILLERS





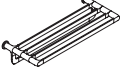

PRODUCT	MODEL NO.	DESCRIPTION	COLOR/FINISH	LIST PRICE
	K-T97367-4  Order mountain block separately	Avid Floor-Mount Bath Filler Trim with Handshower Spout reach: 8-5/8" (219 mm) (inlet to outlet) Spout height: 34-7/16" (875 mm) max. (base to outlet) Total spout height: 36-5/8" (930 mm) max. Single-handle actuation Integral valve Includes Shift+® Ellipse multifunction handshower, aerator, hardware kit and escutcheon Trim only, for use with: K-97342 mounting block	2MB	\$ 2,899.10

WALL-MOUNT SPOUTS

PRODUCT	MODEL NO.	DESCRIPTION	COLOR/FINISH	LIST PRICE
	K-97021	Avid Wall-Mount Non-Diverter Bath Spout Spout reach: 7-3/16" (198 mm) 1/2" (13 mm) NPT or slip-fit connection	2MB	\$ 364.70

ACCESSORIES

PRODUCT	MODEL NO.	DESCRIPTION	COLOR/FINISH	LIST PRICE
	K-97494	Avid 18" (457 mm) Towel Bar 19-3/4" x 2-3/4" x 1-13/16" (502 mm x 70 mm x 46 mm)	2MB	\$ 249.00
	K-97495	Avid 24" (610 mm) Towel Bar 25-13/16" x 2-3/4" x 1-13/16" (656 mm x 70 mm x 46 mm)	2MB	266.75
	K-97027	Avid 30" (762 mm) Towel Bar 31-13/16" x 2-3/4" x 1-13/16" (808 mm x 70 mm x 46 mm)	2MB	355.55
	K-97496	Avid 24" (610 mm) Double Towel Bar 25-13/16" x 5-1/4" x 1-13/16" (656 mm x 133 mm x 46 mm)	2MB	373.40
	K-97497	Avid Hotelier 25-13/16" x 10-3/16" x 3-13/16" (656 mm x 259 mm x 97 mm)	2MB	577.85
	K-97498	Avid Towel Arm 9-15/16" x 2-3/4" x 1-13/16" (252 mm x 70 mm x 46 mm)	2MB	231.15



PRODUCT	MODEL NO.	DESCRIPTION	COLOR/FINISH	LIST PRICE
	K-97499	Avid Robe Hook 1-13/16" x 1-7/8" x 2-11/16" (46 mm x 48 mm x 68 mm)	2MB	\$ 106.75
	K-97500	Avid Double Robe Hook 4-3/4" x 1-7/8" x 2-11/16" (121 mm x 48 mm x 68 mm)	2MB	128.05
	K-97502	Avid Vertical Toilet Tissue Holder 1-13/16" x 5-1/16" x 5-3/4" (46 mm x 129 mm x 146 mm)	2MB	204.55
	K-97503	Avid Covered Toilet Tissue Holder 5-5/8" x 5-3/16" x 3-1/4" (143 mm x 131 mm x 83 mm)	2MB	266.75
	K-97029	Avid Pull Cabinet Hardware 4-1/16" x 1-3/8" x 9/16" (103 mm x 35 mm x 14 mm) For 3" centers (76 mm)	2MB	39.15
	K-97030	Avid Knob Cabinet Hardware 1-5/16" x 1-3/8" x 9/16" (33 mm x 35 mm x 14 mm)	2MB	17.85

Competitive

Max flow rates:
1.2 gpm (4.5 lpm), 1.0 gpm (3.8 lpm) or 0.5 gpm (1.9 lpm)

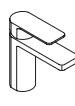
SINGLE-HANDLE BATHROOM SINK FAUCET

PRODUCT	MODEL NO.	DESCRIPTION	COLOR/FINISH	LIST PRICE
	K-24804-4	Parallel Short Single-Handle Bathroom Sink Faucet Spout reach: 4-11/16" (119 mm) Spout height: 2-7/16" (62 mm) (base to outlet) Aerated flow, 1.2 gpm (4.5 lpm) Lever handle Flexible supplies Pop-up drain with 1-1/4" (32 mm) tailpiece For single-hole installation	2MB	\$ 652.10
	K-24804-4K	Flow rate: 1.0 gpm (3.8 lpm)	2MB	652.10
	K-24804-4N	Flow rate: 0.5 gpm (1.9 lpm)	2MB	652.10
	K-23472-4	Parallel Single-Handle Bathroom Sink Faucet Spout reach: 4-9/16" (116 mm) Spout height: 3-15/16" (100 mm) (base to outlet) Aerated flow, 1.2 gpm (4.5 lpm) Lever handle Flexible supplies Pop-up drain with 1-1/4" (32 mm) tailpiece For single-hole installation	2MB	652.10
	K-23472-4K	Flow rate: 1.0 gpm (3.8 lpm)	2MB	652.10
	K-23472-4N	Flow rate: 0.5 gpm (1.9 lpm)	2MB	652.10

PRODUCT	MODEL NO.	DESCRIPTION	COLOR/FINISH	LIST PRICE
	K-23475-4	Parallel Tall Single-Handle Bathroom Sink Faucet Spout reach: 5-3/8" (137 mm) Spout height: 8-1/16" (205 mm) (base to outlet) Aerated flow, 1.2 gpm (4.5 lpm) Lever handle Flexible supplies Touch activated drain with 1-1/4" (32 mm) tailpiece For single-hole installation	2MB	\$ 937.45
	K-23475-4K	Flow rate: 1.0 gpm (3.8 lpm)	2MB	937.45
	K-23475-4N	Flow rate: 0.5 gpm (1.9 lpm)	2MB	937.45
	K-23481	6-3/8" (162 mm) Escutcheon plate included For 4" centers (102 mm)	2MB	52.50

Max flow rates:
1.2 gpm (4.5 lpm), 1.0 gpm (3.8 lpm) or 0.5 gpm (1.9 lpm)

WIDESPREAD BATHROOM SINK FAUCET

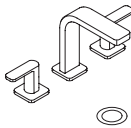
PRODUCT	MODEL NO.	DESCRIPTION	COLOR/FINISH	LIST PRICE
	K-23484-4	Parallel Widespread Bathroom Sink Faucet Spout reach: 5" (127 mm) Spout height: 5-1/2" (133 mm) (base to outlet) Aerated flow, 1.2 gpm (4.5 lpm) Lever handles Flexible supplies Touch activated drain with 1-1/4" (32 mm) tailpiece For 8" to 16" centers (203 mm to 406 mm)	2MB	\$ 864.10
	K-23484-4K	Flow rate: 1.0 gpm (3.8 lpm)	2MB	864.10
	K-23484-4N	Flow rate: 0.5 gpm (1.9 lpm)	2MB	864.10





Lever handles comply with the actuation force limitations of the 2010 ADA Standards for Accessible Design, Section 309 Operable Parts, of the Act.

THE BOLD LOOK
OF **KOHLER**

WALL-MOUNT BATHROOM SINK FAUCET, VALVE AND TRIM

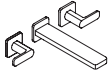
Max flow rate: 1.2 gpm (4.5 lpm)

PRODUCT	MODEL NO.	DESCRIPTION	COLOR/FINISH	LIST PRICE
	K-T27120-4	Parallel Two-Handle Wall-Mount Bathroom Sink Faucet Trim Spout reach: 8-5/8" (219 mm) Aerated flow Lever handles Trim only, for use with valve: K-410-K	2MB	\$ 815.15
		Order valve separately		

DECK-MOUNT BATH

Max flow rates:
(K-27121): 10 gpm (37.9 lpm), or
(K-23488): 8 gpm (30.3 lpm)
(Handshower): 1.75 gpm (6.6 lpm)

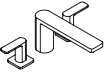
PRODUCT	MODEL NO.	DESCRIPTION	COLOR/FINISH	LIST PRICE
	K-27121-4	Parallel Deck-Mount Bath Faucet Non-diverter spout; Spout reach: 8-3/16" (208 mm) (inlet to outlet) Spout height: 4-1/8" (105 mm) (base to outlet) Lever handles Valve included	2MB	\$ 1,304.15

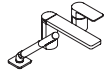
PRODUCT	MODEL NO.	DESCRIPTION	COLOR/FINISH	LIST PRICE
	K-23488-4	Parallel Deck-Mount Bath Faucet with Handshower Diverter spout; Spout reach: 8-3/16" (208 mm) (inlet to outlet) Spout height: 4-1/8" (105 mm) (base to outlet) Single-control remote lever handle Shift+® Ellipse multifunction handshower Valve included	2MB	\$1,385.70

WALL-MOUNT BATH FILLER VALVE AND TRIM

Max flow rate: 10 gpm (37.9 lpm)

PRODUCT	MODEL NO.	DESCRIPTION	COLOR/FINISH	LIST PRICE
	K-T23491-4	Parallel Wall-Mount Bath Filler Trim Spout reach: 8-15/16" (227 mm) (inlet to outlet) Lever handles Trim only, for use with valve: K-20716-K	2MB	\$ 1,059.70



Competitive

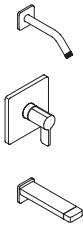
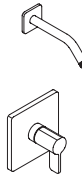

BATH AND SHOWER TRIM SETS LESS SHOWERHEAD

PRODUCT	MODEL NO.	DESCRIPTION	COLOR/FINISH	LIST PRICE	PRODUCT	MODEL NO.	DESCRIPTION	COLOR/FINISH	LIST PRICE
	K-TLS23502-4	Parallel Rite-Temp Pressure-Balancing Bath and Shower Trim Set, Less Showerhead 6-1/4" (152 mm) Diverter spout with slip-fit connection Lever handle Showerarm and flange	2MB	\$ 831.65		K-TLS23503-4	Parallel Rite-Temp Pressure-Balancing Shower Trim Set, Less Showerhead Lever handle Showerarm and flange	2MB	\$ 619.15
	Order valve separately	Trim only, for use with valves: K-8304-K/-**, K-2971-KS or K-8300-K/-** with K-8305-NA				Order valve separately	Trim only, for use with valves: K-8304-K/-**, K-2971-KS or K-8300-K/-** with K-8305-NA		

Max flow rates:

(Showerheads) 2.5 gpm (9.5 lpm) or 1.75 gpm (6.6 lpm)

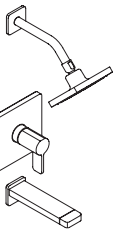
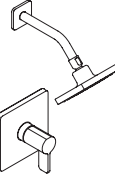
BATH AND SHOWER TRIM SETS WITH SHOWERHEAD

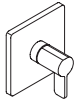
PRODUCT	MODEL NO.	DESCRIPTION	COLOR/FINISH	LIST PRICE	PRODUCT	MODEL NO.	DESCRIPTION	COLOR/FINISH	LIST PRICE
	K-TS23502-4	Parallel Rite-Temp Pressure-Balancing Bath and Shower Trim Set 6-1/4" (152 mm) Diverter spout with slip-fit connection Lever handle 2.5 gpm Single-function Catalyst showerhead, arm and flange	2MB	\$ 977.90		K-TS23503-4	Parallel Rite-Temp Pressure-Balancing Shower Trim Set Lever handle 2.5 gpm Single-function Catalyst showerhead, arm and flange	2MB	\$ 765.25
	Order valve separately	Trim only, for use with valves: K-8304-K/-**, K-2971-KS or K-8300-K/-** with K-8305-NA				Order valve separately	Trim only, for use with valves: K-8304-K/-**, K-2971-KS or K-8300-K/-** with K-8305-NA		
	K-TS23502-4G	With 1.75 gpm single-function showerhead	2MB	977.90		K-TS23503-4G	With 1.75 gpm single-function showerhead	2MB	765.25
						K-TS23501-4	Parallel Rite-Temp Pressure-Balancing Valve Trim Lever handle	2MB	399.80
						Order valve separately	Trim only, for use with valves: K-8304-K/-**, K-2971-KS or K-8300-K/-** with K-8305-NA		

Note: K-2971-KS valve requires service parts cap 1362395.

TRANSFER/DIVERTER VALVE TRIM

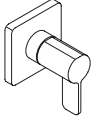
PRODUCT	MODEL NO.	DESCRIPTION	COLOR/FINISH	LIST PRICE
	K-T23509-4	Parallel Transfer/Diverter Valve Trim Lever handle	2MB	\$ 255.15
	Order valve separately	Trim only, for use with valves: K-728-K, K-737-K		





Lever handles comply with the actuation force limitations of the 2010 ADA Standards for Accessible Design, Section 309 Operable Parts, of the Act.



THE BOLD LOOK
OF **KOHLER**®

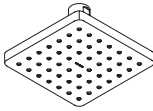



BATH AND SHOWER COMPONENTS

Max flow rates:
2.5 gpm (9.5 lpm) or 1.75 gpm (6.6 lpm)

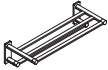
PRODUCT	MODEL NO.	DESCRIPTION	COLOR/FINISH	LIST PRICE
	K-23510	Parallel Wall-Mount 6-1/4" (152 mm) Diverter Bath Spout 1/2" (13 mm) NPT or slip-fit connection	2MB	\$ 326.05
	K-24805	Parallel 2.5 gpm Single-Function Katalyst Showerhead 1/2" (13 mm) NPT connection	2MB	153.00
	K-24805-G	Flow rate: 1.75 gpm (6.6 lpm)	2MB	153.00

ACCESSORIES



PRODUCT	MODEL NO.	DESCRIPTION	COLOR/FINISH	LIST PRICE
	K-23524	Parallel 18" (457 mm) Towel Bar 20" x 3-5/8" x 2" (508 x 92 x 51 mm)	2MB	\$ 230.55
	K-23525	Parallel 24" (610 mm) Towel Bar 26" x 3-5/8" x 2" (660 x 92 x 51 mm)	2MB	246.95
	K-23526	Parallel Towel Arm 9-1/2" x 3-5/8" x 2" (241 x 92 x 51 mm)	2MB	164.75
	K-23530	Parallel Hotelier 26-1/16" x 10-3/16" x 5-15/16" (662 x 259 x 151 mm)	2MB	535.15



PRODUCT	MODEL NO.	DESCRIPTION	COLOR/FINISH	LIST PRICE
	K-23527	Parallel Vertical Toilet Tissue Holder 2-3/4" x 4-7/16" x 6-7/8" (70 x 113 x 175 mm)	2MB	\$ 189.45
	K-23528	Parallel Pivoting Toilet Tissue Holder 8-1/4" x 3-9/16" x 2" (210 x 91 x 51 mm)	2MB	197.60
	K-21897	Parallel Double Toilet Tissue Holder 11-9/16" x 3-9/16" x 2" (294 x 91 x 51 mm)	2MB	214.10
	K-23529	Parallel Robe Hook 2" x 2-3/16" x 2" (51 x 56 x 51 mm)	2MB	98.85

Competitive

Max flow rate:
1.2 gpm (4.5 lpm), 1.0 gpm (3.8 lpm) or 0.5 gpm (1.9 lpm)

SINGLE-HANDLE WIDESPREAD BATHROOM SINK FAUCET

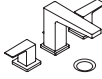
PRODUCT	MODEL NO.	DESCRIPTION	COLOR/FINISH	LIST PRICE
	K-99760-4 	Honesty Single-Handle Bathroom Sink Faucet Spout reach: 4-3/16" (106 mm) Spout height: 4-1/2" (114 mm) (base to outlet) Aerated flow Flow rate: 1.2 gpm (4.5 lpm) Lever handle with red/blue indexing Flexible supplies Pop-up drain with 1-1/4" (32 mm) tailpiece For single-hole installation	2MB	\$ 634.70
	K-99760-4N 	Flow rate: 1.0 gpm (3.8 lpm)	2MB	634.70
	K-99760-4K	Flow rate: 0.5 gpm (1.9 lpm)	2MB	634.70

PRODUCT	MODEL NO.	DESCRIPTION	COLOR/FINISH	LIST PRICE
	K-23255-4 	Honesty Widespread Bathroom Sink Faucet Spout reach: 5-5/16" (135 mm) Spout height: 4-1/8" (105 mm) (base to outlet) Aerated flow Flow rate: 1.2 gpm (4.5 lpm) Lever handles Pop-up drain with 1-1/4" (32 mm) tailpiece For 8" to 16" centers (203 mm to 406 mm)	2MB	\$ 761.50
	K-24857-4	Flow rate: 0.5 gpm (1.9 lpm)	2MB	761.50

Max flow rates:
(Showerheads): 2.5 gpm (9.5 lpm) or 1.75 gpm (6.6 lpm)

BATH AND SHOWER TRIM SETS LESS SHOWERHEAD

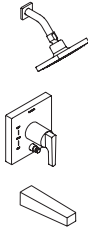
PRODUCT	MODEL NO.	DESCRIPTION	COLOR/FINISH	LIST PRICE
	K-T99763-4L Order valve separately	Honesty Rite-Temp Pressure-Balancing Bath and Shower Trim Set with Push-Button Diverter, Less Showerhead 6-5/8" (168 mm) Non-diverter spout with 1/2" (13 mm) NPT or slip-fit connection Lever handle Showerarm and flange Trim only, for use with valves: K-11748-K/KS	BL, BN 2MB	\$ 538.10

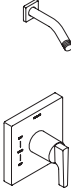
PRODUCT	MODEL NO.	DESCRIPTION	COLOR/FINISH	LIST PRICE
	K-TLS99764-4 Order valve separately	Honesty Rite-Temp Pressure-Balancing Shower Trim Set, Less Showerhead Lever handle Showerarm and flange Trim only, for use with valves: K-8304-K/-**, K-2971-KS or K-8300-K/-** with K-8305-NA	BL, BN 2MB	\$ 306.05







Lever handles comply with the actuation force limitations of the 2010 ADA Standards for Accessible Design, Section 309 Operable Parts, of the Act.

THE BOLD LOOK
OF **KOHLER**®

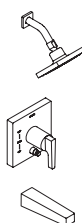
BATH AND SHOWER TRIM SETS WITH SHOWERHEAD

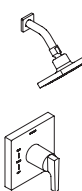

Max flow rates:
(Showerheads) 2.5 gpm (9.5 lpm) or 1.75 gpm (6.6 lpm)

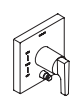
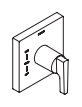



PRODUCT	MODEL NO.	DESCRIPTION	COLOR/FINISH	LIST PRICE
	K-T99763-4	Honesty Rite-Temp Pressure-Balancing Bath and Shower Trim Set with Push-Button Diverter 6-5/8" (168 mm) Non-diverter spout with 1/2" (13 mm) NPT or slip-fit connection Lever handle 2.5 gpm Single-function Katalyst showerhead, arm and flange Trim only, for use with valves: K-11748-K/KS	BL, BN 2MB	\$ 656.30
	K-T99763-4G	With 1.75 gpm (6.6 lpm) single-function showerhead 	BL, BN 2MB	656.30
	K-TS99764-4	Honesty Rite-Temp Pressure-Balancing Shower Trim Set Lever handle 2.5 gpm Single-function Katalyst showerhead, arm and flange Trim only, for use with valves: K-8304-K/-**, K-2971-KS or K-8300-K/-** with K-8305-NA	BL, BN 2MB	408.00
	K-TS99764-4G	With 1.75 gpm (6.6 lpm) single-function showerhead 	BL, BN 2MB	408.00

PRODUCT	MODEL NO.	DESCRIPTION	COLOR/FINISH	LIST PRICE
	K-T99762-4	Honesty Rite-Temp Pressure-Balancing Valve Trim with Push-Button Diverter Lever handle Trim only, for use with valves: K-11748-K/KS	BL, BN 2MB	\$ 328.40
	K-TS99761-4	Honesty Rite-Temp Pressure-Balancing Valve Trim Lever handle Trim only, for use with valves: K-8304-K/-**, K-2971-KS or K-8300-K/-** with K-8305-NA	BL, BN 2MB	299.30

BATH AND SHOWER COMPONENTS

Max flow rates:
(Showerheads, Handshowers): 2.5 gpm (9.5 lpm) or 1.75 gpm (6.6 lpm)
(Diverter Valve): 15.0 gpm (56.8 lpm)





PRODUCT	MODEL NO.	DESCRIPTION	COLOR/FINISH	LIST PRICE
	K-20004	Honesty Wall-Mount 6-9/16" (167 mm) Non-Diverter Bath Spout 1/2" (13 mm) NPT or slip-fit connection	BL, BN 2MB	\$ 223.25 239.80
	K-26148	Honesty 2.5 gpm Rainhead 8" x 8" (203 x 203 mm) 1/2" (13 mm) NPT connection 	2MB	290.45
	K-26148-G	Flow rate: 1.75 gpm (6.6 lpm) 	2MB	290.45



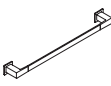

PRODUCT	MODEL NO.	DESCRIPTION	COLOR/FINISH	LIST PRICE
	K-26149	Honesty 2.5 gpm Rainhead 10" x 10" (254 x 254 mm) 1/2" (13 mm) NPT connection 	2MB	\$ 352.10
	K-26149-G	Flow rate: 1.75 gpm (6.6 lpm) 	2MB	352.10
	K-20005	Honesty Showerarm and Flange 5-3/8" (137 mm) reach 1/2" (13 mm) NPT connection	BL, BN 2MB	69.20

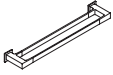

Competitive



ACCESSORIES



PRODUCT	MODEL NO.	DESCRIPTION	COLOR/FINISH	LIST PRICE
	K-26633	Honesty 18" (457 mm) Towel Bar 20-1/8" x 2-15/16" x 2-1/8" (511 x 75 x 54 mm)	2MB	\$ 166.85
	K-26634	Honesty 24" (610 mm) Towel Bar 26-1/8" x 2-15/16" x 2-1/8" (664 x 75 x 54 mm)	2MB	171.80
	K-26636	Honesty Robe Hook 2-1/8" x 2-1/4" x 3-5/8" (54 x 57 x 92 mm)	2MB	94.85
	K-26637	Honesty Towel Arm 9-11/16" x 2-15/16" x 2-1/8" (246 x 75 x 54 mm)	2MB	122.70
	K-26638	Honesty Toilet Tissue Holder 9-1/8" x 2-15/16" x 2-1/8" (232 x 75 x 54 mm)	2MB	127.55
	K-26643	Honesty 24" (610 mm) Double Towel Bar 26-1/8" x 4-3/4" x 2-1/8" (664 x 121 x 54 mm)	2MB	264.95

PRODUCT	MODEL NO.	DESCRIPTION	COLOR/FINISH	LIST PRICE
	K-26639	Honesty 3" (76 mm) Pull Cabinet Hardware 3-5/8" x 1-1/16" x 5/8" (92 x 27 x 16 mm) For 3" centers (76 mm)	2MB	\$ 35.05
	K-26640	Honesty 5" (127 mm) Pull Cabinet Hardware 5-5/8" x 1-1/16" x 5/8" (143 x 27 x 16 mm) For 5" centers (127 mm)	2MB	36.05
	K-26641	Honesty 7" (178 mm) Pull Cabinet Hardware 7-5/8" x 1-1/16" x 5/8" (194 x 27 x 16 mm) For 7" centers (178 mm)	2MB	39.30
	K-26642	Honesty Knob Cabinet Hardware 2-1/2" x 1-1/16" x 1" (64 x 27 x 25 mm) For 2" centers (51 mm)	2MB	19.65

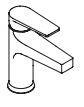
SINGLE-HANDLE BATHROOM SINK FAUCET

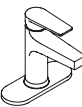

Max flow rate: 1.2 gpm (4.5 lpm)



PRODUCT	MODEL NO.	DESCRIPTION	COLOR/FINISH	LIST PRICE
	K-74013-4 	Taut Single-Handle Bathroom Sink Faucet Spout reach: 3-15/16" (100 mm) Spout height: 3-9/16" (90 mm) (base to outlet) Aerated flow Lever handle Flexible supplies Pop-up drain with 1-1/4" (32 mm) tailpiece For single-hole installation	2MB	\$ 452.70

PRODUCT	MODEL NO.	DESCRIPTION	COLOR/FINISH	LIST PRICE
	K-74021-4 	Taut Single-Handle Bathroom Sink Faucet Spout reach: 3-15/16" (100 mm) Spout height: 3-13/16" (97 mm) (base to outlet) Aerated flow Lever handle Flexible supplies Pop-up drain with 1-1/4" (32 mm) tailpiece For both single-hole and three-hole installations 6-3/8" (162 mm) Escutcheon plate included	2MB	\$ 470.55

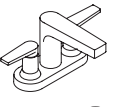
CENTERSET / WIDESPREAD BATHROOM SINK FAUCET

Max flow rate: 1.2 gpm (4.5 lpm)

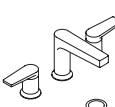
PRODUCT	MODEL NO.	DESCRIPTION	COLOR/FINISH	LIST PRICE
	K-97031-4 	Taut Centerset Bathroom Sink Faucet Spout reach: 4-5/16" (110 mm) Spout height: 3-5/8" (92 mm) (base to outlet) Aerated flow Lever handles Pop-up drain with 1-1/4" (32 mm) tailpiece For 4" centers (102 mm)	2MB	\$ 467.85

PRODUCT	MODEL NO.	DESCRIPTION	COLOR/FINISH	LIST PRICE
	K-97100-4 	Taut Widespread Bathroom Sink Faucet Spout reach: 4-11/16" (119 mm) Spout height: 3-5/8" (92 mm) (base to outlet) Aerated flow Lever handles Pop-up drain with 1-1/4" (32 mm) tailpiece For 8" to 16" centers (203 mm to 406 mm)	2MB	\$ 723.15

DECK-MOUNT BATH

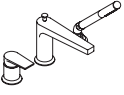

Max flow rates:
11.0 gpm (41.6 lpm)
(Handshower): 1.75 gpm (6.6 lpm)



PRODUCT	MODEL NO.	DESCRIPTION	COLOR/FINISH	LIST PRICE
	K-74032-4	Taut Deck-Mount Bath Faucet with Handshower Diverter spout: Spout reach: 7-7/16" (189 mm) (inlet to outlet) Spout height: 5-1/16" (129 mm) (base to outlet) Single-control remote lever handle Valve included	2MB	\$ 1,122.75

Competitive

SINGLE-HANDLE BATHROOM SINK FAUCET



Max flow rate: 1.2 gpm (4.5 lpm)



PRODUCT	MODEL NO.	DESCRIPTION	COLOR/FINISH	LIST PRICE
	K-97060-4 	Hint Single-Handle Bathroom Sink Faucet Spout reach: 3-7/8" (98 mm) Spout height: 3-1/2" (base to outlet) Aerated flow Lever handle Flexible supplies Pop-up drain with 1-1/4" (32 mm) tailpiece For single-hole installation	2MB	\$ 381.75

PRODUCT	MODEL NO.	DESCRIPTION	COLOR/FINISH	LIST PRICE
	K-97061-4 	Hint Single-Handle Bathroom Sink Faucet Spout reach: 3-7/8" (98 mm) Spout height: 3-15/16" (100 mm) (base to outlet) Aerated flow Lever handle Flexible supplies Pop-up drain with 1-1/4" (32 mm) tailpiece For both single-hole and three-hole installations 6-3/8" (162 mm) Escutcheon plate included	2MB	\$ 418.55

CENTERSET / WIDESPREAD BATHROOM SINK FAUCET

Max flow rate: 1.2 gpm (4.5 lpm)

PRODUCT	MODEL NO.	DESCRIPTION	COLOR/FINISH	LIST PRICE
	K-97094-4 	Hint Centerset Bathroom Sink Faucet Spout reach: 4-5/16" (110 mm) Spout height: 3-5/8" (92 mm) (base to outlet) Aerated flow Lever handles Pop-up drain with 1-1/4" (32 mm) tailpiece For 4" centers (102 mm)	2MB	\$ 301.35

PRODUCT	MODEL NO.	DESCRIPTION	COLOR/FINISH	LIST PRICE
	K-97093-4 	Hint Widespread Bathroom Sink Faucet Spout reach: 4-3/4" (121 mm) Spout height: 3-1/2" (89 mm) (base to outlet) Aerated flow Lever handles Pop-up drain with 1-1/4" (32 mm) tailpiece For 8" to 16" centers (203 mm to 406 mm)	2MB	\$ 522.95

Max flow rates:
11.0 gpm (41.6 lpm)
(Handshower): 1.75 gpm (6.6 lpm)

DECK-MOUNT BATH

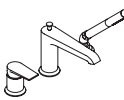
PRODUCT	MODEL NO.	DESCRIPTION	COLOR/FINISH	LIST PRICE
	K-97070-4	Hint Deck-Mount Bath Faucet with Handshower Diverter spout: Spout reach: 7-7/16" (189 mm) (inlet to outlet); Spout height: 5" (127 mm) (base to outlet) Single-control remote lever handle Valve include	2MB	\$ 995.75



Lever handles comply with the actuation force limitations of the 2010 ADA Standards for Accessible Design, Section 309 Operable Parts, of the Act.

THE BOLD LOOK
OF **KOHLER**®

TRANSFER/DIVERTER VALVE TRIM

PRODUCT	MODEL NO.	DESCRIPTION	COLOR/FINISH	LIST PRICE
	K-T97091-4 Order valve separately	Pitch Transfer/Diverter Valve Trim Lever handle Trim only, for use with valves: K-728-K, K-737-K	2MB	\$ 247.30



BATH AND SHOWER TRIM SETS LESS SHOWERHEAD



PRODUCT	MODEL NO.	DESCRIPTION	COLOR/FINISH	LIST PRICE
	K-TLS97074-4 Order valve separately	Pitch Rite-Temp Pressure- Balancing Bath and Shower Trim Set, Less Showerhead 6" (152 mm) Diverter spout with slip-fit connection Lever handle Showerarm and flange Trim only, for use with valves: K-8304-K/-**, K-2971-KS or K-8300-K/-** with K-8305-NA	2MB	\$ 165.60

PRODUCT	MODEL NO.	DESCRIPTION	COLOR/FINISH	LIST PRICE
	K-TLS97077-4 Order valve separately	Pitch Rite-Temp Pressure- Balancing Shower Trim Set, Less Showerhead Lever handle Showerarm and flange Trim only, for use with valves: K-8304-K/-**, K-2971-KS or K-8300-K/-** with K-8305-NA	2MB	\$ 120.00

BATH AND SHOWER TRIM SETS WITH SHOWERHEAD

Max. Flow Rate:
(Showerhead) 1.75 gpm (6.6 lpm)

PRODUCT	MODEL NO.	DESCRIPTION	COLOR/FINISH	LIST PRICE
	K-TS97074-4G  Order valve separately	Pitch Rite-Temp Pressure-Balancing Bath and Shower Trim Set 6" (152 mm) Diverter spout with slip-fit connection Lever handle Single-function Catalyst showerhead, arm and flange Trim only, for use with valves: K-8304-K/-**, K-2971-KS or K-8300-K/-** with K-8305-NA	2MB	\$ 209.35
Note: K-2971-KS valve requires service parts cap 1362395.				

PRODUCT	MODEL NO.	DESCRIPTION	COLOR/FINISH	LIST PRICE
	K-TS97077-4G  Order valve separately	Pitch Rite-Temp Pressure-Balancing Shower Trim Set Lever handle Single-function Catalyst showerhead, arm and flange Trim only, for use with valves: K-8304-K/-**, K-2971-KS or K-8300-K/-** with K-8305-NA)	2MB	\$ 152.20
	K-TS74042-4 Order valve separately	Pitch Rite-Temp Pressure-Balancing Valve Trim Lever handle Trim only, for use with valves: K-8304-K/-**, K-2971-KS or K-8300-K/-** with K-8305-NA	2MB	106.65
Note: K-2971-KS valve requires service parts cap 1362395.				

WALL-MOUNT SPOUTS

PRODUCT	MODEL NO.	DESCRIPTION	COLOR/FINISH	LIST PRICE
	K-97089	Pitch Wall-Mount 6" (152 mm) Diverter Bath Spout Slip-fit connection	2MB	\$ 79.70







Competitive

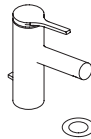

Max. Flow Rates:
1.2 gpm (4.5 lpm), or
0.5 gpm (1.9 lpm)

BATH AND SHOWER TRIM SETS WITH SHOWERHEAD

PRODUCT	MODEL NO.	DESCRIPTION	COLOR/FINISH	LIST PRICE
	K-99491-4	Elate Single-Handle Bathroom Sink Faucet Spout reach: 4-3/16" (106 mm) Spout height: 3-13/16" (97 mm) (base to outlet) Aerated flow Flow rate: 1.2 gpm (4.5 lpm) Lever handle with red/blue indexing Flexible supplies Pop-up drain with 1-1/4" (32 mm) tailpiece For single-hole installation	2MB	\$ 471.25
	K-99492-4	Flow rate: 0.5 gpm (1.9 lpm)	2MB	\$ 471.25

ACCESSORIES

PRODUCT	MODEL NO.	DESCRIPTION	COLOR/FINISH	LIST PRICE
Dimensions are listed LONG X WIDE (DEEP) X HIGH Long = Widest Side to Side Measurement Wide = Depth from Outside Edge to Wall High = Vertical Height				
	K-27288	Elate 12" Towel Bar 14" x 2-3/4" x 2" (356 mm x 70 mm x 51 mm)	2MB	\$ 56.55
	K-27286	Elate 18" (457 mm) Towel Bar 20-1/8" x 2-15/16" x 2-1/8" (511 x 75 x 54 mm)	2MB	60.50
	K-27287	Elate 24" (610 mm) Towel Bar 26" x 2-3/4" x 2" (660 x 75 x 51 mm)	2MB	66.35
	K-27289	Elate Double Toilet Tissue Holder 10-1/8" x 3-13/16" x 2" (257 mm x 97 mm x 51 mm)	2MB	101.30
	K-27290	Elate Robe Hook 2" x 1-7/8" x 2" (51 mm x 48 mm x 51 mm)	2MB	35.20

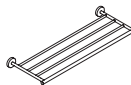
PRODUCT	MODEL NO.	DESCRIPTION	COLOR/FINISH	LIST PRICE
	K-27291	Elate Towel Arm 10-1/8" x 2-15/16" x 2" (257 mm x 75 mm x 51 mm)	2MB	\$ 50.70
	K-27292	Elate Pivoting Toilet Tissue Holder 6-1/16" x 3-13/16" x 2" (154 mm x 97 mm x 51 mm)	2MB	52.65
	K-27293	Elate Vertical Toilet Tissue Holder 2-3/8" x 3-9/16" x 6-5/16" (61 mm x 91 mm x 161 mm)	2MB	58.55
	K-27294	Elate Hotelier 26" x 9-1/2" x 2" (660 mm x 241 mm x 51 mm)	2MB	243.40



Lever handles comply with the actuation force limitations of the 2010 ADA Standards for Accessible Design, Section 309 Operable Parts, of the Act.

THE BOLD LOOK
OF **KOHLER**

FINISH ADDITIONS — STEAM

INVIGORATION® SERIES STEAM UNITS

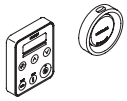
PRODUCT	MODEL NO.	DESCRIPTION	COLOR/FINISH	LIST PRICE
	K-5557	Invigoration Series Steam Generator Control Kit	BL, 2MB	\$ 1,321.60
		Circular steam head protracts from finished wall, allowing steam to evenly dispense throughout shower. Steam head features an integral aromatherapy well for adding scents. UL and NOM-ANCE Listed.	2MB	1,321.70
		Easily adjustable control panel allows user to set temperature (90-125°F (35-52°C) range) and the steam session duration. Required for use with KOHLER® Invigoration Series 5kW–15kW Steam Generators.	TT	1,458.40

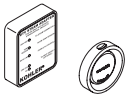
PRODUCT	MODEL NO.	DESCRIPTION	COLOR/FINISH	LIST PRICE
	K-5548-K1	DTV+ Steam Adapter Kit	BL, 2MB	\$ 1,315.50
		Circular steam head protracts from finished wall, allowing steam to evenly dispense throughout shower. Steam head features an integral aromatherapy well for adding scents. UL and NOM-ANCE Listed. Adjustable temperature and session settings via the DTV+ digital interface. 20-minute safety shut-off. For use with KOHLER Invigoration Series 5kW–15kW Steam Generators when used with KOHLER DTV+ K-99693-P/K-99695-E custom showering products		

INVIGORATION SERIES TANDEM STEAM UNITS

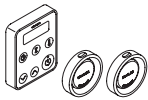
PRODUCT	MODEL NO.	DESCRIPTION	COLOR/FINISH	LIST PRICE
	K-5558	Invigoration Series Tandem Steam Generator Control Kit	2MB	\$ 1,701.95
		Circular steam heads protract from finished wall, allowing steam to evenly dispense throughout shower. Steam heads feature an integral aromatherapy well for adding scents. UL Listed. Easily adjustable control panel allows user to set temperature (90-125°F (32-52°C) range) and the steam session duration. Required for use with KOHLER Invigoration Series 8kW–30kW Steam Generators.	BL, TT	1,878.05

PRODUCT	MODEL NO.	DESCRIPTION	COLOR/FINISH	LIST PRICE
	K-5549-K1	DTV+ Tandem Steam Adapter Kit	BL	\$ 1,680.30
		Circular steam heads protract from finished wall, allowing steam to evenly dispense throughout shower. Steam heads feature an integral aromatherapy well for adding scents. UL Listed. Adjustable temperature and session settings via the DTV+ digital interface. 20-minute safety shut-off. For use with KOHLER Invigoration Series 18kW–30kW Steam Generators when used with KOHLER DTV+ K-99693-P/K-99695-E custom showering products.		

SHOWERARMS WITH DIVERTER

PRODUCT	MODEL NO.	DESCRIPTION	COLOR/FINISH	LIST PRICE
	K-76336	Gooseneck Rainhead Showerarm with 3-Way Diverter and Flange Diverter switches water between showerhead and handshower, or both on at one time Spout reach: 18-3/16" (462 mm) For use with KOHLER® rainheads and handshowers 1/2" (13 mm) NPT connection	2MB	\$ 349.60
	K-76337	Gooseneck Rainhead Showerarm with 2-Way Diverter and Flange Diverter switches water between showerhead and handshower Spout reach: 18-3/16" (462 mm) For use with KOHLER rainheads and handshowers 1/2" (13 mm) NPT connection	2MB	349.60

WALL-MOUNT HANDSHOWER SUPPLY ELBOWS

PRODUCT	MODEL NO.	DESCRIPTION	COLOR/FINISH	LIST PRICE
	K-98351	Includes check valve for backflow prevention	2MB	\$ 107.05

DECK-MOUNT HANDSHOWER DIVERTER/TRANSFER VALVES

Max. Flow Rates:

15.0 gpm (56.8 lpm) @ 45 psi using 1/2" High-Flow Valves

25.0 gpm (94.6 lpm) @ 45 psi using 3/4" High-Flow Valves

PRODUCT	MODEL NO.	DESCRIPTION	COLOR/FINISH	LIST PRICE
	K-8549	Bath- or Deck-Mount Diverter Valve Kit Includes: 2-way diverter valve, handshower hose guide, and Polished Chrome hose Can be mounted up to 1-1/4" (32 mm) thickness Requires handshower	2MB	\$ 1,017.55

PRODUCT	MODEL NO.	DESCRIPTION	COLOR/FINISH	LIST PRICE
	K-9530	Deck-Mount 2-Way Diverter Valve Can be wall-mounted up to 1-1/4" (32 mm) wall thickness Code approved for backflow prevention	2MB	\$ 543.70

KOHLER® CUSTOM BATH DRAINS

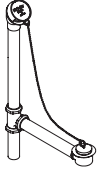
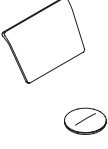
PRODUCT	MODEL NO.	DESCRIPTION	COLOR/FINISH	LIST PRICE
Chain and Rubber Stopper Bath Drain				
	K-106	Antique™ 1-1/2" (38 mm) Bath Drain Chain and rubber stopper Brass tee and pipe For through-the-floor installation For K-100 Birthday Bath® installation	2MB	\$ 1,326.55
Cable Pop-up Bath Drains				
	K-23857	Tea-for-Two® Bath Drain Trim Contoured overflow hood For use with K-23856 Tea-for-Two Cable Pop-Up Bath Drain	2MB	222.40
NOTE: K-23856/57 drain and trim should be used specifically for the Tea-for-Two baths versus SKU #'s K-7147-AF-*, K-7148-AF-* and K-7169-AF-*				

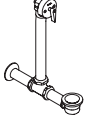
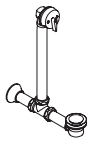
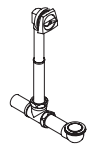
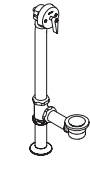
PRODUCT	MODEL NO.	DESCRIPTION	COLOR/FINISH	LIST PRICE
Trip Lever Pop-up Bath Drains				
	K-7104	Iron Works® 1-1/2" (38 mm) Exposed Bath Drain Adjustable trip lever pop-up For Iron Works Historic™ freestanding baths	2MB	\$ 1,380.30
	K-7159	Artifacts® 1-1/2" (38 mm) Pop-Up Bath Drain Adjustable trip lever pop-up For Artifacts freestanding baths	2MB	1,414.20
	K-7167	Clearflo 2" (51 mm) Adjustable Pop-Up High Volume Drain Brass tee and pipe For above- or through-the-floor installation For RiverBath® and Consonance® whirlpools	2MB	1,063.10
	K-7178	Clearflo 1-1/2" (38 mm) Decorative Bath Drain Adjustable trip lever pop-up For exposed drain installation, above- or through-the-floor installation For Iron Works® Historic bath	2MB	1,526.20

Competitive

Max flow rate: 1.5 gpm (5.7 lpm)

ELECTRONIC PULL-DOWN SPRAY

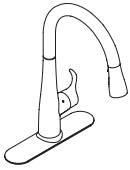
PRODUCT	MODEL NO.	DESCRIPTION	COLOR/FINISH	LIST PRICE
Spout Height A = Finished Surface to Highest Faucet Point Spout Height B = Finished Surface to Aerator				
	K-22036	Simplice Electronic Pull-Down Spray Kitchen Sink Faucet Response® technology uses a state-of-the-art motion sensor for reliable touchless activation Three-function pull-down sprayhead with touch-control allows you to switch between stream, Sweep® spray and Boost technology DockNetik®, a magnetic docking system smoothly glides and securely locks the sprayhead into place ProMotion® technology with light, quiet braided hose, swiveling ball joint and MasterClean™ sprayface Ceramic disc valves Swing spout reach: 9" (229 mm) Spout height A : 16-9/16" (421 mm) Spout height B : 9-3/8" (231 mm) Lever handle Flexible supplies 10-1/2" (267 mm) Escutcheon plate included	2MB	\$ 908.75
<p>Note: Requires unswitched power outlet (110V AC) located below the sink and within 5' (1.5 m) of the control box. (Garbage disposals typically use switched outlets and are not recommended.)</p> <p>K-22036 Simplice faucet contains all necessary parts for both single-hole and three-hole installations. See Deep Roughing-In Kit (1012715).</p>				

Max flow rate: 1.5 gpm (5.7 lpm)

SEMI-PROFESSIONAL

PRODUCT	MODEL NO.	DESCRIPTION	COLOR/FINISH	LIST PRICE
Spout Height A = Finished Surface to Highest Faucet Point Spout Height B = Finished Surface to Aerator				
	K-22033	Simplice Semi-Professional Kitchen Sink Faucet Three-function pull-down sprayhead with touch-control allows you to switch between stream, Sweep spray and Boost technology Magnetic docking arm that securely locks the sprayhead into place Easy to clean coated hose, removable coil and MasterClean sprayface Ceramic disc valves High arch spout with 360° rotation: Spout reach: 9" (229 mm) Spout height A : 21-5/8" (549 mm) Spout height B : 7-5/8" (194 mm) Lever handle Flexible supplies 10-1/2" (267 mm) Escutcheon plate included	2MB	\$ 803.55
<p>Note: K-22033 Simplice faucet contains all necessary parts for both single-hole and three-hole installations. See Deep Roughing-In Kit (1327990).</p>				



Lever handles comply with the actuation force limitations of the 2010 ADA Standards for Accessible Design, Section 309 Operable Parts, of the Act.

THE BOLD LOOK
OF **KOHLER**®

PULL-DOWN SPRAY

Max flow rate: 1.5 gpm (5.7 lpm)

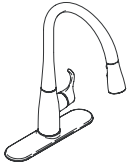
PRODUCT	MODEL NO.	DESCRIPTION	COLOR/FINISH	LIST PRICE
Spout Height A = Finished Surface to Highest Faucet Point Spout Height B = Finished Surface to Aerator				
	K-596	Simplice Single-Handle Pull-Down Spray Kitchen Sink Faucet Three-function pull-down sprayhead with touch-control allows you to switch between stream, Sweep spray and Boost technology DockNetik, a magnetic docking system smoothly glides and securely locks the sprayhead into place ProMotion® technology with light, quiet braided hose, swiveling ball joint and MasterClean sprayface Ceramic disc valves High arc spout with 360° rotation: Spout reach: 9" (229 mm) Spout height A : 16-5/8" (422 mm) Spout height B : 9-5/8" (244 mm) Aerated flow Lever handle Flexible supplies 10-1/2" (267 mm) Escutcheon plate included	2MB	\$ 580.10
Note: K-596 and K-597 Simplice faucets contain all necessary parts for both single-hole and three-hole installations.				

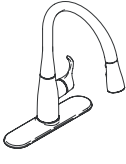
PRODUCT	MODEL NO.	DESCRIPTION	COLOR/FINISH	LIST PRICE
Spout Height A = Finished Surface to Highest Faucet Point Spout Height B = Finished Surface to Aerator				
	K-597	Simplice Single-Handle Pull-Down Spray Secondary Sink Faucet Three-function pull-down sprayhead with touch-control allows you to switch between stream, Sweep spray and Boost technology DockNetik, a magnetic docking system smoothly glides and securely locks the sprayhead into place ProMotion® technology with light, quiet braided hose, swiveling ball joint and MasterClean sprayface Ceramic disc valves High arc spout with 360° rotation: Spout reach: 8" (203 mm) Spout height A : 15-3/8" (390 mm) Spout height B : 8-5/8" (219 mm) Aerated flow Lever handle Flexible supplies 10-1/2" (267 mm) Escutcheon plate included	2MB	\$ 554.85
Note: K-596 and K-597 Simplice faucets contain all necessary parts for both single-hole and three-hole installations.				



SINGLE-HANDLE LAUNDRY & BAR

Max flow rates:
(K-22035): 4.0 gpm (15.1 lpm)
(K-22034): 1.5 gpm (5.7 lpm)

PRODUCT	MODEL NO.	DESCRIPTION	COLOR/FINISH	LIST PRICE
Spout Height A = Finished Surface to Highest Faucet Point Spout Height B = Finished Surface to Aerator				
	K-22035	Simplice Single-Handle Pull-Out Spray Laundry Sink Faucet Two-function pull-out sprayhead with touch control for aerated flow and Sweep® spray Ceramic disc valves Swing spout reach: 8-1/16" (205 mm) Spout height A : 9-3/8" (238 mm) Spout height B : 4-15/16" (125 mm) Lever handle Flexible supplies For 4" centers (102 mm)	2MB	\$ 312.55

PRODUCT	MODEL NO.	DESCRIPTION	COLOR/FINISH	LIST PRICE
	K-22034	Simplice Single Handle Bar Sink Faucet Ceramic disc valves Swing spout with 180° rotation: Swing spout reach: 7-1/4" (184 mm) Spout height A : 13" (330 mm) Spout height B : 8-1/16" (205 mm) Aerated flow Lever handle Flexible supplies	2MB	\$ 446.40

MISCELLANEOUS

PRODUCT	MODEL NO.	DESCRIPTION	COLOR/ FINISH	LIST PRICE
	K-14531	6" Escutcheon Plate (152 mm) For 4" centers (102 mm)	2MB	\$ 119.00
	K-9110	Air Gap Kit Includes Valve Body and Cover	2MB	43.80



Lever handles comply with the actuation force limitations of the 2010 ADA Standards for Accessible Design, Section 309 Operable Parts, of the Act. Product meets all State and Federal material regulations for drinking water faucets and fittings.



THE BOLD LOOK
OF **KOHLER**®





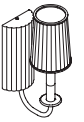
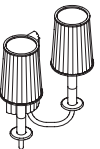

TRESDOUX

The Tresdoux lighting collection offers a modern interpretation of vintage Hollywood charm. Textured metal and embellished matte glass combine in contrast for centerpieces as elegant and unique as they are functional.

LIGHTING

PRODUCT	MODEL NO.	DESCRIPTION	COLOR/ FINISH	LIST PRICE
Tresdoux Lighting Collection				
	K-27438-SC01	Tresdoux One-Light Sconce Dimensions: (L x W x H) 8-3/16" x 4-13/16" x 15-5/16" (208 x 122 x 389 mm) Socket Size: Candelabra Base (E12) Recommended Bulb: B10 or B11	GNL, SNL 2PL	\$ 499.00
	K-28544-SC02	Tresdoux Two-Light Sconce Dimensions: (L x W x H) 6-5/8" x 13" x 15-5/16" (168 x 330 x 389 mm) Socket Size: Candelabra Base (E12) Recommended Bulb: B10 or B11	GNL, SNL 2PL	699.00
 ADA	K-28545-SC02	Tresdoux Two-Light Bath Bar Dimensions: (L x W x H) 3-1/2" x 4-3/4" x 21-9/16" (88 x 121 x 548 mm) Socket Size: Candelabra Base (E12) Recommended Bulb: B9	GNL, SNL 2PL	699.00
	K-27439-PE03	Tresdoux Three-Light Pendant Dimensions: (Diam. x L) 16-3/16" x 9-1/8" (411x 232 mm) Min. Height: 31-3/8" (797 mm) Max. Height: 103-7/16" (2627 mm) Socket Size: Medium Base (E26 Socket) Recommended Bulb: A19	GNL, SNL 2PL	1,299.00



PRODUCT	MODEL NO.	DESCRIPTION	COLOR/ FINISH	LIST PRICE
Tresdoux Lighting Collection				
	K-27436-FM03	Tresdoux Three-Light Flush Mount Dimensions: (Diam. x H) 16" x 8-1/4" (406 x 210 mm) Socket Size: Medium Base (E26 Socket) Recommended Bulb: A19	GNL, SNL 2PL	\$1,299.00
	K-27437-SF03	Tresdoux Three-Light Semi-Flush Mount Dimensions: (Diam. x H) 16-3/16" x 10-3/4" (411x 273 mm) Socket Size: Medium Base (E26 Socket) Recommended Bulb: A19	GNL, SNL 2PL	999.00
	K-27441-CH06	Tresdoux Six-Light Chandelier Dimensions: (Diam. x H) 24" x 18-11/16" (610 x 475 mm) Min. Height: 33-7/16" (849 mm) Max. Height: 105-7/16" (2678 mm) Socket Size: Candelabra Base (E12) Recommended Bulb: B10 or B11	GNL, SNL 2PL	1,999.00
	K-27442-CH08	Tresdoux Eight-Light Chandelier Dimensions: (Diam. x H) 30" x 25-7/8" (762 x 657 mm) Min. Height: 44-1/2" (1130 mm) Max. Height: 114-1/2" (2908 mm) Socket Size: Candelabra Base (E12) Recommended Bulb: B10 or B11	GNL, SNL 2PL	2,499.00





VORLEIGH

Vorleigh takes inspiration from Streamline Moderne, an international style of Art Deco architecture that emerged in the 1930s. Inspired by aerodynamic design, it was used in railroad locomotives, telephones, buses, appliances, and other devices to give the impression of sleekness and modernity.

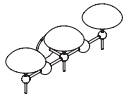
LIGHTING

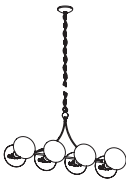
PRODUCT	MODEL NO.	DESCRIPTION	COLOR/ FINISH	LIST PRICE
Vorleigh Lighting Collection				
	K-27944-SC01	Vorleigh One-Light Sconce Dimensions: (L x W x H) 10" x 8-5/8" x 14-7/8" (254 x 219 x 378 mm) Socket Size: Candelabra Base (E12) Recommended Bulb: G16.5	CPL, GNL SNL, 2GL 2PL	\$ 399.00
	K-27945-SC02	Vorleigh Two-Light Sconce Dimensions: (L x W x H) 10" x 21-5/8" x 10-3/4" (254 x 549 x 273 mm) Socket Size: Candelabra Base (E12) Recommended Bulb: G16.5	CPL, GNL SNL, 2GL 2PL	719.00
	K-27946-SC03	Vorleigh Three-Light Sconce Dimensions: (L x W x H) 10" x 31-5/8" x 10-3/4" (254 x 803 x 273 mm) Socket Size: Candelabra Base (E12) Recommended Bulb: G16.5	CPL, GNL SNL, 2GL 2PL	969.00

PRODUCT	MODEL NO.	DESCRIPTION	COLOR/ FINISH	LIST PRICE
Vorleigh Lighting Collection				
	K-27949-CH08	Vorleigh Eight-Light Linear Chandelier Dimensions: (L x W) 14-3/4" x 44-7/16" (375 x 1129 mm) Min. Height: 28-1/2" (724 mm) Max. Height: 97-3/8" (2473 mm) Socket Size: Candelabra Base (E12) Recommended Bulb: G16.5	GNL, SNL 2GL, 2PL	\$1,999.00
	K-27950-CH04	Vorleigh Four-Light Chandelier Dimensions: (L x W) 29-5/8" x 29-5/8" (752 x 752 mm) Min. Height: 32-1/4" (819 mm) Max. Height: 101-1/8" (2569 mm) Socket Size: Candelabra Base (E12) Recommended Bulb: G16.5	GNL, SNL 2GL, 2PL	1,299.00
	K-27951-CH08	Vorleigh Eight-Light Chandelier Dimensions: (L x W) 40-3/8" x 40-3/8" (1026 x 1026 mm) Min. Height: 38-1/4" (972 mm) Max. Height: 107-3/16" (2723 mm) Socket Size: Candelabra Base (E12) Recommended Bulb: G16.5	GNL, SNL 2GL, 2PL	2,999.00



Modern Farm

Inspired by the agricultural heritage of the Kohler Co., we designed this collection with a modern mindset to offer a balanced blend of rustic and refined.

LIGHTING







PRODUCT	MODEL NO.	DESCRIPTION	COLOR/FINISH	LIST PRICE
Modern Farm Lighting Collection				
	K-23669-SC01 Modern Farm One-Light Lacemaker Sconce Dimensions: (L x W x H) 9-3/8" x 8-1/2" x 7-1/4" (238 x 216 x 184 mm) Socket Size: Candelabra Base (E12) Recommended Bulb: G16.5	BGL, CPL	\$ 499.00	
		WHL	249.00	
	K-23668-SC01 Modern Farm One-Light Swinging Sconce Dimensions: (L x W x H) 10" x 8-1/16" x 6-5/8" (254 x 205 x 168 mm) Socket Size: Candelabra Base (E12) Recommended Bulb: G16.5	BGL, CPL	399.00	
		WHL	149.00	
	K-23670-FM01 Modern Farm One-Light Flush-Mount Dimensions: (Diam. x H) 12" x 6-5/8" (305 x 168 mm) Socket Size: Candelabra Base (E12) Recommended Bulb: G16.5	BGL, CPL	499.00	
		WHL	299.00	







TERRET

Inspired by the equestrian-themed lifestyle and its interior design following, Terret lighting collection offers an updated perspective on what originated from aristocratic English country estates.

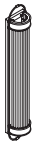
LIGHTING

PRODUCT	MODEL NO.	DESCRIPTION	COLOR/ FINISH	LIST PRICE
Terret Lighting Collection				
	K-27741-SC01	Terret One-Light Sconce Dimensions: (L x W x H): 8-7/16" x 7-1/16" x 10-7/8" (214 x 179 x 276 mm) Socket Size: Medium Base (E26 Socket) Recommended Bulb: 19 or G16.5	BVL, CPL SNL, 2GL	\$ 359.00
	K-27742-SC02	Terret Two-Light Sconce Dimensions: (L x W x H): 8-7/16" x 15-9/16" x 10-15/16" (214 x 395 x 278 mm) Socket Size: Medium Base (E26 Socket) Recommended Bulb: A19 or G16.5	BVL, CPL SNL, 2GL	599.00
	K-27743-SC03	Terret Three-Light Sconce Dimensions: (L x W x H): 8-7/16" x 24-1/16" x 10-7/8" (214 x 611 x 276 mm) Socket Size: Medium Base (E26 Socket) Recommended Bulb: A19 or G16.5	BVL, CPL SNL, 2GL	799.00
	K-27744-SC04	Terret Four-Light Sconce Dimensions: (L x W x H): 8-7/16" x 32-9/16" x 10-7/8" (214 x 827 x 276 mm) Socket Size: Medium Base (E26 Socket) Recommended Bulb: A19 or G16.5	BVL, CPL SNL, 2GL	999.00
 ADA	K-27751-SC01	Terret One-Light Bath Bar Dimensions: (L x W x H): 3-9/16" x 4-3/4" x 14-13/16" (90 x 121 x 376 mm) Socket Size: Candelabra Base (E12) Recommended Bulb: B9	BVL, CPL SNL, 2GL	449.00
 ADA	K-27752-SC02	Terret Two-Light Bath Bar Dimensions: (L x W x H): 3-9/16" x 4-3/4" x 20-15/16" (90 x 121 x 532 mm) Socket Size: Candelabra Base (E12) Recommended Bulb: B9	BVL, CPL SNL, 2GL	599.00



PRODUCT	MODEL NO.	DESCRIPTION	COLOR/ FINISH	LIST PRICE
Terret Lighting Collection				
 ADA	K-27753-SC04	Terret Four-Light Bath Bar Dimensions: (L x W x H): 3-9/16" x 4-3/4" x 31-1/2" (90 x 121 x 800 mm) Socket Size: Candelabra Base (E12) Recommended Bulb: B9	BVL, CPL SNL, 2GL	\$ 699.00
	K-27750-FM03	Terret Three-Light Flush Mount Dimensions: (Diam. x H): 15" x 5-7/8" (381 x 149 mm) Socket Size: Medium Base (E26 Socket) Recommended Bulb: A19	BVL, CPL SNL, 2GL	999.00
	K-27748-CH05	Terret Five-Light Chandelier Dimensions: (Diam. x H): 29" x 36-13/16" (737 x 935 mm) Min. Height: 38-3/4" (984 mm) Max. Height: 100-3/4" (2559 mm) Socket Size: Candelabra Base (E12) Recommended Bulb: B9 or B10	BVL, SNL 2GL	2,699.00
	K-27749-CH06	Terret Six-Light Chandelier Dimensions: (Diam. x H): 35-3/4" x 27-3/8" (908 x 695 mm) Min. Height: 38-1/4" (972 mm) Max. Height: 107-3/16" (2723 mm) Socket Size: Candelabra Base (E12) Recommended Bulb: B9 or B10	BVL, SNL 2GL	2,299.00



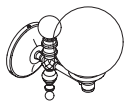
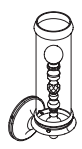

DAMASK

Influenced by the unique candle-like shape of antique apothecary jars, the Damask lighting collection illuminates any space with lasting beauty and style.

LIGHTING

PRODUCT	MODEL NO.	DESCRIPTION	COLOR/FINISH	LIST PRICE
Damask Lighting Collection				
	K-22546-SC01	Damask One-Light Lacemaker Sconce Dimensions: (L x W x H) 10-5/16" x 5" x 11-5/16" (262 x 127 x 287 mm) Socket Size: Candelabra Base (E12) Recommended Bulb: G16.5/B10/CA10/T10	BGL, BZL CPL, SNL	\$ 379.00
	K-22545-SC0	Damask One-Light Sconce Dimensions: (L x W x H) 6-9/16" x 5" x 13-3/16" (167 x 127 x 351 mm) Socket Size: Candelabra Base (E12) Recommended Bulb: G16.5/B10/CA10/T1	BGL, BZL CPL, SNL	289.00
	K-23339-PE01	Damask One-Light Pendant Dimensions: (Diam.) 5" (127 mm) Min. Height: 15-5/16" (389 mm) Max. Height: 135-5/16" (3437 mm) Socket Size: Candelabra Base (E12) Recommended Bulb: G16.5/B10/CA10/T10	BGL, BZL CPL, SNL	299.00



PRODUCT	MODEL NO.	DESCRIPTION	COLOR/FINISH	LIST PRICE
Damask Lighting Collection				
	K-23340-PE01	Damask One-Light Adjustable Pendant Dimensions: (Diam.) 6-1/2" (165 mm) Min. Height: 23-3/8" (594 mm) Max. Height: 143-3/8" (3642 mm) Socket Size: Candelabra Base (E12) Recommended Bulb: G16.5/B10/CA10/T10	BGL, BZL CPL, SNL	\$ 349.00
	K-23341-PE03	Damask Three-Light Pendant Dimensions: (Diam.) 12-1/2" (318 mm) Min. Height: 32-5/8" (829 mm) Max. Height: 152-5/8" (3877 mm) Socket Size: Candelabra Base (E12) Recommended Bulb: G16.5/B10/CA10/T10	BGL, BZL CPL, SNL	899.00



SIMPALO

Elegant, spherical forms feature an uncluttered yet beautifully detailed linear pattern - exemplifying the chic minimalism and subtle ornamentation that keep the fervor for midcentury style alive.

LIGHTING

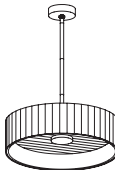

PRODUCT	MODEL NO.	DESCRIPTION	COLOR/ FINISH	LIST PRICE
Simpalo Lighting Collection				
	K-22520-PELED	<p>Simpalo LED Pendant</p> <p>Dimensions: (Diam. x H) 12-5/16" x 1-9/16" (313 x 40 mm)</p> <p>Min. Height: 15" (381 mm) Max. Height: 36" (914 mm)</p> <p>Socket Size: Integrated LED Recommended Bulb: Included</p>	BLL, CPL SNL	\$ 899.00
	K-22521-SFLED	<p>Simpalo Semi-Flush LED Pendant</p> <p>Dimensions: (Diam. x H) 14-5/16" x 11-3/4" (364 x 298 mm)</p> <p>Socket Size: Integrated LED Recommended Bulb: Included</p>	BLL, CPL SNL	1,249.00
	K-22519-CHLED	<p>Simpalo LED Drum</p> <p>Dimensions: (Diam. x H) 28-1/8" x 7-15/16" (714 mm x 202 mm)</p> <p>Min. Height: 22-1/4" (565 mm) Max. Height: 46-1/4" (1175 mm)</p> <p>Socket Size: Integrated LED Recommended Bulb: Included</p>	BLL	2,999.00
			SNL	3,499.00



COMPONENTS

Modern form meets modern function: the KOHLER® Components collection is defined by controlled forms and stark precision in every line and angle.

LIGHTING

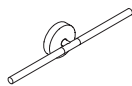
PRODUCT	MODEL NO.	DESCRIPTION	COLOR/FINISH	LIST PRICE
Components Lighting Collection				
	K-23467-SCLED	Components One-Light LED Lacemaker Sconce Dimensions: (L x W x H) 7-1/4" x 6" x 12" (184 x 152 x 305 mm) Socket Size: Integrated LED Recommended Bulb: Included	BLL, CPL SNL, 2GL	\$ 389.00
 <small>ADA</small>	K-23463-SCLED	Components 18" (457 mm) One-Light LED Sconce Dimensions: (L x W x H) 3-1/4" x 5-1/8" x 18" (83 x 130 x 457 mm) Socket Size: Integrated LED Recommended Bulb: Included	BLL, CPL SNL, 2GL	269.00
 <small>ADA</small>	K-23464-SCLED	Components 24" (610 mm) Two-Light LED Sconce Dimensions: (L x W x H) 3-1/4" x 24" x 5-1/8" (83 x 610 x 130 mm) Socket Size: Integrated LED Recommended Bulb: Included	BLL, CPL SNL, 2GL	299.00





KRAGA

Emulating the unique elegance of pearl drop earrings, Kraga compact lighting designs feature translucent, globular glasses gracefully suspended from arced metals

LIGHTING

PRODUCT	MODEL NO.	DESCRIPTION	COLOR/ FINISH	LIST PRICE
Kraga Lighting Collection				
	K-32376-SC01	Kraga One-Light Sconce Dimensions: (L x W x H) 7-1/8" x 6" x 13-1/16" (181 x 152 x 332 mm) Socket Size: G9 Recommended Bulb: G9 LED 5w (about 40w/60w equivalent)	BLL, CPL 2PL	\$ 229.00
	K-32379-PE01	Kraga One-Light XL Pendant Dimensions: (Diam. x L) 9-7/8" x 10-3/8" (251 x 264 mm) Min. Height: 14-13/16" (376 mm) Max. Height: 68-13/16" (1748 mm) Socket Size: Medium Base (E26 Socket) Recommended Bulb: T10, 5 inches from one end to the tip	BLL, 2PL	399.00
	K-32374-FM01	Kraga One-Light Flush Mount Dimensions: (L x W x H) 10-11/16" x 14" x 11-3/8" (271 x 357 x 289 mm) Socket Size: Medium Base (E26 Socket) Recommended Bulb: T10, 5 inches from one end to the tip	BLL, CPL 2PL	399.00

PRODUCT	MODEL NO.	DESCRIPTION	COLOR/ FINISH	LIST PRICE
Kraga Lighting Collection				
	K-32380-CH05	Kraga Five-Light Linear Chandelier Dimensions: (L x W) 6-3/4" x 45" (171 x 1143 mm) Min. Height: 23-5/8" (600 mm) Max. Height: 77-5/8" (1972 mm) Socket Size: G9 Recommended Bulb: G9 LED 5w (about 40w/60w equivalent)	BLL	\$1,999.00
	K-32382-CH05	Kraga Five-Light Chandelier Dimensions: (Diam. x H) 23-11/16" x 20" (602 x 508 mm) Min. Height: 28-5/8" (727 mm) Max. Height: 82-5/8" (2099 mm) Socket Size: G9 Recommended Bulb: G9 LED 5w (about 40w/60w equivalent)	BLL	1,999.00

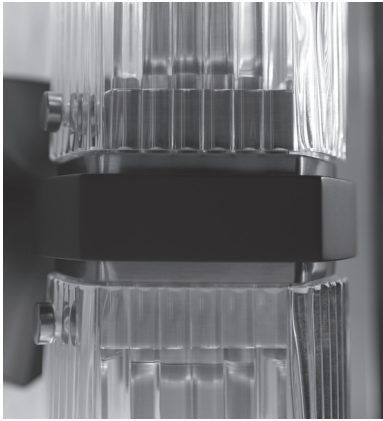



OCCASION

The Occasion lighting collection offers a modern rendition of 1960s Hollywood glamour. Faceted metal bases and fluted cylindrical glass shades combine in centerpieces as elegant as they are functional.

LIGHTING

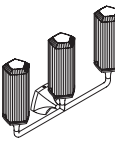
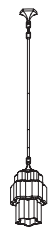
PRODUCT	MODEL NO.	DESCRIPTION	COLOR/FINISH	LIST PRICE
Occasion Lighting Collection				
	K-31775-SC01	Occasion One-Light Sconce Dimensions: (L x W x H) 6-1/2" x 5-1/4" x 16-3/8" (165 x 133 x 416 mm) Socket Size: Medium Base (E26 Socket) Recommended Bulb: T10	BLL, BML BNL, CPL SNL, 2GL	\$ 199.00
	K-31776-SC02	Occasion Two-Light Sconce Dimensions: (L x W x H) 6-1/2" x 14-3/16" x 16-3/8" (165 x 360 x 416 mm) Socket Size: Medium Base (E26 Socket) Recommended Bulb: T10	BLL, BML BNL, CPL SNL, 2GL	399.00
	K-31777-SC02	Occasion Two-Light Vertical Sconce Dimensions: (L x W x H) 7-3/8" x 5-1/4" x 20-11/16" (187 x 133 x 525 mm) Socket Size: Medium Base (E26 Socket) Recommended Bulb: T10	BLL, BML BNL, CPL SNL, 2GL	299.00





PRODUCT	MODEL NO.	DESCRIPTION	COLOR/FINISH	LIST PRICE
Occasion Lighting Collection				
	K-31778-SC03	Occasion Three-Light Sconce Dimensions: (L x W x H) 6-1/2" x 24-1/4" x 16-3/8" (165 x 616 x 416 mm) Socket Size: Medium Base (E26 Socket) Recommended Bulb: T10	BLL, BML BNL, CPL SNL, 2GL	\$ 499.00
	K-31781-PE03	Occasion Three-Light Pendant Dimensions: (Diam) 11-7/8" (302 mm) Min. Height: 33-5/8" (854 mm) Max. Height: 87-5/8" (2226 mm) Socket Size: Candelabra Base (E12) Recommended Bulb: T10	BLL, SNL 2GL	499.00
	K-31780-FM03	Occasion Three-Light Flush Mount Dimensions: (Diam. x H) 14-7/8" x 10-9/16" (378 x 268 mm) Socket Size: Candelabra Base (E12) Recommended Bulb: B11	BLL, SNL 2GL	599.00





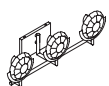
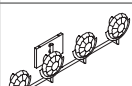

ARENDELA

Arendela takes inspiration from briolette, a type of gemstone faceting that was invented in the late 15th century. The briolette cut is a pear-shaped stone that has facets on the entire surface.

LIGHTING

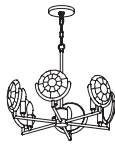
PRODUCT	MODEL NO.	DESCRIPTION	COLOR/ FINISH	LIST PRICE
Arendela Lighting Collection				
	K-29375-SC01B	Arendela One-Light Sconce Dimensions: (L x W x H) 5-3/4" x 7" x 8-1/8" (146 x 178 x 206 mm) Socket Size: Candelabra Base (E12) Recommended Bulb: B10, B11 or G16.5	BNL, CPL SNL, 2GL	\$ 199.00
	K-29376-SC02B	Arendela Two-Light Sconce Dimensions: (L x W x H) 7-5/16" x 17" x 7-7/8" (186 x 432 x 200 mm) Socket Size: Candelabra Base (E12) Recommended Bulb: B10, B11 or G16.5	BNL, CPL SNL, 2GL	299.00
	K-29377-SC03B	Arendela Three-Light Sconce Dimensions: (L x W x H) 7-5/16" x 27" x 7-7/8" (186 x 686 x 200 mm) Socket Size: Candelabra Base (E12) Recommended Bulb: B10, B11 or G16.5	BNL, CPL SNL, 2GL	399.00
	K-29378-SC04B	Arendela Four-Light Sconce Dimensions: (L x W x H) 7-5/16" x 37" x 7-7/8" (186 x 940 x 200 mm) Socket Size: Candelabra Base (E12) Recommended Bulb: B10, B11 or G16.5	BNL, CPL SNL, 2GL	519.00
	K-29373-FM03B	Arendela Three-Light Flush Mount Dimensions: (Diam. x H) 15" x 4-1/2" (381 x 114 mm) Socket Size: Candelabra Base (E12) Recommended Bulb: B10 or B11	BNL, CPL SNL, 2GL	379.00

PRODUCT	MODEL NO.	DESCRIPTION	COLOR/ FINISH	LIST PRICE
Arendela Lighting Collection				
	K-29374-SF03B	Arendela Three-Light Semi-Flush Mount Dimensions: (Diam. x H) 15-9/16" x 15-9/16" x 12-3/8" (395 x 314 mm) Socket Size: Candelabra Base (E12) Recommended Bulb: B10 or B11	BNL, CPL SNL, 2GL	\$ 349.00
	K-29382-CH08B	Arendela Eight-Light Linear Chandelier Dimensions: (L x W) 15-1/2" x 37-5/8" (394 x 956 mm) Min. Height: 19-1/16" (486 mm) Max. Height: 92-1/8" (2340 mm) Socket Size: Candelabra Base (E12) Recommended Bulb: B10, B11 or G16.5	SNL, 2GL	1,399.00
	K-29381-CH06B	Arendela Six-Light Chandelier Dimensions: (Diam.) 21-5/8" (549 mm) Min. Height: 19-3/4" (502 mm) Max. Height: 90" (2286 mm) Socket Size: Candelabra Base (E12) Recommended Bulb: B10, B11 or G16.5	SNL, 2GL	1,099.00
	K-29380-CH10B	Arendela Ten-Light Chandelier Dimensions: (Diam.) 28" (711 mm) Min. Height: 19-13/4" (502 mm) Max. Height: 90" (2286 mm) Socket Size: Candelabra Base (E12) Recommended Bulb: B10, B11 or G16.5	SNL, 2GL	2,199.00



MARGAUX

Redefine traditional styling with Margaux, which features a strong modern design that commands attention.

LIGHTING

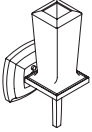
PRODUCT	MODEL NO.	DESCRIPTION	COLOR/FINISH	LIST PRICE
Margaux Lighting Collection				
	K-16268	<p>Margaux One-Light Sconce</p> <p>Dimensions: (L x W x H) 5-3/4" x 4-13/16" x 11-5/8" (146 x 122 x 295 mm)</p> <p>Socket Size: Medium Base (E26 Socket) Recommended Bulb: T10</p>	<p>AFL, BNL BVL, CPL SNL</p>	\$ 189.00





RIFF

Inspired by the French and Spanish architecture of the historical American South, Riff collection lighting offers a contemporary interpretation of traditional Southern design.

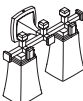
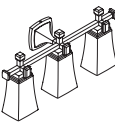
LIGHTING

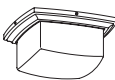
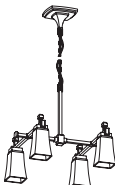
PRODUCT	MODEL NO.	DESCRIPTION	COLOR/ FINISH	LIST PRICE
Riff Lighting Collection				
	K-31755-SC01	Riff One-Light Sconce Dimensions: (L x W x H) 6-9/16" x 4-13/16" x 11-3/16" (167 x 122 x 284 mm) Socket Size: Medium Base (E26 Socket) Recommended Bulb: T10 or T8	BLL, BNL CPL, SNL 2GL	\$ 189.00
	K-31756-SC02	Riff Two-Light Sconce Dimensions: (L x W x H) 6-9/16" x 15-15/16" x 11-3/16" (167 x 405 x 284 mm) Socket Size: Medium Base (E26 Socket) Recommended Bulb: T10 or T8	BLL, BNL CPL, SNL 2GL	349.00
	K-31757-SC03	Riff Three-Light Sconce Dimensions: (L x W x H) 6-9/16" x 24-7/8" x 11-3/16" (167 x 632 x 284 mm) Socket Size: Medium Base (E26 Socket) Recommended Bulb: T10 or T8	BLL, BNL CPL, SNL 2GL	449.00



PRODUCT	MODEL NO.	DESCRIPTION	COLOR/ FINISH	LIST PRICE
Riff Lighting Collection				
	K-31760-FM02	Riff Two-Light Flush Mount Dimensions: (L x W x H) 14" x 14" x 6-13/16" (356 x 356 x 173 mm) Socket Size: Candelabra Base (E12) Recommended Bulb: G16.5	SNL, 2GL	\$ 429.00
	K-31758-CH04	Riff Four-Light Chandelier Dimensions: (Diam. x H) 30" x 23-9/16" (762 x 598 mm) Min. Height: 31-1/4" (794 mm) Max. Height: 101-1/2" (2578 mm) Socket Size: Medium Base (E26 Socket) Recommended Bulb: T10 or T8	SNL, 2GL	799.00
	K-31759-CH08	Riff Eight-Light Chandelier Dimensions: (Diam. x H) 35" x 23-9/16" (889 x 599 mm) Min. Height: 32-1/4" (819 mm) Max. Height: 101-9/16" (2580 mm) Socket Size: Medium Base (E26 Socket) Recommended Bulb: T10 or T8	SNL, 2GL	1,499.00



MEMOIRS

Inspired by elegant architecture and crown molding, Memoirs brings comfort and sophistication to your bathroom.

LIGHTING

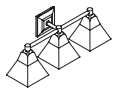
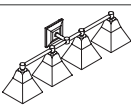



PRODUCT	MODEL NO.	DESCRIPTION	COLOR/ FINISH	LIST PRICE
Memoirs Lighting Collection				
	K-23686-SC01	Memoirs One-Light Sconce Dimensions: (L x W x H) 7-3/16" x 6-1/8" x 9-3/8" (183 x 156 x 238 mm) Socket Size: Medium Base (E26) Recommended Bulb: A19 or G25	BGL, BNL BZL, CPL SNL	\$ 189.00
	K-23687-BA02	Memoirs Two-Light Sconce Dimensions: (L x W x H) 7-3/16" x 15-1/8" x 9-3/8" (183 x 384 x 238 mm) Socket Size: Medium Base (E26) Recommended Bulb: A19 or G25	BGL, BNL BZL, CPL SNL	339.00
	K-23688-BA03	Memoirs Three-Light Sconce Dimensions: (L x W x H) 7-3/16" x 24-3/16" x 9-3/8" (183 x 614 x 238 mm) Socket Size: Medium Base (E26) Recommended Bulb: A19 or G25	BGL, BNL BZL, CPL SNL	449.00
	K-23689-BA04	Memoirs Four-Light Sconce Dimensions: (L x W x H) 7-3/16" x 33-3/16" x 9-3/8" (183 x 843 x 238 mm) Socket Size: Medium Base (E26) Recommended Bulb: A19 or G25	BGL, BNL BZL, CPL SNL	599.00







ARTIFACTS

Timeless in its inspiration, the Artifacts collection combines quality craftsmanship with artisan designs to lend character and authenticity to your space.

LIGHTING

PRODUCT	MODEL NO.	DESCRIPTION	COLOR/ FINISH	LIST PRICE
Artifacts Lighting Collection				
	K-72584	Artifacts One-Light Sconce Dimensions: (L x W x H) 7-1/2" x 4-1/8" x 13-3/16" (191 x 105 x 335 mm) Socket Size: Medium Base (E26) Recommended Bulb: T-10 (w/ included frosted shade); ST19 or A19 (w/out included frosted shade)	BLL, BNL BVL, BZL CPL, SNL 2GL	\$ 179.00
			AFL, TTL	219.00
	K-72582	Artifacts Two-Light Sconce Dimensions: (L x W x H) 7-7/16" x 18-3/16" x 13-1/4" (189 x 462 x 337 mm) Socket Size: Medium Base (E26) Recommended Bulb: T-10 (w/ included frosted shade); ST19 or A19 (w/out included frosted shade)	BLL, BNL BVL, BZL CPL, SNL 2GL	299.00
			AFL, TTL	379.00
	K-32806-SC03	Artifacts Three-Light Sconce Dimensions: (L x W x H) 7-7/16" x 23" x 13-5/16" (189 x 584 x 338 mm) Socket Size: Medium Base (E26) Recommended Bulb: T-10 (w/ included frosted shade); ST19 or A19 (w/out included frosted shade)	BLL, BNL BVL, BZL CPL, SNL 2GL	369.00
			AFL, TTL	459.00
	K-72581	Artifacts One-Light Adjustable Sconce Dimensions: (L x W x H) 9-7/16" x 5-3/8" x 16-3/4" (240 x 137 x 425 mm) Socket Size: Medium Base (E26) Recommended Bulb: T-10 (w/ included frosted shade); ST19 or A19 (w/out included frosted shade)	BLL, BNL BVL, BZL CPL, SNL 2GL	399.00
			AFL, TTL	499.00
	K-22653-PE01	Artifacts One-Light Pendant Dimensions: (Diam.) 4-1/8" (105 mm) Min. Height: 12-5/16" (313 mm) Max. Height: 129-7/8" (3299 mm) Socket Size: Medium Base (E26) Recommended Bulb: T-10 (w/ included frosted shade); ST19 or A19 (w/out included frosted shade)	BLL, BNL BVL, BZL CPL, SNL 2GL	199.00
			AFL, TTL	249.00

LIGHTING

PRODUCT	MODEL NO.	DESCRIPTION	COLOR/ FINISH	LIST PRICE
Artifacts Lighting Collection				
	K-22654-PE01	Artifacts One-Light Adjustable Pendant Dimensions: (Diam.) 8" (203 mm) Min. Height: 18-1/2" (470 mm) Max. Height: 138-1/2" (3518 mm) Socket Size: Medium Base (E26) Recommended Bulb: T-10 (w/ included frosted shade); ST19 or A19 (w/out included frosted shade)	BGL, BZL CPL, SNL	\$ 299.00
	K-22655-PE03	Artifacts Three-Light Pendant Cloud Dimensions: (Diam.) 10-13/16" (275 mm) Min. Height: 26-3/8" (670 mm) Max. Height: 146-3/8" (3718 mm) Socket Size: Medium Base (E26) Recommended Bulb: T-10 (w/ included frosted shade); ST19 or A19 (w/out included frosted shade)	BGL, BZL CPL, SNL	729.00
	K-22659-CH03	Artifacts Three-Light Adjustable Linear Chandelier Dimensions: (L x W) 5" x 26-7/8" (127 x 683 mm) Min. Height: 18-1/2" (470 mm) Max. Height: 138-1/2" (3518 mm) Socket Size: Medium Base (E26) Recommended Bulb: T-10 (w/ included frosted shade); ST19 or A19 (w/out included frosted shade)	BGL, BZL CPL, SNL	999.00
	K-22657-CH03	Artifacts Three-Light Chandelier Dimensions: (Diam.) 22-1/16" (560 mm) Min. Height: 14-5/16" (364 mm) Max. Height: 134-5/16" (3412 mm) Socket Size: Medium Base (E26) Recommended Bulb: T-10 (w/ included frosted shade); ST19 or A19 (w/out included frosted shade)	BGL, BZL CPL, SNL	899.00
	K-22656-CH03	Artifacts Three-Light Shaded Chandelier Dimensions: (Diam.) 22-1/16" (560 mm) Min. Height: 38-9/16" (980 mm) Max. Height: 108-5/8" (2759 mm) Socket Size: Medium Base (E26) Recommended Bulb: T-10 (w/ included frosted shade); ST19 or A19 (w/out included frosted shade)	BGL, BZL CPL, SNL	1,799.00





PAROHN

The Parohn collection reflects a high style modern look, inspired by the classic designs of the 1930s and 40s which reinterpreted the aesthetic of the Bauhaus in luxurious materials.

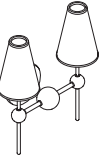
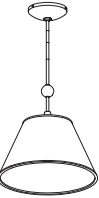
LIGHTING

PRODUCT	MODEL NO.	DESCRIPTION	COLOR/ FINISH	LIST PRICE
Parohn Lighting Collection				
	K-27858-SC01	Parohn One-Light Sconce Dimensions: (L x W x H) 7-1/8" x 5-1/2" x 16-3/4" (181 x 140 x 425 mm) Socket Size: Candelabra Base (E12) Recommended Bulb: B10 or B11	CPL, GNL SNL, 2GL 2PL	\$ 189.00
	K-27860-SC02	Parohn Two-Light Sconce Dimensions: (L x W x H) 16" x 16" x 11-7/8" (406 x 406 x 302 mm) Socket Size: Candelabra Base (E12) Recommended Bulb: B10 or B11	CPL, GNL SNL, 2GL 2PLL	329.00
	K-27861-PE01	Parohn One-Light Pendant Dimensions: (Diam.) 14-3/8" (365 mm) Min. Height: 18-15/16" (481 mm) Max. Height: 75-15/16" (1929 mm) Socket Size: Medium Base (E26) Recommended Bulb: A19	CPL, GNL SNL, 2GL 2PL	389.00





PRODUCT	MODEL NO.	DESCRIPTION	COLOR/ FINISH	LIST PRICE
Parohn Lighting Collection				
	K-27859-FM02	Parohn Two-Light Flush Mount Dimensions: (L x W x H) 7-1/8" x 15-1/8" x 16-3/4" (181 x 384 x 426 mm) Socket Size: Medium Base (E26) Recommended Bulb: A19	GNL, SNL 2GL, 2PL	\$ 349.00
	K-27862-CH04	Parohn Four-Light Chandelier Dimensions: (L x W) 26-1/4" x 26-1/4" (667 x 667 mm) Min. Height: 32-15/16" (837 mm) Max. Height: 101-7/8" (2588 mm) Socket Size: Candelabra Base (E12) Recommended Bulb: B10 or B11	GNL, SNL 2GL, 2PL	899.00
	K-27863-CH08	Parohn Eight-Light Chandelier Dimensions: (L x W) 36-1/8" x 36-1/8" (918 x 918) Min. Height: 39-7/8" (1013 mm) Max. Height: 109" (2769 mm) Socket Size: Candelabra Base (E12) Recommended Bulb: B10 or B11	GNL, SNL 2GL, 2PL	1,729.00





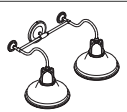
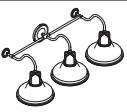

HAUKSBEE

The design of the Hauksbee collection is drawn from the lighting created for factories, farms, and industrial spaces in the 1920s and 30s.

LIGHTING

PRODUCT	MODEL NO.	DESCRIPTION	COLOR/FINISH	LIST PRICE
Hauksbee Lighting Collection				
	K-32281-SC01	Hauksbee One-Light Bell Sconce Dimensions: (L x W x H) 9-5/8" x 7-3/8" x 13-3/4" (244 x 187 x 349 mm) Socket Size: Medium Base (E26 Socket) Recommended Bulb: A19 or G25	BLL, BNL CPL, SNL 2GL	\$ 159.00
	K-32282-SC02	Hauksbee Two-Light Bell Sconce Dimensions: (L x W x H) 9-5/8" x 18-1/4" x 13-5/8" (244 x 464 x 346 mm) Socket Size: Medium Base (E26 Socket) Recommended Bulb: A19 or G25	BLL, BNL CPL, SNL 2GL	319.00
	K-32283-SC03	Hauksbee Three-Light Bell Sconce Dimensions: (L x W x H) 9-5/8" x 28-1/8" x 13-5/8" (244 x 714 x 346 mm) Socket Size: Medium Base (E26 Socket) Recommended Bulb: A19 or G25	BLL, BNL CPL, SNL 2GL	359.00
	K-32285-SC01	Hauksbee One-Light Sconce Dimensions: (L x W x H) 15-11/16" x 9-11/16" x 11-1/4" (398 x 246 x 286 mm) Socket Size: Medium Base (E26 Socket) Recommended Bulb: A19 or G25	BML, WCL WGL	299.00
	K-32286-SC02	Hauksbee Two-Light Sconce Dimensions: (L x W x H) 15-11/16" x 24-11/16" x 11-1/4" (398 x 627 x 286 mm) Socket Size: Medium Base (E26 Socket) Recommended Bulb: A19 or G25	BML, WCL WGL	499.00
	K-32287-SC03	Hauksbee Three-Light Sconce Dimensions: (L x W x H) 15-3/4" x 34-11/16" x 11-1/4" (400 x 881 x 286 mm) Socket Size: Medium Base (E26 Socket) Recommended Bulb: A19 or G25	BML, WCL WGL	679.00

LIGHTING



PRODUCT	MODEL NO.	DESCRIPTION	COLOR/ FINISH	LIST PRICE
Hauksbee Lighting Collection				
	K-32288-SC04	Hauksbee Four-Light Sconce Dimensions: (L x W x H) 15-3/4" x 47-1/8" x 11-1/4" (400 x 1197 x 286 mm) Socket Size: Medium Base (E26 Socket) Recommended Bulb: A19 or G25	BML,WCL WGL	\$ 879.00
	K-32290-PE03	Hauksbee Three-Light XL Pendant Dimensions: (L x W x H) 17-15/16" Diam. (456 mm) Min. Height: 30-5/16" (770 mm) Max. Height: 99-9/16" (2529 mm) Socket Size: Medium Base (E26 Socket) Recommended Bulb: A19 or G25	BML,WCL WGL	539.00
	K-32294-SF03	Hauksbee Three-Light Semi-Flush Mount Dimensions: (L x W x H) 17-15/16" x 17-15/16" x 13-15/16" (456 x 456 x 354 mm) Socket Size: Medium Base (E26 Socket) Recommended Bulb: A19 or G25	BML,WCL WGL	529.00
	K-32292-CH03	Hauksbee Three-Light Linear Chandelier Dimensions: (L x W) 12-7/16" x 42-1/8" (316 x 1070 mm) Min. Height: 15-1/4" (387 mm) Max. Height: 72-1/4" (1835 mm) Socket Size: Medium Base (E26 Socket) Recommended Bulb: A19 or G25	BML,WCL WGLL	1,199.00
	K-32293-CH03	Hauksbee Three-Light Chandelier Dimensions: (L x W) 30-1/4" x 30-1/4" (768 mm) Min. Height: 15-1/4" (387 mm) Max. Height: 72-1/4" (1835 mm) Socket Size: Medium Base (E26 Socket) Recommended Bulb: A19 or G25	BML,WCL WGL	1,199.00



BANCROFT

Bancroft captures the elegance of early 1900s American design with its traditional and enduring style.

LIGHTING





PRODUCT	MODEL NO.	DESCRIPTION	COLOR/FINISH	LIST PRICE
Bancroft Lighting Collection				
	K-11421	Bancroft One-Light Sconce Dimensions: (L x W x H) 6-7/8" x 4-9/16" x 7-15/16" (175 x 116 x 202 mm) Socket Size: Medium Base (E26) Recommended Bulb: A19	BNL, BZL CPL, SNL	\$ 159.00
	K-11422	Bancroft Two-Light Sconce Dimensions: (L x W x H) 6-7/8" x 15-1/6" x 8-11/16" (175 x 385 x 221 mm) Socket Size: Medium Base (E26) Recommended Bulb: A19	BNL, BZL CPL, SNL	269.00
	K-11423	Bancroft Three-Light Sconce Dimensions: (L x W x H) 6-13/16" x 15-3/4" x 8-15/16" (173 x 400 x 227 mm) Socket Size: Medium Base (E26) Recommended Bulb: A19	BNL, BZL CPL, SNL	349.00



BELLERA

Distinguished by elegant, jewelry-inspired silhouettes, the Bellera lighting collection delivers versatility with a transitional style that easily flows with your entire home's aesthetic.

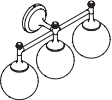
LIGHTING

PRODUCT	MODEL NO.	DESCRIPTION	COLOR/ FINISH	LIST PRICE
Bellera Lighting Collection				
	K-31761-SC01	Bellera One-Light Sconce Dimensions: (L x W x H) 7-7/8" x 5-7/8" x 13-1/2" (200 x 149 x 343 mm) Socket Size: Candelabra Base (E12) Recommended Bulb: T10	BLL, BNL BZL, CPL 2GL	\$ 149.00
	K-31762-SC02	Bellera Two-Light Sconce Dimensions: (L x W x H) 7-7/8" x 5-7/8" x 17-5/16" (200 x 149 x 343 mm) Socket Size: Candelabra Base (E12) Recommended Bulb: T10	BLL, BNL BZL, CPL 2GL	249.00
	K-31763-SC03	Bellera Three-Light Sconce Dimensions: (L x W x H) 7-7/8" x 21-7/8" x 10-1/8" (200 x 556 x 257 mm) Socket Size: Candelabra Base (E12) Recommended Bulb: T10	BLL, BNL BZL, CPL 2GL	349.00
	K-31764-FM02	Bellera Two-Light Flush Mount Dimensions: (Diam. x H) 15" x 15" x 13-1/4" (381 x 381 x 337 mm) Socket Size: Medium Base (E26 Socket) Recommended Bulb: G16.5	SNL, 2GL	399.00

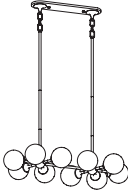
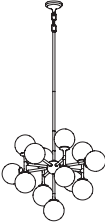
PRODUCT	MODEL NO.	DESCRIPTION	COLOR/ FINISH	LIST PRICE
Bellera Lighting Collection				
	K-31765-PE01	Bellera One-Light Pendant Dimensions: (Diam.) 13-3/4" (349 mm) Min. Height: 30-1/2" (775 mm) Max. Height: 84-1/2" (2146 mm) Socket Size: Medium Base (E26 Socket) Recommended Bulb: G25	SNL, 2GL	\$ 599.00
	K-31766-CH10	Bellera Ten-Light Linear Chandelier Dimensions: (L x W) 19-7/8" x 38-3/16" (505 x 970 mm) Min. Height: 17-5/16" (440 mm) Max. Height: 84-1/2" (2146 mm) Socket Size: Candelabra Base (E12) Recommended Bulb: T10	SNL, 2GL	1,199.00
	K-31767-CH13	Bellera Thirteen-Light Chandelier Dimensions: (Diam.) 32" (813 mm) Min. Height: 31-1/16" (789 mm) Max. Height: 85-1/16" (2161 mm) Socket Size: Candelabra Base (E12) Recommended Bulb: T10	SNL, 2GL	1,499.00



PURIST

Combining architectural forms with sensual design lines, Purist brings a touch of modern elegance to your home.

LIGHTING

PRODUCT	MODEL NO.	DESCRIPTION	COLOR/ FINISH	LIST PRICE
Purist Lighting Collection				
	K-27262-SC01	Purist One-Light Sconce Dimensions: (L x W x H) 7-5/16" x 4-3/4" x 13" (186 x 121 x 330 mm) Socket Size: Medium Base (E26 Socket) Recommended Bulb: T10	BLL, BNL BVL, CPL SNL, 2GL	\$ 139.00
	K-32375-SC01	Purist One-Light Sconce Dimensions: (L x W x H) 4-3/4" x 4-9/16" x 16-7/16" (121 x 116 x 418 mm) Socket Size: Candelabra Base (E12) Recommended Bulb: B10, B11 or G16.5	BLL, BML BNL, BVL CPL, SNL 2GL	199.00
	K-27263-SC02	Purist 22" (559 mm) Two-Light Sconce Dimensions: (L x W x H) 6-7/8" x 4-3/4" x 22" (175 x 121 x 559 mm) Socket Size: Medium Base (E26 Socket) Recommended Bulb: T10	BLL, BNL BVL, CPL SNL, 2GL	199.00
	K-27264-SC02	Purist 29" (737 mm) Two-Light Sconce Dimensions: (L x W x H) 6-7/8" x 4-3/4" x 29-3/8" (175 x 121 x 746 mm) Socket Size: Medium Base (E26 Socket) Recommended Bulb: T10	BLL, BNL BVL, CPL SNL, 2GL	269.00
			AFL, TTL	339.00





PRODUCT	MODEL NO.	DESCRIPTION	COLOR/ FINISH	LIST PRICE
Purist Lighting Collection				
	K-27265-PE02	Purist Two-Light Pendant Dimensions: (Diam.) 12-5/8" (321 mm) Min. Height: 15-7/16" (392 mm) Max. Height: 69-7/16" (1764 mm) Socket Size: Medium Base (E26 Socket) Recommended Bulb: T14	BLL, BNL BVL, CPL SNL, 2GL	369.00
	K-27266-PE04	Purist Four-Light XL Pendant Dimensions: (Diam.) 18-1/8" (460 mm) Min. Height: 19-3/8" (492 mm) Max. Height: 73-3/8" (1864 mm) Socket Size: Medium Base (E26 Socket) Recommended Bulb: T14	BLL	649.00
	K-27267-CHLED	Purist Linear LED Chandelier Dimensions: (L x W) 5" x 33-15/16" (127 x 862 mm) Min. Height: 16-1/16" (408 mm) Max. Height: 70-1/16" (1780 mm) Recommended Bulb: Included	BLL, 2GL	1,099.00



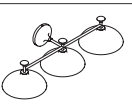

TONE

With domed, clear-glass shades, mixed-metal trumpet bases, and intersecting rod supports, the Tone lighting collection delivers a fresh take on midcentury modern style.

LIGHTING

PRODUCT	MODEL NO.	DESCRIPTION	COLOR/FINISH	LIST PRICE
Tone Lighting Collection				
	K-31768-SC01	Tone One-Light Sconce Dimensions: (L x W x H) 10-3/4" x 9-1/8" x 6-11/16" (273 x 232 x 170 mm) Socket Size: Candelabra Base (E12) Recommended Bulb: G16.5	BLL, BML BNL, CBL CPL, 2GL	\$ 129.00
	K-31769-SC02	Tone Two-Light Sconce Dimensions: (L x W x H) 10-3/4" x 20-3/16" x 6-11/16" (273 x 513 x 170) Socket Size: Candelabra Base (E12) Recommended Bulb: G16.5	BLL, BML BNL, CBL CPL, 2GL	239.00
	K-31770-SC03	Tone Three-Light Sconce Dimensions: (L x W x H) 10-3/4" x 31-3/16" x 6-11/16" (273 x 792 x 170 mm) Socket Size: Candelabra Base (E12) Recommended Bulb: G16.5	BLL, BML BNL, CBL CPL, 2GL	349.00
	K-31771-PE01	Tone One-Light Pendant Dimensions: (Diam.) 14-3/4" (375 mm) Min. Height: 24-1/2" (622 mm) Max. Height: 96-1/2" (2451 mm) Socket Size: Medium Base (E26 Socket) Recommended Bulb: G25	BLL, BML SNL	199.00



PRODUCT	MODEL NO.	DESCRIPTION	COLOR/FINISH	LIST PRICE
Tone Lighting Collection				
	K-31772-FM01	Tone One-Light Flush Mount Dimensions: (Diam. x H) 14-3/4" x 7-3/8" (375 x 187 mm) Socket Size: Medium Base (E26 Socket) Recommended Bulb: G25	BLL, BML SNL	\$ 249.00
	K-31773-CH04	Tone Four-Light Chandelier Dimensions: (Diam.) 24-1/4" (616 mm) Min. Height: 35-1/4" (895 mm) Max. Height: 89-1/4" (2267 mm) Socket Size: Candelabra Base (E12) Recommended Bulb: G16.5	BLL, BML SNL	599.00
	K-31774-CH08	Tone Eight-Light Linear Chandelier Dimensions: (L x W) 25-9/16" x 41-1/16" (649 x 1043 mm) Min. Height: 22-7/16" (570 mm) Max. Height: 92-13/16" (2357 mm) Socket Size: Candelabra Base (E12) Recommended Bulb: G16.5	BLL, BML SNL	1,199.00



DEVONSHIRE

With a striking combination of curves and lines reminiscent of old-world design, Devonshire accessories provide distinctive visual impact for bath and powder rooms. This single wall sconce offers versatile lighting options in a stylish vintage design, coordinating perfectly with the Devonshire Collection.

LIGHTING

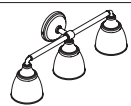

PRODUCT	MODEL NO.	DESCRIPTION	COLOR/ FINISH	LIST PRICE
Devonshire Lighting Collection				
	K-10570	Devonshire One-Light Sconce Dimensions: (L x W x H) 4-15/16" x 6" x 9-1/8" (125 x 152 x 232 mm) Socket Size: Medium Base (E26) Recommended Bulb: A19	BLL	\$ 89.00
			BML, BNL BZL, CPL 2GL	99.00
	K-10571	Devonshire Two-Light Sconce Dimensions: (L x W x H) 15" x 6" x 9-1/8" (381 x 152 x 232 mm) Socket Size: Medium Base (E26) Recommended Bulb: A19	BLL	119.00
			BML, BNL BZL, CPL 2GL	139.00
	K-10572	Devonshire Three-Light Sconce Dimensions: (L x W x H) 23-1/6" x 6" x 9-1/8" (586 x 152 x 232 mm) Socket Size: Medium Base (E26) Recommended Bulb: A19	BLL	179.00
			BML, BNL BZL, CPL 2GL	199.00



FORTÉ

With domed, clear-glass shades, mixed-metal trumpet bases, and intersecting rod supports, the Tone lighting collection delivers a fresh take on midcentury modern style.

LIGHTING

PRODUCT	MODEL NO.	DESCRIPTION	COLOR/ FINISH	LIST PRICE
Forté Lighting Collection				
	K-11365	Forté One-Light Sconce Dimensions: (L x W x H) 5-1/2" x 7" x 8-13/16" (140 x 178 x 224 mm) Socket Size: Medium Base (E26) Recommended Bulb: A19	BLL, BNL CPL	\$ 89.00
	K-11366	Forté Two-Light Sconce Dimensions: (L x W x H) 15-1/2" x 6-9/16 x 8-13/16" (394 x 167 x 224 mm) Socket Size: Medium Base (E26) Recommended Bulb: A19	BLL, BNL CPL	119.00
	K-11367	Forté Three-Light Sconce Dimensions: (L x W x H) 22-13/16" x 6-15/16 x 8-13/16" (579 x 176 x 224 mm) Socket Size: Medium Base (E26) Recommended Bulb: A19	BLL, BNL CPL	179.00

COMMERCIAL SOLUTIONS

COMPOSED® WALL-MOUNT FAUCETS WITH KINESIS TECHNOLOGY

Max flow rate: 0.5 gpm (1.9 l/min)

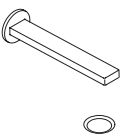
PRODUCT	MODEL NO.	DESCRIPTION	COLOR/FINISH	LIST PRICE
Note: If tempered or premixed water is desired, order K-99799 Thermostatic Mixing Valve (see Options).				
AC-Powered				
	K-123C36-SANA	Composed Touchless Wall-Mount Faucet with Kinesis Sensor Technology On-demand usage with 30-second max. continual run cycle Spout reach: 8-9/16" (218 mm) Vandal-resistant aerator 18" (457 mm) Flexible supply hose Grid drain Single-hole mounting Requires K-13480/-A or K-13481/-A power supply (see Options)	BL	\$1,032.50

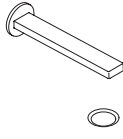
PRODUCT	MODEL NO.	DESCRIPTION	COLOR/FINISH	LIST PRICE
DC-Powered				
	K-124C36-SANA	Composed Touchless Wall-Mount Faucet with Kinesis Sensor Technology On-demand usage with 30-second max. continual run cycle Spout reach: 8-9/16" (218 mm) Vandal-resistant aerator 18" (457 mm) Flexible supply hose Grid drain Single-hole mounting AA battery-powered; up to four-year battery life (approx. 105,000 cycles)	BL	\$1,032.50

TAUT® SINGLE-HANDLE BATHROOM SINK FAUCET

Max flow rate: 0.5 gpm (1.9 l/min)

PRODUCT	MODEL NO.	DESCRIPTION	COLOR/FINISH	LIST PRICE
	K-46028-4	Taut Single-Handle Bathroom Sink Faucet Spout reach: 3-15/16" (100 mm) Spout height: 3-9/16" (91 mm) (base to outlet) Vandal-resistant aerator Lever handle Flexible supplies Less drain and lift rod For single-hole installation	BN	\$ 241.90

TRITON® BOWE® CENTERSET BATHROOM SINK FAUCET

Max flow rate: 1.0 gpm (3.8 lpm)

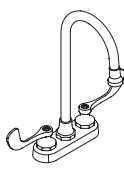
PRODUCT	MODEL NO.	DESCRIPTION	COLOR/FINISH	LIST PRICE
	K-400T70-5AKC	Triton Bowe 4 Gooseneck - Centerset Bathroom Sink Faucet Gooseneck spout Spout reach: 5-3/16" (132 mm) Spout height: 7-3/4" (197 mm) (base to outlet) Vandal-resistant aerator Lever handles Less drain and lift rod For 4" (102 mm) centers	CP	\$ 227.30

TRITON BOWE WIDESPREAD BATHROOM SINK FAUCET

Max flow rate: 1.0 gpm (3.8 lpm)

PRODUCT	MODEL NO.	DESCRIPTION	COLOR/FINISH	LIST PRICE
	K-800T70-5AKC	Triton Bowe 8 Gooseneck - Widespread Bathroom Sink Faucet Gooseneck spout Spout reach: 5-3/16" (132 mm) Spout height: 7-9/16" (192 mm) (base to outlet) Vandal-resistant aerator Wristblade lever handles Less drain and lift rod For 8" to 16" (203 mm to 406 mm) centers	CP	\$ 324.50

THE BOLD LOOK
OF **KOHLER**®



Touchless products comply with the actuation force limitations of the 2010 ADA Standards for Accessible Design, Section 309 Operable Parts, of the Act.
Lever handles comply with the actuation force limitations of the 2010 ADA Standards for Accessible Design, Section 309 Operable Parts, of the Act.





Featuring Mach™ TRIPOINT®



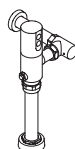

- Reduces false actuations due to light and color variations
- Features a new patented MACH piston that utilizes leading-edge materials to deliver unparalleled performance and accuracy
- Reliable, consistent performance in a range of commercial environments
- 24-hour sentinel flush keeps trapway fresh
- Humidity- and submersion-proof
- 5- to 7-year expected battery life based on 30,000 actuations per year

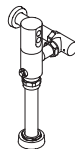

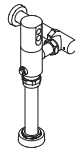
HYBRIDenergysystem

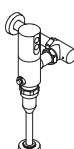
TRIPOINT HYBRID ENERGY CELL POWERED FLUSHOMETERS

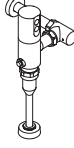
PRODUCT	MODEL NO.	DESCRIPTION	COLOR/FINISH	LIST PRICE
	K-10TH00K10 	Mach Touchless Flushometer with Tripoint Technology Fixture-mount design Electronic infrared sensor with TriPoint technology for accurate activation 1.0 gallon (3.79 litre) flush flow rate Includes one hybrid energy cell For use with toilet installations with 1-1/2" (38 mm) top spud coupling connection	CP	\$ 832.45
	K-10TH00N10 	Mach Touchless Flushometer with Tripoint Technology Fixture-mount design Electronic infrared sensor for accurate activation 1.28 gallon (4.85 litre) flush flow rate Includes one hybrid energy cell For use with toilet installations with 1-1/2" (38 mm) top spud coupling connection	CP	832.45
	K-10TH00N10-RF 	Retrofit design Does not include vacuum breaker and control stop	CP	754.25
	K-10TH00R10	Mach Touchless Flushometer with Tripoint Technology Fixture-mount design Electronic infrared sensor for accurate activation 1.6 gallon (6.05 litre) flush flow rate Includes one hybrid energy cell For use with toilet installations with 1-1/2" (38 mm) top spud coupling connection	CP	832.75
	K-10TH00R10-RF	Retrofit design Does not include vacuum breaker and control stop	CP	754.25

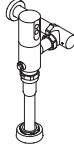
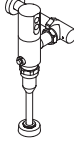
PRODUCT	MODEL NO.	DESCRIPTION	COLOR/FINISH	LIST PRICE
	K-10UH00D20 	Mach Touchless Flushometer with Tripoint Technology Fixture-mount design 0.125 gallon (0.47 litre) flush flow rate Includes one hybrid energy cell Intended for urinal installations with 3/4" (19 mm) top spud coupling connection	CP	\$ 832.75
	K-10UH00D20-RF 	Retrofit design Does not include vacuum breaker and control stop	CP	754.25
	K-10UH00G20 	Mach Touchless Flushometer with Tripoint Technology Fixture-mount design 0.5 gallon (1.89 litre) flush flow rate Intended for urinal installations with 3/4" (19 mm) top spud coupling connection	CP	832.75
	K-10UH00G20-RF 	Retrofit design Does not include vacuum breaker and control stop	CP	754.25
	K-10UH00K30	Mach Touchless Flushometer with Tripoint Technology Fixture-mount design 1.0 gallon (3.79 litre) flush flow rate For use with wash-down, washout, siphon jet and blow-out urinal installations with 3/4" (19 mm) top spud coupling connection	CP	841.10
	K-10UH00K30-RF	Retrofit design Does not include vacuum breaker and control stop	CP	754.25
	K-10UH00K20	Mach Touchless Flushometer with Tripoint Technology Fixture-mount design 1.0 gallon (3.79 litre) flush flow rate For use with washout urinal installations with 3/4" top spud coupling connection	CP	841.10



Touchless products comply with the actuation force limitations of the 2010 ADA Standards for Accessible Design, Section 309 Operable Parts, of the Act.

THE BOLD LOOK
OF **KOHLER**

TOUCHLESS ELECTRONIC FLUSHOMETERS









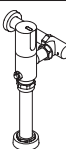

HYBRIDenergysystem

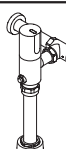
Featuring Mach® WAVE

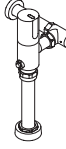
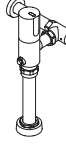
- User-controlled flush eliminates false actuations
- Features a new patented MACH piston that utilizes leading-edge materials to deliver unparalleled performance and accuracy
- Reliable, consistent performance in a range of commercial environments
- 24-hour sentinel flush keeps trapway fresh
- Humidity- and submersion-proof
- Includes a hybrid energy cell, that requires no charging, and provides maintenance-free power for an expected 30 years based on 30,000 actuations per year

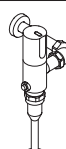
WAVE HYBRID ENERGY CELL POWERED FLUSHOMETERS

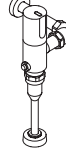
PRODUCT	MODEL NO.	DESCRIPTION	COLOR/FINISH	LIST PRICE
	K-40TH00K10 	Mach Touchless Flushometer with WAVE Technology Fixture-mount design 1.0 gallon (3.79 litre) flush flow rate Includes one hybrid energy cell For use with toilet installations with 1-1/2" (38 mm) top spud coupling connection	CP	\$ 852.55
	K-40TH00N10 	Mach Touchless Flushometer with WAVE Technology Fixture-mount design 1.28 gallon (4.85 litre) flush flow rate Includes one hybrid energy cell For use with toilet installations with 1-1/2" (38 mm) top spud coupling connection	CP	852.55
	K-40TH00N10-RF 	Retrofit design Does not include vacuum breaker and control stop	CP	737.75
	K-40TH00R10	Mach Touchless Flushometer with WAVE Technology Fixture-mount design 1.6 gallon (6.06 litre) flush flow rate Includes one hybrid energy cell For use with toilet installations with 1-1/2" (38 mm) top spud coupling connection	CP	852.55
	K-40TH00R10-RF	Retrofit design Does not include vacuum breaker and control stop	CP	730.45
	K-40TH00V10	Mach Touchless Flushometer with WAVE Technology Fixture-mount design 3.5 gallon (13.25 litre) flush flow rate Includes one hybrid energy cell For use with toilet installations with 1-1/2" (38 mm) top spud coupling connection	CP	852.55

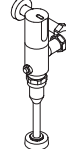
PRODUCT	MODEL NO.	DESCRIPTION	COLOR/FINISH	LIST PRICE
	K-40UH00D20 	Mach Touchless Flushometer with WAVE Technology Fixture-mount design 0.125 gallon (0.47 litre) flush flow rate Includes one hybrid energy cell Intended for urinal installations with 3/4" (19 mm) top spud coupling connection	CP	\$ 852.55
	K-40UH00D20-RF 	Retrofit design Does not include vacuum breaker and control stop	CP	737.75
	K-40UH00G20 	Mach Touchless Flushometer with WAVE Technology Fixture-mount design 0.5 gallon (1.89 litre) flush flow rate Includes one hybrid energy cell Intended for urinal installations with 3/4" (19 mm) top spud coupling connection	CP	852.55
	K-40UH00G20-RF 	Retrofit design Does not include vacuum breaker and control stop	CP	730.45
	K-40UH00K20	Mach Touchless Flushometer with WAVE Technology Fixture-mount design 1.0 gallon (3.79 litre) flush flow rate Includes one hybrid energy cell Intended for urinal installations with 3/4" (19 mm) top spud coupling connection	CP	852.55
	K-40UH00K20-RF	Retrofit design Does not include vacuum breaker and control stop	CP	723.50

THE BOLD LOOK
OF **KOHLER**



Touchless products comply with the actuation force limitations of the 2010 ADA Standards for Accessible Design, Section 309 Operable Parts, of the Act.

TOUCHLESS ELECTRONIC FLUSHOMETERS





Featuring Mach® TRIPOINT®



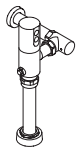

- Reduces false actuations due to light and color variations
- Features a new patented MACH piston that utilizes leading-edge materials to deliver unparalleled performance and accuracy
- Reliable, consistent performance in a range of commercial environments
- 24-hour sentinel flush keeps trapway fresh
- Humidity- and submersion-proof
- 5- to 7-year expected battery life based on 30,000 actuations per year

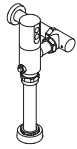

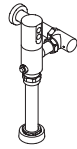
HYBRIDenergysystem

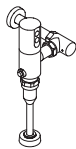
TRIPOINT DC POWERED FLUSHOMETERS

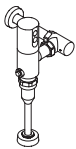
PRODUCT	MODEL NO.	DESCRIPTION	COLOR/FINISH	LIST PRICE
	K-10TD00K10 	Mach Touchless Flushometer with TRIPOINT Technology Fixture-mount design Electronic infrared sensor with TriPoint technology for accurate activation 1.0 gallon (3.79 litre) flush flow rate Includes a lithium battery pack (two AA's) For use with toilet installations with 1-1/2" (38 mm) top spud coupling connection	CP	\$ 666.25
	K-10TD00N10 	Mach Touchless Flushometer with TRIPOINT Technology Fixture-mount design Electronic infrared sensor with TriPoint technology for accurate activation 1.28 gallon (4.85 litre) flush flow rate Includes a lithium battery pack (two AA's) For use with toilet installations with 1-1/2" (38 mm) top spud coupling connection	CP	666.25
	K-10TD00N10-RF 	Retrofit design Does not include vacuum breaker and control stop	CP	600.30
	K-10TD00R10	Mach Touchless Flushometer with TRIPOINT Technology Fixture-mount design Electronic infrared sensor with TriPoint technology for accurate activation 1.6 gallon (6.06 litre) flush flow rate Includes a lithium battery pack (two AA's) For use with toilet installations with 1-1/2" (38 mm) top spud coupling connection	CP	666.25
	K-10TD00R10-RF	Retrofit design Does not include vacuum breaker and control stop	CP	600.30

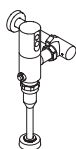
PRODUCT	MODEL NO.	DESCRIPTION	COLOR/FINISH	LIST PRICE
	K-10UD00D20 	Mach Touchless Flushometer with TRIPOINT Technology Fixture-mount design 0.125 gallon (0.47 litre) flush flow rate Includes a lithium battery pack (two AA's) Intended for urinal installations with 3/4" (19 mm) top spud coupling connection	CP	\$ 666.25
	K-10UD00G20 	Mach Touchless Flushometer with TRIPOINT Technology Fixture-mount design 0.5 gallon (1.89 litre) flush flow rate Includes a lithium battery pack (two AA's) Intended for urinal installations with 3/4" (19 mm) top spud coupling connection	CP	666.25
	K-10UD00K20	Mach Touchless Flushometer with TRIPOINT Technology Fixture-mount design 1.0 gallon (3.79 litre) flush flow rate Includes a lithium battery pack (two AA's) Intended for urinal installations with 3/4" (19 mm) top spud coupling connection	CP	672.95



Touchless products comply with the actuation force limitations of the 2010 ADA Standards for Accessible Design, Section 309 Operable Parts, of the Act.

THE BOLD LOOK
OF **KOHLER**

TOUCHLESS ELECTRONIC FLUSHOMETERS











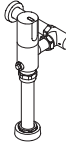

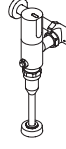
HYBRIDenergysystem

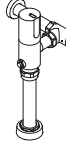
Featuring Mach® WAVE

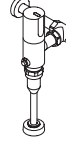
- User-controlled flush eliminates false actuations
- Features a new patented MACH piston that utilizes leading-edge materials to deliver unparalleled performance and accuracy
- Reliable, consistent performance in a range of commercial environments
- 24-hour sentinel flush keeps trapway fresh
- Humidity- and submersion-proof
- 3- to 5-year expected battery life based on 30,000 actuations per year

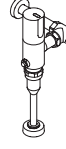

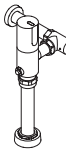
WAVE DC POWERED FLUSHOMETERS



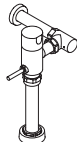
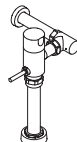

PRODUCT	MODEL NO.	DESCRIPTION	COLOR/FINISH	LIST PRICE	PRODUCT	MODEL NO.	DESCRIPTION	COLOR/FINISH	LIST PRICE
	K-40TD00K10 	Mach Touchless Flushometer with WAVE Technology Fixture-mount design 1.0 gallon (3.79 litre) flush flow rate Includes a lithium battery pack (two AA's) For use with toilet installations with 1-1/2" (38 mm) top spud coupling connection	CP	\$ 673.95		K-40UD00D20 	Mach Touchless Flushometer with WAVE Technology Fixture-mount design 0.125 gallon (0.47 litre) flush flow rate Includes a lithium battery pack (two AA's) Intended for urinal installations with 3/4" (19 mm) top spud coupling connection	CP	\$ 673.95
	K-40TD00N10 	Mach Touchless Flushometer with WAVE Technology Fixture-mount design 1.28 gallon (4.85 litre) flush flow rate Includes a lithium battery pack (two AA's) For use with toilet installations with 1-1/2" (38 mm) top spud coupling connection	CP	673.95		K-40UD00G20 	Mach Touchless Flushometer with WAVE Technology Fixture-mount design 0.5 gallon (1.89 litre) flush flow rate Includes a lithium battery pack (two AA's) Intended for urinal installations with 3/4" (19 mm) top spud coupling connection	CP	673.95
	K-40TD00N10-RF 	Retrofit design Does not include vacuum breaker and control stop	CP	575.00		K-40UD00K20 	Mach Touchless Flushometer with WAVE Technology Fixture-mount design 1.0 gallon (3.79 litre) flush flow rate Includes a lithium battery pack (two AA's) Intended for urinal installations with 3/4" (19 mm) top spud coupling connection	CP	673.95
	K-40TD00R10	Mach Touchless Flushometer with WAVE Technology Fixture-mount design 1.6 gallon (6.06 litre) flush flow rate Includes a lithium battery pack (two AA's) For use with toilet installations with 1-1/2" (38 mm) top spud coupling connection	CP	673.95					
	K-40TD00R10-RF	Retrofit design Does not include vacuum breaker and control stop	CP	575.00					

Mach® Manual Flushometers

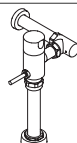
- Reliable piston technology delivers consistent performance and accurate discharge across a full range of incoming water pressures
- Features a new patented MACH piston that utilizes leading-edge materials to deliver unparalleled performance and accuracy
- Chloramine resistance on all rubber components exposed to waterway
- Locking stop cap and nonhold open design provides protection against vandalism

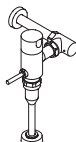
MACH FLUSHOMETERS

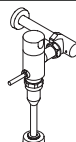
PRODUCT	MODEL NO.	DESCRIPTION	COLOR/FINISH	LIST PRICE
	K-80TM00K10	Mach Manual Flushometer Fixture-mount design 1.0 gallon (3.79 litre) flush flow rate For use with toilet installations with 1-1/2" (38 mm) top spud coupling connection	CP	\$ 233.95
	K-80TM00N10 	Mach Manual Flushometer Fixture-mount design 1.28 gallon (4.85 litre) flush flow rate For use with toilet installations with 1-1/2" (38 mm) top spud coupling connection	CP	233.95
	K-80TM00R10	Mach Manual Flushometer Fixture-mount design 1.6 gallon (6.06 litre) flush flow rate For use with toilet installations with 1-1/2" (38 mm) top spud coupling connection	CP	233.95

PRODUCT	MODEL NO.	DESCRIPTION	COLOR/FINISH	LIST PRICE
	K-80UM00D20 	Mach Manual Flushometer Fixture-mount design 0.125 gallon (0.47 litre) flush flow rate Intended for urinal installations with 3/4" (19 mm) top spud coupling connection	CP	\$ 233.95
	K-80UM00G20 	Mach Manual Flushometer Fixture-mount design 0.5 gallon (1.89 litre) flush flow rate Intended for urinal installations with 3/4" (19 mm) top spud coupling connection	CP	233.95

MANUAL FLUSHOMETER SERVICE KITS

MODEL NO.	DESCRIPTION	COLOR/FINISH	LIST PRICE
K-1388743	Manual Flushometer Service Kit (contains Piston, Piston Cover Assembly, 1287291** Handle Assembly) 1.0 gallon (3.79 litre) flush flow rate	CP	\$ 66.50
K-1388744	Manual Flushometer Service Kit (contains Piston, Piston Cover Assembly, 1287291** Handle Assembly) 1.28 gallon (4.85 litre) flush flow rate	CP	68.00
K-1388745	Manual Flushometer Service Kit (contains Piston, Piston Cover Assembly, 1287291** Handle Assembly) 1.6 gallon (6.06 litre) flush flow rate	CP	76.30

MODEL NO.	DESCRIPTION	COLOR/FINISH	LIST PRICE
K-1388740	Manual Flushometer Service Kit (contains Piston, Piston Cover Assembly, 1287291** Handle Assembly) 0.125 gallon (0.47 litre) flush flow rate	CP	\$ 68.70
K-1388741	Manual Flushometer Service Kit (contains Piston, Piston Cover Assembly, 1287291** Handle Assembly) 0.5 gallon (1.89 litre) flush flow rate	CP	68.70



Touchless products comply with the actuation force limitations of the 2010 ADA Standards for Accessible Design, Section 309 Operable Parts, of the Act.

THE BOLD LOOK
OF **KOHLER**

COORDINATED SOLUTIONS FOR TOILETS AND URINALS

Coordinated solutions pair KOHLER® fixtures with the Mach® flushometer platform for optimized performance and ease of specification. Mach flushometers feature an innovative patented piston design constructed with leading-edge material that prevents mineral buildup and allows for high-precision manufacturing, delivering exceptional performance and reliability. Select from a range of flush rates and power options that pair with toilets and urinals shown below.



Mach Tripoint®



Kingston™
Ultra



Highcliff™
Ultra



Wellcomme™
Ultra



Modflex®
Adjust-a-Bowl®



Bardon™



Dexter™



Tend™

WALL-MOUNT TOILETS

			MACH TRIPPOINT TOUCHLESS FLUSHOMETERS				
			DC-Powered			Hybrid-Powered	
Product Name	Fixture SKU	Variations	1.0 GPF (K-10TD00K10-CP)	1.28 GPF K-10TD00N10-CP	1.6 GPF K-10TD00R10-CP	1.0 GPF (K-10TH00K10-CP)	1.28 GPF K-10TH00N10-CP
Kingston Ultra	K-84325-0	Top Spud	PR84325-T3D-NA	PR84325-T4D-NA	PR84325-T5D-NA	PR84325-T3H-NA	PR84325-T4H-NA
	K-84325-SS-0	Top Spud Antimicrobial	PR84325-T3DS-NA	PR84325-T4DS-NA	PR84325-T5DS-NA	PR84325-T3HS-NA	PR84325-T4HS-NA

FLOOR-MOUNT TOILETS

			MACH TRIPPOINT TOUCHLESS FLUSHOMETERS				
			DC-Powered			Hybrid-Powered	
Product Name	Fixture SKU	Variations	1.0 GPF (K-10TD00K10-CP)	1.28 GPF K-10TD00N10-CP	1.6 GPF K-10TD00R10-CP	1.0 GPF (K-10TH00K10-CP)	1.28 GPF K-10TH00N10-CP
Highcliff Ultra	K-96057-0	Top Spud	PR96057-T3D-NA	PR96057-T4D-NA	PR96057-T5D-NA	PR96057-T3H-NA	PR96057-T4H-NA
	K-96057-SS-0	Top Spud Antimicrobial	PR96057-T3DS-NA	PR96057-T4DS-NA	PR96057-T5DS-NA	PR96057-T3HS-NA	PR96057-T4HS-NA
Wellcomme Ultra	K-96053-0	Top Spud	PR96053-T3D-NA	PR96053-T4D-NA	PR96053-T5D-NA	PR96053-T3H-NA	PR96053-T4H-NA
	K-96053-SS-0	Top Spud Antimicrobial	PR96053-T3DS-NA	PR96053-T4DS-NA	PR96053-T5DS-NA	PR96053-T3HS-NA	PR96053-T4HS-NA
Modflex Adjust-a-Bowl†	K-25042-SS-0	Top Spud Antimicrobial	N/A	PR25042-T4DS-NA	PR25042-T5DS-NA	N/A	PR25042-T4HS-NA
	K-25042-SSL-0	Top Spud Antimicrobial Bedpan Lugs	N/A	PR25042-T4DSL-NA	PR25042-T5DSL-NA	N/A	PR25042-T4HSL-NA

URINALS

			MACH TRIPPOINT TOUCHLESS FLUSHOMETERS			
			DC-Powered		Hybrid-Powered	
Product Name	Fixture SKU	Variations	0.125 GPF K-10UD00D20-CP	0.5 GPF K-10UD00G20-CP	0.125 GPF K-10UH00D20-CP	0.5 GPF K-10UH00G20-CP
Bardon	K-4991-ET-0	Top Spud	PR4991-T1D-NA	PR4991-T2D-NA	PR4991-T1H-NA	PR4991-T2H-NA
Dexter	K-5452-ET-0	Top Spud	PR5452-T1D-NA	PR5016-T2D-NA	PR5452-T1H-NA	PR5016-T2H-NA
	K-5452-ETSS-0	Top Spud Antimicrobial	PR5452-T1DS-NA	PR5016-T2DS-NA	PR5452-T1HS-NA	PR5016-T2HS-NA
Tend†	K-20713-ET-0	Top Spud	PR20713-T1D-NA	PR20713-T2D-NA	PR20713-T1H-NA	PR20713-T2H-NA

To place an order for the above combinations, please order fixture/flushometer SKUs separately.

* Ultra flush engine is designed to outperform competitors' bowls in cleanliness and plug resistance, engineered to flush effectively at low water pressure and flow, and has a flexible water-consumption rate.

† Innovative adjustable-height Modflex connector attaches to the existing wall carrier, requiring no construction behind the wall. Saves thousands of dollars in lost room revenue, material, and labor. Retrofit takes less than one hour compared to one to two days for a total renovation.

‡ Tend features a P-trap that can be removed and replaced if necessary, allowing you to reuse the vitreous china.

Items with the antimicrobial variation have an antimicrobial agent that is baked into the glaze and inhibits the growth of mold-, mildew-, stain-, and odor-causing bacteria on the fixture's surface. This product does not protect users against bacteria, viruses, or other disease organisms.

THE BOLD LOOK
OF KOHLER®



All fixtures and flushometers listed, with the exception of the 1.6 gpf options, are WaterSense® labeled.



All fixtures and flushometers listed, with the exception of Wellcomme, are compliant to ADA when installed to the specific requirements of this regulation.

FLUSHOMETER FINISH – Polished Chrome (CP)
FIXTURE COLOR – White (0)

MODEL NO.	DESCRIPTION	COLOR/ FINISH	LIST PRICE
K-23724	<p>Toilet Cleaner & Disinfectant</p> <p>Cleans, disinfects and deodorizes toilets and plastic toilet seats, including bidet toilet seats</p> <p>Premium formula penetrates soils, removing the toughest stains</p> <p>28 fl oz spray bottle</p> <p>Must be ordered in quantity of 10, 8-packs or 80 pieces; price each</p>	N/A	\$ 10.50
K-EC23724	<p>Comes with spray head detached and both the spray head and cleaner bottle in a poly bag</p> <p>Sold as individual units</p>	N/A	10.50
K-23734	<p>Toilet Bowl Cleaner & Disinfectant</p> <p>Cleans, disinfects and deodorizes toilet bowls and urinals</p> <p>Premium formula removes the toughest hard water films and rust stains</p> <p>Antibacterial, antimicrobial</p> <p>24 fl oz squeeze bottle</p> <p>Must be ordered in quantity of 12; price each</p>	N/A	11.50
K-EC23734	<p>Comes with squeeze head detached and both the squeeze head and cleaner bottle in a poly bag</p> <p>Sold as individual units</p>	N/A	11.50
K-23735	<p>Whirlpool Disinfectant</p> <p>Cleans and deodorizes whirlpools including hydrotherapy systems</p> <p>Premium formula eliminates and prevents bacteria, viruses and fungi</p> <p>28 fl oz pour bottle</p> <p>Sold as individual units</p>	N/A	14.50

NOTES

THE BOLD LOOK
OF **KOHLER**®