

TOTO®

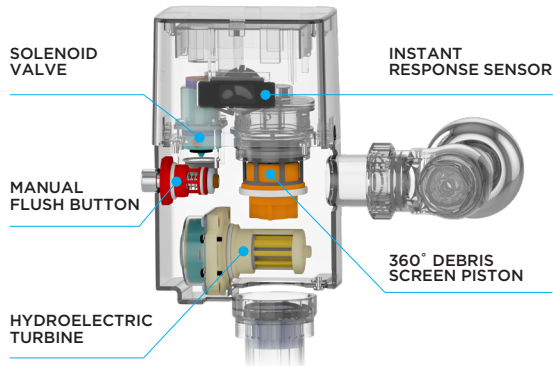

ECOPOWER® FLUSH VALVES

Hands-free ECOPOWER smart-sensor flush valves for toilet and urinal are energy-saving, durable, and provide maximum performance in even the most demanding, high-traffic public restrooms. This self-powered hydroelectric flush valve system generates its power during use; every time water turns the internal turbine.



- Self-powered hydroelectric flush valve system
- No minimum daily usage requirement (Except for 0.125 GPF Urinal flush valve)
- No external Power or routine battery changes
- Smart sensor with self-adjusting detection range
- Self-Cleaning piston valve with 360° filter screen
- Smart sensor with self-adjusting detection range
- 6-second detection time to prevent ghost flushing
- Protects trap seal with a maintenance flush if not used in a 24 hour period

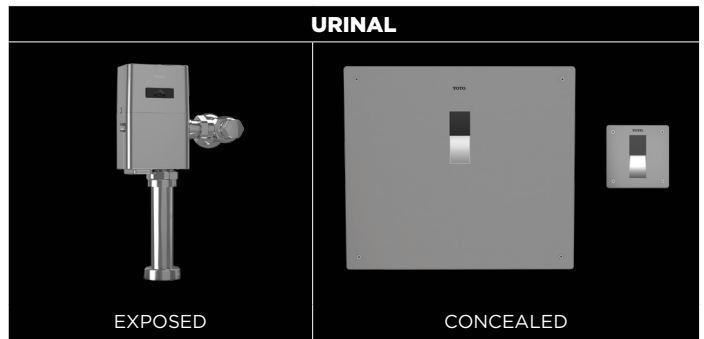
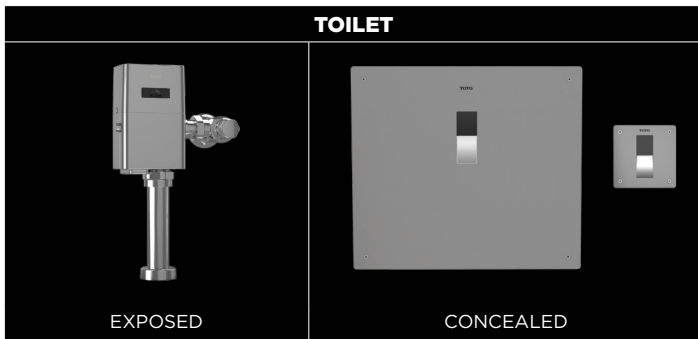













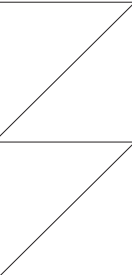









Toilet Flush Valve		Gallon Per Flush		
		1.0 GPF	1.28 GPF	1.6 GPF
Top Spud	Exposed	TET1UA32#CP	TET1LA32#CP	TET1GA32#CP
	Exposed (24" Vacuum Breaker Set)	TET6UA32#CP	TET6LA32#CP	TET6GA32#CP
	Exposed (Reclaimed Water)	TET1UAX32#CP	TET1LAX32#CP	
	Concealed	TET2UA32#SS	TET2LA32#SS	TET2GA32#SS
Back Spud	Concealed	TET3UA32#SS	TET3LA32#SS	TET3GA32#SS
		TET2UA31#SS	TET2LA31#SS	TET2GA31#SS
Back Spud	Concealed	TET3UA31#SS	TET3LA31#SS	TET3GA31#SS

Urinal Flush Valve		Gallon Per Flush		
		0.125 GPF	0.5 GPF	1.0 GPF
Top Spud	Exposed	TEU1UA12#CP	TEU1LA12#CP	TEU1GA12#CP
	Exposed (Reclaimed Water)	TEU1UAX12#CP	TEU1LAX12#CP	
	Concealed	TEU2UA12#SS	TEU2LA12#SS	
		TEU3UA12#SS	TEU3LA12#SS	
Back Spud	Concealed (3/4" Back Spud Inlet)	TEU2UA11#SS	TEU2LA11#SS	
		TEU3UA11#SS	TEU3LA11#SS	
	Concealed (1-1/4" Back Spud Inlet)		TEU2LA21#SS	
		TEU3LA21#SS		

TOTO®

GLOBAL AUTO FAUCETS













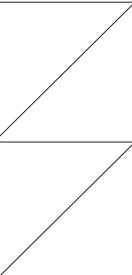









CROSS REFERENCE CHART

ECOPOWER / DC															
Sloan			Zurn			TOTO									
Series	Image	Sensor	Series	Image	Sensor	Series	GPM	Mode	KIT #	Cover Plate	Image	Sensor			
EAF-250		Body Sensor	Z6950		Tip Sensor	Standard R	1.0	On-Demand	T28S11E#CP						
							0.5	On-Demand	T28S51E#CP						
							0.5	Continuous	T28S53E#CP						
							0.35	On-Demand	T28S32E#CP						
						Standard S	1.0	On-Demand	T27S11E#CP						
							0.5	On-Demand	T27S51E#CP						
							0.5	Continuous	T27S53E#CP						
							0.35	On-Demand	T27S32E#CP						
SF-2150-4		Body Sensor	Z6950		Tip Sensor	Standard R with 4 Inch Plate	1.0	On-Demand	T28S11E#CP	THP3158#CP					
							0.5	On-Demand	T28S51E#CP						
							0.5	Continuous	T28S53E#CP						
							0.35	On-Demand	T28S32E#CP						
						Standard S with 4 Inch Plate	1.0	On-Demand	T27S11E#CP						
							0.5	On-Demand	T27S51E#CP						
			0.5	Continuous	T27S53E#CP										
			0.35	On-Demand	T27S32E#CP										
			Z6955		Tip Sensor				Standard R with 4 Inch Plate	1.0	On-Demand	T28S11E#CP	THP3158#CP		
										0.5	On-Demand	T28S51E#CP			
										0.5	Continuous	T28S53E#CP			
										0.35	On-Demand	T28S32E#CP			
Standard S with 4 Inch Plate	1.0	On-Demand							T27S11E#CP						
	0.5	On-Demand							T27S51E#CP						
	0.5	Continuous	T27S53E#CP												
	0.35	On-Demand	T27S32E#CP												
SF-2350		Body Sensor	Z6915		Body Sensor	Standard R with 4 Inch Plate	1.0	On-Demand	T28S11E#CP	THP3158#CP					
							0.5	On-Demand	T28S51E#CP						
							0.5	Continuous	T28S53E#CP						
							0.35	On-Demand	T28S32E#CP						
						Standard S with 4 Inch Plate	1.0	On-Demand	T27S11E#CP						
							0.5	On-Demand	T27S51E#CP						
							0.5	Continuous	T27S53E#CP						
							0.35	On-Demand	T27S32E#CP						
EBF-650		Body Sensor				Standard R with 4 Inch Plate	1.0	On-Demand	T28S11E#CP	THP3158#CP					
							0.5	On-Demand	T28S51E#CP						
							0.5	Continuous	T28S53E#CP						
							0.35	On-Demand	T28S32E#CP						
						Standard S with 4 Inch Plate	1.0	On-Demand	T27S11E#CP						
							0.5	On-Demand	T27S51E#CP						
0.5	Continuous	T27S53E#CP													
0.35	On-Demand	T27S32E#CP													
SF-2400-4		Body Sensor	ETF-880		Tip Sensor	Helix with 4 Inch Plate	0.5	On-Demand	T26S51E#CP	THP3158#CP					
							0.5	Continuous	T26S53E#CP						
							0.35	On-Demand	T26S32E#CP						























TOTO®



































GLOBAL AUTO FAUCETS

CROSS REFERENCE CHART

AC Powered															
Sloan			Zurn			TOTO									
Series	Image	Sensor	Series	Image	Sensor	Series	GPM	Mode	KIT #	Cover Plate	Image	Sensor			
EAF-250		Body Sensor	Z6950		Tip Sensor	Standard R	1.0	On-Demand	T28S11A#CP						
							0.5	On-Demand	T28S51A#CP						
							0.5	Continuous	T28S53A#CP						
							0.35	On-Demand	T28S32A#CP						
						Standard S	1.0	On-Demand	T27S11A#CP						
							0.5	On-Demand	T27S51A#CP						
							0.5	Continuous	T27S53A#CP						
							0.35	On-Demand	T27S32A#CP						
SF-2150-4		Body Sensor	Z6950		Tip Sensor	Standard R with 4 Inch Plate	1.0	On-Demand	T28S11A#CP	THP3158#CP					
							0.5	On-Demand	T28S51A#CP						
							0.5	Continuous	T28S53A#CP						
							0.35	On-Demand	T28S32A#CP						
						Standard S with 4 Inch Plate	1.0	On-Demand	T27S11A#CP						
							0.5	On-Demand	T27S51A#CP						
							0.5	Continuous	T27S53A#CP						
							0.35	On-Demand	T27S32A#CP						
			Z6955		Tip Sensor				Standard R with 4 Inch Plate	1.0	On-Demand	T28S11A#CP	THP3158#CP		
										0.5	On-Demand	T28S51A#CP			
										0.5	Continuous	T28S53A#CP			
										0.35	On-Demand	T28S32A#CP			
Standard S with 4 Inch Plate	1.0	On-Demand							T27S11A#CP						
	0.5	On-Demand							T27S51A#CP						
	0.5	Continuous							T27S53A#CP						
	0.35	On-Demand							T27S32A#CP						
SF-2350		Body Sensor	Z6915		Body Sensor	Standard R with 4 Inch Plate	1.0	On-Demand	T28S11A#CP	THP3158#CP					
							0.5	On-Demand	T28S51A#CP						
							0.5	Continuous	T28S53A#CP						
							0.35	On-Demand	T28S32A#CP						
						Standard S with 4 Inch Plate	1.0	On-Demand	T27S11A#CP						
							0.5	On-Demand	T27S51A#CP						
							0.5	Continuous	T27S53A#CP						
							0.35	On-Demand	T27S32A#CP						
EBF-650		Body Sensor				Standard R with 4 Inch Plate	1.0	On-Demand	T28S11A#CP	THP3158#CP					
							0.5	On-Demand	T28S51A#CP						
							0.5	Continuous	T28S53A#CP						
							0.35	On-Demand	T28S32A#CP						
						Standard S with 4 Inch Plate	1.0	On-Demand	T27S11A#CP						
							0.5	On-Demand	T27S51A#CP						
							0.5	Continuous	T27S53A#CP						
							0.35	On-Demand	T27S32A#CP						
SF-2400-4		Body Sensor	ETF-880		Tip Sensor	Helix with 4 Inch Plate	0.5	On-Demand	T26S51A#CP	THP3158#CP					
							0.5	Continuous	T26S53A#CP						
							0.35	On-Demand	T26S32A#CP						

GLOBAL AUTO FAUCETS

		ECOPOWER						AC POWER					
FAUCET		Kit Number (Spout & Controller)				Spout	Controller	Kit Number (Spout & Controller)				Spout	Controller
		Item #	GPC	GPM	Mode			Item #	GPC	GPM	Mode		
Standard R		T28S32E#CP	0.12	0.35	On-Demand	TLE28001U2#CP	TLE03501U2	T28S32A#CP	0.12	0.35	On-Demand	TLE28001U2#CP	TLE01501U
		T28S51E#CP	0.08	0.5	On-Demand	TLE28002U1#CP	TLE03502U1	T28S51A#CP	0.08	0.5	On-Demand	TLE28002U1#CP	TLE01502U
		T28S53E#CP	0.17	0.5	Continuous	TLE28002U3#CP	TLE03502U3	T28S53A#CP	0.17	0.5	Continuous	TLE28002U3#CP	
		T28S11E#CP	0.18	1.0	On-Demand	TLE28003U1#CP	TLE03503U1	T28S11A#CP	0.18	1.0	On-Demand	TLE28003U1#CP	TLE01503U
Standard S		T27S32E#CP	0.12	0.35	On-Demand	TLE27002U2#CP	TLE03501U2	T27S32A#CP	0.12	0.35	On-Demand	TLE27002U2#CP	TLE01501U
		T27S51E#CP	0.08	0.5	On-Demand	TLE27002U1#CP	TLE03502U1	T27S51A#CP	0.08	0.5	On-Demand	TLE27002U1#CP	TLE01502U
		T27S53E#CP	0.17	0.5	Continuous	TLE27002U3#CP	TLE03502U3	T27S53A#CP	0.17	0.5	Continuous	TLE27002U3#CP	
		T27S11E#CP	0.18	1.0	On-Demand	TLE27003U1#CP	TLE03503U1	T27S11A#CP	0.18	1.0	On-Demand	TLE27003U1#CP	TLE01503U
GE		T20S32E#CP	0.12	0.35	On-Demand	TLE20001U2#CP	TLE03501U2	T20S32A#CP	0.12	0.35	On-Demand	TLE20001U2#CP	TLE01501U
		T20S51E#CP	0.08	0.5	On-Demand	TLE20006U1#CP	TLE03502U1	T20S51A#CP	0.08	0.5	On-Demand	TLE20006U1#CP	TLE01502U
		T20S53E#CP	0.17	0.5	Continuous	TLE20006U3#CP	TLE03502U3	T20S53A#CP	0.17	0.5	Continuous	TLE20006U3#CP	
GC		T21S32E#CP	0.12	0.35	On-Demand	TLE21001U2#CP	TLE03501U2	T21S32A#CP	0.12	0.35	On-Demand	TLE21001U2#CP	TLE01501U
		T21S51E#CP	0.08	0.5	On-Demand	TLE21006U1#CP	TLE03502U1	T21S51A#CP	0.08	0.5	On-Demand	TLE21006U1#CP	TLE01502U
		T21S53E#CP	0.17	0.5	Continuous	TLE21006U3#CP	TLE03502U3	T21S53A#CP	0.17	0.5	Continuous	TLE21006U3#CP	
GM		T22S32E#CP	0.12	0.35	On-Demand	TLE22001U2#CP	TLE03501U2	T22S32A#CP	0.12	0.35	On-Demand	TLE22001U2#CP	TLE01501U
		T22S51E#CP	0.08	0.5	On-Demand	TLE22006U1#CP	TLE03502U1	T22S51A#CP	0.08	0.5	On-Demand	TLE22006U1#CP	TLE01502U
		T22S53E#CP	0.17	0.5	Continuous	TLE22006U3#CP	TLE03502U3	T22S53A#CP	0.17	0.5	Continuous	TLE22006U3#CP	
AXIOM STANDARD		T25S32E#CP	0.12	0.35	On-Demand	TLE25001U2#CP	TLE03501U2	T25S32A#CP	0.12	0.35	On-Demand	TLE25001U2#CP	TLE01501U
		T25S51E#CP	0.08	0.5	On-Demand	TLE25006U1#CP	TLE03502U1	T25S51A#CP	0.08	0.5	On-Demand	TLE25006U1#CP	TLE01502U
		T25S53E#CP	0.17	0.5	Continuous	TLE25006U3#CP	TLE03502U3	T25S53A#CP	0.17	0.5	Continuous	TLE25006U3#CP	
AXIOM VESSEL		T25T32E#CP	0.12	0.35	On-Demand	TLE25003U2#CP	TLE03501U2	T25T32A#CP	0.12	0.35	On-Demand	TLE25003U2#CP	TLE01501U
		T25T51E#CP	0.08	0.5	On-Demand	TLE25008U1#CP	TLE03502U1	T25T51A#CP	0.08	0.5	On-Demand	TLE25008U1#CP	TLE01502U
		T25T53E#CP	0.17	0.5	Continuous	TLE25008U3#CP	TLE03502U3	T25T53A#CP	0.17	0.5	Continuous	TLE25008U3#CP	
AXIOM WALL-MOUNT		T25L32E#CP	0.12	0.35	On-Demand	TLE25005U2#CP	TLE03501U2	T25L32A#CP	0.12	0.35	On-Demand	TLE25005U2#CP	TLE01501U
		T25L51E#CP	0.08	0.5	On-Demand	TLE25010U1#CP	TLE03502U1	T25L51A#CP	0.08	0.5	On-Demand	TLE25010U1#CP	TLE01502U
		T25L53E#CP	0.17	0.5	Continuous	TLE25010U3#CP	TLE03502U3	T25L53A#CP	0.17	0.5	Continuous	TLE25010U3#CP	
GOOSENECK STANDARD		T24S32E#CP	0.12	0.35	On-Demand	TLE24001U2#CP	TLE03501U2	T24S32A#CP	0.12	0.35	On-Demand	TLE24001U2#CP	TLE01501U
		T24S51E#CP	0.08	0.5	On-Demand	TLE24006U1#CP	TLE03502U1	T24S51A#CP	0.08	0.5	On-Demand	TLE24006U1#CP	TLE01502U
		T24S53E#CP	0.17	0.5	Continuous	TLE24006U3#CP	TLE03502U3	T24S53A#CP	0.17	0.5	Continuous	TLE24006U3#CP	
GOOSENECK VESSEL		T24T32E#CP	0.12	0.35	On-Demand	TLE24003U2#CP	TLE03501U2	T24T32A#CP	0.12	0.35	On-Demand	TLE24003U2#CP	TLE01501U
		T24T51E#CP	0.08	0.5	On-Demand	TLE24008U1#CP	TLE03502U1	T24T51A#CP	0.08	0.5	On-Demand	TLE24008U1#CP	TLE01502U
		T24T53E#CP	0.17	0.5	Continuous	TLE24008U3#CP	TLE03502U3	T24T53A#CP	0.17	0.5	Continuous	TLE24008U3#CP	
HELIX STANDARD		T26S32E#CP	0.12	0.35	On-Demand	TLE26001U2#CP	TLE03501U2	T26S32A#CP	0.12	0.35	On-Demand	TLE26001U2#CP	TLE01501U
		T26S51E#CP	0.08	0.5	On-Demand	TLE26006U1#CP	TLE03502U1	T26S51A#CP	0.08	0.5	On-Demand	TLE26006U1#CP	TLE01502U
		T26S53E#CP	0.17	0.5	Continuous	TLE26006U3#CP	TLE03502U3	T26S53A#CP	0.17	0.5	Continuous	TLE26006U3#CP	
HELIX VESSEL		T26T32E#CP	0.12	0.35	On-Demand	TLE26003U2#CP	TLE03501U2	T26T32A#CP	0.12	0.35	On-Demand	TLE26003U2#CP	TLE01501U
		T26T51E#CP	0.08	0.5	On-Demand	TLE26008U1#CP	TLE03502U1	T26T51A#CP	0.08	0.5	On-Demand	TLE26008U1#CP	TLE01502U
		T26T53E#CP	0.17	0.5	Continuous	TLE26008U3#CP	TLE03502U3	T26T53A#CP	0.17	0.5	Continuous	TLE26008U3#CP	
HELIX WALL-MOUNT		T26L32E#CP	0.12	0.35	On-Demand	TLE26005U2#CP	TLE03501U2	T26L32A#CP	0.12	0.35	On-Demand	TLE26005U2#CP	TLE01501U
		T26L51E#CP	0.08	0.5	On-Demand	TLE26010U1#CP	TLE03502U1	T26L51A#CP	0.08	0.5	On-Demand	TLE26010U1#CP	TLE01502U
		T26L53E#CP	0.17	0.5	Continuous	TLE26010U3#CP	TLE03502U3	T26L53A#CP	0.17	0.5	Continuous	TLE26010U3#CP	
LIBELLA SEMI-VESSEL		T23M32E#CP	0.12	0.35	On-Demand	TLE23002U2	TLE03501U2	T23M32A#CP	0.12	0.35	On-Demand	TLE23002U2	TLE01501U
		T23M51E#CP	0.08	0.5	On-Demand	TLE23007U1	TLE03502U1	T23M51A#CP	0.08	0.5	On-Demand	TLE23007U1	TLE01502U
		T23M53E#CP	0.17	0.5	Continuous	TLE23007U3	TLE03502U3	T23M53A#CP	0.17	0.5	Continuous	TLE23007U3	
LIBELLA WALL-MOUNT		T23L32E#CP	0.12	0.35	On-Demand	TLE23005U2	TLE03501U2	T23L32A#CP	0.12	0.35	On-Demand	TLE23005U2	TLE01501U
		T23L51E#CP	0.08	0.5	On-Demand	TLE23010U1	TLE03502U1	T23L51A#CP	0.08	0.5	On-Demand	TLE23010U1	TLE01502U
		T23L53E#CP	0.17	0.5	Continuous	TLE23010U3	TLE03502U3	T23L53A#CP	0.17	0.5	Continuous	TLE23010U3	
STANDARD R		—						T28S51A#CP	0.08	0.5	On-Demand	TLE31002U1	TLE02502U
Optional Items	Mixing Valve	Thermo Valve	Mounting Bracket			Swivel Coupling	Grid Drain	4" Cover Plate		8" Cover Plate			
SKU	TLM10	TLE05701U	THP5084			THP3237	THP5067#CP	THP3158#CP		THP3159#CP			
IMAGE													

SERIES	ECOPOWER		AC POWER	
	Spout Body	Controller Box	Spout Body	Controller Box
STANDARD R	—	—		
Standard R		 		
Standard S				
GE				
GC				
GM				
AXIOM STANDARD				
AXIOM VESSEL				
AXIOM WALL-MOUNT				
GOOSENECK STANDARD				
GOOSENECK VESSEL				
HELIX STANDARD				
HELIX VESSEL				
HELIX WALL-MOUNT				
LIBELLA SEMI-VESSEL				
LIBELLA WALL-MOUNT				

KIT NUMBER *Kit includes spout body, controller box, and mounting hardware (supply lines not included)	T Fitting 2 Spout body: 20: GE 21: GC 22: GM 23: Libella 24: Gooseneck 25: Axiom 26: Helix 27: Standard S 28: Standard R 3 Spout size: S: Short M: Semi-Vessel T: Vessel L: Wall-mount M Mode: 1: D10 2: D20 3: C20 3 Flow rate: 3: 0.35 GPM 5: 0.5 GPM 1: 1.0 GPM 2 Controller: A: AC D: DC E: ECOPOWER S: EWATER+ Single E Option: Blank: none T: w/ Thermo M: Mixing T Finish: CP: Chrome Plated BN: Brushed Nickel PN: Polished Nickel # C P																												
	T Fitting L Electronic E Spout body: 20: GE 21: GC 22: GM 23: Libella 24: Gooseneck 25: Axiom 26: Helix 27: Standard S 28: Standard R 2 Valve: 0: W/O valve 5: W/ valve (single) 7: W/ valve (thermo) 3 Company: U: USA 0 Mode: 1: D10 2: D20 3: C20 0 2 U Finish: CP: Chrome Plated BN: Brushed Nickel PN: Polished Nickel 1 # C P	<table border="1"> <thead> <tr> <th>Flow Volume</th> <th>Spout</th> <th>GE/GC/GM Libella/Gooseneck Axiom/Helix</th> <th>Standard S Standard R</th> </tr> </thead> <tbody> <tr> <td rowspan="4">0.35 GPM</td> <td>S</td> <td>01</td> <td rowspan="4">01</td> </tr> <tr> <td>M</td> <td>02</td> </tr> <tr> <td>T</td> <td>03</td> </tr> <tr> <td>L</td> <td>05</td> </tr> <tr> <td rowspan="4">0.5 GPM</td> <td>S</td> <td>06</td> <td rowspan="4">02</td> </tr> <tr> <td>M</td> <td>07</td> </tr> <tr> <td>T</td> <td>08</td> </tr> <tr> <td>L</td> <td>10</td> </tr> <tr> <td>1.0 GPM</td> <td>S</td> <td></td> <td>03</td> </tr> </tbody> </table>	Flow Volume	Spout	GE/GC/GM Libella/Gooseneck Axiom/Helix	Standard S Standard R	0.35 GPM	S	01	01	M	02	T	03	L	05	0.5 GPM	S	06	02	M	07	T	08	L	10	1.0 GPM	S	
Flow Volume	Spout	GE/GC/GM Libella/Gooseneck Axiom/Helix	Standard S Standard R																										
0.35 GPM	S	01	01																										
	M	02																											
	T	03																											
	L	05																											
0.5 GPM	S	06	02																										
	M	07																											
	T	08																											
	L	10																											
1.0 GPM	S		03																										
T Fitting L Electronic E Power Type: 01: AC 02: AC EWATER+ 03: ECOPOWER 0 Flow rate: 3: 0.35 GPM 5: 0.5 GPM 1: 1.0 GPM 3 Type: S: Single 5 Company: U: USA 0 1 U Mode: 1: D10 2: D20 3: C20 2																													



TOTO®

TOUCHLESS FAUCET CONTROLLER WITH HEATER

EASY INSTALL. ECOLOGICAL. NEW TECHNOLOGY.



SKU: REAH03B1U

SPECS

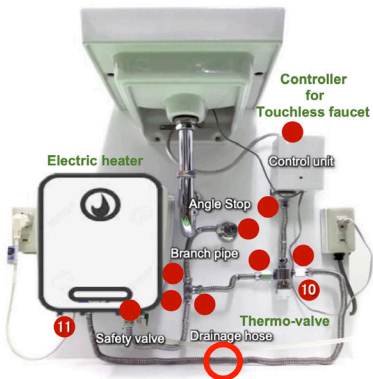
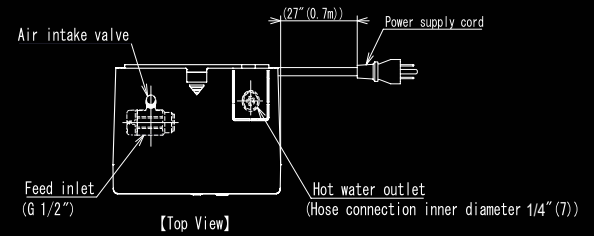
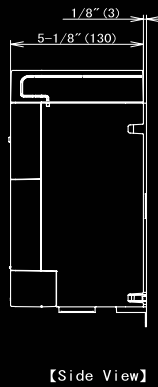
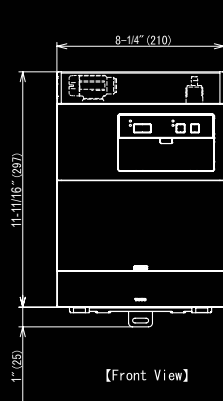

FEATURES INCLUDE:

ECOLOGICAL WITH POWER SAVINGS

- Find a time when hot water usage is low and save energy

EASY TO INSTALL

- Hot water piping system, T&P relief valve and expansion tank are NOT required

EASY TO MAINTAIN







- No periodical replacement parts

SAFETY DESIGN

- Tank and Heating element are made of high corrosion-resistance stainless steel
- EQUIPPED with burnout prevention control of heater elements
- Integrated thermostatic mixing valve is ASSE 1070 compliant

COMPACT DESIGN

- Allows for ADA compliance

Water Heater Controller		Series	KIT #	Image	GPM/GPC	Mode
	+	Standard R	TLE28002U1#CP		0.5 GPM / 0.08 GPC	On-demand
		Standard S	TLE27002U1#CP			
		Helix	TLE26006U1#CP			
		Axiom	TLE25006U1#CP			
		Gooseneck	TLE24006U1#CP			
		Libella	TLE23007U1#CP			

*More spout design options available.