

HR HARDWARE RENAISSANCE

LIKE NO OTHER™



Hand Forged Iron Hardware Price List

June 1, 2022

T 505.983.2644

sales@hardwarerenaisance.com

www.hardwarerenaisance.com

June 1, 2022 HAND FORGED IRON PRICE LIST

TABLE OF CONTENTS

M
O
D
E
R
N

E
U
R
O
↓

	PAGES
ORDERING INFORMATION	4
Door Handing, Mortise lock options	5
Upcharges (thick door, extended strikes, etc.)	6
Multipoint Hardware spec sheets & order form	7
IRON PATINA OPTIONS	11
LEVER & KNOBS OPTIONS	12
 DOOR HARDWARE COLLECTIONS	
Cody	14
El Secreto	17
Milan (Straight Edge Escutcheons)	20
Monte Vista	23
Sierra	26
Step	29
Avila	32
Art Nouveau	35
Beveled (Verona, Manhattan)	38
Chateau	41
Fleur de Lis	44
Notched Corner	47
STRIKE-BAR LATCHES: Exterior & Interior	53
 SLIDING DOOR HARDWARE	65
POCKET DOOR HARDWARE	68
DOOR & APPLIANCE PULLS	70
PUSH PLATES	78
 ACCESSORIES	
Dummy Straps & Braces	79
Strap Hinges	81
Heavy Duty Pintle (Gravity) Hinges	82
Door Knockers	83
Surface & Cane Bolts	84
Clavos	88
Door Stops	89
Hook & Eye	89
Window Hardware	90
Switch Plate Covers	91
Door Bell Buttons	93
Speakeasy Grilles & Latches	94
 KITCHEN & BATH	
Cabinet Knobs & Pulls	95
Bath Hardware	104

ORDERING INFORMATION

NOTE :

- 1) **ALL PRICES LIST**
- 2) **ALL PRICES INCLUDE ALL NECESSARY LOCKS AND COMPONENTS**
- 3) **COLLECTIONS ARE SHOWN FOR EASE OF ORDERING. LEVERS & KNOBS CAN BE INTERCHANGED WITHOUT UPCHARGE**
- 4) **CONTACT US FOR OTHER PAIRING OPTIONS AND CUSTOM WORK QUOTES**
- 5) **ALL PATINAS (FINISHES) ARE PRICED THE SAME**
- 6) UPCHARGES FOR DOORS THICKER THAN 1.75": SEE UPCHARGES ON PAGE 6
- 7) **DOORS LESS THAN 1.75" THICK? ASK ABOUT UPCHARGES TO MODIFY ESCUTCHEONS**
- 8) **WE DO NOT KEY ALIKE BY DEFAULT. SEE UPCHARGES ON PAGE 6 FOR KEYED ALIKE**
- 9) SEE GLOSSARY ON THIS PAGE FOR CODES
- 10) PRICES ARE SUBJECT TO CHANGE AT ANY TIME
- 11) HR IS NOT RESPONSIBLE FOR TYPOGRAPHICAL ERRORS
- 12) **SEND ALL ORDERS TO SALES@HARDWARERENAISSANCE.COM**
- 13) FORMAT FOR ORDERING: Backplate-Lever-Function-Lock type-Patina-Door thickness-Backset.
Eg: HE621-HL109-EN-ML-HW-1.75-2.5

SUMMARY TERMS OF SALE:

- 1) There is no minimum order. Hardware Renaissance reserves the right to refuse any order in whole or part.
- 2) Orders once placed and confirmed by Hardware Renaissance may not be changed or cancelled without the approval of Hardware Renaissance. Approved cancellations are subject to a 40% restocking fee.
- 3) LEAD TIMES are 6-8 weeks for standard products, and up to 12 weeks for custom.
RUSH OPTION: Certain products can be delivered in 4-6 weeks for a 15% Rush Fee. Contact us for details.
- 4) All sales are FOB Santa Fe NM USA. All orders will be shipped prepaid and added to the invoice.
- 5) Drop-shipment requests are subject to Hardware Renaissance's DROP SHIPMENT POLICY.
- 6) RETURNS ARE ACCEPTABLE ONLY FOR ERRORS & DEFECTS for which Hardware Renaissance is responsible, and must be accompanied by an RGA requested in advance. All RGA's expire 60 days after issuance.
- 7) Returns of standard hardware, requested within 30 days of invoice date, are at the discretion of Hardware Renaissance and subject to a 40% restocking fee.
- 8) There are NO RETURNS on Multipoint & Sliding Door Hardware.
- 9) There are NO RETURNS on custom products.
- 10) OUR IRON HARDWARE IS THE GENUINE ARTICLE MADE BY MASTER BLACKSMITHS. **IT IS NOT RUST PROOF!** Every order requires a signed RUST WAIVER.

GLOSSARY OF FUNCTIONS & LOCK TYPES:

FUNCTIONS:

EN	Entry (Keyed)
PT	Patio
FD	Full Dummy
SD	Single Dummy
AD	Active Dummy
PP	Passage
PR	Privacy

LOCK TYPES:

ML	Mortise Lock
MD	Mortise Deadbolt
DB	Tubular Deadbolt
SC	Single Cylinder
DC	Double Cylinder
TL	Tubular Latch
PMB	Privacy Bolt

HANDING OF DOOR

Door Handing is determined by standing at the outside of the door while facing the door. The side of the hinges determines door handing.

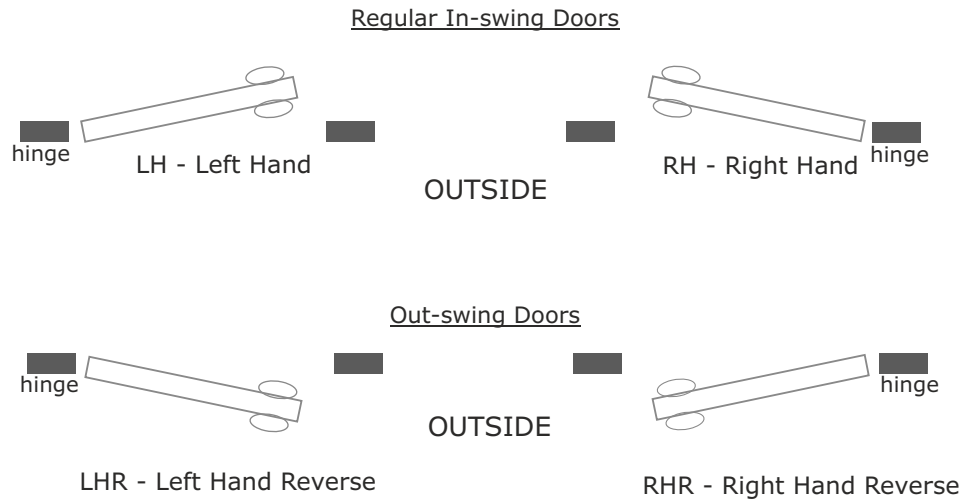

9100 Mortise Lock: Choice of ENTRY Functions. SPECIFY ON ORDER!

9148

Entrance or Apartment Lock

Latch bolt by key outside and lever either side unless outside lever is locked by toggle action stop.

Deadbolt by key outside and turn piece inside.

Turning inside lever retracts latch and deadbolt simultaneously.

Outside lever remains locked until manually unlocked by toggle.

9149

Entrance or Apartment Lock.

Latch bolt by key outside and lever either side unless outside lever is locked by toggle action stop.

Deadbolt by key outside and turn piece inside.

Turning inside lever retracts latch and deadbolt simultaneously.

Outside lever remains unlocked until manually locked by toggle or projection of deadbolt.

** Function not offered on thumb grip x thumb grip applications.*

9124 (No Toggle)

Dormitory, Entrance or Storeroom Lock.

Latch bolt by lever either side.

Deadbolt by key outside and turn piece inside.

Turn of inside lever retracts latch and deadbolt simultaneously, automatically unlocking outside lever.

UPCHARGES (ALL UPCHARGES ARE NET)

THICK DOOR UPCHARGES:

(If your door is in between, choose the next higher door thickness)

Door Thickness	Mortise Lock Sets	Mortise Deadbolt Sets (Strike-bar latch)	Tubular Deadbolt Sets
1.75"	NONE	NONE	NONE
2"	\$ 23.00	NONE	NONE
2.25"	\$ 29.00	\$ 13.00	\$ 8.00
2.5"	\$ 50.00	\$ 36.00	\$ 8.00
2.75"	\$ 55.00	\$ 36.00	\$ 8.00
3"	\$ 61.00	\$ 42.00	\$ 8.00
3.25"	\$ 61.00	\$ 42.00	\$ 8.00
3.5"	\$ 65.00	\$ 46.00	\$ 8.00
3.75"	\$ 65.00	\$ 46.00	\$ 11.00
4"	\$ 69.00	\$ 50.00	\$ 11.00
4.25"	\$ 69.00	\$ 50.00	\$ 11.00

UPCHARGES FOR EXTENDED T-STRIKES AND FOR FULL LIP STRIKES

(NOTE: WE SUPPLY T-STRIKES STANDARD)

UPCHARGES FOR EXTENDED T-STRIKES

(If your door is in between, choose the next higher thickness)

Door Thickness	T-Strike Size	NET per set
1.75"	1 1/4"	NONE
2"	1 1/4"	NONE
2.25"	1 1/2"	\$ 11.00
2.5"	1 1/2"	\$ 11.00
2.75"	1 3/4"	\$ 12.00
3"	1 3/4"	\$ 12.00
3.25"	2"	\$ 12.00
3.5"	2"	\$ 12.00
3.75"	2.5"	\$ 13.00
4"	2.5"	\$ 13.00

UPCHARGES FOR FULL LIP STRIKES

Door Thickness	FLS Size	NET per set
1.75"	1 3/16"	\$ 5.00
2"	1 3/16"	\$ 5.00
2.25"	1 1/2"	\$ 10.00
2.5"	1 1/2"	\$ 10.00
2.75"	1 3/4"	\$ 12.00
3"	1 3/4"	\$ 12.00
3.25"	2"	\$ 13.00
3.5"	2"	\$ 13.00

(Not available for doors over 3.5" thick)

UPCHARGES FOR KEYED ALIKE

(NOTE: WE DO NOT KEY ALIKE UNLESS SPECIFIED)

No. of Cylinders	Key Alike charge TOTAL NET	No. of Keys provided	Extra keys NET per key
2	\$ 9.00	4	\$ 5.00
3	\$ 14.00	4	
4	\$ 17.00	4	
5	\$ 19.00	4	
6	\$ 23.00	4	
7	\$ 27.00	4	
8	\$ 32.00	4	
9	\$ 37.00	4	
10	\$ 42.00	4	
11	\$ 46.00	4	

MULTIPOINT HARDWARE ORDERING INFORMATION

Multipoint hardware is available for most doors (except Andersen).

See specification pages for configurations and functions, and send the Multipoint Hardware Order Form with your order.



MULTIPOINT RETROFIT HARDWARE SPECIFICATION SHEET - PG.1 LEVER HIGH, AMERICAN CYLINDER SETS

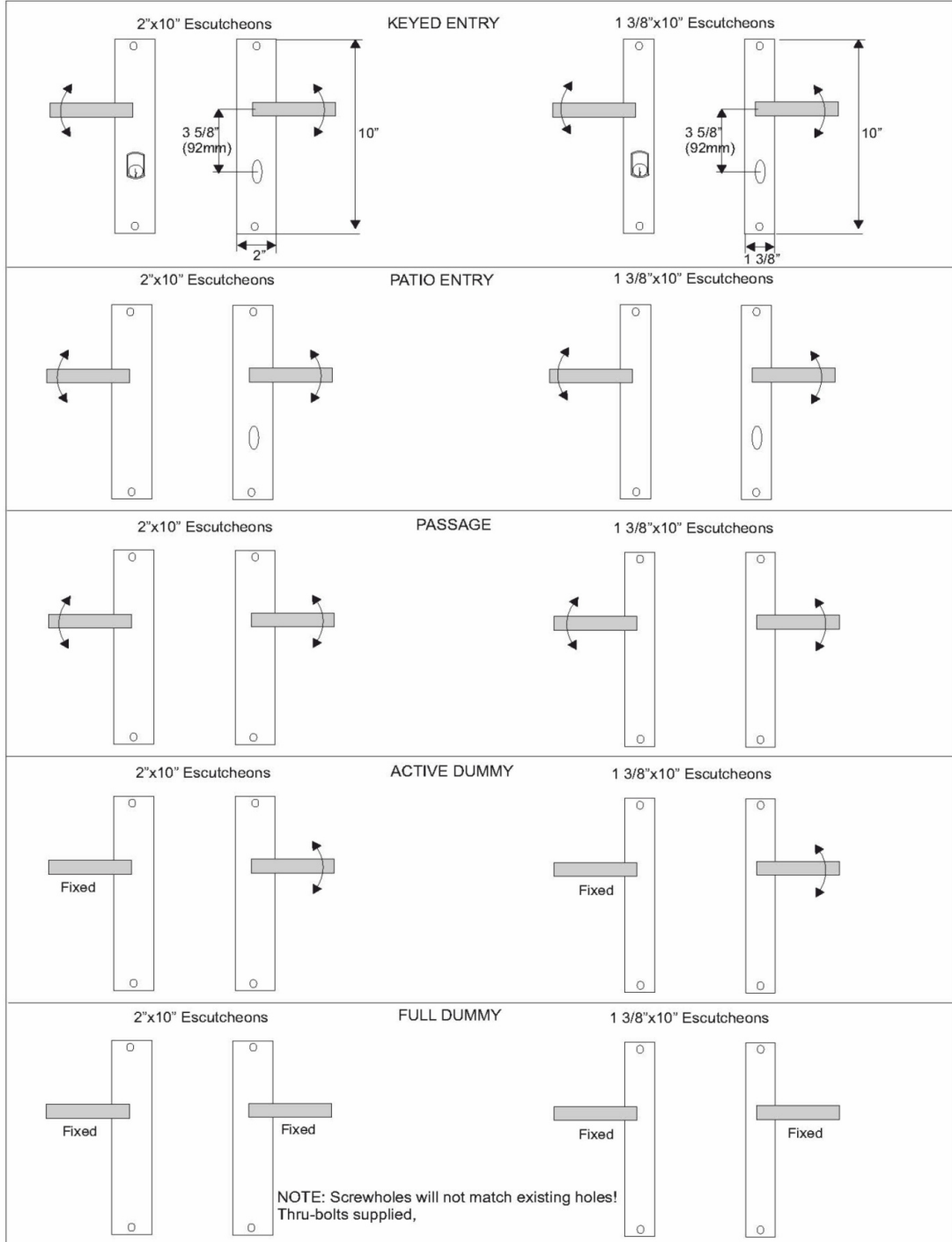



MULTIPOINT RETROFIT HARDWARE SPECIFICATION SHEET - PG.2
LEVER LOW, AMERICAN CYLINDER SETS

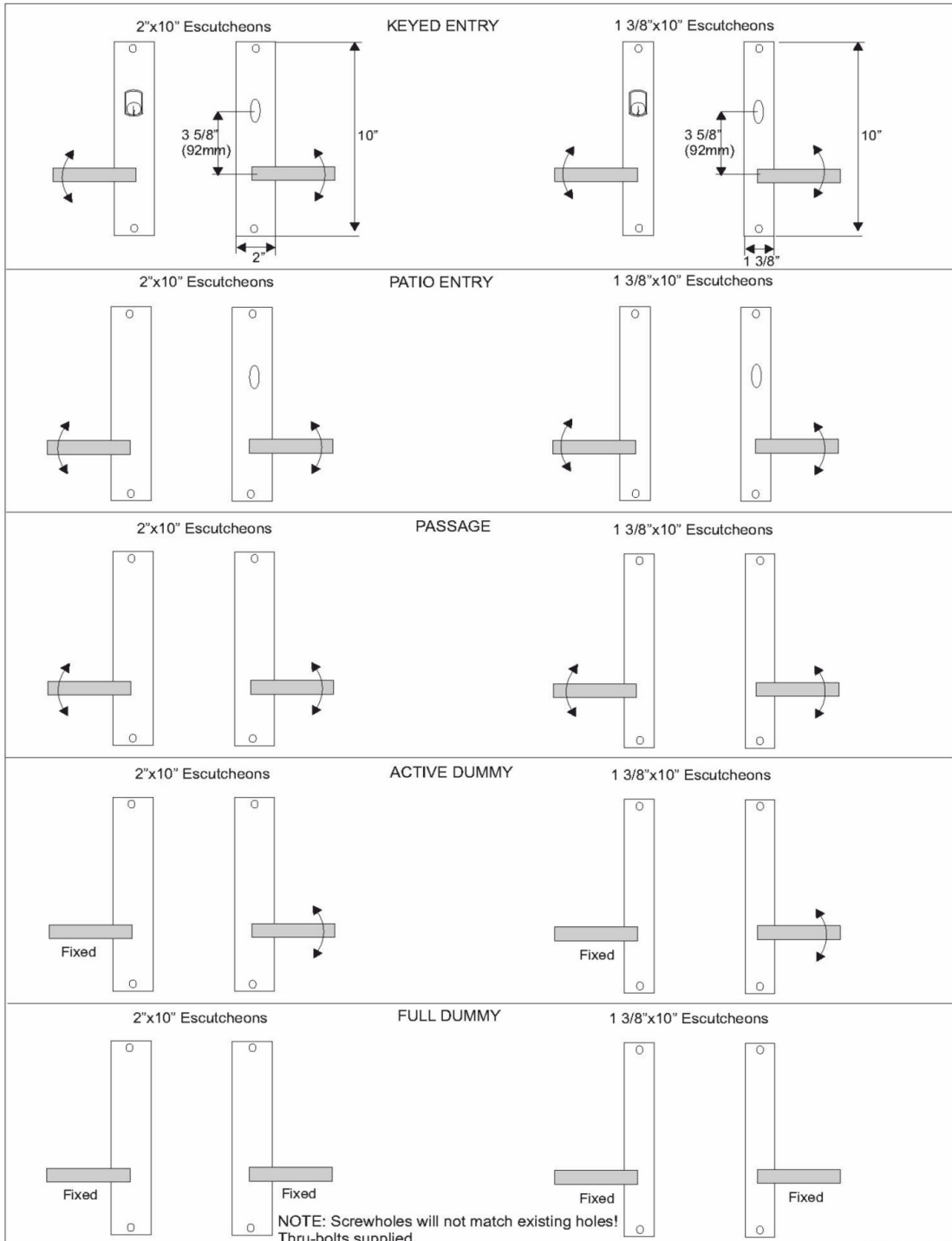



MULTIPOINT RETROFIT HARDWARE SPECIFICATION SHEET - PG.3
LEVER HIGH, EUROPEAN PROFILE CYLINDER SETS

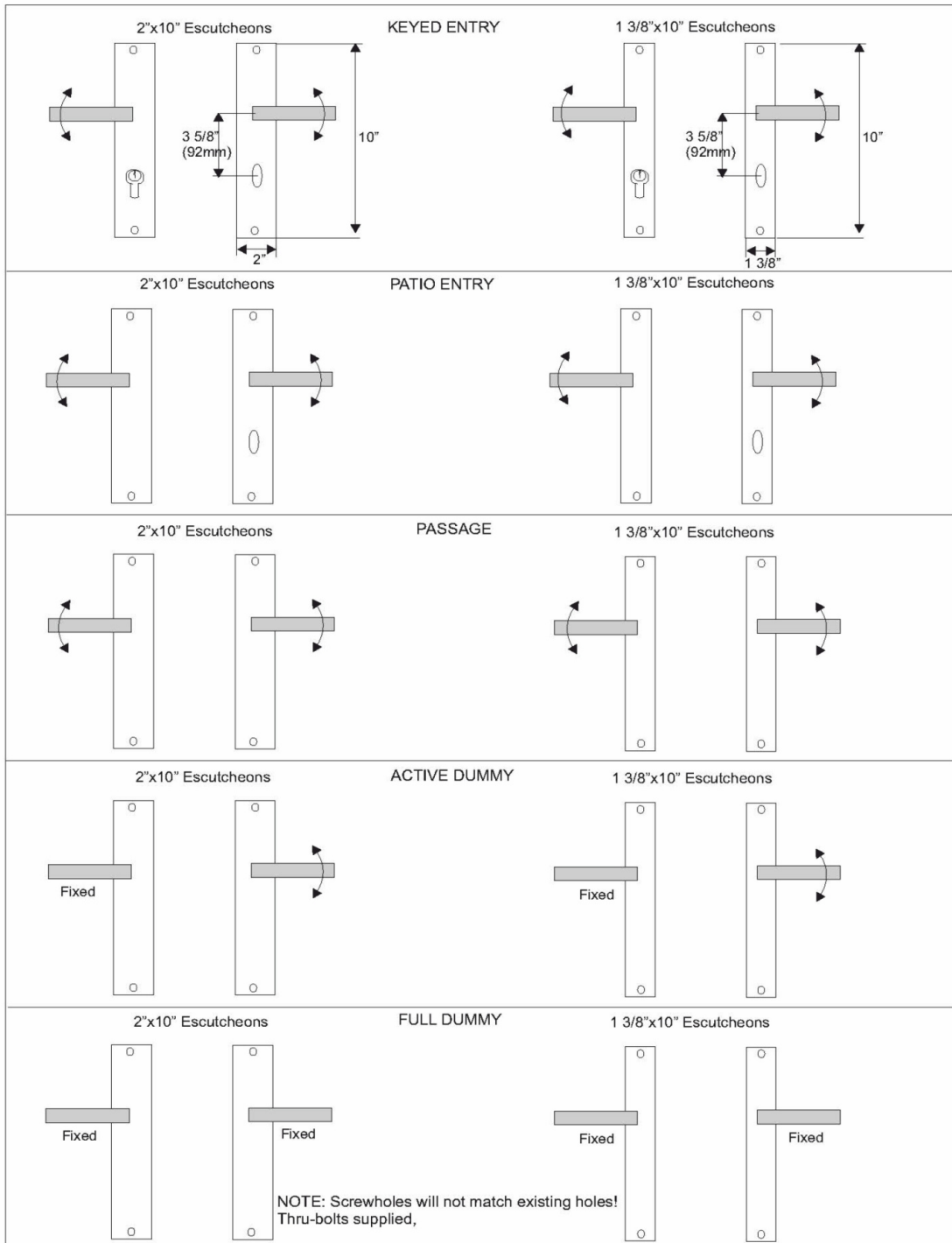



**HARDWARE RENAISSANCE
MULTIPOINT RETROFIT HARDWARE FORM**
Please provide this with your Multipoint Retrofit order
(REFER TO MULTIPOINT SPEC SHEETS)

DATE _____

DEALER _____

PO# _____

* LOCK MAKE: _____

* DOOR THICKNESS (1.75" std.) _____

* CYLINDER:
EURO PROFILE

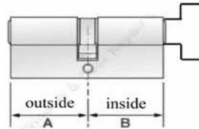

Centered in door (std.)
Offset A:
B:

AMERICAN



Tailpiece horizontal (std.)
Tailpiece vertical

* LEVER LOCATION: High
Low

* CENTER TO CENTER (std. 92mm or 3 5/8"):
92mm
Other (specify)

* PASSIVE (NON-LOCKING) DOOR SETS:
FULL DUMMY (both levers fixed)
ACTIVE DUMMY (outside lever fixed, inside lever working)
PASSAGE (both levers working)

* SPINDLE (HUB) SIZE:
8mm square (std.)
Other (specify)

THUMBURNS: Contemporary styles with cuboid thumbturns. Classic styles with oval thumbturns.

HANDING guide:

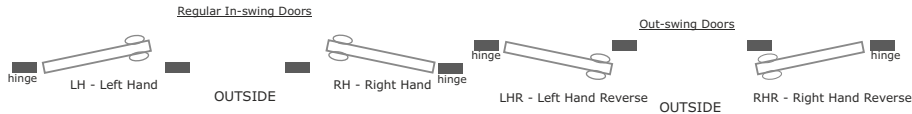

NOTE ABOUT OUR SCREW HOLE LOCATIONS: We do NOT match existing screw hole locations.

Our screw holes are made to miss existing holes. We provide thru-bolts for install.

NOTE FOR IRON MULTIPOINTS: HOLES WILL ALSO NEED TO BE MADE TO ACCOMODATE LEVER SPRING ASSIST.

3205 A Mercantile Court, Santa Fe NM 87507 T: 505-963-2644 F: 505-820-2941 www.hardwarerenaissance.com

HAND FORGED IRON PATINAS

HARDWARE PRICE INCLUDES CHOICE OF ANY OF THE FOLLOWING HAND APPLIED PATINAS:

PATINA NAME	PATINA CODE
Hot Wax:	HW
Antique Rose:	AR
Antique Bronze:	AB
Rust Highlights:	RH
French Red:	FF
Old Pawn Silver:	OS
Satin Nickel:	SN
Antique Copper:	AC

IMPORTANT NOTE ABOUT OUR IRON PATINAS :

Our Iron hardware in NOT RUST-PROOF. We provide an authentic wax coating only. We cannot guarantee against rust. Maintenance instructions are included with each order. All orders will need a rust-waiver signed by the dealer confirming this understanding. The patinas which hold up best against rust and which are easier to maintain are Hot Wax and Antique Rose. The plated finishes (OS, SN, AC) are likely to rust sooner and are more difficult to maintain.

All patinas are hand applied and will vary slightly from patina samples or display samples. This is due to aging of samples, and natural variations in patina which occur depending upon surface texture of the iron, temperature and humidity while applying the patina. This is considered to be a key part of the beauty and uniqueness of the hand forged iron product and not a defect.

All our patinas are living finishes and will age gracefully over time. How quickly they will age depends upon the conditions of use and maintenance.

LEVER & KNOB OPTIONS
 (All levers and knobs are priced the same)



HL101 Verona



HL102 Soho



HL103 Casa California



HL105 East-West



HL107 Neha



HL108 Fleetwood



HL109 Milan

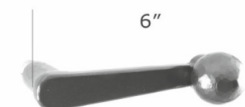

HL111 Ball



HL112 Spoon



HL113 Scrolled



HL116 East-West II



HL131 Accent



HL132 Manhattan



HL135 Toscana



HL136 Capri



HL138 Del Mar



HL139 Chelsea



HL140 Bay



HL141 Scottsdale



HL142 Taos



HL143 Trio



HL144 Fleur de Lis

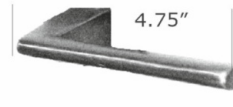

HL145 Salon

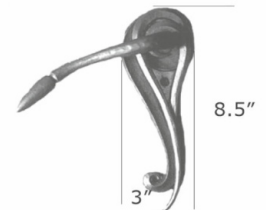

HL104 Art Nouveau

LEVER & KNOB OPTIONS
 (All levers and knobs are priced the same)

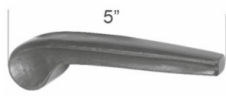

HL146 Mayfair



HL147 Taylor



HL148 Frisco



HL152 Carson



HL153 Loop



HL155 El Secreto

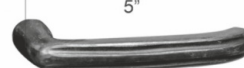

HL156 Monte Vista

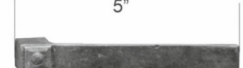

HL157 Cody



HL158 Avila



HL159 Sierra



HL121 Petite Verona



HL122 Petite Neha



HL123 Petite Wave

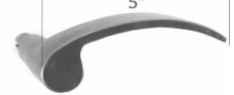

HL124 Petite Soho



HL125 Petite Casa California

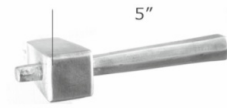

HL126 Petite East-West



HL127 Petite Spoon



HL128 Petite Scrolled

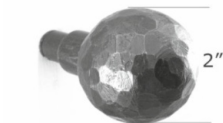

HK751 Forged Large

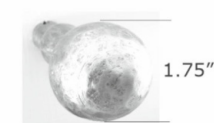

HK752 Forged Medium



HK753 Casa California

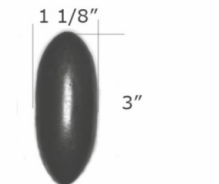

HK755 East-West

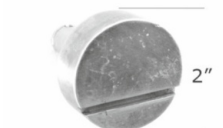

HK756 Sunrise

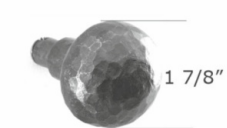

HK757 Mushroom

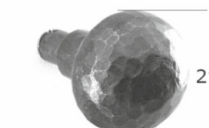

HK757L Mushroom Large

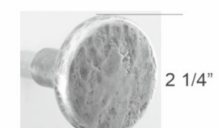

HK758 Martini



HK759 Hampton



HK759M Hampton Medium

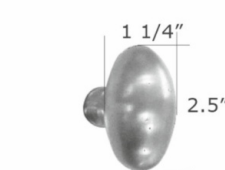

HK760 Bermuda



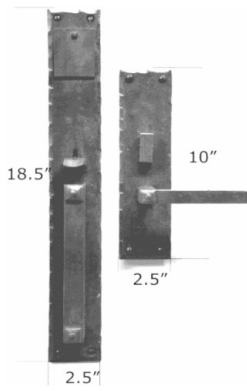
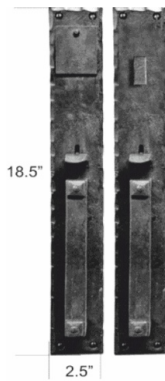
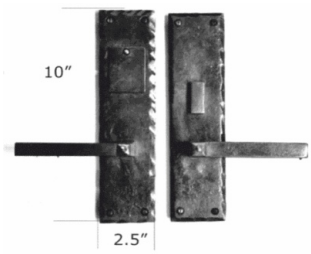

HP718 Ring Pull

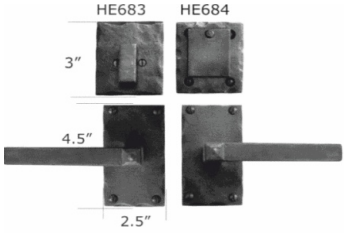
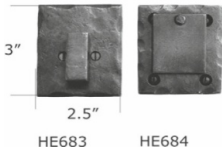
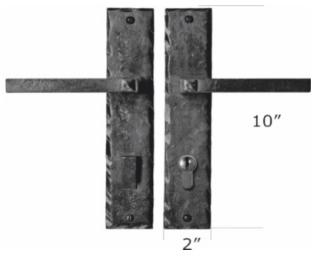
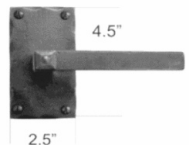

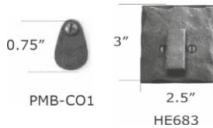
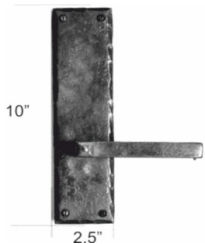
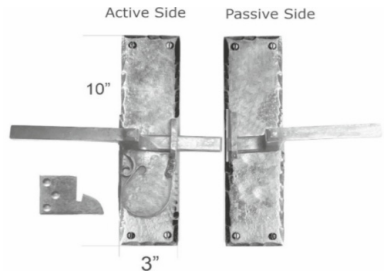
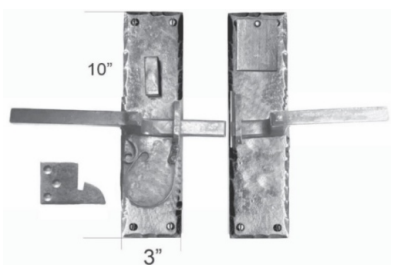
HARDWARE RENAISSANCE		FUNCTION	LIST PRICE \$
IRON CODY COLLECTION			
RUSTIC MODERN COWBOY-CHIC COLLECTION			
<p>CODY Thumbblatch x Lever Entry (Mortise Only) HH453 - HE648-HL157</p> 	EN-ML FD	2,428 1,692	
See Page 5 for choice of Mortise Lock functions. Std Door Thickness: 1.75". Std Backsets: 2.5" or 2.75"			
<p>CODY Thumbblatch x Thumbblatch Entry (Mortise Only) HH453-HH453</p> 	EN-ML FD	2,999 2,199	
See Page 5 for choice of Mortise Lock functions. Std Door Thickness: 1.75". Std Backsets: 2.5" or 2.75"			
<p>CODY Lever x Lever Entry (Mortise or Tubular. Tubular is 5.5" c-to-c) HE648-HL157</p> 	EN-ML PT-ML EN-DB-SC EN-DB-DC PT-DB FD	1,618 1,485 1,155 1,220 1,088 630	
See Page 5 for choice of Mortise Lock functions. Std Door Thickness: 1.75". Std Backsets: 2.5" or 2.75" Tubular: Baton Tubular Latch & Deadbolt. Std Door Thickness: 1.75". Std Backsets 2 3/8" or 2.75"			

HARDWARE RENAISSANCE		FUNCTION	LIST PRICE \$
IRON CODY COLLECTION			
<p>CODY Sectional Lever x Lever Entry (Tubular) HE647-HL157 with HE683-HE684 deadbolt</p>  <p>Mortise: Accurate 9503 Deadlock. Std Door Thickness: 1.75". Std Backsets: 2.5" or 2.75" Baton Tubular Latch & Deadbolt. Std Door Thickness: 1.75". Std Backsets 2 3/8" or 2.75"</p>	<p>HE683 HE684</p> <p>3"</p> <p>4.5"</p> <p>2.5"</p>	<p>EN-DB-SC 884 EN-DB-DC 964 EN-MD 1,058 PT-DB 741 FD 440</p>	
<p>CODY Deadbolt Only (Tubular or Mortise) HE683-HE684</p>  <p>Mortise: Accurate 9503 Deadlock. Std Door Thickness: 1.75". Std Backsets: 2.5" or 2.75" Tubular: Baton Tubular Deadbolt. Std Door Thickness: 1.75". Std Backsets 2 3/8" or 2.75"</p>	<p>3"</p> <p>2.5"</p> <p>HE683 HE684</p>	<p>EN-DB-SC 347 EN-DB-DC 425 PT-DB 203 EN-MD 521</p>	
<p>CODY Multipoint Hardware HE650-HL157</p>  <p>Available for most door makes (except Andersen). See Multipoint Spec Sheets for available configurations and functions Must send Multipoint order form with order</p>	<p>10"</p> <p>2"</p>	<p>EN-US CYL 805 PT-US CYL 714 EN-EURO 922 PT-EURO 874 PP 648 AD 648 FD 617</p>	
<p>CODY Passage/ Privacy/ Dummy (Tubular) HE647-HL157</p>  <p>Baton Tubular Latch. Std Door Thickness: 1.75". Std Backsets: 2 3/8" or 2.75"</p>	<p>4.5"</p> <p>2.5"</p>	<p>PP-TL 538 PR-TL 561 FD 441 SD 221</p>	

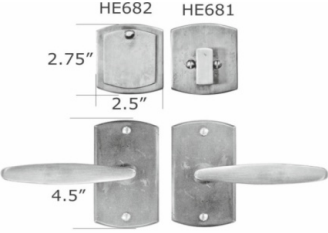
HARDWARE RENAISSANCE		FUNCTION	LIST PRICE \$
IRON CODY COLLECTION			
<p>CODY Privacy Bolt (Tubular: Add to Passage Set) HE683-PMB</p>  <p>Baton Privacy bolt. Std Door Thickness: 1.75". Std Backsets: 2 3/8" or 2.75"</p>	PMB	236	
<p>CODY Passage/ Privacy/ Dummy (Tubular or Mortise) HE648-HL157</p>  <p>Mortise: Accurate 9100 lock. Std Door Thickness: 1.75". Std Backsets: 2.5" or 2.75" Baton Tubular Latch & Privacy Bolt. Std Door Thickness: 1.75". Std Backsets: 2 3/8" or 2.75"</p>	PP-TL 736 PR-TL 759 PR- PMB 945 PP-ML 1,014 PR-ML 1,272 FD 630 SD 315		
<p>CODY Strike-bar Latch HS513 (no lever options - available as shown only)</p>  <p>ENTRY OPTIONS (Mortise or Tubular)</p>  <p>Mortise: Accurate 9503 Deadlock. Std Door Thickness: 1.75". Std Backsets: 2.5" or 2.75" Tubular: Baton Tubular Deadbolt. Std Door Thickness: 1.75". Std Backsets 2 3/8" or 2.75"</p>	PP 758 PR 792 FD 728 SD 364 EN-MD 1,367 EN-DB-SC 1,189 EN-DB-DC 1,248 PT-DB 1,041 FD 728 SD 364		

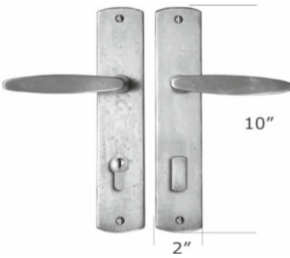
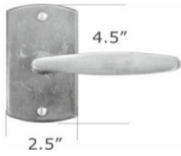
HARDWARE RENAISSANCE		FUNCTION	LIST PRICE \$
IRON EL SECRETO COLLECTION			
RUSTIC MODERN DESIGN WITH SLEEK CURVES			
EL SECRETO Thumbblatch x Lever Entry (Mortise Only) HH451 -HE646-HL155		EN-ML FD	2,428 1,692
See Page 5 for choice of Mortise Lock functions. Std Door Thickness: 1.75". Std Backsets: 2.5" or 2.75"			
EL SECRETO Thumbblatch x Thumbblatch Entry (Mortise Only) HH451-HH451		EN-ML FD	2,999 2,199
See Page 5 for choice of Mortise Lock functions. Std Door Thickness: 1.75". Std Backsets: 2.5" or 2.75"			
EL SECRETO Lever x Lever Entry (Mortise or Tubular. Tubular is 5.5" c-to-c) HE646-HL155		EN-ML PT-ML EN-DB-SC EN-DB-DC PT-DB FD	1,618 1,485 1,155 1,220 1,088 630
See Page 5 for choice of Mortise Lock functions. Std Door Thickness: 1.75". Std Backsets: 2.5" or 2.75" Tubular: Baton Tubular Latch & Deadbolt. Std Door Thickness: 1.75". Std Backsets 2 3/8" or 2.75"			

HARDWARE RENAISSANCE		FUNCTION	LIST PRICE \$
IRON EL SECRETO COLLECTION			
<p>EL SECRETO Sectional Lever x Lever Entry (Tubular) HE645-HL155 with HE681-HE682 deadbolt</p>  <p>Mortise: Accurate 9503 Deadlock. Std Door Thickness: 1.75". Std Backsets: 2.5" or 2.75" Baton Tubular Latch & Deadbolt. Std Door Thickness: 1.75". Std Backsets 2 3/8" or 2.75"</p>	<p>EN-DB-SC 884 EN-DB-DC 964 EN-MD 1,058 PT-DB 741 FD 440</p>		
<p>EL SECRETO Deadbolt Only (Tubular or Mortise) HE681-HE682</p>  <p>Mortise: Accurate 9503 Deadlock. Std Door Thickness: 1.75". Std Backsets: 2.5" or 2.75" Tubular: Baton Tubular Deadbolt. Std Door Thickness: 1.75". Std Backsets 2 3/8" or 2.75"</p>	<p>EN-DB-SC 347 EN-DB-DC 425 PT-DB 203 EN-MD 521</p>		
<p>EL SECRETO Multipoint Hardware HE649-HL155</p>  <p>Available for most door makes (except Andersen). See Multipoint Spec Sheets for available configurations and functions Must send Multipoint order form with order</p>	<p>EN-US CYL 805 PT-US CYL 714 EN-EURO 922 PT-EURO 874 PP 648 AD 648 FD 617</p>		
<p>EL SECRETO Passage/ Privacy/ Dummy (Tubular) HE645-HL155</p>  <p>Baton Tubular Latch. Std Door Thickness: 1.75". Std Backsets: 2 3/8" or 2.75"</p>	<p>PP-TL 538 PR-TL 561 FD 441 SD 221</p>		

HARDWARE RENAISSANCE	FUNCTION	LIST PRICE \$
IRON EL SECRETO COLLECTION		
<p>EL SECRETO Privacy Bolt (Tubular: Add to Passage Set) HE681-PMB</p> <div style="text-align: center;">  </div> <p>Baton Privacy bolt. Std Door Thickness: 1.75". Std Backsets: 2 3/8" or 2.75"</p>	PMB	236
<p>EL SECRETO Passage/ Privacy/ Dummy (Tubular or Mortise) HE646-HL155</p> <div style="text-align: center;">  </div> <p>Mortise: Accurate 9100 lock. Std Door Thickness: 1.75". Std Backsets: 2.5" or 2.75" Baton Tubular Latch & Privacy Bolt. Std Door Thickness: 1.75". Std Backsets: 2 3/8" or 2.75"</p>	PP-TL PR-TL PR- PMB PP-ML PR-ML FD SD	736 759 945 1,014 1,271 630 315

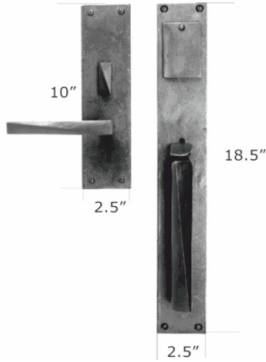
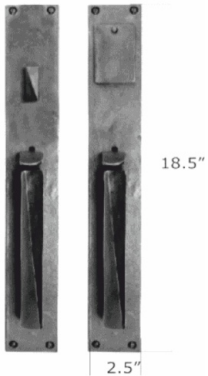
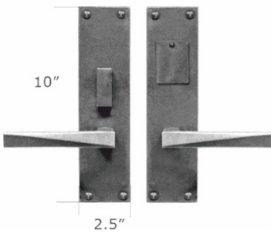
HARDWARE RENAISSANCE		FUNCTION	LIST PRICE \$
IRON MILAN COLLECTION			
RUSTIC MODERN WITH STRAIGHT EDGES & DISTINCTIVE DESIGN			
<p>MILAN II Thumbblatch x Lever Entry (Mortise Only) HH448- HE621-HL109</p> 	EN-ML FD	2,428 1,691	
See Page 5 for choice of Mortise Lock functions. Std Door Thickness: 1.75". Std Backsets: 2.5" or 2.75"			
<p>MILAN II Thumbblatch x Thumbblatch Entry (Mortise Only) HH448-HH448</p> 	EN-ML FD	2,999 2,198	
See Page 5 for choice of Mortise Lock functions. Std Door Thickness: 1.75". Std Backsets: 2.5" or 2.75"			
<p>MILAN Lever x Lever Entry (Mortise or Tubular. Tubular is 5.5" c-to-c) HE621-HL109</p> 	EN-ML PT-ML EN-DB-SC EN-DB-DC PT-DB FD	1,618 1,485 1,155 1,220 1,088 630	
See Page 5 for choice of Mortise Lock functions. Std Door Thickness: 1.75". Std Backsets: 2.5" or 2.75" Tubular: Baton Tubular Latch & Deadbolt. Std Door Thickness: 1.75". Std Backsets 2 3/8" or 2.75"			

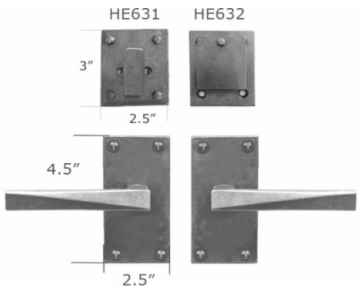
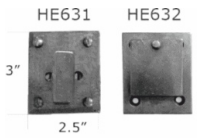
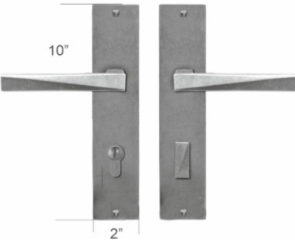
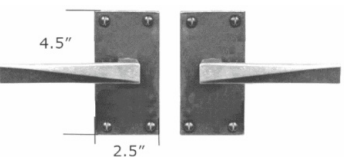

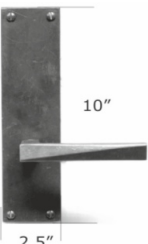
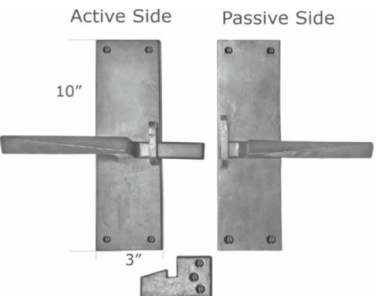
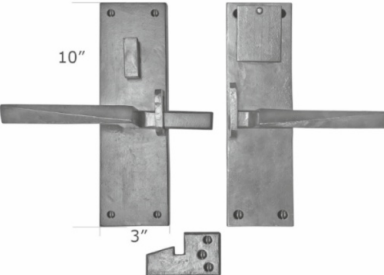
HARDWARE RENAISSANCE		FUNCTION	LIST PRICE \$
IRON MILAN COLLECTION			
<p>MILAN Sectional Lever x Lever Entry (Tubular) HE620-HL109 with HE631-HE632 deadbolt</p>  <p>Mortise: Accurate 9503 Deadlock. Std Door Thickness: 1.75". Std Backsets: 2.5" or 2.75" Baton Tubular Latch & Deadbolt. Std Door Thickness: 1.75". Std Backsets 2 3/8" or 2.75"</p>	<p>EN-DB-SC 884 EN-DB-DC 964 EN-MD 1,058 PT-DB 741 FD 440</p>		
<p>Modern Deadbolt Only (Tubular or Mortise) HE631-HE632</p>  <p>Mortise: Accurate 9503 Deadlock. Std Door Thickness: 1.75". Std Backsets: 2.5" or 2.75" Tubular: Baton Tubular Deadbolt. Std Door Thickness: 1.75". Std Backsets 2 3/8" or 2.75"</p>	<p>EN-DB-SC 346 EN-DB-DC 426 PT-DB 203 EN-MD 520</p>		
<p>MILAN Multipoint Hardware HE606-HL109</p>  <p>Available for most door makes (except Andersen). See Multipoint Spec Sheets for available configurations and functions Must send Multipoint order form with order</p>	<p>EN-US CYL 805 PT-US CYL 714 EN-EURO 922 PT-EURO 873 PP 648 AD 648 FD 617</p>		
<p>MILAN Passage/ Privacy/ Dummy (Tubular) HE620-HL109</p>  <p>Baton Tubular Latch. Std Door Thickness: 1.75". Std Backsets: 2 3/8" or 2.75"</p>	<p>PP-TL 538 PR-TL 561 FD 441 SD 220</p>		

HARDWARE RENAISSANCE		FUNCTION	LIST PRICE \$
IRON MILAN COLLECTION			
<p>Modern Privacy Bolt (Tubular: Add to Passage Set) HE631-PMB</p> 	PMB	236	
Baton Privacy bolt. Std Door Thickness: 1.75". Std Backsets: 2 3/8" or 2.75"			
<p>MILAN Passage/ Privacy/ Dummy (Tubular or Mortise) HE621-HL109</p> 	PP-TL PR-TL PR-PMB PP-ML PR-ML FD SD	736 759 945 1,014 1,271 630 315	
Mortise: Accurate 9100 lock. Std Door Thickness: 1.75". Std Backsets: 2.5" or 2.75" Baton Tubular Latch & Privacy Bolt. Std Door Thickness: 1.75". Std Backsets: 2 3/8" or 2.75"			
<p>MILAN Strike-bar Latch HS512 (no lever options - available as shown only)</p> 	PP PR FD SD	759 792 728 364	
<p>ENTRY OPTIONS (Mortise or Tubular)</p> 	EN-MD EN-DB-SC EN-DB-DC PT-DB FD SD	1,367 1,188 1,248 1,041 728 364	
Mortise: Accurate 9503 Deadlock. Std Door Thickness: 1.75". Std Backsets: 2.5" or 2.75" Tubular: Baton Tubular Deadbolt. Std Door Thickness: 1.75". Std Backsets 2 3/8" or 2.75"			

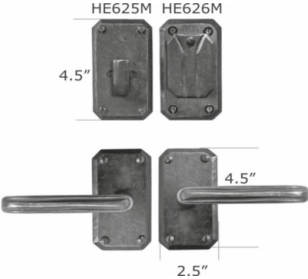
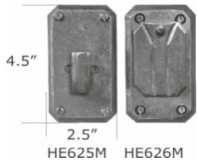
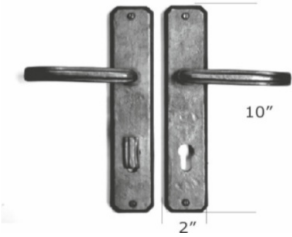
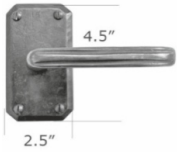
HARDWARE RENAISSANCE		FUNCTION	LIST PRICE \$
IRON MONTE VISTA COLLECTION TRANSITIONAL RIBBED DESIGN			
<p>MONTE VISTA Thumbblatch x Lever Entry (Mortise Only) HH452 - HE642-HL156</p> 	EN-ML FD	2,428 1,691	
See Page 5 for choice of Mortise Lock functions. Std Door Thickness: 1.75". Std Backsets: 2.5" or 2.75"			
<p>MONTE VISTA Thumbblatch x Thumbblatch Entry (Mortise Only) HH452-HH452</p> 	EN-ML FD	2,999 2,198	
See Page 5 for choice of Mortise Lock functions. Std Door Thickness: 1.75". Std Backsets: 2.5" or 2.75"			
<p>MONTE VISTA Lever x Lever Entry (Mortise or Tubular. Tubular is 5.5" c-to-c) HE642-HL156</p> 	EN-ML PT-ML EN-DB-SC EN-DB-DC PT-DB FD	1,618 1,485 1,155 1,220 1,088 630	
See Page 5 for choice of Mortise Lock functions. Std Door Thickness: 1.75". Std Backsets: 2.5" or 2.75" Tubular: Baton Tubular Latch & Deadbolt. Std Door Thickness: 1.75". Std Backsets 2 3/8" or 2.75"			

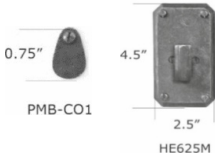
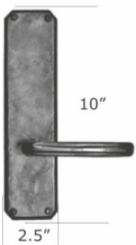
HARDWARE RENAISSANCE		FUNCTION	LIST PRICE \$
IRON MONTE VISTA COLLECTION			
<p>MONTE VISTA Sectional Lever x Lever Entry (Tubular) HE643-HL156 with HE625M-HE626M deadbolt</p>  <p>Mortise: Accurate 9503 Deadlock. Std Door Thickness: 1.75". Std Backsets: 2.5" or 2.75" Baton Tubular Latch & Deadbolt. Std Door Thickness: 1.75". Std Backsets 2 3/8" or 2.75"</p>	<p>EN-DB-SC 884 EN-DB-DC 964 EN-MD 1,058 PT-DB 741 FD 440</p>		
<p>MONTE VISTA Deadbolt Only (Tubular or Mortise) HE625M-HE626M</p>  <p>Mortise: Accurate 9503 Deadlock. Std Door Thickness: 1.75". Std Backsets: 2.5" or 2.75" Tubular: Baton Tubular Deadbolt. Std Door Thickness: 1.75". Std Backsets 2 3/8" or 2.75"</p>	<p>EN-DB-SC 346 EN-DB-DC 426 PT-DB 203 EN-MD 520</p>		
<p>MONTE VISTA Multipoint Hardware HE644-HL156</p>  <p>Available for most door makes (except Andersen). See Multipoint Spec Sheets for available configurations and functions Must send Multipoint order form with order</p>	<p>EN-US CYL 805 PT-US CYL 714 EN-EURO 922 PT-EURO 873 PP 648 AD 648 FD 617</p>		
<p>MONTE VISTA Passage/ Privacy/ Dummy (Tubular) HE643-HL156</p>  <p>Baton Tubular Latch. Std Door Thickness: 1.75". Std Backsets: 2 3/8" or 2.75"</p>	<p>PP-TL 538 PR-TL 561 FD 441 SD 220</p>		

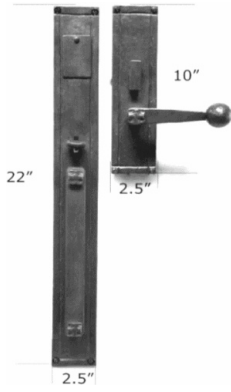
HARDWARE RENAISSANCE	FUNCTION	LIST PRICE \$
IRON MONTE VISTA COLLECTION		
<p>MONTE VISTA Privacy Bolt (Tubular: Add to Passage Set) HE625M-PMB</p>  <p>Baton Privacy bolt. Std Door Thickness: 1.75". Std Backsets: 2 3/8" or 2.75"</p>	PMB	236
<p>MONTE VISTA Passage/ Privacy/ Dummy (Tubular or Mortise) HE642-HL156</p>  <p>Mortise: Accurate 9100 lock. Std Door Thickness: 1.75". Std Backsets: 2.5" or 2.75" Baton Tubular Latch & Privacy Bolt. Std Door Thickness: 1.75". Std Backsets: 2 3/8" or 2.75"</p>	PP-TL PR-TL PR- PMB PP-ML PR-ML FD SD	736 759 945 1,014 1,271 630 315

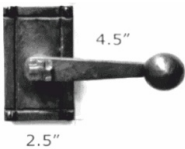
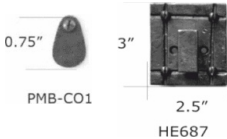
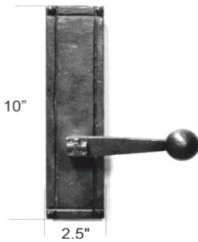
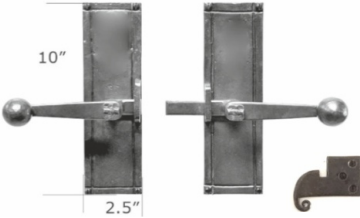
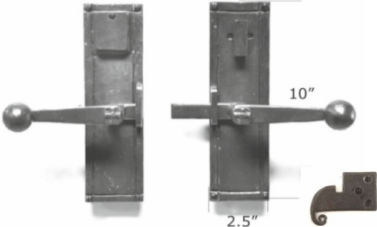

HARDWARE RENAISSANCE	FUNCTION	LIST PRICE \$
IRON SIERRA COLLECTION		
DISTINCTIVE WESTERN INSPIRED DESIGN		
<p>SIERRA Thumbblatch x Lever Entry (Mortise Only) HH456 - HE668-HL159</p>  <p>See Page 5 for choice of Mortise Lock functions. Std Door Thickness: 1.75". Std Backsets: 2.5" or 2.75"</p>	EN-ML FD	2,642 1,881
<p>SIERRA Thumbblatch x Strike-bar Latch Entry (Mortise Only) HH456-HS514</p> <p>No lever option</p>  <p>HS514 (shown w/HL159)</p> <p>Accurate 9503 Mortise Deadbolt. Std Door Thickness: 1.75". Std Backsets: 2.5" or 2.75"</p>	EN-MD FD	2,525 2,057
<p>SIERRA Thumbblatch x Thumbblatch Entry (Mortise Only) HH456-HH456</p>  <p>See Page 5 for choice of Mortise Lock functions. Std Door Thickness: 1.75". Std Backsets: 2.5" or 2.75"</p>	EN-ML FD	3,233 2,448

HARDWARE RENAISSANCE		FUNCTION	LIST PRICE \$
IRON SIERRA COLLECTION			
<p>SIERRA Lever x Lever Entry (Mortise or Tubular. Tubular is 5.5" c-to-c) HE668-HL159</p>  <p>See Page 5 for choice of Mortise Lock functions. Std Door Thickness: 1.75". Std Backsets: 2.5" or 2.75" Tubular: Baton Tubular Latch & Deadbolt. Std Door Thickness: 1.75". Std Backsets 2 3/8" or 2.75"</p>	<p>EN-ML 1,618 PT-ML 1,485 EN-DB-SC 1,155 EN-DB-DC 1,220 PT-DB 1,088 FD 630</p>		
<p>SIERRA Sectional Lever x Lever Entry (Tubular) HE667-HL159 with HE687-HE688 deadbolt</p>  <p>Mortise: Accurate 9503 Deadlock. Std Door Thickness: 1.75". Std Backsets: 2.5" or 2.75" Baton Tubular Latch & Deadbolt. Std Door Thickness: 1.75". Std Backsets 2 3/8" or 2.75"</p>	<p>EN-DB-SC 884 EN-DB-DC 964 EN-MD 1,058 PT-DB 741 FD 440</p>		
<p>SIERRA Deadbolt Only (Tubular or Mortise) HE687-HE688</p>  <p>Mortise: Accurate 9503 Deadlock. Std Door Thickness: 1.75". Std Backsets: 2.5" or 2.75" Baton Tubular Latch & Deadbolt. Std Door Thickness: 1.75". Std Backsets 2 3/8" or 2.75"</p>	<p>EN-DB-SC 346 EN-DB-DC 426 PT-DB 203 EN-MD 520</p>		
<p>SIERRA Multipoint Hardware HE669-HL159</p>  <p>Available for most door makes (except Andersen). See Multipoint Spec Sheets for available configurations and functions Must send Multipoint order form with order</p>	<p>EN-US CYL 805 PT-US CYL 714 EN-EURO 922 PT-EURO 873 PP 648 AD 648 FD 617</p>		

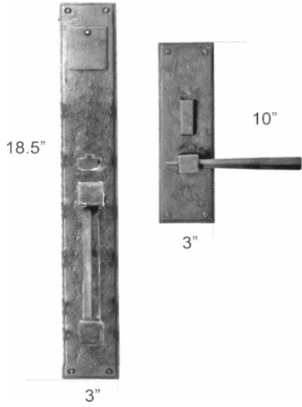
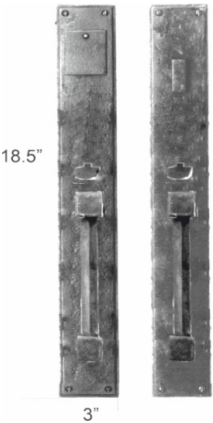
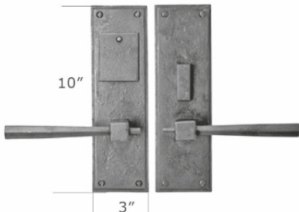
HARDWARE RENAISSANCE		FUNCTION	LIST PRICE \$
IRON SIERRA COLLECTION			
SIERRA Passage/ Privacy/ Dummy (Tubular) HE667-HL159		PP-TL PR-TL FD SD	538 561 441 220
Baton Tubular Latch. Std Door Thickness: 1.75". Std Backsets: 2 3/8" or 2.75"			
SIERRA Privacy Bolt (Tubular: Add to Passage Set) HE687-PMB		PMB	236
Baton Privacy bolt. Std Door Thickness: 1.75". Std Backsets: 2 3/8" or 2.75"			
SIERRA Passage/ Privacy/ Dummy (Tubular or Mortise) HE668-HL159		PP-TL PR-TL PR- PMB PP-ML PR-ML FD SD	736 759 945 1,014 1,271 630 315
Mortise: Accurate 9100 lock. Std Door Thickness: 1.75". Std Backsets: 2.5" or 2.75" Baton Tubular Latch & Privacy Bolt. Std Door Thickness: 1.75". Std Backsets: 2 3/8" or 2.75"			
SIERRA Strike-bar Latch HS514 (no lever options - available as shown only)		PP PR FD SD	759 792 728 364
ENTRY OPTIONS (Mortise or Tubular)		EN-MD EN-DB-SC EN-DB-DC PT-DB FD SD	1,367 1,188 1,248 1,041 728 364
Mortise: Accurate 9503 Deadlock. Std Door Thickness: 1.75". Std Backsets: 2.5" or 2.75" Tubular: Baton Tubular Deadbolt. Std Door Thickness: 1.75". Std Backsets 2 3/8" or 2.75"			

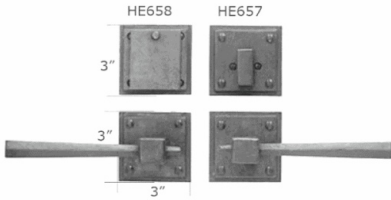
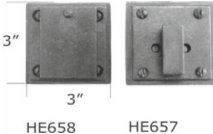
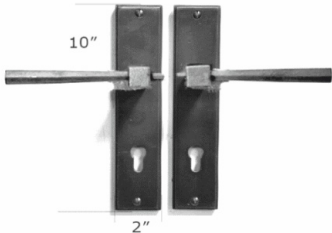
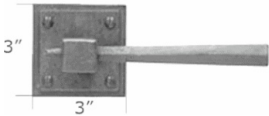
HARDWARE RENAISSANCE		FUNCTION	LIST PRICE \$
IRON STEP COLLECTION			
RUSTIC MODERN DESIGN WITH STEP ESCUTCHEONS - AVAILABLE WITH ANY LEVER OR KNOB			
<p>STEP Thumbblatch x Lever Entry (Mortise Only) HH463 - HE614-HL105</p> 	EN-ML FD	2,428 1,691	
See Page 5 for choice of Mortise Lock functions. Std Door Thickness: 1.75". Std Backsets: 2.5" or 2.75"			
<p>STEP Thumbblatch x Thumbblatch Entry (Mortise Only) HH463-HH463</p> 	EN-ML FD	2,999 2,198	
See Page 5 for choice of Mortise Lock functions. Std Door Thickness: 1.75". Std Backsets: 2.5" or 2.75"			
<p>STEP Lever x Lever Entry (Mortise or Tubular. Tubular is 5.5" c-to-c) HE614-HL105 (available with any lever or knob)</p> 	EN-ML PT-ML EN-DB-SC EN-DB-DC PT-DB FD	1,618 1,485 1,155 1,220 1,088 630	
See Page 5 for choice of Mortise Lock functions. Std Door Thickness: 1.75". Std Backsets: 2.5" or 2.75" Tubular: Baton Tubular Latch & Deadbolt. Std Door Thickness: 1.75". Std Backsets 2 3/8" or 2.75"			

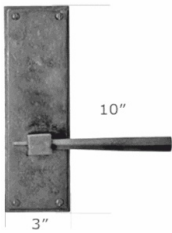

HARDWARE RENAISSANCE		FUNCTION	LIST PRICE \$
IRON STEP COLLECTION			
<p>STEP Sectional Lever x Lever Entry (Tubular) HE615-H105 (available with any lever or knob) with HE657-HE658 deadbolt</p>  <p>Mortise: Accurate 9503 Deadlock. Std Door Thickness: 1.75". Std Backsets: 2.5" or 2.75" Baton Tubular Latch & Deadbolt. Std Door Thickness: 1.75". Std Backsets 2 3/8" or 2.75"</p>	<p>EN-DB-SC 884 EN-DB-DC 964 EN-MD 1,058 PT-DB 741 FD 440</p>		
<p>STEP Deadbolt Only (Tubular or Mortise) HE657-HE658</p>  <p>Mortise: Accurate 9503 Deadlock. Std Door Thickness: 1.75". Std Backsets: 2.5" or 2.75" Tubular: Baton Tubular Deadbolt. Std Door Thickness: 1.75". Std Backsets 2 3/8" or 2.75"</p>	<p>EN-DB-SC 346 EN-DB-DC 426 PT-DB 203 EN-MD 520</p>		
<p>STEP Multipoint Hardware HE616-HL105 (available with any lever or knob)</p>  <p>Available for most door makes (except Andersen). See Multipoint Spec Sheets for available configurations and functions Must send Multipoint order form with order</p>	<p>EN-US CYL 805 PT-US CYL 714 EN-EURO 922 PT-EURO 873 PP 648 AD 648 FD 617</p>		
<p>STEP Passage/ Privacy/ Dummy (Tubular) HE615-HL105 (available with any lever or knob)</p>  <p>Baton Tubular Latch. Std Door Thickness: 1.75". Std Backsets: 2 3/8" or 2.75"</p>	<p>PP-TL 538 PR-TL 561 FD 441 SD 220</p>		

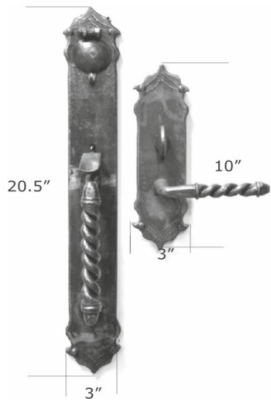
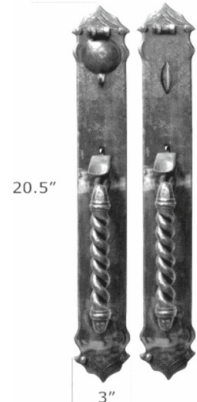
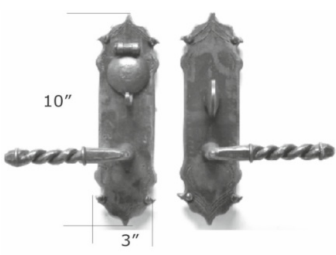
HARDWARE RENAISSANCE	FUNCTION	LIST PRICE \$
IRON STEP COLLECTION		
<p>STEP Privacy Bolt (Tubular: Add to Passage Set) HE657-PMB</p> <div style="display: flex; justify-content: space-around; align-items: center;"> <div style="text-align: center;">  <p>0.75"</p> <p>PMB-CO1</p> </div> <div style="text-align: center;">  <p>3"</p> <p>3"</p> <p>HE657</p> </div> </div> <p>Baton Privacy bolt. Std Door Thickness: 1.75". Std Backsets: 2 3/8" or 2.75"</p>	PMB	236
<p>STEP Passage/ Privacy/ Dummy (Tubular or Mortise) HE614-HL105 (available with any lever or knob)</p> <div style="text-align: center;">  <p>10"</p> <p>3"</p> </div> <p>Mortise: Accurate 9100 lock. Std Door Thickness: 1.75". Std Backsets: 2.5" or 2.75" Baton Tubular Latch & Privacy Bolt. Std Door Thickness: 1.75". Std Backsets: 2 3/8" or 2.75"</p>	PP-TL PR-TL PR- PMB PP-ML PR-ML FD SD	736 759 945 1,014 1,271 630 315

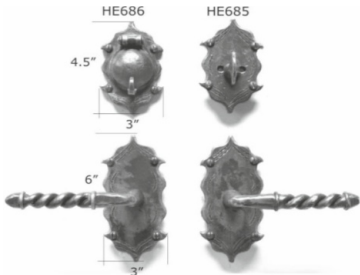
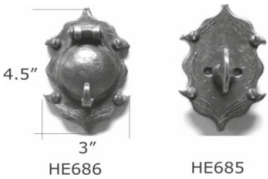
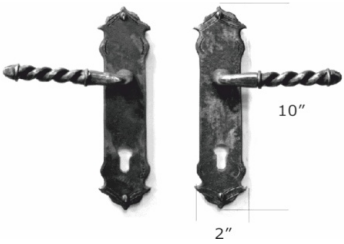
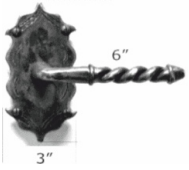
HARDWARE RENAISSANCE		FUNCTION	LIST PRICE \$
IRON AVILA COLLECTION			
SPANISH COLONIAL REVIVAL ELEGANCE			
<p>AVILA Thumbblatch x Lever Entry (Mortise Only) HH455 - HE664-HL158</p>  <p>See Page 5 for choice of Mortise Lock functions. Std Door Thickness: 1.75". Std Backsets: 2.5" or 2.75"</p>	EN-ML FD	3,109 2,313	
<p>AVILA Thumbblatch x Thumbblatch Entry (Mortise Only) HH455-HH455</p>  <p>See Page 5 for choice of Mortise Lock functions. Std Door Thickness: 1.75". Std Backsets: 2.5" or 2.75"</p>	EN-ML FD	3,623 2,817	
<p>AVILA Lever x Lever Entry (Mortise or Tubular. Tubular is 5.5" c-to-c) HE664-HL158</p>  <p>See Page 5 for choice of Mortise Lock functions. Std Door Thickness: 1.75". Std Backsets: 2.5" or 2.75" Tubular: Baton Tubular Latch & Deadbolt. Std Door Thickness: 1.75". Std Backsets 2 3/8" or 2.75"</p>	EN-ML PT-ML EN-DB-SC EN-DB-DC PT-DB FD	1,699 1,613 1,283 1,347 1,216 692	

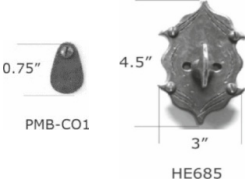
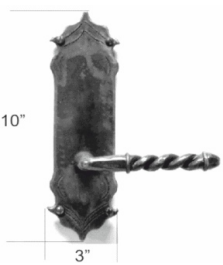
HARDWARE RENAISSANCE		FUNCTION	LIST PRICE \$
IRON AVILA COLLECTION			
<p>AVILA Sectional Lever x Lever Entry (Tubular) HE663-HL158 with HE685-HE686 deadbolt</p>  <p>Mortise: Accurate 9503 Deadlock. Std Door Thickness: 1.75". Std Backsets: 2.5" or 2.75" Baton Tubular Latch & Deadbolt. Std Door Thickness: 1.75". Std Backsets 2 3/8" or 2.75"</p>	<p>EN-DB-SC 1,107 EN-DB-DC 1,149 EN-MD 1,281 PT-DB 953 FD 577</p>		
<p>AVILA Deadbolt Only (Tubular or Mortise) HE685-HE686</p>  <p>Mortise: Accurate 9503 Deadlock. Std Door Thickness: 1.75". Std Backsets: 2.5" or 2.75" Tubular: Baton Tubular Deadbolt. Std Door Thickness: 1.75". Std Backsets 2 3/8" or 2.75"</p>	<p>EN-DB-SC 415 EN-DB-DC 456 PT-DB 260 EN-MD 578</p>		
<p>AVILA Multipoint Hardware HE665-HL158</p>  <p>Available for most door makes (except Andersen). See Multipoint Spec Sheets for available configurations and functions Must send Multipoint order form with order</p>	<p>EN-US CYL 867 PT-US CYL 774 EN-EURO 983 PT-EURO 933 PP 708 AD 708 FD 677</p>		
<p>AVILA Passage/ Privacy/ Dummy (Tubular) HE663-HL158</p>  <p>Baton Tubular Latch. Std Door Thickness: 1.75". Std Backsets: 2 3/8" or 2.75"</p>	<p>PP-TL 692 PR-TL 715 FD 576 SD 288</p>		

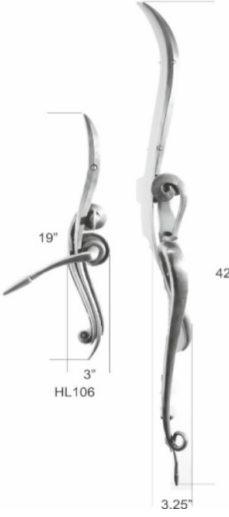
HARDWARE RENAISSANCE	FUNCTION	LIST PRICE \$
IRON AVILA COLLECTION		
<p>AVILA Privacy Bolt (Tubular: Add to Passage Set) HE685-PMB</p>  <p>Baton Privacy bolt. Std Door Thickness: 1.75". Std Backsets: 2 3/8" or 2.75"</p>	PMB	258
<p>AVILA Passage/ Privacy/ Dummy (Tubular or Mortise) HE664-HL158</p>  <p>Mortise: Accurate 9100 lock. Std Door Thickness: 1.75". Std Backsets: 2.5" or 2.75" Baton Tubular Latch & Privacy Bolt. Std Door Thickness: 1.75". Std Backsets: 2 3/8" or 2.75"</p>	PP-TL PR-TL PR- PMB PP-ML PR-ML FD SD	803 827 1,012 1,081 1,338 692 346

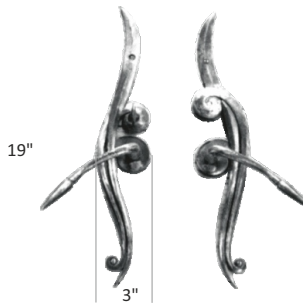



HARDWARE RENAISSANCE		FUNCTION	LIST PRICE \$
IRON ART NOUVEAU COLLECTION			
LIKE NO OTHER! FLOWING, ASYMMETRICAL DESIGN			
<p>ART NOUVEAU LOUVRE Thumbblatch x Lever Entry (Mortise Only) HH445 - HL106</p> <p>NOTE: This design is handed No custom options - available as shown only Extended 10 week lead time</p>  <p>NOT FOR PRE-BORED DOORS!</p> <p>See Page 5 for choice of Mortise Lock functions. Std Door Thickness: 1.75". Std Backsets: 2.5" or 2.75"</p>	EN-ML FD	4,586 4,057	
<p>ART NOUVEAU LOUVRE Thumbblatch x Thumbblatch Entry (Mortise Only) HH445-HH445</p> <p>NOTE: this design is handed No custom options - available as shown only Extended 10 week lead time</p>  <p>NOT FOR PRE-BORED DOORS!</p> <p>See Page 5 for choice of Mortise Lock functions. Std Door Thickness: 1.75". Std Backsets: 2.5" or 2.75"</p>	EN-ML FD	5,464 4,935	
<p>ART NOUVEAU Lever x Lever Entry (Mortise Only) HL106</p> <p>No custom options - available as shown only Extended 10 week lead time</p>  <p>NOT FOR PRE-BORED DOORS!</p> <p>See Page 5 for choice of Mortise Lock functions. Std Door Thickness: 1.75". Std Backsets: 2.5" or 2.75"</p>	EN-ML PT-ML FD	3,112 3,027 2,304	

HARDWARE RENAISSANCE		FUNCTION	LIST PRICE \$
IRON ART NOUVEAU COLLECTION			
<p>ART NOUVEAU Sectional Lever x Lever Entry (Tubular) HL110 with HE627-HE628 deadbolt</p> <p>No custom options - available as shown only Extended 10 week lead time</p> <p>NOT FOR PRE-BORED DOORS! Mortise: Accurate 9503 Deadlock. Std Door Thickness: 1.75". Std Backsets: 2.5" or 2.75" Baton Tubular Latch & Deadbolt. Std Door Thickness: 1.75". Std Backsets 2 3/8" or 2.75"</p>		<p>EN-DB-SC 1,599 EN-DB-DC 1,663 EN-MD 1,773 PT-DB 1,530 FD 825</p>	
<p>ART NOUVEAU Deadbolt Only (Tubular or Mortise) HE627-HE628</p> <p>Extended 10 week lead time</p> <p>Mortise: Accurate 9503 Deadlock. Std Door Thickness: 1.75". Std Backsets: 2.5" or 2.75" Tubular: Baton Tubular Deadbolt. Std Door Thickness: 1.75". Std Backsets 2 3/8" or 2.75"</p>		<p>EN-DB-SC 415 EN-DB-DC 456 PT-DB 260 EN-MD 578</p>	
<p>ART NOUVEAU Multipoint Hardware HL106MP</p> <p>Extended 10 week lead time</p> <p>NOT FOR PRE-BORED DOORS!</p> <p>Available lever high, Patio function ONLY (as shown) Must send Multipoint order form with order</p>		<p>PT-US CYL 2,406 PT-EURO 2,478 PP 2,370 AD 2,370 FD 2,194</p>	
<p>ART NOUVEAU Passage/ Privacy/ Dummy (Tubular) HL104</p> <p>No custom options - available as shown only Extended 10 week lead time</p> <p>NOT FOR PRE-BORED DOORS! Baton Tubular Latch. Std Door Thickness: 1.75". Std Backsets: 2 3/8" or 2.75"</p>		<p>PP-TL 924 PR-TL NA FD 808 SD 404</p>	

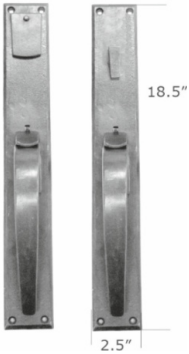
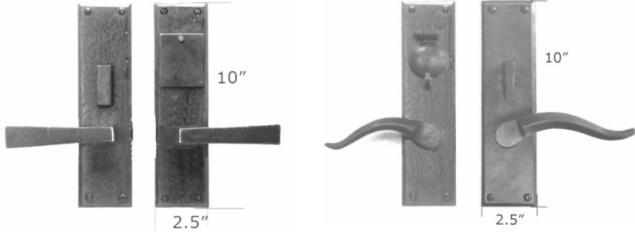
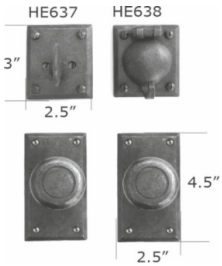
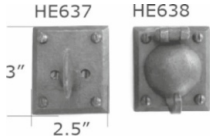
HARDWARE RENAISSANCE	FUNCTION	LIST PRICE \$
IRON ART NOUVEAU COLLECTION		
<p>ART NOUVEAU Privacy Bolt (Tubular: Add to Passage Set) HE627-PMB</p> <p>Extended 10 week lead time</p> <div style="text-align: center;">  <p>0.75" 2 5/8"</p> <p>PMB-CO1 HE627</p> </div> <p>Baton Privacy bolt. Std Door Thickness: 1.75". Std Backsets: 2 3/8" or 2.75"</p>	PMB	258

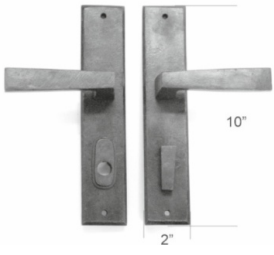
HARDWARE RENAISSANCE	FUNCTION	LIST PRICE \$
IRON BEVELED COLLECTION		
BEVELED ESCUTCHEONS - AVAILABLE WITH ANY LEVER OR KNOB		
<p>VERONA Thumbblatch x Lever Entry (Mortise Only) HH443 - HE607-HL101</p> 	EN-ML FD	2,428 1,691
See Page 5 for choice of Mortise Lock functions. Std Door Thickness: 1.75". Std Backsets: 2.5" or 2.75"		
<p>MANHATTAN Thumbblatch x Lever Entry (Mortise Only) HH444 - HE607-HL132</p> 	EN-ML FD	2,428 1,691
See Page 5 for choice of Mortise Lock functions. Std Door Thickness: 1.75". Std Backsets: 2.5" or 2.75"		
<p>VERONA Thumbblatch x Thumbblatch Entry (Mortise Only) HH443-HH443</p> 	EN-ML FD	2,999 2,198
See Page 5 for choice of Mortise Lock functions. Std Door Thickness: 1.75". Std Backsets: 2.5" or 2.75"		

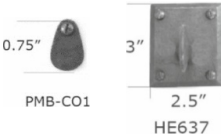
HARDWARE RENAISSANCE		FUNCTION	LIST PRICE \$
IRON BEVELED COLLECTION			
<p>MANHATTAN Thumbblatch x Thumbblatch Entry (Mortise Only) HH444-HH444</p>  <p>See Page 5 for choice of Mortise Lock functions. Std Door Thickness: 1.75". Std Backsets: 2.5" or 2.75"</p>	EN-ML FD	2,999 2,198	
<p>BEVELED Lever x Lever Entry (Mortise or Tubular. Tubular is 5.5" c-to-c) HE607-HL132 or HL101 (available with any lever or knob)</p>  <p>See Page 5 for choice of Mortise Lock functions. Std Door Thickness: 1.75". Std Backsets: 2.5" or 2.75" Tubular: Baton Tubular Deadbolt. Std Door Thickness: 1.75". Std Backsets 2 3/8" or 2.75"</p>	EN-ML PT-ML EN-DB-SC EN-DB-DC PT-DB FD	1,618 1,485 1,155 1,220 1,088 630	
<p>BEVELED Sectional Lever x Lever Entry (Tubular) HE604-HK759 with HE637-HE638 deadbolt (available with any lever or knob)</p>  <p>Mortise: Accurate 9503 Deadlock. Std Door Thickness: 1.75". Std Backsets: 2.5" or 2.75" Baton Tubular Latch & Deadbolt. Std Door Thickness: 1.75". Std Backsets 2 3/8" or 2.75"</p>	EN-DB-SC EN-DB-DC EN-MD PT-DB FD	884 964 1,058 741 440	
<p>BEVELED Deadbolt Only (Tubular or Mortise) HE637-HE638</p>  <p>Mortise: Accurate 9503 Deadlock. Std Door Thickness: 1.75". Std Backsets: 2.5" or 2.75" Tubular: Baton Tubular Deadbolt. Std Door Thickness: 1.75". Std Backsets 2 3/8" or 2.75"</p>	EN-DB-SC EN-DB-DC PT-DB EN-MD	346 426 203 520	



HARDWARE RENAISSANCE		FUNCTION	LIST PRICE \$
IRON BEVELED COLLECTION			
<p>BEVELED Multipoint Hardware</p> <p>HE606B-HL132 (available with any lever or knob)</p>  <p>Available for most door makes (except Andersen). See Multipoint Spec Sheets for available configurations and functions Must send Multipoint order form with order</p>	<p>EN-US CYL 805 PT-US CYL 714 EN-EURO 922 PT-EURO 873 PP 648 AD 648 FD 617</p>		
<p>BEVELED Passage/ Privacy/ Dummy (Tubular)</p> <p>HE604-HK759 (available with any lever or knob)</p>  <p>Baton Tubular Latch. Std Door Thickness: 1.75". Std Backsets: 2 3/8" or 2.75"</p>	<p>PP-TL 538 PR-TL 561 FD 441 SD 220</p>		
<p>BEVELED Privacy Bolt (Tubular: Add to Passage Set)</p> <p>HE637-PMB</p>  <p>Baton Privacy bolt. Std Door Thickness: 1.75". Std Backsets: 2 3/8" or 2.75"</p>	<p>PMB 236</p>		
<p>BEVELED Passage/ Privacy/ Dummy (Tubular or Mortise)</p> <p>HE607-HL101 (available with any lever or knob)</p>  <p>Mortise: Accurate 9100 lock. Std Door Thickness: 1.75". Std Backsets: 2.5" or 2.75" Baton Tubular Latch & Privacy Bolt. Std Door Thickness: 1.75". Std Backsets: 2 3/8" or 2.75"</p>	<p>PP-TL 736 PR-TL 759 PR- PMB 945 PP-ML 1,014 PR-ML 1,271 FD 630 SD 315</p>		

HARDWARE RENAISSANCE		FUNCTION	LIST PRICE \$
IRON CHATEAU COLLECTION			
RUSTIC FRENCH COUNTRY ELEGANCE			
<p>CHATEAU Thumbblatch x Lever Entry (Mortise Only) HH449 - HE481-HL101 (available with any lever or knob)</p>		EN-ML FD	3,109 2,313
See Page 5 for choice of Mortise Lock functions. Std Door Thickness: 1.75". Std Backsets: 2.5" or 2.75"			
<p>CHATEAU Thumbblatch x Thumbblatch Entry (Mortise Only) HH449-HH449</p>		EN-ML FD	3,623 2,807
See Page 5 for choice of Mortise Lock functions. Std Door Thickness: 1.75". Std Backsets: 2.5" or 2.75"			
<p>CHATEAU Lever x Lever Entry (Mortise or Tubular. Tubular is 5.5" c-to-c) HE481-HL113 (available with any lever or knob)</p>		EN-ML PT-ML EN-DB-SC EN-DB-DC PT-DB FD	2,417 2,335 2,020 2,082 1,956 1,678
See Page 5 for choice of Mortise Lock functions. Std Door Thickness: 1.75". Std Backsets: 2.5" or 2.75" Tubular: Baton Tubular Latch & Deadbolt. Std Door Thickness: 1.75". Std Backsets 2 3/8" or 2.75"			

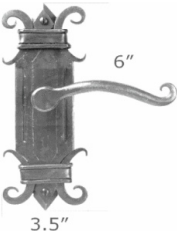
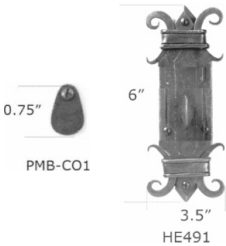
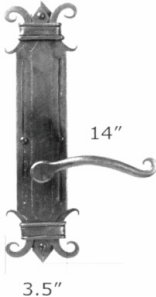
HARDWARE RENAISSANCE		FUNCTION	LIST PRICE \$
IRON CHATEAU COLLECTION			
<p>CHATEAU Sectional Lever x Lever Entry (Tubular) HE482-HL113 with HE491-HE492 deadbolt (available with any lever or knob)</p>		EN-DB-SC 2,032 EN-DB-DC 2,075 EN-MD 2,197 PT-DB 1,601 FD 962	
<p>Mortise: Accurate 9503 Deadlock. Std Door Thickness: 1.75". Std Backsets: 2.5" or 2.75" Baton Tubular Latch & Deadbolt. Std Door Thickness: 1.75". Std Backsets 2 3/8" or 2.75"</p>			
<p>CHATEAU Deadbolt Only (Tubular or Mortise) HE491-HE492</p>		EN-DB-SC 966 EN-DB-DC 1,008 PT-DB 533 EN-MD 1,129	
<p>Mortise: Accurate 9503 Deadlock. Std Door Thickness: 1.75". Std Backsets: 2.5" or 2.75" Tubular: Baton Tubular Deadbolt. Std Door Thickness: 1.75". Std Backsets 2 3/8" or 2.75"</p>			
<p>CHATEAU Multipoint Hardware HE480-HL121 (available with any lever or knob)</p>		EN-US CYL 1,935 PT-US CYL 1,847 EN-EURO 2,046 PT-EURO 1,999 PP 1,785 AD 1,785 FD 1,678	
<p>Available for most door makes (except Andersen). See Multipoint Spec Sheets for available configurations and functions Must send Multipoint order form with order</p>			

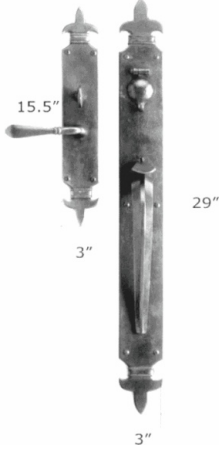
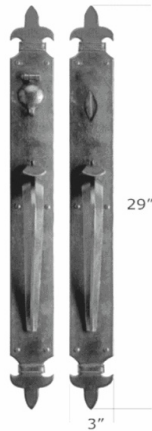
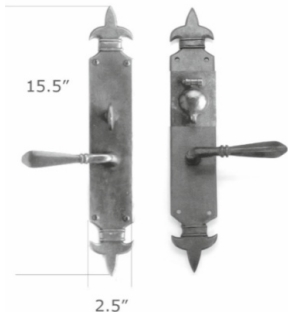
HARDWARE RENAISSANCE		FUNCTION	LIST PRICE \$
IRON CHATEAU COLLECTION			
<p>CHATEAU Passage/ Privacy/ Dummy (Tubular) HE482-HL113 (available with any lever or knob)</p>  <p>Baton Tubular Latch. Std Door Thickness: 1.75". Std Backsets: 2 3/8" or 2.75"</p>	PP-TL PR-TL FD SD	1,067 1,090 962 481	
<p>CHATEAU Privacy Bolt (Tubular: Add to Passage Set) HE491-PMB</p>  <p>Baton Privacy bolt. Std Door Thickness: 1.75". Std Backsets: 2 3/8" or 2.75"</p>	PMB	307	
<p>CHATEAU Passage/ Privacy/ Dummy (Tubular or Mortise) HE481-HL113 (available with any lever or knob)</p>  <p>Mortise: Accurate 9100 lock. Std Door Thickness: 1.75". Std Backsets: 2.5" or 2.75" Baton Tubular Latch & Privacy Bolt. Std Door Thickness: 1.75". Std Backsets: 2 3/8" or 2.75"</p>	PP-TL PR-TL PR- PMB PP-ML PR-ML FD SD	1,842 1,864 2,041 2,108 2,365 1,678 839	

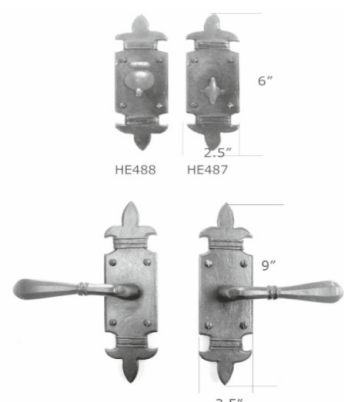
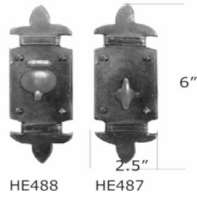
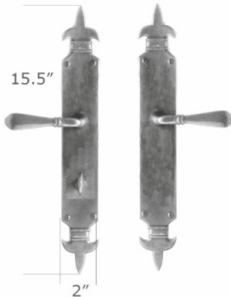
HARDWARE RENAISSANCE	FUNCTION	LIST PRICE \$
IRON FLEUR DE LIS COLLECTION		
A REINVENTED FRENCH CLASSIC		
<p>FLEUR DE LIS Thumbblatch x Lever Entry (Mortise Only) HH447 - HE484-HL144</p>  <p>See Page 5 for choice of Mortise Lock functions. Std Door Thickness: 1.75". Std Backsets: 2.5" or 2.75"</p>	EN-ML FD	2,717 1,934
<p>FLEUR DE LIS Thumbblatch x Thumbblatch Entry (Mortise Only) HH447-HH447</p>  <p>See Page 5 for choice of Mortise Lock functions. Std Door Thickness: 1.75". Std Backsets: 2.5" or 2.75"</p>	EN-ML FD	3,323 2,498
<p>FLEUR DE LIS Lever x Lever Entry (Mortise or Tubular. Tubular is 5.5" c-to-c) HE484-HL144</p>  <p>See Page 5 for choice of Mortise Lock functions. Std Door Thickness: 1.75". Std Backsets: 2.5" or 2.75" Tubular: Baton Tubular Latch & Deadbolt. Std Door Thickness: 1.75". Std Backsets 2 3/8" or 2.75"</p>	EN-ML PT-ML EN-DB-SC EN-DB-DC PT-DB FD	1,699 1,613 1,283 1,347 1,216 662

HARDWARE RENAISSANCE		FUNCTION	LIST PRICE \$
IRON FLEUR DE LIS COLLECTION			
<p>FLEUR DE LIS Sectional Lever x Lever Entry (Tubular) HE485-HL144 with HE487-HE488 deadbolt</p>  <p>Mortise: Accurate 9503 Deadlock. Std Door Thickness: 1.75". Std Backsets: 2.5" or 2.75" Baton Tubular Latch & Deadbolt. Std Door Thickness: 1.75". Std Backsets 2 3/8" or 2.75"</p>	<p>EN-DB-SC 1,151 EN-DB-DC 1,193 EN-MD 1,325 PT-DB 997 FD 630</p>		
<p>FLEUR DE LIS Deadbolt Only (Tubular or Mortise) HE487-HE488</p>  <p>Mortise: Accurate 9503 Deadlock. Std Door Thickness: 1.75". Std Backsets: 2.5" or 2.75" Tubular: Baton Tubular Deadbolt. Std Door Thickness: 1.75". Std Backsets 2 3/8" or 2.75"</p>	<p>EN-DB-SC 415 EN-DB-DC 456 PT-DB 260 EN-MD 578</p>		
<p>FLEUR DE LIS Multipoint Hardware HE489W-HL144</p>  <p>Available for most door makes (except Andersen). See Multipoint Spec Sheets for available configurations and functions Must send Multipoint order form with order</p>	<p>EN-US CYL 867 PT-US CYL 774 EN-EURO 983 PT-EURO 933 PP 708 AD 708 FD 686</p>		
<p>FLEUR DE LIS Passage/ Privacy/ Dummy (Tubular) HE485-HL144</p>  <p>Baton Tubular Latch. Std Door Thickness: 1.75". Std Backsets: 2 3/8" or 2.75"</p>	<p>PP-TL 736 PR-TL 759 PP-ML 1,014 FD 630 SD 315</p>		

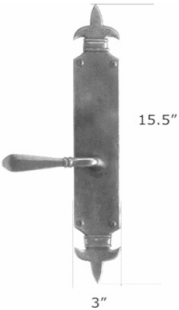

HARDWARE RENAISSANCE	FUNCTION	LIST PRICE \$
IRON FLEUR DE LIS COLLECTION		
<p>FLEUR DE LIS Privacy Bolt (Tubular: Add to Passage Set) HE487-PMB</p>  <p>Baton Privacy bolt. Std Door Thickness: 1.75". Std Backsets: 2 3/8" or 2.75"</p>	PMB	258
<p>FLEUR DE LIS Passage/ Privacy/ Dummy (Tubular or Mortise) HE484-HL144</p>  <p>Mortise: Accurate 9100 lock. Std Door Thickness: 1.75". Std Backsets: 2.5" or 2.75" Baton Tubular Latch & Privacy Bolt. Std Door Thickness: 1.75". Std Backsets: 2 3/8" or 2.75"</p>	PP-TL PR-TL PR- PMB PP-ML PR-ML FD SD	764 787 975 1,043 1,315 662 331

HARDWARE RENAISSANCE	FUNCTION	LIST PRICE \$
IRON NOTCHED CORNER COLLECTION		
HISTORICALLY INSPIRED DESIGNS. AVAILABLE WITH ANY LEVER OR KNOB		
<p>NORMANDY Thumbblatch x Lever Entry (Mortise Only) HH441 - HE601-HK751 (available with any lever or knob)</p> 	EN-ML FD	2,642 1,881
See Page 5 for choice of Mortise Lock functions. Std Door Thickness: 1.75". Std Backsets: 2.5" or 2.75"		
<p>SEVILLE Thumbblatch x Lever Entry (Mortise Only) HH442 - HE601-HK751 (available with any lever or knob)</p> 	EN-ML FD	2,642 1,881
See Page 5 for choice of Mortise Lock functions. Std Door Thickness: 1.75". Std Backsets: 2.5" or 2.75"		
<p>ORLEANS Thumbblatch x Lever Entry (Mortise Only) HH454NC - HE601N-HL138 (available with any lever or knob)</p> 	EN-ML FD	2,428 1,691
See Page 5 for choice of Mortise Lock functions. Std Door Thickness: 1.75". Std Backsets: 2.5" or 2.75"		

HARDWARE RENAISSANCE	FUNCTION	LIST PRICE \$
IRON NOTCHED CORNER COLLECTION		
<p>NORMANDY Thumblatch x Thumblatch Entry (Mortise Only) HH441-HH441</p>  <p>See Page 5 for choice of Mortise Lock functions. Std Door Thickness: 1.75". Std Backsets: 2.5" or 2.75"</p>	<p>EN-ML FD</p>	<p>3,233 2,448</p>
<p>SEVILLE Thumblatch x Thumblatch Entry (Mortise Only) HH442-HH442</p>  <p>See Page 5 for choice of Mortise Lock functions. Std Door Thickness: 1.75". Std Backsets: 2.5" or 2.75"</p>	<p>EN-ML FD</p>	<p>3,233 2,448</p>
<p>ORLEANS Thumblatch x Thumblatch Entry (Mortise Only) HH454NC-HH454NC</p>  <p>See Page 5 for choice of Mortise Lock functions. Std Door Thickness: 1.75". Std Backsets: 2.5" or 2.75"</p>	<p>EN-ML FD</p>	<p>2,999 2,198</p>

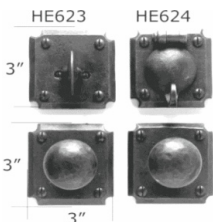
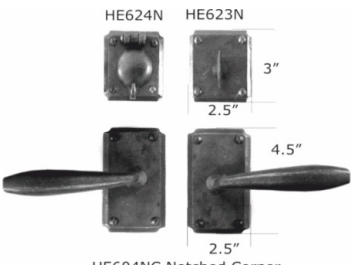
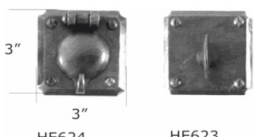
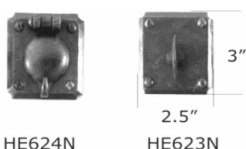
HARDWARE RENAISSANCE		FUNCTION	LIST PRICE \$
IRON NOTCHED CORNER COLLECTION			
<p>NOTCHED CORNER Lever x Lever Entry (Mortise or Tubular. Tubular is 5.5" c-to-c) HE601-HL142 (available with any lever or knob)</p>  <p>See Page 5 for choice of Mortise Lock functions. Std Door Thickness: 1.75". Std Backsets: 2.5" or 2.75" Tubular: Baton Tubular Latch & Deadbolt. Std Door Thickness: 1.75". Std Backsets 2 3/8" or 2.75"</p>	<p>EN-ML 1,618 PT-ML 1,485 EN-DB-SC 1,155 EN-DB-DC 1,220 PT-DB 1,088 FD 630</p>		
<p>NARROW NOTCHED CORNER Lever x Lever Entry (Mortise or Tubular. Tubular is 5.5" c-to-c) HE601N-HL101 (available with any lever or knob)</p>  <p>See Page 5 for choice of Mortise Lock functions. Std Door Thickness: 1.75". Std Backsets: 2.5" or 2.75" Tubular: Baton Tubular Latch & Deadbolt. Std Door Thickness: 1.75". Std Backsets 2 3/8" or 2.75"</p>	<p>EN-ML 1,618 PT-ML 1,485 EN-DB-SC 1,155 EN-DB-DC 1,220 PT-DB 1,088 FD 630</p>		
<p>NOTCHED CORNER Sectional Lever x Lever Entry (Tubular) HE602-HK751 with HE623-HE624 deadbolt (available with any lever or knob)</p>  <p>Mortise: Accurate 9503 Deadlock. Std Door Thickness: 1.75". Std Backsets: 2.5" or 2.75" Baton Tubular Latch & Deadbolt. Std Door Thickness: 1.75". Std Backsets 2 3/8" or 2.75"</p>	<p>EN-DB-SC 980 EN-DB-DC 1,060 EN-MD 1,154 PT-DB 837 FD 535</p>		

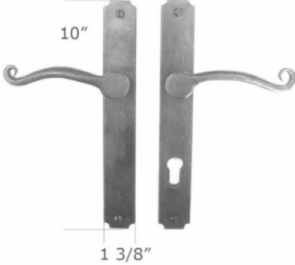
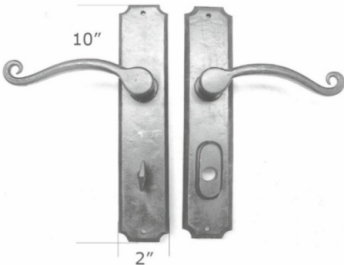
HARDWARE RENAISSANCE		FUNCTION	LIST PRICE \$
IRON NOTCHED CORNER COLLECTION			
<p>NOTCHED CORNER Sectional Lever x Lever Entry (Tubular) HE603-HK751 with HE623-HE624 deadbolt (available with any lever or knob)</p>  <p>Mortise: Accurate 9503 Deadlock. Std Door Thickness: 1.75". Std Backsets: 2.5" or 2.75" Baton Tubular Latch & Deadbolt. Std Door Thickness: 1.75". Std Backsets 2 3/8" or 2.75"</p>	<p>EN-DB-SC 884 EN-DB-DC 964 EN-MD 1,058 PT-DB 741 FD 440</p>		
<p>NOTCHED CORNER Sectional Lever x Lever Entry (Tubular) HE604NC with HE623N-HE624N deadbolt (available with any lever or knob)</p>  <p>Mortise: Accurate 9503 Deadlock. Std Door Thickness: 1.75". Std Backsets: 2.5" or 2.75" Baton Tubular Latch & Deadbolt. Std Door Thickness: 1.75". Std Backsets 2 3/8" or 2.75"</p>	<p>EN-DB-SC 884 EN-DB-DC 964 EN-MD 1,058 PT-DB 741 FD 440</p>		
<p>NOTCHED CORNER Deadbolt Only (Tubular or Mortise) HE623-HE624</p>  <p>Mortise: Accurate 9503 Deadlock. Std Door Thickness: 1.75". Std Backsets: 2.5" or 2.75" Tubular: Baton Tubular Deadbolt. Std Door Thickness: 1.75". Std Backsets 2 3/8" or 2.75"</p>	<p>EN-DB-SC 346 EN-DB-DC 426 PT-DB 203 EN-MD 520</p>		
<p>NARROW NOTCHED CORNER Deadbolt Only (Tubular or Mortise) HE623N-HE624N</p>  <p>Mortise: Accurate 9503 Deadlock. Std Door Thickness: 1.75". Std Backsets: 2.5" or 2.75" Tubular: Baton Tubular Deadbolt. Std Door Thickness: 1.75". Std Backsets 2 3/8" or 2.75"</p>	<p>EN-DB-SC 346 EN-DB-DC 426 PT-DB 203 EN-MD 520</p>		

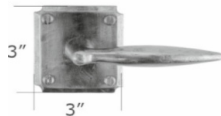
HARDWARE RENAISSANCE		FUNCTION	LIST PRICE \$
IRON NOTCHED CORNER COLLECTION			
<p>NOTCHED CORNER Multipoint Hardware</p> <p>HE605NC-HL128 (available with any lever)</p>  <p>NO SPRING ASSIST! RECOMMENDED WITH SMALLER LEVERS ONLY</p> <p>Available for most door makes (except Andersen). See Multipoint Spec Sheets for available configurations and functions Must send Multipoint order form with order</p>		EN-US CYL 794 PT-US CYL 692 EN-EURO 911 PT-EURO 862 PP 637 AD 637 FD 606	
<p>NOTCHED CORNER Multipoint Hardware</p> <p>HE606NC-HL113 (available with any lever)</p>  <p>Available for most door makes (except Andersen). See Multipoint Spec Sheets for available configurations and functions Must send Multipoint order form with order</p>		EN-US CYL 805 PT-US CYL 714 EN-EURO 922 PT-EURO 873 PP 648 AD 648 FD 617	
<p>NOTCHED CORNER Passage/ Privacy/ Dummy (Tubular)</p> <p>HE602-HP718 (available with any lever or knob)</p>  <p>PR-PMB C-TO-C is 2.75" Baton Tubular Latch. Std Door Thickness: 1.75". Std Backsets: 2 3/8" or 2.75"</p>		PP-TL 634 PR-TL 658 PR- PMB 854 FD 535 SD 267	
<p>NOTCHED CORNER Passage/ Privacy/ Dummy (Tubular)</p> <p>HE603-HL131 (available with any lever or knob)</p>  <p>Baton Tubular Latch. Std Door Thickness: 1.75". Std Backsets: 2 3/8" or 2.75"</p>		PP-TL 538 PR-TL 561 FD 441 SD 220	

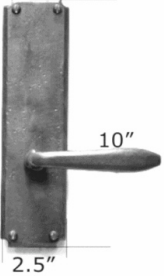
HARDWARE RENAISSANCE		FUNCTION	LIST PRICE \$
IRON NOTCHED CORNER COLLECTION			
<p>NOTCHED CORNER Passage/ Privacy/ Dummy (Tubular) HE604NC-HL138 (available with any lever or knob)</p> 	PP-TL PR-TL FD SD	538 561 441 220	
Baton Tubular Latch. Std Door Thickness: 1.75". Std Backsets: 2 3/8" or 2.75"			
<p>NOTCHED CORNER Passage/ Privacy/ Dummy (Tubular) HE601-HL142 (available with any lever or knob)</p> 	PP-TL PR-TL PR- PMB PP-ML PR-ML FD SD	736 759 945 1,014 1,271 630 315	
Mortise: Accurate 9100 lock. Std Door Thickness: 1.75". Std Backsets: 2.5" or 2.75" Baton Tubular Latch & Privacy Bolt. Std Door Thickness: 1.75". Std Backsets: 2 3/8" or 2.75"			
<p>NARROW NOTCHED CORNER Passage/ Privacy/ Dummy (Tubular) HE601N-HL138 (available with any lever or knob)</p> 	PP-TL PR-TL PR- PMB PP-ML PR-ML FD SD	736 759 945 1,014 1,271 630 315	
Mortise: Accurate 9100 lock. Std Door Thickness: 1.75". Std Backsets: 2.5" or 2.75" Baton Tubular Latch & Privacy Bolt. Std Door Thickness: 1.75". Std Backsets: 2 3/8" or 2.75"			
<p>NOTCHED CORNER Privacy Bolt (Tubular: Add to Passage Set) HE623-PMB</p> 	PMB	236	
Baton Privacy bolt. Std Door Thickness: 1.75". Std Backsets: 2 3/8" or 2.75"			
<p>NARROW NOTCHED CORNER Privacy Bolt (Tubular: Add to Passage Set) HE623N-PMB</p> 	PMB	236	
Baton Privacy bolt. Std Door Thickness: 1.75". Std Backsets: 2 3/8" or 2.75"			

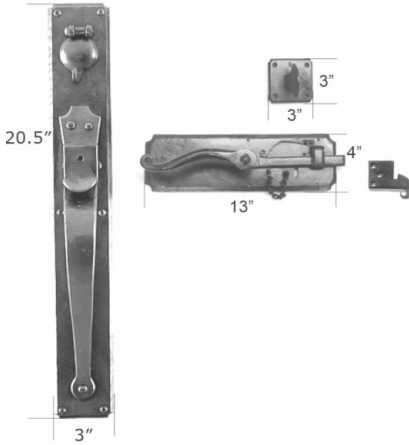
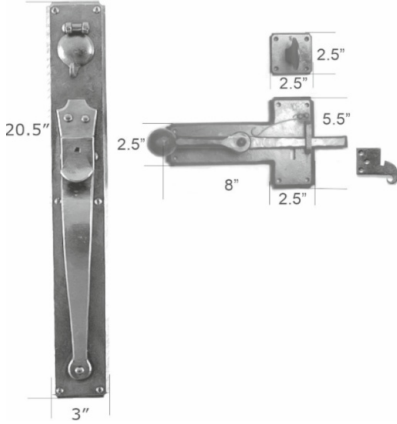
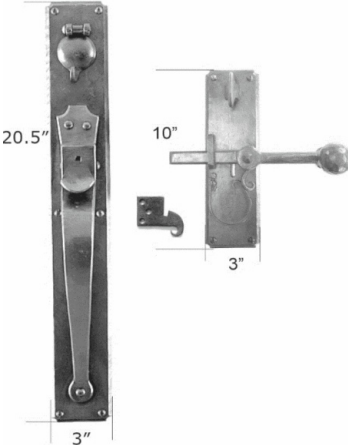

HARDWARE RENAISSANCE	FUNCTION	LIST PRICE \$
IRON STRIKE-BAR LATCHES COLLECTION		
HISTORIC STYLES IN OUR UNIQUE COLLECTION OF STRIKE-BAR LATCHES IN EVERY FUNCTION		
<p>ENTRY SETS:</p> <p>NORMANDY Thumbblatch Entry With HORIZONTAL Strike-bar Latch (Mortise Only) HH441 - HS501-HL113R (available with any lever)</p> <div data-bbox="711 363 1122 806" data-label="Image"> </div> <p>With Mortise Strike as shown</p> <p>Mortise: Accurate 9503 Deadlock. Std Door Thickness: 1.75". Std Backsets: 2.5" or 2.75"</p>	EN-MD FD	2,525 2,057
<p>NORMANDY Thumbblatch Entry With T-SHAPED Strike-bar Latch (Mortise Only) HH441 - HS502-HL111R (available with any lever)</p> <div data-bbox="701 913 1107 1346" data-label="Image"> </div> <p>With Mortise Strike as shown</p> <p>Mortise: Accurate 9503 Deadlock. Std Door Thickness: 1.75". Std Backsets: 2.5" or 2.75"</p>	EN-MD FD	2,525 2,057
<p>NORMANDY Thumbblatch Entry With VERTICAL Strike-bar Latch (Mortise Only) HH441 - HS503-HL101R (available with any lever)</p> <div data-bbox="701 1432 1057 1850" data-label="Image"> </div> <p>With Mortise Strike as shown</p> <p>Mortise: Accurate 9503 Deadlock. Std Door Thickness: 1.75". Std Backsets: 2.5" or 2.75"</p>	EN-MD FD	2,525 2,057

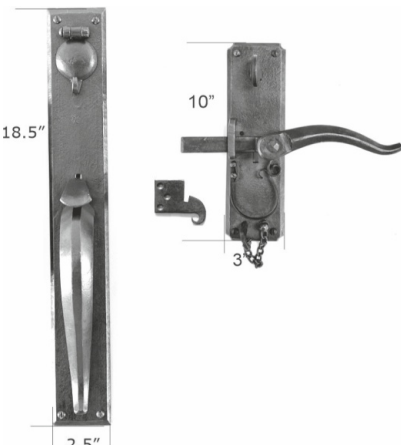
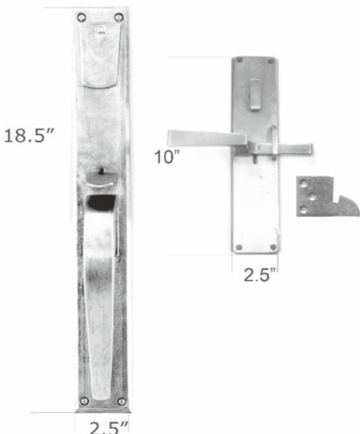
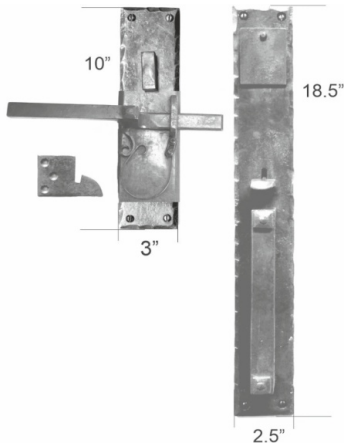
HARDWARE RENAISSANCE		FUNCTION	LIST PRICE \$
IRON STRIKE-BAR LATCHES COLLECTION			
<p>SEVILLE Thumbblatch Entry With HORIZONTAL Strike-bar Latch (Mortise Only) HH442 - HS501-HL113R (available with any lever)</p>  <p>With Mortise Strike as shown</p> <p>Mortise: Accurate 9503 Deadlock. Std Door Thickness: 1.75". Std Backsets: 2.5" or 2.75"</p>	EN-MD FD	2,525 2,057	
<p>SEVILLE Thumbblatch Entry With T-SHAPED Strike-bar Latch (Mortise Only) HH442 - HS502-HL111R (available with any lever)</p>  <p>With Mortise Strike as shown</p> <p>Mortise: Accurate 9503 Deadlock. Std Door Thickness: 1.75". Std Backsets: 2.5" or 2.75"</p>	EN-MD FD	2,525 2,057	
<p>SEVILLE Thumbblatch Entry With VERTICAL Strike-bar Latch (Mortise Only) HH442 - HS503-HL111R (available with any lever)</p>  <p>With Mortise Strike as shown</p> <p>Mortise: Accurate 9503 Deadlock. Std Door Thickness: 1.75". Std Backsets: 2.5" or 2.75"</p>	EN-MD FD	2,525 2,057	

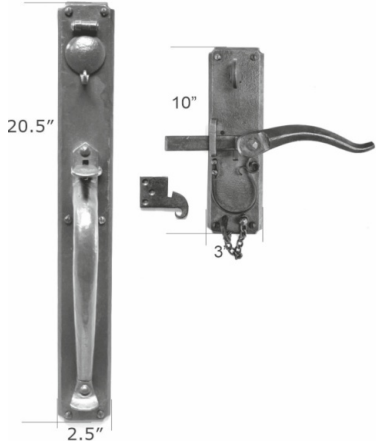
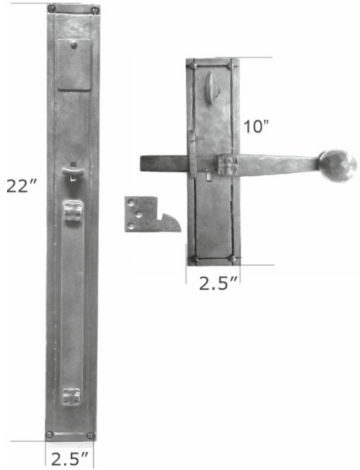
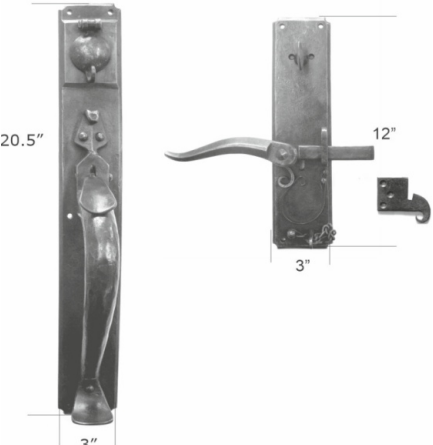
HARDWARE RENAISSANCE	FUNCTION	LIST PRICE \$
IRON STRIKE-BAR LATCHES COLLECTION		
<p>VERONA Thumblatch Entry With VERTICAL Strike-bar Latch (Mortise Only) HH443 - HS503-HL101R (available with any lever)</p> <div style="text-align: center;">  </div> <p>With Mortise Strike as shown</p> <p>Mortise: Accurate 9503 Deadlock. Std Door Thickness: 1.75". Std Backsets: 2.5" or 2.75"</p>	EN-MD FD	2,302 1,850
<p>MANHATTAN Thumblatch Entry With MANHATTAN Strike-bar Latch (Mortise Only) HH444 - HS506-HL132</p> <div style="text-align: center;">  </div> <p>With Mortise Strike as shown</p> <p>Mortise: Accurate 9503 Deadlock. Std Door Thickness: 1.75". Std Backsets: 2.5" or 2.75"</p>	EN-MD FD	2,302 1,850
<p>CODY Thumblatch Entry With CODY Strike-bar Latch (Mortise Only) HH453 - HS513</p> <div style="text-align: center;">  </div> <p>With Mortise Strike as shown</p> <p>Mortise: Accurate 9503 Deadlock. Std Door Thickness: 1.75". Std Backsets: 2.5" or 2.75"</p>	EN-MD FD	2,302 1,850

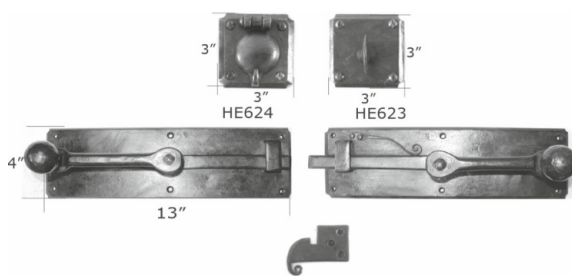
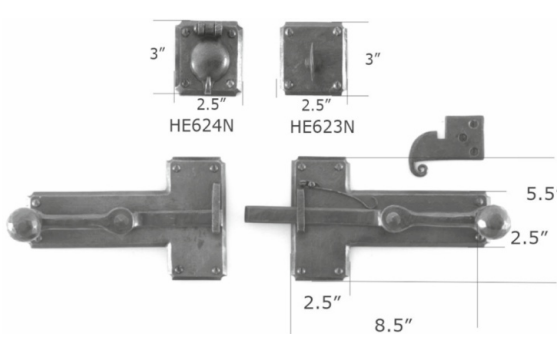
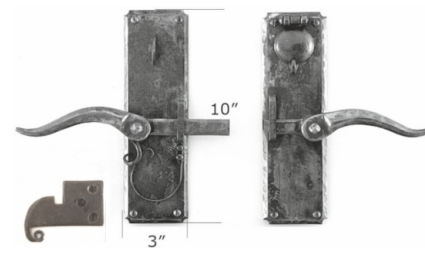
HARDWARE RENAISSANCE		FUNCTION	LIST PRICE \$
IRON STRIKE-BAR LATCHES COLLECTION			
<p>ORLEANS Thumblatch Entry With VERTICAL Strike-bar Latch (Mortise Only) HH454NC - HS503-HL101R (available with any lever)</p>  <p>With Mortise Strike as shown</p> <p>Mortise: Accurate 9503 Deadlock. Std Door Thickness: 1.75". Std Backsets: 2.5" or 2.75"</p>	EN-MD FD	2,525 2,057	
<p>SIERRA Thumblatch Entry With SIERRA Strike-bar Latch (Mortise Only) HH456 - HS514</p>  <p>With Mortise Strike as shown</p> <p>Mortise: Accurate 9503 Deadlock. Std Door Thickness: 1.75". Std Backsets: 2.5" or 2.75"</p>	EN-MD FD	2,525 2,057	
<p>NORMANDY Thumblatch Entry With VERTICAL Strike-bar Latch (TUBULAR VERSION) HH441 - HS503-HL101R (available with any lever)</p> <p>NOTE: THIS IS THE ONLY ENTRY THAT WORKS WITH TUBULAR SET UP. IF YOU HAVE PRE-BORED DOORS WITH 5.5" C-TO-C, WE CAN ALSO MAKE A CUSTOM LONGER STRIKE, PLUS A CUSTOM COVER PLATE TO COVER THE DOOR PREP. ASK US FOR DETAILS!</p>  <p>With Mortise Strike as shown</p> <p>Tubular: Baton Tubular Deadbolt. Std Door Thickness: 1.75". Std Backsets 2 3/8" or 2.75"</p>	EN-DB FD	2,511 2,057	

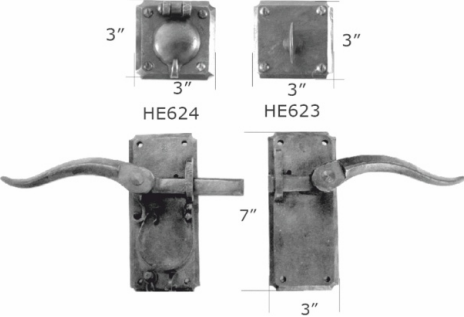
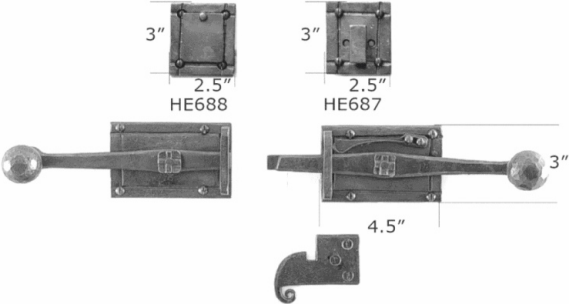
HARDWARE RENAISSANCE		FUNCTION	LIST PRICE \$
IRON STRIKE-BAR LATCHES COLLECTION			
<p>These unique sets are available with tubular deadbolt (DB) or heavier duty Mortise Deadlock (MD). With mortise strike as shown. Contact us for surface strike or other custom strike requirements.</p> <p>THESE SETS ARE HANDED, and handing is not reversible in the field or the factory</p> <p>HORIZONTAL Strike-bar Latch Entry HS501-HL111R (Mortise or Tubular) With HE623-HE624 Deadbolt (available with any lever)</p>  <p>Mortise: Accurate 9503 Deadlock. Std Door Thickness: 1.75". Std Backsets: 2.5" or 2.75" Tubular: Baton Tubular Deadbolt. Std Door Thickness: 1.75". Std Backsets 2 3/8" or 2.75"</p>		EN-MD EN-DB-SC EN-DB-DC PT-DB FD SD	1,316 1,142 1,222 999 728 364
<p>T-SHAPED Strike-bar Latch Entry HS502-HL111R (Mortise or Tubular) With HE623N-HE624N Deadbolt (available with any lever)</p>  <p>Mortise: Accurate 9503 Deadlock. Std Door Thickness: 1.75". Std Backsets: 2.5" or 2.75" Tubular: Baton Tubular Deadbolt. Std Door Thickness: 1.75". Std Backsets 2 3/8" or 2.75"</p>		EN-MD EN-DB-SC EN-DB-DC PT-DB FD SD	1,261 1,087 1,166 944 690 345
<p>VERTICAL Strike-bar Latch Entry HS503-HL101R (Mortise or Tubular) (available with any lever)</p>  <p>Mortise: Accurate 9503 Deadlock. Std Door Thickness: 1.75". Std Backsets: 2.5" or 2.75" Tubular: Baton Tubular Deadbolt. Std Door Thickness: 1.75". Std Backsets 2 3/8" or 2.75"</p>		EN-MD EN-DB-SC EN-DB-DC PT-DB FD SD	1,367 1,188 1,248 1,041 728 364

HARDWARE RENAISSANCE		FUNCTION	LIST PRICE \$
IRON STRIKE-BAR LATCHES COLLECTION			
<p>VERTICAL SECTIONAL Strike-bar Latch Entry HS503S-HL101R (Mortise or Tubular) With HE623-HE624 Deadbolt (available with any lever)</p>  <p>Mortise: Accurate 9503 Deadlock. Std Door Thickness: 1.75". Std Backsets: 2.5" or 2.75" Tubular: Baton Tubular Deadbolt. Std Door Thickness: 1.75". Std Backsets 2 3/8" or 2.75"</p>	EN-MD EN-DB-SC EN-DB-DC PT-DB FD SD	1,261 1,087 1,166 944 690 345	
<p>TWEEZER Strike-bar Latch Entry HS504 (Mortise or Tubular) With HE687-HE688 Deadbolt (no lever options - available as shown only)</p>  <p>Mortise: Accurate 9503 Deadlock. Std Door Thickness: 1.75". Std Backsets: 2.5" or 2.75" Tubular: Baton Tubular Deadbolt. Std Door Thickness: 1.75". Std Backsets 2 3/8" or 2.75"</p>	EN-MD EN-DB-SC EN-DB-DC PT-DB FD SD	1,261 1,087 1,166 944 690 345	
<p>STOKER Strike-bar Latch Entry HS505 (Mortise or Tubular) With HE635-HE636 Deadbolt (no lever options - available as shown only)</p>  <p>Mortise: Accurate 9503 Deadlock. Std Door Thickness: 1.75". Std Backsets: 2.5" or 2.75" Tubular: Baton Tubular Deadbolt. Std Door Thickness: 1.75". Std Backsets 2 3/8" or 2.75"</p>	EN-MD EN-DB-SC EN-DB-DC PT-DB FD SD	1,316 1,142 1,222 999 728 364	

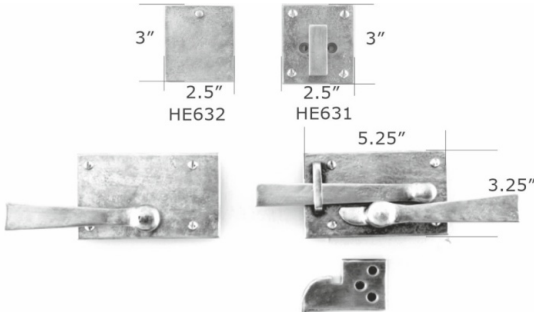
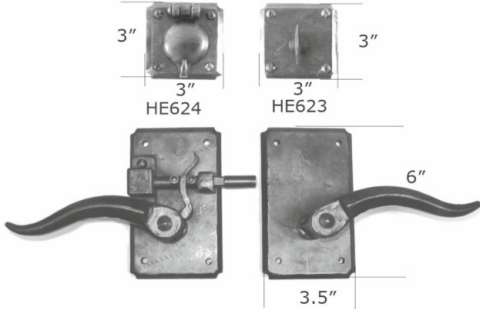
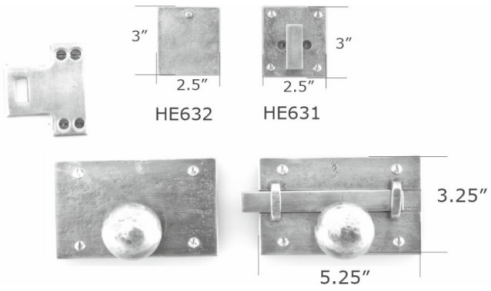
HARDWARE RENAISSANCE		FUNCTION	LIST PRICE \$
IRON STRIKE-BAR LATCHES COLLECTION			
<p>BERMUDA Strike-bar Latch Entry HS507 (Mortise or Tubular) With HE631-HE632 Deadbolt (no lever options - available as shown only)</p>  <p>Mortise: Accurate 9503 Deadlock. Std Door Thickness: 1.75". Std Backsets: 2.5" or 2.75" Tubular: Baton Tubular Deadbolt. Std Door Thickness: 1.75". Std Backsets 2 3/8" or 2.75"</p>	EN-MD EN-DB-SC EN-DB-DC PT-DB FD SD	1,261 1,087 1,166 944 690 345	
<p>SANTA BARBARA Strike-bar Latch Entry HS508-HL101R (Mortise or Tubular) With HE623-HE624 Deadbolt (available with any lever)</p>  <p>Mortise: Accurate 9503 Deadlock. Std Door Thickness: 1.75". Std Backsets: 2.5" or 2.75" Tubular: Baton Tubular Deadbolt. Std Door Thickness: 1.75". Std Backsets 2 3/8" or 2.75"</p>	EN-MD EN-DB-SC EN-DB-DC PT-DB FD SD	1,261 1,087 1,166 944 690 345	
<p>SCOTTSDALE Strike-bar Latch Entry HS509 (Mortise or Tubular) With HE631-HE632 Deadbolt (no lever options - available as shown with Mushroom knob only)</p>  <p>Mortise: Accurate 9503 Deadlock. Std Door Thickness: 1.75". Std Backsets: 2.5" or 2.75" Tubular: Baton Tubular Deadbolt. Std Door Thickness: 1.75". Std Backsets 2 3/8" or 2.75"</p>	EN-MD EN-DB-SC EN-DB-DC PT-DB FD SD	1,261 1,087 1,166 944 690 345	

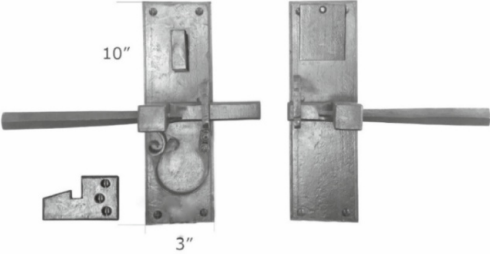
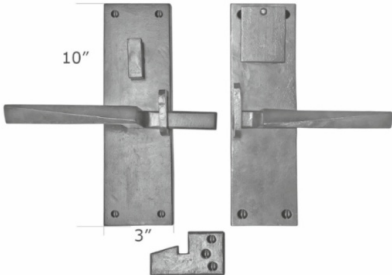
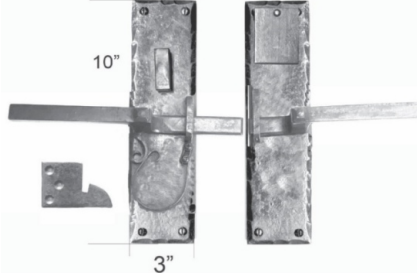
HARDWARE RENAISSANCE		FUNCTION	LIST PRICE \$
IRON STRIKE-BAR LATCHES COLLECTION			
<p>EAST-WEST Strike-bar Latch Entry HS511 (Mortise or Tubular) (no lever options - available as shown only)</p>  <p>Mortise: Accurate 9503 Deadlock. Std Door Thickness: 1.75". Std Backsets: 2.5" or 2.75" Tubular: Baton Tubular Deadbolt. Std Door Thickness: 1.75". Std Backsets 2 3/8" or 2.75"</p>	<p>EN-MD EN-DB-SC EN-DB-DC PT-DB FD SD</p>	<p>1,367 1,188 1,248 1,041 728 364</p>	
<p>MILAN Strike-bar Latch Entry HS512 (Mortise or Tubular) (no lever options - available as shown only)</p>  <p>Mortise: Accurate 9503 Deadlock. Std Door Thickness: 1.75". Std Backsets: 2.5" or 2.75" Tubular: Baton Tubular Deadbolt. Std Door Thickness: 1.75". Std Backsets 2 3/8" or 2.75"</p>	<p>EN-MD EN-DB-SC EN-DB-DC PT-DB FD SD</p>	<p>1,367 1,188 1,248 1,041 728 364</p>	
<p>CODY Strike-bar Latch Entry HS513 (Mortise or Tubular) (no lever options - available as shown only)</p>  <p>Mortise: Accurate 9503 Deadlock. Std Door Thickness: 1.75". Std Backsets: 2.5" or 2.75" Tubular: Baton Tubular Deadbolt. Std Door Thickness: 1.75". Std Backsets 2 3/8" or 2.75"</p>	<p>EN-MD EN-DB-SC EN-DB-DC PT-DB FD SD</p>	<p>1,367 1,188 1,248 1,041 728 364</p>	

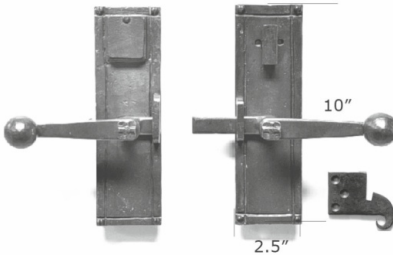
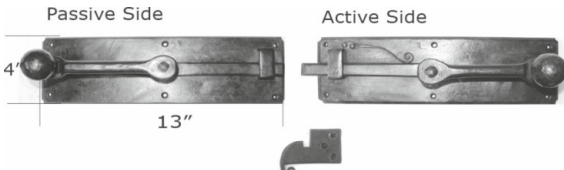
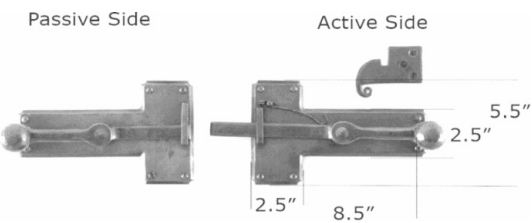
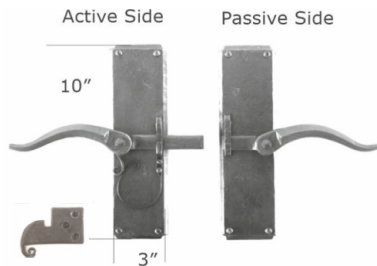
HARDWARE RENAISSANCE		FUNCTION	LIST PRICE \$
IRON STRIKE-BAR LATCHES COLLECTION			
<p>SIERRA Strike-bar Latch Entry HS514 (Mortise or Tubular) (no lever options - available as shown only)</p>  <p>Mortise: Accurate 9503 Deadlock. Std Door Thickness: 1.75". Std Backsets: 2.5" or 2.75" Tubular: Baton Tubular Deadbolt. Std Door Thickness: 1.75". Std Backsets 2 3/8" or 2.75"</p>	EN-MD EN-DB-SC EN-DB-DC PT-DB FD SD	1,367 1,188 1,248 1,041 728 364	
INTERIOR PASSAGE/ PRIVACY/ DUMMY SETS			
Privacy is with locking pin + chain. There are no components. With mortise strike as shown. Contact us for surface strike or other custom strike requirements. THESE SETS ARE HANDED, and handing is not reversible in the field or the factory			
<p>HORIZONTAL Strike-bar Latch HS501-HL111R (available with any lever)</p> 	PP PR FD SD	796 829 728 364	
<p>T-SHAPED Strike-bar Latch HS502-HL111R (available with any lever)</p> 	PP PR FD SD	741 774 690 345	
<p>VERTICAL Strike-bar Latch HS503-HL101R (available with any lever)</p> 	PP PR FD SD	759 792 728 364	



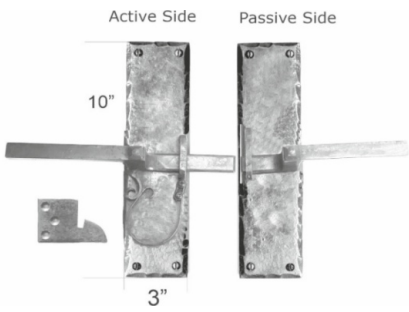
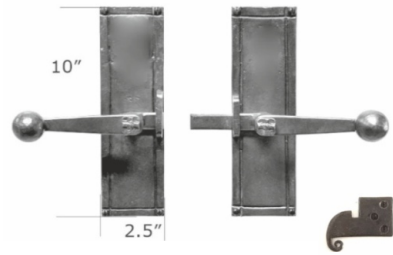
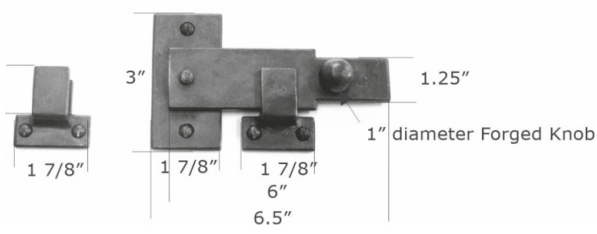

HARDWARE RENAISSANCE		FUNCTION	LIST PRICE \$
IRON STRIKE-BAR LATCHES COLLECTION			
VERTICAL Strike-bar Latch HS503S-HL111R (available with any lever)		PP PR FD SD	741 774 690 345
TWEEZER Strike-bar Latch HS504 (no lever options - available as shown only)		PP PR FD SD	741 774 690 345
STOKER Strike-bar Latch HS505 (no lever options - available as shown only)		PP PR FD SD	796 829 728 364
BERMUDA Strike-bar Latch HS507 (no lever options - available as shown only)		PP PR FD SD	741 774 690 345
SANTA BARBARA Strike-bar Latch HS508-HL101R (available with any lever)		PP PR FD SD	741 774 690 345

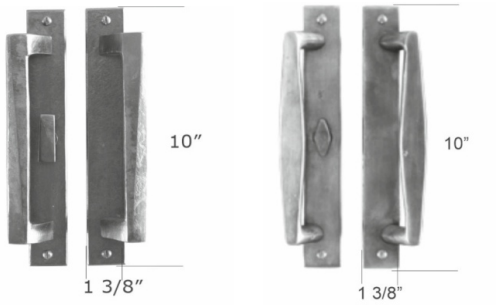
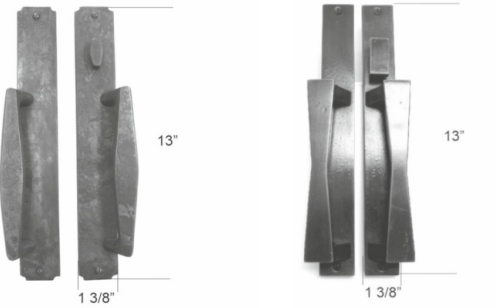
HARDWARE RENAISSANCE		FUNCTION	LIST PRICE \$
IRON STRIKE-BAR LATCHES COLLECTION			
<p>SCOTTSDALE Strike-bar Latch HS509 (no lever options - available as shown with Mushroom knob only)</p>		PP PR FD SD	741 774 690 345
<p>PETITE Strike-bar Latch HS510 (no lever options - available as shown only)</p>		PP PR FD SD	573 606 536 268
<p>EAST-WEST Strike-bar Latch HS511 (no lever options - available as shown only) Privacy shown (w/ chain)</p>		PP PR FD SD	759 792 728 364
<p>MILAN Strike-bar Latch HS512 (no lever options - available as shown only)</p>		PP PR FD SD	759 792 728 364

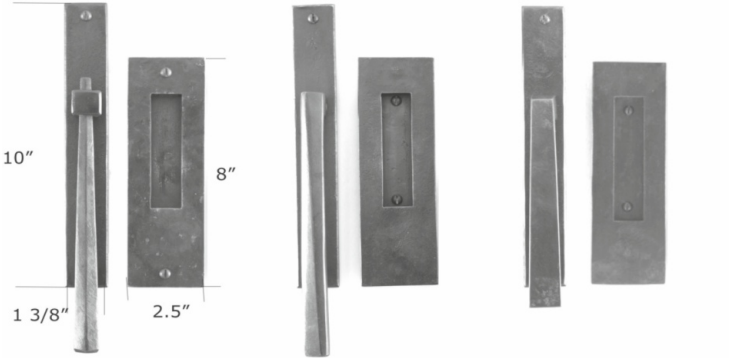
HARDWARE RENAISSANCE		FUNCTION	LIST PRICE \$
IRON STRIKE-BAR LATCHES COLLECTION			
<p>CODY Strike-bar Latch HS513 (no lever options - available as shown only)</p> 	PP PR FD SD	759 792 728 364	
<p>SIERRA Strike-bar Latch HS514 (no lever options - available as shown only)</p> 	PP PR FD SD	759 792 728 364	
<p>BARN Door Latch HS522 (One sided)</p> 	PP	496	

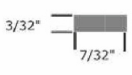
HARDWARE RENAISSANCE		FUNCTION	LIST PRICE \$
IRON SLIDING DOOR HARDWARE			
STANDARD SLIDING DOOR			
Available for most door makes. See Sliding door order form on Page 67 for required information NOTE: <u>WE DO NOT MATCH existing screw hole locations</u> - our default set up is to miss them. Thru-bolts will be provided.			
AVAILABLE WITH THE FOLLOWING GRIPS: HP444 Manhattan HP656 Milan HP657 El Secreto			
SLIDING DOOR:			
HE605	1 3/8" x 10" Straight Edge	PT FD	790 736
HE605B	1 3/8" x 10" Beveled		
HE605NC	1 3/8" x 10" Notched Corner		
 <p>HE605 Escutcheon Patio set shown w/ HP656 Grip HE605 Escutcheon Patio set shown w/ HP657 Grip</p>			
HE605L	1 3/8" x 13" Straight Edge	EN-US PT FD	924 802 750
HR605L-B	1 3/8" x 13" Beveled		
HE605L-NC	1 3/8" x 13" Notched Corner		
 <p>HE605L-NC Escutcheon Patio set shown w/ HP657 Grip HE605L Escutcheon Patio set shown w/ HP444 Grip</p>			

HARDWARE RENAISSANCE		FUNCTION	LIST PRICE \$
IRON SLIDING DOOR HARDWARE			
<p>MULTIPOINT SLIDING DOOR:</p> <p>Available for most door makes. Existing door prep information is required. NOTE: <u>WE DO NOT MATCH existing screw hole locations</u> - our default set up is to miss them. Thru-bolts will be provided.</p> <p>AVAILABLE WITH MOST OFFSET LEVERS: CALL FOR DETAILS</p>			
<p>HE605L 1 3/8" x 13" Straight Edge HR605L-B 1 3/8" x 13" Beveled HE605L-NC 1 3/8" x 13" Notched Corner</p>		<p>EN-US CYL 888 PT-US CYL 770 EN-EURO 999 PT-EURO 952 FD 726</p>	
<p>LIFT & SLIDE DOOR:</p> <p>Lift and Slide sets are typically a long lever on the inside, and a flush pull on the outside. The locking is inside the door mechanism. Standard spindle (hub) is 10mm square.</p> <p>AVAILABLE WITH THE FOLLOWING LONG LEVERS: HL105L East-West HL109L Milan HL132L Manhattan</p>			
<p>HE605 1 3/8" x 10" Straight Edge Escutcheon HP712 Flush Pull</p>		<p>PP</p>	<p>714</p>

- PURCHASE ORDER # _____
- 1 Manufacturer _____
- 2 Function _____
- 3 Door Thickness _____
- 4 Handing _____ (OX, XO, OR looking from the outside, the direction to which the door slides)
- 5 Type of Spindle for turnpiece
 (Circle one or send sketch if different)
- 

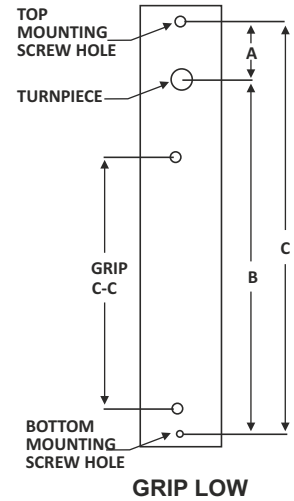

- 6 Hardware projection limitations (i.e. for screen door)?
- 7 Type of set-up and screw spacing (mark below OR supply drawing if different)

GRIP LOW

MAKE	DIM A	DIM B	DIM C
HOPPE	1-3/4" (1.772")	7-3/8" (7.362")	9-1/8" (9.134")
JELDWEN (A)	1-3/16" (1.818")	5-7/16" (5.427")	7-1/4" (7.245")
JELDWEN (B)	1-15/16" (1.945")	8-5/16" (8.300")	10-1/4" (10.245")
KOLBE	1-31/32" (1.969")	8-9/32" (8.277")	10-1/4" (10.245")
MARVIN	1-9/16" (1.584")	9-5/8" (9.643")	11-1/4" (11.227")
MARVIN INTEGRITY	1-15/16" (1.945")	9-31/32" (9.975")	11-15/16" (11.920")
PELLA	23/32" (.700")	7-5/16" (7.300")	8.000"
ANDERSEN	1-15/16" (1.950")	9-13/16" (9.800")	11-3/4" (11.75")
SIERRA PACIFIC	1-3/4" (1.771")	7-3/8" (7.361")	9-1/8" (9.132")
WINDSOR	1-31/32" (1.969")	9-15/16" (9.951")	11-15/16" (11.920")
OTHER			

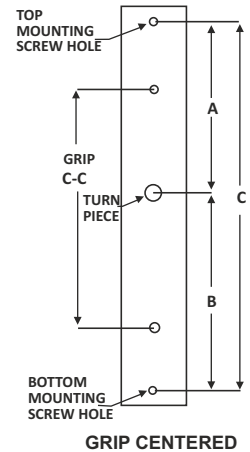
GRIP CENTERED

MAKE	DIM A	DIM B	DIM C
JELDWEN (A)	2-23/32" (2.718")	1-1/4" (1.219")	3-15/16" (3.937")
EAGLE	1-1/4" (1.219")	2-23/32" (2.718")	3-15/16" (3.937")
MARVIN	4-15/16" (4.938")	4-15/16" (4.938")	9-7/8" (9.875")
MARVIN	1-15/16" (1.945")	1-15/16" (1.945")	3-31/32" (3.980")
OTHER			







NOTE: WE DO NOT MATCH EXISTING SCREWHOLES. OUR BACKPLATES WILL MISS THEM.
 WE PROVIDE THRU-BOLTS FOR INSTALL.

SLIDING DOOR RETROFIT TRIM IS NON-RETURNABLE

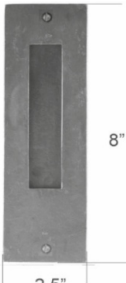
Signature _____

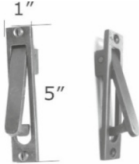
Date _____

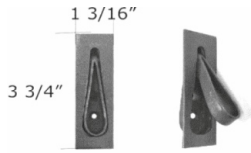
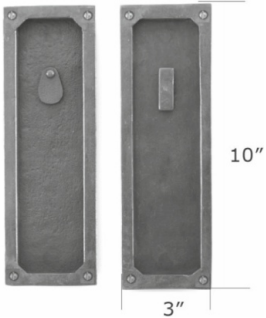
HARDWARE RENAISSANCE	FUNCTION	LIST PRICE \$
IRON POCKET DOOR HARDWARE		
HP711 Flush Pull <div style="text-align: center;">  </div>		207
HP712 Flush Pull <div style="text-align: center;">  </div>		194
HP713 Flush Pull <div style="text-align: center;">  </div>		207
HP714 Flush Pull <div style="text-align: center;">  </div>		114
HP710 Edge Pull <div style="text-align: center;">  </div>		100

HARDWARE RENAISSANCE		FUNCTION	LIST PRICE \$
IRON POCKET DOOR HARDWARE			
HP804 Tear Drop Edge Pull			163
			
HP711 Pocket Door Privacy & Keyed Sets			
HP711-PR 3" x 10" Pocket Mortise Privacy Set HP711-EN 3" x 10" Pocket Mortise Entry Set HP711-FD 3" x 10" Pocket Door Full Dummy (w/ pocket mortise strike/pull for double pocket/ sliding doors)		PR EN FD	1,005 1,039 805
HP711-PR-PDL 3" x 10" Pocket Privacy Set (w/161PDL lock + 161PDP edge pull) (Tubular Option)		PR	809
Accurate 2002 Pocket Mortise lock. Std Door Thickness: 1.75". Std Backsets: 2.5" or 2.75" Accurate 161PDL lock. Std Backsets 2 3/8" or 2.75"			
HP712 Pocket Door Privacy & Keyed Sets			
HP712-PR 2.5" x 8" Pocket Mortise Privacy Set HP712-EN 2.5" x 8" Pocket Mortise Entry Set HP712-FD 2.5" x 8" Pocket Door Full Dummy (w/ pocket mortise strike/pull for double pocket/ sliding doors)		PR EN FD	990 1,023 796
HP712-PR-PDL 2.5" x 8" Pocket Privacy Set (w/161PDL lock + 161PDP edge pull) (Tubular Option)		PR	793
Accurate 2002 Pocket Mortise lock. Std Door Thickness: 1.75". Std Backsets: 2.5" or 2.75" Accurate 161PDL lock. Std Backsets 2 3/8" or 2.75"			

HARDWARE RENAISSANCE		FUNCTION	LIST PRICE \$
IRON DOOR & APPLIANCE PULLS			
<p>Pulls are either thru-bolted or surface mounted with screws (depending upon the design) by default. Available for back-to-back or (hidden) front-mounting. Specify and provide door thickness.</p>			
HP113L	25" Scrolled Pull		659
HP441	15" Normandy Pull		531
HP442	14.5" Seville Pull		531
HP484	Fleur de Lis Pull		472

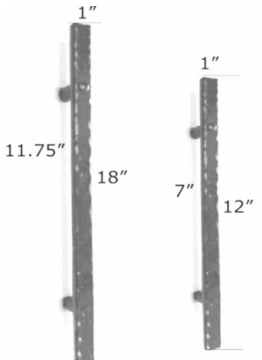
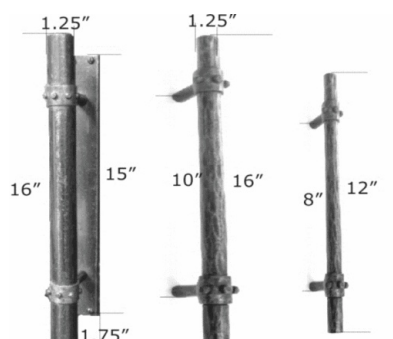
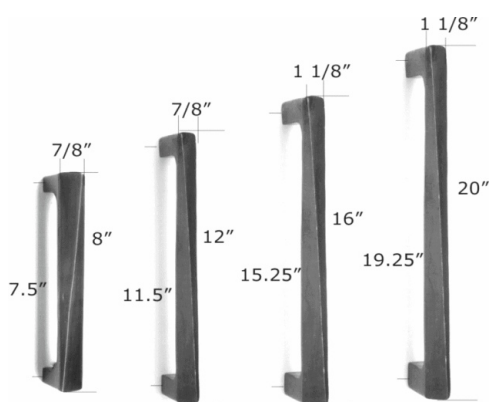

HARDWARE RENAISSANCE		FUNCTION	LIST PRICE \$
IRON DOOR & APPLIANCE PULLS			
<p>HP701S 8" Fishtail Pull HP701 16" Fishtail Pull HP701L 21" Fishtail Pull</p>	<p style="text-align: center;">HP701L HP701 HP701S</p>		<p>260 487 593</p>
<p>HP702-ESC 16" Rope Pull w/ 18" Escutcheon HP702 16" Rope Pull HP703 9" Rope Pull</p>	<p style="text-align: center;">HP702-ESC HP702 HP703</p>		<p>657 457 209</p>
<p>HP705S 6" East-West Pull HP705 12" East-West Pull</p>	<p style="text-align: center;">HP705 HP705S</p>		<p>260 474</p>

HARDWARE RENAISSANCE		FUNCTION	LIST PRICE \$
IRON DOOR & APPLIANCE PULLS			
<p>HP706S 8" Trio Pull HP706 14" Trio Pull HP706-ESC 14" Trio Pull w/ 13" Escutcheon</p> <p>COPPER wire and bands standard for all patinas Specify for IRON wire and bands</p>	<p style="text-align: center;">HP706-ESC HP706 HP706S</p>	<p>5" c-to-c 10" c-to-c</p>	<p>209 386 502</p>
<p>HP707 12.25" El Secreto Pull HP707L 20" El Secreto Pull</p>	<p style="text-align: center;">HP707L HP707 El Secreto (2.5" projection)</p>		<p>474 593</p>
<p>HP707S-AP-8 8" El Secreto Appliance Pull HP707S-AP-12 12" El Secreto Appliance Pull HP707S-AP-16 16" El Secreto Appliance Pull</p>	<p style="text-align: center;">HP707S-AP-8 HP707S-AP-12 HP707S-AP-16</p>	<p>7.5" c-to-c 11.5" c-to-c 15.5" c-to-c</p>	<p>209 295 351</p>

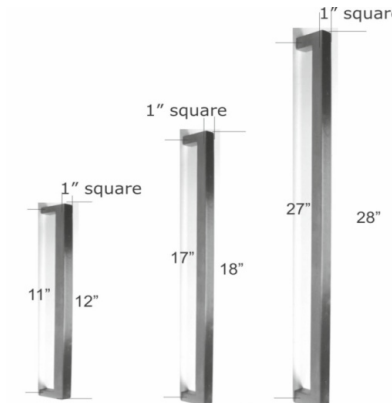
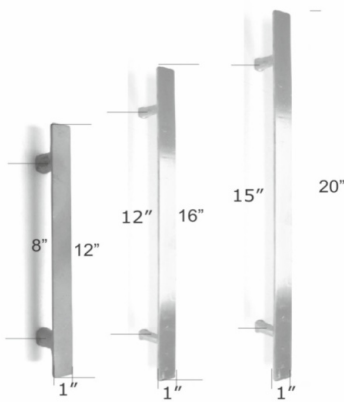
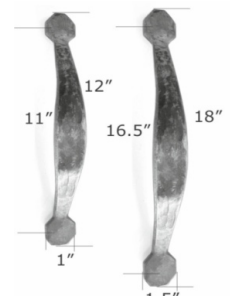
HARDWARE RENAISSANCE		FUNCTION	LIST PRICE \$
IRON DOOR & APPLIANCE PULLS			
<p>HP708AP-12 12" Rectangular Appliance Pull HP708AP-18 18" Rectangular Appliance Pull</p>  <p style="text-align: center;">HP708AP-18 HP708AP-12</p>	<p>7" c-to-c 11.75" c-to-c</p>	<p>319 462</p>	
<p>HP709-12 12" Galisteo Pull HP709 16" Galisteo Pull HP709-ESC 16" Galisteo Pull w/ 15" Escutcheon</p> <p>COPPER bands standard for all patinas Specify for IRON bands</p>  <p style="text-align: center;">HP709-ESC HP709 HP709-12</p>	<p>8" c-to-c 10" c-to-c N/A</p>	<p>336 548 658</p>	
<p>HP725-8 8" Milan Pull HP725-12 12" Milan Pull HP725-16 16" Milan Pull HP725-20 20" Milan Pull</p>  <p style="text-align: center;">HP725-8 HP725-12 HP725-16 HP725-20</p>	<p>7.5" c-to-c 11.5" c-to-c 15.25" c-to-c 19.25" c-to-c</p>	<p>245 336 476 572</p>	

HARDWARE RENAISSANCE		FUNCTION	LIST PRICE \$
IRON DOOR & APPLIANCE PULLS			
<p>HP726AP-12 12" Stockholm Pull HP726AP-18 18" Stockholm Pull HP726AP-28 28" Stockholm Pull</p>  <p style="text-align: center;">HP726AP-12 HP726AP-18 HP726AP-28</p>		<p>11" c-to-c 17" c-to-c 27" c-to-c</p>	<p>226 357 572</p>
<p>HP754AP-12 12" Scottsdale Pull HP754AP-16 16" Scottsdale Pull HP754AP-20 20" Scottsdale Pull</p>  <p style="text-align: center;">HP754L-AP-12 HP754L-AP-16 HP754L-AP-20</p>		<p>8" c-to-c 12" c-to-c 15" c-to-c</p>	<p>295 351 494</p>
<p>HP767AP-12 12" Hampton Pull HP767AP-18 18" Hampton Pull</p>  <p style="text-align: center;">HP767AP-12 HP767AP-18</p>		<p>11" c-to-c 16.5" c-to-c</p>	<p>271 402</p>

HARDWARE RENAISSANCE		FUNCTION	LIST PRICE \$
IRON DOOR & APPLIANCE PULLS			
HP768AP-12 12" Casa California Pull HP768AP-18 18" Casa California Pull		12" c-to-c 18" c-to-c	295 402
HP772AP-12 12" Prescott Pull HP772AP-18 18" Prescott Pull		10 7/8" c-to-c 16 7/8" c-to-c	295 402
HP773AP-12 13" Arc Pull HP773AP-16 17" Arc Pull		12" c-to-c 16" c-to-c	271 351

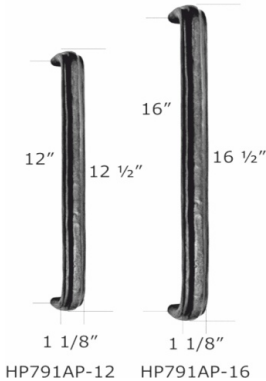
HARDWARE RENAISSANCE		FUNCTION	LIST PRICE \$
IRON DOOR & APPLIANCE PULLS			
HP783	19" Balboa Pull		538
HP785	20" Avila Pull		16" c-to-c 591
HP791AP-12 HP791AP-16	12.5" Monte Vista Pull 16.5" Monte Vista Pull		12" c-to-c 16" c-to-c 295 351

HARDWARE RENAISSANCE		FUNCTION	LIST PRICE \$
IRON DOOR & APPLIANCE PULLS			
HP793AP-12 12.5" Cody Pull HP793AP-16 16.5" Cody Pull		12" c-to-c 16" c-to-c	295 351
HP795AP-12 12.75" Avila Pull HP795AP-16 16.75" Avila Pull		12" c-to-c 16" c-to-c	329 402
HP797AP-12 12.5" Sierra Pull HP797AP-16 16.5" Sierra Pull		12" c-to-c 16" c-to-c	295 351

HARDWARE RENAISSANCE		FUNCTION	LIST PRICE \$
----------------------	--	----------	---------------

IRON DOOR & APPLIANCE PULLS

- HP798AP-12** 13" Dixon Pull
- HP798AP-16** 17" Dixon Pull
- HP798AP-23** 24" Dixon Pull

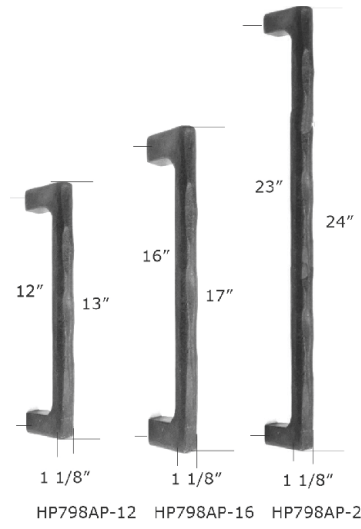

12" c-to-c	295
16" c-to-c	351
23" c-to-c	487

IRON PUSH PLATES

IRON PUSH PLATES:

Any escutcheon can be made into a push plate. Contact us for pricing.



- HE700** 2.5" x 10" Straight Edge
- HE700B** 2.5" x 10" Beveled
- HE700NC** 2.5" x 10" Notched Corner

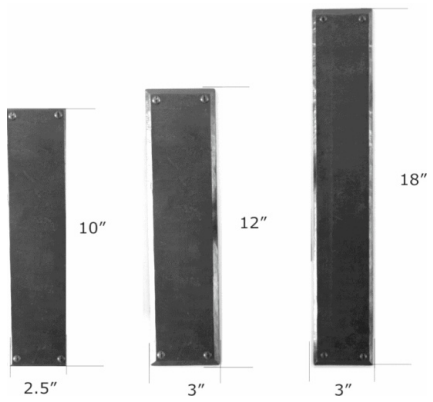

- HE701** 3" x 12" Straight Edge
- HE701B** 3" x 12" Beveled
- HE701NC** 3" x 12" Notched Corner

- HE702** 3" x 18" Straight Edge
- HE702B** 3" x 18" Beveled
- HE702NC** 3" x 18" Notched Corner

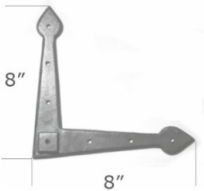
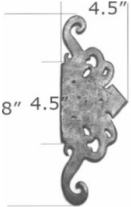

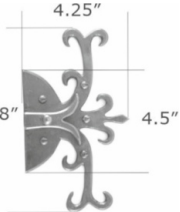

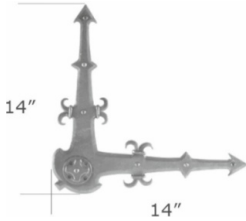
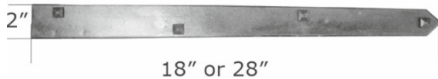
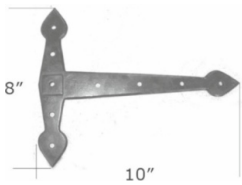
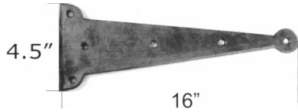

HE700	179
HE700B	179
HE700NC	179
HE701	207
HE701B	207
HE701NC	207
HE702	280
HE702B	280
HE702NC	280

HARDWARE RENAISSANCE			FUNCTION	LIST PRICE \$
IRON ACCESSORIES				
IRON STRAPS & BRACES				
HB351	8" Single Arm Brace			82
HB355	8" Corner Brace			130
HB356	8" Scrolled Strap			251
HB357	Arrow-head Strap			333
HB358	8" Chateau Strap			333

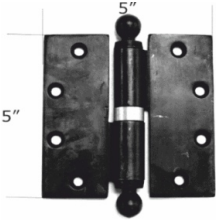
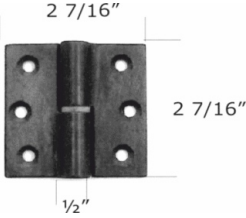
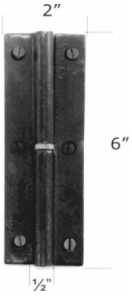
HARDWARE RENAISSANCE		FUNCTION	LIST PRICE \$
IRON ACCESSORIES			
IRON STRAPS & BRACES			
HB358L	22" Chateau Long Strap		384
HB359	14" Pistoria Corner Brace		401
HB365-18 HB365-28	18" Straight Strap 28" Straight Strap		260 395
HB367	8" T-Brace		185
HB361-D	16" Dummy Strap		271
HB363-D	28" Dummy Strap		425

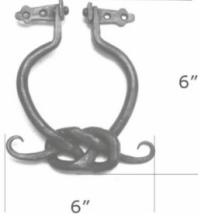
HARDWARE RENAISSANCE		FUNCTION	LIST PRICE \$
IRON ACCESSORIES			
IRON STRAP HINGES		Specify if hinges are going to be installed half mortise or full flat surface	
HB361	16" Hinge Strap		437
HB363	28" Hinge Strap		602
HB369	4" Fleur de Lis Hinge Strap		417
HB371	33" Pintle Hinge Strap	Specify Handing 	644
HB372	30" Bud Tip Pintle Hinge Strap	Specify Handing 	622
HB451 HB452 HB453	12" Bean Strap Hinge 18" Bean Strap Hinge 21" Bean Strap Hinge		439 507 549

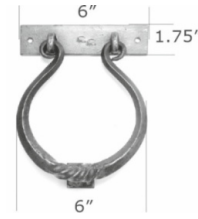
HARDWARE RENAISSANCE		FUNCTION	LIST PRICE \$
IRON ACCESSORIES			
IRON HEAVY DUTY PINTLE (GRAVITY) HINGES			
SPECIFY FINIAL: BALL or FLAT CAP			
THESE HINGES ARE HANDED - MUST SPECIFY HANDING			
HN404 6" x 6" HN405 5" x 5" HN406 4.5" x 4" HN408 4.5" x 4.5"			257 204 190 190
3/16" leaf thickness 7/8" barrel diameter			
CABINET HINGES:			
HNC110 2 7/16" x 2 7/16" Cabinet Pintle Hinge Specify handing			137
1/2" barrel diameter			
HNC150 2" x 6" Cabinet Pintle Hinge Specify handing			158
1/2" barrel diameter			

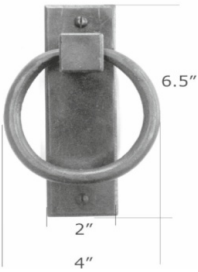
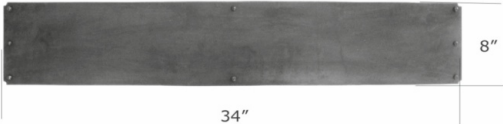

HARDWARE RENAISSANCE		FUNCTION	LIST PRICE \$
IRON ACCESSORIES			
IRON DOOR KNOCKERS			
HD252	6" Knot		379
HD254	6" Ring		379
HD255	6" Twist		379
HD256	4.75" East-West Oval		379
HD257	6.5" East-West II		368
IRON KICK PLATES HKP810	Call for custom sizes		527
		HKP810: 34" x 8" x 1/8" Specify Straight Edge, Beveled (square corners), or Notched.	

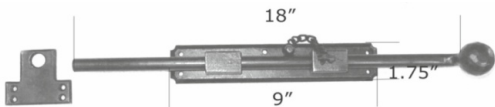
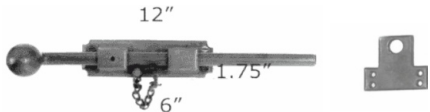
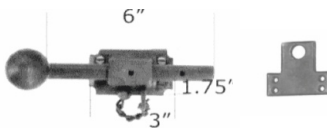

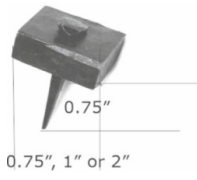
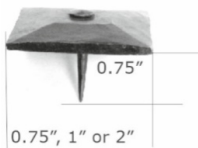
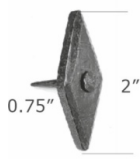
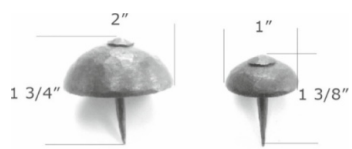

HARDWARE RENAISSANCE		FUNCTION	LIST PRICE \$
IRON ACCESSORIES			
IRON SURFACE BOLTS			
<p>With Mortise Strike standard. Specify surface strike if required Custom lengths available. Call for pricing.</p>			
HB280	24" Surface Bolt with Leaf Grip		611
HB281	18" Surface Bolt with Leaf Grip		494
HB283	12" Surface Bolt with Leaf Grip		415
HB285	6" Surface Bolt with Leaf Grip		322

HARDWARE RENAISSANCE		FUNCTION	LIST PRICE \$
IRON ACCESSORIES			
IRON SURFACE BOLTS			
<p>With Mortise Strike standard. Specify surface strike if required Custom lengths available. Call for pricing.</p>			
HB286	24" Dunn Surface Bolt		611
HB287	18" Dunn Surface Bolt		494
HB288	12" Dunn Surface Bolt		415
HB289	6" Dunn Surface Bolt		322

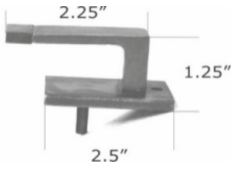
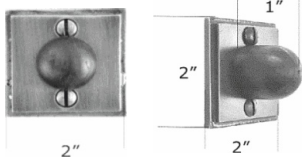
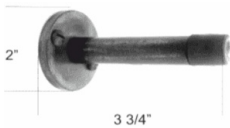
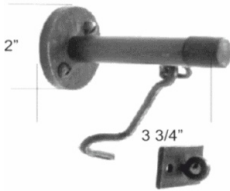

HARDWARE RENAISSANCE		FUNCTION	LIST PRICE \$
IRON ACCESSORIES			
IRON SURFACE BOLTS			
<p>With Mortise Strike standard. Specify surface strike if required Custom lengths available. Call for pricing.</p>			
HB274	24" Narrow Guide Surface Bolt		564
HB273	18" Narrow Guide Surface Bolt		459
HB272	12" Narrow Guide Surface Bolt		389
HB271	6" Narrow Guide Surface Bolt		298

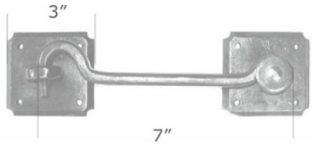
HARDWARE RENAISSANCE		FUNCTION	LIST PRICE \$
IRON ACCESSORIES			
HB233 18" Cane Bolt Custom lengths available. Call for pricing.			461
IRON SPECIALTY BOLTS			
HB520 Slide Bolt			349
HGC600 Cannonball Gate Closer			1,618

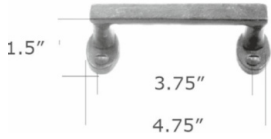
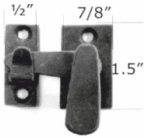

HARDWARE RENAISSANCE			FUNCTION	LIST PRICE \$
IRON ACCESSORIES				
IRON CLAVOS				
HC331 0.75" Round HC332 1" Round HC333 2" Round				22 25 30
HC341 0.75" Square HC342 1" Square HC343 2" Square				22 25 30
HC351 0.75" Pyramid HC352 1" Pyramid HC353 2" Pyramid				22 25 30
HC323 2" Diamond				30
HC362 1" Dome HC363 2" Dome				30 40
HN390 Split Nail				20

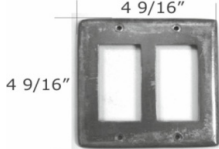
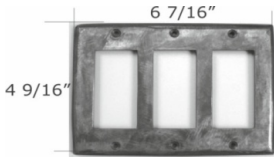
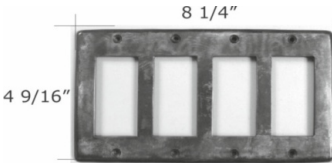
HARDWARE RENAISSANCE		FUNCTION	LIST PRICE \$
IRON ACCESSORIES			
IRON DOOR STOPS			
HD258	Floor mounted contemporary		117
HD259	Wall mounted		104
HD261	3.75" Base stop		71
HD261W	3.75" Base stop with hook		86
HD262	3" Floor Stop		90
HD262W	3" Floor stop with hook		106
IRON HOOK & EYE			
HB370L	7" Hook & Eye		229
HB370S	5" Hook & Eye		130

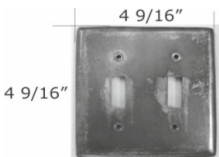

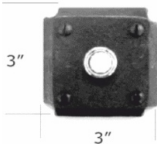
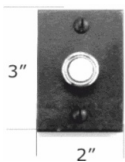

HARDWARE RENAISSANCE		FUNCTION	LIST PRICE \$
IRON ACCESSORIES			
IRON WINDOW HARDWARE			
European Push & Tilt HE500 1.5" x 3" Push & Tilt Escutcheon Available with most mini levers - call for details		 HE500-HL138M	317
With std 7mm square spindle and 90 degree turn mechanism			
Double Hung HW111 Scottsdale Sash Pull			64
HW112 Classic Sash Pull			64
HW114 Sash Lock Specify HANDING (RH shown)			117
HW117 Sash Lift			50
HW115 Casement Latch (specify handing. RH shown) With mortise strike (shown) standard. Specify surface strike.			285





HARDWARE RENAISSANCE			FUNCTION	LIST PRICE \$
IRON ACCESSORIES				
IRON SWITCH PLATE COVERS				
HSP1	Single Décora Switch			79
HSP2	Double Décora Switch			106
HSP3	Triple Décora Switch			152
HSP4	Quad Décora Switch			205
HSPS1	Single Switch Cover			80
HSPS2	Double Switch Cover			106



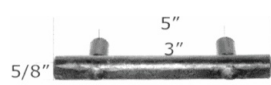
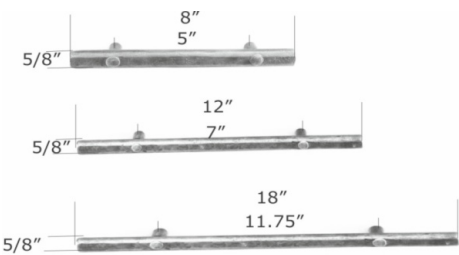

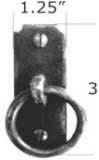
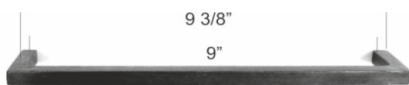
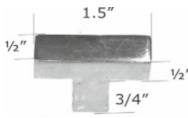
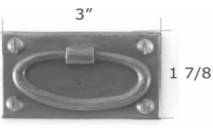
HARDWARE RENAISSANCE			FUNCTION	LIST PRICE \$
IRON ACCESSORIES				
HSPS3	Triple Switch Cover			152
HSPC-cable	Single Cable Cover			80
HSPP	Single Cover Plate			80
HOP1	Double Outlet Cover			80
HOP2	Quad Outlet Cover			106
HSOP2	Combo Switch & Outlet Cover			106
HSOP3	Combo Switch & Decora Cover			106

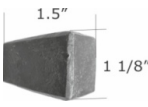

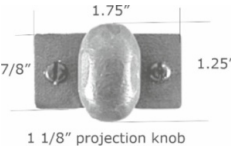
HARDWARE RENAISSANCE		FUNCTION	LIST PRICE \$
IRON ACCESSORIES			
IRON DOOR BELL BUTTONS (any escutcheon can be adapted for door bell button. Call for pricing)			
HE603-BB	3"x 3" Notched Corner		132
HE651-BB	2" x 3" Straight Edge		132
HE651NC-BB HE651B-BB	2" x 3" Notched Corner 2" x 3" Beveled		132
HE627-BB	2 5/8" Round Art Nouveau		132

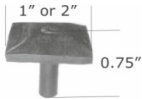

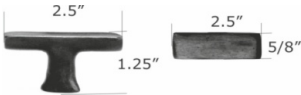
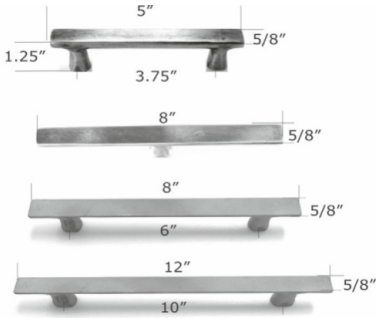

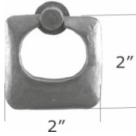
HARDWARE RENAISSANCE		FUNCTION	LIST PRICE \$
IRON ACCESSORIES			
SPEAKEASY GRILLES & LATCHES			
HG285	Speakeasy Grille Call for custom sizes		322
HG287	Chateau Grille		397
HG288	Craftsman Grille		397
HG290	Quarterfoile Grille		690
HG233 HG233-L HG233-S	Speakeasy Latch & Pair of hinge straps Speakeasy Latch ONLY Speakeasy Hinge Straps ONLY (Pair)		298 190 108
HG235 HG235-L HG235-S	Arch Latch & Pair of hinge straps Arch Latch ONLY Arch Hinge Straps ONLY (Pair)		427 251 176

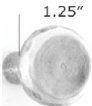
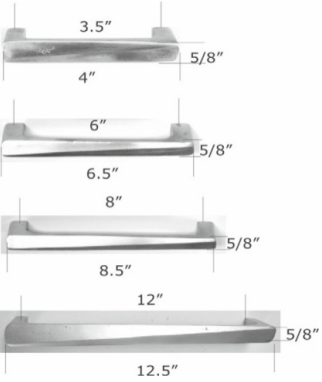
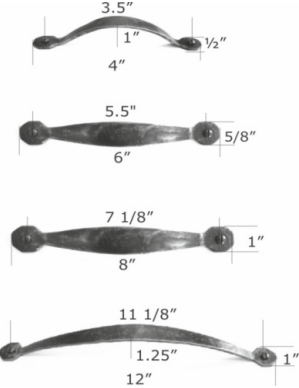

HARDWARE RENAISSANCE		FUNCTION	LIST PRICE \$
IRON CABINET HARDWARE			
HP703	9" Rope		8.25" c-to-c 210
HP704	4.5" Rope		3.75" c-to-c 80
HP706S	8" Trio COPPER wire and bands standard for all patinas Specify for IRON wire and bands	 (w/ copper wire bands)	5" c-to-c 210
HP765	4" Trio COPPER wire and bands standard for all patinas Specify for IRON wire and bands	 (w/ copper wire bands)	2.5" c-to-c 80
HP707SC-4	4 3/8" El Secreto		4" c-to-c 68
HP707SC-6	6 3/8" El Secreto		6" c-to-c 90
HP707SC-8	8" El Secreto		7 5/8" c-to-c 137
HP707SC-12	12" El Secreto		11 5/8" c-to-c 160
HP731	5" Rectangular		
HP708-8	8" Rectangular		5" c-to-c 137
HP708-12	12" Rectangular		7" c-to-c 156
HP708-18	18" Rectangular		11.75" c-to-c 260

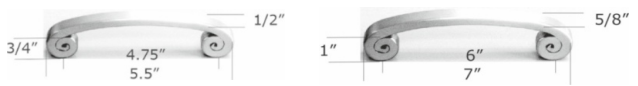
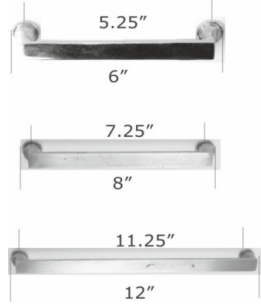
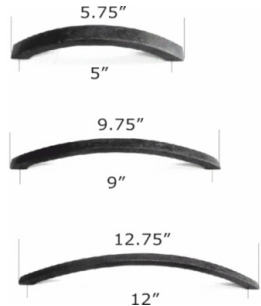
HARDWARE RENAISSANCE			FUNCTION	LIST PRICE \$
IRON CABINET HARDWARE				
HP720	Petite Notched Ring Pull			90
HP726-4 HP726-6 HP726-9 HP726-12 HP726-15 HP726-24	Stockholm 4 3/8" Stockholm 6 3/8" Stockholm 9 3/8" Stockholm 12 3/8" Stockholm 15 3/8" Stockholm 24 3/8"	 3/8" square profile. HP726-9 shown	4" c-to-c 6" c-to-c 9" c-to-c 12" c-to-c 15" c-to-c 24" c-to-c	56 68 97 114 134 181
HP727	Stockholm T- Knob			58
HP732	Bungalow Pull			68
HP733 HP734	1" Round 2" Round			34 42
HP735	East-West			58
HP737	L-shaped Milan			62
HP738	Melon (w/ rectangular rose)			62

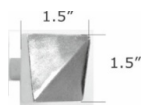

HARDWARE RENAISSANCE			FUNCTION	LIST PRICE \$
IRON CABINET HARDWARE				
HP741	Forged Ball			62
HP743 HP744	1" Pyramid 2" Pyramid			34 42
HP751	Aegean			62
HP753	Oblong T-Knob			62
HP754	Scottsdale T-Knob			62
HP754M HP754L-8 HP754DL-8 HP754DL-12	Scottsdale 5" double-post Scottsdale 8" single-post Scottsdale 8" double-post Scottsdale 12" double-post		3.75" c-to-c N/A 6" c-to-c 10" c-to-c	68 137 137 160
HP758	Sunrise			58
HP760	Tokyo Ring Pull			68

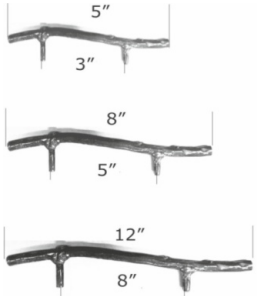

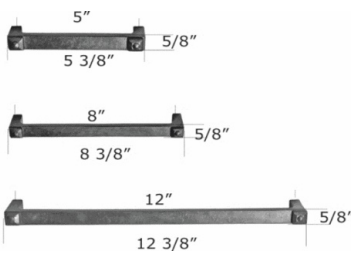
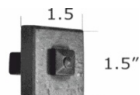
HARDWARE RENAISSANCE			FUNCTION	LIST PRICE \$
IRON CABINET HARDWARE				
HP761	Bin Pull			68
HP762	Casa California			58
HP763	Mushroom			53
HP764	Martini			53
HP766-4 HP766-6 HP766-8 HP766-12	4" Milan 6.5" Milan 8.5" Milan 12.5" Milan		3.5" c-to-c 6" c-to-c 8" c-to-c 12" c-to-c	68 95 137 163
HP767-4 HP767-6 HP767-8 HP767-12	4" Hampton 6" Hampton 8" Hampton 12" Hampton		3.5" c-to-c 5.5" c-to-c 7 1/8" c-to-c 11 1/8" c-to-c	68 90 115 148

HARDWARE RENAISSANCE			FUNCTION	LIST PRICE \$
IRON CABINET HARDWARE				
HP768-6 6" Casa Cal II HP768-13 13.25" Casa Cal II		5" c-to-c 12" c-to-c	90 176	
HP769-5 5.5" Casa Cal III HP769-7 7" Casa Cal III HP769-12 12" Casa Cal III		4.75" c-to-c 6" c-to-c 11" c-to-c	97 104 204	
HP772-6 6" Prescott HP772-8 8" Prescott HP772-12 12" Prescott		5.25" c-to-c 7.25" c-to-c 11.25" c-to-c	79 117 160	
HP773-5 5.75" Arc HP773-9 9.75" Arc HP773-12 12.75" Arc		5" c-to-c 9" c-to-c 12" c-to-c	68 115 149	
HP774 Milan Rectangular			58	
HP775 Milan Square			66	
HP778 Trio T- Knob			66	

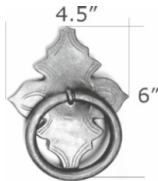
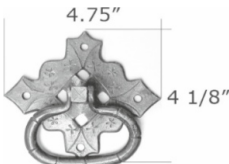
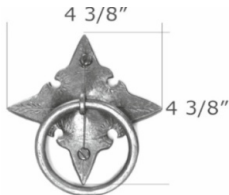
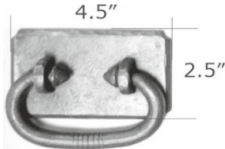

HARDWARE RENAISSANCE			FUNCTION	LIST PRICE \$
IRON CABINET HARDWARE				
HP788-5 5" Twig HP788-8 8" Twig HP788-12 12" Twig		3" c-to-c 5" c-to-c 8" c-to-c	68 115 163	
HP791-4 4 3/8" Monte Vista HP791-6 6 3/8" Monte Vista HP791-8 8 3/8" Monte Vista HP791-12 12 3/8" Monte Vista		4" c-to-c 6" c-to-c 8" c-to-c 12" c-to-c	68 90 115 163	
HP793-5 5 3/8" Cody HP793-8 8 3/8" Cody HP793-12 12 3/8" Cody		5" c-to-c 8" c-to-c 12" c-to-c	68 115 163	
HP794 Cody Square			68	

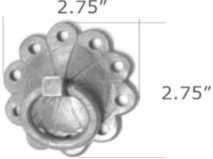
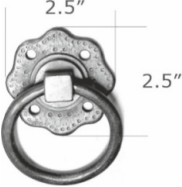
HARDWARE RENAISSANCE			FUNCTION	LIST PRICE \$
IRON CABINET HARDWARE				
HP795-4 4 3/8" Avila HP795-6 6 3/8" Avila HP795-8 8 3/8" Avila HP795-12 12 3/8" Avila		4" c-to-c 6" c-to-c 8" c-to-c 12" c-to-c	73 99 137 181	
HP797-4 4 1/4" Sierra HP797-8 8 1/4" Sierra HP797-12 12 1/4" Sierra		4" c-to-c 8" c-to-c 12" c-to-c	68 115 163	
HP798-6 6.5" Dixon HP798-8 8.5" Dixon HP798-12 12.5" Dixon		6" c-to-c 8" c-to-c 12" c-to-c	77 115 163	
HP799	Dixon Round			60
HP809	El Secreto T-Knob			62

HARDWARE RENAISSANCE		FUNCTION	LIST PRICE \$
IRON RING PULLS			
HP716 Catalonia Through-bolted standard Specify for surface mounting			238
HP717 Seville Through-bolted standard Specify for surface mounting			207
HP718P Merida Through-bolted standard Specify for surface mounting			207
HP719 Guadalupe Through-bolted standard Specify for surface mounting			207
HP736 Veracruz			207

HARDWARE RENAISSANCE		FUNCTION	LIST PRICE \$
IRON RING PULLS			
<p>HP739 Baja</p> <p>Through-bolted standard Specify for surface mounting</p>			172
<p>HP740 Monterey</p> <p>Through-bolted standard Specify for surface mounting</p>			172
<p>HP715 Twist Ring Pull</p>			280

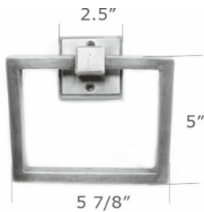
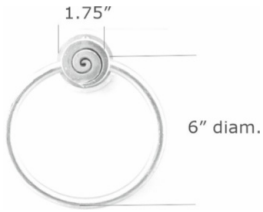
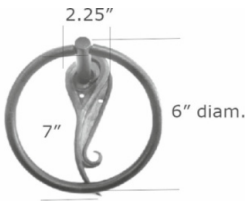
HARDWARE RENAISSANCE		FUNCTION	LIST PRICE \$
IRON BATH HARDWARE			
ROBE HOOKS			
HT702	Scroll		130
HT703	East-West		130
HT704	Casa California		130
HT709	Diamond Specify for escutcheon on square		130
TOILET PAPER HOLDERS			
HT701	Diamond Specify for escutcheon on square		176
HT705	East West	2.5" square 	229
HT706	Casa California	2.5" diam. 	229
HT801	Art Nouveau		383

HARDWARE RENAISSANCE		FUNCTION	LIST PRICE \$		
IRON BATH HARDWARE					
TOWEL RINGS					
HT712	Diamond		271		
Specify for escutcheon on square					
HT746	East-West				329
HT747	Casa California				329
HT812	Art Nouveau		538		
TOWEL BARS					
HT716	Diamond 16"		256		
HT724	Diamond 24"			329	
HT732	Diamond 32"				414
Specify for escutcheon on square					
HT736	East-West 16"	329			
HT737	East-West 24"		395		
HT738	East-West 32"			527	
2.5" square					

HARDWARE RENAISSANCE			FUNCTION	LIST PRICE \$
IRON BATH HARDWARE				
HT756 HT757 HT758	Casa California 16" Casa California 24" Casa California 32"	<p>16", 24", or 32"</p> <p>2.5" diam.</p>		329 395 527
HT816 HT824 HT832	Art Nouveau 16" Art Nouveau 24" Art Nouveau 32"	<p>16", 24", or 32"</p> <p>2.25"</p> <p>7"</p>		770 866 982



HR **HARDWARE
RENAISSANCE**
LIKE NO OTHER™

Sante Fe, New Mexico, USA
www.hardwarerenaissance.com