



## Solid Bronze Hardware Price List

———— June 1, 2022 ————

T 505.983.2644

[sales@hardwarerenaisance.com](mailto:sales@hardwarerenaisance.com)

[www.hardwarerenaisance.com](http://www.hardwarerenaisance.com)



# June 1, 2022 SOLID BRONZE PRICE LIST

## TABLE OF CONTENTS

### PAGES

<b>ORDERING INFORMATION</b> .....	4
Door Handing, Mortise lock options .....	5
Upcharges (thick door, extended strikes, etc.) .....	6
Multipoint Hardware spec sheets & order form .....	7
<b>BRONZE PATINA OPTIONS</b> .....	11
<b>LEVER &amp; KNOBS OPTIONS</b> .....	12
<b>DOOR HARDWARE COLLECTIONS</b>	
Amalfi .....	14
Amora Royale .....	17
Canyon .....	20
Cayman Royale .....	23
CONCEALED-SCREW MODERN ESCUTCHEONS .....	26
El Secreto .....	27
Grande Manhattan .....	30
Greco .....	33
Manhattan (Beveled Edge) .....	36
Milan (Straight Edge) .....	39
Scottsdale Royale .....	42
Tribeca .....	45
Art Deco .....	48
Art Nouveau .....	50
Notched Corner / Casa California .....	53
Chateau .....	57
Fleur de Lis .....	59
Verona (Beveled Edge) .....	61
Strike-bar Latches Collection .....	64
<b>SLIDING DOOR HARDWARE</b> .....	67
<b>POCKET DOOR HARDWARE</b> .....	71
<b>DOOR &amp; APPLIANCE PULLS</b> .....	73
<b>PUSH PLATES</b> .....	78
<b>ACCESSORIES</b>	
Straps & Braces .....	79
Door Knockers .....	80
Surface & Cane Bolts .....	81
Clavos .....	81
Door Stops .....	82
Window Hardware .....	83
Heavy Duty Butt Hinges .....	84
Door Bell Buttons & Switch Plate Covers .....	85
Hook & Eye and Speakeasy Grille .....	86
<b>KITCHEN &amp; BATH</b>	
Cabinet Knobs & Pulls .....	87
Bath Hardware .....	96

M  
O  
D  
E  
R  
N



E  
U  
R  
O



## ORDERING INFORMATION

### NOTE :

- 1) **ALL PRICES LIST**
- 2) **ALL PRICES INCLUDE ALL NECESSARY LOCKS AND COMPONENTS**
- 3) **COLLECTIONS ARE SHOWN FOR EASE OF ORDERING. LEVERS & KNOBS CAN BE INTERCHANGED WITHOUT UPCHARGE**
- 4) **CONTACT US FOR OTHER PAIRING OPTIONS AND CUSTOM WORK QUOTES**
- 5) **ALL PATINAS (FINISHES) ARE PRICED THE SAME**
- 6) UPCHARGES FOR DOORS THICKER THAN 1.75": SEE UPCHARGES ON PAGE 6
- 7) DOORS LESS THAN 1.75" THICK? **ESCUTCHEONS WHICH WILL WORK ARE NOTED**
- 8) **WE DO NOT KEY ALIKE BY DEFAULT. SEE UPCHARGES ON PAGE 7 FOR KEYED ALIKE**
- 9) SEE GLOSSARY ON THIS PAGE FOR CODES
- 10) PRICES ARE SUBJECT TO CHANGE AT ANY TIME
- 11) HR IS NOT RESPONSIBLE FOR TYPOGRAPHICAL ERRORS
- 12) **SEND ALL ORDERS TO SALES@HARDWARERENAISSANCE.COM**
- 13) FORMAT FOR ORDERING: Backplate-Lever-Function-Lock type-Patina-Door thickness-Backset.  
Eg: BE676-BL137-EN-ML-MG-1.75-2.5

### SUMMARY TERMS OF SALE:

- 1) There is no minimum order. Hardware Renaissance reserves the right to refuse any order in whole or part.
- 2) Orders once placed and confirmed by Hardware Renaissance may not be changed or cancelled without the approval of Hardware Renaissance. Approved cancellations are subject to a 40% restocking fee.
- 3) LEAD TIMES are 6-8 weeks for standard products, and up to 12 weeks for custom. We do not offer a rush option for bronze hardware. Contact us for details.
- 4) All sales are FOB Santa Fe NM USA. All orders will be shipped prepaid and added to the invoice.
- 5) Drop-shipment requests are subject to Hardware Renaissance's DROP SHIPMENT POLICY.
- 6) Returns are acceptable only for defects or errors for which Hardware Renaissance is responsible, and must be accompanied by an RGA requested in advance. All RGA's expire 60 days after issuance.
- 7) Returns of standard hardware, requested within 30 days of invoice date, are at the discretion of Hardware Renaissance and subject to a 40% restocking fee.
- 8) There are NO RETURNS on Multipoint & Sliding Door Hardware.
- 9) There are NO RETURNS on products with INLAY (Grande Manhattan, Scottsdale Royale, Amora Royale and Cayman Royale)
- 10) There are NO RETURNS on custom products.

### GLOSSARY OF FUNCTIONS & LOCK TYPES:

#### FUNCTIONS:

EN	Entry (Keyed)
PT	Patio
FD	Full Dummy
SD	Single Dummy
AD	Active Dummy
PP	Passage
PR	Privacy

#### LOCK TYPES:

ML	Mortise Lock
MD	Mortise Deadbolt
DB	Tubular Deadbolt
SC	Single Cylinder
DC	Double Cylinder
TL	Tubular Latch
PMB	Privacy Bolt

## HANDING OF DOOR

Door Handing is determined by standing at the outside of the door while facing the door. The side of the hinges determines door handing.

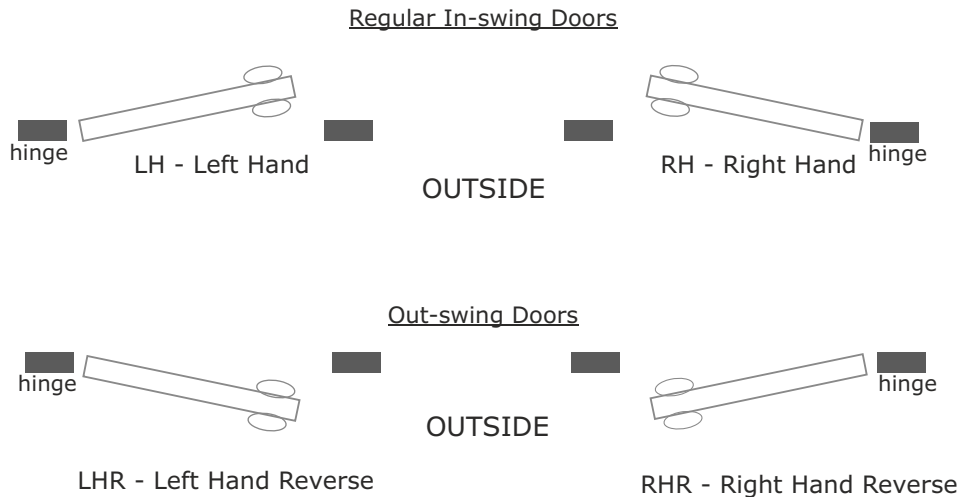

### **9100 Mortise Lock: Choice of ENTRY Functions. SPECIFY ON ORDER!**

#### **9148**

Entrance or Apartment Lock

Latch bolt by key outside and lever either side unless outside lever is locked by toggle action stop.

Deadbolt by key outside and turn piece inside.

Turning inside lever retracts latch and deadbolt simultaneously.

Outside lever remains locked until manually unlocked by toggle.

#### **9149**

Entrance or Apartment Lock.

Latch bolt by key outside and lever either side unless outside lever is locked by toggle action stop.

Deadbolt by key outside and turn piece inside.

Turning inside lever retracts latch and deadbolt simultaneously.

Outside lever remains unlocked until manually locked by toggle or projection of deadbolt.

*\* Function not offered on thumb grip x thumb grip applications*

#### **9124 (No Toggle)**

Dormitory, Entrance or Storeroom Lock.

Latch bolt by lever either side.

Deadbolt by key outside and turn piece inside.

Turn of inside lever retracts latch and deadbolt simultaneously, automatically unlocking outside lever.

**UPCHARGES (ALL UPCHARGES ARE NET)**

**THICK DOOR UPCHARGES:**

(If your door is in between, choose the next higher door thickness)

Door Thickness	Mortise Lock Sets	Mortise Deadbolt Sets (Strike-bar latch)	Tubular Deadbolt Sets
1.75"	NONE	NONE	NONE
2"	\$ 23.00	NONE	NONE
2.25"	\$ 29.00	\$ 13.00	\$ 8.00
2.5"	\$ 50.00	\$ 36.00	\$ 8.00
2.75"	\$ 55.00	\$ 36.00	\$ 8.00
3"	\$ 61.00	\$ 42.00	\$ 8.00
3.25"	\$ 61.00	\$ 42.00	\$ 8.00
3.5"	\$ 65.00	\$ 46.00	\$ 8.00
3.75"	\$ 65.00	\$ 46.00	\$ 11.00
4"	\$ 69.00	\$ 50.00	\$ 11.00
4.25"	\$ 69.00	\$ 50.00	\$ 11.00

**UPCHARGES FOR EXTENDED T-STRIKES AND FOR FULL LIP STRIKES**

(NOTE: WE SUPPLY T-STRIKES STANDARD)

**UPCHARGES FOR EXTENDED T-STRIKES**

(If your door is in between, choose the next higher thickness)

Door Thickness	T-Strike Size	NET per set
1.75"	1 1/4"	NONE
2"	1 1/4"	NONE
2.25"	1 1/2"	\$ 11.00
2.5"	1 1/2"	\$ 11.00
2.75"	1 3/4"	\$ 12.00
3"	1 3/4"	\$ 12.00
3.25"	2"	\$ 12.00
3.5"	2"	\$ 12.00
3.75"	2.5"	\$ 13.00
4"	2.5"	\$ 13.00

**UPCHARGES FOR FULL LIP STRIKES**

Door Thickness	FLS Size	NET per set
1.75"	1 3/16"	\$ 5.00
2"	1 3/16"	\$ 5.00
2.25"	1 1/2"	\$ 10.00
2.5"	1 1/2"	\$ 10.00
2.75"	1 3/4"	\$ 12.00
3"	1 3/4"	\$ 12.00
3.25"	2"	\$ 13.00
3.5"	2"	\$ 13.00

(Not available for doors over 3.5" thick)

**UPCHARGES FOR KEYED ALIKE**

(NOTE: WE DO NOT KEY ALIKE UNLESS SPECIFIED)

No. of Cylinders	Key Alike charge TOTAL NET	No. of Keys provided	Extra keys NET per key
2	\$ 9.00	4	\$ 5.00
3	\$ 14.00	4	
4	\$ 17.00	4	
5	\$ 19.00	4	
6	\$ 23.00	4	
7	\$ 27.00	4	
8	\$ 32.00	4	
9	\$ 37.00	4	
10	\$ 42.00	4	
11	\$ 46.00	4	

## MULTIPOINT HARDWARE ORDERING INFORMATION

Multipoint hardware is available for most doors (except Andersen).

See specification pages for configurations and functions, and send the Multipoint Hardware Order Form with your order.



### MULTIPOINT RETROFIT HARDWARE SPECIFICATION SHEET - PG.1 LEVER HIGH, AMERICAN CYLINDER SETS

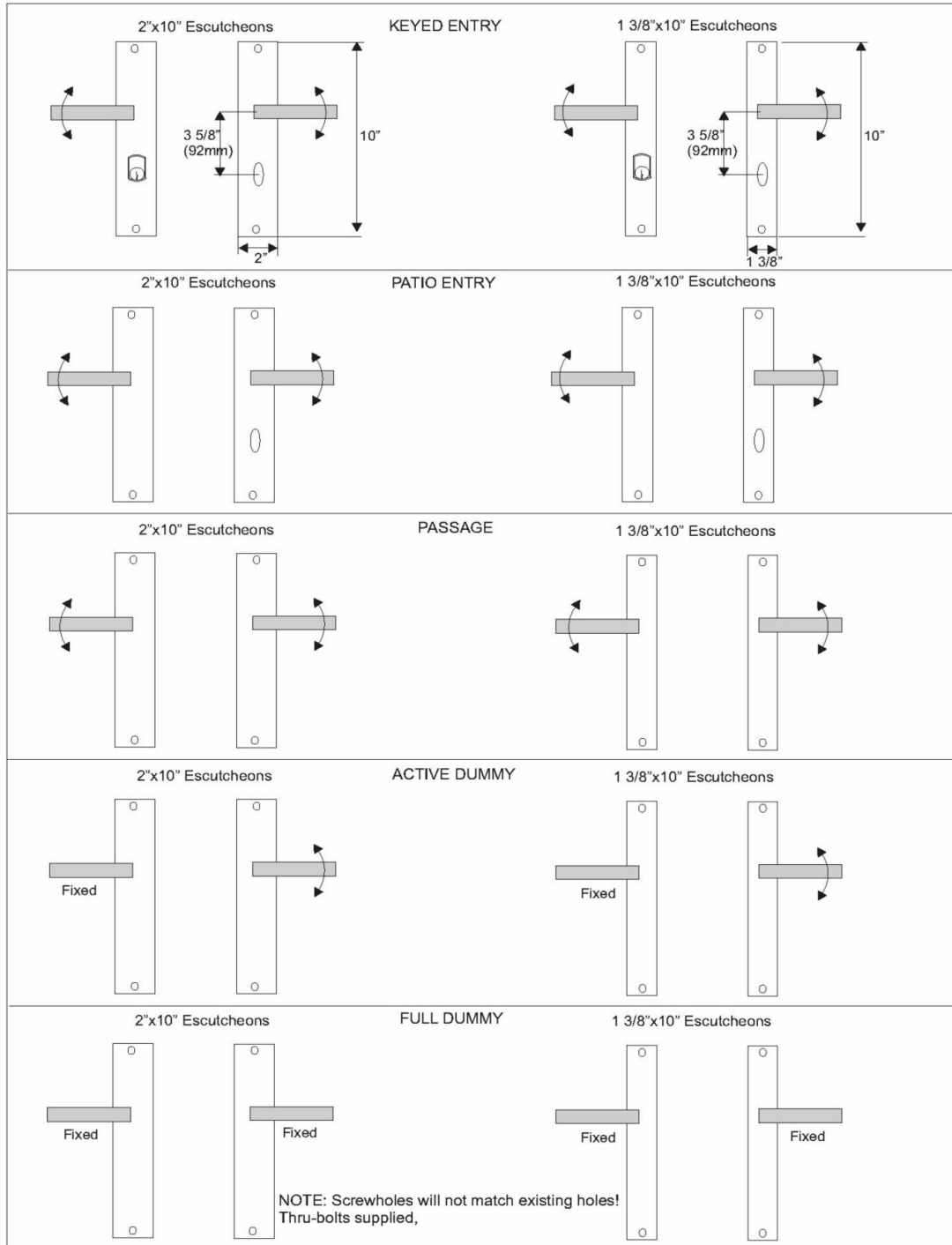

HR/MPspec/0113



MULTIPOINT RETROFIT HARDWARE SPECIFICATION SHEET - PG.2  
LEVER LOW, AMERICAN CYLINDER SETS

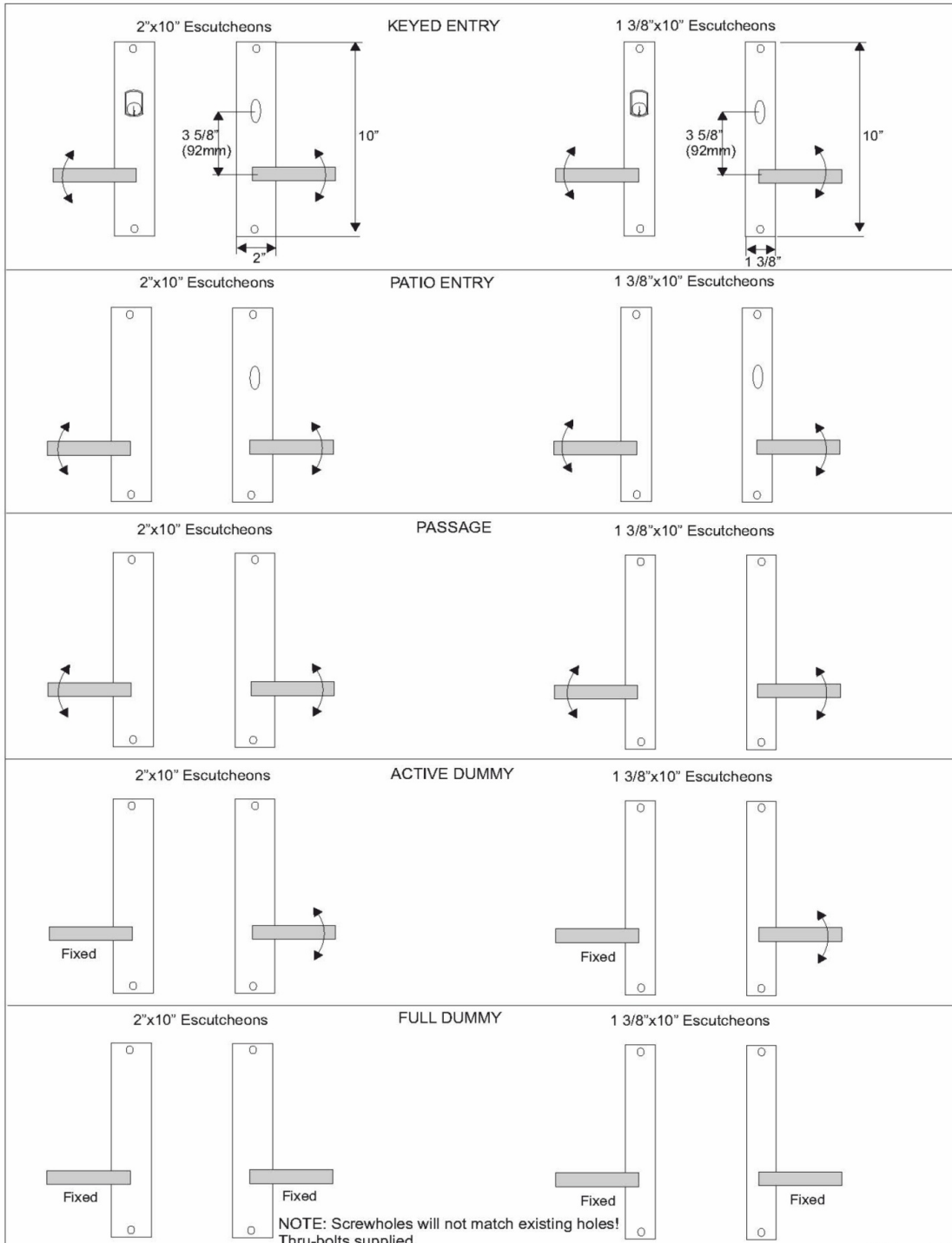

HRMPSpec/0113



MULTIPOINT RETROFIT HARDWARE SPECIFICATION SHEET - PG.3  
LEVER HIGH, EUROPEAN PROFILE CYLINDER SETS

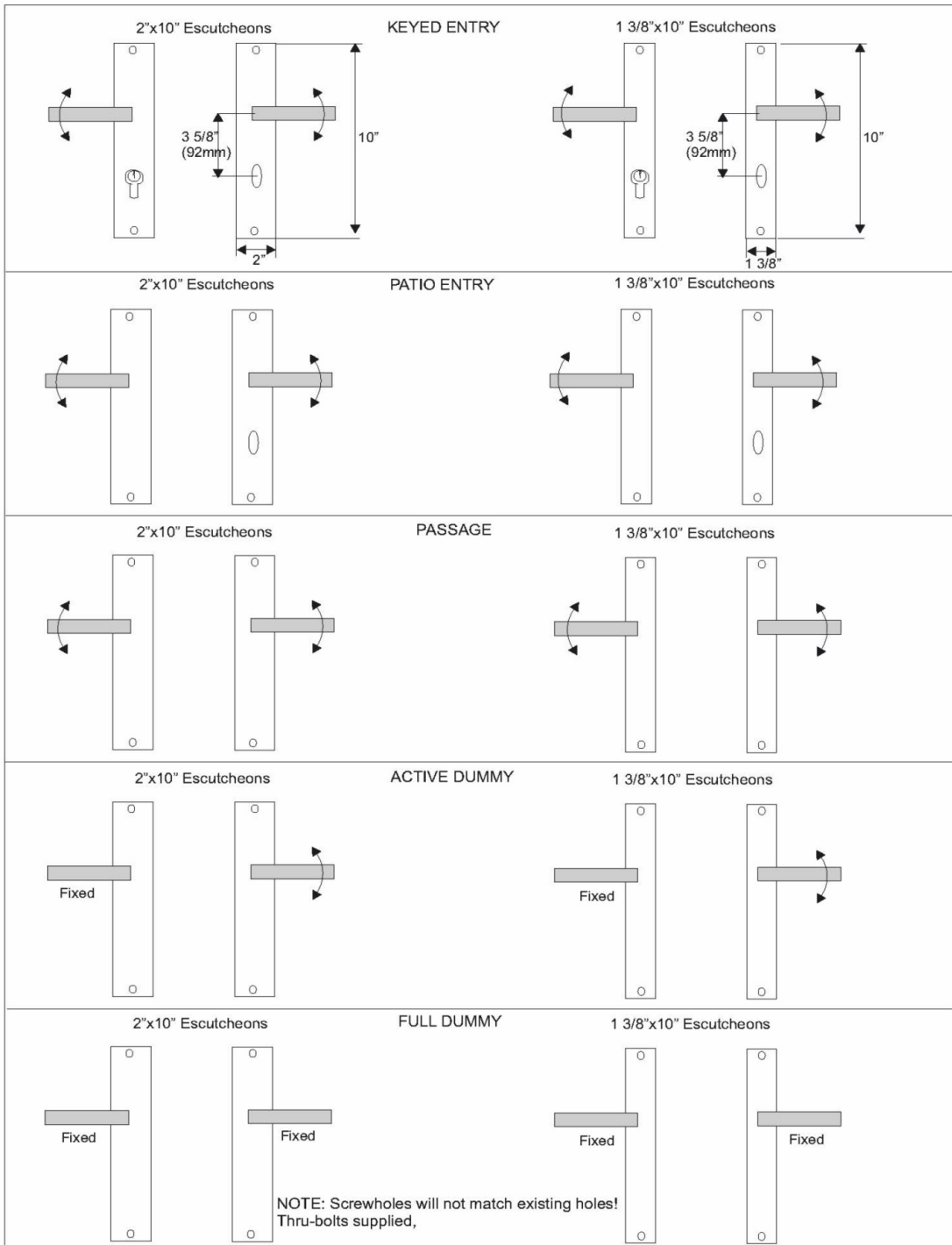

HR/MPspec/0113



**HARDWARE RENAISSANCE  
MULTIPOINT RETROFIT HARDWARE FORM**  
Please provide this with your Multipoint Retrofit order  
(REFER TO MULTIPOINT SPEC SHEETS)

DATE \_\_\_\_\_

DEALER \_\_\_\_\_

PO# \_\_\_\_\_

\* LOCK MAKE: \_\_\_\_\_

\* DOOR THICKNESS (1.75" std.) \_\_\_\_\_

\* CYLINDER:  
**EURO PROFILE**

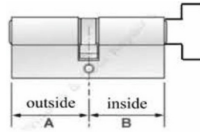

Centered in door (std.)   
Offset A:   
B:

**AMERICAN**



Tailpiece horizontal (std.)   
Tailpiece vertical

\* LEVER LOCATION: High   
Low

\* CENTER TO CENTER (std. 92mm or 3 5/8"):  
92mm   
Other (specify)

\* PASSIVE (NON-LOCKING) DOOR SETS:  
FULL DUMMY (both levers fixed)   
ACTIVE DUMMY (outside lever fixed, inside lever working)   
PASSAGE (both levers working)

\* SPINDLE (HUB) SIZE: 8mm square (std.)   
Other (specify)

THUMBURNS: Contemporary styles with cuboid thumbturns. Classic styles with oval thumbturns.

**HANDING guide:**

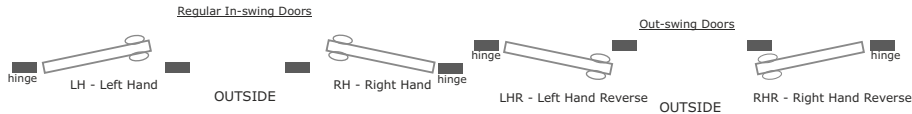

**NOTE ABOUT OUR SCREW HOLE LOCATIONS: We do NOT match existing screw hole locations.**  
Our screw holes are made to miss existing holes. We provide thru-bolts for install.

**NOTE FOR IRON MULTIPOINTS:** HOLES WILL ALSO NEED TO BE MADE TO ACCOMODATE LEVER SPRING ASSIST.

3205 A Mercantile Court, Santa Fe NM 87507 T: 505-963-2644 F: 505-820-2941 www.hardwarerenaissance.com

## SOLID BRONZE PATINAS

**HARDWARE PRICE INCLUDES CHOICE OF ANY OF THE FOLLOWING HAND APPLIED PATINAS :**

<b>PATINA NAME</b>	<b>PATINA CODE</b>
--------------------	--------------------

SILICON BRONZE BASE ALLOY

Midnight Gold:	MG
Cascade Green:	CG
Antique Gold:	AN
Red Autumn Leaves:	RL
Sonora Red:	SR
French Brown:	FB
Granite Verde:	GV
Tuscan Bronze:	TB
Old Copper:	OC
Navajo Silver:	NS
Khaki:	KH
Obsidian:	ON
Brushed Bronze:	BB

WHITE BRONZE BASE ALLOY

Natural White:	NW
Pewter White:	PW
Midnight White:	MW

**IMPORTANT NOTE ABOUT OUR BRONZE PATINAS:**

All patinas are hand applied and will vary slightly from patina samples or display samples. This is due to aging of samples, and natural variations in patina which occur depending upon the bronze casting, and temperature and humidity while applying the patina. This is considered to be a key part of the beauty and uniqueness of our hand crafted product and not a defect.

All our patinas are living finishes and will age gracefully over time. How quickly they will age depends upon the conditions of use and maintenance (a light re-waxing).

## LEVER & KNOB OPTIONS

(All levers and knobs are priced the same)



BL101 Verona

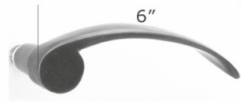

BL102 Soho



BL103 Casa California



BL105 Art Deco

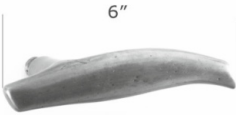

BL107 Neha

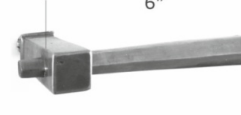

BL108 East-West



BL109 Fleetwood



BL110 Eagle Eye

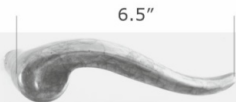

BL112 Dolphin



BL131 Accent



BL132 Manhattan



BL135 Verona II



BL136 Capri



BL137 Milan



BL138 Del Mar



BL139 Chelsea



BL140 Bay  
(Right angle back)

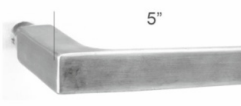

BL141 Scottsdale  
(Radius back)



BL142 Taos



BL143 Toscana

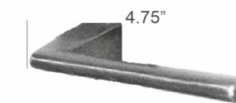

BL145 Salon

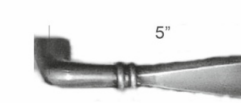

BL146 Fleur de Lis



BL147 Taylor Lever



BL155 El Secreto Lever

## LEVER & KNOB OPTIONS

(All levers and knobs are priced the same)



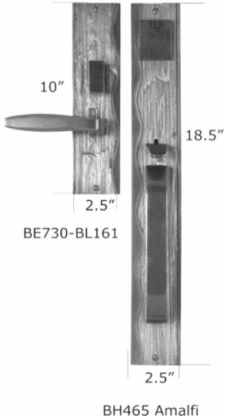
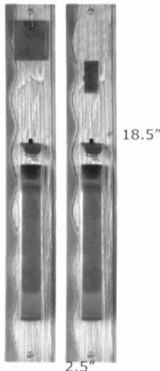
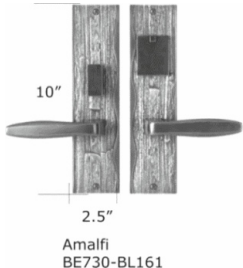

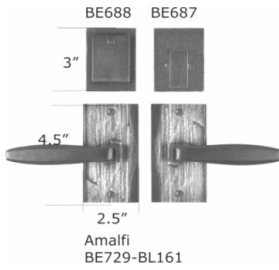
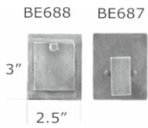
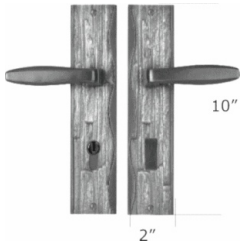
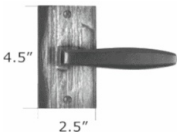
HARDWARE RENAISSANCE	FUNCTION	LIST PRICE \$
<b>BRONZE AMALFI COLLECTION</b>		
TEXTURED BRONZE WITH HAND SHADED FINISHES		
<p><b>AMALFI Thumbblatch x Lever Entry</b> (Mortise Only) <b>BH465 - BE730-BL161</b></p>  <p style="text-align: center;">BH465 Amalfi</p> <p>See Page 5 for choice of Mortise Lock functions. Std Door Thickness: 1.75". Std Backsets: 2.5" or 2.75"</p>	EN-ML FD	2,692 1,905
<p><b>AMALFI Thumbblatch x Thumbblatch Entry</b> (Mortise Only) <b>BH465-BH465</b></p>  <p style="text-align: center;">BH465 Amalfi</p> <p>See Page 5 for choice of Mortise Lock functions. Std Door Thickness: 1.75". Std Backsets: 2.5" or 2.75"</p>	EN-ML FD	3,007 2,255
<p><b>AMALFI Lever x Lever Entry</b> (Mortise Only) <b>BE730-BL161</b></p>  <p style="text-align: center;">Amalfi BE730-BL161</p> <p>See Page 5 for choice of Mortise Lock functions. Std Door Thickness: 1.75". Std Backsets: 2.5" or 2.75"</p>	EN-ML PT-ML FD	1,716 1,630 805

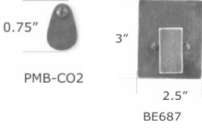
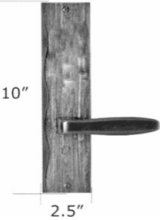

HARDWARE RENAISSANCE		FUNCTION	LIST PRICE \$
<b>BRONZE AMALFI COLLECTION</b>			
<p><b>AMALFI Sectional Lever x Lever Entry</b> (Tubular) <b>BE729-BL161</b> with BE687-BE688 deadbolt</p>  <p>Mortise: Accurate 9503 Deadlock. Std Door Thickness: 1.75". Std Backsets: 2.5" or 2.75" Baton Tubular Latch &amp; Deadbolt. Std Door Thickness: 1.75". Std Backsets 2 3/8" or 2.75"</p>	<p>EN-DB-SC 1,058 EN-DB-DC 1,118 EN-MD 1,233 PT-DB 916 FD 611</p>		
<p><b>Modern Deadbolt Only</b> (Tubular or Mortise) <b>BE687-BE688</b></p>  <p>Mortise: Accurate 9503 Deadlock. Std Door Thickness: 1.75". Std Backsets: 2.5" or 2.75" Tubular: Baton Tubular Deadbolt. Std Door Thickness: 1.75". Std Backsets 2 3/8" or 2.75"</p>	<p>EN-DB-SC 342 EN-DB-DC 403 PT-DB 200 EN-MD 517</p>		
<p><b>AMALFI Multipoint Hardware</b> <b>BE731-BL161</b></p>  <p>Available for most door makes (except Andersen). See Multipoint Spec Sheets for available configurations and functions Must send Multipoint order form along with order</p>	<p>EN-EURO 1,067 PT-EURO 1,010 PP 811 AD 790 FD 768</p>		
<p><b>AMALFI Passage/ Privacy/ Dummy</b> (Tubular) <b>BE729-BL161</b></p>  <p>Baton Tubular Latch. Std Door Thickness: 1.75". Std Backsets: 2 3/8" or 2.75"</p>	<p>PP-TL 715 PR-TL 739 FD 611 SD 306</p>		

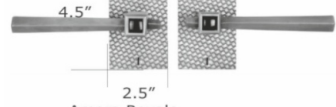
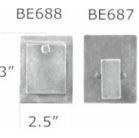
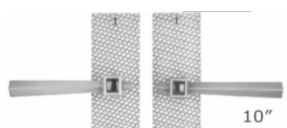
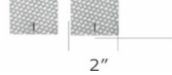
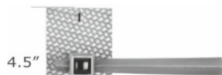
HARDWARE RENAISSANCE	FUNCTION	LIST PRICE \$
<b>BRONZE AMALFI COLLECTION</b>		
<p><b>Modern Privacy Bolt</b> (Tubular: Add to Passage Set) <b>BE687-PMB</b></p>  <p>Baton Privacy Bolt. Std Door Thickness: 1.75". Std Backsets: 2 3/8" or 2.75"</p>	PMB	236
<p><b>AMALFI Passage/ Privacy/ Dummy</b> (Tubular or Mortise) <b>BE730-BL161</b></p>  <p>Mortise: Accurate 9100 lock. Std Door Thickness: 1.75". Std Backsets: 2.5" or 2.75" Baton Tubular Latch &amp; Privacy Bolt. Std Door Thickness: 1.75". Std Backsets: 2 3/8" or 2.75"</p>	PP-TL PR-TL PR-PMB PP-ML PR-ML FD SD	917 940 1,102 1,196 1,442 805 403

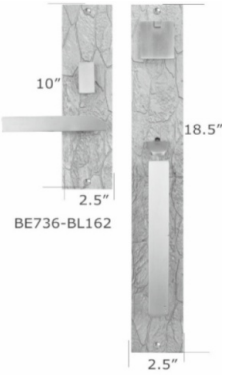

HARDWARE RENAISSANCE		FUNCTION	LIST PRICE \$
<b>BRONZE AMORA ROYALE COLLECTION (OPTIONAL stone inlay)</b>			
BASKETWEAVE TEXTURE WITH OPTIONAL PANTHER-JASPER (PJ) OR BLACK JADE (JB) STONE INLAY			
SPECIFY WITH OR WITHOUT INLAY. IF WITH INLAY, SPECIFY TRIM FINISH AND INLAY STONE			
<p><b>AMORA ROYALE Thumbblatch x Lever Entry</b> (Mortise Only) <b>BHR466 - BE733-BLR108</b></p> <p><b>BH466 - BE733- BL108 (w/out Inlay)</b> (w/out inlay: any lever or knob)</p>	<p>BHR466 Amora Royale (w/optional semi-precious stone inlay)</p>	<p>WITH INLAY</p> <p>WITHOUT INLAY</p>	<p>EN-ML FD</p> <p>EN-ML FD</p> <p>3,171 2,474</p> <p>2,692 1,905</p>
See Page 5 for choice of Mortise Lock functions. Std Door Thickness: 1.75". Std Backsets: 2.5" or 2.75"			
<p><b>AMORA ROYALE Thumbblatch x Thumbblatch Entry</b> (Mortise Only) <b>BHR466-BHR466</b></p> <p><b>BH466-BH466 (w/out Inlay)</b></p>	<p>BHR466 Amora Royale (w/optional semi-precious stone inlay)</p>	<p>WITH INLAY</p> <p>WITHOUT INLAY</p>	<p>EN-ML FD</p> <p>EN-ML FD</p> <p>3,532 2,800</p> <p>3,008 2,256</p>
See Page 5 for choice of Mortise Lock functions. Std Door Thickness: 1.75". Std Backsets: 2.5" or 2.75"			
<p><b>AMORA ROYALE Lever x Lever Entry</b> (Mortise Only) <b>BE733-BLR108</b></p> <p><b>BE733-BL108 (w/out Inlay)</b> (w/out inlay: any lever or knob)</p>	<p>Amora Royale w/optional semi-precious stone inlay BE733-BLR108</p>	<p>WITH INLAY</p> <p>WITHOUT INLAY</p>	<p>EN-ML PT-ML FD</p> <p>EN-ML PT-ML FD</p> <p>1,887 1,801 1,036</p> <p>1,716 1,630 805</p>
See Page 5 for choice of Mortise Lock functions. Std Door Thickness: 1.75". Std Backsets: 2.5" or 2.75"			

HARDWARE RENAISSANCE		FUNCTION	LIST PRICE \$
<b>BRONZE AMORA ROYALE COLLECTION (OPTIONAL stone inlay)</b>			
<b>AMORA ROYALE Sectional Lever x Lever Entry</b> (Tubular) <b>BE732-BLR108</b> with BE687-BE688 deadbolt		WITH INLAY	EN-DB-SC 1,125 EN-DB-DC 1,185 EN-MD 1,300 PT-DB 982 FD 678
<b>BE732-BL108 (w/out Inlay)</b> (w/out inlay: any lever or knob)	 <p>Amora Royale w/optional semi-precious stone inlay BE732-BLR108</p>	WITHOUT INLAY	EN-DB-SC 1,058 EN-DB-DC 1,118 EN-MD 1,233 PT-DB 915 FD 611
Mortise: Accurate 9503 Deadlock. Std Door Thickness: 1.75". Std Backsets: 2.5" or 2.75" Baton Tubular Latch & Deadbolt. Std Door Thickness: 1.75". Std Backsets 2 3/8" or 2.75"			
<b>Modern Deadbolt Only</b> (Tubular or Mortise) <b>BE687-BE688</b>		NO INLAY OPTION	EN-DB-SC 343 EN-DB-DC 403 PT-DB 199 EN-MD 517
Mortise: Accurate 9503 Deadlock. Std Door Thickness: 1.75". Std Backsets: 2.5" or 2.75" Tubular: Baton Tubular Deadbolt. Std Door Thickness: 1.75". Std Backsets 2 3/8" or 2.75"			
<b>AMORA ROYALE Multipoint Hardware</b> <b>BE733N-BLR108</b>		WITH INLAY	EN-EURO 1,288 PT-EURO 1,229 PP 1,031 AD 1,009 FD 987
<b>BE733N-BL108 (w/out Inlay)</b> (w/out inlay: any lever or knob)		WITHOUT INLAY	EN-EURO 1,067 PT-EURO 1,010 PP 811 AD 789 FD 767
Available for most door makes (except Andersen). See Multipoint Spec Sheets for available configurations and functions Must send Multipoint order form along with order			
<b>AMORA ROYALE Passage/ Privacy/ Dummy</b> (Tubular) <b>BE732-BLR108</b>		WITH INLAY	PP-TL 783 PR-TL 806 FD 679 SD 339
<b>BE732-BL108 (w/out Inlay)</b> (w/out inlay: any lever or knob)		WITHOUT INLAY	PP-TL 715 PR-TL 739 FD 611 SD 306
Baton Tubular Latch. Std Door Thickness: 1.75". Std Backsets: 2 3/8" or 2.75"			

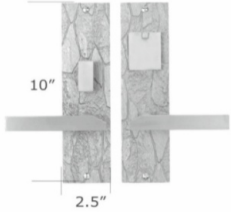
HARDWARE RENAISSANCE		FUNCTION	LIST PRICE \$
<b>BRONZE AMORA ROYALE COLLECTION (OPTIONAL stone inlay)</b>			
<b>Modern Privacy Bolt</b> (Tubular: Add to Passage Set) <b>BE687-PMB</b>		NO INLAY OPTION	PMB 236
Baton Privacy Bolt. Std Door Thickness: 1.75". Std Backsets: 2 3/8" or 2.75"			
<b>AMORA ROYALE Passage/ Privacy/ Dummy</b> (Tubular or Mortise) <b>BE733-BLR108</b>		WITH INLAY	PP-TL 1,148 PR-TL 1,172 PR-PMB 1,334 PP-ML 1,427 PR-ML 1,674 FD 1,036 SD 519
<b>BE733-BL108 (w/out Inlay)</b> (w/out inlay: any lever or knob)		WITHOUT INLAY	PP-TL 917 PR-TL 940 PR-PMB 1,102 PP-ML 1,196 PR-ML 1,442 FD 805 SD 403
Mortise: Accurate 9100 lock. Std Door Thickness: 1.75". Std Backsets: 2.5" or 2.75"			
Baton Tubular Latch & Privacy Bolt. Std Door Thickness: 1.75". Std Backsets: 2 3/8" or 2.75"			

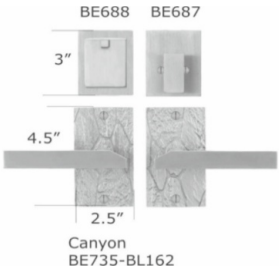
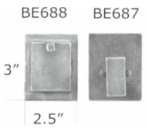
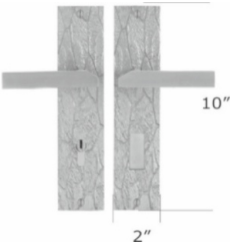
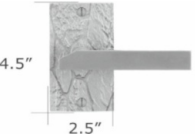
HARDWARE RENAISSANCE		FUNCTION	LIST PRICE \$
<b>BRONZE CANYON COLLECTION</b>			
DRAMATIC TEXTURE INSPIRED BY NATURE			
<p><b>CANYON Thumbblatch x Lever Entry</b> (Mortise Only) <b>BH467- BE736-BL162</b></p>  <p style="text-align: center;">BH467 Canyon</p>	EN-ML FD	2,692 1,905	
See Page 5 for choice of Mortise Lock functions. Std Door Thickness: 1.75". Std Backsets: 2.5" or 2.75"			
<p><b>CANYON Thumbblatch x Thumbblatch Entry</b> (Mortise Only) <b>BH467-BH467</b></p>  <p style="text-align: center;">BH467 Canyon</p>	EN-ML FD	3,008 2,256	
See Page 5 for choice of Mortise Lock functions. Std Door Thickness: 1.75". Std Backsets: 2.5" or 2.75"			
<p><b>CANYON Lever x Lever Entry</b> (Mortise Only) <b>BE736-BL162</b></p>  <p style="text-align: center;">Canyon BE736-BL162</p>	EN-ML PT-ML FD	1,716 1,630 805	
See Page 5 for choice of Mortise Lock functions. Std Door Thickness: 1.75". Std Backsets: 2.5" or 2.75"			

HARDWARE RENAISSANCE	FUNCTION	LIST PRICE \$
<b>BRONZE CANYON COLLECTION</b>		
<p><b>CANYON Sectional Lever x Lever Entry</b> (Tubular) <b>BE735-BL162</b> with BE687-BE688 deadbolt</p>  <p>Mortise: Accurate 9503 Deadlock. Std Door Thickness: 1.75". Std Backsets: 2.5" or 2.75" Baton Tubular Latch &amp; Deadbolt. Std Door Thickness: 1.75". Std Backsets 2 3/8" or 2.75"</p>	EN-DB-SC 1,058 EN-DB-DC 1,118 EN-MD 1,233 PT-DB 915 FD 611	
<p><b>Modern Deadbolt Only</b> (Tubular or Mortise) <b>BE687-BE688</b></p>  <p>Mortise: Accurate 9503 Deadlock. Std Door Thickness: 1.75". Std Backsets: 2.5" or 2.75" Tubular: Baton Tubular Deadbolt. Std Door Thickness: 1.75". Std Backsets 2 3/8" or 2.75"</p>	EN-DB-SC 343 EN-DB-DC 403 PT-DB 199 EN-MD 517	
<p><b>CANYON Multipoint Hardware</b> <b>BE736N-BL162</b></p>  <p>Available for most door makes (except Andersen). See Multipoint Spec Sheets for available configurations and functions Must send Multipoint order form along with order</p>	EN-EURO 1,067 PT-EURO 1,010 PP 811 AD 789 FD 767	
<p><b>CANYON Passage/ Privacy/ Dummy</b> (Tubular) <b>BE735-BL162</b></p>  <p>Baton Tubular Latch. Std Door Thickness: 1.75". Std Backsets: 2 3/8" or 2.75"</p>	PP-TL 715 PR-TL 739 FD 611 SD 306	

HARDWARE RENAISSANCE	FUNCTION	LIST PRICE \$
<b>BRONZE CANYON COLLECTION</b>		
<p><b>Modern Privacy Bolt</b> (Tubular: Add to Passage Set) <b>BE687-PMB</b></p> <div style="display: flex; justify-content: space-around; align-items: center;"> <div style="text-align: center;">  <p>0.75" PMB-CO2</p> </div> <div style="text-align: center;">  <p>3" 2.5" BE687</p> </div> </div> <p>Baton Privacy Bolt. Std Door Thickness: 1.75". Std Backsets: 2 3/8" or 2.75"</p>	PMB	236
<p><b>CANYON Passage/ Privacy/ Dummy</b> (Tubular or Mortise) <b>BE736-BL162</b></p> <div style="text-align: center;">  <p>10" 2.5"</p> </div> <p>Mortise: Accurate 9100 lock. Std Door Thickness: 1.75". Std Backsets: 2.5" or 2.75" Baton Tubular Latch &amp; Privacy Bolt. Std Door Thickness: 1.75". Std Backsets: 2 3/8" or 2.75"</p>	PP-TL PR-TL PR-PMB PP-ML PR-ML FD SD	917 940 1,102 1,196 1,442 806 403

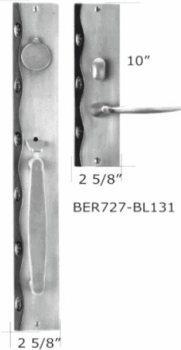
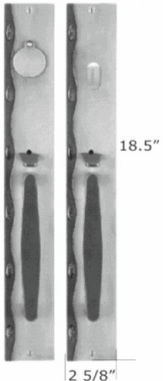
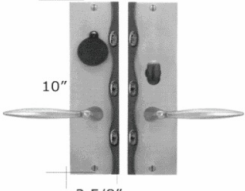
HARDWARE RENAISSANCE		FUNCTION	LIST PRICE \$
<b>BRONZE CAYMAN ROYALE COLLECTION (OPTIONAL stone inlay)</b>			
UNDULATING WAVES DESIGN WITH OPTIONAL BLUE CHRYSOCOLA (BC) OR RED JADE (JR) STONE INLAY  SPECIFY WITH OR WITHOUT INLAY. IF WITH INLAY, SPECIFY TRIM FINISH AND INLAY STONE FINISHES: SINGLE FINISH, OR OPTIONAL (UPCHARGED) DUAL FINISH AS SHOWN Dual Finish options: NW/MW or BB/MG			
<b>CAYMAN ROYALE Thumblatch x Lever Entry</b> (Mortise Only) <b>BHR464 - BER727-BL131</b>  <b>BH464 - BE727-BL131 (w/out Inlay)</b>	 <p>BHR464 Cayman Royale (w/optional semi-precious stone inlay)</p>	WITH INLAY  WITHOUT INLAY	EN-ML FD 3,171 2,474  EN-ML FD 2,692 1,905
See Page 5 for choice of Mortise Lock functions. Std Door Thickness: 1.75". Std Backsets: 2.5" or 2.75"			
<b>CAYMAN ROYALE Thumblatch x Thumblatch Entry</b> (Mortise Only) <b>BHR464-BHR464</b>  <b>BH464-BH464 (w/out Inlay)</b>	 <p>BHR464 Cayman Royale (w/optional semi-precious stone inlay)</p>	WITH INLAY  WITHOUT INLAY	EN-ML FD 3,532 2,800  EN-ML FD 3,008 2,256
See Page 5 for choice of Mortise Lock functions. Std Door Thickness: 1.75". Std Backsets: 2.5" or 2.75"			
<b>CAYMAN ROYALE Lever x Lever Entry</b> (Mortise Only) <b>BER727-BL131</b>  <b>BE727-BL131 (w/out Inlay)</b>	 <p>Cayman Royale w/optional semi-precious stone inlay BER727-BL131</p>	WITH INLAY  WITHOUT INLAY	EN-ML PT-ML FD 1,887 1,801 1,036  EN-ML PT-ML FD 1,716 1,630 805
See Page 5 for choice of Mortise Lock functions. Std Door Thickness: 1.75". Std Backsets: 2.5" or 2.75"			

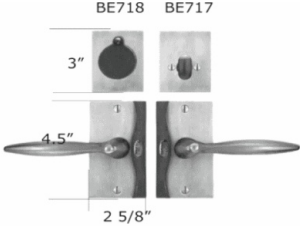
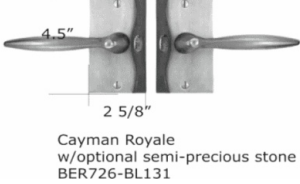
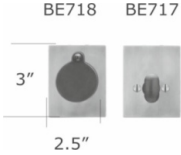
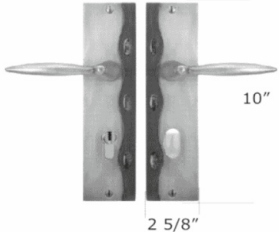
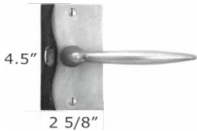

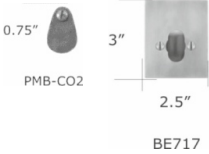
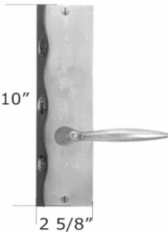
HARDWARE RENAISSANCE			FUNCTION	LIST PRICE \$
<b>BRONZE CAYMAN ROYALE COLLECTION (OPTIONAL stone inlay)</b>				
<b>CAYMAN ROYALE Sectional Lever x Lever Entry</b> (Tubular) <b>BER726-BL131</b> with BE717-BE718 deadbolt		WITH INLAY	EN-DB-SC 1,125 EN-DB-DC 1,185 EN-MD 1,300 PT-DB 982 FD 678	
<b>BE726-BL131 (w/out Inlay)</b>	 <p>Cayman Royale w/optional semi-precious stone inlay BER726-BL131</p>	WITHOUT INLAY	EN-DB-SC 1,058 EN-DB-DC 1,118 EN-MD 1,233 PT-DB 915 FD 611	
Mortise: Accurate 9503 Deadlock. Std Door Thickness: 1.75". Std Backsets: 2.5" or 2.75" Baton Tubular Latch & Deadbolt. Std Door Thickness: 1.75". Std Backsets 2 3/8" or 2.75"				
<b>Modern Deadbolt Only</b> (Tubular or Mortise) <b>BE717-BE718</b>		NO INLAY OPTION	EN-DB-SC 343 EN-DB-DC 403 PT-DB 199 EN-MD 517	
Mortise: Accurate 9503 Deadlock. Std Door Thickness: 1.75". Std Backsets: 2.5" or 2.75" Tubular: Baton Tubular Deadbolt. Std Door Thickness: 1.75". Std Backsets 2 3/8" or 2.75"				
<b>CAYMAN ROYALE Multipoint Hardware</b> <b>BER727-BL131</b>		WITH INLAY	EN-EURO 1,288 PT-EURO 1,229 PP 1,031 AD 1,009 FD 987	
<b>BE727-BL131 (w/out Inlay)</b>		WITHOUT INLAY	EN-EURO 1,067 PT-EURO 1,010 PP 811 AD 789 FD 767	
Available for most door makes (except Andersen). See Multipoint Spec Sheets for available configurations and functions Must send Multipoint order form along with order				
<b>CAYMAN ROYALE Passage/ Privacy/ Dummy</b> (Tubular) <b>BER726-BL131</b>		WITH INLAY	PP-TL 783 PR-TL 806 FD 678 SD 339	
<b>BE726-BL131 (w/out Inlay)</b>		WITHOUT INLAY	PP-TL 715 PR-TL 739 FD 611 SD 306	
Baton Tubular Latch. Std Door Thickness: 1.75". Std Backsets: 2 3/8" or 2.75"				

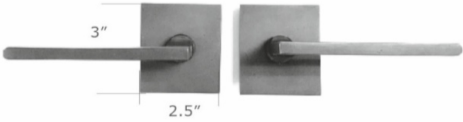
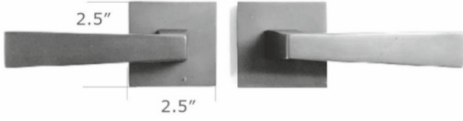
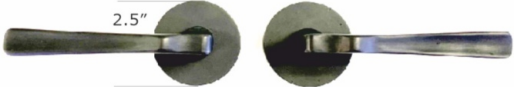
HARDWARE RENAISSANCE		FUNCTION	LIST PRICE \$
<b>BRONZE CAYMAN ROYALE COLLECTION (OPTIONAL stone inlay)</b>			
<p><b>Cayman Privacy Bolt</b> (Tubular: Add to Passage Set) <b>BE717-PMB</b></p> 	NO INLAY OPTION	PMB	236
Baton Privacy Bolt. Std Door Thickness: 1.75". Std Backsets: 2 3/8" or 2.75"			
<p><b>CAYMAN ROYALE Passage/ Privacy/ Dummy</b> (Tubular or Mortise) <b>BER727-BL131</b></p> 	WITH INLAY	PP-TL PR-TL PR-PMB PP-ML PR-ML FD SD	1,148 1,172 1,334 1,427 1,674 1,036 519
<b>BE727-BL131 (w/out Inlay)</b>	WITHOUT INLAY	PP-TL PR-TL PR-PMB PP-ML PR-ML FD SD	917 940 1,102 1,196 1,442 805 403
Mortise: Accurate 9100 lock. Std Door Thickness: 1.75". Std Backsets: 2.5" or 2.75" Baton Tubular Latch & Privacy Bolt. Std Door Thickness: 1.75". Std Backsets: 2 3/8" or 2.75"			

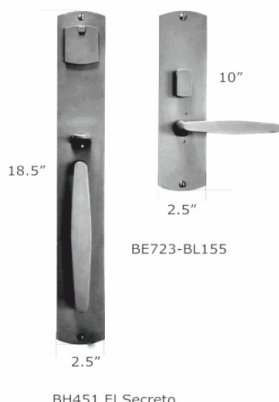
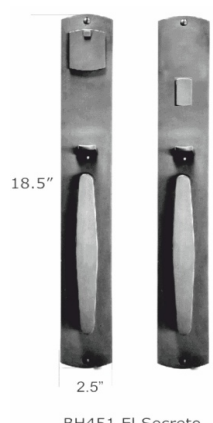
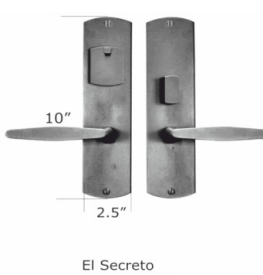
HARDWARE RENAISSANCE	FUNCTION	LIST PRICE \$
<b>BRONZE CONCEALED-SCREW ESCUTCHEONS COLLECTION</b>		
<p><b>NO VISIBLE SCREW EITHER SIDE</b>  <b>AVAILABLE WITH ANY LEVER OR KNOB</b>  <b>AVAILABLE FOR TUBULAR LATCH PASSAGE, PRIVACY, OR DUMMY SETS</b>  <b>NOTE: These have a custom install and will not work with pre-bored doors</b></p>		
<p><b>RECTANGULAR CONCEALED-SCREW ESCUTCHEON</b>  (Tubular)  <b>BE801</b></p>  <p style="text-align: center;">BE801 Rectangular Concealed</p> <p>NOT FOR PRE-BORED DOORS!  Backplate has 9/16" projection</p> <p>Baton Tubular Latch. Std Door Thickness: 1.75". Std Backsets 2 3/8" or 2.75"</p>	PP-TL PR-TL FD SD	572 590 452 226
<p><b>SQUARE CONCEALED-SCREW ESCUTCHEON</b>  (Tubular)  <b>BE802</b></p>  <p style="text-align: center;">BE802 Square Concealed</p> <p>NOT FOR PRE-BORED DOORS!  Backplate has 9/16" projection</p> <p>Baton Tubular Latch. Std Door Thickness: 1.75". Std Backsets 2 3/8" or 2.75"</p>	PP-TL PR-TL FD SD	572 590 452 226
<p><b>ROUND CONCEALED-SCREW ESCUTCHEON</b>  (Tubular)  <b>BE803</b></p>  <p style="text-align: center;">BE803 Round Concealed</p> <p>NOT FOR PRE-BORED DOORS!  Backplate has 9/16" projection</p> <p>Baton Tubular Latch. Std Door Thickness: 1.75". Std Backsets 2 3/8" or 2.75"</p>	PP-TL PR-TL FD SD	572 590 452 226

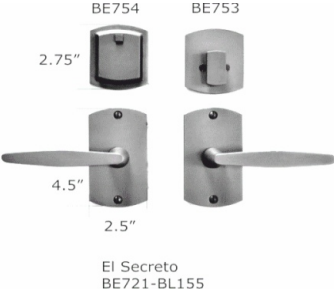
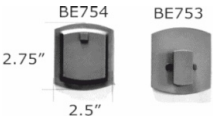
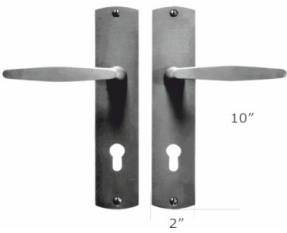
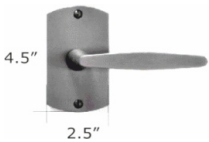
HARDWARE RENAISSANCE	FUNCTION	LIST PRICE \$
<b>BRONZE EL SECRETO COLLECTION</b>		
SLEEK & MODERN CURVES		
<p><b>EL SECRETO Thumbblatch x Lever Entry</b> (Mortise Only) <b>BH451 - BE723-BL155</b></p>  <p style="text-align: center;">BH451 El Secreto</p> <p>See Page 5 for choice of Mortise Lock functions. Std Door Thickness: 1.75". Std Backsets: 2.5" or 2.75"</p>	EN-ML FD	2,196 1,480
<p><b>EL SECRETO Thumbblatch x Thumbblatch Entry</b> (Mortise Only) <b>BH451-BH451</b></p>  <p style="text-align: center;">BH451 El Secreto</p> <p>See Page 5 for choice of Mortise Lock functions. Std Door Thickness: 1.75". Std Backsets: 2.5" or 2.75"</p>	EN-ML FD	2,692 1,962
<p><b>EL SECRETO Lever x Lever Entry</b> (Mortise or Tubular. Tubular is 5.5" c-to-c) <b>BE723-BL155</b></p>  <p style="text-align: center;">El Secreto BE723-BL155</p> <p>See Page 5 for choice of Mortise Lock functions. Std Door Thickness: 1.75". Std Backsets: 2.5" or 2.75" Tubular: Baton Tubular Latch &amp; Deadbolt. Std Door Thickness: 1.75". Std Backsets 2 3/8" or 2.75"</p>	EN-ML PT-ML EN-DB-SC EN-DB-DC PT-DB FD	1,468 1,380 1,003 1,116 984 600

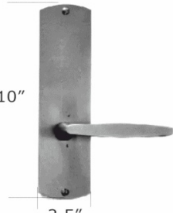

HARDWARE RENAISSANCE		FUNCTION	LIST PRICE \$
<b>BRONZE EL SECRETO COLLECTION</b>			
<p><b>EL SECRETO Sectional Lever x Lever Entry</b> (Tubular) <b>BE721-BL155</b> with BE753-BE754 deadbolt</p>  <p style="text-align: center;">El Secreto BE721-BL155</p> <p>Mortise: Accurate 9503 Deadlock. Std Door Thickness: 1.75". Std Backsets: 2.5" or 2.75" Baton Tubular Latch &amp; Deadbolt. Std Door Thickness: 1.75". Std Backsets 2 3/8" or 2.75"</p>	<p>EN-DB-SC 890 EN-DB-DC 949 EN-MD 1,064 PT-DB 746 FD 430</p>		
<p><b>EL SECRETO Deadbolt Only</b> (Tubular or Mortise) <b>BE753-BE754</b></p>  <p>Mortise: Accurate 9503 Deadlock. Std Door Thickness: 1.75". Std Backsets: 2.5" or 2.75" Tubular: Baton Tubular Deadbolt. Std Door Thickness: 1.75". Std Backsets 2 3/8" or 2.75"</p>	<p>EN-DB-SC 343 EN-DB-DC 403 PT-DB 199 EN-MD 517</p>		
<p><b>EL SECRETO Multipoint Hardware</b> <b>BE722-BL155</b></p>  <p>Available for most door makes (except Andersen). See Multipoint Spec Sheets for available configurations and functions Must send Multipoint order form along with order</p>	<p>EN-US CYL 796 PT-US CYL 734 EN-EURO 915 PT-EURO 854 PP 646 AD 623 FD 600</p>		
<p><b>EL SECRETO Passage/ Privacy/ Dummy</b> (Tubular) <b>BE721-BL155</b></p>  <p>Baton Tubular Latch. Std Door Thickness: 1.75". Std Backsets: 2 3/8" or 2.75"</p>	<p>PP-TL 546 PR-TL 570 FD 430 SD 215</p>		

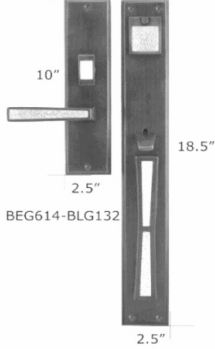
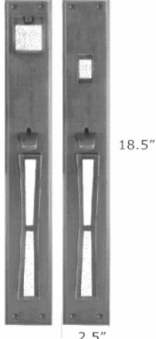
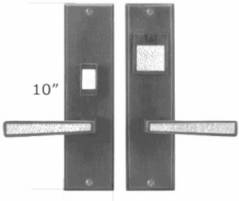
HARDWARE RENAISSANCE	FUNCTION	LIST PRICE \$
<b>BRONZE EL SECRETO COLLECTION</b>		
<p><b>EL SECRETO Privacy Bolt</b> (Tubular: Add to Passage Set) <b>BE753-PMB</b></p> <div style="display: flex; justify-content: space-around; align-items: center;"> <div style="text-align: center;">  <p>0.75"</p> <p>PMB-CO2</p> </div> <div style="text-align: center;">  <p>2.75"</p> <p>2.5"</p> <p>BE753</p> </div> </div> <p>Baton Privacy Bolt. Std Door Thickness: 1.75". Std Backsets: 2 3/8" or 2.75"</p>	PMB	236
<p><b>EL SECRETO Passage/ Privacy/ Dummy</b> (Tubular or Mortise) <b>BE723-BL155</b></p> <div style="text-align: center;">  <p>10"</p> <p>2.5"</p> </div> <p>Mortise: Accurate 9100 lock. Std Door Thickness: 1.75". Std Backsets: 2.5" or 2.75" Baton Tubular Latch &amp; Privacy Bolt. Std Door Thickness: 1.75". Std Backsets: 2 3/8" or 2.75"</p>	PP-TL PR-TL PR-PMB PP-ML PR-ML FD SD	715 739 901 994 1,172 600 300

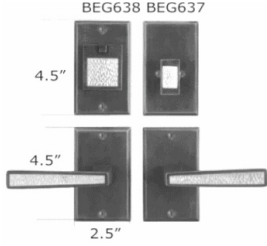
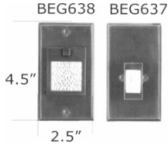
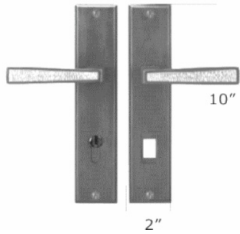
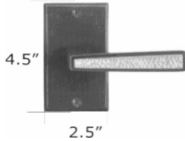
HARDWARE RENAISSANCE	FUNCTION	LIST PRICE \$
<b>BRONZE GRANDE MANHATTAN COLLECTION</b>		
WITH HAND TEXTURED BRONZE INLAY. SPECIFY TRIM FINISH AND INLAY FINISH FROM ANY OF OUR 16 BRONZE PATINAS		
<p><b>GRANDE MANHATTAN Thumbblatch x Lever Entry</b> (Mortise Only) <b>BHG461 - BEG614-BLG132</b></p>  <p style="text-align: center;">BHG461 Grande Manhattan (w/textured bronze inlay)</p> <p>See Page 5 for choice of Mortise Lock functions. Std Door Thickness: 1.75". Std Backsets: 2.5" or 2.75"</p>	EN-ML FD	2,692 1,905
<p><b>GRANDE MANHATTAN Thumbblatch x Thumbblatch Entry</b> (Mortise Only) <b>BHG461-BHG461</b></p>  <p style="text-align: center;">BHG461 Grande Manhattan (w/textured bronze inlay)</p> <p>See Page 5 for choice of Mortise Lock functions. Std Door Thickness: 1.75". Std Backsets: 2.5" or 2.75"</p>	EN-ML FD	3,008 2,256
<p><b>GRANDE MANHATTAN Lever x Lever Entry</b> (Mortise Only) <b>BEG614-BLG132</b></p>  <p style="text-align: center;">Grande Manhattan w/bronze inlay BEG614-BLG132</p> <p>See Page 5 for choice of Mortise Lock functions. Std Door Thickness: 1.75". Std Backsets: 2.5" or 2.75"</p>	EN-ML PT-ML FD	1,716 1,630 805

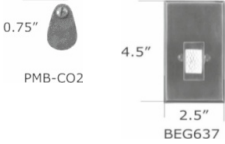
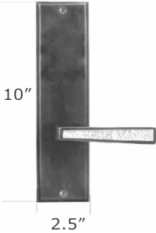
HARDWARE RENAISSANCE		FUNCTION	LIST PRICE \$
<b>BRONZE GRANDE MANHATTAN COLLECTION</b>			
<p><b>GRANDE MANHATTAN Sectional Lever x Lever Entry</b> (Tubular) <b>BE618-BLG132</b> with BEG637-BEG638 deadbolt</p>  <p>Grande Manhattan w/bronze inlay BE618-BLG132</p> <p>Mortise: Accurate 9503 Deadlock. Std Door Thickness: 1.75". Std Backsets: 2.5" or 2.75" Baton Tubular Latch &amp; Deadbolt. Std Door Thickness: 1.75". Std Backsets 2 3/8" or 2.75"</p>	<p>BEG638 BEG637</p> <p>4.5"</p> <p>4.5"</p> <p>2.5"</p>	<p>EN-DB-SC 1,057 EN-DB-DC 1,118 EN-MD 1,231 PT-DB 884 FD 551</p>	
<p><b>GRANDE MANHATTAN Deadbolt Only</b> (Tubular or Mortise) <b>BEG637-BEG638</b></p>  <p>Mortise: Accurate 9503 Deadlock. Std Door Thickness: 1.75". Std Backsets: 2.5" or 2.75" Tubular: Baton Tubular Deadbolt. Std Door Thickness: 1.75". Std Backsets 2 3/8" or 2.75"</p>	<p>BEG638 BEG637</p> <p>4.5"</p> <p>2.5"</p>	<p>EN-DB-SC 403 EN-DB-DC 463 PT-DB 229 EN-MD 577</p>	
<p><b>GRANDE MANHATTAN Multipoint Hardware</b> <b>BEG614N-BLG132</b></p>  <p>Available for most door makes (except Andersen). See Multipoint Spec Sheets for available configurations and functions Must send Multipoint order form along with order</p>	<p>10"</p> <p>2"</p>	<p>EN-US CYL 1,003 PT-US CYL 928 EN-EURO 1,121 PT-EURO 1,060 PP 852 AD 829 FD 806</p>	
<p><b>GRANDE MANHATTAN Passage/ Privacy/ Dummy</b> (Tubular) <b>BE618-BLG132</b></p>  <p>Baton Tubular Latch. Std Door Thickness: 1.75". Std Backsets: 2 3/8" or 2.75"</p>	<p>4.5"</p> <p>2.5"</p>	<p>PP-TL 655 PR-TL 678 FD 551 SD 276</p>	

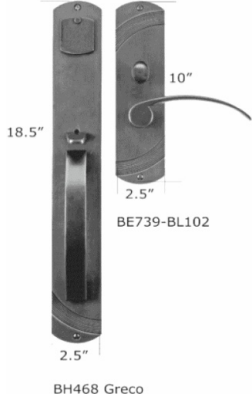
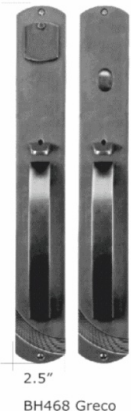
HARDWARE RENAISSANCE	FUNCTION	LIST PRICE \$
<b>BRONZE GRANDE MANHATTAN COLLECTION</b>		
<p><b>GRANDE MANHATTAN Privacy Bolt</b> (Tubular: Add to Passage Set) <b>BEG637-PMB</b></p>  <p>Baton Privacy Bolt. Std Door Thickness: 1.75". Std Backsets: 2 3/8" or 2.75"</p>	PMB	273
<p><b>GRANDE MANHATTAN Passage/ Privacy/ Dummy</b> (Tubular or Mortise) <b>BE614-BLG132</b></p>  <p>Mortise: Accurate 9100 lock. Std Door Thickness: 1.75". Std Backsets: 2.5" or 2.75" Baton Tubular Latch &amp; Privacy Bolt. Std Door Thickness: 1.75". Std Backsets: 2 3/8" or 2.75"</p>	PP-TL PR-TL PR-PMB PP-ML PR-ML FD SD	917 940 1,102 1,196 1,442 805 403

HARDWARE RENAISSANCE		FUNCTION	LIST PRICE \$
<b>BRONZE GRECO COLLECTION</b>			
ELEGANT CURVES & DETAILS			
<p><b>GRECO Thumbblatch x Lever Entry</b> (Mortise Only) <b>BH468 - BE739-BL102</b></p>  <p style="text-align: center;">BH468 Greco</p>	EN-ML FD	2,284 1,539	
See Page 5 for choice of Mortise Lock functions. Std Door Thickness: 1.75". Std Backsets: 2.5" or 2.75"			
<p><b>GRECO Thumbblatch x Thumbblatch Entry</b> (Mortise Only) <b>BH468-BH468</b></p>  <p style="text-align: center;">BH468 Greco</p>	EN-ML FD	2,800 2,041	
See Page 5 for choice of Mortise Lock functions. Std Door Thickness: 1.75". Std Backsets: 2.5" or 2.75"			
<p><b>GRECO Lever x Lever Entry</b> (Mortise Only) <b>BE739-BL102</b></p>  <p style="text-align: center;">Greco BE739-BL102</p>	EN-ML PT-ML FD	1,527 1,435 624	
See Page 5 for choice of Mortise Lock functions. Std Door Thickness: 1.75". Std Backsets: 2.5" or 2.75"			

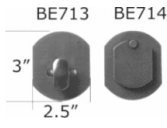
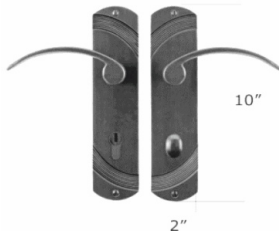
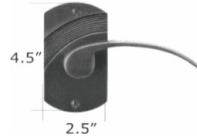
HARDWARE RENAISSANCE		FUNCTION	LIST PRICE \$
<b>BRONZE GRECO COLLECTION</b>			
<p><b>GRECO Sectional Lever x Lever Entry</b> (Tubular) <b>BE738-BL124</b> with BE713-BE714 deadbolt</p>  <p>Mortise: Accurate 9503 Deadlock. Std Door Thickness: 1.75". Std Backsets: 2.5" or 2.75" Baton Tubular Latch &amp; Deadbolt. Std Door Thickness: 1.75". Std Backsets 2 3/8" or 2.75"</p>	<p>EN-DB-SC 908 EN-DB-DC 968 EN-MD 1,083 PT-DB 765 FD 453</p>		
<p><b>GRECO Deadbolt Only</b> (Tubular or Mortise) <b>BE713-BE714</b></p>  <p>Mortise: Accurate 9503 Deadlock. Std Door Thickness: 1.75". Std Backsets: 2.5" or 2.75" Tubular: Baton Tubular Deadbolt. Std Door Thickness: 1.75". Std Backsets 2 3/8" or 2.75"</p>	<p>EN-DB-SC 343 EN-DB-DC 403 PT-DB 199 EN-MD 517</p>		
<p><b>GRECO Multipoint Hardware</b> <b>BE739N-BL102</b></p>  <p>Available for most door makes (except Andersen). See Multipoint Spec Sheets for available configurations and functions Must send Multipoint order form along with order</p>	<p>EN-EURO 961 PT-EURO 897 PP 678 AD 655 FD 631</p>		
<p><b>GRECO Passage/ Privacy/ Dummy</b> (Tubular) <b>BE738-BL124</b></p>  <p>Baton Tubular Latch. Std Door Thickness: 1.75". Std Backsets: 2 3/8" or 2.75"</p>	<p>PP-TL 566 PR-TL 589 FD 451 SD 226</p>		

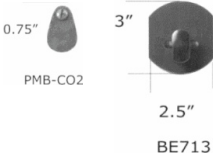
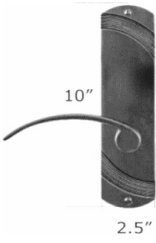
HARDWARE RENAISSANCE	FUNCTION	LIST PRICE \$
<b>BRONZE GRECO COLLECTION</b>		
<p><b>GRECO Privacy Bolt</b> (Tubular: Add to Passage Set) <b>BE713-PMB</b></p>  <p>Baton Privacy Bolt. Std Door Thickness: 1.75". Std Backsets: 2 3/8" or 2.75"</p>	PMB	236
<p><b>GRECO Passage/ Privacy/ Dummy</b> (Tubular or Mortise) <b>BE739-BL102</b></p>  <p>Mortise: Accurate 9100 lock. Std Door Thickness: 1.75". Std Backsets: 2.5" or 2.75" Baton Tubular Latch &amp; Privacy Bolt. Std Door Thickness: 1.75". Std Backsets: 2 3/8" or 2.75"</p>	PP-TL PR-TL PR-PMB PP-ML PR-ML FD SD	741 765 933 1,030 1,214 624 312

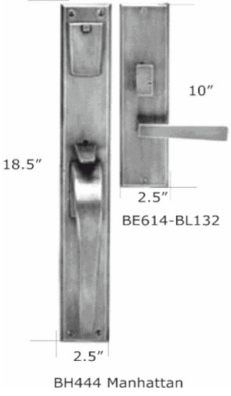
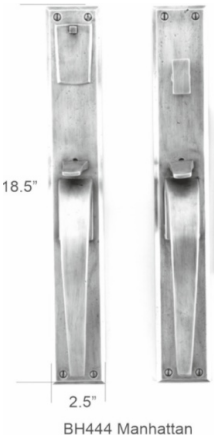
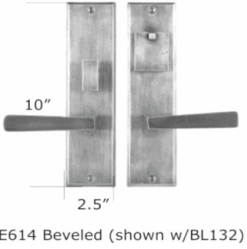
HARDWARE RENAISSANCE		FUNCTION	LIST PRICE \$
<b>BRONZE MANHATTAN COLLECTION</b>			
MODERN DESIGN WITH BEVELED ESCUTCHEONS			
<p><b>MANHATTAN Thumbblatch x Lever Entry</b> (Mortise Only) <b>BH444 - BE614-BL132</b></p>  <p style="text-align: center;">BH444 Manhattan</p>	EN-ML FD	2,196 1,480	
See Page 5 for choice of Mortise Lock functions. Std Door Thickness: 1.75". Std Backsets: 2.5" or 2.75"			
<p><b>MANHATTAN Thumbblatch x Thumbblatch Entry</b> (Mortise Only) <b>BH444-BH444</b></p>  <p style="text-align: center;">BH444 Manhattan</p>	EN-ML FD	2,692 1,962	
See Page 5 for choice of Mortise Lock functions. Std Door Thickness: 1.75". Std Backsets: 2.5" or 2.75"			
<p><b>MANHATTAN Lever x Lever Entry</b> (Mortise or Tubular. Tubular is 5.5" c-to-c) <b>BE614-BL132</b></p>  <p style="text-align: center;">BE614 Beveled (shown w/BL132)</p>	EN-ML PT-ML EN-DB-SC EN-DB-DC PT-DB FD	1,468 1,380 1,003 1,116 984 600	
See Page 5 for choice of Mortise Lock functions. Std Door Thickness: 1.75". Std Backsets: 2.5" or 2.75" Tubular: Baton Tubular Latch & Deadbolt. Std Door Thickness: 1.75". Std Backsets 2 3/8" or 2.75"			

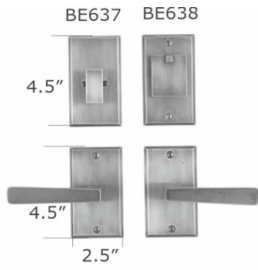
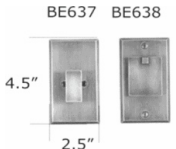
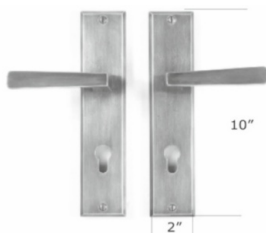
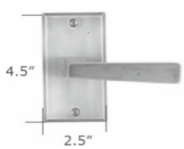
HARDWARE RENAISSANCE		FUNCTION	LIST PRICE \$
<b>BRONZE MANHATTAN COLLECTION</b>			
<p><b>MANHATTAN Sectional Lever x Lever Entry</b> (Tubular) <b>BE618-BL132</b> with BE637-BE638 deadbolt</p>  <p>BE618 Beveled w/ BL132</p> <p>Mortise: Accurate 9503 Deadlock. Std Door Thickness: 1.75". Std Backsets: 2.5" or 2.75" Baton Tubular Latch &amp; Deadbolt. Std Door Thickness: 1.75". Std Backsets 2 3/8" or 2.75"</p>	<p>EN-DB-SC 890 EN-DB-DC 949 EN-MD 1,064 PT-DB 746 FD 430</p>		
<p><b>MANHATTAN Deadbolt Only</b> (Tubular or Mortise) <b>BE637-BE638</b></p>  <p>Mortise: Accurate 9503 Deadlock. Std Door Thickness: 1.75". Std Backsets: 2.5" or 2.75" Tubular: Baton Tubular Deadbolt. Std Door Thickness: 1.75". Std Backsets 2 3/8" or 2.75"</p>	<p>EN-DB-SC 343 EN-DB-DC 403 PT-DB 199 EN-MD 517</p>		
<p><b>MANHATTAN Multipoint Hardware</b> <b>BE614N-BL132</b></p>  <p>Available for most door makes (except Andersen). See Multipoint Spec Sheets for available configurations and functions Must send Multipoint order form along with order</p>	<p>EN-US CYL. 796 PT-US CYL. 734 EN-EURO 915 PT-EURO 854 PP 646 AD 623 FD 600</p>		
<p><b>MANHATTAN Passage/ Privacy/ Dummy</b> (Tubular) <b>BE618-BL132</b></p>  <p>Baton Tubular Latch. Std Door Thickness: 1.75". Std Backsets: 2 3/8" or 2.75"</p>	<p>PP-TL 546 PR-TL 570 FD 430 SD 215</p>		

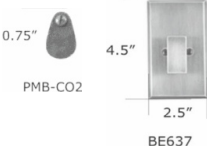
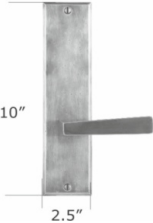

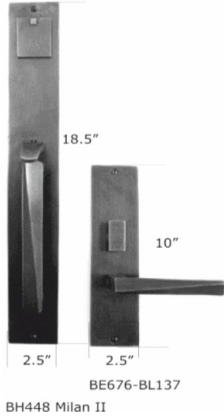
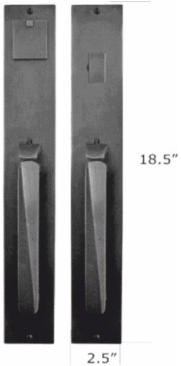
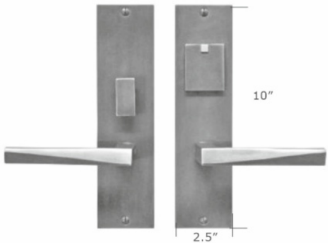
HARDWARE RENAISSANCE	FUNCTION	LIST PRICE \$
<b>BRONZE MANHATTAN COLLECTION</b>		
<p><b>MANHATTAN Privacy Bolt</b> (Tubular: Add to Passage Set) <b>BE637-PMB</b></p>  <p>Baton Privacy Bolt. Std Door Thickness: 1.75". Std Backsets: 2 3/8" or 2.75"</p>	PMB	236
<p><b>MANHATTAN Passage/ Privacy/ Dummy</b> (Tubular or Mortise) <b>BE614-BL132</b></p>  <p>Mortise: Accurate 9100 lock. Std Door Thickness: 1.75". Std Backsets: 2.5" or 2.75" Baton Tubular Latch &amp; Privacy Bolt. Std Door Thickness: 1.75". Std Backsets: 2 3/8" or 2.75"</p>	PP-TL PR-TL PR-PMB PP-ML PR-ML FD SD	715 739 901 994 1,172 600 300

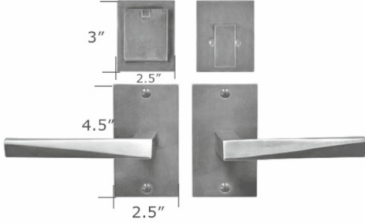
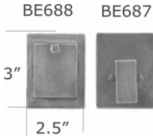
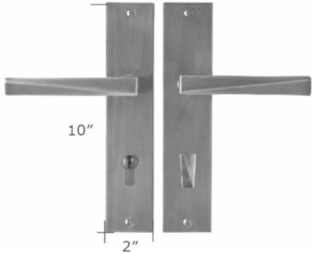
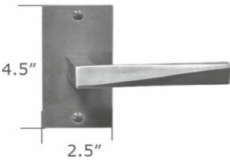

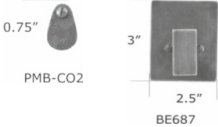
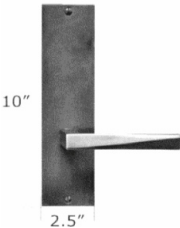
HARDWARE RENAISSANCE		FUNCTION	LIST PRICE \$
<b>BRONZE MILAN COLLECTION</b>			
MODERN, LINEAR DESIGN WITH STRAIGHT EDGE ESCUTCHEONS			
<p><b>MILAN II Thumbblatch x Lever Entry</b> (Mortise Only) <b>BH448 - BE676-BL137</b></p>  <p style="text-align: center;">BH448 Milan II</p>	EN-ML FD	2,196 1,480	
See Page 5 for choice of Mortise Lock functions. Std Door Thickness: 1.75". Std Backsets: 2.5" or 2.75"			
<p><b>MILAN II Thumbblatch x Thumbblatch Entry</b> (Mortise Only) <b>BH448-BH448</b></p>  <p style="text-align: center;">BH448 Milan II</p>	EN-ML FD	2,692 1,962	
See Page 5 for choice of Mortise Lock functions. Std Door Thickness: 1.75". Std Backsets: 2.5" or 2.75"			
<p><b>MILAN Lever x Lever Entry</b> (Mortise or Tubular. Tubular is 5.5" c-to-c) <b>BE676-BL137</b></p>  <p style="text-align: center;">BE676 Straight Edge (shown w/BL137)</p>	EN-ML PT-ML EN-DB-SC EN-DB-DC PT-DB FD	1,468 1,380 1,003 1,116 984 600	
See Page 5 for choice of Mortise Lock functions. Std Door Thickness: 1.75". Std Backsets: 2.5" or 2.75" Tubular: Baton Tubular Latch & Deadbolt. Std Door Thickness: 1.75". Std Backsets 2 3/8" or 2.75"			

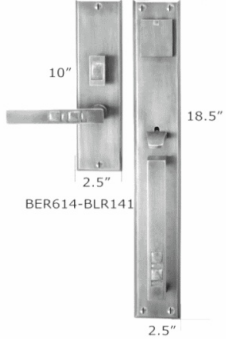
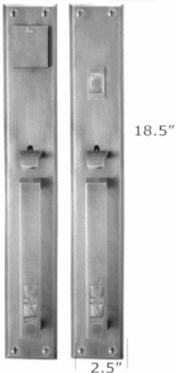
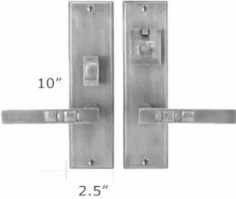
HARDWARE RENAISSANCE		FUNCTION	LIST PRICE \$
<b>BRONZE MILAN COLLECTION</b>			
<p><b>MILAN Sectional Lever x Lever Entry</b> (Tubular) <b>BE675-BL137</b> with BE687-BE688 deadbolt</p>  <p style="text-align: center;">BE675 Straight Edge w/ BL137</p> <p>Mortise: Accurate 9503 Deadlock. Std Door Thickness: 1.75". Std Backsets: 2.5" or 2.75" Baton Tubular Latch &amp; Deadbolt. Std Door Thickness: 1.75". Std Backsets 2 3/8" or 2.75"</p>	<p>EN-DB-SC 890 EN-DB-DC 949 EN-MD 1,064 PT-DB 746 FD 430</p>		
<p><b>Modern Deadbolt Only</b> (Tubular or Mortise) <b>BE687-BE688</b></p>  <p>Mortise: Accurate 9503 Deadlock. Std Door Thickness: 1.75". Std Backsets: 2.5" or 2.75" Tubular: Baton Tubular Deadbolt. Std Door Thickness: 1.75". Std Backsets 2 3/8" or 2.75"</p>	<p>EN-DB-SC 343 EN-DB-DC 403 PT-DB 199 EN-MD 517</p>		
<p><b>MILAN Multipoint Hardware</b> <b>BE672-BL137</b></p>  <p>Available for most door makes (except Andersen). See Multipoint Spec Sheets for available configurations and functions Must send Multipoint order form along with order</p>	<p>EN-US CYL 796 PT-US CYL 734 EN-EURO 915 PT-EURO 854 PP 646 AD 623 FD 600</p>		
<p><b>MILAN Passage/ Privacy/ Dummy</b> (Tubular) <b>BE675-BL137</b></p>  <p>Baton Tubular Latch. Std Door Thickness: 1.75". Std Backsets: 2 3/8" or 2.75"</p>	<p>PP-TL 546 PR-TL 570 FD 430 SD 215</p>		

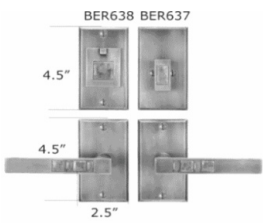
HARDWARE RENAISSANCE	FUNCTION	LIST PRICE \$
<b>BRONZE MILAN COLLECTION</b>		
<p><b>Modern Privacy Bolt</b> (Tubular: Add to Passage Set) <b>BE687-PMB</b></p>  <p>Baton Privacy Bolt. Std Door Thickness: 1.75". Std Backsets: 2 3/8" or 2.75"</p>	PMB	236
<p><b>MILAN Passage/ Privacy/ Dummy</b> (Tubular or Mortise) <b>BE676-BL137</b></p>  <p>Mortise: Accurate 9100 lock. Std Door Thickness: 1.75". Std Backsets: 2.5" or 2.75" Baton Tubular Latch &amp; Privacy Bolt. Std Door Thickness: 1.75". Std Backsets: 2 3/8" or 2.75"</p>	PP-TL PR-TL PR-PMB PP-ML PR-ML FD SD	715 739 901 994 1,172 600 300

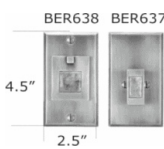
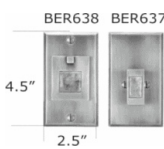
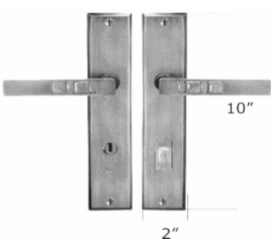
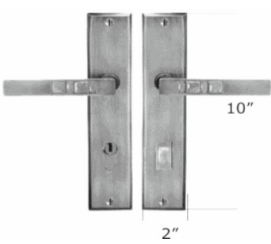
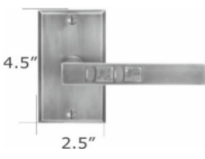
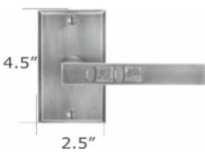

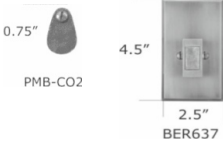
HARDWARE RENAISSANCE		FUNCTION	LIST PRICE \$
<b>BRONZE SCOTTSDALE ROYALE COLLECTION (OPTIONAL stone inlay)</b>			
MODERN DESIGN WITH BEVELED ESCUTCHEONS AND SEMI-PRECIOUS STONE INLAY AVAILABLE IN THREE COMBINATIONS: TURQUOISE & DARK ROTILE (TDR), GREEN & YELLOW OPAL (OGY), OR RED JADE & PANTHER JASPER (JRP)			
SPECIFY WITH OR WITHOUT INLAY. IF WITH INLAY, SPECIFY TRIM FINISH AND INLAY STONE			
<b>SCOTTSDALE ROYALE Thumbblatch x Lever Entry</b> (Mortise Only) <b>BHR462 - BER614-BLR141</b>  <b>BH462 - BE614-BL141 (w/out Inlay)</b>	 <p>BHR462 Scottsdale Royale (w/optional semi-precious stone inlay)</p>	WITH INLAY EN-ML 2,906 FD 2,057  WITHOUT INLAY EN-ML 2,196 FD 1,480	
See Page 5 for choice of Mortise Lock functions. Std Door Thickness: 1.75". Std Backsets: 2.5" or 2.75"			
<b>SCOTTSDALE ROYALE Thumbblatch x Thumbblatch Entry</b> (Mortise Only) <b>BHR462-BHR462</b>  <b>BH462-BH462 (w/out Inlay)</b>	 <p>BHR462 Scottsdale Royale (w/optional semi-precious stone inlay)</p>	WITH INLAY EN-ML 3,217 FD 2,509  WITHOUT INLAY EN-ML 2,692 FD 1,962	
See Page 5 for choice of Mortise Lock functions. Std Door Thickness: 1.75". Std Backsets: 2.5" or 2.75"			
<b>SCOTTSDALE ROYALE Lever x Lever Entry</b> (Mortise Only) <b>BER614-BLR141</b>  <b>BE614-BL141 (w/out Inlay)</b>	 <p>Scottsdale Royale w/optional semi-precious stone inlay BER614-BLR141</p>	WITH INLAY EN-ML 1,887 PT-ML 1,801 FD 1,036  WITHOUT INLAY EN-ML 1,468 PT-ML 1,380 FD 600	
See Page 5 for choice of Mortise Lock functions. Std Door Thickness: 1.75". Std Backsets: 2.5" or 2.75"			

HARDWARE RENAISSANCE		FUNCTION	LIST PRICE \$
<b>BRONZE SCOTTSDALE ROYALE COLLECTION (OPTIONAL stone inlay)</b>			
<b>SCOTTSDALE ROYALE Sectional Lever x Lever Entry</b> (Tubular) <b>BE618-BLR141</b> with BER637-BER638 deadbolt		WITH INLAY	EN-DB-SC 1,299 EN-DB-DC 1,359 EN-MD 1,473 PT-DB 1,065 FD 678
<b>BE618-BL141 (w/out Inlay)</b> with BE637-BE638 deadbolt	 <p>Scottsdale Royale w/semi-precious stone inlay BE618-BLR141</p>	WITHOUT INLAY	EN-DB-SC 890 EN-DB-DC 949 EN-MD 1,064 PT-DB 746 FD 430
Mortise: Accurate 9503 Deadlock. Std Door Thickness: 1.75". Std Backsets: 2.5" or 2.75" Baton Tubular Latch & Deadbolt. Std Door Thickness: 1.75". Std Backsets 2 3/8" or 2.75"			
<b>SCOTTSDALE ROYALE Deadbolt Only</b> (Tubular or Mortise) <b>BER637-BER638</b>		WITH INLAY	EN-DB-SC 516 EN-DB-DC 576 PT-DB 282 EN-MD 690
<b>BE637-BE638 (w/out Inlay)</b>		WITHOUT INLAY	EN-DB-SC 343 EN-DB-DC 403 PT-DB 199 EN-MD 517
Mortise: Accurate 9503 Deadlock. Std Door Thickness: 1.75". Std Backsets: 2.5" or 2.75" Tubular: Baton Tubular Deadbolt. Std Door Thickness: 1.75". Std Backsets 2 3/8" or 2.75"			
<b>SCOTTSDALE ROYALE Multipoint Hardware</b> <b>BER614N-BLR141</b>		WITH INLAY	EN-US CYL 1,233 PT-US CYL 1,171 EN-EURO 1,353 PT-EURO 1,291 PP 1,283 AD 1,060 FD 1,037
<b>BE614N-BL141 (w/out Inlay)</b>		WITHOUT INLAY	EN-US CYL 796 PT-US CYL 734 EN-EURO 915 PT-EURO 854 PP 646 AD 623 FD 600
Available for most door makes (except Andersen). See Multipoint Spec Sheets for available configurations and functions Must send Multipoint order form along with order			
<b>SCOTTSDALE ROYALE Passage/ Privacy/ Dummy</b> (Tubular) <b>BE618-BLR141</b>		WITH INLAY	PP-TL 783 PR-TL 806 FD 678 SD 336
<b>BE618-BL141 (w/out Inlay)</b>		WITHOUT INLAY	PP-TL 546 PR-TL 570 FD 430 SD 215
Baton Tubular Latch. Std Door Thickness: 1.75". Std Backsets: 2 3/8" or 2.75"			

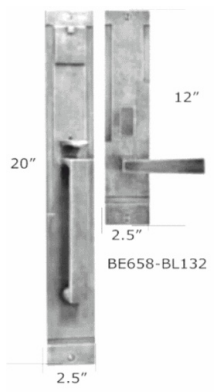
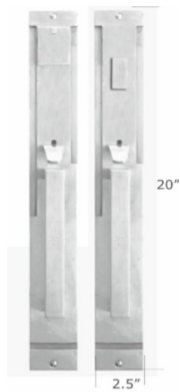
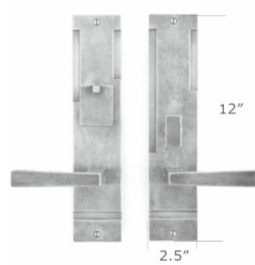
HARDWARE RENAISSANCE		FUNCTION	LIST PRICE \$
<b>BRONZE SCOTTSDALE ROYALE COLLECTION (OPTIONAL stone inlay)</b>			
<b>SCOTTSDALE ROYALE Privacy Bolt</b> (Tubular: Add to Passage Set) <b>BER637-PMB</b>  <b>BE637-PMB (w/out Inlay)</b>		WITH INLAY	PMB 306
		WITHOUT INLAY	PMB 236
Baton Privacy Bolt. Std Door Thickness: 1.75". Std Backsets: 2 3/8" or 2.75"			
<b>SCOTTSDALE ROYALE Passage/ Privacy/ Dummy</b> (Tubular or Mortise) <b>BE614-BLR141</b>  <b>BE614-BL141 (w/out Inlay)</b>		WITH INLAY	PP-TL 1,148 PR-TL 1,172 PR-PMB 1,334 PP-ML 1,427 PR-ML 1,674 FD 1,036 SD 519
		WITHOUT INLAY	PP-TL 715 PR-TL 739 PR-PMB 901 PP-ML 994 PR-ML 1,172 FD 600 SD 300
Mortise: Accurate 9100 lock. Std Door Thickness: 1.75". Std Backsets: 2.5" or 2.75" Baton Tubular Latch & Privacy Bolt. Std Door Thickness: 1.75". Std Backsets: 2 3/8" or 2.75"			

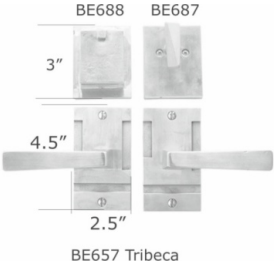
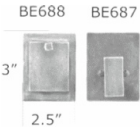
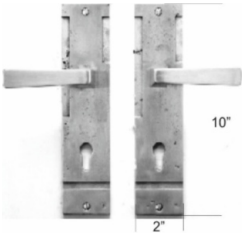
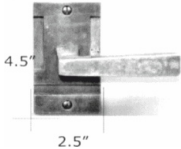
HARDWARE RENAISSANCE		FUNCTION	LIST PRICE \$
<b>BRONZE TRIBECA COLLECTION</b>			
MODERN DESIGN WITH DISTINCTIVE ESCUTCHEON CUT-IN EDGES			
<p><b>TRIBECA Thumbblatch x Lever Entry</b> (Mortise Only) <b>BH449 - BE658-BL132 OR BL141</b></p>  <p style="text-align: center;">BH449 Tribeca</p>	EN-ML FD	2,666 1,887	
See Page 5 for choice of Mortise Lock functions. Std Door Thickness: 1.75". Std Backsets: 2.5" or 2.75"			
<p><b>TRIBECA Thumbblatch x Thumbblatch Entry</b> (Mortise Only) <b>BH449-BH449</b></p>  <p style="text-align: center;">BH449 Tribeca</p>	EN-ML FD	3,008 2,256	
See Page 5 for choice of Mortise Lock functions. Std Door Thickness: 1.75". Std Backsets: 2.5" or 2.75"			
<p><b>TRIBECA Lever x Lever Entry</b> (Mortise or Tubular. Tubular is 5.5" c-to-c) <b>BE658-BL132 OR BL141</b></p>  <p style="text-align: center;">BE658 Tribeca (shown w/BL132)</p>	EN-ML PT-ML EN-DB-SC EN-DB-DC PT-DB FD	1,716 1,630 1,300 1,365 1,233 805	
See Page 5 for choice of Mortise Lock functions. Std Door Thickness: 1.75". Std Backsets: 2.5" or 2.75" Tubular: Baton Tubular Latch & Deadbolt. Std Door Thickness: 1.75". Std Backsets 2 3/8" or 2.75"			



HARDWARE RENAISSANCE		FUNCTION	LIST PRICE \$
<b>BRONZE TRIBECA COLLECTION</b>			
<p><b>TRIBECA Sectional Lever x Lever Entry</b> (Tubular) <b>BE657-BL132 OR BL141</b> with BE687-BE688 deadbolt</p>  <p>Mortise: Accurate 9503 Deadlock. Std Door Thickness: 1.75". Std Backsets: 2.5" or 2.75" Baton Tubular Latch &amp; Deadbolt. Std Door Thickness: 1.75". Std Backsets 2 3/8" or 2.75"</p>	<p>EN-DB-SC 975 EN-DB-DC 1,034 EN-MD 1,149 PT-DB 831 FD 529</p>		
<p><b>Modern Deadbolt Only</b> (Tubular or Mortise) <b>BE687-BE688</b></p>  <p>Mortise: Accurate 9503 Deadlock. Std Door Thickness: 1.75". Std Backsets: 2.5" or 2.75" Tubular: Baton Tubular Deadbolt. Std Door Thickness: 1.75". Std Backsets 2 3/8" or 2.75"</p>	<p>EN-DB-SC 343 EN-DB-DC 403 PT-DB 199 EN-MD 517</p>		
<p><b>TRIBECA Multipoint Hardware</b> <b>BE659-BL132 OR BL141</b></p>  <p>Available for most door makes (except Andersen). See Multipoint Spec Sheets for available configurations and functions Must send Multipoint order form along with order</p>	<p>EN-US CYL. 912 PT-US CYL. 850 EN-EURO 1,030 PT-EURO 970 PP 762 AD 739 FD 715</p>		
<p><b>TRIBECA Passage/ Privacy/ Dummy</b> (Tubular) <b>BE657-BL132 OR BL141</b></p>  <p>Baton Tubular Latch. Std Door Thickness: 1.75". Std Backsets: 2 3/8" or 2.75"</p>	<p>PP-TL 632 PR-TL 655 FD 529 SD 265</p>		

HARDWARE RENAISSANCE	FUNCTION	LIST PRICE \$
<b>BRONZE TRIBECA COLLECTION</b>		
<p><b>Modern Privacy Bolt</b> (Tubular: Add to Passage Set) <b>BE687-PMB</b></p> <div style="display: flex; justify-content: space-around; align-items: center;"> <div style="text-align: center;"> <p>0.75"</p>  <p>PMB-CO2</p> </div> <div style="text-align: center;"> <p>3"</p>  <p>2.5"</p> <p>BE687</p> </div> </div> <p>Baton Privacy Bolt. Std Door Thickness: 1.75". Std Backsets: 2 3/8" or 2.75"</p>	PMB	236
<p><b>TRIBECA Passage/ Privacy/ Dummy</b> (Tubular or Mortise) <b>BE658-BL132 OR BL141</b></p> <div style="text-align: center;">  <p>12"</p> <p>2.5"</p> </div> <p>Mortise: Accurate 9100 lock. Std Door Thickness: 1.75". Std Backsets: 2.5" or 2.75" Baton Tubular Latch &amp; Privacy Bolt. Std Door Thickness: 1.75". Std Backsets: 2 3/8" or 2.75"</p>	PP-TL PR-TL PR-PMB PP-ML PR-ML FD SD	917 940 1,102 1,196 1,442 805 403

HARDWARE RENAISSANCE		FUNCTION	LIST PRICE \$
<b>BRONZE ART DECO COLLECTION</b>			
DISTINCTIVE ART DECO INSPIRED KNOB SETS			
<p><b>ART DECO OVAL Knob x Knob Entry</b> (Mortise Only) <b>BE692-BK201</b></p>  <p style="text-align: center;">16" 2.75" BE692 Art Deco w/BK201</p> <p>NOT FOR PRE-BORED DOORS!</p> <p>See Page 5 for choice of Mortise Lock functions. Std Door Thickness: 1.75". Std Backsets: 2.5" or 2.75"</p>	<p>EN-ML 1,887 PT-ML 1,801 FD 1,036</p>		
<p><b>ART DECO CHEVRON Sectional Knob x Knob Entry</b> (Tubular) <b>BE651-BK201</b> with BE711-BE712 deadbolt</p>  <p style="text-align: center;">BE711 BE712 4.5" 4.5" 2.5" BE651 Chevron</p> <p>Mortise: Accurate 9503 Deadlock. Std Door Thickness: 1.75". Std Backsets: 2.5" or 2.75" Baton Tubular Latch &amp; Deadbolt. Std Door Thickness: 1.75". Std Backsets 2 3/8" or 2.75"</p>	<p>EN-DB-SC 1,003 EN-DB-DC 1,069 EN-MD 1,176 PT-DB 866 FD 529</p>		
<p><b>ART DECO CHEVRON Deadbolt Only</b> (Tubular or Mortise) <b>BE711-BE712</b></p>  <p style="text-align: center;">BE711 BE712 4.5" 2.5"</p> <p>Mortise: Accurate 9503 Deadlock. Std Door Thickness: 1.75". Std Backsets: 2.5" or 2.75" Tubular: Baton Tubular Deadbolt. Std Door Thickness: 1.75". Std Backsets 2 3/8" or 2.75"</p>	<p>EN-DB-SC 370 EN-DB-DC 438 PT-DB 234 EN-MD 545</p>		

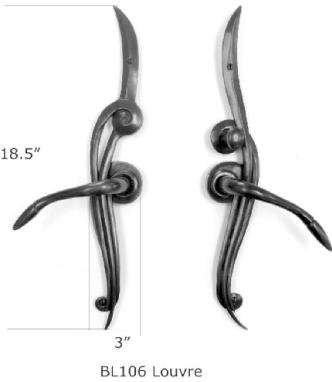

HARDWARE RENAISSANCE		FUNCTION	LIST PRICE \$
<b>BRONZE ART DECO COLLECTION</b>			
<b>ART DECO CHEVRON Multipoint Hardware</b> <b>BE701-BL141 OR BL132</b>		EN-US CYL 796 PT-US CYL 734 EN-EURO 915 PT-EURO 854 PP 646 AD 623 FD 600	
Available for most door makes (except Andersen). See Multipoint Spec Sheets for available configurations and functions. Must send Multipoint order form along with order.			
<b>ART DECO CHEVRON Passage/ Privacy/ Dummy</b> (Tubular) <b>BE651-BK201</b>		PP-TL 632 PR-TL 655 FD 529 SD 265	
Baton Tubular Latch. Std Door Thickness: 1.75". Std Backsets: 2 3/8" or 2.75"			
<b>ART DECO Privacy Bolt</b> (Tubular: Add to Passage Set) <b>BE711-PMB</b>		PMB 271	
Baton Privacy Bolt. Std Door Thickness: 1.75". Std Backsets: 2 3/8" or 2.75"			
<b>ART DECO OVAL Passage/ Dummy</b> (Tubular or Mortise) <b>BE692-BK201</b>		PP-TL 1,162 PR-TL N/A PR-PMB N/A PP-ML 1,547 PR-ML 1,734 FD 1,036 SD 518	
NOT FOR PRE-BORED DOORS!  Mortise: Accurate 9100 lock. Std Door Thickness: 1.75". Std Backsets: 2.5" or 2.75" Baton Tubular Latch & Privacy Bolt. Std Door Thickness: 1.75". Std Backsets: 2 3/8" or 2.75"			

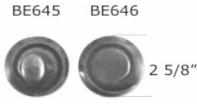

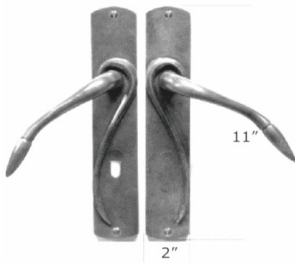
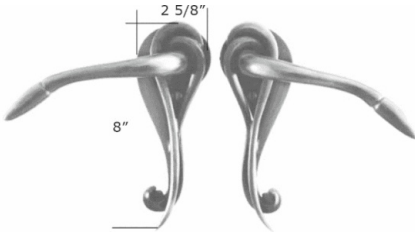
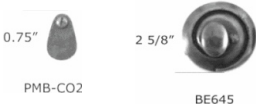
HARDWARE RENAISSANCE		FUNCTION	LIST PRICE \$
<b>BRONZE ART NOUVEAU COLLECTION</b>			
OUR SIGNATURE COLLECTION INSPIRED BY FREE-FLOWING ART NOUVEAU DESIGN			
<p><b>LOUVRE ART NOUVEAU Thumbblatch x Lever Entry</b> (Mortise Only) <b>BH445 - BL106</b></p> <p>NOTE: this design is handed No custom options - available as shown only <b>Extended 10 week lead time</b></p>	<p style="text-align: center;">BH445 Louvre</p>	EN-ML FD	4,044 3,407
NOT FOR PRE-BORED DOORS!			
See Page 5 for choice of Mortise Lock functions. Std Door Thickness: 1.75". Std Backsets: 2.5" or 2.75"			
<p><b>LOUVRE ART NOUVEAU Thumbblatch x Thumbblatch Entry</b> (Mortise Only) <b>BH445-BH445</b></p> <p>NOTE: this design is handed No custom options - available as shown only <b>Extended 10 week lead time</b></p>	<p style="text-align: center;">BH445 Louvre</p>	EN-ML FD	4,735 3,956
NOT FOR PRE-BORED DOORS!			
See Page 5 for choice of Mortise Lock functions. Std Door Thickness: 1.75". Std Backsets: 2.5" or 2.75"			

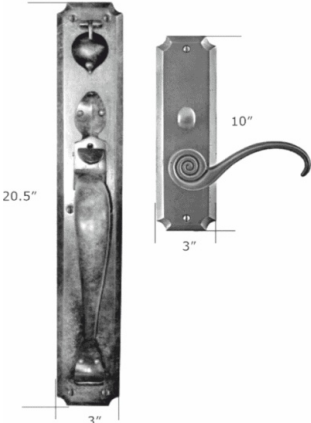
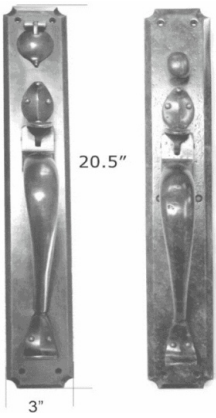
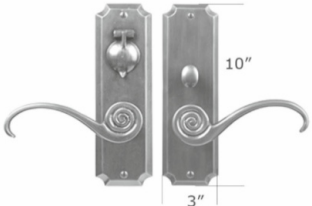

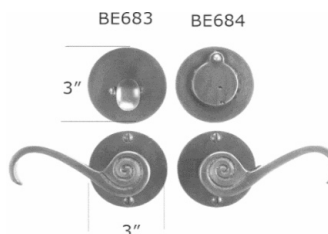

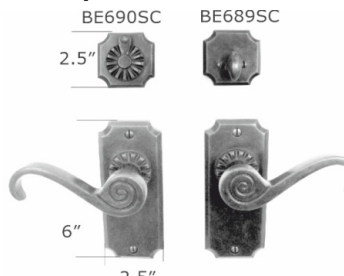
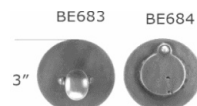
HARDWARE RENAISSANCE		FUNCTION	LIST PRICE \$
<b>BRONZE ART NOUVEAU COLLECTION</b>			
<p><b>LOUVRE ART NOUVEAU Lever x Lever Entry</b> (Mortise Only) <b>BL106</b></p> <p>No custom options - available as shown only <b>Extended 10 week lead time</b></p>  <p style="text-align: center;">BL106 Louvre</p> <p>NOT FOR PRE-BORED DOORS!</p> <p>See Page 5 for choice of Mortise Lock functions. Std Door Thickness: 1.75". Std Backsets: 2.5" or 2.75"</p>	 <p style="text-align: center;">BL104 Art Nouveau</p> <p>NOT FOR PRE-BORED DOORS!</p> <p>Mortise: Accurate 9503 Deadlock. Std Door Thickness: 1.75". Std Backsets: 2.5" or 2.75" Baton Tubular Latch &amp; Deadbolt. Std Door Thickness: 1.75". Std Backsets 2 3/8" or 2.75"</p>	<p>EN-ML 2,564 PT-ML 2,497 FD 1,750</p>	
<p><b>ART NOUVEAU Sectional Lever x Lever Entry</b> (Tubular) <b>BL104</b> with BE645-BE646 deadbolt</p> <p>No custom options - available as shown only <b>Extended 10 week lead time</b></p>	<p>EN-DB-SC 1,229 EN-DB-DC 1,297 EN-MD 1,403 PT-DB 1,093 FD 750</p>		
<p><b>ART NOUVEAU Deadbolt Only</b> (Tubular or Mortise) <b>BE645-BE646</b></p> <p><b>Extended 10 week lead time</b></p> <p>Mortise: Accurate 9503 Deadlock. Std Door Thickness: 1.75". Std Backsets: 2.5" or 2.75" Tubular: Baton Tubular Deadbolt. Std Door Thickness: 1.75". Std Backsets 2 3/8" or 2.75"</p>	 <p style="text-align: center;">BE645 BE646 2 5/8"</p>	<p>EN-DB-SC 370 EN-DB-DC 438 PT-DB 234 EN-MD 545</p>	

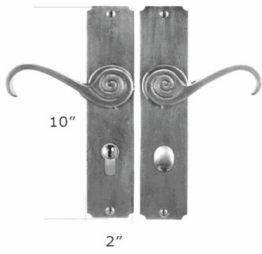
HARDWARE RENAISSANCE		FUNCTION	LIST PRICE \$
<b>BRONZE ART NOUVEAU COLLECTION</b>			
<p><b>ART NOUVEAU Multipoint Hardware</b></p> <p><b>BE698-BL104</b></p> <p>Extended 10 week lead time</p>		EN-US CYL 889 PT-US CYL 827 EN-EURO 959 PT-EURO 898 PP 690 AD 667 FD 644	
Available for most door makes (except Andersen). See Multipoint Spec Sheets for available configurations and functions. Must send Multipoint order form along with order.			
<p><b>ART NOUVEAU Passage/ Dummy</b> (Tubular)</p> <p><b>BL104</b></p> <p>No custom options - available as shown only</p> <p>Extended 10 week lead time</p>		PP-TL 859 PR-TL N/A FD 750 SD 375	
NOT FOR PRE-BORED DOORS!			
Baton Tubular Latch. Std Door Thickness: 1.75". Std Backsets: 2 3/8" or 2.75"			
<p><b>ART NOUVEAU Privacy Bolt</b> (Tubular: Add to Passage Set)</p> <p><b>BE645-PMB</b></p> <p>Extended 10 week lead time</p>		PMB	236
Baton Privacy Bolt. Std Door Thickness: 1.75". Std Backsets: 2 3/8" or 2.75"			

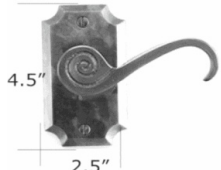
HARDWARE RENAISSANCE	FUNCTION	LIST PRICE \$
<b>BRONZE NOTCHED CORNER - CASA CALIFORNIA COLLECTION</b>		
EUROPEAN INSPIRED ELEGANCE WITH NOTCHED ESCUTCHEONS - AVAILABLE WITH ANY LEVER OR KNOB		
<p><b>NORMANDY- CASA CALIFORNIA Thumbblatch x Lever Entry</b> (Mortise Only) <b>BH441 - BE623-BL103</b></p>  <p>See Page 5 for choice of Mortise Lock functions. Std Door Thickness: 1.75". Std Backsets: 2.5" or 2.75"</p>	EN-ML FD	2,428 1,689
<p><b>NORMANDY Thumbblatch x Thumbblatch Entry</b> (Mortise Only) <b>BH441-BH441</b></p>  <p>See Page 5 for choice of Mortise Lock functions. Std Door Thickness: 1.75". Std Backsets: 2.5" or 2.75"</p>	EN-ML FD	2,893 2,176
<p><b>CASA CALIFORNIA Lever x Lever Entry</b> (Mortise or Tubular. Tubular is 5.5" c-to-c) <b>BE623-BL103</b></p>  <p>BE623 Notched Corner w/BL103</p> <p>See Page 5 for choice of Mortise Lock functions. Std Door Thickness: 1.75". Std Backsets: 2.5" or 2.75" Tubular: Baton Tubular Latch &amp; Deadbolt. Std Door Thickness: 1.75". Std Backsets 2 3/8" or 2.75"</p>	EN-ML PT-ML EN-DB-SC EN-DB-DC PT-DB FD	1,468 1,380 1,003 1,116 984 600

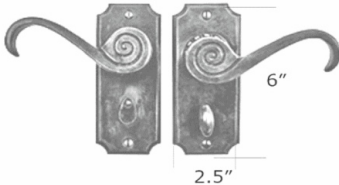
HARDWARE RENAISSANCE		FUNCTION	LIST PRICE \$
<b>BRONZE NOTCHED CORNER - CASA CALIFORNIA COLLECTION</b>			
<p><b>CASA CALIFORNIA Round Sectional Lever x Lever Entry</b> (Tubular) <b>BE603-BL125</b> with BE683-BE684 deadbolt</p>  <p>BE603 Round w/ BL125</p> <p>Mortise: Accurate 9503 Deadlock. Std Door Thickness: 1.75". Std Backsets: 2.5" or 2.75" Baton Tubular Latch &amp; Deadbolt. Std Door Thickness: 1.75". Std Backsets 2 3/8" or 2.75"</p>	<p>EN-DB-SC 890 EN-DB-DC 949 EN-MD 1,064 PT-DB 746 FD 430</p>		
<p><b>Notched Sectional Lever x Lever Entry</b> (Tubular) <b>BE621-BL135</b> with BE689S-BE690S deadbolt</p>  <p>BE621 Notched Corner</p> <p>Mortise: Accurate 9503 Deadlock. Std Door Thickness: 1.75". Std Backsets: 2.5" or 2.75" Baton Tubular Latch &amp; Deadbolt. Std Door Thickness: 1.75". Std Backsets 2 3/8" or 2.75"</p>	<p>EN-DB-SC 890 EN-DB-DC 949 EN-MD 1,064 PT-DB 746 FD 430</p>		
<p><b>CASA CALIFORNIA Rosette Sectional Lever x Lever Entry</b> (Tubular) <b>BE691S-BL125</b> with BE689SC-BE690SC deadbolt</p>  <p>BE691S Rosette w/ BL125</p> <p>Mortise: Accurate 9503 Deadlock. Std Door Thickness: 1.75". Std Backsets: 2.5" or 2.75" Baton Tubular Latch &amp; Deadbolt. Std Door Thickness: 1.75". Std Backsets 2 3/8" or 2.75"</p>	<p>EN-DB-SC 909 EN-DB-DC 968 EN-MD 1,083 PT-DB 765 FD 451</p>		
<p><b>ROUND Deadbolt Only</b> (Tubular or Mortise) <b>BE683-BE684</b></p>  <p>Mortise: Accurate 9503 Deadlock. Std Door Thickness: 1.75". Std Backsets: 2.5" or 2.75" Tubular: Baton Tubular Deadbolt. Std Door Thickness: 1.75". Std Backsets 2 3/8" or 2.75"</p>	<p>EN-DB-SC 343 EN-DB-DC 403 PT-DB 199 EN-MD 517</p>		

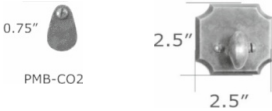

HARDWARE RENAISSANCE		FUNCTION	LIST PRICE \$
<b>BRONZE NOTCHED CORNER - CASA CALIFORNIA COLLECTION</b>			
<p><b>CASA CALIFORNIA NOTCHED Deadbolts Only</b> (Tubular or Mortise) <b>BE689S-BE680S</b> <b>OR</b> <b>BE689SC-BE680SC</b></p>  <p>Mortise: Accurate 9503 Deadlock. Std Door Thickness: 1.75". Std Backsets: 2.5" or 2.75" Tubular: Baton Tubular Deadbolt. Std Door Thickness: 1.75". Std Backsets 2 3/8" or 2.75"</p>	<p>EN-DB-SC 343 EN-DB-DC 403 PT-DB 199 EN-MD 517</p>		
<p><b>CASA CALIFORNIA NOTCHED Multipoint Hardware</b> <b>BE674-BL125</b></p>  <p>Available for most door makes (except Andersen). See Multipoint Spec Sheets for available configurations and functions Must send Multipoint order form along with order</p>	<p>EN-US CYL. 796 PT-US CYL. 734 EN-EURO 915 PT-EURO 854 PP 646 AD 623 FD 600</p>		
<p><b>CASA CALIFORNIA ROUND Passage/ Privacy/ Dummy</b> (Tubular) <b>BE603-BL125</b></p>  <p>Baton Tubular Latch. Std Door Thickness: 1.75". Std Backsets: 2 3/8" or 2.75"</p>	<p>PP-TL 546 PR-TL 570 FD 430 SD 215</p>		
<p><b>CASA CALIFORNIA NOTCHED Passage/ Privacy/ Dummy</b> (Tubular) <b>BE621-BL125</b></p>  <p>Baton Tubular Latch. Std Door Thickness: 1.75". Std Backsets: 2 3/8" or 2.75"</p>	<p>PP-TL 546 PR-TL 570 FD 430 SD 215</p>		

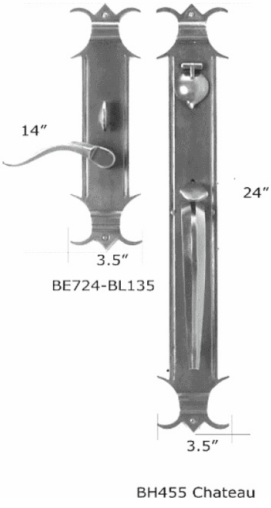
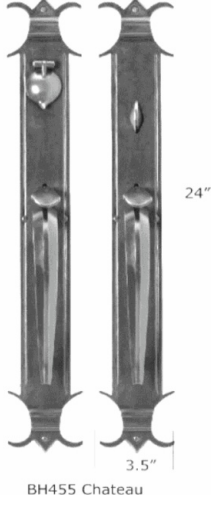
HARDWARE RENAISSANCE		FUNCTION	LIST PRICE \$
<b>BRONZE NOTCHED CORNER - CASA CALIFORNIA COLLECTION</b>			
<p><b>CASA CALIFORNIA ROSETTE Passage/ Privacy/ Dummy</b> (Tubular) <b>BE691S-BL125</b></p>  <p>All functions available LEVER HIGH only (Privacy Bolt is shown) Baton Tubular Latch &amp; Privacy Bolt. Std Door Thickness: 1.75". Std Backsets: 2 3/8" or 2.75"</p>	PP-TL PR-TL PR-PMB FD SD	566 589 751 451 226	
<p><b>ROUND Privacy Bolt</b> (Tubular: Add to Passage Set) <b>BE683-PMB</b></p>  <p>Baton Privacy Bolt. Std Door Thickness: 1.75". Std Backsets: 2 3/8" or 2.75"</p>	PMB	236	
<p><b>NOTCHED Privacy Bolt</b> (Tubular: Add to Passage Set) <b>BE689SC-PMB</b></p>  <p>Baton Privacy Bolt. Std Door Thickness: 1.75". Std Backsets: 2 3/8" or 2.75"</p>	PMB	236	
<p><b>CASA CALIFORNIA NOTCHED Passage/ Privacy/ Dummy</b> (Tubular or Mortise) <b>BE623-BL103</b></p>  <p>Mortise: Accurate 9100 lock. Std Door Thickness: 1.75". Std Backsets: 2.5" or 2.75" Baton Tubular Latch &amp; Privacy Bolt. Std Door Thickness: 1.75". Std Backsets: 2 3/8" or 2.75". 5.5" c-to-c.</p>	PP-TL PR-TL PR-PMB PP-ML PR-ML FD SD	715 739 901 994 1,172 600 300	

HARDWARE RENAISSANCE	FUNCTION	LIST PRICE \$
<b>BRONZE CHATEAU COLLECTION</b>		
FRENCH ELEGANCE WITH SCALE		
<p><b>CHATEAU Thumbblatch x Lever Entry</b> (Mortise Only) <b>BH455 - BE724-BL135</b></p>  <p style="text-align: center;">BH455 Chateau</p> <p>See Page 5 for choice of Mortise Lock functions. Std Door Thickness: 1.75". Std Backsets: 2.5" or 2.75"</p>	EN-ML FD	2,769 1,958
<p><b>CHATEAU Thumbblatch x Thumbblatch Entry</b> (Mortise Only) <b>BH455-BH455</b></p>  <p style="text-align: center;">BH455 Chateau</p> <p>See Page 5 for choice of Mortise Lock functions. Std Door Thickness: 1.75". Std Backsets: 2.5" or 2.75"</p>	EN-ML FD	3,096 2,320

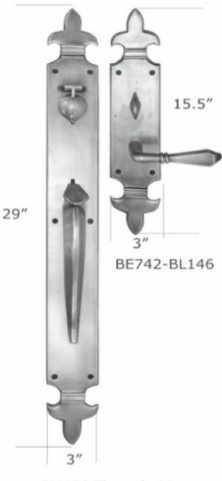
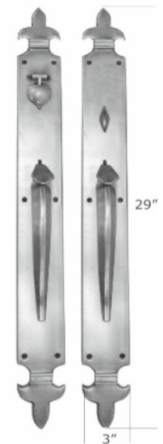
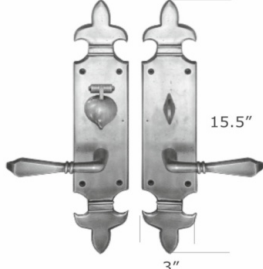
HARDWARE RENAISSANCE	FUNCTION	LIST PRICE \$
<b>BRONZE CHATEAU COLLECTION</b>		
<p><b>CHATEAU Lever x Lever Entry</b>  (Mortise or Tubular. Tubular is 5.5" c-to-c)  <b>BE724-BL135</b></p> <div data-bbox="722 399 1047 766" style="text-align: center;"> <p>Chateau BE724-BL135</p> </div> <p>See Page 5 for choice of Mortise Lock functions. Std Door Thickness: 1.75". Std Backsets: 2.5" or 2.75"  Tubular: Baton Tubular Latch &amp; Deadbolt. Std Door Thickness: 1.75". Std Backsets 2 3/8" or 2.75"</p>	EN-ML 1,716 PT-ML 1,630 EN-DB-SC 1,251 EN-DB-DC 1,364 PT-DB 1,234 FD 805	
<p><b>CHATEAU Passage/ Privacy/ Dummy</b>  (Tubular)  <b>BE724-BL135</b></p> <div data-bbox="836 1029 990 1312" style="text-align: center;"> </div> <p>Mortise: Accurate 9100 lock. Std Door Thickness: 1.75". Std Backsets: 2.5" or 2.75"  Baton Tubular Latch &amp; Privacy Bolt. Std Door Thickness: 1.75". Std Backsets: 2 3/8" or 2.75"</p>	PP-TL 917 PR-TL 940 PR-PMB 1,102 PP-ML 1,196 PR-ML 1,442 FD 805 SD 403	

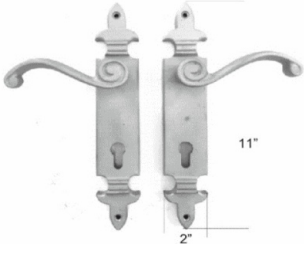
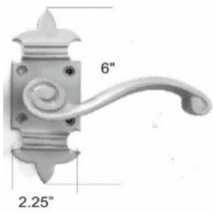
HARDWARE RENAISSANCE	FUNCTION	LIST PRICE \$
<b>BRONZE FLEUR DE LIS COLLECTION</b>		
A CLASSIC FRENCH DESIGN REIMAGINED		
<p><b>FLEUR DE LIS Thumbblatch x Lever Entry</b> (Mortise Only) <b>BH456 - BE742-BL146</b></p>  <p style="text-align: center;">BH456 Fleur de Lis</p>	EN-ML FD	2,769 1,958
See Page 5 for choice of Mortise Lock functions. Std Door Thickness: 1.75". Std Backsets: 2.5" or 2.75"		
<p><b>FLEUR DE LIS Thumbblatch x Thumbblatch Entry</b> (Mortise Only) <b>BH456-BH456</b></p>  <p style="text-align: center;">BH456 Fleur de Lis</p>	EN-ML FD	3,096 2,320
See Page 5 for choice of Mortise Lock functions. Std Door Thickness: 1.75". Std Backsets: 2.5" or 2.75"		
<p><b>FLEUR DE LIS Lever x Lever Entry</b> (Mortise or Tubular. Tubular is 5.5" c-to-c) <b>BE742-BL146 OR BL164</b></p>  <p style="text-align: center;">Fleur de Lis BE742-BL146</p>	EN-ML PT-ML EN-DB-SC EN-DB-DC PT-DB FD	1,716 1,630 1,253 1,366 1,234 805
See Page 5 for choice of Mortise Lock functions. Std Door Thickness: 1.75". Std Backsets: 2.5" or 2.75" Tubular: Baton Tubular Latch & Deadbolt. Std Door Thickness: 1.75". Std Backsets 2 3/8" or 2.75"		

HARDWARE RENAISSANCE		FUNCTION	LIST PRICE \$
<b>BRONZE FLEUR DE LIS COLLECTION</b>			
<b>FLEUR DE LIS Multipoint Hardware</b> <b>BE743-BL146 OR BL164 (shown)</b> 	EN-US CYL. 1,003 PT-US CYL. 928 EN-EURO 1,121 PT-EURO 1,060 PP 852 AD 829 FD 806		
Available for most door makes (except Andersen). See Multipoint Spec Sheets for available configurations and functions. Must send Multipoint order form along with order.			
<b>FLEUR DE LIS Passage/ Privacy/ Dummy (Tubular)</b> <b>BE744-BL146 OR BL164 (shown)</b> 	PP-TL 715 PR-TL 739 FD 611 SD 306		
Baton Tubular Latch. Std Door Thickness: 1.75". Std Backsets: 2 3/8" or 2.75"			
<b>Privacy Bolt</b> (Tubular: Add to Passage Set) <b>BE645-PMB</b> 	PMB	236	
Baton Privacy Bolt. Std Door Thickness: 1.75". Std Backsets: 2 3/8" or 2.75"			
<b>FLEUR DE LIS Passage/ Privacy/ Dummy (Tubular or Mortise)</b> <b>BE742-BL146 OR BL164</b> 	PP-TL 917 PR-TL 940 PR-PMB 1,102 PP-ML 1,196 PR-ML 1,442 FD 805 SD 403		
Mortise: Accurate 9100 lock. Std Door Thickness: 1.75". Std Backsets: 2.5" or 2.75" Baton Tubular Latch & Privacy Bolt. Std Door Thickness: 1.75". Std Backsets: 2 3/8" or 2.75"			

HARDWARE RENAISSANCE	FUNCTION	LIST PRICE \$
<b>BRONZE VERONA COLLECTION</b>		
CLASSIC ELEGANCE WITH BEVELED ESCUTCHEONS - AVAILABLE WITH ANY LEVER OR KNOB		
<p><b>VERONA Thumbblatch x Lever Entry</b> (Mortise Only) <b>BH443 - BE614-BL135</b></p>  <p>See Page 5 for choice of Mortise Lock functions. Std Door Thickness: 1.75". Std Backsets: 2.5" or 2.75"</p>	EN-ML FD	2,196 1,480
<p><b>VERONA Thumbblatch x Thumbblatch Entry</b> (Mortise Only) <b>BH443-BH443</b></p>  <p>See Page 5 for choice of Mortise Lock functions. Std Door Thickness: 1.75". Std Backsets: 2.5" or 2.75"</p>	EN-ML FD	2,692 1,962
<p><b>VERONA Thumbblatch x Strike-bar Latch Entry</b> (Mortise Deadbolt Only) <b>BH443-BS503</b></p> <p>No lever option</p>  <p>With mortise strike shown Accurate 9503 Deadlock. Std Door Thickness: 1.75". Std Backsets: 2.5" or 2.75"</p>	EN-MD FD	2,423 2,037

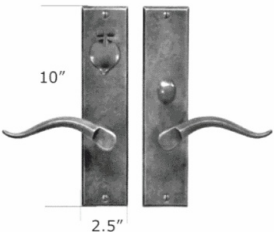
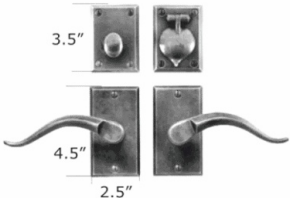
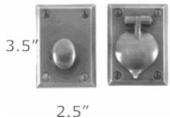
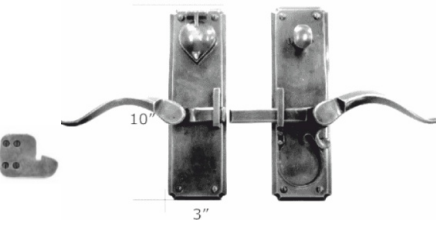

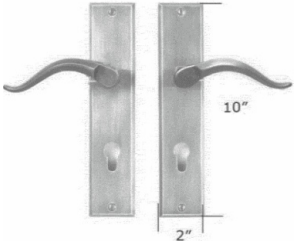
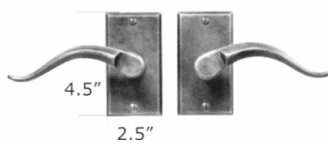
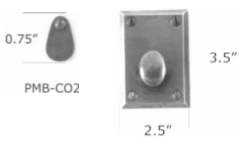
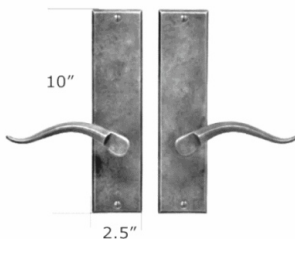
HARDWARE RENAISSANCE		FUNCTION	LIST PRICE \$
<b>BRONZE VERONA COLLECTION</b>			
<p><b>VERONA Lever x Lever Entry</b> (Mortise or Tubular. Tubular is 5.5" c-to-c) <b>BE614-BL135</b></p>  <p>See Page 5 for choice of Mortise Lock functions. Std Door Thickness: 1.75". Std Backsets: 2.5" or 2.75" Tubular: Baton Tubular Latch &amp; Deadbolt. Std Door Thickness: 1.75". Std Backsets 2 3/8" or 2.75"</p>	EN-ML 1,468 PT-ML 1,380 EN-DB-SC 1,003 EN-DB-DC 1,116 PT-DB 984 FD 600		
<p><b>VERONA Sectional Lever x Lever Entry</b> (Tubular) <b>BE618-BL135</b> with BE685-BE686 deadbolt</p>  <p>Mortise: Accurate 9503 Deadlock. Std Door Thickness: 1.75". Std Backsets: 2.5" or 2.75" Baton Tubular Latch &amp; Deadbolt. Std Door Thickness: 1.75". Std Backsets 2 3/8" or 2.75"</p>	EN-DB-SC 890 EN-DB-DC 949 EN-MD 1,064 PT-DB 746 FD 430		
<p><b>Deadbolt Only</b> (Tubular or Mortise) <b>BE685-BE686</b></p>  <p>Mortise: Accurate 9503 Deadlock. Std Door Thickness: 1.75". Std Backsets: 2.5" or 2.75" Tubular: Baton Tubular Deadbolt. Std Door Thickness: 1.75". Std Backsets 2 3/8" or 2.75"</p>	EN-DB-SC 343 EN-DB-DC 403 PT-DB 199 EN-MD 517		
<p><b>VERTICAL Strike-bar Latch Entry</b> (Mortise or Tubular Deadbolt) <b>BS503-BL135 Verona II lever</b></p> <p>No lever option</p>  <p>With mortise strike shown</p> <p>Mortise: Accurate 9503 Deadlock. Std Door Thickness: 1.75". Std Backsets: 2.5" or 2.75" Tubular: Baton Tubular Deadbolt. Std Door Thickness: 1.75". Std Backsets 2 3/8" or 2.75"</p>	EN-MD 1,482 EN-DB-SC 1,315 EN-DB-DC 1,375 PT-DB 1,251 FD 783		

HARDWARE RENAISSANCE		FUNCTION	LIST PRICE \$
<b>BRONZE VERONA COLLECTION</b>			
<b>VERONA Multipoint Hardware</b> <b>BE614N-BL135</b> 	EN-US CYL. 796 PT-US CYL. 734 EN-EURO 915 PT-EURO 854 PP 646 AD 623 FD 600		
<p>Available for most door makes (except Andersen). See Multipoint Spec Sheets for available configurations and functions            Must send Multipoint order form along with order</p>			
<b>VERONA Passage/ Privacy/ Dummy</b> (Tubular) <b>BE618-BL135</b> 	PP-TL 546 PR-TL 570 FD 430 SD 215		
<p>Baton Tubular Latch. Std Door Thickness: 1.75". Std Backsets: 2 3/8" or 2.75"</p>			
<b>Beveled Privacy Bolt</b> (Tubular: Add to Passage Set) <b>BE685-PMB</b> 	PMB 236		
<p>Baton Privacy Bolt. Std Door Thickness: 1.75". Std Backsets: 2 3/8" or 2.75"</p>			
<b>VERONA Passage/ Privacy/ Dummy</b> (Tubular or Mortise) <b>BE614-BL135</b> 	PP-TL 715 PR-TL 739 PR-PMB 901 PP-ML 994 PR-ML 1,172 FD 600 SD 300		
<p>Mortise: Accurate 9100 lock. Std Door Thickness: 1.75". Std Backsets: 2.5" or 2.75"            Baton Tubular Latch &amp; Privacy Bolt. Std Door Thickness: 1.75". Std Backsets: 2 3/8" or 2.75"</p>			

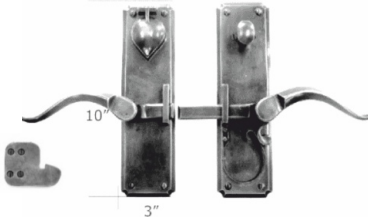
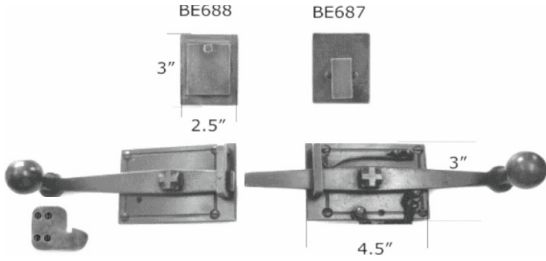
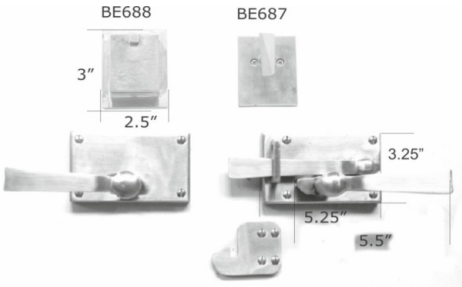
HARDWARE RENAISSANCE	FUNCTION	LIST PRICE \$
<p align="center"><b>BRONZE STRIKE-BAR LATCHES COLLECTION: ENTRY SETS</b></p> <p align="center">HISTORIC STYLES IN OUR UNIQUE COLLECTION OF STRIKE-BAR LATCHES IN EVERY FUNCTION</p>		
<p><b>NORMANDY Thumbblatch x Strike-bar Latch Entry</b>  (Mortise Deadbolt Only)  <b>BH441-BS503 (w/ BL135 Lever)</b></p> <p>No lever option</p>  <p>With mortise strike shown  Accurate 9503 Deadlock. Std Door Thickness: 1.75". Std Backsets: 2.5" or 2.75"</p>	EN-MD FD	2,644 2,203
<p><b>VERONA Thumbblatch x Strike-bar Latch Entry</b>  (Mortise Deadbolt Only)  <b>BH443-BS503 (w/ BL135 Lever)</b></p> <p>No lever option</p>  <p>With mortise strike shown  Accurate 9503 Deadlock. Std Door Thickness: 1.75". Std Backsets: 2.5" or 2.75"</p>	EN-MD FD	2,423 2,037

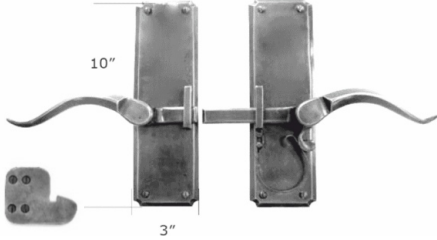
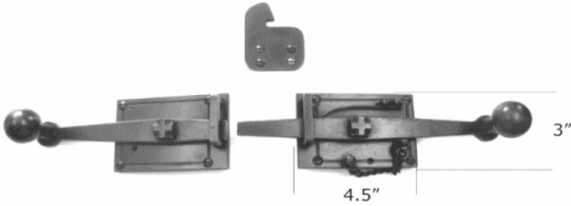
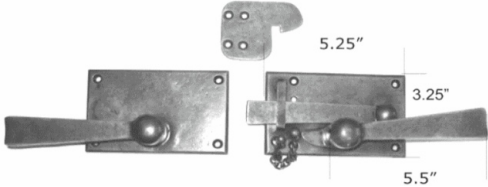
HARDWARE RENAISSANCE		FUNCTION	LIST PRICE \$
<b>BRONZE STRIKE-BAR LATCHES COLLECTION: ENTRY SETS</b>			
<p>These unique sets are available with tubular deadbolt (DB) or heavier duty Mortise Deadlock (MD -Accurate 9503) for HS503. Sets are HANDED. Active side with extended bar goes on the inside of inswing door. With mortise strike as shown. Contact us for surface or other strike requirements.</p> <p><b>VERTICAL Strike-bar Latch Entry</b> (Mortise or Tubular Deadbolt) <b>BS503-BL135</b></p> <p>No lever option</p>  <p>Mortise: Accurate 9503 Deadlock. Std Door Thickness: 1.75". Std Backsets: 2.5" or 2.75" Tubular: Baton Tubular Deadbolt. Std Door Thickness: 1.75". Std Backsets 2 3/8" or 2.75"</p>		EN-MD EN-DB-SC EN-DB-DC PT-DB FD	1,482 1,315 1,375 1,251 783
<p><b>TWEEZER Strike-bar Latch Entry</b> (Mortise or Tubular Deadbolt) <b>BS504</b></p> <p>No lever option</p>  <p>Mortise: Accurate 9503 Deadlock. Std Door Thickness: 1.75". Std Backsets: 2.5" or 2.75" Tubular: Baton Tubular Deadbolt. Std Door Thickness: 1.75". Std Backsets 2 3/8" or 2.75"</p>		EN-MD EN-DB-SC EN-DB-DC PT-DB FD	1,212 1,045 1,105 905 613
<p><b>BERMUDA Strike-bar Latch Entry</b> (Mortise or Tubular Deadbolt) <b>BS507</b></p> <p>No lever option</p>  <p>Mortise: Accurate 9503 Deadlock. Std Door Thickness: 1.75". Std Backsets: 2.5" or 2.75" Tubular: Baton Tubular Deadbolt. Std Door Thickness: 1.75". Std Backsets 2 3/8" or 2.75"</p>		EN-MD EN-DB-SC EN-DB-DC PT-DB FD	1,212 1,045 1,105 905 613

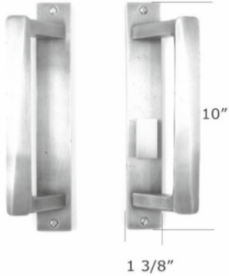
HARDWARE RENAISSANCE		FUNCTION	LIST PRICE \$
<b>BRONZE STRIKE-BAR LATCHES: PASSAGE/ PRIVACY SETS</b>			
<p>These unique sets have no internal components except for a spindle. Can be ordered for any door thickness. Sets are HANDED. Active side with extended bar goes on the inside of inswing door. With mortise strike as shown. Contact us for surface or other strike requirements.</p>			
<p><b>VERTICAL Strike-bar Latch</b></p> <p><b>BS503-BL135</b></p> <p>No lever option</p>  <p>Passage shown</p>	<p>PP 869</p> <p>PR 907</p> <p>FD 783</p> <p>SD 391</p>		
<p><b>TWEEZER Strike-bar Latch</b></p> <p><b>BS504</b></p> <p>No lever option</p>  <p>Privacy shown, with locking privacy chain</p>	<p>PP 703</p> <p>PR 743</p> <p>FD 613</p> <p>SD 307</p>		
<p><b>BERMUDA Strike-bar Latch</b></p> <p><b>BS507</b></p> <p>No lever option</p>  <p>Privacy shown, with locking privacy chain</p>	<p>PP 703</p> <p>PR 743</p> <p>FD 613</p> <p>SD 307</p>		

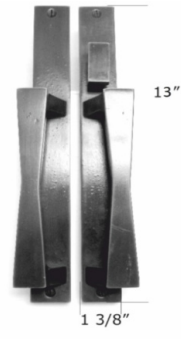
HARDWARE RENAISSANCE		FUNCTION	LIST PRICE \$
<b>BRONZE SLIDING DOOR HARDWARE</b>			
<b>STANDARD SLIDING DOOR</b>			
Available for most door makes. See Sliding door order form on Page 70 for required information NOTE: <u>WE DO NOT MATCH existing screw hole locations</u> - our default set up is to miss them. Thru-bolts will be provided.			
<b>AVAILABLE WITH THE FOLLOWING GRIPS:</b>			
BP656 Milan BP657 El Secreto BP444 Manhattan BP659 Scottsdale			
<b>SLIDING DOOR:</b>			
<b>BE671</b>	<b>1 3/8" x 10" Straight Edge</b>	PT-US FD	700 633
 <p style="text-align: center;">BE671 Escutcheon Patio set shown w/ BP656 Offset Milan Grip</p>			
<b>BE671L</b>	<b>1 3/8" x 13" Straight Edge</b>	EN-US PT-US FD	850 786 645
<b>BE671LB</b>	<b>1 3/8" x 13" Beveled</b>		
<b>BE671LNC</b>	<b>1 3/8" x 13" Notched Corner</b>		
 <p style="text-align: center;">BE671L Escutcheon Patio set shown w/ BP657 Grip</p>		 <p style="text-align: center;">BE671L Escutcheon Patio Set shown w/ BP444 Grip</p>	

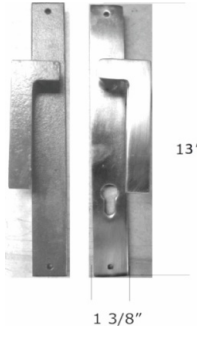
HARDWARE RENAISSANCE		FUNCTION	LIST PRICE \$
<b>BRONZE SLIDING DOOR HARDWARE</b>			
<b>MULTIPOINT SLIDING DOOR:</b>			
Available for most door makes. Additional information about existing door prep is required NOTE: <u>WE DO NOT MATCH</u> existing screw hole locations - our default set up is to miss them. Thru-bolts will be provided.			
<b>AVAILABLE WITH THE FOLLOWING OFFSET LEVERS:</b>			
BL137-OS Milan BL140-OS Bay			
<b>BE671</b>	<b>1 3/8" x 10" Straight Edge</b>		EN-US 782 PT-US 729 EN-EURO 881 PT-EURO 819 FD 643
<b>BE671L</b>	<b>1 3/8" x 13" Straight Edge</b>		EN-US 816 PT-US 762 EN-EURO 914 PT-EURO 853 FD 676

HARDWARE RENAISSANCE		FUNCTION	LIST PRICE \$
<b>BRONZE SLIDING DOOR HARDWARE</b>			
<p><b>LIFT &amp; SLIDE:</b></p> <p>Lift and Slide sets are typically a long lever on the inside, and a flush pull on the outside.            The locking is inside the door mechanism.            Standard spindle (hub) is 10mm square.</p> <p><b>AVAILABLE WITH THE FOLLOWING LONG LEVERS:</b></p> <p>BL108L East-West            BL137L Milan            BL132L Manhattan</p> <p><b>BE671      1 3/8" x 10" Straight Edge Escutcheon</b>  <b>BP712      Flush Pull</b></p>  <p>10" 1 3/8"</p> <p>BE671 Escutcheon set shown w/ BL108L East-West 9" Lever &amp; BP712 Flush Pull      BE671 Escutcheon set shown w/ BL137L Milan 9" Lever &amp; BP712 Flush Pull      BE671 Escutcheon set shown w/ BL132L Manhattan 7" Lever &amp; BP712 Flush Pull</p> <p>INQUIRE ABOUT OTHER LEVER &amp; ESCUTCHEON OPTIONS.</p>		PP	753

PURCHASE ORDER # \_\_\_\_\_

1 Manufacturer \_\_\_\_\_

2 Function \_\_\_\_\_

3 Door Thickness \_\_\_\_\_

4 Handing \_\_\_\_\_ (OX, XO, OR looking from the outside, the direction to which the door slides)

5 Type of Spindle for turnpiece

(Circle one or send sketch if different)

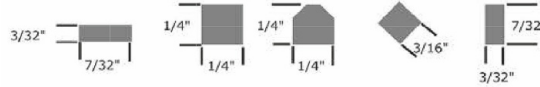

6 Hardware projection limitations (i.e. for screen door)?

7 Type of set-up and screw spacing (mark below OR supply drawing if different)

**GRIP LOW**

	MAKE		DIM A	DIM B	DIM C
	HOPPE		1-3/4" (1.772")	7-3/8" (7.362")	9-1/8" (9.134")
	JELDWEN (A)		1-3/16" (1.818")	5-7/16" (5.427")	7-1/4" (7.245")
	JELDWEN (B)		1-15/16" (1.945")	8-5/16" (8.300")	10-1/4" (10.245")
	KOLBE		1-31/32" (1.969")	8-9/32" (8.277")	10-1/4" (10.246")
	MARVIN		1-9/16" (1.584")	9-5/8" (9.643")	11-1/4" (11.227")
	MARVIN INTEGRITY		1-15/16" (1.945")	9-31/32" (9.975")	11-15/16" (11.920")
	PELLA		23/32" (.700")	7-5/16" (7.300")	8.000"
	ANDERSEN		1-15/16" (1.950")	9-13/16" (9.800")	11-3/4" (11.75")
	SIERRA PACIFIC		1-3/4" (1.771")	7-3/8" (7.361")	9-1/8" (9.132")
	WINDSOR		1-31/32" (1.969")	9-15/16" (9.951")	11-15/16" (11.920")
	OTHER				

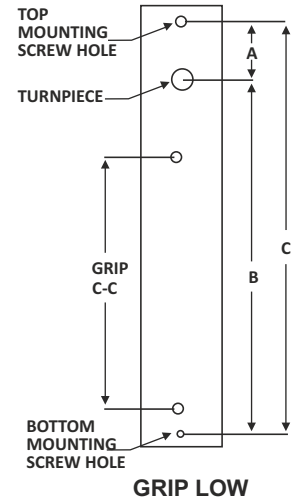
**GRIP CENTERED**

	MAKE		DIM A	DIM B	DIM C
	JELDWEN (A)		2-23/32" (2.718")	1-1/4" (1.219")	3-15/16" (3.937")
	EAGLE		1-1/4" (1.219")	2-23/32" (2.718")	3-15/16" (3.937")
	MARVIN		4-15/16" (4.938")	4-15/16" (4.938")	9-7/8" (9.875")
	MARVIN		1-15/16" (1.945")	1-15/16" (1.945")	3-31/32" (3.980")
	OTHER				

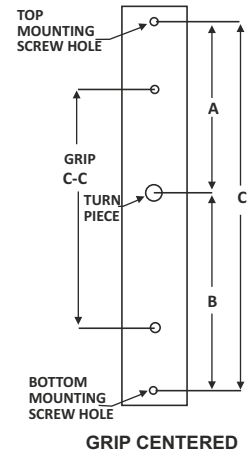



NOTE: WE DO NOT MATCH EXISTING SCREWHOLE. OUR BACKPLATES WILL MISS THEM.  
 WE PROVIDE THRU-BOLTS FOR INSTALL.

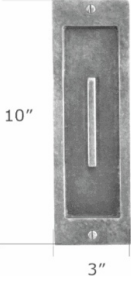
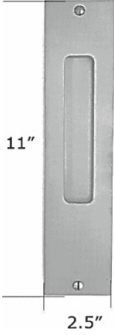
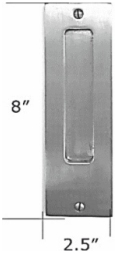
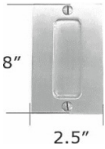

**SLIDING DOOR RETROFIT TRIM IS NON-RETURNABLE**

Signature \_\_\_\_\_

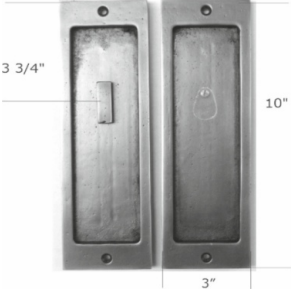
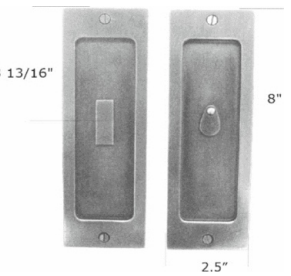

Date \_\_\_\_\_

HARDWARE RENAISSANCE	FUNCTION	LIST PRICE \$
<b>BRONZE POCKET DOOR HARDWARE</b>		
<b>BP711 Flush Pull</b> 		181
<b>BP712 Flush Pull</b> 		181
<b>BP713 Flush Pull</b> 		146
<b>BP714 Flush Pull</b> 		98
<b>BP710 Edge Pull</b> 		97

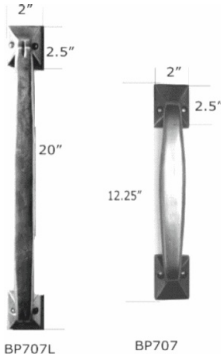
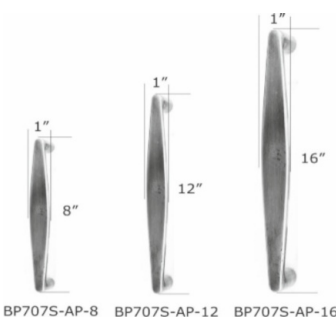
HARDWARE RENAISSANCE		FUNCTION	LIST PRICE \$
<b>BRONZE POCKET DOOR HARDWARE</b>			
<b>BP711 Pocket Door Privacy &amp; Keyed Sets</b>			
BP711-PR	3" x 10" Pocket Mortise Privacy Set	PR EN FD	867
BP711-EN	3" x 10" Pocket Mortise Entry Set		899
BP711-FD	3" x 10" Pocket Door Full Dummy (with Pocket mortise strike/pull) (for double pocket/ sliding doors)		773
BP711-PR-PDL	3" x 10" Pocket Privacy Set (w/161PDL lock + 161PDP edge pull) (Tubular Option)	PR	670
			
<p>Accurate 2002 Pocket Mortise lock. Std Door Thickness: 1.75". Std Backsets: 2.5" or 2.75"            Accurate 161PDL lock. Std Backsets 2 3/8" or 2.75"</p>			
<b>BP713 Pocket Door Privacy &amp; Keyed Sets</b>			
BP713-PR	2.5" x 8" Pocket Mortise Privacy Set	PR EN FD	843
BP713-EN	2.5" x 8" Pocket Mortise Entry Set		884
BP713-FD	2.5" x 8" Pocket Door Full Dummy (with Pocket mortise strike/pull) (for double pocket/ sliding doors)		697
BP713-PR-PDL	2.5" x 8" Pocket Privacy Set (w/161PDL lock + 161PDP edge pull) (Tubular Option)	PR	646
			
<p>Accurate 2002 Pocket Mortise lock. Std Door Thickness: 1.75". Std Backsets: 2.5" or 2.75"            Accurate 161PDL lock. Std Backsets 2 3/8" or 2.75"</p>			

HARDWARE RENAISSANCE		FUNCTION	LIST PRICE \$
<p align="center"><b>BRONZE DOOR &amp; APPLIANCE PULLS</b></p> <p>Pulls are either thru-bolted or surface mounted with screws (depending upon the design) by default. Available for back-to-back mounting or concealed front-mounting. Specify and provide door thickness.</p> <p><b>BP106 19" Art Nouveau Pull</b> Specify HANDING</p> 			553
<p><b>BP705 12" East-West Pull</b></p> 			439
<p><b>BP707L 20" El Secreto Pull</b> <b>BP707 12.25" El Secreto Pull</b></p> 			564 439
<p><b>BP707S-AP-8 8" El Secreto Appliance Pull</b> <b>BP707S-AP-12 12" El Secreto Appliance Pull</b> <b>BP707S-AP-16 16" El Secreto Appliance Pull</b></p> 		7.25" c-to-c 11.25" c-to-c 15.25" c-to-c	216 251 362

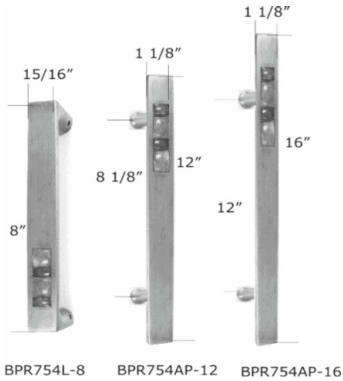
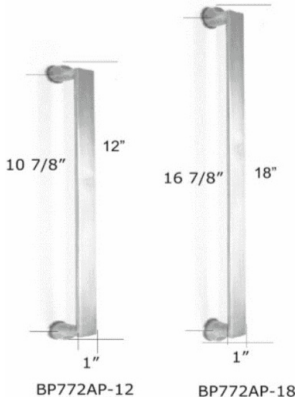
HARDWARE RENAISSANCE		FUNCTION	LIST PRICE \$
<b>BRONZE DOOR &amp; APPLIANCE PULLS</b>			
<b>BP654 8" Milan Pull</b> <b>BP725-12 12" Milan Pull</b> <b>BP725-16 16" Milan Pull</b> <b>BP725-20 20" Milan Pull</b>		7.25" c-to-c 11.25" c-to-c 15.25" c-to-c 19.25" c-to-c	243 392 461 549
<b>BP726AP-12 12" Rectangular Pull</b> <b>BP726AP-20 20" Rectangular Pull</b>		7" c-to-c 12" c-to-c	295 472
<b>BP754AP-12 12" Scottsdale Pull</b> <b>BP754AP-16 16" Scottsdale Pull</b> <b>BP754AP-20 20" Scottsdale Pull</b> <b>BP754AP-24 24" Scottsdale Pull</b>		8 1/8" c-to-c 12" c-to-c 15" c-to-c 18" c-to-c	295 428 472 538

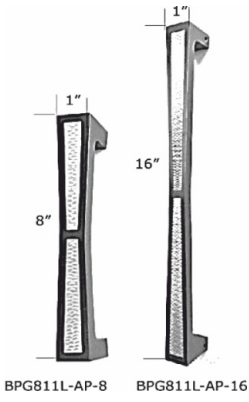
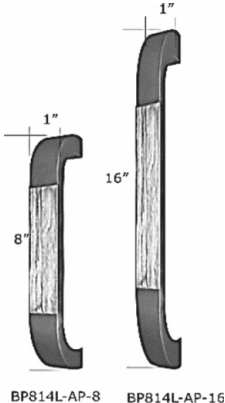
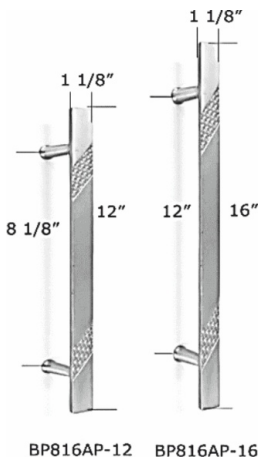

HARDWARE RENAISSANCE		FUNCTION	LIST PRICE \$
<b>BRONZE DOOR &amp; APPLIANCE PULLS</b>			
<p><b>BPR754L-8      8" Scottsdale Royale Grip Pull</b>  <b>BPR754AP-12   12" Scottsdale Royale Pull</b>  <b>BPR754AP-16   16" Scottsdale Royale Pull</b></p> <p>Specify Turquoise &amp; Dark Rotile (TDR),  Green &amp; Yellow Opal (OGY), or Red Jade  &amp; Panther Jasper (JRP) combination</p>	 <p>BPR754L-8    BPR754AP-12    BPR754AP-16</p>	<p>7.25" c-to-c      366  8 1/8" c-to-c      472  12" c-to-c          538</p>	
<p><b>BP772AP-12    12" Prescott Pull</b>  <b>BP772AP-18    18" Prescott Pull</b></p>	 <p>BP772AP-12    BP772AP-18</p>	<p>10 7/8" c-to-c      318  16 7/8" c-to-c      472</p>	
<p><b>BP779AP-12    12" Stockholm Pull</b>  <b>BP779AP-18    18" Stockholm Pull</b>  <b>BP779AP-24    24" Stockholm Pull</b></p>	 <p>BP779AP-12    BP779AP-18    BP779AP-24</p>	<p>11.5" c-to-c      295  17.5" c-to-c      461  23.5" c-to-c      538</p>	



HARDWARE RENAISSANCE		FUNCTION	LIST PRICE \$
<b>BRONZE DOOR &amp; APPLIANCE PULLS</b>			
<p><b>BPG811AP-8 8" Grande Manhattan Pull</b>  <b>BPG811AP-16 16" Grande Manhattan Pull</b></p> <p>With hand textured bronze inlay  Specify trim/ inlay patina from any of our 16 bronze patinas</p>  <p>BPG811L-AP-8 BPG811L-AP-16</p>	<p>7.25" c-to-c  15.25" c-to-c</p>	<p>326  518</p>	
<p><b>BP814AP-8 8" Amalfi Pull</b>  <b>BP814AP-16 16" Amalfi Pull</b></p>  <p>BP814L-AP-8 BP814L-AP-16</p>	<p>7.25" c-to-c  15.25" c-to-c</p>	<p>309  483</p>	
<p><b>BP816AP-12 12" Amora Pull</b>  <b>BP816AP-16 16" Amora Pull</b></p>  <p>BP816AP-12 BP816AP-16</p>	<p>8 1/8" c-to-c  12" c-to-c</p>	<p>309  483</p>	

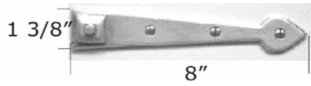
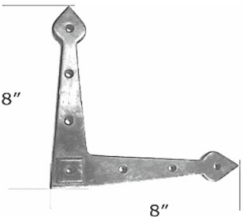
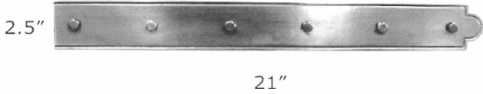
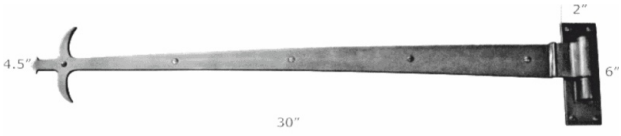

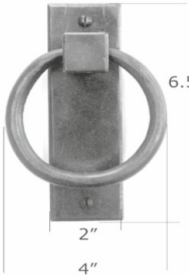

HARDWARE RENAISSANCE		FUNCTION	LIST PRICE \$
<b>BRONZE DOOR &amp; APPLIANCE PULLS</b>			
<b>BP818AP-12 12" Cayman Pull</b> <b>BP818AP-16 16" Cayman Pull</b>		8" c-to-c 12" c-to-c	309 483
<b>BP820AP-8 8" Canyon Pull</b> <b>BP820AP-16 16" Canyon Pull</b>		7.25" c-to-c 15.25" c-to-c	324 516
<b>BP822AP-12 12" Aria Pull</b> <b>BP822AP-16 16" Aria Pull</b>		8" c-to-c 12" c-to-c	309 483

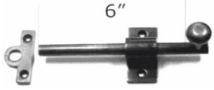
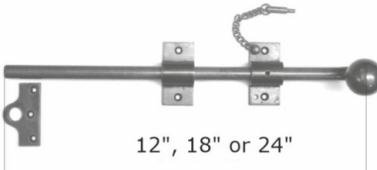
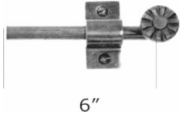
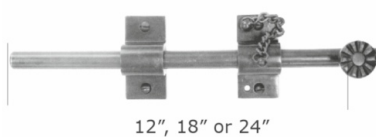
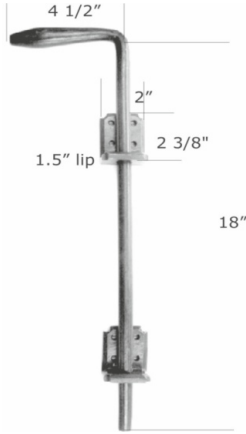
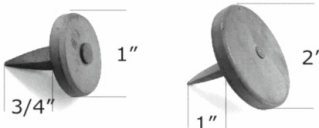

HARDWARE RENAISSANCE		FUNCTION	LIST PRICE \$
<b>BRONZE DOOR &amp; APPLIANCE PULLS</b>			
<b>BP824AP-10</b> 10" Fleur de Lis Pull <b>BP824AP-14</b> 14" Fleur de Lis Pull		9.25" c-to-c 13" c-to-c	306 439
<b>BRONZE PUSH PLATES</b>			
Any escutcheon can be made into a push plate. Contact us for pricing.			
<b>BE715</b> 2.5" x 10" Straight Edge <b>BE715B</b> 2.5" x 10" Beveled			171 171
<b>BE616</b> 3" x 12" Straight Edge <b>BE616B</b> 3" x 12" Beveled			196 196
<b>BE617B</b> 4" x 15" Beveled			251

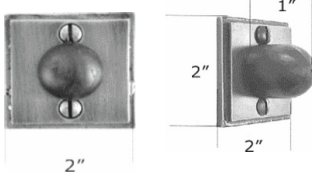
HARDWARE RENAISSANCE			FUNCTION	LIST PRICE \$
<b>BRONZE ACCESSORIES</b>				
<b>BRONZE STRAPS &amp; BRACES</b>				
<b>BB351</b>	<b>8" Single Arm Brace</b>			117
<b>BB355</b>	<b>8" Corner Brace</b>			152
<b>BB800</b>	<b>21" Arch Dummy Strap</b>			516
<b>BB812</b>	<b>6" x 30" Chateau Pintle Strap Hinge (MUST SPECIFY HANDING!)</b>			645

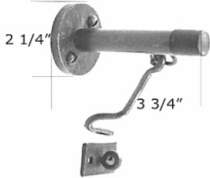

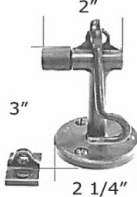

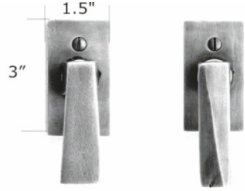
HARDWARE RENAISSANCE		FUNCTION	LIST PRICE \$
<b>BRONZE ACCESSORIES</b>			
<b>BRONZE DOOR KNOCKERS</b>			
<b>BD254</b>	<b>Ring</b>		395
<b>BD256</b>	<b>East-West Oval</b>		373
<b>BD257</b>	<b>East-West II</b>		373

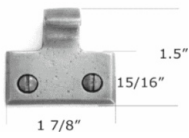
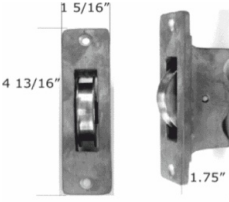
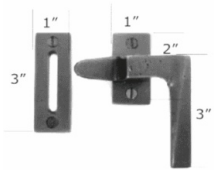
HARDWARE RENAISSANCE		FUNCTION	LIST PRICE \$
<b>BRONZE ACCESSORIES</b>			
<b>BRONZE SURFACE BOLTS</b>			
With mortise strike as shown. Available with surface strike			
<b>BB283</b>	<b>6" (1 guide)</b>		292
<b>BB285</b> <b>BB287</b> <b>BB288</b>	<b>12" (2 guides)</b> <b>18" (2 guides)</b> <b>24" (3 guides)</b>		410 449 576
<b>BB290-6</b>	<b>6" Rosette Knob (1 guide)</b>		317
<b>BB290-12</b> <b>BB290-18</b> <b>BB290-24</b>	<b>12" Rosette Knob (2 guides)</b> <b>18" Rosette Knob (2 guides)</b> <b>24" Rosette Knob (3 guides)</b>		439 487 626
<b>BB233</b>	<b>18" Cane Bolt</b>		461
<b>BRONZE CLAVOS</b>			
<b>BC332</b> <b>BC333</b>	<b>1" Round</b> <b>2" Round</b>		28 42
<b>BC352</b> <b>BC353</b>	<b>1" Pyramid</b> <b>2" Pyramid</b>		28 42

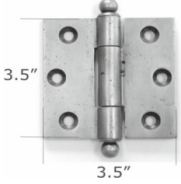
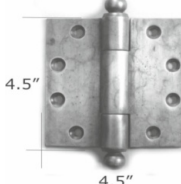
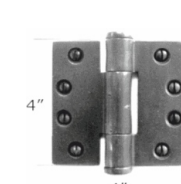
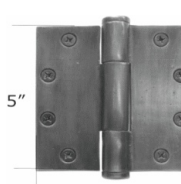
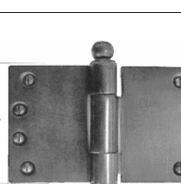
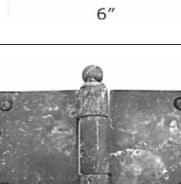
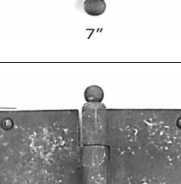
HARDWARE RENAISSANCE			FUNCTION	LIST PRICE \$
<b>BRONZE ACCESSORIES</b>				
<b>BRONZE DOOR STOPS</b>				
<b>BD258</b>	<b>Floor mounted contemporary</b>			108
<b>BD259</b>	<b>Wall mounted (Flat w/round stop)</b>			100
<b>BD261</b>	<b>3.75" Base Stop</b>			68
<b>BD261W</b>	<b>3.75" Base Stop with hook</b>			84
<b>BD262</b>	<b>3" Floor Stop</b>			90
<b>BD262-W</b>	<b>3" Floor Stop with hook</b>			106

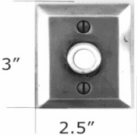
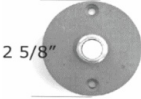
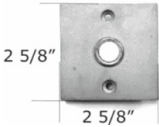
HARDWARE RENAISSANCE		FUNCTION	LIST PRICE \$
<b>BRONZE ACCESSORIES</b>			
<b>BRONZE WINDOW HARDWARE</b>			
<b>European Push &amp; Tilt</b> <b>BE620</b>	<b>1.5" x 3" Push &amp; Tilt Escutcheon</b>	 <p>BE620-BL132M      BE620-BL137M</p>	313
With std 7mm square spindle and 90 degree turn mechanism			
<b>Double Hung</b> <b>BW112</b>	<b>Classic Sash Pull</b>		61
<b>BW114</b>	<b>Sash Lock</b>	 <p>BW114 Sash Lock SPECIFY Handing (RH shown)</p>	97
<b>BW117</b>	<b>Sash Lift</b>		50
<b>BW210</b>	<b>Sash Pulley</b>	 <p>BW210 Window SASH PULLEY (with #25 natural bronze chain)</p>	188
<b>BW210-CH</b>	<b>Sash Chain (natural bronze)</b>		per foot      8
<b>Casement</b> <b>BW116</b>	<b>Milan Casement Latch</b> (specify handing. RH shown)		285

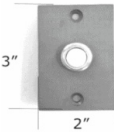

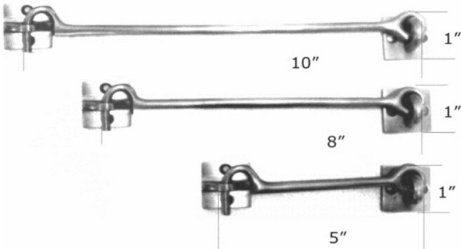
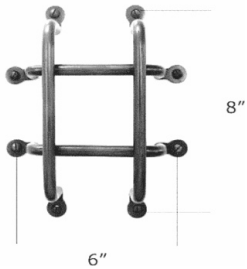
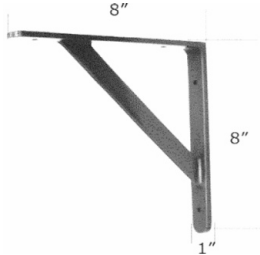

HARDWARE RENAISSANCE		FUNCTION	LIST PRICE \$
<b>BRONZE ACCESSORIES</b>			
<b>BRONZE HEAVY DUTY BUTT HINGES</b>			
With teflon bushings. SPECIFY FINIAL: BALL or FLAT CAP			
<b>BN403</b>	<b>3.5" x 3.5"</b>		175
5/8" barrel diameter			
<b>BN405</b>	<b>4.5" x 4.5"</b>		190
7/8" barrel diameter			
<b>BN406</b>	<b>4" x 4"</b>		185
7/8" barrel diameter			
<b>BN407</b>	<b>5" x 5"</b>		203
7/8" barrel diameter			
<b>BN408</b> <b>Wide-Throw</b>	<b>4" x 6"</b>		218
7/8" barrel diameter			
<b>BN409</b> <b>Wide-Throw</b>	<b>4" x 7"</b>		247
7/8" barrel diameter			
<b>BN410</b> <b>Wide-Throw</b>	<b>5" x 8"</b>		311
7/8" barrel diameter			

HARDWARE RENAISSANCE		FUNCTION	LIST PRICE \$
<b>BRONZE ACCESSORIES</b>			
<b>BRONZE SWITCH PLATE COVERS</b>			
<b>BSP1</b>	<b>Single Decora Switch</b>		57
<b>BSP2</b>	<b>Double Decora Switch</b>		82
<b>BSP3</b>	<b>Triple Decora Switch</b>		87
<b>BSP4</b>	<b>Quad Decora Switch</b>		159
<b>BSPP</b>	<b>Single Cover Plate</b>		86
<b>BOP1</b>	<b>Outlet Cover</b>		57
BSP1 shown			
<b>BRONZE DOOR BELL BUTTONS</b> (any escutcheon can be adapted for door bell button. Call for pricing)			
<b>BE602-BB</b>	<b>2.5" x 3" Beveled</b>		114
<b>BE606L-BB</b>	<b>2 5/8" Round</b>		114
<b>BE607L-BB</b>	<b>2 5/8" Square Straight Edge</b>		114
<b>BE621NS-BB</b>	<b>2" x 3" Notched</b>		114
<b>BE644-BB</b>	<b>2" x 3" Straight Edge</b>		114
<b>BE645-BB</b>	<b>2 5/8" diameter Art Nouveau</b>		130



HARDWARE RENAISSANCE		FUNCTION	LIST PRICE \$
<b>BRONZE ACCESSORIES</b>			
<b>BRONZE MISCELLANEOUS ACCESSORIES</b>			
<b>BB370S-5</b> 5" Hook & Eye <b>BB370S-8</b> 8" Hook & Eye <b>BB370S-10</b> 10" Hook & Eye		130 152 172	
<b>BG281</b> 6" x 8" Speakeasy Grille Call for custom sizes		377	
<b>BSB122</b> 8" x 8" Shelf Bracket		329	

HARDWARE RENAISSANCE			FUNCTION	LIST PRICE \$
<b>BRONZE CABINET HARDWARE</b>				
<b>BP707SC-4</b> <b>4" El Secreto</b> <b>BP707SC-6</b> <b>6" El Secreto</b> <b>BP707SC-8</b> <b>8" El Secreto</b> <b>BP707SC-12</b> <b>12" El Secreto</b>			3.5" c-to-c 5.5" c-to-c 7.5" c-to-c 11.5" c-to-c	68 90 137 160
<b>BP731</b>	<b>1" Round</b>			38
<b>BP732</b>	<b>2" Round</b>			53
<b>BP733</b>	<b>1" Pyramid</b>			38
<b>BP734</b>	<b>2" Pyramid</b>			53
<b>BP735</b>	<b>East-West</b>			53

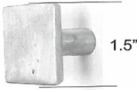
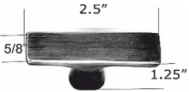





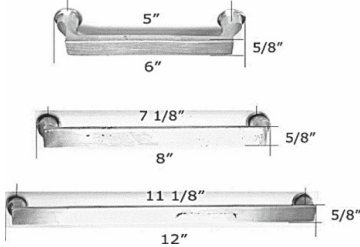
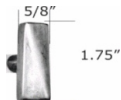
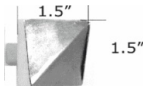
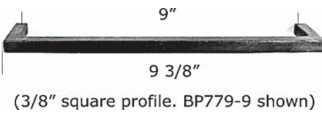
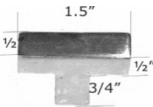
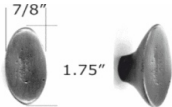

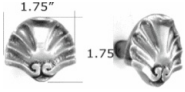
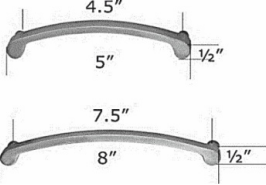
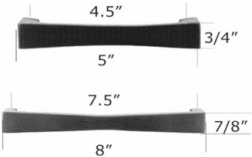
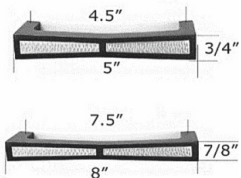
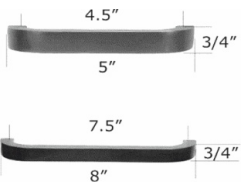

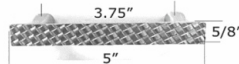

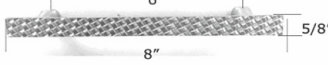

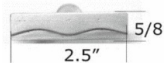
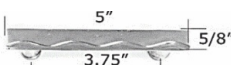
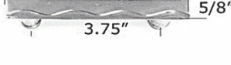
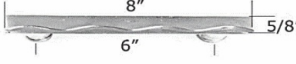
HARDWARE RENAISSANCE		FUNCTION	LIST PRICE \$
<b>BRONZE CABINET HARDWARE</b>			
<b>BP736</b> <b>5" Rectangular</b> <b>BP726-8</b> <b>8" Rectangular</b> <b>BP726-12</b> <b>12" Rectangular</b> <b>BP726-20</b> <b>20" Rectangular</b>		3" c-to-c      66 5" c-to-c      130 7" c-to-c      163 11.75" c-to-c   292	
<b>BP737</b> <b>L-shaped Milan</b>			53
<b>BP739</b> <b>Mushroom</b>			53
<b>BP740</b> <b>Sunrise</b>			53
<b>BP741</b> <b>Art Deco Oval</b>			53
<b>BP742</b> <b>Art Deco Round</b>			53
<b>BP743</b> <b>Martini</b>			53
<b>BP744</b> <b>2" Leaf</b>			57

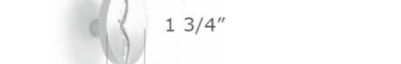
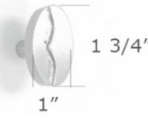
HARDWARE RENAISSANCE			FUNCTION	LIST PRICE \$
BRONZE CABINET HARDWARE				
BP745	Casa California			53
BP746	3" Leaf			70
BP747	Eagle Eye			53
BP749	Whale Tail			53
BP751	Aegean			53
BP752	Scottsdale Square			61
BP753	Oblong			60
BP754	Scottsdale T-Knob			60

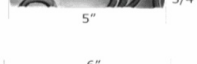
HARDWARE RENAISSANCE		FUNCTION	LIST PRICE \$
<b>BRONZE CABINET HARDWARE</b>			
<b>BP754M</b> <b>Scottsdale 5" double post</b> <b>BP754L</b> <b>Scottsdale 8" single post</b> <b>BP754DL-8</b> <b>Scottsdale 8" double post</b> <b>BP754DL-12</b> <b>Scottsdale 12" double post</b>		3.75" c-to-c N/A 6" c-to-c 10" c-to-c	68 130 130 163
<b>BPR754</b> <b>Scottsdale ROYALE T-Knob</b> Turquoise (TR), Dark Rotile (DR), or Green Opal (OG) stone			78
<b>BPR754M</b> <b>Scottsdale ROYALE 5"</b> <b>BPR754DL-8</b> <b>Scottsdale ROYALE 8"</b> <b>BPR754DL-12</b> <b>Scottsdale ROYALE 12"</b>  Turquoise & Dark Rotile (TDR), Green & Yellow Opal (OGY), or Red Jade & Panther (JRP) combination		3.75" c-to-c 6" c-to-c 8 1/8" c-to-c	108 207 307
<b>BP756N-4</b> <b>4.75" Milan</b> <b>BP756N-6</b> <b>6.75" Milan</b> <b>BP756N-8</b> <b>8.75" Milan</b> <b>BP756N-12</b> <b>12.75" Milan</b>		4" c-to-c 6" c-to-c 8" c-to-c 12" c-to-c	66 90 137 163

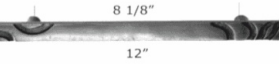

HARDWARE RENAISSANCE			FUNCTION	LIST PRICE \$
BRONZE CABINET HARDWARE				
<b>BP761</b>	<b>Large Melon</b>			66
<b>BP762</b>	<b>Bin Pull</b>			66
<b>BP772-6</b> <b>BP772-8</b> <b>BP772-12</b>	<b>6" Prescott</b> <b>8" Prescott</b> <b>12" Prescott</b>		5" c-to-c 7 1/8" c-to-c 11 1/8" c-to-c	90 137 163
<b>BP774</b>	<b>Milan Rectangular</b>			53
<b>BP775</b>	<b>Milan Square</b>			66
<b>BP779-4</b> <b>BP779-6</b> <b>BP779-9</b> <b>BP779-12</b> <b>BP779-15</b> <b>BP779-24</b>	<b>4 3/8" Stockholm</b> <b>6 3/8" Stockholm</b> <b>9 3/8" Stockholm</b> <b>12 3/8" Stockholm</b> <b>15 3/8" Stockholm</b> <b>24 1/2" Stockholm (5/8" thick)</b>		4" c-to-c 6" c-to-c 9" c-to-c 12" c-to-c 15" c-to-c 24" c-to-c	53 64 90 108 141 218
<b>BP780</b>	<b>Stockholm T- Knob</b>			53
<b>BP781</b>	<b>Ellipse</b>			53

HARDWARE RENAISSANCE		FUNCTION	LIST PRICE \$
<b>BRONZE CABINET HARDWARE</b>			
<b>BP782</b>	<b>Seashell</b>		68
<b>BP785-5</b> <b>BP785-8</b>	<b>5" Soho</b> <b>8" Soho</b>		4.5" c-to-c 7.5" c-to-c 66 112
<b>BP811-5</b> <b>BP811-8</b>	<b>5" Manhattan</b> <b>8" Manhattan</b>		4.5" c-to-c 7.5" c-to-c 66 112
<b>BPG811-5</b> <b>BPG811-8</b>	<b>5" Grande Manhattan</b> <b>8" Grande Manhattan</b> <b>(w/ inlay)</b>	 <p>With hand textured bronze inlay Specify trim/ inlay patina from any of our 16 bronze patinas</p>	4.5" c-to-c 7.5" c-to-c 93 152
<b>BP814-5</b> <b>BP814-8</b>	<b>5" Amalfi (no texture)</b> <b>8" Amalfi (no texture)</b>		4.5" c-to-c 7.5" c-to-c 66 112

HARDWARE RENAISSANCE			FUNCTION	LIST PRICE \$
<b>BRONZE CABINET HARDWARE</b>				
<b>BE816</b>	<b>Amora T- Knob</b>			66
<b>BP816-5</b>	<b>5" Amora</b>		3.75" c-to-c	86
<b>BP816-8</b>	<b>8" Amora</b>		6" c-to-c	141
<b>BP816-12</b>	<b>12" Amora (part texture)</b>	  	8 1/8" c-to-c	179
<b>BP818</b>	<b>Cayman T- Knob</b>			64
<b>BP818-5</b>	<b>5" Cayman</b>		3.75" c-to-c	77
<b>BP818-8</b>	<b>8" Cayman</b>		6" c-to-c	130
<b>BP818-12</b>	<b>12" Cayman</b>	   	8 1/8" c-to-c	179
<b>BP819</b>	<b>Cayman Oval</b>			64
<b>BP822</b>	<b>Aria T- Knob</b>			64
<b>BP822-5</b>	<b>5" Aria</b>		3.75" c-to-c	77
<b>BP822-8</b>	<b>8" Aria</b>		6" c-to-c	130
<b>BP822-12</b>	<b>12" Aria</b>	   	8 1/8" c-to-c	179
<b>BP824-5</b>	<b>5" Fleur de Lis</b>		4.5" c-to-c	79
<b>BP824-8</b>	<b>8" Fleur de Lis</b>		7.5" c-to-c	130

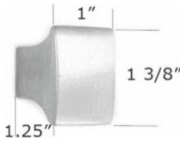
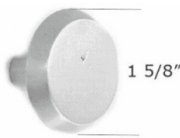
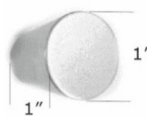
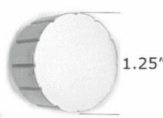
HARDWARE RENAISSANCE			FUNCTION	LIST PRICE \$
<b>BRONZE CABINET HARDWARE</b>				
<b>NEW MID-CENTURY MODERN CABINET PULLS COLLECTION</b>				
<b>BP851-6</b> <b>6" Austin</b> <b>BP851-9</b> <b>9" Austin</b> <b>BP851-12</b> <b>12" Austin</b>		4 7/8" c-to-c 7 7/8" c-to-c 10 7/8" c-to-c	90 137 163	
<b>BP852-5</b> <b>5.5" Palmas</b> <b>BP852-8</b> <b>8.5" Palmas</b>		4 7/16" c-to-c 7 7/16" c-to-c	75 130	
<b>BP853-4</b> <b>4.75" BelAire</b> <b>BP853-8</b> <b>8.75" BelAire</b> <b>BP853-12</b> <b>12.75" BelAire</b>		4" c-to-c 8" c-to-c 12" c-to-c	66 112 151	

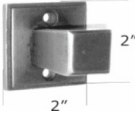
HARDWARE RENAISSANCE		FUNCTION	LIST PRICE \$
<b>BRONZE CABINET HARDWARE</b>			
<b>NEW MID-CENTURY MODERN CABINET KNOBS COLLECTION</b>			
<b>BP856</b>	<b>Imperial</b>		65
<b>BP857</b>	<b>Hancock</b>		65
<b>BP858</b>	<b>Glendale</b>		65
<b>BP859</b>	<b>Brentwood</b>		65

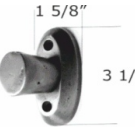
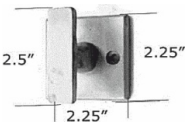
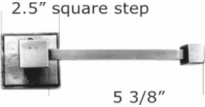
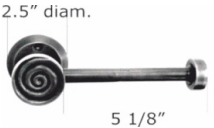
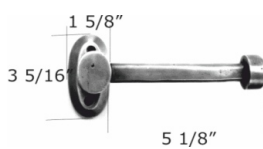
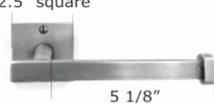
HARDWARE RENAISSANCE			FUNCTION	LIST PRICE \$
<b>BRONZE BATH HARDWARE</b>				
<b>ROBE HOOKS</b>				
<b>BT702</b>	<b>East-West</b>			99
<b>BT703</b>	<b>Casa California</b>			107
<b>BT704</b>	<b>Oval</b>			100
<b>BT705</b>	<b>Scottsdale</b>			100
<b>TOILET PAPER HOLDERS</b>				
<b>BT711</b>	<b>East-West</b>			246
<b>BT712</b>	<b>Casa California</b>			252
<b>BT713</b>	<b>Oval</b>			246
<b>BT715</b>	<b>Scottsdale</b>			246

HARDWARE RENAISSANCE		FUNCTION	LIST PRICE \$
<b>BRONZE BATH HARDWARE</b>			
<b>TOWEL RINGS</b>			
<b>BT745</b>	<b>Scottsdale</b>		379
<b>BT746</b>	<b>East-West</b>		379
<b>BT747</b>	<b>Casa California</b>		396
<b>BT748</b>	<b>Oval</b>		379
<b>TOWEL BARS</b>			
<b>BT612</b> <b>BT618</b> <b>BT624</b> <b>BT636</b>	<b>Leaf 12"</b> <b>Leaf 18"</b> <b>Leaf 24"</b> <b>Leaf 36"</b>		375 435 492 542
<b>BT718</b> <b>BT724</b> <b>BT726</b>	<b>Casa California 18"</b> <b>Casa California 24"</b> <b>Casa California 36"</b>		435 492 542

HARDWARE RENAISSANCE			FUNCTION	LIST PRICE \$
<b>BRONZE BATH HARDWARE</b>				
<b>BT736</b> <b>East-West 18"</b> <b>BT737</b> <b>East-West 24"</b> <b>BT738</b> <b>East-West 36"</b>	<p>18", 24", or 36"</p> <p>2.5" square step</p>			435 492 542
<b>BT751</b> <b>Oval 18"</b> <b>BT752</b> <b>oval 24"</b> <b>BT753</b> <b>Oval 36"</b>	<p>18", 24", or 36"</p> <p>3 5/16"</p> <p>1 5/8"</p>			435 492 542
<b>BT755</b> <b>Scottsdale 18"</b> <b>BT756</b> <b>Scottsdale 24"</b>	<p>18" or 24"</p> <p>2.5" square</p>			435 492





**HR** **HARDWARE  
RENAISSANCE**  
LIKE NO OTHER™

Sante Fe, New Mexico, USA  
[www.hardwarerenaissance.com](http://www.hardwarerenaissance.com)