



**DEALER PRICE LIST**  
**EFFECTIVE MARCH 1, 2022**

**2022**

# TABLE OF CONTENTS

## FREESTANDING RANGES

6	Platinum Series
11	Nova (RNB) Series
25	Precious Metals Series
27	Culinary Series – Open Burner
28	Culinary Series – Sealed Burner
32	Freestanding Range Customization & Accessories

## RANGETOPS & COOKTOPS

34	Platinum Series
39	Nova (RNB) Series
50	Gas Cooktops
51	Induction Cooktop
52	Rangetop & Cooktop Customization & Accessories

## WALL OVENS

54	Gas Wall Ovens
57	Electric Wall Ovens
61	Wall Oven Customization & Accessories

## BROILERS

62	Salamander Broiler
----	--------------------

## REFRIGERATION & DISHWASHER PANEL

64	PRO Built-In Refrigerators
66	Column Refrigerator
68	Column Freezer
71	Freestanding Refrigerator & Dishwasher Panel

## VENTILATION

73	Hood Selection Guide
74	Duct Selection Guide
75	Professional Series Wall Hoods
79	Liners
83	Designer Series Wall Hoods
95	Designer Series Island Hoods
97	Abbaka Series
102	Ventilation Accessories & Wall Liners
103	Customization Summary Guide

## To Place and/or Check Order Status

Phone: (800) 449 – 8691 or (610) 376 – 7479

Submit orders to: [sales@bluestarcooking.com](mailto:sales@bluestarcooking.com)

**When ordering specify LP or Natural Gas, Elevation, etc.**

**Inspect all deliveries immediately upon receipt and prior to signing for items in good condition. Note any damage to the box and/or items and contact BlueStar customer service by email to report damage same day. All shipments are FOB origin. Consignee is responsible for repair/replacement charges and for filing freight claims.**

- BlueStar will ship dealer orders to their designated store or warehouse location
- Orders of \$20,000 or more shipped as one shipment qualify for pre-paid freight
- Freight charges for non-qualifying orders will be subject to the following cost schedule

Ranges, Cooktops, Rangetops, Wall Ovens, Salamander Broiler, Indoor Charbroiler and Ventilation Hoods (Wall or Island with Blower)	\$125
------------------------------------------------------------------------------------------------------------------------------------	-------

Refrigerators	\$200
---------------	-------

- Deliveries requiring Liftgate service will incur a \$30 flat fee per delivery
- Will-Call orders are subject to a \$25 Will-Call charge per order
- The freight program does not apply to small package orders/shipments that would typically be shipped via UPS or FedEx, such as color samples and backguards not shipped with a major unit.
- All freight charges for small package orders/shipments, except for warranty parts, will be invoiced to the dealer.

Get the Look: 60" Nova (RNB) Series Range in Anthracite Grey (RAL 7016) with Antique Brass trim

# Unsurpassed Customization

Available in over 1,000+ colors and finishes with near infinite configuration possibilities, BlueStar® equipment is designed to suit your personal style and unique preferences. Build Your Own BlueStar® today at [www.bluestarcooking.com](http://www.bluestarcooking.com).

## Color

1,000+ Colors & Finishes



## Knob Color

Mix and match to design your dream kitchen



## Metal Trim Options

Stainless Steel, Brushed Brass, Polished Brass, Brushed Copper, Polished Copper, Chrome, Antique Brass, Antique Copper, Oil Rubbed Bronze, and Pewter



## Door Options

Standard, Swing Left, Swing Right, and French Doors



## Burner Configurations

Integrated Griddles, Charbroilers, and French Tops



## Backguard Options

Island, 6", 17", and 24"



## Strapping & Rivets



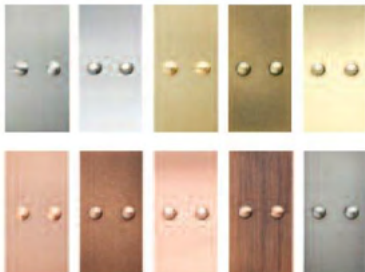

Customize with Stainless Steel or Designer Metals



## Blower Options

In-hood, In-line, and Remote plus CFM Options



MODEL	Feature	Platinum™	Nova (RNB)	Precious Metals	Culinary (RCS) Open	Culinary (RCS) Sealed
						
	Sizes Available	24", 30", 36", 48" & 60"	24", 30", 36", 48" & 60"	30" & 36"	30" & 36"	24", 30", 36" & 48"
PERFORMANCE	25,000 BTU Burners	★				
	22,000 BTU Burners	★	★	★		
	21,000 BTU Burners					★
	18,000 BTU Burner	★		★		
	15,000 BTU Burners	★	★	★	★	★
	Precise Simmer Burner	★	★	★	★	★
	Extra-large convection oven with Infrared Broiler	★	★	★	★	★
	Integrated Wok Cooking	★	★	★	★	
	Interchangeable Griddle & Charbroiler	★				
	PowR™ Oven Technology	★				
CUSTOMIZATION	1,000+ Colors & Finishes	★	★	★		★
	Custom Knobs & Trim Options	★	★	★	★	★
	Custom Door Options	Drop Down Door Only	★	French Doors Only		
	Integrated Top Burner Configurations		★			
	Backguard Options	★	★	Island Trim Only	★	★



## **FREESTANDING RANGES**

Get the Look: 60" Platinum Series Range in Brown Grey (RAL 7013)

## FREESTANDING RANGES: 60" PLATINUM SERIES

BlueStar Model Number Guide:			
<b>Base Model (BSP6010B)</b> 10 Burners   Natural Gas   Stainless Steel Finish   Standard Trim	<b>Change to LP Gas</b> Add (L) for LP/Propane Gas	<b>Add code below for desired color</b> (C) 190 Standard RAL (Semi-Gloss) Colors (CF) Specialty Finish (190 Matte RAL, Precious Metals & Textures) (CC) Custom Colors	<b>Add (PLT) for Plated Trim</b> Includes plated bezels, door handle, handle end and logo. See available options below.

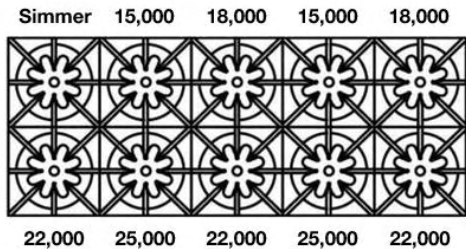

### FEATURES:

- 25,000 BTU PrimaNova™ burners
- All burners, plus Interchangeable Griddle and Charbroiler accessory
- The PowR Oven™ provides 40% faster preheating and 30% increase in oven efficiency
- Precise 130° simmer burner
- Integrated wok cooking
- Extra-large oven with True European Convection and 1850° infrared broiler
- Accommodates a full-size commercial 18" x 26" baking sheet
- Includes full extension rack
- Available in 1,000+ colors and finishes
- Handcrafted in Pennsylvania since 1880

### PRODUCT SPECIFICATIONS:

- Unit Dimensions: 59.875"W x 24"D x 36.75"H
- Oven Interior: 26.438"W x 20"D x 15"H
- Top Burner Power: 25,000 BTUs
- Simmer Burner: 9,000 BTUs
- Electrical Reqs: 120V, 60Hz, 15 AMPS, 1PH
- Gas Pressure: NAT: 5.0" WC, LP 10.0" WC
- Gas Line Size: ¾"
- Unit Weight: 930 lbs.

Model	Description (* Denotes item that must be specified)	UMRP	MSRP
<b>Natural Gas Models: 60" Platinum Series</b>			
BSP6010B	10 Burner   Nat Gas   Stainless Steel   Standard Trim	\$ 18,995	\$ 21,845
BSP6010BPLT	10 Burner   Nat Gas   Stainless Steel   Plated Trim*	\$ 21,405	\$ 24,615
BSP6010BC	10 Burner   Nat Gas   Std RAL Color*   Standard Trim	\$ 20,420	\$ 23,485
BSP6010BCPLT	10 Burner   Nat Gas   Std RAL Color*   Plated Trim*	\$ 22,830	\$ 26,255
BSP6010BCF	10 Burner   Nat Gas   Specialty Finish*   Standard Trim	\$ 21,520	\$ 24,750
BSP6010BCFPLT	10 Burner   Nat Gas   Specialty Finish*   Plated Trim*	\$ 23,930	\$ 27,520
BSP6010BCC	10 Burner   Nat Gas   Custom Color*   Standard Trim	\$ 22,950	\$ 26,390
BSP6010BCCPLT	10 Burner   Nat Gas   Custom Color*   Plated Trim*	\$ 25,360	\$ 29,165
<b>LP/Propane Models: 60" Platinum Series</b>			
BSP6010BL	10 Burner   LP Gas   Stainless Steel   Standard Trim	\$ 18,995	\$ 21,845
BSP6010BLPLT	10 Burner   LP Gas   Stainless Steel   Plated Trim*	\$ 21,405	\$ 24,615
BSP6010BLC	10 Burner   LP Gas   Std RAL Color*   Standard Trim	\$ 20,420	\$ 23,485
BSP6010BLCPLT	10 Burner   LP Gas   Std RAL Color*   Plated Trim*	\$ 22,830	\$ 26,255
BSP6010BLCF	10 Burner   LP Gas   Specialty Finish*   Standard Trim	\$ 21,520	\$ 24,750
BSP6010BLCFPLT	10 Burner   LP Gas   Specialty Finish*   Plated Trim*	\$ 23,930	\$ 27,520
BSP6010BLCC	10 Burner   LP Gas   Custom Color*   Standard Trim	\$ 22,950	\$ 26,390
BSP6010BLCCPLT	10 Burner   LP Gas   Custom Color*   Plated Trim*	\$ 25,360	\$ 29,165
<b>BACKGUARD OPTIONS:</b>			
<b>All BlueStar freestanding appliances must be installed with a UL approved backguard. All units ship standard with a UL approved Island Trim unless otherwise specified.</b>			
BG660BSP	6" Backguard	\$ 1,390	\$ 1,600
BG6017BSP	17" Backguard	\$ 2,255	\$ 2,595
SDHS60BSP	24" High Shelf	\$ 2,635	\$ 3,030
<b>KNOB &amp; PAINTED BODY SIDE OPTIONS: (Total Knobs: 12)</b>			
SIDES-C	Add Painted Sides (All colors)	\$ 695	\$ 800
KN-BLK	Standard Black Knob (Ordered with unit)	N/C	N/C
KN-C	Knob: Standard 190 RAL Color	\$ 115 ea	\$ 130 ea
BZ-C	Bezel: Standard 190 RAL Color	\$ 65 ea	\$ 75 ea
KN-CF	Knob: Spec Finish (Matte RAL, Textured RAL or Prec Metals)	\$ 185 ea	\$ 215 ea
KN-PLT	Knob: Plated Trim (See options below)	\$ 250 ea	\$ 290 ea
<b>PLATED TRIM OPTIONS: (Includes bezels, door handle, handle ends and logo)</b>			
Antique Brass, Brushed Brass, Polished Brass, Antique Copper, Brushed Copper, Polished Copper, Chrome, Oil Rubbed Bronze & Pewter			
See page 32 for additional customization and accessories for Freestanding Ranges			

## FREESTANDING RANGES: 48" PLATINUM SERIES

### BlueStar Model Number Guide:

<b>Base Model (BSP488B)</b> 8 Burners   Natural Gas   Stainless Steel Finish   Standard Trim	<b>Change to LP Gas</b> Add (L) for LP/Propane Gas	<b>Add code below for desired color</b> (C) 190 Standard RAL (Semi-Gloss) Colors (CF) Specialty Finish (190 Matte RAL, Precious Metals & Textures) (CC) Custom Colors	<b>Add (PLT) for Plated Trim</b> Includes plated bezels, door handle, handle end and logo. See available options below.
-------------------------------------------------------------------------------------------------	-------------------------------------------------------	--------------------------------------------------------------------------------------------------------------------------------------------------------------------------------	----------------------------------------------------------------------------------------------------------------------------

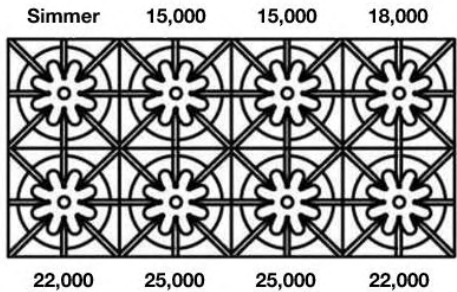

### FEATURES:

- 25,000 BTU PrimaNova™ burners
- All burners, plus Interchangeable Griddle and Charbroiler accessory
- The PowR Oven™ provides 40% faster preheating and 30% increase in oven efficiency
- Precise 130° simmer burner
- Integrated wok cooking
- Extra-large oven with True European Convection and 1850° infrared broiler
- Accommodates a full-size commercial 18" x 26" baking sheet
- Includes full extension rack
- Available in 1,000+ colors and finishes
- Handcrafted in Pennsylvania since 1880

### PRODUCT SPECIFICATIONS:

- Unit Dimensions: 47.875"W x 24"D x 36.75"H
- Large Oven Intr: 26.438"W x 20"D x 15"H
- Small Oven Intr: 13.578"W x 20"D x 15"H
- Top Burner Power: 25,000 BTUs
- Simmer Burner: 9,000 BTUs
- Electrical Reqs: 120V, 60Hz, 15 AMPS, 1PH
- Gas Pressure: NAT: 5.0" WC, LP 10.0" WC
- Gas Line Size: ¾"
- Unit Weight: 750 lbs.

Model	Description (* Denotes item that must be specified)	UMRP	MSRP
<b>Natural Gas Models: 48" Platinum Series</b>			
BSP488B	8 Burner   Nat Gas   Stainless Steel   Standard Trim	\$ 14,295	\$ 16,440
BSP488BPLT	8 Burner   Nat Gas   Stainless Steel   Plated Trim*	\$ 16,390	\$ 18,850
BSP488BC	8 Burner   Nat Gas   Std RAL Color*   Standard Trim	\$ 15,720	\$ 18,080
BSP488BCPLT	8 Burner   Nat Gas   Std RAL Color*   Plated Trim*	\$ 17,815	\$ 20,485
BSP488BCF	8 Burner   Nat Gas   Specialty Finish*   Standard Trim	\$ 16,820	\$ 19,345
BSP488BCFPLT	8 Burner   Nat Gas   Specialty Finish*   Plated Trim*	\$ 18,915	\$ 21,750
BSP488BCC	8 Burner   Nat Gas   Custom Color*   Standard Trim	\$ 18,250	\$ 20,990
BSP488BCCPLT	8 Burner   Nat Gas   Custom Color*   Plated Trim*	\$ 20,345	\$ 23,395
<b>LP/Propane Models: 48" Platinum Series</b>			
BSP488BL	8 Burner   LP Gas   Stainless Steel   Standard Trim	\$ 14,295	\$ 16,440
BSP488BLPLT	8 Burner   LP Gas   Stainless Steel   Plated Trim*	\$ 16,390	\$ 18,850
BSP488BLC	8 Burner   LP Gas   Std RAL Color*   Standard Trim	\$ 15,720	\$ 18,080
BSP488BLCPLT	8 Burner   LP Gas   Std RAL Color*   Plated Trim*	\$ 17,815	\$ 20,485
BSP488BLCF	8 Burner   LP Gas   Specialty Finish*   Standard Trim	\$ 16,820	\$ 19,345
BSP488BLCFPLT	8 Burner   LP Gas   Specialty Finish*   Plated Trim*	\$ 18,915	\$ 21,750
BSP488BLCC	8 Burner   LP Gas   Custom Color*   Standard Trim	\$ 18,250	\$ 20,990
BSP488BLCCPLT	8 Burner   LP Gas   Custom Color*   Plated Trim*	\$ 20,345	\$ 23,395
<b>BACKGUARD OPTIONS:</b>			
<b>All BlueStar freestanding appliances must be installed with a UL approved backguard. All units ship standard with a UL approved Island Trim unless otherwise specified.</b>			
BG648BSP	6" Backguard	\$ 945	\$ 1,085
BG4817BSP	17" Backguard	\$ 1,980	\$ 2,275
SDHS48BSP	24" High Shelf	\$ 2,125	\$ 2,445
<b>KNOB &amp; PAINTED BODY SIDE OPTIONS: (Total Knobs: 10)</b>			
SIDES-C	Add Painted Sides (All colors)	\$ 695	\$ 800
KN-BLK	Standard Black Knob (Ordered with unit)	N/C	N/C
KN-C	Knob: Standard 190 RAL Color	\$ 115 ea	\$ 130 ea
BZ-C	Bezel: Standard 190 RAL Color	\$ 65 ea	\$ 75 ea
KN-CF	Knob: Spec Finish (Matte RAL, Textured RAL or Prec Metals)	\$ 185 ea	\$ 215 ea
KN-PLT	Knob: Plated Trim (See options below)	\$ 250 ea	\$ 290 ea
<b>PLATED TRIM OPTIONS: (Includes bezels, door handle, handle ends and logo)</b>			
Antique Brass, Brushed Brass, Polished Brass, Antique Copper, Brushed Copper, Polished Copper, Chrome, Oil Rubbed Bronze & Pewter			
See page 32 for additional customization and accessories for Freestanding Ranges			

## FREESTANDING RANGES: 36" PLATINUM SERIES

BlueStar Model Number Guide:			
<b>Base Model (BSP366B)</b> 6 Burners   Natural Gas   Stainless Steel Finish   Standard Trim	<b>Change to LP Gas</b> Add (L) for LP/Propane Gas	<b>Add code below for desired color</b> (C) 190 Standard RAL (Semi-Gloss) Colors (CF) Specialty Finish (190 Matte RAL, Precious Metals & Textures) (CC) Custom Colors	<b>Add (PLT) for Plated Trim</b> Includes plated bezels, door handle, handle end and logo. See available options below.

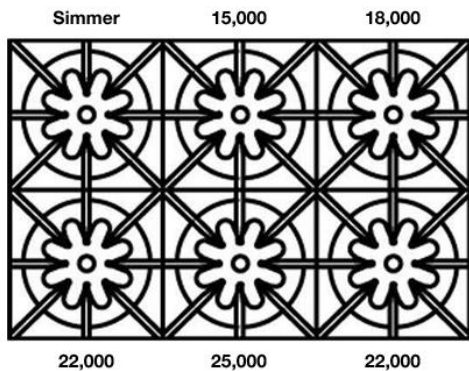

### FEATURES:

- 25,000 BTU PrimaNova™ burners
- All burners, plus Interchangeable Griddle and Charbroiler accessory
- The PowR Oven™ provides 40% faster preheating and 30% increase in oven efficiency
- Precise 130° simmer burner
- Integrated wok cooking
- Extra-large oven with True European Convection and 1850° infrared broiler
- Accommodates a full-size commercial 18" x 26" baking sheet
- Includes full extension rack
- Available in 1,000+ colors and finishes
- Handcrafted in Pennsylvania since 1880

### PRODUCT SPECIFICATIONS:

- Unit Dimensions: 35.875"W x 24"D x 36.75"H
- Oven Interior: 29.25"W x 20"D x 15"H
- Top Burner Power: 25,000 BTUs
- Simmer Burner: 9,000 BTUs
- Electrical Reqs: 120V, 60Hz, 15 AMPS, 1PH
- Gas Pressure: NAT: 5.0" WC, LP 10.0" WC
- Gas Line Size: ½
- Unit Weight: 555 lbs.

Model	Description (* Denotes item that must be specified)	UMRP	MSRP
<b>Natural Gas Models: 36" Platinum Series</b>			
BSP366B	6 Burner   Nat Gas   Stainless Steel   Standard Trim	\$ 10,495	\$ 12,070
BSP366BPLT	6 Burner   Nat Gas   Stainless Steel   Plated Trim*	\$ 12,275	\$ 14,115
BSP366BC	6 Burner   Nat Gas   Std RAL Color*   Standard Trim	\$ 11,590	\$ 13,330
BSP366BCPLT	6 Burner   Nat Gas   Std RAL Color*   Plated Trim*	\$ 13,370	\$ 15,375
BSP366BCF	6 Burner   Nat Gas   Specialty Finish*   Standard Trim	\$ 12,580	\$ 14,465
BSP366BCFPLT	6 Burner   Nat Gas   Specialty Finish*   Plated Trim*	\$ 14,360	\$ 16,515
BSP366BCC	6 Burner   Nat Gas   Custom Color*   Standard Trim	\$ 14,010	\$ 16,110
BSP366BCCPLT	6 Burner   Nat Gas   Custom Color*   Plated Trim*	\$ 15,790	\$ 18,160
<b>LP/Propane Models: 36" Platinum Series</b>			
BSP366BL	6 Burner   LP Gas   Stainless Steel   Standard Trim	\$ 10,495	\$ 12,070
BSP366BLPLT	6 Burner   LP Gas   Stainless Steel   Plated Trim*	\$ 12,275	\$ 14,115
BSP366BLC	6 Burner   LP Gas   Std RAL Color*   Standard Trim	\$ 11,590	\$ 13,330
BSP366BLCPLT	6 Burner   LP Gas   Std RAL Color*   Plated Trim*	\$ 13,370	\$ 15,375
BSP366BLCF	6 Burner   LP Gas   Specialty Finish*   Standard Trim	\$ 12,580	\$ 14,465
BSP366BLCFPLT	6 Burner   LP Gas   Specialty Finish*   Plated Trim*	\$ 14,360	\$ 16,515
BSP366BLCC	6 Burner   LP Gas   Custom Color*   Standard Trim	\$ 14,010	\$ 16,110
BSP366BLCCPLT	6 Burner   LP Gas   Custom Color*   Plated Trim*	\$ 15,790	\$ 18,160
<b>BACKGUARD OPTIONS:</b>			
All BlueStar freestanding appliances must be installed with a UL approved backguard. All units ship standard with a UL approved Island Trim unless otherwise specified.			
BG636BSP	6" Backguard	\$ 655	\$ 755
BG3617BSP	17" Backguard	\$ 1,325	\$ 1,525
SDHS36BSP	24" High Shelf	\$ 1,535	\$ 1,765
<b>KNOB &amp; PAINTED BODY SIDE OPTIONS: (Total Knobs: 7)</b>			
SIDES-C	Add Painted Sides (All colors)	\$ 695	\$ 800
KN-BLK	Standard Black Knob (Ordered with unit)	N/C	N/C
KN-C	Knob: Standard 190 RAL Color	\$ 115 ea	\$ 130 ea
BZ-C	Bezel: Standard 190 RAL Color	\$ 65 ea	\$ 75 ea
KN-CF	Knob: Spec Finish (Matte RAL, Textured RAL or Prec Metals)	\$ 185 ea	\$ 215 ea
KN-PLT	Knob: Plated Trim (See options below)	\$ 250 ea	\$ 290 ea
<b>PLATED TRIM OPTIONS: (Includes bezels, door handle, handle ends and logo)</b>			
Antique Brass, Brushed Brass, Polished Brass, Antique Copper, Brushed Copper, Polished Copper, Chrome, Oil Rubbed Bronze & Pewter			
See page 32 for additional customization and accessories for Freestanding Ranges			

## FREESTANDING RANGES: 30" PLATINUM SERIES

### BlueStar Model Number Guide:

<b>Base Model (BSP304B)</b> 4 Burners   Natural Gas   Stainless Steel Finish   Standard Trim	<b>Change to LP Gas</b> Add (L) for LP/Propane Gas	<b>Add code below for desired color</b> (C) 190 Standard RAL (Semi-Gloss) Colors (CF) Specialty Finish (190 Matte RAL, Precious Metals & Textures) (CC) Custom Colors	<b>Add (PLT) for Plated Trim</b> Includes plated bezels, door handle, handle end and logo. See available options below.
-------------------------------------------------------------------------------------------------	-------------------------------------------------------	--------------------------------------------------------------------------------------------------------------------------------------------------------------------------------	----------------------------------------------------------------------------------------------------------------------------

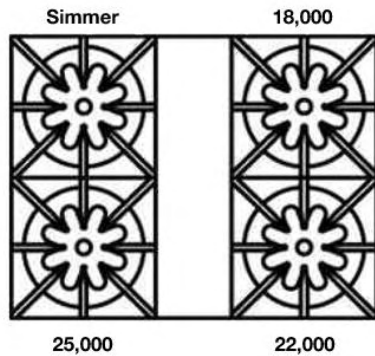

#### FEATURES:

- 25,000 BTU PrimaNova™ burners
- All burners, plus Interchangeable Griddle and Charbroiler accessory
- The PowR Oven™ provides 40% faster preheating and 30% increase in oven efficiency
- Precise 130° simmer burner
- Integrated wok cooking
- Extra-large oven with True European Convection and 1850° infrared broiler
- Accommodates a full-size commercial 18" x 26" baking sheet
- Available in 1,000+ colors and finishes
- Includes full extension rack
- Handcrafted in Pennsylvania since 1880

#### PRODUCT SPECIFICATIONS:

- Unit Dimensions: 29.875W x 24"D x 36.75"H
- Oven Interior: 26.438"W x 20"D x 15"H
- Top Burner Power: 25,000 BTUs
- Simmer Burner: 9,000 BTUs
- Electrical Reqs: 120V, 60Hz, 15 AMPS, 1PH
- Gas Pressure: NAT: 5.0" WC, LP 10.0" WC
- Gas Line Size: ½
- Unit Weight: 480 lbs.

Model	Description (* Denotes item that must be specified)	UMRP	MSRP
<b>Natural Gas Models: 30" Platinum Series</b>			
BSP304B	4 Burner   Nat Gas   Stainless Steel   Standard Trim	\$ 7,795	\$ 8,965
BSP304BPLT	4 Burner   Nat Gas   Stainless Steel   Plated Trim*	\$ 9,260	\$ 10,650
BSP304BC	4 Burner   Nat Gas   Std RAL Color*   Standard Trim	\$ 8,890	\$ 10,225
BSP304BCPLT	4 Burner   Nat Gas   Std RAL Color*   Plated Trim*	\$ 10,355	\$ 11,910
BSP304BCF	4 Burner   Nat Gas   Specialty Finish*   Standard Trim	\$ 9,880	\$ 11,360
BSP304CFPLT	4 Burner   Nat Gas   Specialty Finish*   Plated Trim*	\$ 11,345	\$ 13,045
BSP304BCC	4 Burner   Nat Gas   Custom Color*   Standard Trim	\$ 11,310	\$ 13,005
BSP304BCCPLT	4 Burner   Nat Gas   Custom Color*   Plated Trim*	\$ 12,775	\$ 14,690
<b>LP/Propane Models: 30" Platinum Series</b>			
BSP304BL	4 Burner   LP Gas   Stainless Steel   Standard Trim	\$ 7,795	\$ 8,965
BSP304BLPLT	4 Burner   LP Gas   Stainless Steel   Plated Trim*	\$ 9,260	\$ 10,650
BSP304BLC	4 Burner   LP Gas   Std RAL Color*   Standard Trim	\$ 8,890	\$ 10,225
BSP304BLCPLT	4 Burner   LP Gas   Std RAL Color*   Plated Trim*	\$ 10,355	\$ 11,910
BSP304BLCF	4 Burner   LP Gas   Specialty Finish*   Standard Trim	\$ 9,880	\$ 11,360
BSP304BLCFPLT	4 Burner   LP Gas   Specialty Finish*   Plated Trim*	\$ 11,345	\$ 13,045
BSP304BLCC	4 Burner   LP Gas   Custom Color*   Standard Trim	\$ 11,310	\$ 13,005
BSP304BLCCPLT	4 Burner   LP Gas   Custom Color*   Plated Trim*	\$ 12,775	\$ 14,690
<b>BACKGUARD OPTIONS:</b>			
All BlueStar freestanding appliances must be installed with a UL approved backguard. All units ship standard with a UL approved Island Trim unless otherwise specified.			
BG630BSP	6" Backguard	\$ 550	\$ 635
BG3017BSP	17" Backguard	\$ 1,020	\$ 1,175
SDHS30BSP	24" High Shelf	\$ 1,325	\$ 1,525
<b>KNOB &amp; PAINTED BODY SIDE OPTIONS: (Total Knobs: 5)</b>			
SIDES-C	Add Painted Sides (All colors)	\$ 695	\$ 800
KN-BLK	Standard Black Knob (Ordered with unit)	N/C	N/C
KN-C	Knob: Standard 190 RAL Color	\$ 115 ea	\$ 130 ea
BZ-C	Bezel: Standard 190 RAL Color	\$ 65 ea	\$ 75 ea
KN-CF	Knob: Spec Finish (Matte RAL, Textured RAL or Prec Metals)	\$ 185 ea	\$ 215 ea
KN-PLT	Knob: Plated Trim (See options below)	\$ 250 ea	\$ 290 ea
<b>PLATED TRIM OPTIONS: (Includes bezels, door handle, handle ends and logo)</b>			
Antique Brass, Brushed Brass, Polished Brass, Antique Copper, Brushed Copper, Polished Copper, Chrome, Oil Rubbed Bronze & Pewter			
See page 32 for additional customization and accessories for Freestanding Ranges			

## FREESTANDING RANGES: 24" PLATINUM SERIES

BlueStar Model Number Guide:			
<b>Base Model (BSP244B)</b> 4 Burners   Natural Gas   Stainless Steel Finish   Standard Trim	<b>Change to LP Gas</b> Add (L) for LP/Propane Gas	<b>Add code below for desired color</b> (C) 190 Standard RAL (Semi-Gloss) Colors (CF) Specialty Finish (190 Matte RAL, Precious Metals & Textures) (CC) Custom Colors	<b>Add (PLT) for Plated Trim</b> Includes plated bezels, door handle, handle end and logo. See available options below.

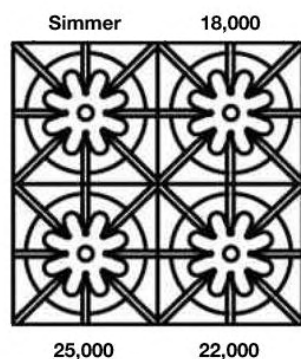

### FEATURES:

- 25,000 BTU PrimaNova™ burners
- All burners, plus Interchangeable Griddle and Charbroiler accessory
- The PowR Oven™ provides 40% faster preheating and 30% increase in oven efficiency
- Precise 130° simmer burner
- Integrated wok cooking
- Extra-large oven with True European Convection and 1850° infrared broiler
- Accommodates a half-size commercial 18" x 13" baking sheet
- Includes full extension rack
- Available in 1,000+ colors and finishes
- Handcrafted in Pennsylvania since 1880

### PRODUCT SPECIFICATIONS:

- Unit Dimensions: 23.875"W x 24"D x 36.75"H
- Oven Interior: 20.25"W x 20"D x 15"H
- Top Burner Power: 25,000 BTUs
- Simmer Burner: 9,000 BTUs
- Electrical Reqs: 120V, 60Hz, 15 AMPS, 1PH
- Gas Pressure: NAT: 5.0" WC, LP 10.0" WC
- Gas Line Size: ½
- Unit Weight: 435 lbs.

Model	Description (* Denotes item that must be specified)	UMRP	MSRP
<b>Natural Gas Models: 24" Platinum Series</b>			
BSP244B	4 Burner   Nat Gas   Stainless Steel   Standard Trim	\$ 7,095	\$ 8,160
BSP244BPLT	4 Burner   Nat Gas   Stainless Steel   Plated Trim*	\$ 8,560	\$ 9,845
BSP244BC	4 Burner   Nat Gas   Std RAL Color*   Standard Trim	\$ 8,190	\$ 9,420
BSP244BCPLT	4 Burner   Nat Gas   Std RAL Color*   Plated Trim*	\$ 9,655	\$ 11,105
BSP244BCF	4 Burner   Nat Gas   Specialty Finish*   Standard Trim	\$ 9,180	\$ 10,555
BSP244BCFPLT	4 Burner   Nat Gas   Specialty Finish*   Plated Trim*	\$ 10,645	\$ 12,240
BSP244BCC	4 Burner   Nat Gas   Custom Color*   Standard Trim	\$ 10,610	\$ 12,200
BSP244BCCPLT	4 Burner   Nat Gas   Custom Color*   Plated Trim*	\$ 12,075	\$ 13,885
<b>LP/Propane Models: 24" Platinum Series</b>			
BSP244BL	4 Burner   LP Gas   Stainless Steel   Standard Trim	\$ 7,095	\$ 8,160
BSP244BLPLT	4 Burner   LP Gas   Stainless Steel   Plated Trim*	\$ 8,560	\$ 9,845
BSP244BLC	4 Burner   LP Gas   Std RAL Color*   Standard Trim	\$ 8,190	\$ 9,420
BSP244BLCPLT	4 Burner   LP Gas   Std RAL Color*   Plated Trim*	\$ 9,655	\$ 11,105
BSP244BLCF	4 Burner   LP Gas   Specialty Finish*   Standard Trim	\$ 9,180	\$ 10,555
BSP244BLCFPLT	4 Burner   LP Gas   Specialty Finish*   Plated Trim*	\$ 10,645	\$ 12,240
BSP244BLCC	4 Burner   LP Gas   Custom Color*   Standard Trim	\$ 10,610	\$ 12,200
BSP244BLCCPLT	4 Burner   LP Gas   Custom Color*   Plated Trim*	\$ 12,075	\$ 13,885
<b>BACKGUARD OPTIONS:</b>			
All BlueStar freestanding appliances must be installed with a UL approved backguard. All units ship standard with a UL approved Island Trim unless otherwise specified.			
BG624BSP	6" Backguard	\$ 550	\$ 635
BG2417BSP	17" Backguard	\$ 1,020	\$ 1,175
SDHS24BSP	24" High Shelf	\$ 1,325	\$ 1,525
<b>ADDITIONAL PAINT, KNOB AND CUSTOMIZATION OPTIONS: (Total Knobs: 5)</b>			
SIDES-C	Add Painted Sides (All colors)	\$ 695	\$ 800
KN-BLK	Standard Black Knob (Ordered with unit)	N/C	N/C
KN-C	Knob: Standard 190 RAL Color	\$ 115 ea	\$ 130 ea
BZ-C	Bezel: Standard 190 RAL Color	\$ 65 ea	\$ 75 ea
KN-CF	Knob: Spec Finish (Matte RAL, Textured RAL or Prec Metals)	\$ 185 ea	\$ 215 ea
KN-PLT	Knob: Plated Trim (See options below)	\$ 250 ea	\$ 290 ea
<b>PLATED TRIM OPTIONS: (Includes bezels, door handle, handle ends and logo)</b>			
Antique Brass, Brushed Brass, Polished Brass, Antique Copper, Brushed Copper, Polished Copper, Chrome, Oil Rubbed Bronze & Pewter			
See page 32 for additional customization and accessories for Freestanding Ranges			

## FREESTANDING RANGES: 60" NOVA (RNB) SERIES

### BlueStar Model Number Guide:

<b>Base Model (RNB6010BV2)</b> 10 Burners   Natural Gas   Stainless Steel Finish   Standard Trim	<b>Change to LP Gas</b> Add (L) for LP/Propane Gas	<b>Add code below for desired color</b> (C) 190 Standard RAL (Semi-Gloss) Colors (CF) Specialty Finish (190 Matte RAL, Precious Metals & Textures) (CC) Custom Colors	<b>Add (PLT) for Plated Trim</b> Includes plated bezels, door handle, handle end and logo. See available options below.
-----------------------------------------------------------------------------------------------------	-------------------------------------------------------	--------------------------------------------------------------------------------------------------------------------------------------------------------------------------------	----------------------------------------------------------------------------------------------------------------------------



Simmer 15,000 15,000 15,000 15,000

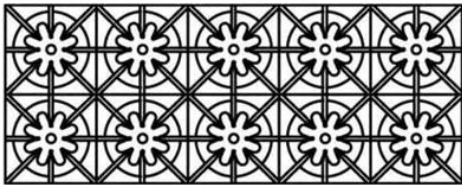

22,000 15,000 15,000 15,000 22,000

#### FEATURES:

- 22,000 BTU UltraNova™ burners & 15,000 BTU Nova™ burners
- Available with all burners or add integrated griddle, charbroiler or French top
- Extra-large convection oven with 1850° infrared broiler that accommodates a full size 18" x 26" commercial baking sheet
- Available with swing doors
- Available in 1,000+ colors & finishes plus additional customization options
- Handcrafted in Pennsylvania since 1880

#### PRODUCT SPECIFICATIONS:

- Unit Dimensions: 59.875"W x 24"D x 36.75"H
- Oven Interior: 26.438"W x 20"D x 15"H
- Top Burner Power: 22,000 BTUs
- Simmer Burner: 9,000 BTUs
- Electrical Reqs: 120V, 60Hz, 15 AMPS, 1PH
- Gas Pressure: NAT: 5.0" WC, LP 10.0" WC
- Gas Line Size: ¾"
- Unit Weight: 800 lbs.

Model	Description (* Denotes item that must be specified)	UMRP	MSRP
<b>Natural Gas Models: 60" Nova (RNB) Series</b>			
RNB6010BV2	10 Burner   Nat Gas   Stainless Steel   Standard Trim	\$ 18,795	\$ 21,615
RNB6010BV2PLT	10 Burner   Nat Gas   Stainless Steel   Plated Trim*	\$ 21,205	\$ 24,385
RNB6010BV2C	10 Burner   Nat Gas   Std RAL Color*   Standard Trim	\$ 20,220	\$ 23,255
RNB6010BV2CPLT	10 Burner   Nat Gas   Std RAL Color*   Plated Trim*	\$ 22,630	\$ 26,025
RNB6010BV2CF	10 Burner   Nat Gas   Specialty Finish*   Standard Trim	\$ 21,320	\$ 24,520
RNB6010BV2CFPLT	10 Burner   Nat Gas   Specialty Finish*   Plated Trim*	\$ 23,730	\$ 27,290
RNB6010BV2CC	10 Burner   Nat Gas   Custom Color*   Standard Trim	\$ 22,750	\$ 26,160
RNB6010BV2CCPLT	10 Burner   Nat Gas   Custom Color*   Plated Trim*	\$ 25,160	\$ 28,935
<b>LP/Propane Models: 60" Nova (RNB) Series</b>			
RNB6010BV2L	10 Burner   LP Gas   Stainless Steel   Standard Trim	\$ 18,795	\$ 21,615
RNB6010BV2LPLT	10 Burner   LP Gas   Stainless Steel   Plated Trim*	\$ 21,205	\$ 24,385
RNB6010BV2LC	10 Burner   LP Gas   Std RAL Color*   Standard Trim	\$ 20,220	\$ 23,255
RNB6010BV2LCPLT	10 Burner   LP Gas   Std RAL Color*   Plated Trim*	\$ 22,630	\$ 26,025
RNB6010BV2LCF	10 Burner   LP Gas   Specialty Finish*   Standard Trim	\$ 21,320	\$ 24,520
RNB6010BV2LCFPLT	10 Burner   LP Gas   Specialty Finish*   Plated Trim*	\$ 23,730	\$ 27,290
RNB6010BV2LCC	10 Burner   LP Gas   Custom Color*   Standard Trim	\$ 22,750	\$ 26,160
RNB6010BV2LCCPLT	10 Burner   LP Gas   Custom Color*   Plated Trim*	\$ 25,160	\$ 28,935
<b>BACKGUARD OPTIONS:</b>			
<b>All BlueStar freestanding appliances must be installed with a UL approved backguard. All units ship standard with a UL approved Island Trim unless otherwise specified.</b>			
BG660BSP	6" Backguard	\$ 1,390	\$ 1,600
BG6017BSP	17" Backguard	\$ 2,255	\$ 2,595
SDHS60BSP	24" High Shelf	\$ 2,635	\$ 3,030
<b>KNOB &amp; PAINTED BODY SIDE OPTIONS: (Total Knobs: 12)</b>			
SIDES-C	Add Painted Sides (All colors)	\$ 695	\$ 800
KN-BLK	Standard Black Knob (Ordered with unit)	N/C	N/C
KN-C	Knob: Standard 190 RAL Color	\$ 115 ea	\$ 130 ea
BZ-C	Bezel: Standard 190 RAL Color	\$ 65 ea	\$ 75 ea
KN-CF	Knob: Spec Finish (Matte RAL, Textured RAL or Prec Metals)	\$ 185 ea	\$ 215 ea
KN-PLT	Knob: Plated Trim (See options below)	\$ 250 ea	\$ 290 ea
<b>SWING DOOR OPTIONS:</b>			
SWING DOOR – LH	Swing Door – Left Hinge for Nova (RNB) Series	\$ 1,390	\$ 1,600
SWING DOOR – RH	Swing Door – Right Hinge for Nova (RNB) Series	\$ 1,390	\$ 1,600
<b>PLATED TRIM OPTIONS: (Includes bezels, door handle, handle ends and logo)</b>			
Antique Brass, Brushed Brass, Polished Brass, Antique Copper, Brushed Copper, Polished Copper, Chrome, Oil Rubbed Bronze & Pewter			
See page 32 for additional customization and accessories for Freestanding Ranges			

## FREESTANDING RANGES: 60" NOVA (RNB) SERIES

**60" Nova (RNB) Series  
with 12" Charbroiler**

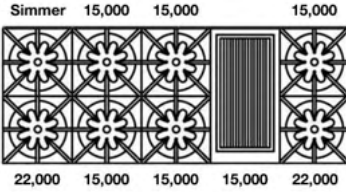

Model	Description (* Denotes item that must be specified)	UMRP	MSRP
<b>Natural Gas Models: 60" Nova Series with 12" Charbroiler</b>			
RNB608CBV2	8 Burner   12" Charbroiler   Nat Gas   Stainless Steel   Standard Trim	\$ 17,995	\$ 20,695
RNB608CBV2PLT	8 Burner   12" Charbroiler   Nat Gas   Stainless Steel   Plated Trim*	\$ 20,405	\$ 23,465
RNB608CBV2C	8 Burner   12" Charbroiler   Nat Gas   Std RAL Paint*   Standard Trim	\$ 19,420	\$ 22,335
RNB608CBV2CPLT	8 Burner   12" Charbroiler   Nat Gas   Std RAL Paint*   Plated Trim*	\$ 21,830	\$ 25,105
RNB608CBV2CF	8 Burner   12" Charbroiler   Nat Gas   Specialty Finish*   Standard Trim	\$ 20,520	\$ 23,600
RNB608CBV2CFPLT	8 Burner   12" Charbroiler   Nat Gas   Specialty Finish*   Plated Trim*	\$ 22,930	\$ 26,370
RNB608CBV2CC	8 Burner   12" Charbroiler   Nat Gas   Custom Color*   Standard Trim	\$ 21,950	\$ 25,240
RNB608CBV2CCPLT	8 Burner   12" Charbroiler   Nat Gas   Custom Color*   Plated Trim*	\$ 24,360	\$ 28,015
<b>LP/Propane Models: 60" Nova Series with 12" Charbroiler</b>			
RNB608CBV2L	8 Burner   12" Charbroiler   LP Gas   Stainless Steel   Standard Trim	\$ 17,995	\$ 20,695
RNB608CBV2LPLT	8 Burner   12" Charbroiler   LP Gas   Stainless Steel   Plated Trim*	\$ 20,405	\$ 23,465
RNB608CBV2LC	8 Burner   12" Charbroiler   LP Gas   Std RAL Paint*   Standard Trim	\$ 19,420	\$ 22,335
RNB608CBV2LCPLT	8 Burner   12" Charbroiler   LP Gas   Std RAL Paint*   Plated Trim*	\$ 21,830	\$ 25,105
RNB608CBV2LCF	8 Burner   12" Charbroiler   LP Gas   Specialty Finish*   Standard Trim	\$ 20,520	\$ 23,600
RNB608CBV2LCFPLT	8 Burner   12" Charbroiler   LP Gas   Specialty Finish*   Plated Trim*	\$ 22,930	\$ 26,370
RNB608CBV2LCC	8 Burner   12" Charbroiler   LP Gas   Custom Color*   Standard Trim	\$ 21,950	\$ 25,240
RNB608CBV2LCCPLT	8 Burner   12" Charbroiler   LP Gas   Custom Color*   Plated Trim*	\$ 24,360	\$ 28,015
<b>Customization &amp; Accessory Options: (See page 21)   Total Knobs: 11</b>			

**60" Nova (RNB) Series  
with 24" Charbroiler**

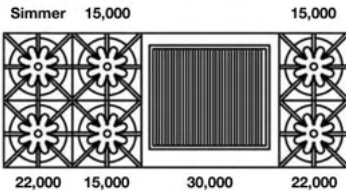

<b>Natural Gas Models: 60" Nova Series with 24" Charbroiler</b>			
RNB606CBV2	6 Burner   24" Charbroiler   Nat Gas   Stainless Steel   Standard Trim	\$ 18,495	\$ 21,270
RNB606CBV2PLT	6 Burner   24" Charbroiler   Nat Gas   Stainless Steel   Plated Trim*	\$ 20,905	\$ 24,040
RNB606CBV2C	6 Burner   24" Charbroiler   Nat Gas   Std RAL Paint*   Standard Trim	\$ 19,920	\$ 22,910
RNB606CBV2CPLT	6 Burner   24" Charbroiler   Nat Gas   Std RAL Paint*   Plated Trim*	\$ 22,330	\$ 25,680
RNB606CBV2CF	6 Burner   24" Charbroiler   Nat Gas   Specialty Finish*   Standard Trim	\$ 21,020	\$ 24,175
RNB606CBV2CFPLT	6 Burner   24" Charbroiler   Nat Gas   Specialty Finish*   Plated Trim*	\$ 23,430	\$ 26,945
RNB606CBV2CC	6 Burner   24" Charbroiler   Nat Gas   Custom Color*   Standard Trim	\$ 22,450	\$ 25,815
RNB606CBV2CCPLT	6 Burner   24" Charbroiler   Nat Gas   Custom Color*   Plated Trim*	\$ 24,860	\$ 28,590
<b>LP/Propane Models: 60" Nova Series with 24" Charbroiler</b>			
RNB606CBV2L	6 Burner   24" Charbroiler   LP Gas   Stainless Steel   Standard Trim	\$ 18,495	\$ 21,270
RNB606CBV2LPLT	6 Burner   24" Charbroiler   LP Gas   Stainless Steel   Plated Trim*	\$ 20,905	\$ 24,040
RNB606CBV2LC	6 Burner   24" Charbroiler   LP Gas   Std RAL Paint*   Standard Trim	\$ 19,920	\$ 22,910
RNB606CBV2LCPLT	6 Burner   24" Charbroiler   LP Gas   Std RAL Paint*   Plated Trim*	\$ 22,330	\$ 25,680
RNB606CBV2LCF	6 Burner   24" Charbroiler   LP Gas   Specialty Finish*   Standard Trim	\$ 21,020	\$ 24,175
RNB606CBV2LCFPLT	6 Burner   24" Charbroiler   LP Gas   Specialty Finish*   Plated Trim*	\$ 23,430	\$ 26,945
RNB606CBV2LCC	6 Burner   24" Charbroiler   LP Gas   Custom Color*   Standard Trim	\$ 22,450	\$ 25,815
RNB606CBV2LCCPLT	6 Burner   24" Charbroiler   LP Gas   Custom Color*   Plated Trim*	\$ 24,860	\$ 28,590
<b>Customization &amp; Accessory Options: (See page 21)   Total Knobs: 10</b>			

## FREESTANDING RANGES: 60" NOVA (RNB) SERIES

### 60" Nova (RNB) Series with 12" Griddle

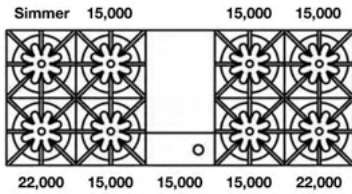

Model	Description (* Denotes item that must be specified)	UMRP	MSRP
<b>Natural Gas Models: 60" Nova Series with 12" Griddle</b>			
RNB608GV2	8 Burner   12" Griddle   Nat Gas   Stainless Steel   Standard Trim	\$ 17,995	\$ 20,695
RNB608GV2PLT	8 Burner   12" Griddle   Nat Gas   Stainless Steel   Plated Trim*	\$ 20,405	\$ 23,465
RNB608GV2C	8 Burner   12" Griddle   Nat Gas   Std RAL Paint*   Standard Trim	\$ 19,420	\$ 22,335
RNB608GV2CPLT	8 Burner   12" Griddle   Nat Gas   Std RAL Paint*   Plated Trim*	\$ 21,830	\$ 25,105
RNB608GV2CF	8 Burner   12" Griddle   Nat Gas   Specialty Finish*   Standard Trim	\$ 20,520	\$ 23,600
RNB608GV2CFPLT	8 Burner   12" Griddle   Nat Gas   Specialty Finish*   Plated Trim*	\$ 22,930	\$ 26,370
RNB608GV2CC	8 Burner   12" Griddle   Nat Gas   Custom Color*   Standard Trim	\$ 21,950	\$ 25,240
RNB608GV2CCPLT	8 Burner   12" Griddle   Nat Gas   Custom Color*   Plated Trim*	\$ 24,360	\$ 28,015
<b>LP/Propane Models: 60" Nova Series with 12" Griddle</b>			
RNB608GV2L	8 Burner   12" Griddle   LP Gas   Stainless Steel   Standard Trim	\$ 17,995	\$ 20,695
RNB608GV2LPLT	8 Burner   12" Griddle   LP Gas   Stainless Steel   Plated Trim*	\$ 20,405	\$ 23,465
RNB608GV2LC	8 Burner   12" Griddle   LP Gas   Std RAL Paint*   Standard Trim	\$ 19,420	\$ 22,335
RNB608GV2LCPLT	8 Burner   12" Griddle   LP Gas   Std RAL Paint*   Plated Trim*	\$ 21,830	\$ 25,105
RNB608GV2LCF	8 Burner   12" Griddle   LP Gas   Specialty Finish*   Standard Trim	\$ 20,520	\$ 23,600
RNB608GV2LCFPLT	8 Burner   12" Griddle   LP Gas   Specialty Finish*   Plated Trim*	\$ 22,930	\$ 26,370
RNB608GV2LCC	8 Burner   12" Griddle   LP Gas   Custom Color*   Standard Trim	\$ 21,950	\$ 25,240
RNB608GV2LCCPLT	8 Burner   12" Griddle   LP Gas   Custom Color*   Plated Trim*	\$ 24,360	\$ 28,015
<b>Customization &amp; Accessory Options: (See page 21)   Total Knobs: 11</b>			

### 60" Nova (RNB) Series with 24" Griddle

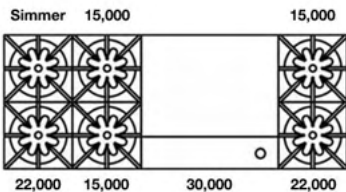

<b>Natural Gas Models: 60" Nova Series with 24" Griddle</b>			
RNB606GV2	6 Burner   24" Griddle   Nat Gas   Stainless Steel   Standard Trim	\$ 18,695	\$ 21,500
RNB606GV2PLT	6 Burner   24" Griddle   Nat Gas   Stainless Steel   Plated Trim*	\$ 21,105	\$ 24,270
RNB606GV2C	6 Burner   24" Griddle   Nat Gas   Std RAL Paint*   Standard Trim	\$ 20,120	\$ 23,140
RNB606GV2CPLT	6 Burner   24" Griddle   Nat Gas   Std RAL Paint*   Plated Trim*	\$ 22,530	\$ 25,910
RNB606GV2CF	6 Burner   24" Griddle   Nat Gas   Specialty Finish*   Standard Trim	\$ 21,220	\$ 24,405
RNB606GV2CFPLT	6 Burner   24" Griddle   Nat Gas   Specialty Finish*   Plated Trim*	\$ 23,630	\$ 27,175
RNB606GV2CC	6 Burner   24" Griddle   Nat Gas   Custom Color*   Standard Trim	\$ 22,650	\$ 26,045
RNB606GV2CCPLT	6 Burner   24" Griddle   Nat Gas   Custom Color*   Plated Trim*	\$ 25,060	\$ 28,820
<b>LP/Propane Models: 60" Nova Series with 24" Griddle</b>			
RNB606GV2L	6 Burner   24" Griddle   LP Gas   Stainless Steel   Standard Trim	\$ 18,695	\$ 21,500
RNB606GV2LPLT	6 Burner   24" Griddle   LP Gas   Stainless Steel   Plated Trim*	\$ 21,105	\$ 24,270
RNB606GV2LC	6 Burner   24" Griddle   LP Gas   Std RAL Paint*   Standard Trim	\$ 20,120	\$ 23,140
RNB606GV2LCPLT	6 Burner   24" Griddle   LP Gas   Std RAL Paint*   Plated Trim*	\$ 22,530	\$ 25,910
RNB606GV2LCF	6 Burner   24" Griddle   LP Gas   Specialty Finish*   Standard Trim	\$ 21,220	\$ 24,405
RNB606GV2LCFPLT	6 Burner   24" Griddle   LP Gas   Specialty Finish*   Plated Trim*	\$ 23,630	\$ 27,175
RNB606GV2LCC	6 Burner   24" Griddle   LP Gas   Custom Color*   Standard Trim	\$ 22,650	\$ 26,045
RNB606GV2LCCPLT	6 Burner   24" Griddle   LP Gas   Custom Color*   Plated Trim*	\$ 25,060	\$ 28,820
<b>Customization &amp; Accessory Options: (See page 21)   Total Knobs: 10</b>			

## FREESTANDING RANGES: 60" NOVA (RNB) SERIES

**60" Nova (RNB) Series  
with 12" Griddle & Charbroiler**

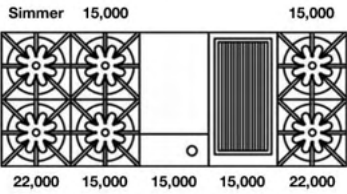

Model	Description (* Denotes item that must be specified)	UMRP	MSRP
<b>Natural Gas Models: 60" Nova Series with 12" Griddle &amp; Charbroiler</b>			
RNB606GCBV2	6 Burner   12" Griddle & Char Br.   Nat Gas   Stainless Steel   Standard Trim	\$ 18,895	\$ 21,730
RNB606GCBV2PLT	6 Burner   12" Griddle & Char Br.   Nat Gas   Stainless Steel   Plated Trim*	\$ 21,305	\$ 24,500
RNB606GCBV2C	6 Burner   12" Griddle & Char Br.   Nat Gas   Std RAL Paint*   Standard Trim	\$ 20,320	\$ 23,370
RNB606GCBV2CPLT	6 Burner   12" Griddle & Char Br.   Nat Gas   Std RAL Paint*   Plated Trim*	\$ 22,730	\$ 26,140
RNB606GCBV2CF	6 Burner   12" Griddle & Char Br.   Nat Gas   Specialty Finish*   Standard Trim	\$ 21,420	\$ 24,635
RNB606GCBV2CFPLT	6 Burner   12" Griddle & Char Br.   Nat Gas   Specialty Finish*   Plated Trim*	\$ 23,830	\$ 27,405
RNB606GCBV2CC	6 Burner   12" Griddle & Char Br.   Nat Gas   Custom Color*   Standard Trim	\$ 22,850	\$ 26,275
RNB606GCBV2CCPLT	6 Burner   12" Griddle & Char Br.   Nat Gas   Custom Color*   Plated Trim*	\$ 25,260	\$ 29,050
<b>LP/Propane Models: 60" Nova Series with 12" Griddle &amp; Charbroiler</b>			
RNB606GCBV2L	6 Burner   12" Griddle & Char Br.   LP Gas   Stainless Steel   Standard Trim	\$ 18,895	\$ 21,730
RNB606GCBV2LPLT	6 Burner   12" Griddle & Char Br.   LP Gas   Stainless Steel   Plated Trim*	\$ 21,305	\$ 24,500
RNB606GCBV2LC	6 Burner   12" Griddle & Char Br.   LP Gas   Std RAL Paint*   Standard Trim	\$ 20,320	\$ 23,370
RNB606GCBV2LCPLT	6 Burner   12" Griddle & Char Br.   LP Gas   Std RAL Paint*   Plated Trim*	\$ 22,730	\$ 26,140
RNB606GCBV2LCF	6 Burner   12" Griddle & Char Br.   LP Gas   Specialty Finish*   Standard Trim	\$ 21,420	\$ 24,635
RNB606GCBV2LCFPLT	6 Burner   12" Griddle & Char Br.   LP Gas   Specialty Finish*   Plated Trim*	\$ 23,830	\$ 27,405
RNB606GCBV2LCC	6 Burner   12" Griddle & Char Br.   LP Gas   Custom Color*   Standard Trim	\$ 22,850	\$ 26,275
RNB606GCBV2LCCPLT	6 Burner   12" Griddle & Char Br.   LP Gas   Custom Color*   Plated Trim*	\$ 25,260	\$ 29,050
<b>Customization &amp; Accessory Options: (See page 21)   Total Knobs: 10</b>			

**60" Nova (RNB) Series  
with 24" French Top**

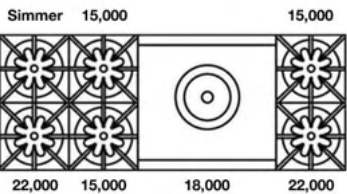

Model	Description (* Denotes item that must be specified)	UMRP	MSRP
<b>Natural Gas Models: 60" Nova Series with 24" French Top</b>			
RNB606FTV2	6 Burner   24" French Top   Nat Gas   Stainless Steel   Standard Trim	\$ 19,995	\$ 22,995
RNB606FTV2PLT	6 Burner   24" French Top   Nat Gas   Stainless Steel   Plated Trim*	\$ 22,405	\$ 25,765
RNB606FTV2C	6 Burner   24" French Top   Nat Gas   Std RAL Paint*   Standard Trim	\$ 21,420	\$ 24,635
RNB606FTV2CPLT	6 Burner   24" French Top   Nat Gas   Std RAL Paint*   Plated Trim*	\$ 23,830	\$ 27,405
RNB606FTV2CF	6 Burner   24" French Top   Nat Gas   Specialty Finish*   Standard Trim	\$ 22,520	\$ 25,900
RNB606FTV2CFPLT	6 Burner   24" French Top   Nat Gas   Specialty Finish*   Plated Trim*	\$ 24,930	\$ 28,670
RNB606FTV2CC	6 Burner   24" French Top   Nat Gas   Custom Color*   Standard Trim	\$ 23,950	\$ 27,540
RNB606FTV2CCPLT	6 Burner   24" French Top   Nat Gas   Custom Color*   Plated Trim*	\$ 26,350	\$ 30,315
<b>LP/Propane Models: 60" Nova Series with 24" French Top</b>			
RNB606FTV2L	6 Burner   24" French Top   LP Gas   Stainless Steel   Standard Trim	\$ 19,995	\$ 22,995
RNB606FTV2LPLT	6 Burner   24" French Top   LP Gas   Stainless Steel   Plated Trim*	\$ 22,405	\$ 25,765
RNB606FTV2LC	6 Burner   24" French Top   LP Gas   Std RAL Paint*   Standard Trim	\$ 21,420	\$ 24,635
RNB606FTV2LCPLT	6 Burner   24" French Top   LP Gas   Std RAL Paint*   Plated Trim*	\$ 23,830	\$ 27,405
RNB606FTV2LCF	6 Burner   24" French Top   LP Gas   Specialty Finish*   Standard Trim	\$ 22,520	\$ 25,900
RNB606FTV2LCFPLT	6 Burner   24" French Top   LP Gas   Specialty Finish*   Plated Trim*	\$ 24,930	\$ 28,670
RNB606FTV2LCC	6 Burner   24" French Top   LP Gas   Custom Color*   Standard Trim	\$ 23,950	\$ 27,540
RNB606FTV2LCCPLT	6 Burner   24" French Top   LP Gas   Custom Color*   Plated Trim*	\$ 26,350	\$ 30,315
<b>Customization &amp; Accessory Options: (See page 21)   Total Knobs: 9</b>			

## FREESTANDING RANGES: 48" NOVA (RNB) SERIES

### BlueStar Model Number Guide:

<b>Base Model (RNB488BV2)</b> 8 Burners   Natural Gas   Stainless Steel Finish   Standard Trim	<b>Change to LP Gas</b> Add (L) for LP/Propane Gas	<b>Add code below for desired color</b> (C) 190 Standard RAL (Semi-Gloss) Colors (CF) Specialty Finish (190 Matte RAL, Precious Metals & Textures) (CC) Custom Colors	<b>Add (PLT) for Plated Trim</b> Includes plated bezels, door handle, handle end and logo. See available options below.
---------------------------------------------------------------------------------------------------	-------------------------------------------------------	--------------------------------------------------------------------------------------------------------------------------------------------------------------------------------	----------------------------------------------------------------------------------------------------------------------------

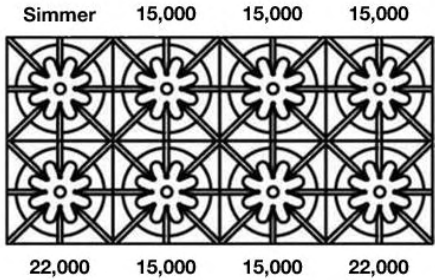

### FEATURES:

- 22,000 BTU UltraNova™ burners & 15,000 BTU Nova™ burners
- Available with all burners or add integrated griddle, charbroiler or French top
- Extra-large convection oven with 1850° infrared broiler that accommodates a full size 18" x 26" commercial baking sheet
- Integrated wok cooking
- Available in 1,000+ colors & finishes plus additional customization options
- Handcrafted in Pennsylvania since 1880

### PRODUCT SPECIFICATIONS:

- Unit Dimensions: 47.875"W x 24"D x 36.75"H
- Large Oven Intr: 26.438"W x 20"D x 15"H
- Small Oven Intr: 13.578"W x 20"D x 15"H
- Top Burner Power: 22,000 BTUs
- Simmer Burner: 9,000 BTUs
- Electrical Reqs: 120V, 60Hz, 15 AMPS, 1PH
- Gas Pressure: NAT: 5.0" WC, LP 10.0" WC
- Gas Line Size: ¾"
- Unit Weight: 645 lbs.

Model	Description (* Denotes item that must be specified)	UMRP	MSRP
<b>Natural Gas Models: 48" Nova (RNB) Series</b>			
RNB488BV2	8 Burner   Nat Gas   Stainless Steel   Standard Trim	\$ 11,995	\$ 13,795
RNB488BV2PLT	8 Burner   Nat Gas   Stainless Steel   Plated Trim*	\$ 14,090	\$ 16,205
RNB488BV2C	8 Burner   Nat Gas   Std RAL Color*   Standard Trim	\$ 13,420	\$ 15,435
RNB488BV2CPLT	8 Burner   Nat Gas   Std RAL Color*   Plated Trim*	\$ 15,515	\$ 17,840
RNB488BV2CF	8 Burner   Nat Gas   Specialty Finish*   Standard Trim	\$ 14,520	\$ 16,700
RNB488BV2CFPLT	8 Burner   Nat Gas   Specialty Finish*   Plated Trim*	\$ 16,615	\$ 19,105
RNB488BV2CC	8 Burner   Nat Gas   Custom Color*   Standard Trim	\$ 15,950	\$ 18,345
RNB488BV2CCPLT	8 Burner   Nat Gas   Custom Color*   Plated Trim*	\$ 18,045	\$ 20,750
<b>LP/Propane Models: 48" Nova (RNB) Series</b>			
RNB488BV2L	8 Burner   LP Gas   Stainless Steel   Standard Trim	\$ 11,995	\$ 13,795
RNB488BV2LPLT	8 Burner   LP Gas   Stainless Steel   Plated Trim*	\$ 14,090	\$ 16,205
RNB488BV2LC	8 Burner   LP Gas   Std RAL Color*   Standard Trim	\$ 13,420	\$ 15,435
RNB488BV2LCPLT	8 Burner   LP Gas   Std RAL Color*   Plated Trim*	\$ 15,515	\$ 17,840
RNB488BV2LCF	8 Burner   LP Gas   Specialty Finish*   Standard Trim	\$ 14,520	\$ 16,700
RNB488BV2LCFPLT	8 Burner   LP Gas   Specialty Finish*   Plated Trim*	\$ 16,615	\$ 19,105
RNB488BV2LCC	8 Burner   LP Gas   Custom Color*   Standard Trim	\$ 15,950	\$ 18,345
RNB488BV2LCCPLT	8 Burner   LP Gas   Custom Color*   Plated Trim*	\$ 18,045	\$ 20,750
<b>BACKGUARD OPTIONS:</b>			
<b>All BlueStar freestanding appliances must be installed with a UL approved backguard. All units ship standard with a UL approved Island Trim unless otherwise specified.</b>			
BG648BSP	6" Backguard	\$ 945	\$ 1,085
BG4817BSP	17" Backguard	\$ 1,980	\$ 2,275
SDHS48BSP	24" High Shelf	\$ 2,125	\$ 2,445
<b>KNOB &amp; PAINTED BODY SIDE OPTIONS: (Total Knobs: 10)</b>			
SIDES-C	Add Painted Sides (All colors)	\$ 695	\$ 800
KN-BLK	Standard Black Knob (Ordered with unit)	N/C	N/C
KN-C	Knob: Standard 190 RAL Color	\$ 115 ea	\$ 130 ea
BZ-C	Bezel: Standard 190 RAL Color	\$ 65 ea	\$ 75 ea
KN-CF	Knob: Spec Finish (Matte RAL, Textured RAL or Prec Metals)	\$ 185 ea	\$ 215 ea
KN-PLT	Knob: Plated Trim (See options below)	\$ 250 ea	\$ 290 ea
<b>SWING DOOR OPTIONS:</b>			
SWING DOOR – LH	Swing Door – Left Hinge for Nova (RNB) Series	\$ 1,390	\$ 1,600
SWING DOOR – RH	Swing Door – Right Hinge for Nova (RNB) Series	\$ 1,390	\$ 1,600
<b>PLATED TRIM OPTIONS: (Includes bezels, door handle, handle ends and logo)</b>			
Antique Brass, Brushed Brass, Polished Brass, Antique Copper, Brushed Copper, Polished Copper, Chrome, Oil Rubbed Bronze & Pewter			
See page 32 for additional customization and accessories for Freestanding Ranges			

## FREESTANDING RANGES: 48" NOVA (RNB) SERIES

**48" Nova (RNB) Series  
with 12" Griddle**

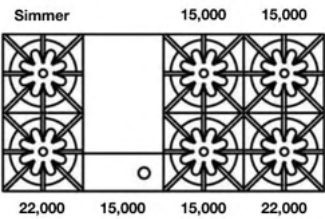

Model	Description (* Denotes item that must be specified)	UMRP	MSRP
<b>Natural Gas Models: 48" Nova (RNB) Series with 12" Griddle</b>			
RNB486GV2	6 Burner   12" Griddle   Nat Gas   Stainless Steel   Standard Trim	\$ 12,995	\$ 14,945
RNB486GV2PLT	6 Burner   12" Griddle   Nat Gas   Stainless Steel   Plated Trim*	\$ 15,090	\$ 17,355
RNB486GV2C	6 Burner   12" Griddle   Nat Gas   Std RAL Paint*   Standard Trim	\$ 14,420	\$ 16,585
RNB486GV2CPLT	6 Burner   12" Griddle   Nat Gas   Std RAL Paint*   Plated Trim*	\$ 16,515	\$ 18,990
RNB486GV2CF	6 Burner   12" Griddle   Nat Gas   Specialty Finish*   Standard Trim	\$ 15,520	\$ 17,850
RNB486GV2CFPLT	6 Burner   12" Griddle   Nat Gas   Specialty Finish*   Plated Trim*	\$ 17,615	\$ 20,255
RNB486GV2CC	6 Burner   12" Griddle   Nat Gas   Custom Color*   Standard Trim	\$ 16,950	\$ 19,495
RNB486GV2CCPLT	6 Burner   12" Griddle   Nat Gas   Custom Color*   Plated Trim*	\$ 19,045	\$ 21,900
<b>LP/Propane Models: 48" Nova (RNB) Series with 12" Griddle</b>			
RNB486GV2L	6 Burner   12" Griddle   LP Gas   Stainless Steel   Standard Trim	\$ 12,995	\$ 14,945
RNB486GV2LPLT	6 Burner   12" Griddle   LP Gas   Stainless Steel   Plated Trim*	\$ 15,090	\$ 17,355
RNB486GV2LC	6 Burner   12" Griddle   LP Gas   Std RAL Paint*   Standard Trim	\$ 14,420	\$ 16,585
RNB486GV2LCPLT	6 Burner   12" Griddle   LP Gas   Std RAL Paint*   Plated Trim*	\$ 16,515	\$ 18,990
RNB486GV2LCF	6 Burner   12" Griddle   LP Gas   Specialty Finish*   Standard Trim	\$ 15,520	\$ 17,850
RNB486GV2LCFPLT	6 Burner   12" Griddle   LP Gas   Specialty Finish*   Plated Trim*	\$ 17,615	\$ 20,255
RNB486GV2LCC	6 Burner   12" Griddle   LP Gas   Custom Color*   Standard Trim	\$ 16,950	\$ 19,495
RNB486GV2LCCPLT	6 Burner   12" Griddle   LP Gas   Custom Color*   Plated Trim*	\$ 19,045	\$ 21,900
<b>Customization &amp; Accessory Options: (See page 17)   Total Knobs: 9</b>			

**48" Nova (RNB) Series  
with 12" Charbroiler**

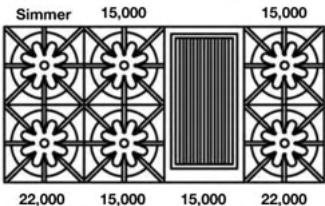

Model	Description (* Denotes item that must be specified)	UMRP	MSRP
<b>Natural Gas Models: 48" Nova (RNB) Series with 12" Charbroiler</b>			
RNB486CBV2	6 Burner   12" Charbroiler   Nat Gas   Stainless Steel   Standard Trim	\$ 13,495	\$ 15,520
RNB486CBV2PLT	6 Burner   12" Charbroiler   Nat Gas   Stainless Steel   Plated Trim*	\$ 15,590	\$ 17,930
RNB486CBV2C	6 Burner   12" Charbroiler   Nat Gas   Std RAL Paint*   Standard Trim	\$ 14,920	\$ 17,160
RNB486CBV2CPLT	6 Burner   12" Charbroiler   Nat Gas   Std RAL Paint*   Plated Trim*	\$ 17,015	\$ 19,565
RNB486CBV2CF	6 Burner   12" Charbroiler   Nat Gas   Specialty Finish*   Standard Trim	\$ 16,020	\$ 18,425
RNB486CBV2CFPLT	6 Burner   12" Charbroiler   Nat Gas   Specialty Finish*   Plated Trim*	\$ 18,115	\$ 20,830
RNB486CBV2CC	6 Burner   12" Charbroiler   Nat Gas   Custom Color*   Standard Trim	\$ 17,450	\$ 20,070
RNB486CBV2CCPLT	6 Burner   12" Charbroiler   Nat Gas   Custom Color*   Plated Trim*	\$ 19,545	\$ 22,475
<b>LP/Propane Models: 48" Nova (RNB) Series with 12" Charbroiler</b>			
RNB486CBV2L	6 Burner   12" Charbroiler   LP Gas   Stainless Steel   Standard Trim	\$ 13,495	\$ 15,520
RNB486CBV2LPLT	6 Burner   12" Charbroiler   LP Gas   Stainless Steel   Plated Trim*	\$ 15,590	\$ 17,930
RNB486CBV2LC	6 Burner   12" Charbroiler   LP Gas   Std RAL Paint*   Standard Trim	\$ 14,920	\$ 17,160
RNB486CBV2LCPLT	6 Burner   12" Charbroiler   LP Gas   Std RAL Paint*   Plated Trim*	\$ 17,015	\$ 19,565
RNB486CBV2LCF	6 Burner   12" Charbroiler   LP Gas   Specialty Finish*   Standard Trim	\$ 16,020	\$ 18,425
RNB486CBV2LCFPLT	6 Burner   12" Charbroiler   LP Gas   Specialty Finish*   Plated Trim*	\$ 18,115	\$ 20,830
RNB486CBV2LCC	6 Burner   12" Charbroiler   LP Gas   Custom Color*   Standard Trim	\$ 17,450	\$ 20,070
RNB486CBV2LCCPLT	6 Burner   12" Charbroiler   LP Gas   Custom Color*   Plated Trim*	\$ 19,545	\$ 22,475
<b>Customization &amp; Accessory Options: (See page 17)   Total Knobs: 9</b>			

## FREESTANDING RANGES: 48" NOVA (RNB) SERIES

### 48" Nova (RNB) Series with 24" Griddle

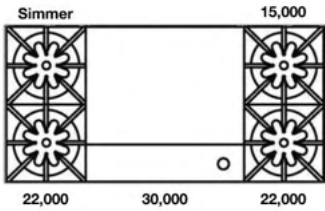

Model	Description (* Denotes item that must be specified)	UMRP	MSRP
<b>Natural Gas Models: 48" Nova (RNB) Series with 24" Griddle</b>			
RNB484GV2	4 Burner   24" Griddle   Nat Gas   Stainless Steel   Standard Trim	\$ 14,395	\$ 16,555
RNB484GV2PLT	4 Burner   24" Griddle   Nat Gas   Stainless Steel   Plated Trim*	\$ 16,490	\$ 18,965
RNB484GV2C	4 Burner   24" Griddle   Nat Gas   Std RAL Paint*   Standard Trim	\$ 15,820	\$ 18,195
RNB484GV2CPLT	4 Burner   24" Griddle   Nat Gas   Std RAL Paint*   Plated Trim*	\$ 17,915	\$ 20,600
RNB484GV2CF	4 Burner   24" Griddle   Nat Gas   Specialty Finish*   Standard Trim	\$ 16,920	\$ 19,460
RNB484GV2CFPLT	4 Burner   24" Griddle   Nat Gas   Specialty Finish*   Plated Trim*	\$ 19,015	\$ 21,865
RNB484GV2CC	4 Burner   24" Griddle   Nat Gas   Custom Color*   Standard Trim	\$ 18,350	\$ 21,105
RNB484GV2CCPLT	4 Burner   24" Griddle   Nat Gas   Custom Color*   Plated Trim*	\$ 20,445	\$ 23,510
<b>LP/Propane Models: 48" Nova (RNB) Series with 24" Griddle</b>			
RNB484GV2L	4 Burner   24" Griddle   LP Gas   Stainless Steel   Standard Trim	\$ 14,395	\$ 16,555
RNB484GV2LPLT	4 Burner   24" Griddle   LP Gas   Stainless Steel   Plated Trim*	\$ 16,490	\$ 18,965
RNB484GV2LC	4 Burner   24" Griddle   LP Gas   Std RAL Paint*   Standard Trim	\$ 15,820	\$ 18,195
RNB484GV2LCPLT	4 Burner   24" Griddle   LP Gas   Std RAL Paint*   Plated Trim*	\$ 17,915	\$ 20,600
RNB484GV2LCF	4 Burner   24" Griddle   LP Gas   Specialty Finish*   Standard Trim	\$ 16,920	\$ 19,460
RNB484GV2LCFPLT	4 Burner   24" Griddle   LP Gas   Specialty Finish*   Plated Trim*	\$ 19,015	\$ 21,865
RNB484GV2LCC	4 Burner   24" Griddle   LP Gas   Custom Color*   Standard Trim	\$ 18,350	\$ 21,105
RNB484GV2LCCPLT	4 Burner   24" Griddle   LP Gas   Custom Color*   Plated Trim*	\$ 20,445	\$ 23,510
<b>Customization &amp; Accessory Options: (See page 17)   Total Knobs: 8</b>			

### 48" Nova (RNB) Series with 24" Charbroiler

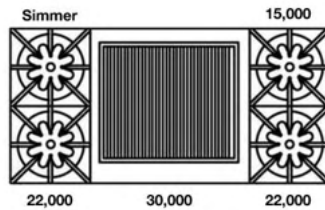

<b>Natural Gas Models: 48" Nova (RNB) Series with 24" Charbroiler</b>			
RNB484CBV2	4 Burner   24" Charbroiler   Nat Gas   Stainless Steel   Standard Trim	\$ 14,395	\$ 16,555
RNB484CBV2PLT	4 Burner   24" Charbroiler   Nat Gas   Stainless Steel   Plated Trim*	\$ 16,490	\$ 18,965
RNB484CBV2C	4 Burner   24" Charbroiler   Nat Gas   Std RAL Paint*   Standard Trim	\$ 15,820	\$ 18,195
RNB484CBV2CPLT	4 Burner   24" Charbroiler   Nat Gas   Std RAL Paint*   Plated Trim*	\$ 17,915	\$ 20,600
RNB484CBV2CF	4 Burner   24" Charbroiler   Nat Gas   Specialty Finish*   Standard Trim	\$ 16,920	\$ 19,460
RNB484CBV2CFPLT	4 Burner   24" Charbroiler   Nat Gas   Specialty Finish*   Plated Trim*	\$ 19,015	\$ 21,865
RNB484CBV2CC	4 Burner   24" Charbroiler   Nat Gas   Custom Color*   Standard Trim	\$ 18,350	\$ 21,105
RNB484CBV2CCPLT	4 Burner   24" Charbroiler   Nat Gas   Custom Color*   Plated Trim*	\$ 20,445	\$ 23,510
<b>LP/Propane Models: 48" Nova (RNB) Series with 12" Charbroiler</b>			
RNB484CBV2L	4 Burner   24" Charbroiler   LP Gas   Stainless Steel   Standard Trim	\$ 14,395	\$ 16,555
RNB484CBV2LPLT	4 Burner   24" Charbroiler   LP Gas   Stainless Steel   Plated Trim*	\$ 16,490	\$ 18,965
RNB484CBV2LC	4 Burner   24" Charbroiler   LP Gas   Std RAL Paint*   Standard Trim	\$ 15,820	\$ 18,195
RNB484CBV2LCPLT	4 Burner   24" Charbroiler   LP Gas   Std RAL Paint*   Plated Trim*	\$ 17,915	\$ 20,600
RNB484CBV2LCF	4 Burner   24" Charbroiler   LP Gas   Specialty Finish*   Standard Trim	\$ 16,920	\$ 19,460
RNB484CBV2LCFPLT	4 Burner   24" Charbroiler   LP Gas   Specialty Finish*   Plated Trim*	\$ 19,015	\$ 21,865
RNB484CBV2LCC	4 Burner   24" Charbroiler   LP Gas   Custom Color*   Standard Trim	\$ 18,350	\$ 21,105
RNB484CBV2LCCPLT	4 Burner   24" Charbroiler   LP Gas   Custom Color*   Plated Trim*	\$ 20,445	\$ 23,510
<b>Customization &amp; Accessory Options: (See page 17)   Total Knobs: 8</b>			

## FREESTANDING RANGES: 48" NOVA (RNB) SERIES

**48" Nova (RNB) Series  
with 12" Griddle & Charbroiler**

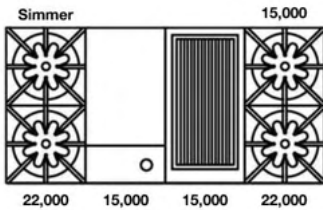

Model	Description (* Denotes item that must be specified)	UMRP	MSRP
<b>Natural Gas Models: 48" Nova (RNB) Series with 12" Griddle &amp; Charbroiler</b>			
RNB484GCBV2	4 Burner   12" Griddle & Char Br.   Nat Gas   Stainless Steel   Standard Trim	\$ 14,995	\$ 17,245
RNB484GCBV2PLT	4 Burner   12" Griddle & Char Br.   Nat Gas   Stainless Steel   Plated Trim*	\$ 17,090	\$ 19,655
RNB484GCBV2C	4 Burner   12" Griddle & Char Br.   Nat Gas   Std RAL Paint*   Standard Trim	\$ 16,420	\$ 18,885
RNB484GCBV2CPLT	4 Burner   12" Griddle & Char Br.   Nat Gas   Std RAL Paint*   Plated Trim*	\$ 18,515	\$ 21,290
RNB484GCBV2CF	4 Burner   12" Griddle & Char Br.   Nat Gas   Specialty Finish*   Standard Trim	\$ 17,520	\$ 20,150
RNB484GCBV2CFPLT	4 Burner   12" Griddle & Char Br.   Nat Gas   Specialty Finish*   Plated Trim*	\$ 19,615	\$ 22,555
RNB484GCBV2CC	4 Burner   12" Griddle & Char Br.   Nat Gas   Custom Color*   Standard Trim	\$ 18,950	\$ 21,795
RNB484GCBV2CCPLT	4 Burner   12" Griddle & Char Br.   Nat Gas   Custom Color*   Plated Trim*	\$ 21,045	\$ 24,200
<b>LP/Propane Models: 48" Nova (RNB) Series with 12" Griddle &amp; Charbroiler</b>			
RNB484GCBV2L	4 Burner   12" Griddle & Char Br   LP Gas   Stainless Steel   Standard Trim	\$ 14,995	\$ 17,245
RNB484GCBV2LPLT	4 Burner   12" Griddle & Char Br   LP Gas   Stainless Steel   Plated Trim*	\$ 17,090	\$ 19,655
RNB484GCBV2LC	4 Burner   12" Griddle & Char Br   LP Gas   Std RAL Paint*   Standard Trim	\$ 16,420	\$ 18,885
RNB484GCBV2LCPLT	4 Burner   12" Griddle & Char Br   LP Gas   Std RAL Paint*   Plated Trim*	\$ 18,515	\$ 21,290
RNB484GCBV2LCF	4 Burner   12" Griddle & Char Br   LP Gas   Specialty Finish*   Standard Trim	\$ 17,520	\$ 20,150
RNB484GCBV2LCFPLT	4 Burner   12" Griddle & Char Br   LP Gas   Specialty Finish*   Plated Trim*	\$ 19,615	\$ 22,555
RNB484GCBV2LCC	4 Burner   12" Griddle & Char Br   LP Gas   Custom Color*   Standard Trim	\$ 18,950	\$ 21,795
RNB484GCBV2LCCPLT	4 Burner   12" Griddle & Char Br   LP Gas   Custom Color*   Plated Trim*	\$ 21,045	\$ 24,200
<b>Customization &amp; Accessory Options: (See page 17)   Total Knobs: 8</b>			

**48" Nova (RNB) Series  
with 24" French Top**

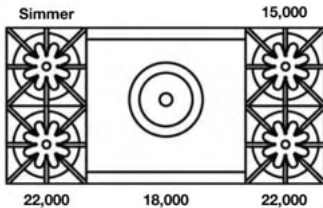

<b>Natural Gas Models: 48" Nova (RNB) Series with 24" French Top</b>			
RNB484FTBV2	4 Burner   24" French Top   Nat Gas   Stainless Steel   Standard Trim	\$ 15,295	\$ 17,590
RNB484FTBV2PLT	4 Burner   24" French Top   Nat Gas   Stainless Steel   Plated Trim*	\$ 17,390	\$ 20,000
RNB484FTBV2C	4 Burner   24" French Top   Nat Gas   Std RAL Paint*   Standard Trim	\$ 16,720	\$ 19,230
RNB484FTBV2CPLT	4 Burner   24" French Top   Nat Gas   Std RAL Paint*   Plated Trim*	\$ 18,815	\$ 21,635
RNB484FTBV2CF	4 Burner   24" French Top   Nat Gas   Specialty Finish*   Standard Trim	\$ 17,820	\$ 20,495
RNB484FTBV2CFPLT	4 Burner   24" French Top   Nat Gas   Specialty Finish*   Plated Trim*	\$ 19,915	\$ 22,900
RNB484FTBV2CC	4 Burner   24" French Top   Nat Gas   Custom Color*   Standard Trim	\$ 19,250	\$ 22,140
RNB484FTBV2CCPLT	4 Burner   24" French Top   Nat Gas   Custom Color*   Plated Trim*	\$ 21,345	\$ 24,545
<b>LP/Propane Models: 48" Nova (RNB) Series with 24" French Top</b>			
RNB484FTBV2L	4 Burner   24" French Top   LP Gas   Stainless Steel   Standard Trim	\$ 15,295	\$ 17,590
RNB484FTBV2LPLT	4 Burner   24" French Top   LP Gas   Stainless Steel   Plated Trim*	\$ 17,390	\$ 20,000
RNB484FTBV2LC	4 Burner   24" French Top   LP Gas   Std RAL Paint*   Standard Trim	\$ 16,720	\$ 19,230
RNB484FTBV2LCPLT	4 Burner   24" French Top   LP Gas   Std RAL Paint*   Plated Trim*	\$ 18,815	\$ 21,635
RNB484FTBV2LCF	4 Burner   24" French Top   LP Gas   Specialty Finish*   Standard Trim	\$ 17,820	\$ 20,495
RNB484FTBV2LCFPLT	4 Burner   24" French Top   LP Gas   Specialty Finish*   Plated Trim*	\$ 19,915	\$ 22,900
RNB484FTBV2LCC	4 Burner   24" French Top   LP Gas   Custom Color*   Standard Trim	\$ 19,250	\$ 22,140
RNB484FTBV2LCCPLT	4 Burner   24" French Top   LP Gas   Custom Color*   Plated Trim*	\$ 21,345	\$ 24,545
<b>Customization &amp; Accessory Options: (See page 17)   Total Knobs: 7</b>			

## FREESTANDING RANGES: 36" NOVA (RNB) SERIES

### BlueStar Model Number Guide:

<b>Base Model (RNB366BV2)</b> 6 Burners   Natural Gas   Stainless Steel Finish   Standard Trim	<b>Change to LP Gas</b> Add (L) for LP/Propane Gas	<b>Add code below for desired color</b> (C) 190 Standard RAL (Semi-Gloss) Colors (CF) Specialty Finish (190 Matte RAL, Precious Metals & Textures) (CC) Custom Colors	<b>Add (PLT) for Plated Trim</b> Includes plated bezels, door handle, handle end and logo. See available options below.
---------------------------------------------------------------------------------------------------	-------------------------------------------------------	--------------------------------------------------------------------------------------------------------------------------------------------------------------------------------	----------------------------------------------------------------------------------------------------------------------------

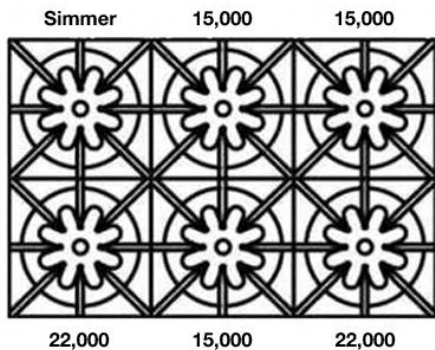

#### FEATURES:

- 22,000 BTU UltraNova™ burners & 15,000 BTU Nova™ burners
- Precise 130° simmer burner
- Available with all burners or add integrated griddle, charbroiler or French top
- Extra-large convection oven with 1850° infrared broiler that accommodates a full size 18" x 26" commercial baking sheet
- Includes full extension rack
- Integrated wok cooking
- Available with swing doors
- Available in 1,000+ colors & finishes plus additional customization options
- Handcrafted in Pennsylvania since 1880

#### PRODUCT SPECIFICATIONS:

- Unit Dimensions: 35.875"W x 24"D x 36.75"H
- Oven Interior: 29.25"W x 20"D x 15"H
- Top Burner Power: 22,000 BTUs
- Simmer Burner: 9,000 BTUs
- Electrical Reqs: 120V, 60Hz, 15 AMPS, 1PH
- Gas Pressure: NAT: 5.0" WC, LP 10.0" WC
- Gas Line Size: ½
- Unit Weight: 470 lbs.

Model	Description (* Denotes item that must be specified)	UMRP	MSRP
<b>Natural Gas Models: 36" Nova (RNB) Series</b>			
RNB366BV2	6 Burner   Nat Gas   Stainless Steel   Standard Trim	\$ 7,995	\$ 9,195
RNB366BV2PLT	6 Burner   Nat Gas   Stainless Steel   Plated Trim*	\$ 9,775	\$ 11,240
RNB366BV2C	6 Burner   Nat Gas   Std RAL Color*   Standard Trim	\$ 9,090	\$ 10,455
RNB366BV2CPLT	6 Burner   Nat Gas   Std RAL Color*   Plated Trim*	\$ 10,870	\$ 12,500
RNB366BV2CF	6 Burner   Nat Gas   Specialty Finish*   Standard Trim	\$ 10,080	\$ 11,590
RNB366BV2CFPLT	6 Burner   Nat Gas   Specialty Finish*   Plated Trim*	\$ 11,860	\$ 13,640
RNB366BV2CC	6 Burner   Nat Gas   Custom Color*   Standard Trim	\$ 11,510	\$ 13,235
RNB366BV2CCPLT	6 Burner   Nat Gas   Custom Color*   Plated Trim*	\$ 13,290	\$ 15,285
<b>LP/Propane Models: 36" Nova (RNB) Series</b>			
RNB366BV2L	6 Burner   LP Gas   Stainless Steel   Standard Trim	\$ 7,995	\$ 9,195
RNB366BV2LPLT	6 Burner   LP Gas   Stainless Steel   Plated Trim*	\$ 9,775	\$ 11,240
RNB366BV2LC	6 Burner   LP Gas   Std RAL Color*   Standard Trim	\$ 9,090	\$ 10,455
RNB366BV2LCPLT	6 Burner   LP Gas   Std RAL Color*   Plated Trim*	\$ 10,870	\$ 12,500
RNB366BV2LCF	6 Burner   LP Gas   Specialty Finish*   Standard Trim	\$ 10,080	\$ 11,590
RNB366BV2LCFPLT	6 Burner   LP Gas   Specialty Finish*   Plated Trim*	\$ 11,860	\$ 13,640
RNB366BV2LCC	6 Burner   LP Gas   Custom Color*   Standard Trim	\$ 11,510	\$ 13,235
RNB366BV2LCCPLT	6 Burner   LP Gas   Custom Color*   Plated Trim*	\$ 13,290	\$ 15,285
<b>BACKGUARD OPTIONS:</b>			
All BlueStar freestanding appliances must be installed with a UL approved backguard. All units ship standard with a UL approved Island Trim unless otherwise specified.			
BG636BSP	6" Backguard	\$ 655	\$ 755
BG3617BSP	17" Backguard	\$ 1,325	\$ 1,525
SDHS36BSP	24" High Shelf	\$ 1,535	\$ 1,765
<b>KNOB &amp; PAINTED BODY SIDE OPTIONS: (Total Knobs: 7)</b>			
SIDES-C	Add Painted Sides (All colors)	\$ 695	\$ 800
KN-BLK	Standard Black Knob (Ordered with unit)	N/C	N/C
KN-C	Knob: Standard 190 RAL Color	\$ 115 ea	\$ 130 ea
BZ-C	Bezel: Standard 190 RAL Color	\$ 65 ea	\$ 75 ea
KN-CF	Knob: Spec Finish (Matte RAL, Textured RAL or Prec Metals)	\$ 185 ea	\$ 215 ea
KN-PLT	Knob: Plated Trim (See options below)	\$ 250 ea	\$ 290 ea
<b>SWING DOOR OPTIONS:</b>			
SWING DOOR – LH	Swing Door – Left Hinge for Nova (RNB) Series	\$ 1,390	\$ 1,600
SWING DOOR – RH	Swing Door – Right Hinge for Nova (RNB) Series	\$ 1,390	\$ 1,600
<b>PLATED TRIM OPTIONS: (Includes bezels, door handle, handle ends and logo)</b>			
Antique Brass, Brushed Brass, Polished Brass, Antique Copper, Brushed Copper, Polished Copper, Chrome, Oil Rubbed Bronze & Pewter			
See page 32 for additional customization and accessories for Freestanding Ranges			

## FREESTANDING RANGES: 36" NOVA (RNB) SERIES

**36" Nova (RNB) Series  
with 12" Griddle**

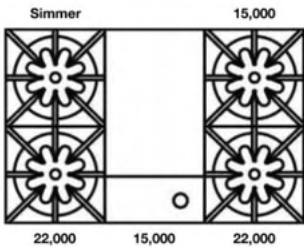

Model	Description (* Denotes item that must be specified)	UMRP	MSRP
<b>Natural Gas Models: 36" Nova (RNB) Series with 12" Griddle</b>			
RNB364GV2	4 Burner   12" Griddle   Nat Gas   Stainless Steel   Standard Trim	\$ 9,195	\$ 10,575
RNB364GV2PLT	4 Burner   12" Griddle   Nat Gas   Stainless Steel   Plated Trim*	\$ 10,975	\$ 12,620
RNB364GV2C	4 Burner   12" Griddle   Nat Gas   Std RAL Paint*   Standard Trim	\$ 10,290	\$ 11,835
RNB364GV2CPLT	4 Burner   12" Griddle   Nat Gas   Std RAL Paint*   Plated Trim*	\$ 12,070	\$ 13,880
RNB364GV2CF	4 Burner   12" Griddle   Nat Gas   Specialty Finish*   Standard Trim	\$ 11,280	\$ 12,970
RNB364GV2CFPLT	4 Burner   12" Griddle   Nat Gas   Specialty Finish*   Plated Trim*	\$ 13,060	\$ 15,020
RNB364GV2CC	4 Burner   12" Griddle   Nat Gas   Custom Color*   Standard Trim	\$ 12,710	\$ 14,615
RNB364GV2CCPLT	4 Burner   12" Griddle   Nat Gas   Custom Color*   Plated Trim*	\$ 14,490	\$ 16,665
<b>LP/Propane Models: 36" Nova (RNB) Series with 12" Griddle</b>			
RNB364GV2L	4 Burner   12" Griddle   LP Gas   Stainless Steel   Standard Trim	\$ 9,195	\$ 10,575
RNB364GV2LPLT	4 Burner   12" Griddle   LP Gas   Stainless Steel   Plated Trim*	\$ 10,975	\$ 12,620
RNB364GV2LC	4 Burner   12" Griddle   LP Gas   Std RAL Paint*   Standard Trim	\$ 10,290	\$ 11,835
RNB364GV2LCPLT	4 Burner   12" Griddle   LP Gas   Std RAL Paint*   Plated Trim*	\$ 12,070	\$ 13,880
RNB364GV2LCF	4 Burner   12" Griddle   LP Gas   Specialty Finish*   Standard Trim	\$ 11,280	\$ 12,970
RNB364GV2LCFPLT	4 Burner   12" Griddle   LP Gas   Specialty Finish*   Plated Trim*	\$ 13,060	\$ 15,020
RNB364GV2LCC	4 Burner   12" Griddle   LP Gas   Custom Color*   Standard Trim	\$ 12,710	\$ 14,615
RNB364GV2LCCPLT	4 Burner   12" Griddle   LP Gas   Custom Color*   Plated Trim*	\$ 14,490	\$ 16,665
<b>Customization &amp; Accessory Options: (See page 15)   Total Knobs: 6</b>			

**36" Nova (RNB) Series  
with 12" Charbroiler**

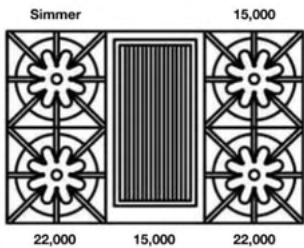

<b>Natural Gas Models: 36" Nova (RNB) Series with 12" Charbroiler</b>			
RNB364CBV2	4 Burner   12" Charbroiler   Nat Gas   Stainless Steel   Standard Trim	\$ 9,195	\$ 10,575
RNB364CBV2PLT	4 Burner   12" Charbroiler   Nat Gas   Stainless Steel   Plated Trim*	\$ 10,975	\$ 12,620
RNB364CBV2C	4 Burner   12" Charbroiler   Nat Gas   Std RAL Paint*   Standard Trim	\$ 10,290	\$ 11,835
RNB364CBV2CPLT	4 Burner   12" Charbroiler   Nat Gas   Std RAL Paint*   Plated Trim*	\$ 12,070	\$ 13,880
RNB364CBV2CF	4 Burner   12" Charbroiler   Nat Gas   Specialty Finish*   Standard Trim	\$ 11,280	\$ 12,970
RNB364CBV2CFPLT	4 Burner   12" Charbroiler   Nat Gas   Specialty Finish*   Plated Trim*	\$ 13,060	\$ 15,020
RNB364CBV2CC	4 Burner   12" Charbroiler   Nat Gas   Custom Color*   Standard Trim	\$ 12,710	\$ 14,615
RNB364CBV2CCPLT	4 Burner   12" Charbroiler   Nat Gas   Custom Color*   Plated Trim*	\$ 14,490	\$ 16,665
<b>LP/Propane Models: 36" Nova (RNB) Series with 12" Charbroiler</b>			
RNB364CBV2L	4 Burner   12" Charbroiler   LP Gas   Stainless Steel   Standard Trim	\$ 9,195	\$ 10,575
RNB364CBV2LPLT	4 Burner   12" Charbroiler   LP Gas   Stainless Steel   Plated Trim*	\$ 10,975	\$ 12,620
RNB364CBV2LC	4 Burner   12" Charbroiler   LP Gas   Std RAL Paint*   Standard Trim	\$ 10,290	\$ 11,835
RNB364CBV2LCPLT	4 Burner   12" Charbroiler   LP Gas   Std RAL Paint*   Plated Trim*	\$ 12,070	\$ 13,880
RNB364CBV2LCF	4 Burner   12" Charbroiler   LP Gas   Specialty Finish*   Standard Trim	\$ 11,280	\$ 12,970
RNB364CBV2LCFPLT	4 Burner   12" Charbroiler   LP Gas   Specialty Finish*   Plated Trim*	\$ 13,060	\$ 15,020
RNB364CBV2LCC	4 Burner   12" Charbroiler   LP Gas   Custom Color*   Standard Trim	\$ 12,710	\$ 14,615
RNB364CBV2LCCPLT	4 Burner   12" Charbroiler   LP Gas   Custom Color*   Plated Trim*	\$ 14,490	\$ 16,665
<b>Customization &amp; Accessory Options: (See page 15)   Total Knobs: 6</b>			

## FREESTANDING RANGES: 30" NOVA (RNB) SERIES

### BlueStar Model Number Guide:

<b>Base Model (RNB304BV2)</b> 4 Burners   Natural Gas   Stainless Steel Finish   Standard Trim	<b>Change to LP Gas</b> Add (L) for LP/Propane Gas	<b>Add code below for desired color</b> (C) 190 Standard RAL (Semi-Gloss) Colors (CF) Specialty Finish (190 Matte RAL, Precious Metals & Textures) (CC) Custom Colors	<b>Add (PLT) for Plated Trim</b> Includes plated bezels, door handle, handle end and logo. See available options below.
---------------------------------------------------------------------------------------------------	-------------------------------------------------------	--------------------------------------------------------------------------------------------------------------------------------------------------------------------------------	----------------------------------------------------------------------------------------------------------------------------

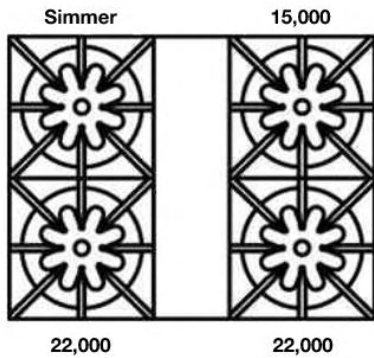

#### FEATURES:

- 22,000 BTU UltraNova™ burners & 15,000 BTU Nova™ burners
- Precise 130° simmer burner
- Extra-large convection oven with 1850° infrared broiler that accommodates a full size 18" x 26" commercial baking sheet
- Includes full extension rack
- Integrated wok cooking
- Available with swing doors
- Available in 1,000+ colors & finishes plus additional customization options
- Handcrafted in Pennsylvania since 1880

#### PRODUCT SPECIFICATIONS:

- Unit Dimensions: 29.875W x 24"D x 36.75"H
- Oven Interior: 26.438"W x 20"D x 15"H
- Top Burner Power: 22,000 BTUs
- Simmer Burner: 9,000 BTUs
- Electrical Reqs: 120V, 60Hz, 15 AMPS, 1PH
- Gas Pressure: NAT: 5.0" WC, LP 10.0" WC
- Gas Line Size: ½
- Unit Weight: 420 lbs.

Model	Description (* Denotes item that must be specified)	UMRP	MSRP
<b>Natural Gas Models: 30" Nova (RNB) Series</b>			
RNB304BV2	4 Burner   Nat Gas   Stainless Steel   Standard Trim	\$ 6,295	\$ 7,240
RNB304BV2PLT	4 Burner   Nat Gas   Stainless Steel   Plated Trim*	\$ 7,760	\$ 8,925
RNB304BV2C	4 Burner   Nat Gas   Std RAL Color*   Standard Trim	\$ 7,390	\$ 8,500
RNB304BV2CPLT	4 Burner   Nat Gas   Std RAL Color*   Plated Trim*	\$ 8,855	\$ 10,185
RNB304BV2CF	4 Burner   Nat Gas   Specialty Finish*   Standard Trim	\$ 8,380	\$ 9,635
RNB304BV2CFPLT	4 Burner   Nat Gas   Specialty Finish*   Plated Trim*	\$ 9,845	\$ 11,320
RNB304BV2CC	4 Burner   Nat Gas   Custom Color*   Standard Trim	\$ 9,810	\$ 11,280
RNB304BV2CCPLT	4 Burner   Nat Gas   Custom Color*   Plated Trim*	\$ 11,275	\$ 12,965
<b>LP/Propane Models: 30" Nova (RNB) Series</b>			
RNB304BV2L	4 Burner   LP Gas   Stainless Steel   Standard Trim	\$ 6,295	\$ 7,240
RNB304BV2LPLT	4 Burner   LP Gas   Stainless Steel   Plated Trim*	\$ 7,760	\$ 8,925
RNB304BV2LC	4 Burner   LP Gas   Std RAL Color*   Standard Trim	\$ 7,390	\$ 8,500
RNB304BV2LCPLT	4 Burner   LP Gas   Std RAL Color*   Plated Trim*	\$ 8,855	\$ 10,185
RNB304BV2LCF	4 Burner   LP Gas   Specialty Finish*   Standard Trim	\$ 8,380	\$ 9,635
RNB304BV2LCFPLT	4 Burner   LP Gas   Specialty Finish*   Plated Trim*	\$ 9,845	\$ 11,320
RNB304BV2LCC	4 Burner   LP Gas   Custom Color*   Standard Trim	\$ 9,810	\$ 11,280
RNB304BV2LCCPLT	4 Burner   LP Gas   Custom Color*   Plated Trim*	\$ 11,275	\$ 12,965
<b>BACKGUARD OPTIONS:</b>			
All BlueStar freestanding appliances must be installed with a UL approved backguard. All units ship standard with a UL approved Island Trim unless otherwise specified.			
BG630BSP	6" Backguard	\$ 550	\$ 635
BG3017BSP	17" Backguard	\$ 1,020	\$ 1,175
SDHS30BSP	24" High Shelf	\$ 1,325	\$ 1,525
<b>KNOB &amp; PAINTED BODY SIDE OPTIONS: (Total Knobs: 5)</b>			
SIDES-C	Add Painted Sides (All colors)	\$ 695	\$ 800
KN-BLK	Standard Black Knob (Ordered with unit)	N/C	N/C
KN-C	Knob: Standard 190 RAL Color	\$ 115 ea	\$ 130 ea
BZ-C	Bezel: Standard 190 RAL Color	\$ 65 ea	\$ 75 ea
KN-CF	Knob: Spec Finish (Matte RAL, Textured RAL or Prec Metals)	\$ 185 ea	\$ 215 ea
KN-PLT	Knob: Plated Trim (See options below)	\$ 250 ea	\$ 290 ea
<b>SWING DOOR OPTIONS:</b>			
SWING DOOR – LH	Swing Door – Left Hinge for Nova (RNB) Series	\$ 1,390	\$ 1,600
SWING DOOR – RH	Swing Door – Right Hinge for Nova (RNB) Series	\$ 1,390	\$ 1,600
<b>PLATED TRIM OPTIONS: (Includes bezels, door handle, handle ends and logo)</b>			
Antique Brass, Brushed Brass, Polished Brass, Antique Copper, Brushed Copper, Polished Copper, Chrome, Oil Rubbed Bronze & Pewter			
See page 32 for additional customization and accessories for Freestanding Ranges			

## FREESTANDING RANGES: 24" NOVA (RNB) SERIES

BlueStar Model Number Guide:			
<b>Base Model (RNB244BV2)</b> 4 Burners   Natural Gas   Stainless Steel Finish   Standard Trim	<b>Change to LP Gas</b> Add (L) for LP/Propane Gas	<b>Add code below for desired color</b> (C) 190 Standard RAL (Semi-Gloss) Colors (CF) Specialty Finish (190 Matte RAL, Precious Metals & Textures) (CC) Custom Colors	<b>Add (PLT) for Plated Trim</b> Includes plated bezels, door handle, handle end and logo. See available options below.



Simmer 15,000



22,000 22,000

### FEATURES:

- 22,000 BTU UltraNova™ burners & 15,000 BTU Nova™ burners
- Precise 130° simmer burner
- Available with all burners or all integrated griddle, charbroiler or French top
- Extra-large convection oven with 1850° infrared broiler that accommodates a half size 18" x 13" commercial baking sheet
- Includes full extension rack
- Integrated wok cooking
- Available with swing doors
- Available in 1,000+ colors & finishes plus additional customization options
- Handcrafted in Pennsylvania since 1880

### PRODUCT SPECIFICATIONS:

- Unit Dimensions: 23.875"W x 24"D x 36.75"H
- Oven Interior: 20.25"W x 20"D x 15"H
- Top Burner Power: 22,000 BTUs
- Simmer Burner: 9,000 BTUs
- Electrical Reqs: 120V, 60Hz, 15 AMPS, 1PH
- Gas Pressure: NAT: 5.0" WC, LP 10.0" WC
- Gas Line Size: ½
- Unit Weight: 365 lbs.

Model	Description (* Denotes item that must be specified)	UMRP	MSRP
<b>Natural Gas Models: 24" Nova (RNB) Series</b>			
RNB244BV2	4 Burner   Nat Gas   Stainless Steel   Standard Trim	\$ 5,995	\$ 6,895
RNB244BV2PLT	4 Burner   Nat Gas   Stainless Steel   Plated Trim*	\$ 7,460	\$ 8,580
RNB244BV2C	4 Burner   Nat Gas   Std RAL Color*   Standard Trim	\$ 7,090	\$ 8,155
RNB244BV2CPLT	4 Burner   Nat Gas   Std RAL Color*   Plated Trim*	\$ 8,555	\$ 9,840
RNB244BV2CF	4 Burner   Nat Gas   Specialty Finish*   Standard Trim	\$ 8,080	\$ 9,290
RNB244BV2CFPLT	4 Burner   Nat Gas   Specialty Finish*   Plated Trim*	\$ 9,545	\$ 10,975
RNB244BV2CC	4 Burner   Nat Gas   Custom Color*   Standard Trim	\$ 9,510	\$ 10,935
RNB244BV2CCPLT	4 Burner   Nat Gas   Custom Color*   Plated Trim*	\$ 10,975	\$ 12,620
<b>LP/Propane Models: 24" Nova (RNB) Series</b>			
RNB244BV2L	4 Burner   LP Gas   Stainless Steel   Standard Trim	\$ 5,995	\$ 6,895
RNB244BV2LPLT	4 Burner   LP Gas   Stainless Steel   Plated Trim*	\$ 7,460	\$ 8,580
RNB244BV2LC	4 Burner   LP Gas   Std RAL Color*   Standard Trim	\$ 7,090	\$ 8,155
RNB244BV2LCPLT	4 Burner   LP Gas   Std RAL Color*   Plated Trim*	\$ 8,555	\$ 9,840
RNB244BV2LCF	4 Burner   LP Gas   Specialty Finish*   Standard Trim	\$ 8,080	\$ 9,290
RNB244BV2LCFPLT	4 Burner   LP Gas   Specialty Finish*   Plated Trim*	\$ 9,545	\$ 10,975
RNB244BV2LCC	4 Burner   LP Gas   Custom Color*   Standard Trim	\$ 9,510	\$ 10,935
RNB244BV2LCCPLT	4 Burner   LP Gas   Custom Color*   Plated Trim*	\$ 10,975	\$ 12,620
<b>BACKGUARD OPTIONS:</b>			
All BlueStar freestanding appliances must be installed with a UL approved backguard. All units ship standard with a UL approved Island Trim unless otherwise specified.			
BG624BSP	6" Backguard	\$ 550	\$ 635
BG2417BSP	17" Backguard	\$ 1,020	\$ 1,175
SDHS24BSP	24" High Shelf	\$ 1,325	\$ 1,525
<b>KNOB &amp; PAINTED BODY SIDE OPTIONS: (Total Knobs: 5)</b>			
SIDES-C	Add Painted Sides (All colors)	\$ 695	\$ 800
KN-BLK	Standard Black Knob (Ordered with unit)	N/C	N/C
KN-C	Knob: Standard 190 RAL Color	\$ 115 ea	\$ 130 ea
BZ-C	Bezel: Standard 190 RAL Color	\$ 65 ea	\$ 75 ea
KN-CF	Knob: Spec Finish (Matte RAL, Textured RAL or Prec Metals)	\$ 185 ea	\$ 215 ea
KN-PLT	Knob: Plated Trim (See options below)	\$ 250 ea	\$ 290 ea
<b>SWING DOOR OPTIONS:</b>			
SWING DOOR – LH	Swing Door – Left Hinge for Nova (RNB) Series	\$ 1,390	\$ 1,600
SWING DOOR – RH	Swing Door – Right Hinge for Nova (RNB) Series	\$ 1,390	\$ 1,600
<b>PLATED TRIM OPTIONS: (Includes bezels, door handle, handle ends and logo)</b>			
Antique Brass, Brushed Brass, Polished Brass, Antique Copper, Brushed Copper, Polished Copper, Chrome, Oil Rubbed Bronze & Pewter			
See page 32 for additional customization and accessories for Freestanding Ranges			

## FREESTANDING RANGES: 24" NOVA (RNB) SERIES

### 24" Nova (RNB) Series - All Griddle

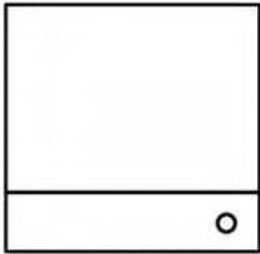

30,000

Model	Description (* Denotes item that must be specified)	UMRP	MSRP
<b>Natural Gas Models: 24" Nova Series – All Griddle</b>			
RNB24GV2	24" Nova Series   24" Griddle   Nat Gas   Stainless Steel   Standard Trim	\$ 6,495	\$ 7,470
RNB24GV2PLT	24" Nova Series   24" Griddle   Nat Gas   Stainless Steel   Plated Trim*	\$ 7,960	\$ 9,155
RNB24GV2C	24" Nova Series   24" Griddle   Nat Gas   Std RAL Paint*   Standard Trim	\$ 7,590	\$ 8,730
RNB24GV2CPLT	24" Nova Series   24" Griddle   Nat Gas   Std RAL Paint*   Plated Trim*	\$ 9,055	\$ 10,415
RNB24GV2CF	24" Nova Series   24" Griddle   Nat Gas   Specialty Finish*   Standard Trim	\$ 8,580	\$ 9,865
RNB24GV2CFPLT	24" Nova Series   24" Griddle   Nat Gas   Specialty Finish*   Plated Trim*	\$ 10,045	\$ 11,550
RNB24GV2CC	24" Nova Series   24" Griddle   Nat Gas   Custom Color*   Standard Trim	\$ 10,010	\$ 11,510
RNB24GV2CCPLT	24" Nova Series   24" Griddle   Nat Gas   Custom Color*   Plated Trim*	\$ 11,475	\$ 13,195
<b>LP/Propane Models: 24" Nova Series – All Griddle</b>			
RNB24GV2L	24" Nova Series   24" Griddle   LP Gas   Stainless Steel   Standard Trim	\$ 6,495	\$ 7,470
RNB24GV2LPLT	24" Nova Series   24" Griddle   LP Gas   Stainless Steel   Plated Trim*	\$ 7,960	\$ 9,155
RNB24GV2LC	24" Nova Series   24" Griddle   LP Gas   Std RAL Paint*   Standard Trim	\$ 7,590	\$ 8,730
RNB24GV2LCPLT	24" Nova Series   24" Griddle   LP Gas   Std RAL Paint*   Plated Trim*	\$ 9,055	\$ 10,415
RNB24GV2LCF	24" Nova Series   24" Griddle   LP Gas   Specialty Finish*   Standard Trim	\$ 8,580	\$ 9,865
RNB24GV2LCFPLT	24" Nova Series   24" Griddle   LP Gas   Specialty Finish*   Plated Trim*	\$ 10,045	\$ 11,550
RNB24GV2LCC	24" Nova Series   24" Griddle   LP Gas   Custom Color*   Standard Trim	\$ 10,010	\$ 11,510
RNB24GV2LCCPLT	24" Nova Series   24" Griddle   LP Gas   Custom Color*   Plated Trim*	\$ 11,475	\$ 13,195
<b>Customization &amp; Accessory Options: (See page 11)   Total Knobs: 3</b>			

### 24" Nova (RNB) Series - All Charbroiler

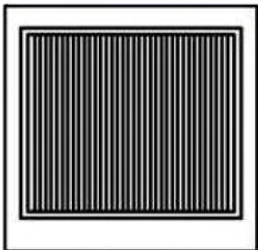

30,000

Model	Description (* Denotes item that must be specified)	UMRP	MSRP
<b>Natural Gas Models: 24" Nova Series – All Charbroiler</b>			
RNB24CBV2	24" Nova Series   24" Charbroiler   Nat Gas   Stainless Steel   Standard Trim	\$ 6,495	\$ 7,470
RNB24CBV2PLT	24" Nova Series   24" Charbroiler   Nat Gas   Stainless Steel   Plated Trim*	\$ 7,960	\$ 9,155
RNB24CBV2C	24" Nova Series   24" Charbroiler   Nat Gas   Std RAL Paint*   Standard Trim	\$ 7,590	\$ 8,730
RNB24CBV2CPLT	24" Nova Series   24" Charbroiler   Nat Gas   Std RAL Paint*   Plated Trim*	\$ 9,055	\$ 10,415
RNB24CBV2CF	24" Nova Series   24" Charbroiler   Nat Gas   Specialty Finish*   Standard Trim	\$ 8,580	\$ 9,865
RNB24CBV2CFPLT	24" Nova Series   24" Charbroiler   Nat Gas   Specialty Finish*   Plated Trim*	\$ 10,045	\$ 11,550
RNB24CBV2CC	24" Nova Series   24" Charbroiler   Nat Gas   Custom Color*   Standard Trim	\$ 10,010	\$ 11,510
RNB24CBV2CCPLT	24" Nova Series   24" Charbroiler   Nat Gas   Custom Color*   Plated Trim*	\$ 11,475	\$ 13,195
<b>LP/Propane Models: 24" Nova Series – Charbroiler</b>			
RNB24CBV2L	24" Nova Series   24" Charbroiler   LP Gas   Stainless Steel   Standard Trim	\$ 6,495	\$ 7,470
RNB24CBV2LPLT	24" Nova Series   24" Charbroiler   LP Gas   Stainless Steel   Plated Trim*	\$ 7,960	\$ 9,155
RNB24CBV2LC	24" Nova Series   24" Charbroiler   LP Gas   Std RAL Paint*   Standard Trim	\$ 7,590	\$ 8,730
RNB24CBV2LCPLT	24" Nova Series   24" Charbroiler   LP Gas   Std RAL Paint*   Plated Trim*	\$ 9,055	\$ 10,415
RNB24CBV2LCF	24" Nova Series   24" Charbroiler   LP Gas   Specialty Finish*   Standard Trim	\$ 8,580	\$ 9,865
RNB24CBV2LCFPLT	24" Nova Series   24" Charbroiler   LP Gas   Specialty Finish*   Plated Trim*	\$ 10,045	\$ 11,550
RNB24CBV2LCC	24" Nova Series   24" Charbroiler   LP Gas   Custom Color*   Standard Trim	\$ 10,010	\$ 11,510
RNB24CBV2LCCPLT	24" Nova Series   24" Charbroiler   LP Gas   Custom Color*   Plated Trim*	\$ 11,475	\$ 13,195
<b>Customization &amp; Accessory Options: (See page 11)   Total Knobs: 3</b>			

## FREESTANDING RANGES: 24" NOVA (RNB) SERIES

### 24" Nova (RNB) Series - All French Top

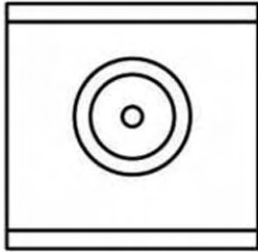

18,000

Model	Description (* Denotes item that must be specified)	UMRP	MSRP
<b>Natural Gas Models: 24" Nova Series – All French Top</b>			
RNB24FTV2	24" Nova Series   24" French Top   Nat Gas   Stainless Steel   Standard Trim	\$ 6,995	\$ 8,045
RNB24FTV2PLT	24" Nova Series   24" French Top   Nat Gas   Stainless Steel   Plated Trim*	\$ 8,460	\$ 9,730
RNB24FTV2C	24" Nova Series   24" French Top   Nat Gas   Std RAL Paint*   Standard Trim	\$ 8,090	\$ 9,305
RNB24FTV2CPLT	24" Nova Series   24" French Top   Nat Gas   Std RAL Paint*   Plated Trim*	\$ 9,555	\$ 10,990
RNB24FTV2CF	24" Nova Series   24" French Top   Nat Gas   Specialty Finish*   Standard Trim	\$ 9,080	\$ 10,440
RNB24FTV2CFPLT	24" Nova Series   24" French Top   Nat Gas   Specialty Finish*   Plated Trim*	\$ 10,545	\$ 12,125
RNB24FTV2CC	24" Nova Series   24" French Top   Nat Gas   Custom Color*   Standard Trim	\$ 10,510	\$ 12,085
RNB24FTV2CCPLT	24" Nova Series   24" French Top   Nat Gas   Custom Color*   Plated Trim*	\$ 11,975	\$ 13,770
<b>LP/Propane Models: 24" Nova Series – All French Top</b>			
RNB24FTV2L	24" Nova Series   24" French Top   LP Gas   Stainless Steel   Standard Trim	\$ 6,995	\$ 8,045
RNB24FTV2LPLT	24" Nova Series   24" French Top   LP Gas   Stainless Steel   Plated Trim*	\$ 8,460	\$ 9,730
RNB24FTV2LC	24" Nova Series   24" French Top   LP Gas   Std RAL Paint*   Standard Trim	\$ 8,090	\$ 9,305
RNB24FTV2LCPLT	24" Nova Series   24" French Top   LP Gas   Std RAL Paint*   Plated Trim*	\$ 9,555	\$ 10,990
RNB24FTV2LCF	24" Nova Series   24" French Top   LP Gas   Specialty Finish*   Standard Trim	\$ 9,080	\$ 10,440
RNB24FTV2LCFPLT	24" Nova Series   24" French Top   LP Gas   Specialty Finish*   Plated Trim*	\$ 10,545	\$ 12,125
RNB24FTV2LCC	24" Nova Series   24" French Top   LP Gas   Custom Color*   Standard Trim	\$ 10,510	\$ 12,085
RNB24FTV2LCCPLT	24" Nova Series   24" French Top   LP Gas   Custom Color*   Plated Trim*	\$ 11,975	\$ 13,770
<b>Customization &amp; Accessory Options: (See page 11)   Total Knobs: 2</b>			

## FREESTANDING RANGES: 36" PRECIOUS METALS SERIES

BlueStar Model Number Guide:			
<b>Base Model (RNB366BPMV2)</b> 6 Burners   Natural Gas   Stainless Steel Finish   Standard Trim	<b>Change to LP Gas</b> Add (L) for LP/Propane Gas	<b>Add code below for desired color</b> (C) 190 Standard RAL (Semi-Gloss) Colors (CF) Specialty Finish (190 Matte RAL, Precious Metals & Textures) (CC) Custom Colors	<b>Add (PLT) for Plated Trim</b> Includes plated bezels and logo. <b>Door handles are not plated</b> See available options below.

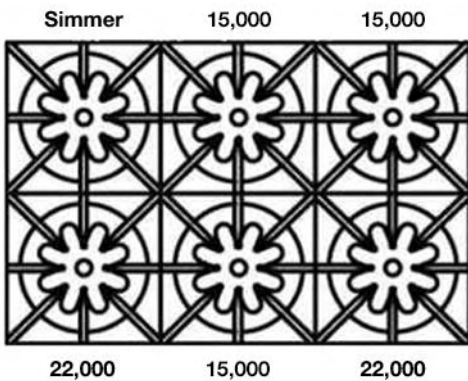

**FEATURES:**

- 22,000 BTU UltraNova™ burners & 18,000 BTU Nova™ burners
- Precise 130° simmer burner
- Unique French Door for easy loading and unloading
- Contemporary, urban aesthetic
- Extra-large convection oven with 1850° infrared broiler that accommodates a full size 18" x 26" commercial baking sheet
- Includes full extension rack
- Matching knobs & trim
- Handcrafted in Pennsylvania since 1880

**PRODUCT SPECIFICATIONS:**

- Unit Dimensions: 35.875"W x 24"D x 36.75"H
- Oven Interior: 29.25"W x 20"D x 15"H
- Top Burner Power: 22,000 BTUs
- Simmer Burner: 9,000 BTUs
- Electrical Reqs: 120V, 60Hz, 15 AMPS, 1PH
- Gas Pressure: NAT: 5.0" WC, LP 10.0" WC
- Gas Line Size: ½
- Unit Weight: 490 lbs.

Model	Description (* Denotes item that must be specified)	UMRP	MSRP
Five unique colors with matching knobs and bezels included. Standard with French doors. Includes matching knobs and bezels and body sides. Ginger Spice & Stainless Steel units will have Stainless Steel knobs. <b>Precious Metals ranges painted in an RAL color include painted body sides, knobs and bezels.</b>			
<b>Natural Gas Models: 36" Precious Metals Series</b>			
RNB366BPMV2	6 Burner   Nat Gas   Stainless Steel   Standard Trim	\$ 11,795	\$ 13,565
RNB366BPMV2PLT	6 Burner   Nat Gas   Stainless Steel   Plated Trim*	\$ 12,840	\$ 14,765
RNB366BPMV2C	6 Burner   Nat Gas   Any Color Option*   Std Trim	\$ 11,795	\$ 13,565
RNB366BPMV2CPLT	6 Burner   Nat Gas   Any Color Option*   Plated Trim*	\$ 12,840	\$ 14,765
RNB366BPMV2CC	6 Burner   Nat Gas   Custom Color*   Standard Trim	\$ 15,310	\$ 17,605
RNB366BPMV2CCPLT	6 Burner   Nat Gas   Custom Color*   Plated Trim*	\$ 16,355	\$ 18,810
<b>LP/Propane Models: 36" Precious Metals Series</b>			
RNB366BPMV2L	6 Burner   LP Gas   Stainless Steel   Standard Trim	\$ 11,795	\$ 13,565
RNB366BPMV2LPLT	6 Burner   LP Gas   Stainless Steel   Plated Trim*	\$ 12,840	\$ 14,765
RNB366BPMV2LC	6 Burner   LP Gas   Any Color Option *   Std Trim	\$ 11,795	\$ 13,565
RNB366BPMV2LCPLT	6 Burner   LP Gas   Any Color Option *   Plated Trim*	\$ 12,840	\$ 14,765
RNB366BPMV2LCC	6 Burner   LP Gas   Custom Color*   Standard Trim	\$ 15,310	\$ 17,605
RNB366BPMV2LCCPLT	6 Burner   LP Gas   Custom Color*   Plated Trim*	\$ 16,355	\$ 18,810
<b>BACKGUARD OPTIONS:</b>			
Only available with the installed island trim backguard.			
<b>KNOB &amp; PAINTED BODY SIDE OPTIONS: (Total Knobs: 7)</b>			
KN-BLK	Standard Black Knob (Ordered with unit)	N/C	N/C
KN-C	Knob: Standard 190 RAL Color	N/C	N/C
BZ-C	Bezel: Standard 190 RAL Color	N/C	N/C
KN-CF	Knob: Spec Finish (Matte RAL, Textured RAL or Prec Metals)	N/C	N/C
KN-PLT	Knob: Plated Trim (See options below)	\$ 250 ea	\$ 290 ea
<b>PLATED TRIM OPTIONS: (Includes bezels and logo only)</b>			
Antique Brass, Brushed Brass, Polished Brass, Antique Copper, Brushed Copper, Polished Copper, Chrome, Oil Rubbed Bronze & Pewter			
<b>PRECIOUS METALS COLORS</b>			
Statuary Bronze, Ginger Spice, Enchanted Silver, Enchanted Sand and Matte Black			
See page 32 for additional customization and accessories for Freestanding Ranges			

## FREESTANDING RANGES: 30" PRECIOUS METALS SERIES

### BlueStar Model Number Guide:

<b>Base Model (RNB304BPMV2)</b> 4 Burners   Natural Gas   Stainless Steel Finish   Standard Trim	<b>Change to LP Gas</b> Add (L) for LP/Propane Gas	<b>Add code below for desired color</b> (C) 190 Standard RAL (Semi-Gloss) Colors (CF) Specialty Finish (190 Matte RAL, Precious Metals & Textures) (CC) Custom Colors	<b>Add (PLT) for Plated Trim</b> Includes plated bezels and logo. <b>Door handles are not plated</b> See available options below.
-----------------------------------------------------------------------------------------------------	-------------------------------------------------------	--------------------------------------------------------------------------------------------------------------------------------------------------------------------------------	--------------------------------------------------------------------------------------------------------------------------------------------

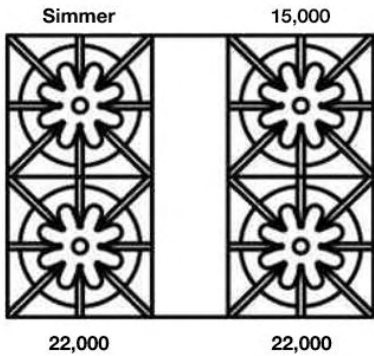

Model	Description (* Denotes item that must be specified)	UMRP	MSRP
Five unique colors with matching knobs and bezels included. Standard with French doors. Includes matching knobs and bezels and body sides. Ginger Spice & Stainless Steel units will have Stainless Steel knobs. <b>Precious Metals ranges painted in an RAL color include painted body sides, knobs and bezels.</b>			
<b>Natural Gas Models: 30" Precious Metals Series</b>			
RNB304BPMV2	4 Burner   Nat Gas   Stainless Steel   Standard Trim	\$ 9,595	\$ 11,035
RNB304BPMV2PLT	4 Burner   Nat Gas   Stainless Steel   Plated Trim*	\$ 10,325	\$ 11,875
RNB304BPMV2C	4 Burner   Nat Gas   Any Color Option *   Std Trim	\$ 9,595	\$ 11,035
RNB304BPMV2CPLT	4 Burner   Nat Gas   Any Color Option *   Plated Trim*	\$ 10,325	\$ 11,875
RNB304BPMV2CC	4 Burner   Nat Gas   Custom Color*   Standard Trim	\$ 13,110	\$ 15,075
RNB304BPMV2CCPLT	4 Burner   Nat Gas   Custom Color*   Plated Trim*	\$ 13,840	\$ 15,915
<b>LP/Propane Models: 30" Precious Metals Series</b>			
RNB304BPMV2L	4 Burner   LP Gas   Stainless Steel   Standard Trim	\$ 9,595	\$ 11,035
RNB304BPMV2LPLT	4 Burner   LP Gas   Stainless Steel   Plated Trim*	\$ 10,325	\$ 11,875
RNB304BPMV2LC	4 Burner   LP Gas   Any Color Option *   Std Trim	\$ 9,595	\$ 11,035
RNB304BPMV2LCPLT	4 Burner   LP Gas   Any Color Option *   Plated Trim*	\$ 10,325	\$ 11,875
RNB304BPMV2LCC	4 Burner   LP Gas   Custom Color*   Standard Trim	\$ 13,110	\$ 15,075
RNB304BPMV2LCCPLT	4 Burner   LP Gas   Custom Color*   Plated Trim*	\$ 13,840	\$ 15,915
<b>BACKGUARD OPTIONS:</b>			
Only available with the installed island trim backguard.			
<b>KNOB &amp; PAINTED BODY SIDE OPTIONS: (Total Knobs: 5)</b>			
KN-BLK	Standard Black Knob (Ordered with unit)	N/C	N/C
KN-C	Knob: Standard 190 RAL Color	N/C	N/C
BZ-C	Bezel: Standard 190 RAL Color	N/C	N/C
KN-CF	Knob: Spec Finish (Matte RAL, Textured RAL or Prec Metals)	N/C	N/C
KN-PLT	Knob: Plated Trim (See options below)	\$ 250 ea	\$ 290 ea
<b>PLATED TRIM OPTIONS: (Includes bezels and logo only)</b>			
Antique Brass, Brushed Brass, Polished Brass, Antique Copper, Brushed Copper, Polished Copper, Chrome, Oil Rubbed Bronze & Pewter			
<b>PRECIOUS METALS COLORS</b>			
Statuary Bronze, Ginger Spice, Enchanted Silver, Enchanted Sand and Matte Black			
See page 32 for additional customization and accessories for Freestanding Ranges			

### FEATURES:

- 22,000 BTU UltraNova™ burners & 18,000 BTU Nova™ burners
- Precise 130° simmer burner
- Unique French Door for easy loading and unloading
- Contemporary, urban aesthetic
- Extra-large convection oven with 1850° infrared broiler that accommodates a full size 18" x 26" commercial baking sheet
- Includes full extension rack
- Matching knobs & trim
- Handcrafted in Pennsylvania since 1880

### PRODUCT SPECIFICATIONS:

- Unit Dimensions: 29.875W x 24"D x 36.75"H
- Oven Interior: 26.438"W x 20"D x 15"H
- Top Burner Power: 22,000 BTUs
- Simmer Burner: 9,000 BTUs
- Electrical Reqs: 120V, 60Hz, 15 AMPS, 1PH
- Gas Pressure: NAT: 5.0" WC, LP 10.0" WC
- Gas Line Size: ½
- Unit Weight: 440 lbs.

# FREESTANDING RANGES: 30" & 36" CULINARY SERIES – OPEN BURNER

## BlueStar Model Number Guide:

<b>Base Model (RCS304BV2)</b> 4 Burners   Natural Gas   Stainless Steel Finish   Standard Trim	<b>Change to LP Gas</b> Add (L) for LP/Propane Gas	<b>Add code below for desired color</b> Not available on Culinary Series – Open Burner models	<b>Add (PLT) for Plated Trim</b> Not available on Culinary Series – Open Burner models
---------------------------------------------------------------------------------------------------	-------------------------------------------------------	--------------------------------------------------------------------------------------------------	-------------------------------------------------------------------------------------------



Model Shown: RCS304BV2



Model Shown: RCS366BV2

Model	Description (* Denotes item that must be specified)	UMRP	MSRP
<b>Natural Gas Models: 30" &amp; 36" Culinary Series – Open Burner</b>			
RCS304BV2	4 Burner   Nat Gas   Stainless Steel   Standard Trim	\$ 4,795	\$ 5,515
RCS366BV2	6 Burner   Nat Gas   Stainless Steel   Standard Trim	\$ 5,795	\$ 6,665
<b>LP/Propane Models: 30" &amp; 36" Culinary Series – Open Burner</b>			
RCS304BV2L	4 Burner   LP Gas   Stainless Steel   Standard Trim	\$ 4,795	\$ 5,515
RCS366BV2L	6 Burner   LP Gas   Stainless Steel   Standard Trim	\$ 5,795	\$ 6,665
<b>BACKGUARD OPTIONS:</b>			
<b>All BlueStar freestanding appliances must be installed with a UL approved backguard. All units ship standard with a UL approved Island Trim unless otherwise specified.</b>			
BG630BSP	6" Backguard for 30" RCS Range	\$ 550	\$ 635
BG3017BSP	17" Backguard for 30" RCS Range	\$ 1,020	\$ 1,175
SDHS30BSP	24" High Shelf for 30" RCS Range	\$ 1,325	\$ 1,525
BG636BSP	6" Backguard for 36" RCS Range	\$ 655	\$ 755
BG3617BSP	17" Backguard for 36" RCS Range	\$ 1,325	\$ 1,525
SDHS36BSP	24" High Shelf for 36" RCS Range	\$ 1,535	\$ 1,765
<b>KNOB OPTIONS: (Total Knobs: 30" – 5   36" – 7)</b>			
KN-SS	Brushed Stainless Steel Knob	\$ 115 ea	\$ 130 ea
KN-C	Knob: Standard 190 RAL Color	\$ 115 ea	\$130 ea
BZ-C	Bezel: Standard 190 RAL Color	\$ 65 ea	\$ 75 ea
KN-CF	Knob: Spec Finish (Matte RAL, Textured RAL or Prec Metals)	\$ 185 ea	\$ 215 ea
KN-PLT	Knob: Plated Trim (See options below)	\$ 250 ea	\$ 290 ea
Antique Brass, Brushed Brass, Polished Brass, Antique Copper, Brushed Copper, Polished Copper, Chrome, Oil Rubbed Bronze & Pewter			
See page 32 for additional customization and accessories for Freestanding Ranges			

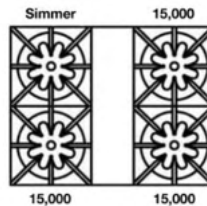

RCS304BV2

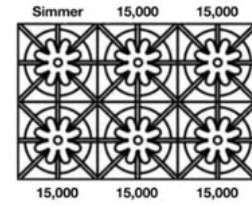

RCS366BV2

## FEATURES:

- 15,000 BTU Nova™ open burners
- Precise 130° simmer burner
- Extra-large convection oven with 1850° infrared broiler that accommodates a full size 18" x 26" commercial baking sheet
- Available in stainless steel only
- Handcrafted in Pennsylvania since 1880

## PRODUCT SPECIFICATIONS:

- 30" Unit Dimensions: 29.875W x 24"D x 36.75"H
- 36" Unit Dimensions: 35.875"W x 24"D x 36.75"H
- 30" Oven Interior: 26.438"W x 20"D x 15"H
- 36" Oven Interior: 29.25"W x 20"D x 15"H
- Top Burner Power: 15,000 BTUs
- Simmer Burner: 9,000 BTUs
- Electrical Requirements: 120V, 60Hz, 15 AMPS, 1PH
- Gas Pressure: NAT: 5.0" WC, LP 10.0" WC
- Gas Line Size: ½
- 30" Unit Weight: 420 lbs.
- 36" Unit Weight: 470 lbs.

# FREESTANDING RANGES: 48" CULINARY SERIES – SEALED BURNER BURNER

<b>BlueStar Model Number Guide:</b>			
<b>Base Model (RCS48SBV2)</b> 8 Burners   Natural Gas   Stainless Steel Finish   Standard Trim	<b>Change to LP Gas</b> Add (L) for LP/Propane Gas	<b>Add code below for desired color</b> (C) 190 Standard RAL (Semi-Gloss) Colors (CF) Specialty Finish (190 Matte RAL, Precious Metals & Textures) (CC) Custom Colors	<b>Add (PLT) for Plated Trim</b> Includes plated bezels, door handle, handle end and logo. See available options below.

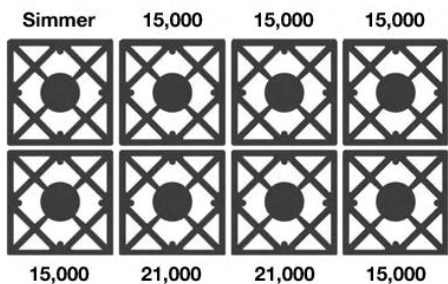

Model	Description (* Denotes item that must be specified)	UMRP	MSRP
<b>Natural Gas Models: 48" Culinary Series – Sealed Burner</b>			
RCS48SBV2	8 Burner   Nat Gas   Stainless Steel   Standard Trim	\$ 9,295	\$ 10,690
RCS48SBV2PLT	8 Burner   Nat Gas   Stainless Steel   Plated Trim*	\$ 11,390	\$ 13,100
RCS48SBV2C	8 Burner   Nat Gas   Std RAL Color*   Standard Trim	\$ 10,720	\$ 12,330
RCS48SBV2CPLT	8 Burner   Nat Gas   Std RAL Color*   Plated Trim*	\$ 12,815	\$ 14,735
RCS48SBV2CF	8 Burner   Nat Gas   Specialty Finish*   Standard Trim	\$ 11,820	\$ 13,595
RCS48SBV2CFPLT	8 Burner   Nat Gas   Specialty Finish*   Plated Trim*	\$ 13,915	\$ 16,000
RCS48SBV2CC	8 Burner   Nat Gas   Custom Color*   Standard Trim	\$ 13,250	\$ 15,235
RCS48SBV2CCPLT	8 Burner   Nat Gas   Custom Color*   Plated Trim*	\$ 15,345	\$ 17,645
<b>LP/Propane Models: 48" Culinary Series – Sealed Burner</b>			
RCS48SBV2L	8 Burner   LP Gas   Stainless Steel   Standard Trim	\$ 9,295	\$ 10,690
RCS48SBV2LPLT	8 Burner   LP Gas   Stainless Steel   Plated Trim*	\$ 11,390	\$ 13,100
RCS48SBV2LC	8 Burner   LP Gas   Std RAL Color*   Standard Trim	\$ 10,720	\$ 12,330
RCS48SBV2LCPLT	8 Burner   LP Gas   Std RAL Color*   Plated Trim*	\$ 12,815	\$ 14,735
RCS48SBV2LCF	8 Burner   LP Gas   Specialty Finish*   Standard Trim	\$ 11,820	\$ 13,595
RCS48SBV2LCFPLT	8 Burner   LP Gas   Specialty Finish*   Plated Trim*	\$ 13,915	\$ 16,000
RCS48SBV2LCC	8 Burner   LP Gas   Custom Color*   Standard Trim	\$ 13,250	\$ 15,235
RCS48SBV2LCCPLT	8 Burner   LP Gas   Custom Color*   Plated Trim*	\$ 15,345	\$ 17,645
<b>BACKGUARD OPTIONS:</b>			
<b>All BlueStar freestanding appliances must be installed with a UL approved backguard. All units ship standard with a UL approved Island Trim unless otherwise specified.</b>			
BG648SB	6" Backguard	\$ 945	\$ 1,085
<b>KNOB &amp; PAINTED BODY SIDE OPTIONS: (Total Knobs: 10)</b>			
SIDES-C	Add Painted Sides (All colors)	\$ 695	\$ 800
KN-SS	Knob: Brushed Stainless Steel	\$ 115 ea	\$ 130 ea
KN-C	Knob: Standard 190 RAL Color	\$ 115 ea	\$ 130 ea
BZ-C	Bezel: Standard 190 RAL Color	\$ 65 ea	\$ 75 ea
KN-CF	Knob: Spec Finish (Matte RAL, Textured RAL or Prec Metals)	\$ 185 ea	\$ 215 ea
KN-PLT	Knob: Plated Trim (See options below)	\$ 250 ea	\$ 290 ea
<b>PLATED TRIM OPTIONS: (Includes bezels, door handle, handle ends and logo)</b>			
Antique Brass, Brushed Brass, Polished Brass, Antique Copper, Brushed Copper, Polished Copper, Chrome, Oil Rubbed Bronze & Pewter			
See page 32 for additional customization and accessories for Freestanding Ranges			

**FEATURES:**

- Sealed burner design with up to 21,000 BTUs of power (18,000 BTUs on LP/Propane models)
- Precise simmer burner
- Extra-large convection oven with 1850° infrared broiler that accommodates a full size 18" x 26" commercial baking sheet.
- 24" depth for compatibility with standard kitchen cabinetry
- Available in 1,000+ colors and finishes
- Handcrafted in Pennsylvania since 1880

**PRODUCT SPECIFICATIONS:**

- Unit Dimensions: 47.875"W x 24"D x 36.75"H
- Large Oven Intr: 26.438"W x 20"D x 15"H
- Small Oven Intr: 13.578"W x 20"D x 15"H
- Top Burner Power: NAT: 21,000 BTUs / LP: 18,000 BTUs
- Simmer Burner: 5,000 BTUs
- Electrical Reqs: 120V, 60Hz, 15 AMPS, 1PH
- Gas Pressure: NAT: 5.0" WC, LP 10.0" WC
- Gas Line Size: ¾"
- Unit Weight: 645 lbs.

# FREESTANDING RANGES: 36" CULINARY SERIES – SEALED BURNER BURNER

BlueStar Model Number Guide:			
<b>Base Model (RCS36SBV2)</b> 6 Burners   Natural Gas   Stainless Steel Finish   Standard Trim	<b>Change to LP Gas</b> Add (L) for LP/Propane Gas	<b>Add code below for desired color</b> (C) 190 Standard RAL (Semi-Gloss) Colors (CF) Specialty Finish (190 Matte RAL, Precious Metals & Textures) (CC) Custom Colors	<b>Add (PLT) for Plated Trim</b> Includes plated bezels, door handle, handle end and logo. See available options below.

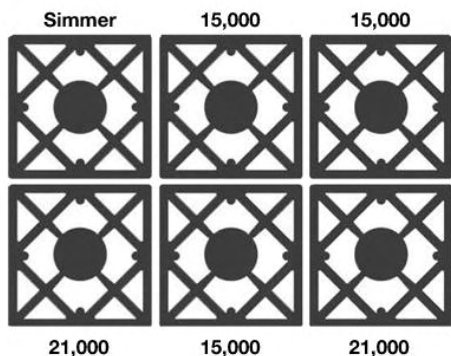

**FEATURES:**

- Sealed burner design with up to 21,000 BTUs of power (18,000 BTUs on LP/Propane models)
- Precise simmer burner
- Extra-large convection oven with 1850° infrared broiler that accommodates a full size 18" x 26" commercial baking sheet.
- 24" depth for compatibility with standard kitchen cabinetry
- Available in 1,000+ colors and finishes
- Handcrafted in Pennsylvania since 1880

**PRODUCT SPECIFICATIONS:**

- Unit Dimensions: 35.875"W x 24"D x 36.75"H
- Oven Interior: 29.25"W x 20"D x 15"H
- Top Burner Power: 21,000 BTUs / 18,000 BTUs
- Simmer Burner: 5,000 BTUs
- Electrical Reqs: 120V, 60Hz, 15 AMPS, 1PH
- Gas Pressure: NAT: 5.0" WC, LP 10.0" WC
- Gas Line Size: ½"
- Unit Weight: 420 lbs.

Model	Description (* Denotes item that must be specified)	UMRP	MSRP
<b>Natural Gas Models: 36" Culinary Series – Sealed Burner</b>			
RCS36SBV2	6 Burner   Nat Gas   Stainless Steel   Standard Trim	\$ 5,795	\$ 6,665
RCS36SBV2PLT	6 Burner   Nat Gas   Stainless Steel   Plated Trim*	\$ 7,575	\$ 8,710
RCS36SBV2C	6 Burner   Nat Gas   Std RAL Color*   Standard Trim	\$ 6,890	\$ 7,925
RCS36SBV2CPLT	6 Burner   Nat Gas   Std RAL Color*   Plated Trim*	\$ 8,670	\$ 9,970
RCS36SBV2CF	6 Burner   Nat Gas   Specialty Finish*   Standard Trim	\$ 7,880	\$ 9,060
RCS36SBV2CFPLT	6 Burner   Nat Gas   Specialty Finish*   Plated Trim*	\$ 9,660	\$ 11,110
RCS36SBV2CC	6 Burner   Nat Gas   Custom Color*   Standard Trim	\$ 9,310	\$ 10,705
RCS36SBV2CCPLT	6 Burner   Nat Gas   Custom Color*   Plated Trim*	\$ 11,090	\$ 12,755
<b>LP/Propane Models: 36" Culinary Series – Sealed Burner</b>			
RCS36SBV2L	6 Burner   LP Gas   Stainless Steel   Standard Trim	\$ 5,795	\$ 6,665
RCS36SBV2LPLT	6 Burner   LP Gas   Stainless Steel   Plated Trim*	\$ 7,575	\$ 8,710
RCS36SBV2LC	6 Burner   LP Gas   Std RAL Color*   Standard Trim	\$ 6,890	\$ 7,925
RCS36SBV2LCPLT	6 Burner   LP Gas   Std RAL Color*   Plated Trim*	\$ 8,670	\$ 9,970
RCS36SBV2LCF	6 Burner   LP Gas   Specialty Finish*   Standard Trim	\$ 7,880	\$ 9,060
RCS36SBV2LCFPLT	6 Burner   LP Gas   Specialty Finish*   Plated Trim*	\$ 9,660	\$ 11,110
RCS36SBV2LCC	6 Burner   LP Gas   Custom Color*   Standard Trim	\$ 9,310	\$ 10,705
RCS36SBV2LCCPLT	6 Burner   LP Gas   Custom Color*   Plated Trim*	\$ 11,090	\$ 12,755
<b>BACKGUARD OPTIONS:</b>			
<b>All BlueStar freestanding appliances must be installed with a UL approved backguard. All units ship standard with a UL approved Island Trim unless otherwise specified.</b>			
BG636SB	6" Backguard	\$ 655	\$ 755
BG3617SB	17" Backguard	\$ 1,325	\$ 1,525
SDHS36SB	24" High Shelf	\$ 1,535	\$ 1,765
<b>KNOB &amp; PAINTED BODY SIDE OPTIONS: (Total Knobs: 7)</b>			
SIDES-C	Add Painted Sides (All colors)	\$ 695	\$ 800
KN-SS	Knob: Brushed Stainless Steel	\$ 115 ea	\$ 130 ea
KN-C	Knob: Standard 190 RAL Color	\$ 115 ea	\$ 130 ea
BZ-C	Bezel: Standard 190 RAL Color	\$ 65 ea	\$ 75 ea
KN-CF	Knob: Spec Finish (Matte RAL, Textured RAL or Prec Metals)	\$ 185 ea	\$ 215 ea
KN-PLT	Knob: Plated Trim (See options below)	\$ 250 ea	\$ 290 ea
<b>PLATED TRIM OPTIONS: (Includes bezels, door handle, handle ends and logo)</b>			
Antique Brass, Brushed Brass, Polished Brass, Antique Copper, Brushed Copper, Polished Copper, Chrome, Oil Rubbed Bronze & Pewter			
See page 32 for additional customization and accessories for Freestanding Ranges			

# FREESTANDING RANGES: 30" CULINARY SERIES – SEALED BURNER BURNER

BlueStar Model Number Guide:			
<b>Base Model (RCS30SBV2)</b> 4 Burners   Natural Gas   Stainless Steel Finish   Standard Trim	<b>Change to LP Gas</b> Add (L) for LP/Propane Gas	<b>Add code below for desired color</b> (C) 190 Standard RAL (Semi-Gloss) Colors (CF) Specialty Finish (190 Matte RAL, Precious Metals & Textures) (CC) Custom Colors	<b>Add (PLT) for Plated Trim</b> Includes plated bezels, door handle, handle end and logo. See available options below.

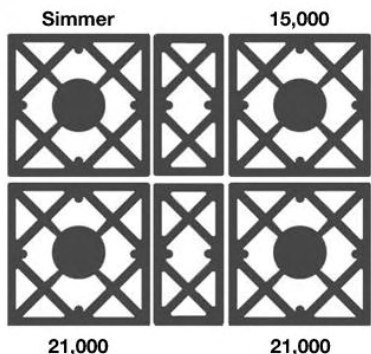

### FEATURES:

- Sealed burner design with up to 21,000 BTUs of power (18,000 BTUs on LP/Propane models)
- Precise simmer burner
- Extra-large convection oven with 1850° infrared broiler that accommodates a full size 18" x 26" commercial baking sheet. 24" model accommodates half size baking sheet.
- 24" depth for compatibility with standard kitchen cabinetry
- Available in 1,000+ colors and finishes
- Handcrafted in Pennsylvania since 1880

### PRODUCT SPECIFICATIONS:

- Unit Dimensions: 29.875"W x 24"D x 36.75"H
- Oven Interior: 26.438"W x 20"D x 15"H
- Top Burner Power: 21,000 BTUs / 18,000 BTUs
- Simmer Burner: 5,000 BTUs
- Electrical Reqs: 120V, 60Hz, 15 AMPS, 1PH
- Gas Pressure: NAT: 5.0" WC, LP 10.0" WC
- Gas Line Size: ½"
- Unit Weight: 380 lbs.

Model	Description (* Denotes item that must be specified)	UMRP	MSRP
<b>Natural Gas Models: 30" Culinary Series – Sealed Burner</b>			
RCS30SBV2	4 Burner   Nat Gas   Stainless Steel   Standard Trim	\$ 4,795	\$ 5,515
RCS30SBV2PLT	4 Burner   Nat Gas   Stainless Steel   Plated Trim*	\$ 6,260	\$ 7,200
RCS30SBV2C	4 Burner   Nat Gas   Std RAL Color*   Standard Trim	\$ 5,890	\$ 6,775
RCS30SBV2CPLT	4 Burner   Nat Gas   Std RAL Color*   Plated Trim*	\$ 7,355	\$ 8,460
RCS30SBV2CF	4 Burner   Nat Gas   Specialty Finish*   Standard Trim	\$ 6,880	\$ 7,910
RCS30SBV2CFPLT	4 Burner   Nat Gas   Specialty Finish*   Plated Trim*	\$ 8,345	\$ 9,595
RCS30SBV2CC	4 Burner   Nat Gas   Custom Color*   Standard Trim	\$ 8,310	\$ 9,555
RCS30SBV2CCPLT	4 Burner   Nat Gas   Custom Color*   Plated Trim*	\$ 9,775	\$ 11,240
<b>LP/Propane Models: 30" Culinary Series – Sealed Burner</b>			
RCS30SBV2L	4 Burner   LP Gas   Stainless Steel   Standard Trim	\$ 4,795	\$ 5,515
RCS30SBV2LPLT	4 Burner   LP Gas   Stainless Steel   Plated Trim*	\$ 6,260	\$ 7,200
RCS30SBV2LC	4 Burner   LP Gas   Std RAL Color*   Standard Trim	\$ 5,890	\$ 6,775
RCS30SBV2LCPLT	4 Burner   LP Gas   Std RAL Color*   Plated Trim*	\$ 7,355	\$ 8,460
RCS30SBV2LCF	4 Burner   LP Gas   Specialty Finish*   Standard Trim	\$ 6,880	\$ 7,910
RCS30SBV2LCFPLT	4 Burner   LP Gas   Specialty Finish*   Plated Trim*	\$ 8,345	\$ 9,595
RCS30SBV2LCC	4 Burner   LP Gas   Custom Color*   Standard Trim	\$ 8,310	\$ 9,555
RCS30SBV2LCCPLT	4 Burner   LP Gas   Custom Color*   Plated Trim*	\$ 9,775	\$ 11,240
<b>BACKGUARD OPTIONS:</b>			
<b>All BlueStar freestanding appliances must be installed with a UL approved backguard. All units ship standard with a UL approved Island Trim unless otherwise specified.</b>			
BG630SB	6" Backguard	\$ 550	\$ 635
BG3017SB	17" Backguard	\$ 1,020	\$ 1,175
SDHS30SB	24" High Shelf	\$ 1,325	\$ 1,525
<b>KNOB &amp; PAINTED BODY SIDE OPTIONS: (Total Knobs: 5)</b>			
SIDES-C	Add Painted Sides (All colors)	\$ 695	\$ 800
KN-SS	Knob: Brushed Stainless Steel	\$ 115 ea	\$ 130 ea
KN-C	Knob: Standard 190 RAL Color	\$ 115 ea	\$ 130 ea
BZ-C	Bezel: Standard 190 RAL Color	\$ 65 ea	\$ 75 ea
KN-CF	Knob: Spec Finish (Matte RAL, Textured RAL or Prec Metals)	\$ 185 ea	\$ 215 ea
KN-PLT	Knob: Plated Trim (See options below)	\$ 250 ea	\$ 290 ea
<b>PLATED TRIM OPTIONS: (Includes bezels, door handle, handle ends and logo)</b>			
Antique Brass, Brushed Brass, Polished Brass, Antique Copper, Brushed Copper, Polished Copper, Chrome, Oil Rubbed Bronze & Pewter			
See page 32 for additional customization and accessories for Freestanding Ranges			

# FREESTANDING RANGES: 24" CULINARY SERIES – SEALED BURNER BURNER

BlueStar Model Number Guide:			
<b>Base Model (RCS24SBV2)</b> 4 Burners   Natural Gas   Stainless Steel Finish   Standard Trim	<b>Change to LP Gas</b> Add (L) for LP/Propane Gas	<b>Add code below for desired color</b> (C) 190 Standard RAL (Semi-Gloss) Colors (CF) Specialty Finish (190 Matte RAL, Precious Metals & Textures) (CC) Custom Colors	<b>Add (PLT) for Plated Trim</b> Includes plated bezels, door handle, handle end and logo. See available options below.

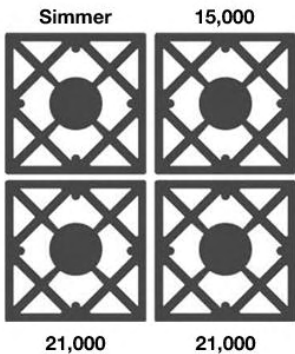

**FEATURES:**

- Sealed burner design with up to 21,000 BTUs of power (18,000 BTUs on LP/Propane models)
- Precise simmer burner
- Extra-large convection oven with 1850° infrared broiler that accommodates a half size 18" x 13" commercial baking sheet.
- 24" depth for compatibility with standard kitchen cabinetry
- Available in 1,000+ colors and finishes
- Handcrafted in Pennsylvania since 1880

**PRODUCT SPECIFICATIONS:**

- Unit Dimensions: 23.875"W x 24"D x 36.75"H
- Oven Interior: 20.25"W x 20"D x 15"H
- Top Burner Power: 21,000 BTUs / 18,000 BTUs
- Simmer Burner: 5,000 BTUs
- Electrical Reqs: 120V, 60Hz, 15 AMPS, 1PH
- Gas Pressure: NAT: 5.0" WC, LP 10.0" WC
- Gas Line Size: ½"
- Unit Weight: 365 lbs

Model	Description (* Denotes item that must be specified)	UMRP	MSRP
<b>Natural Gas Models: 24" Culinary Series – Sealed Burner</b>			
RCS24SBV2	4 Burner   Nat Gas   Stainless Steel   Standard Trim	\$ 4,195	\$ 4,825
RCS24SBV2PLT	4 Burner   Nat Gas   Stainless Steel   Plated Trim*	\$ 5,660	\$ 6,510
RCS24SBV2C	4 Burner   Nat Gas   Std RAL Color*   Standard Trim	\$ 5,290	\$ 6,085
RCS24SBV2CPLT	4 Burner   Nat Gas   Std RAL Color*   Plated Trim*	\$ 6,755	\$ 7,770
RCS24SBV2CF	4 Burner   Nat Gas   Specialty Finish*   Standard Trim	\$ 6,280	\$ 7,220
RCS24SBV2CFPLT	4 Burner   Nat Gas   Specialty Finish*   Plated Trim*	\$ 7,745	\$ 8,905
RCS24SBV2CC	4 Burner   Nat Gas   Custom Color*   Standard Trim	\$ 7,710	\$ 8,865
RCS24SBV2CCPLT	4 Burner   Nat Gas   Custom Color*   Plated Trim*	\$ 9,175	\$ 10,550
<b>LP/Propane Models: 24" Culinary Series – Sealed Burner</b>			
RCS24SBV2L	4 Burner   LP Gas   Stainless Steel   Standard Trim	\$ 4,195	\$ 4,825
RCS24SBV2LPLT	4 Burner   LP Gas   Stainless Steel   Plated Trim*	\$ 5,660	\$ 6,510
RCS24SBV2LC	4 Burner   LP Gas   Std RAL Color*   Standard Trim	\$ 5,290	\$ 6,085
RCS24SBV2LCPLT	4 Burner   LP Gas   Std RAL Color*   Plated Trim*	\$ 6,755	\$ 7,770
RCS24SBV2LCF	4 Burner   LP Gas   Specialty Finish*   Standard Trim	\$ 6,280	\$ 7,220
RCS24SBV2LCFPLT	4 Burner   LP Gas   Specialty Finish*   Plated Trim*	\$ 7,745	\$ 8,905
RCS24SBV2LCC	4 Burner   LP Gas   Custom Color*   Standard Trim	\$ 7,710	\$ 8,865
RCS24SBV2LCCPLT	4 Burner   LP Gas   Custom Color*   Plated Trim*	\$ 9,175	\$ 10,550
<b>BACKGUARD OPTIONS:</b>			
<b>All BlueStar freestanding appliances must be installed with a UL approved backguard. All units ship standard with a UL approved Island Trim unless otherwise specified.</b>			
BG624SB	6" Backguard	\$ 550	\$ 635
BG2417SB	17" Backguard	\$ 1,020	\$ 1,175
SDHS24SB	24" High Shelf	\$ 1,325	\$ 1,525
<b>KNOB &amp; PAINTED BODY SIDE OPTIONS: (Total Knobs: 5)</b>			
SIDES-C	Add Painted Sides (All colors)	\$ 695	\$ 800
KN-SS	Knob: Brushed Stainless Steel	\$ 115 ea	\$ 130 ea
KN-C	Knob: Standard 190 RAL Color	\$ 115 ea	\$ 130 ea
BZ-C	Bezel: Standard 190 RAL Color	\$ 65 ea	\$ 75 ea
KN-CF	Knob: Spec Finish (Matte RAL, Textured RAL or Prec Metals)	\$ 185 ea	\$ 215 ea
KN-PLT	Knob: Plated Trim (See options below)	\$ 250 ea	\$ 290 ea
<b>PLATED TRIM OPTIONS: (Includes bezels, door handle, handle ends and logo)</b>			
Antique Brass, Brushed Brass, Polished Brass, Antique Copper, Brushed Copper, Polished Copper, Chrome, Oil Rubbed Bronze & Pewter			
See page 32 for additional customization and accessories for Freestanding Ranges			

## FREESTANDING RANGES: CUSTOMIZATION & ACCESSORY OPTIONS

Item	Description	UMRP	MSRP
<b>CONFIGURATION OPTIONS: (Available on Platinum &amp; Nova/RNB Series Only)</b>			
BURNER CHG	Add (1) Star Burner – RNB / RGTNB (Simmer, 15K & 22K)   BSP (Simmer, 15K, 18K, 22K or 25K) or Swap (2) Star Burners – RNB / RGTNB / BSP	\$ 650	\$ 745
SWING DOOR – LH	Swing Door – Left Hinge – 24”, 30”, 36”, 48” (Left Oven) & 60” (Left Oven) (RNB Series Only)	\$ 1,390	\$ 1,600
SWING DOOR – RH	Swing Door – Right Hinge – 24”, 30”, 36”, 48” (Right Oven) & 60” (Right Oven) (RNB Series Only)	\$ 1,390	\$ 1,600
<b>PAINT OPTIONS: (Available on Platinum, Nova/RNB &amp; Culinary Series – Sealed Burner Series Only)</b>			
SIDES-C	Body Sides: Standard RAL (Semi-Gloss) (2) Body sides – RNB/Platinum Excludes Pearl, Luminous & Aluminum) Must be ordered with painted range	\$ 695	\$ 800
KN-C	Knob: Standard RAL (Semi-Gloss) Knob – Factory Installed . (Excludes Pearl, Luminous & Aluminum)	\$ 115 ea	\$ 130 ea
BZ-C	Bezel: Standard RAL (Semi-Gloss) Knob – Factory Installed . (Excludes Pearl, Luminous & Aluminum)	\$ 65 ea	\$ 75 ea
SIDES-CF	Body Sides: Specialty Finish (Matte RAL, Textured RAL or Precious Metals) (2) Body Sides – Nova/RNB , Platinum or Culinary Series – Sealed Burner. (Excludes Pearl, Luminous & Aluminum)	\$ 625	\$ 720
KN-CF	Knob: Specialty Finish (Matte RAL, Textured RAL or Precious Metals) – Factory Installed .	\$185 ea	\$215 ea
SIDES-CC	Body Sides: Custom Color (2) Body Sides. MUST be ordered with 24” – 60” Custom Color appliance.	\$ 620	\$ 715
KN-CC	Knob: Custom Color Knob – Factory Installed. MUST be ordered with 24” – 60” Custom Color appliance.	\$ 200 ea	\$ 230 ea
<b>PLATING OPTIONS:</b>			
KN-PLT	Knob: Plated Trim	\$ 250 ea	\$ 290 ea
BZ-PLT	Bezel: Plated Trim	\$ 160 ea	\$ 185 ea
<b>ACCESSORIES:</b>			
IT24BSP	24” Island Trim Backguard for Platinum, Nova (RNB) and RCS Open Burner Ranges	\$ 515	\$ 590
IT30BSP	30” Island Trim Backguard for Platinum, Nova (RNB) and RCS Open Burner Ranges	\$ 515	\$ 590
IT36BSP	36” Island Trim Backguard for Platinum, Nova (RNB) and RCS Open Burner Ranges	\$ 605	\$ 695
IT48BSP	48” Island Trim Backguard for Platinum, Nova (RNB) and RCS Open Burner Ranges	\$ 870	\$ 1,000
IT60BSP	60” Island Trim Backguard for Platinum, Nova (RNB) and RCS Open Burner Ranges	\$ 1,100	\$ 1,265
IT24SB	24” Island Trim Backguard for RCS Sealed Burner Ranges	\$ 515	\$ 590
IT30SB	30” Island Trim Backguard for RCS Sealed Burner Ranges	\$ 515	\$ 590
IT36SB	36” Island Trim Backguard for RCS Sealed Burner Ranges	\$ 605	\$ 695
IT48SB	48” Island Trim Backguard for RCS Sealed Burner Ranges	\$ 870	\$ 1,000
KN-SS	Knob: Brushed Stainless Steel	\$ 115 ea	\$ 130 ea
KN-BLK	Standard Black Knob	\$ 80 ea	\$ 90 ea
BZ-SS	Bezel: Brushed Stainless Steel	\$ 65 ea	\$ 75 ea
EXTN RACK 24	Full Extension Rack for 24” Freestanding Ranges & Wall Ovens	\$ 500	\$ 575
EXTN RACK 30	Full Extension Rack for 30” Freestanding Ranges & Wall Ovens	\$ 535	\$ 615
EXTN RACK 36	Full Extension Rack for 36” Freestanding Ranges & Wall Ovens	\$ 565	\$ 650
704406	Standard Oven Rack for 24” Freestanding Ranges & Wall Ovens	\$ 110	\$ 125
704405	Standard Oven Rack for 30” Freestanding Ranges & Wall Ovens	\$ 140	\$ 160
704402	Standard Oven Rack for 36” Freestanding Ranges & Wall Ovens	\$ 160	\$ 185
704407	Standard Oven Rack for 48” Freestanding Range Small Oven	\$105	\$ 120
731202	Rotating Caster (w/o Brake – Not Installed) 24” – 36” units require 2 ea   48” – 60” units require 3 ea.	\$ 130 ea	\$ 150 ea
731201	Locking Caster (w/ Brake – Not Installed) 24” – 36” units require 2 ea   48” – 60” units require 3 ea.	\$ 145 ea	\$ 165 ea
723101	Standard Leg 2.5” Tall (Not Installed) 24” – 36” units require 4 ea   48” – 60” units require 6 ea.	\$ 180 ea	\$ 205 ea
723102	High Leg 5.5” Tall (Not Installed) 24” – 36” units require 4 ea   48” – 60” units require 6 ea.	\$ 200 ea	\$ 230 ea
BSPICBG12	Interchangeable Griddle Charbroiler – 4 piece	\$ 1,195	\$ 1,375
WOK RING	Wok Ring	\$ 280	\$ 320



## **RANGETOPS & COOKTOPS**

**Get the Look: 60" Nova Series Rangetop with 24" Griddle & Antique Brass Trim**

## RANGETOPS: 60" PLATINUM SERIES

<b>BlueStar Model Number Guide:</b>			
<b>Base Model (BSPRT6010B)</b> 10 Burners   Natural Gas   Stainless Steel Finish   Standard Trim	<b>Change to LP Gas</b> Add (L) for LP/Propane Gas	<b>Add code below for desired color</b> Not available on Rangetop or Cooktop models	<b>Add (PLT) for Plated Trim</b> Includes plated bezels and logo. See available options below.

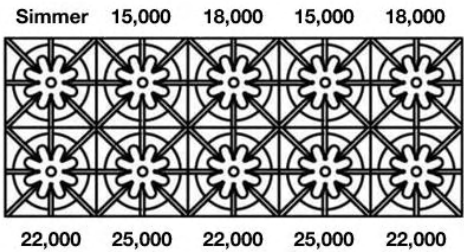

**FEATURES:**

- 25,000 BTU PrimaNova™ burners
- All burners, plus Interchangeable Griddle and Charbroiler accessory
- Precise 130° simmer burner
- Integrated wok cooking
- Handcrafted in Pennsylvania since 1880

**PRODUCT SPECIFICATIONS:**

- Unit Dimensions: 59.875"W x 24"D x 8.625"H
- Top Burner Power: 25,000 BTUs
- Simmer Burner: 9,000 BTUs
- Electrical Reqs: 120V, 60Hz, 15 AMPS, 1PH
- Gas Pressure: NAT: 5.0" WC, LP 10.0" WC
- Gas Line Size: 3/4"
- Unit Weight: 410 lbs.

Model	Description (* Denotes item that must be specified)	UMRP	MSRP
<b>Natural Gas Models: 60" Platinum Series Rangetop</b>			
BSPRT6010B	10 Burners   Nat Gas   Stainless Steel   Std Trim	\$ 10,895	\$ 12,530
BSPRT6010BPLT	10 Burners   Nat Gas   Stainless Steel   Plated Trim*	\$ 12,570	\$ 14,455
<b>LP/Propane Models: 60" Platinum Series Rangetop</b>			
BSPRT6010BL	10 Burners   LP Gas   Stainless Steel   Std Trim	\$ 10,895	\$ 12,530
BSPRT6010BLPLT	10 Burners   LP Gas   Stainless Steel   Plated Trim*	\$ 12,570	\$ 14,455
<b>BACKGUARD OPTIONS:</b>			
<b>All BlueStar freestanding appliances must be installed with a UL approved backguard. All units ship standard with a UL approved Island Trim unless otherwise specified.</b>			
BG660BSP	6" Backguard	\$ 1,390	\$ 1,600
BG6017BSP	17" Backguard	\$ 2,255	\$ 2,595
SDHS60BSP	24" High Shelf	\$ 2,635	\$ 3,030
<b>KNOB OPTIONS: (Total Knobs: 10)</b>			
KN-BLK	Standard Black Knob (Ordered with unit)	N/C	N/C
KN-C	Knob: Standard 190 RAL Color	\$ 115 ea	\$ 130 ea
BZ-C	Bezel: Standard 190 RAL Color	\$ 65 ea	\$ 75 ea
KN-CF	Knob: Spec Finish (Matte RAL, Textured RAL or Prec Metals)	\$ 185 ea	\$ 215 ea
KN-PLT	Knob: Plated Trim (See options below)	\$ 250 ea	\$ 290 ea
<b>PLATED TRIM OPTIONS: (Includes bezels and logo)</b>			
Antique Brass, Brushed Brass, Polished Brass, Antique Copper, Brushed Copper, Polished Copper, Chrome, Oil Rubbed Bronze & Pewter			
See page 52 for additional customization and accessories for Rangetops and Cooktops			

## RANGETOPS: 48" PLATINUM SERIES

### BlueStar Model Number Guide:

<b>Base Model (BSPRT488B)</b> 8 Burners   Natural Gas   Stainless Steel Finish   Standard Trim	<b>Change to LP Gas</b> Add (L) for LP/Propane Gas	<b>Add code below for desired color</b> Not available on Rangetop or Cooktop models	<b>Add (PLT) for Plated Trim</b> Includes plated bezels and logo. See available options below.
---------------------------------------------------------------------------------------------------	-------------------------------------------------------	----------------------------------------------------------------------------------------	---------------------------------------------------------------------------------------------------

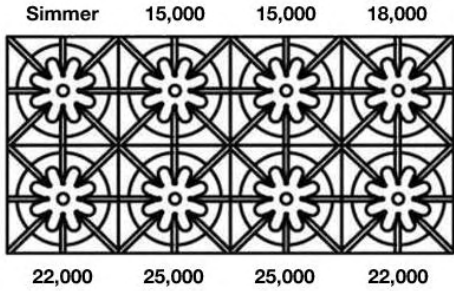

#### FEATURES:

- 25,000 BTU PrimaNova™ burners
- All burners, plus Interchangeable Griddle and Charbroiler accessory
- Precise 130° simmer burner
- Integrated wok cooking
- Handcrafted in Pennsylvania since 1880

#### PRODUCT SPECIFICATIONS:

- Unit Dimensions: 47.875"W x 24"D x 8.625"H
- Top Burner Power: 25,000 BTUs
- Simmer Burner: 9,000 BTUs
- Electrical Reqs: 120V, 60Hz, 15 AMPS, 1PH
- Gas Pressure: NAT: 5.0" WC, LP 10.0" WC
- Gas Line Size: 3/4"
- Unit Weight: 345 lbs.

Model	Description (* Denotes item that must be specified)	UMRP	MSRP
<b>Natural Gas Models: 48" Platinum Series Rangetop</b>			
BSPRT488B	8 Burners   Nat Gas   Stainless Steel   Std Trim	\$ 7,595	\$ 8,735
BSPRT488BPLT	8 Burners   Nat Gas   Stainless Steel   Plated Trim*	\$ 8,955	\$ 10,300
<b>LP/Propane Models: 48" Platinum Series Rangetop,</b>			
BSPRT488BL	8 Burners   LP Gas   Stainless Steel   Std Trim	\$ 7,595	\$ 8,735
BSPRT488BLPLT	8 Burners   LP Gas   Stainless Steel   Plated Trim*	\$ 8,955	\$ 10,300
<b>BACKGUARD OPTIONS:</b>			
<b>All BlueStar freestanding appliances must be installed with a UL approved backguard. All units ship standard with a UL approved Island Trim unless otherwise specified.</b>			
BG648BSP	6" Backguard	\$ 945	\$ 1,085
BG4817BSP	17" Backguard	\$ 1,980	\$ 2,275
SDHS48BSP	24" High Shelf	\$ 2,125	\$ 2,445
<b>KNOB OPTIONS: (Total Knobs: 8)</b>			
KN-BLK	Standard Black Knob (Ordered with unit)	N/C	N/C
KN-C	Knob: Standard 190 RAL Color	\$ 115 ea	\$ 130 ea
BZ-C	Bezel: Standard 190 RAL Color	\$ 65 ea	\$ 75 ea
KN-CF	Knob: Spec Finish (Matte RAL, Textured RAL or Prec Metals)	\$ 185 ea	\$ 215 ea
KN-PLT	Knob: Plated Trim (See options below)	\$ 250 ea	\$ 290 ea
<b>PLATED TRIM OPTIONS: (Includes bezels and logo)</b>			
Antique Brass, Brushed Brass, Polished Brass, Antique Copper, Brushed Copper, Polished Copper, Chrome, Oil Rubbed Bronze & Pewter			
See page 52 for additional customization and accessories for Rangetops and Cooktops			

## RANGETOPS: 36" PLATINUM SERIES

BlueStar Model Number Guide:			
<b>Base Model (BSPRT366B)</b> 6 Burners   Natural Gas   Stainless Steel Finish   Standard Trim	<b>Change to LP Gas</b> Add (L) for LP/Propane Gas	<b>Add code below for desired color</b> Not available on Rangetop or Cooktop models	<b>Add (PLT) for Plated Trim</b> Includes plated bezels and logo. See available options below.

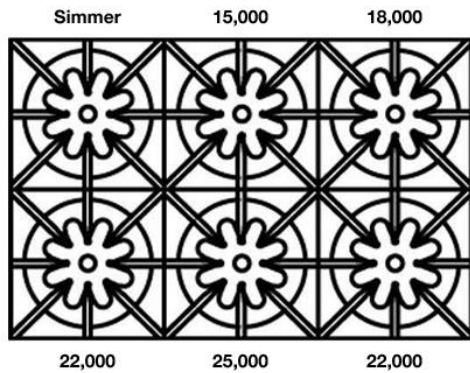

**FEATURES:**

- 25,000 BTU PrimaNova™ burners
- All burners, plus Interchangeable Griddle and Charbroiler accessory
- Precise 130° simmer burner
- Integrated wok cooking
- Handcrafted in Pennsylvania since 1880

**PRODUCT SPECIFICATIONS:**

- Unit Dimensions: 35.875"W x 24"D x 8.625"H
- Top Burner Power: 25,000 BTUs
- Simmer Burner: 9,000 BTUs
- Electrical Reqs: 120V, 60Hz, 15 AMPS, 1PH
- Gas Pressure: NAT: 5.0" WC, LP 10.0" WC
- Gas Line Size: ½"
- Unit Weight: 285 lbs.

Model	Description (* Denotes item that must be specified)	UMRP	MSRP
<b>Natural Gas Models: 36" Platinum Series Rangetop</b>			
BSPRT366B	6 Burners   Nat Gas   Stainless Steel   Std Trim	\$ 6,395	\$ 7,355
BSPRT366BPLT	6 Burners   Nat Gas   Stainless Steel   Plated Trim*	\$ 7,440	\$ 8,555
<b>LP/Propane Models: 36" Platinum Series Rangetop</b>			
BSPRT366BL	6 Burners   LP Gas   Stainless Steel   Std Trim	\$ 6,395	\$ 7,355
BSPRT366BLPLT	6 Burners   LP Gas   Stainless Steel   Plated Trim*	\$ 7,440	\$ 8,555
<b>BACKGUARD OPTIONS:</b>			
All BlueStar freestanding appliances must be installed with a UL approved backguard. All units ship standard with a UL approved Island Trim unless otherwise specified.			
BG636BSP	6" Backguard	\$ 655	\$ 755
BG3617BSP	17" Backguard	\$ 1,325	\$ 1,525
SDHS36BSP	24" High Shelf	\$ 1,535	\$ 1,765
<b>KNOB OPTIONS: (Total Knobs: 6)</b>			
KN-BLK	Standard Black Knob (Ordered with unit)	N/C	N/C
KN-C	Knob: Standard 190 RAL Color	\$ 115 ea	\$ 130 ea
BZ-C	Bezel: Standard 190 RAL Color	\$ 65 ea	\$ 75 ea
KN-CF	Knob: Spec Finish (Matte RAL, Textured RAL or Prec Metals)	\$ 185 ea	\$ 215 ea
KN-PLT	Knob: Plated Trim (See options below)	\$ 250 ea	\$ 290 ea
<b>PLATED TRIM OPTIONS: (Includes bezels and logo)</b>			
Antique Brass, Brushed Brass, Polished Brass, Antique Copper, Brushed Copper, Polished Copper, Chrome, Oil Rubbed Bronze & Pewter			
See page 52 for additional customization and accessories for Rangetops and Cooktops			

## RANGETOPS: 30" PLATINUM SERIES

### BlueStar Model Number Guide:

<b>Base Model (BSPRT304B)</b> 4 Burners   Natural Gas   Stainless Steel Finish   Standard Trim	<b>Change to LP Gas</b> Add (L) for LP/Propane Gas	<b>Add code below for desired color</b> Not available on Rangetop or Cooktop models	<b>Add (PLT) for Plated Trim</b> Includes plated bezels and logo. See available options below.
---------------------------------------------------------------------------------------------------	-------------------------------------------------------	----------------------------------------------------------------------------------------	---------------------------------------------------------------------------------------------------

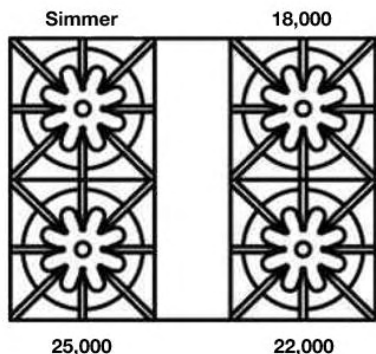

#### FEATURES:

- 25,000 BTU PrimaNova™ burners
- All burners, plus Interchangeable Griddle and Charbroiler accessory
- Precise 130° simmer burner
- Integrated wok cooking
- Handcrafted in Pennsylvania since 1880

#### PRODUCT SPECIFICATIONS:

- Unit Dimensions: 29.875"W x 24"D x 8.625"H
- Top Burner Power: 25,000 BTUs
- Simmer Burner: 9,000 BTUs
- Electrical Reqs: 120V, 60Hz, 15 AMPS, 1PH
- Gas Pressure: NAT: 5.0" WC, LP 10.0" WC
- Gas Line Size: ½"
- Unit Weight: 235 lbs.

Model	Description (* Denotes item that must be specified)	UMRP	MSRP
<b>Natural Gas Models: 30" Platinum Series Rangetop</b>			
BSPRT304B	4 Burners   Nat Gas   Stainless Steel   Std Trim	\$ 5,795	\$ 6,665
BSPRT304BPLT	4 Burners   Nat Gas   Stainless Steel   Plated Trim*	\$ 6,525	\$ 7,505
<b>LP/Propane Models: 30" Platinum Series Rangetop</b>			
BSPRT304BL	4 Burners   LP Gas   Stainless Steel   Std Trim	\$ 5,795	\$ 6,665
BSPRT304BLPLT	4 Burners   LP Gas   Stainless Steel   Plated Trim*	\$ 6,525	\$ 7,505
<b>BACKGUARD OPTIONS:</b>			
<b>All BlueStar freestanding appliances must be installed with a UL approved backguard. All units ship standard with a UL approved Island Trim unless otherwise specified.</b>			
BG630BSP	6" Backguard	\$ 655	\$ 755
BG3017BSP	17" Backguard	\$ 1,325	\$ 1,525
SDHS30BSP	24" High Shelf	\$ 1,535	\$ 1,765
<b>KNOB OPTIONS: (Total Knobs: 4)</b>			
KN-BLK	Standard Black Knob (Ordered with unit)	N/C	N/C
KN-C	Knob: Standard 190 RAL Color	\$ 115 ea	\$ 130 ea
BZ-C	Bezel: Standard 190 RAL Color	\$ 65 ea	\$ 75 ea
KN-CF	Knob: Spec Finish (Matte RAL, Textured RAL or Prec Metals)	\$ 185 ea	\$ 215 ea
KN-PLT	Knob: Plated Trim (See options below)	\$ 250 ea	\$ 290 ea
<b>PLATED TRIM OPTIONS: (Includes bezels and logo)</b>			
Antique Brass, Brushed Brass, Polished Brass, Antique Copper, Brushed Copper, Polished Copper, Chrome, Oil Rubbed Bronze & Pewter			
See page 52 for additional customization and accessories for Rangetops and Cooktops			

## RANGETOPS: 24" PLATINUM SERIES

BlueStar Model Number Guide:			
<b>Base Model (BSPRT244B)</b> 4 Burners   Natural Gas   Stainless Steel Finish   Standard Trim	<b>Change to LP Gas</b> Add (L) for LP/Propane Gas	<b>Add code below for desired color</b> Not available on Rangetop or Cooktop models	<b>Add (PLT) for Plated Trim</b> Includes plated bezels and logo. See available options below.



Model	Description (* Denotes item that must be specified)	UMRP	MSRP
<b>Natural Gas Models: 24" Platinum Series Rangetop</b>			
BSPRT244B	4 Burners   Nat Gas   Stainless Steel   Std Trim	\$ 5,495	\$ 6,320
BSPRT244BPLT	4 Burners   Nat Gas   Stainless Steel   Plated Trim*	\$ 6,225	\$ 7,160
<b>LP/Propane Models: 24" Platinum Series Rangetop</b>			
BSPRT244BL	4 Burners   LP Gas   Stainless Steel   Std Trim	\$ 5,495	\$ 6,320
BSPRT244BLPLT	4 Burners   LP Gas   Stainless Steel   Plated Trim*	\$ 6,225	\$ 7,160
<b>BACKGUARD OPTIONS:</b>			
All BlueStar freestanding appliances must be installed with a UL approved backguard. All units ship standard with a UL approved Island Trim unless otherwise specified.			
BG624BSP	6" Backguard	\$ 550	\$ 635
BG2417BSP	17" Backguard	\$ 1,020	\$ 1,175
SDHS24BSP	24" High Shelf	\$ 1,325	\$ 1,525
<b>KNOB OPTIONS: (Total Knobs: 4)</b>			
KN-BLK	Standard Black Knob (Ordered with unit)	N/C	N/C
KN-C	Knob: Standard 190 RAL Color	\$ 115 ea	\$ 130 ea
BZ-C	Bezel: Standard 190 RAL Color	\$ 65 ea	\$ 75 ea
KN-CF	Knob: Spec Finish (Matte RAL, Textured RAL or Prec Metals)	\$ 185 ea	\$ 215 ea
KN-PLT	Knob: Plated Trim (See options below)	\$ 250 ea	\$ 290 ea
<b>PLATED TRIM OPTIONS: (Includes bezels and logo)</b>			
Antique Brass, Brushed Brass, Polished Brass, Antique Copper, Brushed Copper, Polished Copper, Chrome, Oil Rubbed Bronze & Pewter			
See page 52 for additional customization and accessories for Rangetops and Cooktops			

**FEATURES:**

- 25,000 BTU PrimaNova™ burners
- All burners, plus Interchangeable Griddle and Charbroiler accessory
- Precise 130° simmer burner
- Integrated wok cooking
- Handcrafted in Pennsylvania since 1880

**PRODUCT SPECIFICATIONS:**

- Unit Dimensions: 23.875"W x 24"D x 8.625"H
- Top Burner Power: 25,000 BTUs
- Simmer Burner: 9,000 BTUs
- Electrical Reqs: 120V, 60Hz, 15 AMPS, 1PH
- Gas Pressure: NAT: 5.0" WC, LP 10.0" WC
- Gas Line Size: ½"
- Unit Weight: 220 lbs.

## RANGETOPS: 60" NOVA (RNB) SERIES

<b>BlueStar Model Number Guide:</b>			
<b>Base Model (RGTNB6010BV2)</b> 10 Burners   Natural Gas   Stainless Steel Finish   Standard Trim	<b>Change to LP Gas</b> Add (L) for LP/Propane Gas	<b>Add code below for desired color</b> Not available on Rangetop or Cooktop models	<b>Add (PLT) for Plated Trim</b> Includes plated bezels and logo. See available options below.

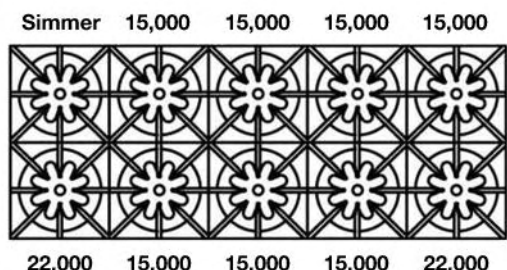

**FEATURES:**

- 22,000 BTU UltraNova™ burners & 15,000 BTU Nova™ burners
- Precise 130° simmer burner
- Available with all burners or add integrated griddle, charbroiler or French top
- Integrated wok cooking
- Handcrafted in Pennsylvania since 1880

**PRODUCT SPECIFICATIONS:**

- Unit Dimensions: 59.875"W x 24"D x 8.625"H
- Top Burner Power: 22,000 BTUs
- Simmer Burner: 9,000 BTUs
- Electrical Reqs: 120V, 60Hz, 15 AMPS, 1PH
- Gas Pressure: NAT: 5.0" WC, LP 10.0" WC
- Gas Line Size: 3/4"
- Unit Weight: 330 lbs.

Model	Description (* Denotes item that must be specified)	UMRP	MSRP
<b>Natural Gas Models: 60" Nova Series Rangetop</b>			
RGTNB6010BV2	10 Burners   Nat Gas   Stainless Steel   Std Trim	\$ 10,195	\$ 11,725
RGTNB6010BV2PLT	10 Burners   Nat Gas   Stainless Steel   Plated Trim*	\$ 11,870	\$ 13,650
<b>LP/Propane Models: 60" Nova Series Rangetop</b>			
RGTNB6010BV2L	10 Burners   LP Gas   Stainless Steel   Std Trim	\$ 10,195	\$ 11,725
RGTNB6010BV2LPLT	10 Burners   LP Gas   Stainless Steel   Plated Trim*	\$ 11,870	\$ 13,650
<b>BACKGUARD OPTIONS:</b>			
<b>All BlueStar freestanding appliances must be installed with a UL approved backguard. All units ship standard with a UL approved Island Trim unless otherwise specified.</b>			
BG660BSP	6" Backguard	\$ 1,390	\$ 1,600
BG6017BSP	17" Backguard	\$ 2,255	\$ 2,595
SDHS60BSP	24" High Shelf	\$ 2,635	\$ 3,030
<b>KNOB OPTIONS: (Total Knobs: 10)</b>			
KN-BLK	Standard Black Knob (Ordered with unit)	N/C	N/C
KN-C	Knob: Standard 190 RAL Color	\$ 115 ea	\$ 130 ea
BZ-C	Bezel: Standard 190 RAL Color	\$ 65 ea	\$ 75 ea
KN-CF	Knob: Spec Finish (Matte RAL, Textured RAL or Prec Metals)	\$ 185 ea	\$ 215 ea
KN-PLT	Knob: Plated Trim (See options below)	\$ 250 ea	\$ 290 ea
<b>PLATED TRIM OPTIONS: (Includes bezels and logo)</b>			
Antique Brass, Brushed Brass, Polished Brass, Antique Copper, Brushed Copper, Polished Copper, Chrome, Oil Rubbed Bronze & Pewter			
See page 52 for additional customization and accessories for Rangetops and Cooktops			

## RANGETOPS: 60" NOVA (RNB) SERIES

**60" Nova (RNB) Rangetop  
with 12" Griddle**

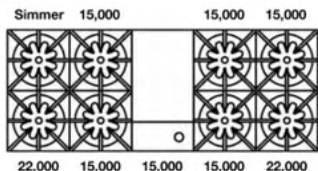

Model	Description (* Denotes item that must be specified)	UMRP	MSRP
<b>Natural Gas Models: 60" Nova Series Rangetop</b>			
RGTNB608GV2	8 Burner   12" Griddle   Nat Gas   Stainless Steel   Standard Trim	\$ 9,895	\$ 11,380
RGTNB608GV2PLT	8 Burner   12" Griddle   Nat Gas   Stainless Steel   Plated Trim*	\$ 11,570	\$ 13,305
<b>LP/Propane Models: 60" Nova Series Rangetop</b>			
RGTNB608GV2L	8 Burner   12" Griddle   LP Gas   Stainless Steel   Standard Trim	\$ 9,895	\$ 11,380
RGTNB608GV2LPLT	8 Burner   12" Griddle   LP Gas   Stainless Steel   Plated Trim*	\$ 11,570	\$ 13,305
<b>Customization &amp; Accessory Options: (See page 47)   Total Knobs: 9</b>			

**60" Nova (RNB) Rangetop  
with 12" Charbroiler**

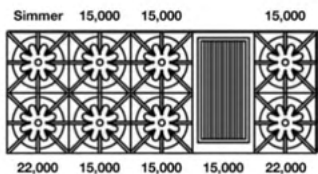

<b>Natural Gas Models: 60" Nova Series Rangetop with 12" Charbroiler</b>			
RGTNB608CBV2	8 Burner   12" Charbroiler   Nat Gas   Stainless Steel   Standard Trim	\$ 9,895	\$ 11,380
RGTNB608CBV2PLT	8 Burner   12" Charbroiler   Nat Gas   Stainless Steel   Plated Trim*	\$ 11,570	\$ 13,305
<b>LP/Propane Models: 60" Nova Series Rangetop with 12" Charbroiler</b>			
RGTNB608CBV2L	8 Burner   12" Charbroiler   LP Gas   Stainless Steel   Standard Trim	\$ 9,895	\$ 11,380
RGTNB608CBV2LPLT	8 Burner   12" Charbroiler   LP Gas   Stainless Steel   Plated Trim*	\$ 11,570	\$ 13,305
<b>Customization &amp; Accessory Options: (See page 47)   Total Knobs: 9</b>			

**60" Nova (RNB) Rangetop  
with 24" Griddle**

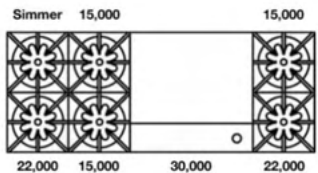

<b>Natural Gas Models: 60" Nova Series Rangetop with 24" Griddle</b>			
RGTNB606GV2	6 Burner   24" Griddle   Nat Gas   Stainless Steel   Standard Trim	\$ 10,195	\$ 11,725
RGTNB606GV2PLT	6 Burner   24" Griddle   Nat Gas   Stainless Steel   Plated Trim*	\$ 11,870	\$ 13,650
<b>LP/Propane Models: 60" Nova Series Rangetop with 24" Griddle</b>			
RGTNB606GV2L	6 Burner   24" Griddle   LP Gas   Stainless Steel   Standard Trim	\$ 10,195	\$ 11,725
RGTNB606GV2LPLT	6 Burner   24" Griddle   LP Gas   Stainless Steel   Plated Trim*	\$ 11,870	\$ 13,650
<b>Customization &amp; Accessory Options: (See page 47)   Total Knobs: 8</b>			

## RANGETOPS: 60" NOVA (RNB) SERIES

**60" Nova (RNB) Rangetop  
with 24" Charbroiler**

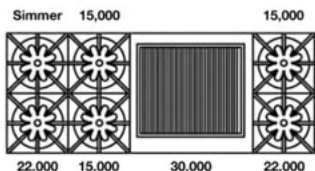

Model	Description (* Denotes item that must be specified)	UMRP	MSRP
<b>Natural Gas Models: 60" Nova Series Rangetop with 24" Charbroiler</b>			
RGTNB606CBV2	6 Burner   12" Charbroiler   Nat Gas   Stainless Steel   Standard Trim	\$ 10,195	\$ 11,725
RGTNB606CBV2PLT	6 Burner   12" Charbroiler   Nat Gas   Stainless Steel   Plated Trim*	\$ 11,870	\$ 13,650
<b>LP/Propane Models: 60" Nova Series Rangetop</b>			
RGTNB606CBV2L	6 Burner   12" Charbroiler   LP Gas   Stainless Steel   Standard Trim	\$ 10,195	\$ 11,725
RGTNB606CBV2LPLT	6 Burner   12" Charbroiler   LP Gas   Stainless Steel   Plated Trim*	\$ 11,870	\$ 13,650
<b>Customization &amp; Accessory Options: (See page 47)   Total Knobs: 8</b>			

**60" Nova (RNB) Rangetop  
with 12" Griddle & Charbroiler**

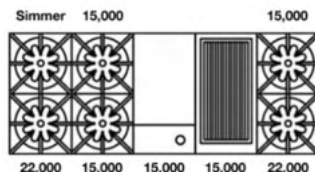

<b>Natural Gas Models: 60" Nova Series Rangetop with 12" Griddle &amp; Charbroiler</b>			
RGTNB4606GCBV2	6 Burner   12" Griddle & Char Br.   Nat Gas   Stainless Steel   Standard Trim	\$ 10,695	\$ 12,300
RGTNB606GCBV2PLT	6 Burner   12" Griddle & Char Br.   Nat Gas   Stainless Steel   Plated Trim*	\$ 12,370	\$ 14,225
<b>LP/Propane Models: 60" Nova Series Rangetop with 12" Griddle &amp; Charbroiler</b>			
RGTNB606GCBV2L	6 Burner   12" Griddle & Char Br.   LP Gas   Stainless Steel   Standard Trim	\$ 10,695	\$ 12,300
RGTNB606GCBV2LPLT	6 Burner   12" Griddle & Char Br.   LP Gas   Stainless Steel   Plated Trim*	\$ 12,370	\$ 14,225
<b>Customization &amp; Accessory Options: (See page 47)   Total Knobs: 8</b>			

**60" Nova (RNB) Rangetop  
with 24" French Top**

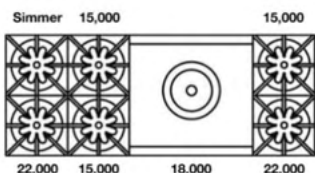

<b>Natural Gas Models: 60" Nova Series Rangetop with 24" French Top</b>			
RGTNB606FTV2	6 Burner   24" French Top   Nat Gas   Stainless Steel   Standard Trim	\$ 10,995	\$ 12,645
RGTNB606FTV2PLT	6 Burner   24" French Top   Nat Gas   Stainless Steel   Plated Trim*	\$ 12,670	\$ 14,570
<b>LP/Propane Models: 60" Nova Series Rangetop with 24" French Top</b>			
RGTNB606FTV2L	6 Burner   24" French Top   LP Gas   Stainless Steel   Standard Trim	\$ 10,995	\$ 12,645
RGTNB606FTV2LPLT	6 Burner   24" French Top   LP Gas   Stainless Steel   Plated Trim*	\$ 12,670	\$ 14,570
<b>Customization &amp; Accessory Options: (See page 47)   Total Knobs: 7</b>			

## RANGETOPS: 48" NOVA (RNB) SERIES

BlueStar Model Number Guide:			
<b>Base Model (RGTNB488BV2)</b> 8 Burners   Natural Gas   Stainless Steel Finish   Standard Trim	<b>Change to LP Gas</b> Add (L) for LP/Propane Gas	<b>Add code below for desired color</b> Not available on Rangetop or Cooktop models	<b>Add (PLT) for Plated Trim</b> Includes plated bezels and logo. See available options below.

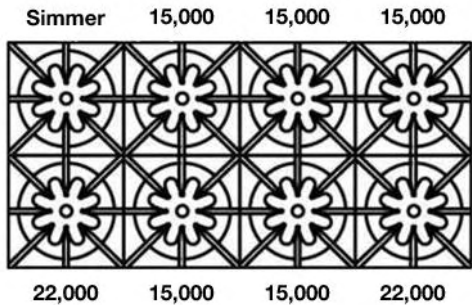

### FEATURES:

- 22,000 BTU UltraNova™ burners & 15,000 BTU Nova™ burners
- Precise 130° simmer burner
- Available with all burners or add integrated griddle, charbroiler or French top
- Integrated wok cooking
- Handcrafted in Pennsylvania since 1880

### PRODUCT SPECIFICATIONS:

- Unit Dimensions: 47.875"W x 24"D x 8.625"H
- Top Burner Power: 22,000 BTUs
- Simmer Burner: 9,000 BTUs
- Electrical Reqs: 120V, 60Hz, 15 AMPS, 1PH
- Gas Pressure: NAT: 5.0" WC, LP 10.0" WC
- Gas Line Size: 3/4"
- Unit Weight: 295 lbs.

Model	Description (* Denotes item that must be specified)	UMRP	MSRP
<b>Natural Gas Models: 48" Nova Series Rangetop</b>			
RGTNB488BV2	8 Burners   Nat Gas   Stainless Steel   Std Trim	\$ 6,395	\$ 7,355
RGTNB488BV2PLT	8 Burners   Nat Gas   Stainless Steel   Plated Trim*	\$ 7,755	\$ 8,920
<b>LP/Propane Models: 48" Nova Series Rangetop</b>			
RGTNB488BV2L	8 Burners   LP Gas   Stainless Steel   Std Trim	\$ 6,395	\$ 7,355
RGTNB488BV2LPLT	8 Burners   LP Gas   Stainless Steel   Plated Trim*	\$ 7,755	\$ 8,920
<b>BACKGUARD OPTIONS:</b>			
All BlueStar freestanding appliances must be installed with a UL approved backguard. All units ship standard with a UL approved Island Trim unless otherwise specified.			
BG648BSP	6" Backguard	\$ 945	\$ 1,085
BG4817BSP	17" Backguard	\$ 1,980	\$ 2,275
SDHS48BSP	24" High Shelf	\$ 2,125	\$ 2,445
<b>KNOB OPTIONS: (Total Knobs: 8)</b>			
KN-BLK	Standard Black Knob (Ordered with unit)	N/C	N/C
KN-C	Knob: Standard 190 RAL Color	\$ 115 ea	\$ 130 ea
BZ-C	Bezel: Standard 190 RAL Color	\$ 65 ea	\$ 75 ea
KN-CF	Knob: Spec Finish (Matte RAL, Textured RAL or Prec Metals)	\$ 185 ea	\$ 215 ea
KN-PLT	Knob: Plated Trim (See options below)	\$ 250 ea	\$ 290 ea
<b>PLATED TRIM OPTIONS: (Includes bezels and logo)</b>			
Antique Brass, Brushed Brass, Polished Brass, Antique Copper, Brushed Copper, Polished Copper, Chrome, Oil Rubbed Bronze & Pewter			
See page 52 for additional customization and accessories for Rangetops and Cooktops			

## RANGETOPS: 48" NOVA (RNB) SERIES

**48" Nova (RNB) Rangetop  
with 12" Griddle**

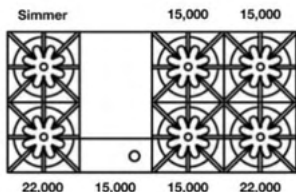

Model	Description (* Denotes item that must be specified)	UMRP	MSRP
<b>Natural Gas Models: 48" Nova Series Rangetop with 12" Griddle</b>			
RGTNB486GV2	4 Burner   12" Griddle   Nat Gas   Stainless Steel   Standard Trim	\$ 6,595	\$ 7,585
RGTNB486GV2PLT	4 Burner   12" Griddle   Nat Gas   Stainless Steel   Plated Trim*	\$ 7,955	\$ 9,150
<b>LP/Propane Models: 48" Nova Series Rangetop with 12" Griddle</b>			
RGTNB486GV2L	4 Burner   12" Griddle   LP Gas   Stainless Steel   Standard Trim	\$ 6,595	\$ 7,585
RGTNB486GV2LPLT	4 Burner   12" Griddle   LP Gas   Stainless Steel   Plated Trim*	\$ 7,955	\$ 9,150
<b>Customization &amp; Accessory Options: (See page 44)   Total Knobs: 7</b>			

**48" Nova (RNB) Rangetop  
with 12" Charbroiler**

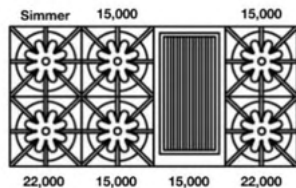

<b>Natural Gas Models: 48" Nova Series Rangetop with 12" Charbroiler</b>			
RGTNB486CBV2	4 Burner   12" Charbroiler   Nat Gas   Stainless Steel   Standard Trim	\$ 6,595	\$ 7,585
RGTNB486CBV2PLT	4 Burner   12" Charbroiler   Nat Gas   Stainless Steel   Plated Trim*	\$ 7,955	\$ 9,150
<b>LP/Propane Models: 48" Nova Series Rangetop with 12" Charbroiler</b>			
RGTNB486CBV2L	4 Burner   12" Charbroiler   LP Gas   Stainless Steel   Standard Trim	\$ 6,595	\$ 7,585
RGTNB486CBV2LPLT	4 Burner   12" Charbroiler   LP Gas   Stainless Steel   Plated Trim*	\$ 7,955	\$ 9,150
<b>Customization &amp; Accessory Options: (See page 44)   Total Knobs: 7</b>			

**48" Nova (RNB) Rangetop  
with 24" Griddle**

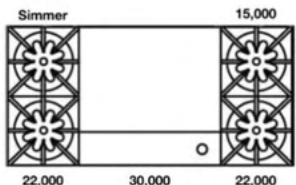

<b>Natural Gas Models: 48" Nova Series Rangetop with 24" Griddle</b>			
RGTNB484GV2	4 Burner   24" Griddle   Nat Gas   Stainless Steel   Standard Trim	\$ 7,195	\$ 8,275
RGTNB484GV2PLT	4 Burner   24" Griddle   Nat Gas   Stainless Steel   Plated Trim*	\$ 8,555	\$ 9,840
<b>LP/Propane Models: 48" Nova Series Rangetop with 24" Griddle</b>			
RGTNB484GV2L	4 Burner   24" Griddle   LP Gas   Stainless Steel   Standard Trim	\$ 7,195	\$ 8,275
RGTNB484GV2LPLT	4 Burner   24" Griddle   LP Gas   Stainless Steel   Plated Trim*	\$ 8,555	\$ 9,840
<b>Customization &amp; Accessory Options: (See page 44)   Total Knobs: 6</b>			

## RANGETOPS: 48" NOVA (RNB) SERIES

### 48" Nova (RNB) Rangetop with 24" Charbroiler

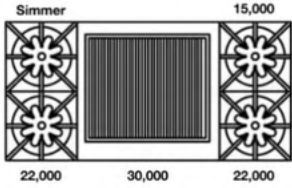

Model	Description (* Denotes item that must be specified)	UMRP	MSRP
<b>Natural Gas Models: 48" Nova Series Rangetop with 24" Charbroiler</b>			
RGTNB484CBV2	4 Burner   24" Charbroiler   Nat Gas   Stainless Steel   Standard Trim	\$ 7,195	\$ 8,275
RGTNB484CBV2PLT	4 Burner   24" Charbroiler   Nat Gas   Stainless Steel   Plated Trim*	\$ 8,555	\$ 9,840
<b>LP/Propane Models: 48" Nova Series Rangetop with 24" Charbroiler</b>			
RGTNB484CBV2L	4 Burner   24" Charbroiler   LP Gas   Stainless Steel   Standard Trim	\$ 7,195	\$ 8,275
RGTNB484CBV2LPLT	4 Burner   24" Charbroiler   LP Gas   Stainless Steel   Plated Trim*	\$ 8,555	\$ 9,840
<b>Customization &amp; Accessory Options: (See page 44)   Total Knobs: 6</b>			

### 48" Nova (RNB) Rangetop with 12" Griddle & Charbroiler

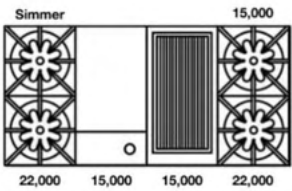

<b>Natural Gas Models: 48" Nova Series Rangetop with 12" Griddle &amp; Charbroiler</b>			
RGTNB484GCBV2	4 Burner   12" Griddle & Char Br.   Nat Gas   Stainless Steel   Standard Trim	\$ 7,395	\$ 8,505
RGTNB484GCBV2PLT	4 Burner   12" Griddle & Char Br.   Nat Gas   Stainless Steel   Plated Trim*	\$ 8,755	\$ 10,070
<b>LP/Propane Models: 48" Nova Series Rangetop with 12" Griddle &amp; Charbroiler</b>			
RGTNB484GCBV2L	4 Burner   12" Griddle & Char Br.   LP Gas   Stainless Steel   Standard Trim	\$ 7,395	\$ 8,505
RGTNB484GCBV2LPLT	4 Burner   12" Griddle & Char Br.   LP Gas   Stainless Steel   Plated Trim*	\$ 8,755	\$ 10,070
<b>Customization &amp; Accessory Options: (See page 44)   Total Knobs: 6</b>			

### 48" Nova (RNB) Rangetop with 24" French Top

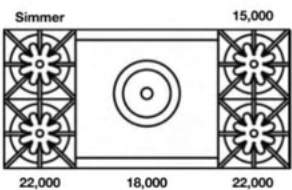

<b>Natural Gas Models: 48" Nova Series Rangetop with 24" French Top</b>			
RGTNB484FTV2	4 Burner   24" French Top   Nat Gas   Stainless Steel   Standard Trim	\$ 7,925	\$ 9,115
RGTNB484FTV2PLT	4 Burner   24" French Top   Nat Gas   Stainless Steel   Plated Trim*	\$ 9,285	\$ 10,680
<b>LP/Propane Models: 48" Nova Series Rangetop with 24" French Top</b>			
RGTNB484FTV2L	4 Burner   24" French Top   LP Gas   Stainless Steel   Standard Trim	\$ 7,925	\$ 9,115
RGTNB484FTV2LPLT	4 Burner   24" French Top   LP Gas   Stainless Steel   Plated Trim*	\$ 9,285	\$ 10,680
<b>Customization &amp; Accessory Options: (See page 44)   Total Knobs: 5</b>			

## RANGETOPS: 36" NOVA (RNB) SERIES

<b>BlueStar Model Number Guide:</b>			
<b>Base Model (RGTNB366BV2)</b> 6 Burners   Natural Gas   Stainless Steel Finish   Standard Trim	<b>Change to LP Gas</b> Add (L) for LP/Propane Gas	<b>Add code below for desired color</b> Not available on Rangetop or Cooktop models	<b>Add (PLT) for Plated Trim</b> Includes plated bezels and logo. See available options below.

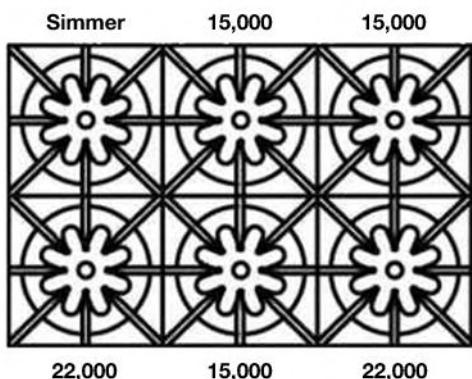

**FEATURES:**

- 22,000 BTU UltraNova™ burners & 15,000 BTU Nova™ burners
- Precise 130° simmer burner
- Available with all burners or add integrated griddle, charbroiler or French top
- Integrated wok cooking
- Handcrafted in Pennsylvania since 1880

**PRODUCT SPECIFICATIONS:**

- Unit Dimensions: 35.875"W x 24"D x 8.625"H
- Top Burner Power: 22,000 BTUs
- Simmer Burner: 9,000 BTUs
- Electrical Reqs: 120V, 60Hz, 15 AMPS, 1PH
- Gas Pressure: NAT: 5.0" WC, LP 10.0" WC
- Gas Line Size: ½"
- Unit Weight: 220 lbs.

Model	Description (* Denotes item that must be specified)	UMRP	MSRP
<b>Natural Gas Models: 36" Nova Series Rangetop</b>			
RGTNB366BV2	6 Burners   Nat Gas   Stainless Steel   Std Trim	\$ 5,095	\$ 5,860
RGTNB366BV2PLT	6 Burners   Nat Gas   Stainless Steel   Plated Trim*	\$ 6,140	\$ 7,060
<b>LP/Propane Models: 36" Nova Series Rangetop</b>			
RGTNB366BV2L	6 Burners   LP Gas   Stainless Steel   Std Trim	\$ 5,095	\$ 5,860
RGTNB366BV2LPLT	6 Burners   LP Gas   Stainless Steel   Plated Trim*	\$ 6,140	\$ 7,060
<b>BACKGUARD OPTIONS:</b>			
<b>All BlueStar freestanding appliances must be installed with a UL approved backguard. All units ship standard with a UL approved Island Trim unless otherwise specified.</b>			
BG636BSP	6" Backguard	\$ 655	\$ 755
BG3617BSP	17" Backguard	\$ 1,325	\$ 1,525
SDHS36BSP	24" High Shelf	\$ 1,535	\$ 1,765
<b>KNOB OPTIONS: (Total Knobs: 6)</b>			
KN-BLK	Standard Black Knob (Ordered with unit)	N/C	N/C
KN-C	Knob: Standard 190 RAL Color	\$ 115 ea	\$ 130 ea
BZ-C	Bezel: Standard 190 RAL Color	\$ 65 ea	\$ 75 ea
KN-CF	Knob: Spec Finish (Matte RAL, Textured RAL or Prec Metals)	\$ 185 ea	\$ 215 ea
KN-PLT	Knob: Plated Trim (See options below)	\$ 250 ea	\$ 290 ea
<b>PLATED TRIM OPTIONS: (Includes bezels and logo)</b>			
Antique Brass, Brushed Brass, Polished Brass, Antique Copper, Brushed Copper, Polished Copper, Chrome, Oil Rubbed Bronze & Pewter			
See page 52 for additional customization and accessories for Rangetops and Cooktops			

## RANGETOPS: 36" NOVA (RNB) SERIES

**36" Nova (RNB) Rangetop  
with 12" Griddle**

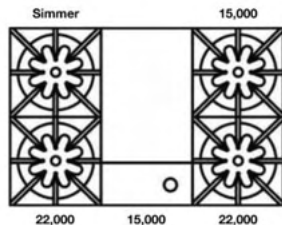

Model	Description (* Denotes item that must be specified)	UMRP	MSRP
<b>Natural Gas Models: 36" Nova Series Rangetop with 12" Griddle</b>			
RGTNB364GV2	4 Burner   12" Griddle   Nat Gas   Stainless Steel   Standard Trim	\$ 5,795	\$ 6,665
RGTNB364GV2PLT	4 Burner   12" Griddle   Nat Gas   Stainless Steel   Plated Trim*	\$ 6,840	\$ 7,865
<b>LP/Propane Models: 36" Nova Series Rangetop with 12" Griddle</b>			
RGTNB364GV2L	4 Burner   12" Griddle   LP Gas   Stainless Steel   Standard Trim	\$ 5,795	\$ 6,665
RGTNB364GV2LPLT	4 Burner   12" Griddle   LP Gas   Stainless Steel   Plated Trim*	\$ 6,840	\$ 7,865
<b>Customization &amp; Accessory Options: (See page 42)   Total Knobs: 5</b>			

**36" Nova (RNB) Rangetop  
with 12" Charbroiler**

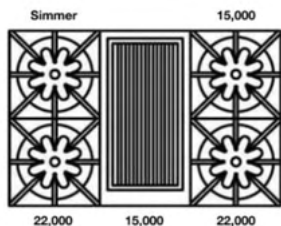

<b>Natural Gas Models: 36" Nova Series Rangetop with 12" Charbroiler</b>			
RGTNB364CBV2	4 Burner   12" Charbroiler   Nat Gas   Stainless Steel   Standard Trim	\$ 5,495	\$ 6,320
RGTNB364CBV2PLT	4 Burner   12" Charbroiler   Nat Gas   Stainless Steel   Plated Trim*	\$ 6,540	\$ 7,520
<b>LP/Propane Models: 36" Nova Series Rangetop with 12" Charbroiler</b>			
RGTNB364CBV2L	4 Burner   12" Charbroiler   LP Gas   Stainless Steel   Standard Trim	\$ 5,495	\$ 6,320
RGTNB364CBV2LPLT	4 Burner   12" Charbroiler   LP Gas   Stainless Steel   Plated Trim*	\$ 6,540	\$ 7,520
<b>Customization &amp; Accessory Options: (See page 42)   Total Knobs: 5</b>			

## RANGETOPS: 30" NOVA (RNB) SERIES

### BlueStar Model Number Guide:

<b>Base Model (RGTNB304BV2)</b> 4 Burners   Natural Gas   Stainless Steel Finish   Standard Trim	<b>Change to LP Gas</b> Add (L) for LP/Propane Gas	<b>Add code below for desired color</b> Not available on Rangetop or Cooktop models	<b>Add (PLT) for Plated Trim</b> Includes plated bezels and logo. See available options below.
-----------------------------------------------------------------------------------------------------	-------------------------------------------------------	----------------------------------------------------------------------------------------	---------------------------------------------------------------------------------------------------

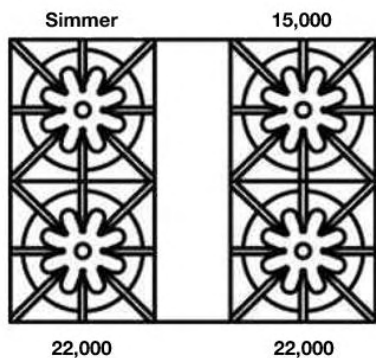

Model	Description (* Denotes item that must be specified)	UMRP	MSRP
<b>Natural Gas Models: 30" Nova Series Rangetop</b>			
RGTNB304BV2	4 Burners   Nat Gas   Stainless Steel   Std Trim	\$ 4,795	\$ 5,515
RGTNB304BV2PLT	4 Burners   Nat Gas   Stainless Steel   Plated Trim*	\$ 5,525	\$ 6,355
<b>LP/Propane Models: 30" Nova Series Rangetop</b>			
RGTNB304BV2L	4 Burners   LP Gas   Stainless Steel   Std Trim	\$ 4,795	\$ 5,515
RGTNB304BV2LPLT	4 Burners   LP Gas   Stainless Steel   Plated Trim*	\$ 5,525	\$ 6,355
<b>BACKGUARD OPTIONS:</b>			
<b>All BlueStar freestanding appliances must be installed with a UL approved backguard. All units ship standard with a UL approved Island Trim unless otherwise specified.</b>			
BG630BSP	6" Backguard	\$ 550	\$ 635
BG3017BSP	17" Backguard	\$ 1,020	\$ 1,175
SDHS30BSP	24" High Shelf	\$ 1,325	\$ 1,525
<b>KNOB OPTIONS: (Total Knobs: 4)</b>			
KN-BLK	Standard Black Knob (Ordered with unit)	N/C	N/C
KN-C	Knob: Standard 190 RAL Color	\$ 115 ea	\$ 130 ea
BZ-C	Bezel: Standard 190 RAL Color	\$ 65 ea	\$ 75 ea
KN-CF	Knob: Spec Finish (Matte RAL, Textured RAL or Prec Metals)	\$ 185 ea	\$ 215 ea
KN-PLT	Knob: Plated Trim (See options below)	\$ 250 ea	\$ 290 ea
<b>PLATED TRIM OPTIONS: (Includes bezels and logo)</b>			
Antique Brass, Brushed Brass, Polished Brass, Antique Copper, Brushed Copper, Polished Copper, Chrome, Oil Rubbed Bronze & Pewter			
See page 52 for additional customization and accessories for Rangetops and Cooktops			

### FEATURES:

- 22,000 BTU UltraNova™ burners & 15,000 BTU Nova™ burners
- Precise 130° simmer burner
- Integrated wok cooking
- Handcrafted in Pennsylvania since 1880

### PRODUCT SPECIFICATIONS:

- Unit Dimensions: 29.875"W x 24"D x 8.625"H
- Top Burner Power: 22,000 BTUs
- Simmer Burner: 9,000 BTUs
- Electrical Reqs: 120V, 60Hz, 15 AMPS, 1PH
- Gas Pressure: NAT: 5.0" WC, LP 10.0" WC
- Gas Line Size: ½"
- Unit Weight: 200 lbs.

## RANGETOPS: 24" NOVA (RNB) SERIES

### BlueStar Model Number Guide:

<b>Base Model (RGTNB244BV2)</b> 4 Burners   Natural Gas   Stainless Steel Finish   Standard Trim	<b>Change to LP Gas</b> Add (L) for LP/Propane Gas	<b>Add code below for desired color</b> Not available on Rangetop or Cooktop models	<b>Add (PLT) for Plated Trim</b> Includes plated bezels and logo. See available options below.
-----------------------------------------------------------------------------------------------------	-------------------------------------------------------	----------------------------------------------------------------------------------------	---------------------------------------------------------------------------------------------------



Model	Description (* Denotes item that must be specified)	UMRP	MSRP
<b>Natural Gas Models: 24" Nova Series Rangetop</b>			
RGTNB244BV2	4 Burners   Nat Gas   Stainless Steel   Std Trim	\$ 4,695	\$ 5,400
RGTNB244BV2PLT	4 Burners   Nat Gas   Stainless Steel   Plated Trim*	\$ 5,425	\$ 6,240
<b>LP/Propane Models: 24" Nova Series Rangetop</b>			
RGTNB244BV2L	4 Burners   LP Gas   Stainless Steel   Std Trim	\$ 4,695	\$ 5,400
RGTNB244BV2LPLT	4 Burners   LP Gas   Stainless Steel   Plated Trim*	\$ 5,425	\$ 6,240
<b>BACKGUARD OPTIONS:</b>			
<b>All BlueStar freestanding appliances must be installed with a UL approved backguard. All units ship standard with a UL approved Island Trim unless otherwise specified.</b>			
BG624BSP	6" Backguard	\$ 550	\$ 635
BG2417BSP	17" Backguard	\$ 1,020	\$ 1,175
SDHS24BSP	24" High Shelf	\$ 1,325	\$ 1,525
<b>KNOB OPTIONS: (Total Knobs: 4)</b>			
KN-BLK	Standard Black Knob (Ordered with unit)	N/C	N/C
KN-C	Knob: Standard 190 RAL Color	\$ 115 ea	\$ 130 ea
BZ-C	Bezel: Standard 190 RAL Color	\$ 65 ea	\$ 75 ea
KN-CF	Knob: Spec Finish (Matte RAL, Textured RAL or Prec Metals)	\$ 185 ea	\$ 215 ea
KN-PLT	Knob: Plated Trim (See options below)	\$ 250 ea	\$ 290 ea
<b>PLATED TRIM OPTIONS: (Includes bezels and logo)</b>			
Antique Brass, Brushed Brass, Polished Brass, Antique Copper, Brushed Copper, Polished Copper, Chrome, Oil Rubbed Bronze & Pewter			
See page 52 for additional customization and accessories for Rangetops and Cooktops			

#### FEATURES:

- 22,000 BTU UltraNova™ burners & 15,000 BTU Nova™ burners
- Precise 130° simmer burner
- Available with all burners or all integrated griddle, charbroiler or French top
- Integrated wok cooking
- Handcrafted in Pennsylvania since 1880

#### PRODUCT SPECIFICATIONS:

- Unit Dimensions: 23.875"W x 24"D x 8.625"H
- Top Burner Power: 22,000 BTUs
- Simmer Burner: 9,000 BTUs
- Electrical Reqs: 120V, 60Hz, 15 AMPS, 1PH
- Gas Pressure: NAT: 5.0" WC, LP 10.0" WC
- Gas Line Size: ½"
- Unit Weight: 185 lbs.

## RANGETOPS: 24" NOVA (RNB) SERIES

### 24" Nova (RNB) Rangetop All Griddle

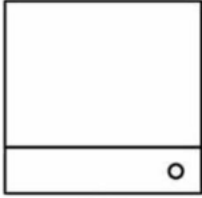

30,000

Model	Description (* Denotes item that must be specified)	UMRP	MSRP
<b>Natural Gas Models: 24" Nova Series Rangetop – All Griddle</b>			
RGTNB24GV2	24" Nova Series   24" Griddle   Nat Gas   Stainless Steel   Standard Trim	\$ 4,695	\$ 5,400
RGTNB24GV2PLT	24" Nova Series   24" Griddle   Nat Gas   Stainless Steel   Plated Trim*	\$ 5,425	\$ 6,240
<b>LP/Propane Models: 24" Nova Series Rangetop – All Griddle</b>			
RGTNB24GV2L	24" Nova Series   24" Griddle   LP Gas   Stainless Steel   Standard Trim	\$ 4,695	\$ 5,400
RGTNB24GV2LPLT	24" Nova Series   24" Griddle   LP Gas   Stainless Steel   Plated Trim*	\$ 5,425	\$ 6,240
<b>Customization &amp; Accessory Options: (See page 39)   Total Knobs: 2</b>			

### 24" Nova (RNB) Rangetop All Charbroiler

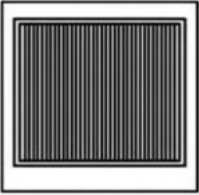

30,000

<b>Natural Gas Models: 24" Nova Series Rangetop – All Charbroiler</b>			
RGTNB24CBV2	24" Nova Series   24" Charbroiler   Nat Gas   Stainless Steel   Standard Trim	\$ 4,695	\$ 5,400
RGTNB24CBV2PLT	24" Nova Series   24" Charbroiler   Nat Gas   Stainless Steel   Plated Trim*	\$ 5,425	\$ 6,240
<b>LP/Propane Models: 24" Nova Series Rangetop – All Charbroiler</b>			
RGTNB24CBV2L	24" Nova Series   24" Charbroiler   LP Gas   Stainless Steel   Standard Trim	\$ 4,695	\$ 5,400
RGTNB24CBV2LPLT	24" Nova Series   24" Charbroiler   LP Gas   Stainless Steel   Plated Trim*	\$ 5,425	\$ 6,240
<b>Customization &amp; Accessory Options: (See page 39)   Total Knobs: 2</b>			

### 24" Nova (RNB) Rangetop All French Top

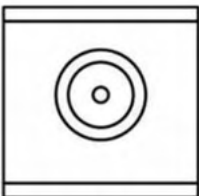

18,000

<b>Natural Gas Models: 24" Nova Series Rangetop – All French Top</b>			
RGTNB24FTV2	24" Nova Series   24" French Top   Nat Gas   Stainless Steel   Standard Trim	\$ 4,795	\$ 5,515
RGTNB24FTV2PLT	24" Nova Series   24" French Top   Nat Gas   Stainless Steel   Plated Trim*	\$ 5,525	\$ 6,355
<b>LP/Propane Models: 24" Nova Series Rangetop – All French Top</b>			
RGTNB24FTV2L	24" Nova Series   24" French Top   LP Gas   Stainless Steel   Standard Trim	\$ 4,795	\$ 5,515
RGTNB24FTV2LPLT	24" Nova Series   24" French Top   LP Gas   Stainless Steel   Plated Trim*	\$ 5,525	\$ 6,355
<b>Customization &amp; Accessory Options: (See page 39)   Total Knobs: 1</b>			

## DROP-IN COOKTOPS: 30" & 36" RBCT SERIES

### BlueStar Model Number Guide:

<b>Base Model (RBCT304BSSV2)</b> 4 Burners   Natural Gas   Stainless Steel Finish   Standard Trim	<b>Change to LP Gas</b> Add (L) for LP/Propane Gas	<b>Add code below for desired color</b> Not available on Rangetop or Cooktop models	<b>Add (PLT) for Plated Trim</b> Includes plated bezels and logo. See available options below.
------------------------------------------------------------------------------------------------------	-------------------------------------------------------	----------------------------------------------------------------------------------------	---------------------------------------------------------------------------------------------------

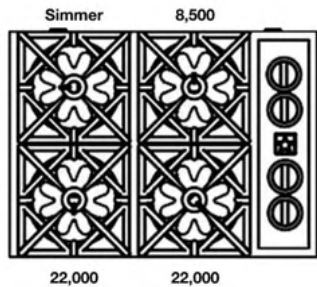
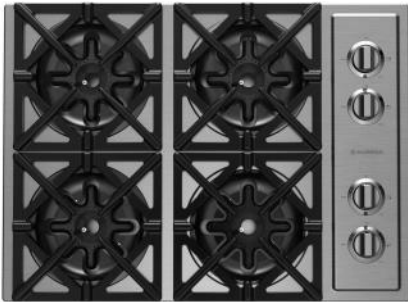

Model	Description (* Denotes item that must be specified)	UMRP	MSRP
<b>Natural Gas Models: 30" Drop-In Cooktop</b>			
RBCT304BSSV2	4 Burners   Nat Gas   Stainless Steel   Std Trim	\$ 2,695	\$ 3,100
RBCT304BSSV2PLT	4 Burners   Nat Gas   Stainless Steel   Plated Trim*	\$ 3,425	\$ 3,940
<b>LP/Propane Models: 30" Drop-In Cooktop</b>			
RBCT304BSSV2L	4 Burners   LP Gas   Stainless Steel   Std Trim	\$ 2,695	\$ 3,100
RBCT304BSSV2LPLT	4 Burners   LP Gas   Stainless Steel   Plated Trim*	\$ 3,425	\$ 3,940
<b>KNOB OPTIONS: (Total Knobs: 4)</b>			
KN-C	Knob: Standard 190 RAL Color	\$ 115 ea	\$ 130 ea
BZ-C	Bezel: Standard 190 RAL Color	\$ 65 ea	\$ 75 ea
KN-CF	Knob: Spec Finish (Matte RAL, Textured RAL or Prec Metals)	\$185 ea	\$ 215 ea
KN-PLT	Knob: Plated Trim (See options below)	\$ 250 ea	\$ 290 ea
<b>PLATED TRIM OPTIONS: (Includes bezels and logo)</b>			
Antique Brass, Brushed Brass, Polished Brass, Antique Copper, Brushed Copper, Polished Copper, Chrome, Oil Rubbed Bronze & Pewter			

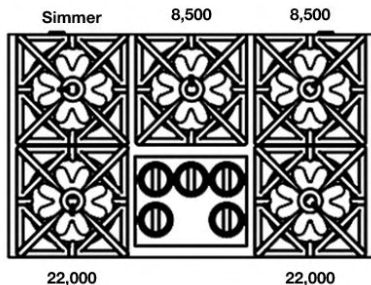

Model	Description (* Denotes item that must be specified)	UMRP	MSRP
<b>Natural Gas Models: 36" Drop-In Cooktop</b>			
RBCT365BSSV2	5 Burners   Nat Gas   Stainless Steel   Std Trim	\$ 3,395	\$ 3,905
RBCT365BSSV2PLT	5 Burners   Nat Gas   Stainless Steel   Plated Trim*	\$ 4,440	\$ 5,105
<b>LP/Propane Models: 36" Drop-In Cooktop</b>			
RBCT365BSSV2L	5 Burners   LP Gas   Stainless Steel   Std Trim	\$ 3,395	\$ 3,905
RBCT365BSSV2LPLT	5 Burners   LP Gas   Stainless Steel   Plated Trim*	\$ 4,440	\$ 5,105
<b>KNOB OPTIONS: (Total Knobs: 5)</b>			
KN-C	Knob: Standard 190 RAL Color	\$ 115 ea	\$ 130 ea
BZ-C	Bezel: Standard 190 RAL Color	\$ 65 ea	\$ 75 ea
KN-CF	Knob: Spec Finish (Matte RAL, Textured RAL or Prec Metals)	\$185 ea	\$ 215 ea
KN-PLT	Knob: Plated Trim (See options below)	\$ 250 ea	\$ 290 ea
<b>PLATED TRIM OPTIONS: (Includes bezels and logo)</b>			
Antique Brass, Brushed Brass, Polished Brass, Antique Copper, Brushed Copper, Polished Copper, Chrome, Oil Rubbed Bronze & Pewter			

### FEATURES:

- 22,000 BTU UltraNova™ burners & 15,000 BTU Nova™ burners
- Precise 130° simmer burner
- Full motion grates
- Stainless steel knobs and available customization
- Includes wok ring accessory
- Enhanced compatibility with BlueStar Electric Wall Oven

### PRODUCT SPECIFICATIONS:

- 30" Unit Dimensions: 30"W x 22"D x 5"H
- 36" Unit Dimensions: 36"W x 22"D x 5"H
- Top Burner Power: 22,000 BTUs
- Simmer Burner: 9,000 BTUs
- Electrical Requirements: 120V, 60Hz, 15 AMPS, 1PH
- Gas Pressure: NAT: 5.0" WC, LP 10.0" WC
- Gas Line Size: ½"
- 30" Unit Weight: 160 lbs.
- 36" Unit Weight: 175 lbs.

## COOKTOPS: 36" INDUCTION

### BlueStar Model Number Guide:

<b>Base Model (BS36INDCKT)</b> 5 Burners   Induction   Standard Trim	<b>Change to LP Gas</b> Not available on Induction models	<b>Add code below for desired color</b> Not available on Rangetop or Cooktop models	<b>Add (PLT) for Plated Trim</b> Includes plated bezels and logo. See available options below.
-------------------------------------------------------------------------	--------------------------------------------------------------	----------------------------------------------------------------------------------------	---------------------------------------------------------------------------------------------------



#### FEATURES:

- Features a searing 5,500 Watt burner
- Rapid “Heat Accelerator” technology for no-wait cooking, heats 50% faster than gas
- Exceptional temperature control with 12 cooking settings
- Maximum cooking surface fits up to 5 pots or pans
- Seamless 2-burner bridging technology, perfect for grilling or searing with the Cast Iron Dual Zone Griddle (Sold separately)
- Gentle simmer capabilities, down to 200 degrees
- Perfect “Keep Warm” (150 degrees) feature for entertaining ease
- Intuitive design with sleek push-to-turn knobs and easy-to-clean, scratch resistant, non-staining glass top
- Safety knob lock feature & no-touch hot surface indicator light
- Customize with 190 color knobs and 10 metal finishes

Model	Description (* Denotes item that must be specified)	UMRP	MSRP
<b>Natural Gas Models: 30" Drop-In Cooktop</b>			
BSP36INDCKT	5 Burner   Induction   Std Trim	\$ 4,395	\$ 5,055
BSP36INDCKTPLT	5 Burner   Induction   Plated Trim*	\$ 5,440	\$ 6,255
<b>KNOB OPTIONS: (Total Knobs: 5)</b>			
KN-C	Knob: Standard 190 RAL Color	\$ 115 ea	\$ 130 ea
BZ-C	Bezel: Standard 190 RAL Color	\$ 65 ea	\$ 75 ea
KN-CF	Knob: Spec Finish (Matte RAL, Textured RAL or Prec Metals)	\$185 ea	\$ 215 ea
KN-PLT	Knob: Plated Trim (See options below)	\$ 250 ea	\$ 290 ea
<b>PLATED TRIM OPTIONS: (Includes bezels and logo)</b>			
Antique Brass, Brushed Brass, Polished Brass, Antique Copper, Brushed Copper, Polished Copper, Chrome, Oil Rubbed Bronze & Pewter			
See page 52 for additional customization and accessories for Rangetops and Cooktops			

#### PRODUCT SPECIFICATIONS:

- Unit Dims: 36 1/16"W x 21 1/8"D x 3 7/8"H
- 31/64<sup>th</sup> from counter to top of glass
- Electrical: 230V, 50 amp, 50/60Hz
- Connection: 2 Phases
- Diameter: 3 x 10 AWG (Provided)

## RANGETOPS & COOKTOPS: CUSTOMIZATION & ACCESSORY OPTIONS

Item	Description	UMRP	MSRP
<b>CONFIGURATION OPTIONS: BURNERS (Available on Platinum &amp; Nova/RNB Series Only)</b>			
BURNER CHG	Add (1) Star Burner – RNB / RGTNB (Simmer, 15K & 22K)   BSP (Simmer, 15K, 18K, 22K or 25K) or Swap (2) Star Burners – RNB / RGTNB / BSP	\$ 650	\$ 745
<b>PAINT &amp; PLATING OPTIONS:</b>			
KN-C	Knob: Standard RAL (Semi-Gloss) Knob – Factory Installed . (Excludes Pearl, Luminous & Aluminum)	\$ 115 ea	\$ 130 ea
BZ-C	Bezel: Standard RAL (Semi-Gloss) Knob – Factory Installed . (Excludes Pearl, Luminous & Aluminum)	\$ 65 ea	\$ 75 ea
KN-CF	Knob: Specialty Finish (Matte RAL, Textured RAL or Precious Metals) – Factory Installed .	\$ 185 ea	\$ 210 ea
KN-CC	Knob: Custom Color Knob – Factory Installed. MUST be ordered with 24” – 60” Custom Color appliance.	\$ 200 ea	\$ 230 ea
KN-PLT	Knob: Plated Trim	\$ 250 ea	\$ 290 ea
BZ-PLT	Bezel: Plated Trim	\$ 160 ea	\$ 185 ea
<b>ACCESSORIES:</b>			
IT24BSP	24” Island Trim Backguard for Platinum and Nova (RGTNB) Rangetops	\$ 515	\$ 590
IT30BSP	30” Island Trim Backguard for Platinum and Nova (RGTNB) Rangetops	\$ 515	\$ 590
IT36BSP	36” Island Trim Backguard for Platinum and Nova (RGTNB) Rangetops	\$ 605	\$ 695
IT48BSP	48” Island Trim Backguard for Platinum and Nova (RGTNB) Rangetops	\$ 870	\$ 1,000
IT60BSP	60” Island Trim Backguard for Platinum and Nova (RGTNB) Rangetops	\$ 1,100	\$ 1,265
KN-SS	Knob: Brushed Stainless Steel	\$ 115 ea	\$ 130 ea
KN-BLK	Standard Black Knob	\$ 80 ea	\$ 90 ea
BZ-SS	Bezel: Brushed Stainless Steel	\$ 65 ea	75 ea
BSPICBG12	Interchangeable Griddle Charbroiler – 4 piece	\$ 1,195	\$ 1,375
138901	Wok Ring	\$ 160	\$ 185
701120	Induction Cast Iron Dual Zone Griddle (1 piece / reversible)	\$ 280	\$ 320



## WALL OVENS

Get the Look: 30" Double Electric Wall Oven with French and Drop Down Doors in Matte Black

## DOUBLE ELECTRIC WALL OVENS: 30" FRENCH DOOR/DROP DOOR

BlueStar Model Number Guide:		
<b>Base Model (BSDEWO30SDV3)</b> French/Drop Door   Electric   Stainless Steel Finish   Standard Trim	<b>Add code below for desired color</b> (C) 190 Standard RAL (Semi-Gloss) Colors (CF) Specialty Finish (190 Matte RAL, Precious Metals & Textures) (CC) Custom Colors	<b>Add (PLT) for Plated Trim</b> Includes plated bezels, door handle, handle end and logo. See available options below.



Model	Description (* Denotes item that must be specified)	UMRP	MSRP
<b>30" Double Electric Wall Oven with French and Drop Door</b>			
BSDEWO30SDV3	French/Drop Door   Stainless Steel   Standard Trim	\$ 10,695	\$ 12,300
BSDEWO30SDV3PLT	French/Drop Door   Stainless Steel   Plated Trim*	\$ 13,000	\$ 14,950
BSDEWO30SDV3C	French/Drop Door   Std RAL Color*   Standard Trim	\$ 12,010	\$ 13,810
BSDEWO30SDV3CPLT	French/Drop Door   Std RAL Color*   Plated Trim*	\$ 14,315	\$ 16,460
BSDEWO30SDV3CF	French/Drop Door   Specialty Finish*   Standard Trim	\$ 12,890	\$ 14,825
BSDEWO30SDV3CFPLT	French/Drop Door   Specialty Finish*   Plated Trim*	\$ 15,195	\$ 17,475
BSDEWO30SDV3CC	French/Drop Door   Custom Color*   Standard Trim	\$ 14,430	\$ 16,595
BSDEWO30SDV3CCPLT	French/Drop Door   Custom Color*   Plated Trim*	\$ 16,735	\$ 19,245
<b>KNOB OPTIONS: (Total Knobs: 2)</b>			
KN-C	Knob: Standard 190 RAL Color	\$ 115 ea	\$ 130 ea
KN-CF	Knob: Spec Finish (Matte RAL, Textured RAL or Prec Metals)	\$ 185 ea	\$ 215 ea
KN-PLT	Knob: Plated Trim (See options below)	\$ 250 ea	\$ 290 ea
BZ-C	Bezel: Standard 190 RAL Color	\$ 65 ea	\$ 75 ea
<b>PLATED TRIM OPTIONS: (Includes bezels, door handle, handle ends and logo)</b>			
Antique Brass, Brushed Brass, Polished Brass, Antique Copper, Brushed Copper, Polished Copper, Chrome, Oil Rubbed Bronze & Pewter			
See page 61 for additional customization and accessories			

### FEATURES:

- New over-sized, intuitive, full-color touchscreen with unique customization capabilities.
- Extra-large oven capacity, overall capacity of 9.2 cu ft & industry leading usable capacity of 7.1 cu ft.
- Built-in, temperature-controlled bake stone for perfect artisan breads and pizzas.
- Professional-level performance with 9 cooking modes plus temperature probe, delayed start, timed cook, warm and Sabbath features.
- Fits full-size commercial sheet pans & includes a full-extension rack.
- Unmatched customization: choose from 1,000+ colors and 10 metal finishes or custom colors.
- Easy to clean, 90-minute express cycle.
- Handcrafted in Pennsylvania since 1880.

### PRODUCT SPECIFICATIONS:

- Unit Dimensions: 30"W x 25 5/32"D x 49 3/4"H
- Oven Interior: 26.438"W x 20"D x 15"H
- Elec. Reqs: 240V, 60Hz, 50 AMPs, 1 PH
- Unit Weight: 483 lbs.

## DOUBLE ELECTRIC WALL OVENS: 30" DOUBLE DROP DOOR

BlueStar Model Number Guide:		
<b>Base Model (BSDEWO30DDV3)</b> Double Drop Door   Electric   Stainless Steel Finish   Standard Trim	<b>Add code below for desired color</b> (C) 190 Standard RAL (Semi-Gloss) Colors (CF) Specialty Finish (190 Matte RAL, Precious Metals & Textures) (CC) Custom Colors	<b>Add (PLT) for Plated Trim</b> Includes plated bezels, door handle, handle end and logo. See available options below.



Model	Description (* Denotes item that must be specified)	UMRP	MSRP
<b>30" Double Electric Wall Oven with Double Drop Doors</b>			
BSDEWO30DDV3	Drop Doors   Stainless Steel   Standard Trim	\$ 10,095	\$ 11,610
BSDEWO30DDV3PLT	Drop Doors   Stainless Steel   Plated Trim*	\$ 12,400	\$ 14,260
BSDEWO30DDV3C	Drop Doors   Std RAL Color*   Standard Trim	\$ 11,410	\$ 13,120
BSDEWO30DDV3CPLT	Drop Doors   Std RAL Color*   Plated Trim*	\$ 13,715	\$ 15,770
BSDEWO30DDV3CF	Drop Doors   Specialty Finish*   Standard Trim	\$ 12,290	\$ 14,135
BSDEWO30DDV3CFPLT	Drop Doors   Specialty Finish*   Plated Trim*	\$ 14,595	\$ 16,785
BSDEWO30DDV3CC	Drop Doors   Custom Color*   Standard Trim	\$ 13,830	\$ 15,905
BSDEWO30DDV3CCPLT	Drop Doors   Custom Color*   Plated Trim*	\$ 16,135	\$ 18,555
<b>KNOB OPTIONS: (Total Knobs: 2)</b>			
KN-C	Knob: Standard 190 RAL Color	\$ 115 ea	\$ 130 ea
KN-CF	Knob: Spec Finish (Matte RAL, Textured RAL or Prec Metals)	\$ 185 ea	\$ 215 ea
KN-PLT	Knob: Plated Trim (See options below)	\$ 250 ea	\$ 290 ea
BZ-C	Bezel: Standard 190 RAL Color	\$ 65 ea	\$ 75 ea
<b>PLATED TRIM OPTIONS: (Includes bezels, door handle, handle ends and logo)</b>			
Antique Brass, Brushed Brass, Polished Brass, Antique Copper, Brushed Copper, Polished Copper, Chrome, Oil Rubbed Bronze & Pewter			
See page 61 for additional customization and accessories			

### FEATURES:

- New over-sized, intuitive, full-color touchscreen with unique customization capabilities.
- Extra-large oven capacity, overall capacity of 9.2 cu ft & industry leading usable capacity of 7.1 cu ft.
- Built-in, temperature-controlled bake stone for perfect artisan breads and pizzas.
- Professional-level performance with 9 cooking modes plus temperature probe, delayed start, timed cook, warm and Sabbath features.
- Fits full-size commercial sheet pans & includes a full-extension rack.
- Unmatched customization: choose from 1,000+ colors and 10 metal finishes or custom colors.
- Easy to clean, 90-minute express cycle.
- Handcrafted in Pennsylvania since 1880.

### PRODUCT SPECIFICATIONS:

- Unit Dimensions: 30"W x 25 5/32"D x 49 3/4"H
- Oven Interior: 26.438"W x 20"D x 15"H
- Elec. Reqs: 240V, 60Hz, 50 AMPs, 1 PH
- Unit Weight: 483 lbs.

## ELECTRIC WALL OVENS: 30" FRENCH DOOR

### BlueStar Model Number Guide:

<b>Base Model (BSEWO30SDV3)</b> French Door   Electric   Stainless Steel Finish   Standard Trim	<b>Add code below for desired color</b> (C) 190 Standard RAL (Semi-Gloss) Colors (CF) Specialty Finish (190 Matte RAL, Precious Metals & Textures) (CC) Custom Colors	<b>Add (PLT) for Plated Trim</b> Includes plated bezels, door handle, handle end and logo. See available options below.
----------------------------------------------------------------------------------------------------	--------------------------------------------------------------------------------------------------------------------------------------------------------------------------------	-------------------------------------------------------------------------------------------------------------------------------



#### FEATURES:

- New over-sized, intuitive, full-color touchscreen with unique customization capabilities.
- Extra-large oven capacity, overall capacity of 4.6 cu ft & industry leading usable capacity of 3.5 cu ft.
- Built-in, temperature-controlled bake stone for perfect artisan breads and pizzas.
- Professional-level performance with 9 cooking modes plus temperature probe, delayed start, timed cook, warm and Sabbath features.
- Fits full-size commercial sheet pans & includes a full-extension rack.
- Unmatched customization: choose from 1,000+ colors and 10 metal finishes or custom colors.
- Easy to clean, 90-minute express cycle.
- Handcrafted in Pennsylvania since 1880.

#### PRODUCT SPECIFICATIONS:

- Unit Dimensions: 30"W x 25.875"D x 27.5"H
- Oven Interior: 26.438"W x 20"D x 15"H
- Elec. Reqs: 208-240 VAC, 24 Amps
- Unit Weight: 304 lbs.

Model	Description (* Denotes item that must be specified)	UMRP	MSRP
<b>30" Electric Wall Oven with French Door</b>			
BSEWO30SDV3	French Door   Stainless Steel   Standard Trim	\$ 7,095	\$ 8,160
BSEWO30SDV3PLT	French Door   Stainless Steel   Plated Trim*	\$ 8,665	\$ 9,965
BSEWO30SDV3C	French Door   Std RAL Color*   Standard Trim	\$ 8,190	\$ 9,420
BSEWO30SDV3CPLT	French Door   Std RAL Color*   Plated Trim*	\$ 9,760	\$ 11,225
BSEWO30SDV3CF	French Door   Specialty Finish*   Standard Trim	\$ 9,180	\$ 10,555
BSEWO30SDV3CFPLT	French Door   Specialty Finish*   Plated Trim*	\$ 10,750	\$ 12,360
BSEWO30SDV3CC	French Door   Custom Color*   Standard Trim	\$ 10,610	\$ 12,200
BSEWO30SDV3CCPLT	French Door   Custom Color*   Plated Trim*	\$ 12,180	\$ 14,005
<b>STACKING KIT:</b>			
EWOSTK-30	Stacking Kit for 30" Electric Wall Ovens	N/C	N/C
<b>KNOB OPTIONS: (Total Knobs: 2)</b>			
KN-C	Knob: Standard 190 RAL Color	\$ 115 ea	\$ 130 ea
KN-CF	Knob: Spec Finish (Matte RAL, Textured RAL or Prec Metals)	\$ 185 ea	\$ 215 ea
KN-PLT	Knob: Plated Trim (See options below)	\$ 250 ea	\$ 290 ea
BZ-C	Bezel: Standard 190 RAL Color	\$ 65 ea	\$ 75 ea
<b>PLATED TRIM OPTIONS: (Includes bezels, door handle, handle ends and logo)</b>			
Antique Brass, Brushed Brass, Polished Brass, Antique Copper, Brushed Copper, Polished Copper, Chrome, Oil Rubbed Bronze & Pewter			
See page 61 for additional customization and accessories			

## ELECTRIC WALL OVENS: 30" DROP DOOR

BlueStar Model Number Guide:		
<b>Base Model (BSEWO30DDV3)</b> Drop Door   Electric   Stainless Steel Finish   Standard Trim	<b>Add code below for desired color</b> (C) 190 Standard RAL (Semi-Gloss) Colors (CF) Specialty Finish (190 Matte RAL, Precious Metals & Textures) (CC) Custom Colors	<b>Add (PLT) for Plated Trim</b> Includes plated bezels, door handle, handle end and logo. See available options below.



### FEATURES:

- New over-sized, intuitive, full-color touchscreen with unique customization capabilities.
- Extra-large oven capacity, overall capacity of 4.6 cu ft & industry leading usable capacity of 3.5 cu ft.
- Built-in, temperature-controlled bake stone for perfect artisan breads and pizzas.
- Professional-level performance with 9 cooking modes plus temperature probe, delayed start, timed cook, warm and Sabbath features.
- Fits full-size commercial sheet pans & includes a full-extension rack.
- Unmatched customization: choose from 1,000+ colors and 10 metal finishes or custom colors.
- Easy to clean, 90-minute express cycle.
- Handcrafted in Pennsylvania since 1880.

### PRODUCT SPECIFICATIONS:

- Unit Dimensions: 30"W x 25.875"D x 27.5"H
- Oven Interior: 26.438"W x 20"D x 15"H
- Elec. Reqs: 208-240 VAC, 24 Amps
- Unit Weight: 304 lbs.

Model	Description (* Denotes item that must be specified)	UMRP	MSRP
<b>30" Electric Wall Oven with Drop Door</b>			
BSEWO30DDV3	Drop Door   Stainless Steel   Standard Trim	\$ 6,495	\$ 7,470
BSEWO30DDV3PLT	Drop Door   Stainless Steel   Plated Trim*	\$ 8,065	\$ 9,275
BSEWO30DDV3C	Drop Door   Std RAL Color*   Standard Trim	\$ 7,590	\$ 8,730
BSEWO30DDV3CPLT	Drop Door   Std RAL Color*   Plated Trim*	\$ 9,160	\$ 10,535
BSEWO30DDV3CF	Drop Door   Specialty Finish*   Standard Trim	\$ 8,580	\$ 9,865
BSEWO30DDV3CFPLT	Drop Door   Specialty Finish*   Plated Trim*	\$ 10,150	\$ 11,675
BSEWO30DDV3CC	Drop Door   Custom Color*   Standard Trim	\$ 10,010	\$ 11,510
BSEWO30DDV3CCPLT	Drop Door   Custom Color*   Plated Trim*	\$ 11,580	\$ 13,315
<b>STACKING KIT:</b>			
EWOSTK-30	Stacking Kit for 30" Electric Wall Ovens	N/C	N/C
<b>KNOB OPTIONS: (Total Knobs: 2)</b>			
KN-C	Knob: Standard 190 RAL Color	\$ 115 ea	\$ 130 ea
KN-CF	Knob: Spec Finish (Matte RAL, Textured RAL or Prec Metals)	\$ 185 ea	\$ 215 ea
KN-PLT	Knob: Plated Trim (See options below)	\$ 250 ea	\$ 290 ea
BZ-C	Bezel: Standard 190 RAL Color	\$ 65 ea	\$ 75 ea
<b>PLATED TRIM OPTIONS: (Includes bezels, door handle, handle ends and logo)</b>			
Antique Brass, Brushed Brass, Polished Brass, Antique Copper, Brushed Copper, Polished Copper, Chrome, Oil Rubbed Bronze & Pewter			
See page 61 for additional customization and accessories			

## GAS WALL OVENS: 36" BUILT-IN

<b>BlueStar Model Number Guide:</b>			
<b>Base Model (BWO36AGSV2)</b> French Door   Natural Gas   Stainless Steel Finish   Standard Trim	<b>Change to LP Gas</b> Add (L) for LP/Propane Gas	<b>Add code below for desired color</b> (C) 190 Standard RAL (Semi-Gloss) Colors (CF) Specialty Finish (190 Matte RAL, Precious Metals & Textures) (CC) Custom Colors	<b>Add (PLT) for Plated Trim</b> Includes plated bezels, door handle, handle end and logo. See available options below.

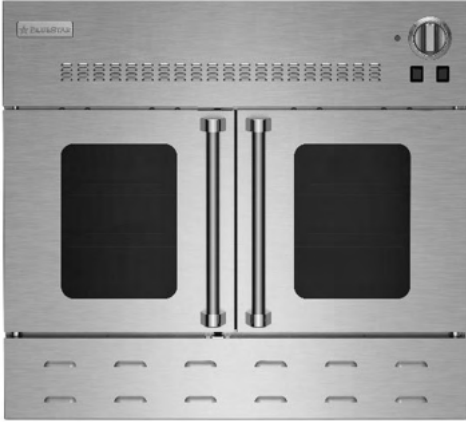

### FEATURES:

- Powerful 25,000 BTU burner with 1850° Infrared Broiler
- Extra-large oven that accommodates a full size 18" x 26" commercial baking sheet
- 24" depth for compatibility with standard kitchen cabinetry
- Available as single ovens or two single ovens double stacked
- Available in 1,000+ colors & finishes
- Handcrafted in Pennsylvania since 1880

### PRODUCT SPECIFICATIONS:

- Unit Dimensions: 36"W x 23"D x 32.75"H
- Oven Interior: 29.25"W x 20"D x 15"H
- Gas Pressure: NAT: 5.0" WC, LP 10.0" WC
- Gas Line Size: ½"
- Unit Weight: 400 lbs.

Model	Description (* Denotes item that must be specified)	UMRP	MSRP
<b>Natural Gas Models: 36" Built-In Gas Wall Oven</b>			
BWO36AGSV2	Nat Gas   Stainless Steel   Standard Trim	\$ 7,395	\$ 8,505
BWO36AGSV2PLT	Nat Gas   Stainless Steel   Plated Trim*	\$ 8,965	\$ 10,310
BWO36AGSV2C	Nat Gas   Std RAL Color*   Standard Trim	\$ 8,490	\$ 9,795
BWO36AGSV2CPLT	Nat Gas   Std RAL Color*   Plated Trim*	\$ 10,050	\$ 11,570
BWO36AGSV2CF	Nat Gas   Specialty Finish*   Standard Trim	\$ 9,480	\$ 10,900
BWO36AGSV2CFPLT	Nat Gas   Specialty Finish*   Plated Trim*	\$ 11,050	\$ 12,705
BWO36AGSV2CC	Nat Gas   Custom Color*   Standard Trim	\$ 10,910	\$ 12,545
BWO36AGSV2CCPLT	Nat Gas   Custom Color*   Plated Trim*	\$ 12,480	\$ 14,350
<b>LP/Propane Models: 36" Built-In Gas Wall Oven</b>			
BWO36AGSV2L	LP Gas   Stainless Steel   Standard Trim	\$ 7,395	\$ 8,505
BWO36AGSV2LPLT	LP Gas   Stainless Steel   Plated Trim*	\$ 8,965	\$ 10,310
BWO36AGSV2LC	LP Gas   Std RAL Color*   Standard Trim	\$ 8,490	\$ 9,795
BWO36AGSV2LCPLT	LP Gas   Std RAL Color*   Plated Trim*	\$ 10,050	\$ 11,570
BWO36AGSV2LCF	LP Gas   Specialty Finish*   Standard Trim	\$ 9,480	\$ 10,900
BWO36AGSV2LCFPLT	LP Gas   Specialty Finish*   Plated Trim*	\$ 11,050	\$ 12,705
BWO36AGSV2LCC	LP Gas   Custom Color*   Standard Trim	\$ 10,910	\$ 12,545
BWO36AGSV2LCCPLT	LP Gas   Custom Color*   Plated Trim*	\$ 12,480	\$ 14,350
<b>STACKING KIT:</b>			
BWOSTK-36	Stacking Kit for 36" Gas Wall Ovens	N/C	N/C
<b>KNOB OPTIONS: (Total Knobs: 1)</b>			
KN-BLK	Standard Black Knob (Ordered with unit)	N/C	N/C
KN-C	Knob: Standard 190 RAL Color	\$ 115 ea	\$ 130 ea
KN-CF	Knob: Spec Finish (Matte RAL, Textured RAL or Prec Metals)	\$ 185 ea	\$ 215 ea
KN-PLT	Knob: Plated Trim (See options below)	\$ 250 ea	\$ 290 ea
BZ-C	Bezel: Standard 190 RAL Color	\$ 65 ea	\$ 75 ea
<b>PLATED TRIM OPTIONS: (Includes bezels, door handle, handle ends and logo)</b>			
Antique Brass, Brushed Brass, Polished Brass, Antique Copper, Brushed Copper, Polished Copper, Chrome, Oil Rubbed Bronze & Pewter			
See page 61 for additional customization and accessories			

## GAS WALL OVENS: 30" BUILT-IN

<b>BlueStar Model Number Guide:</b>			
<b>Base Model (BWO30AGSV2)</b> French Door   Natural Gas   Stainless Steel Finish   Standard Trim	<b>Change to LP Gas</b> Add (L) for LP/Propane Gas	<b>Add code below for desired color</b> (C) 190 Standard RAL (Semi-Gloss) Colors (CF) Specialty Finish (190 Matte RAL, Precious Metals & Textures) (CC) Custom Colors	<b>Add (PLT) for Plated Trim</b> Includes plated bezels, door handle, handle end and logo. See available options below.



**FEATURES:**

- Powerful 25,000 BTU burner with 1850° Infrared Broiler
- Extra-large oven that accommodates a full size 18" x 26" commercial baking sheet
- 24" depth for compatibility with standard kitchen cabinetry
- Available as single ovens or two single ovens double stacked
- Available in 1,000+ colors & finishes
- Handcrafted in Pennsylvania since 1880

**PRODUCT SPECIFICATIONS:**

- Unit Dimensions: 30"W x 26"D x 32.75"H
- Oven Interior: 26.438"W x 20"D x 15"H
- Gas Pressure: NAT: 5.0" WC, LP 10.0" WC
- Gas Line Size: ½"
- Unit Weight: 305 lbs.

Model	Description (* Denotes item that must be specified)	UMRP	MSRP
<b>Natural Gas Models: 30" Built-In Gas Wall Oven</b>			
BWO30AGSV2	Nat Gas   Stainless Steel   Standard Trim	\$ 6,195	\$ 7,125
BWO30AGSV2PLT	Nat Gas   Stainless Steel   Plated Trim*	\$ 7,765	\$ 8,930
BWO30AGSV2C	Nat Gas   Std RAL Color*   Standard Trim	\$ 7,290	\$ 8,930
BWO30AGSV2CPLT	Nat Gas   Std RAL Color*   Plated Trim*	\$ 8,860	\$ 10,190
BWO30AGSV2CF	Nat Gas   Specialty Finish*   Standard Trim	\$ 8,280	\$ 9,520
BWO30AGSV2CFPLT	Nat Gas   Specialty Finish*   Plated Trim*	\$ 9,850	\$ 11,330
BWO30AGSV2CC	Nat Gas   Custom Color*   Standard Trim	\$ 9,710	\$ 11,165
BWO30AGSV2CCPLT	Nat Gas   Custom Color*   Plated Trim*	\$ 11,280	\$ 12,970
<b>LP/Propane Models: 30" Built-In Gas Wall Oven</b>			
BWO30AGSV2L	LP Gas   Stainless Steel   Standard Trim	\$ 6,195	\$ 7,125
BWO30AGSV2LPLT	LP Gas   Stainless Steel   Plated Trim*	\$ 7,765	\$ 8,930
BWO30AGSV2LC	LP Gas   Std RAL Color*   Standard Trim	\$ 7,290	\$ 8,930
BWO30AGSV2LCPLT	LP Gas   Std RAL Color*   Plated Trim*	\$ 8,860	\$ 10,190
BWO30AGSV2LCF	LP Gas   Specialty Finish*   Standard Trim	\$ 8,280	\$ 9,520
BWO30AGSV2LCFPLT	LP Gas   Specialty Finish*   Plated Trim*	\$ 9,850	\$ 11,330
BWO30AGSV2LCC	LP Gas   Custom Color*   Standard Trim	\$ 9,710	\$ 11,165
BWO30AGSV2LCCPLT	LP Gas   Custom Color*   Plated Trim*	\$ 11,280	\$ 12,970
<b>STACKING KIT:</b>			
BWOSTK-30	Stacking Kit for 30" Gas Wall Ovens	N/C	N/C
<b>KNOB OPTIONS: (Total Knobs: 1)</b>			
KN-BLK	Standard Black Knob (Ordered with unit)	N/C	N/C
KN-C	Knob: Standard 190 RAL Color	\$ 115 ea	\$ 130 ea
KN-CF	Knob: Spec Finish (Matte RAL, Textured RAL or Prec Metals)	\$ 185 ea	\$ 215 ea
KN-PLT	Knob: Plated Trim (See options below)	\$ 250 ea	\$ 290 ea
BZ-C	Bezel: Standard 190 RAL Color	\$ 65 ea	\$ 75 ea
<b>PLATED TRIM OPTIONS: (Includes bezels, door handle, handle ends and logo)</b>			
Antique Brass, Brushed Brass, Polished Brass, Antique Copper, Brushed Copper, Polished Copper, Chrome, Oil Rubbed Bronze & Pewter			
See page 61 for additional customization and accessories			

## GAS WALL OVENS: 24" BUILT-IN

### BlueStar Model Number Guide:

<b>Base Model (BWO24AGSV2)</b> Left Hinge   Natural Gas   Stainless Steel Finish   Standard Trim	<b>Change to LP Gas</b> Add (L) for LP/Propane Gas	<b>Add code below for desired color</b> (C) 190 Standard RAL (Semi-Gloss) Colors (CF) Specialty Finish (190 Matte RAL, Precious Metals & Textures) (CC) Custom Colors	<b>Add (PLT) for Plated Trim</b> Includes plated bezels, door handle, handle end and logo. See available options below.
-----------------------------------------------------------------------------------------------------	-------------------------------------------------------	--------------------------------------------------------------------------------------------------------------------------------------------------------------------------------	----------------------------------------------------------------------------------------------------------------------------



Model Shown: BWO24AGS (Left Hinge)  
 Must notate right or left hinge at time of order

#### FEATURES:

- Powerful 25,000 BTU burner with 1850° Infrared Broiler
- Extra-large oven that accommodates a half size 18" x 13" commercial baking sheet
- Features swing door design from either left or right side
- 24" depth for compatibility with standard kitchen cabinetry
- Available as single ovens or two single ovens double stacked
- Available in 1,000+ colors & finishes
- Handcrafted in Pennsylvania since 1880

#### PRODUCT SPECIFICATIONS:

- Unit Dimensions: 24"W x 23"D x 32.75"H
- Oven Interior: 20.25"W x 20"D x 15"H
- Gas Pressure: NAT: 5.0" WC, LP 10.0" WC
- Gas Line Size: ½"
- Unit Weight: 295 lbs.

Model	Description (* Denotes item that must be specified)	UMRP	MSRP
<b>Natural Gas Models: 24" Built-In Gas Wall Oven</b>			
BWO24AGSV2	Nat Gas   Stainless Steel   Standard Trim	\$ 4,695	\$ 5,400
BWO24AGSV2PLT	Nat Gas   Stainless Steel   Plated Trim*	\$ 5,740	\$ 6,600
BWO24AGSV2C	Nat Gas   Std RAL Color*   Standard Trim	\$ 5,790	\$ 6,600
BWO24AGSV2CPLT	Nat Gas   Std RAL Color*   Plated Trim*	\$ 6,835	\$ 7,860
BWO24AGSV2CF	Nat Gas   Specialty Finish*   Standard Trim	\$ 6,780	\$ 7,795
BWO24AGSV2CFPLT	Nat Gas   Specialty Finish*   Plated Trim*	\$ 7,825	\$ 9,000
BWO24AGSV2CC	Nat Gas   Custom Color*   Standard Trim	\$ 8,210	\$ 9,440
BWO24AGSV2CCPLT	Nat Gas   Custom Color*   Plated Trim*	\$ 9,255	\$ 10,645
<b>LP/Propane Models: 24" Built-In Gas Wall Oven</b>			
BWO24AGSV2L	LP Gas   Stainless Steel   Standard Trim	\$ 4,695	\$ 5,400
BWO24AGSV2LPLT	LP Gas   Stainless Steel   Plated Trim*	\$ 5,740	\$ 6,600
BWO24AGSV2LC	LP Gas   Std RAL Color*   Standard Trim	\$ 5,790	\$ 6,600
BWO24AGSV2LCPLT	LP Gas   Std RAL Color*   Plated Trim*	\$ 6,835	\$ 7,860
BWO24AGSV2LCF	LP Gas   Specialty Finish*   Standard Trim	\$ 6,780	\$ 7,795
BWO24AGSV2LCFPLT	LP Gas   Specialty Finish*   Plated Trim*	\$ 7,825	\$ 9,000
BWO24AGSV2LCC	LP Gas   Custom Color*   Standard Trim	\$ 8,210	\$ 9,440
BWO24AGSV2LCCPLT	LP Gas   Custom Color*   Plated Trim*	\$ 9,255	\$ 10,645
<b>STACKING KIT:</b>			
BWOSTK-24	Stacking Kit for 24" Gas Wall Ovens	N/C	N/C
<b>KNOB OPTIONS: (Total Knobs: 1)</b>			
KN-BLK	Standard Black Knob (Ordered with unit)	N/C	N/C
KN-C	Knob: Standard 190 RAL Color	\$ 115 ea	\$ 130 ea
KN-CF	Knob: Spec Finish (Matte RAL, Textured RAL or Prec Metals)	\$ 185 ea	\$ 215 ea
KN-PLT	Knob: Plated Trim (See options below)	\$ 250 ea	\$ 290 ea
BZ-C	Bezel: Standard 190 RAL Color	\$ 65 ea	\$ 75 ea
<b>PLATED TRIM OPTIONS: (Includes bezels, door handle, handle ends and logo)</b>			
Antique Brass, Brushed Brass, Polished Brass, Antique Copper, Brushed Copper, Polished Copper, Chrome, Oil Rubbed Bronze & Pewter			
See page 61 for additional customization and accessories			

## GAS & ELECTRIC WALL OVENS: CUSTOMIZATION & ACCESSORY OPTIONS

PAINT & PLATING OPTIONS:			
KN-C	Knob: Standard RAL (Semi-Gloss) Knob – Factory Installed . (Excludes Pearl, Luminous & Aluminum)	\$ 115 ea	\$ 130 ea
KN-CF	Knob: Specialty Finish (Matte RAL, Textured RAL or Precious Metals) – Factory Installed .	\$ 185 ea	\$ 215 ea
KN-CC	Knob: Custom Color Knob – Factory Installed. MUST be ordered with 24” – 60” Custom Color appliance.	\$ 200 ea	\$ 230 ea
KN-PLT	Knob: Plated Trim	\$ 250 ea	\$ 290 ea
BZ-C	Bezel: Standard RAL (Semi-Gloss) Knob – Factory Installed . (Excludes Pearl, Luminous & Aluminum)	\$ 65 ea	\$ 75 ea
BZ-PLT	Bezel: Plated Trim	\$ 160 ea	\$ 185 ea
ACCESSORIES:			
KN-SS	Knob: Brushed Stainless Steel	\$ 115 ea	\$ 130 ea
BZ-SS	Bezel: Brushed Stainless Steel	\$ 65 ea	\$ 75 ea
EXTN RACK 24	Full Extension Rack for 24” Freestanding Ranges & Wall Ovens	\$ 500	\$ 575
EXTN RACK 30	Full Extension Rack for 30” Freestanding Ranges & Wall Ovens	\$ 535	\$ 615
EXTN RACK 36	Full Extension Rack for 36” Freestanding Ranges & Wall Ovens	\$ 565	\$ 650
704406	Standard Oven Rack for 24” Freestanding Ranges & Wall Ovens	\$ 110	\$ 125
704405	Standard Oven Rack for 30” Freestanding Ranges & Wall Ovens	\$ 140	\$ 160
704402	Standard Oven Rack for 36” Freestanding Ranges & Wall Ovens	\$ 160	\$ 185
799211	30” Electric Wall Oven Baking Stone	\$ 375	\$ 430

# BROILERS: SALAMANDER BROILER

BlueStar Model Number Guide:			
<b>Base Model (PRZSAL24V2)</b> Natural Gas   Stainless Steel Finish   Standard Trim	<b>Change to LP Gas</b> Add (L) for LP/Propane Gas	<b>Add code below for desired color</b> Not available on Salamander models	<b>Add (PLT) for Plated Trim</b> Includes plated bezels, drawer handle, handle ends and logo. See available options below.



**FEATURES:**

- Heavy duty, commercial stainless steel construction
- Two independently controlled infrared ceramic burners
- Powerful 18,500 BTUs
- 215 square inches of cooking space
- Large removable heavy-duty grilling rack
- Automatic electronic ignition and re-ignition system

**PRODUCT SPECIFICATIONS:**

- Front Burner Power: 11,000 BTUs
- Rear Burner Power: 7,500 BTUs

Model	Description (* Denotes item that must be specified)	UMRP	MSRP
<b>Natural Gas Models: 24" Salamander Broiler</b>			
PRZSAL24V2	Nat Gas   Stainless Steel   Standard Trim	\$ 5,495	\$ 6,320
PRZSAL24V2PLT	Nat Gas   Stainless Steel   Plated Trim*	\$ 6,540	\$ 7,520
<b>LP/Propane Models: 24" Salamander Broiler</b>			
PRZSAL24V2L	LP Gas   Stainless Steel   Standard Trim	\$ 5,495	\$ 6,320
PRZSAL24V2LPLT	LP Gas   Stainless Steel   Plated Trim*	\$ 6,540	\$ 7,520
<b>WALL MOUNTS: (Sold separately – Salamander NOT included)</b>			
PRZSALWM	24" Wall Mount (No Shelf) – Salamander Not Included	\$ 1,305	\$ 1,500
PRZSAL36WM	36" Wall Mount w/ Shelf – Salamander Not Included	\$ 2,615	\$ 3,005
PRZSAL48WM	48" Wall Mount w/ Shelf – Salamander Not Included	\$ 3,525	\$ 4,055
PRZSAL60WM	60" Wall Mount w/ Shelf – Salamander Not Included	\$ 3,920	\$ 4,510
<b>KNOB OPTIONS: (Total Knobs: 2)</b>			
KN-C	Knob: Standard 190 RAL Color	\$ 115 ea	\$ 130 ea
KN-CF	Knob: Spec Finish (Matte RAL, Textured RAL or Prec Metals)	\$ 185 ea	\$ 215 ea
KN-CC	Knob: Custom Color (Must be ordered with Custom Color Match Range, Refrigerator or Ventilation Hood)	\$ 200 ea	\$ 230 ea
KN-PLT	Knob: Plated Trim (See options below)	\$ 250 ea	\$ 290 ea
BZ-C	Bezel: Standard 190 RAL Color	\$ 65 ea	\$ 75 ea
<b>PLATED TRIM OPTIONS: (Includes bezels, drawer handle, handle ends and logo)</b>			
Antique Brass, Brushed Brass, Polished Brass, Antique Copper, Brushed Copper, Polished Copper, Chrome, Oil Rubbed Bronze & Pewter			

**WALL MOUNT SPECIFICATIONS:**

**24" Wall Mount (No Shelf)**

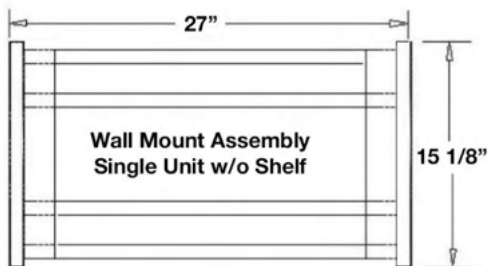

**36", 48" & 60" Wall Mount with Shelf**

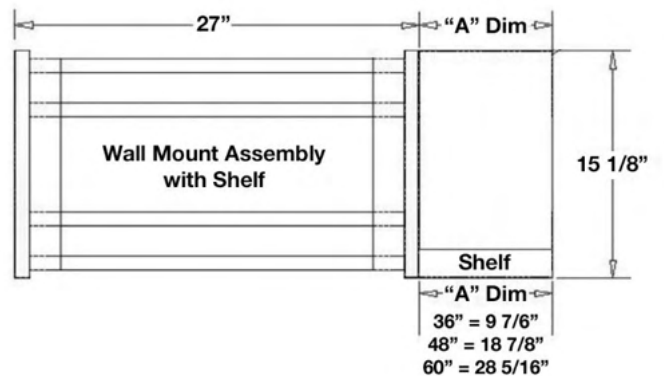

*Note: Wall Mount can only be mounted on left side of assembly.*



# REFRIGERATION

Get the Look: Panel Ready 30" Column Refrigerator & 18" Column Freezer

## REFRIGERATION: 36" PRO BUILT-IN REFRIGERATOR

BlueStar Model Number Guide:		
<b>Base Model (BBB36R2)</b> Right Hinge   Stainless Steel Finish   Standard Trim	<b>Add code below for desired color</b> (C) 190 Standard RAL (Semi-Gloss) Colors (CF) Specialty Finish (190 Matte RAL, Precious Metals & Textures) (CC) Custom Colors	<b>Add (PLT) for Plated Trim</b> Includes door handle, handle end and logo. See available options below.



Model Shown: BBB36R2



Model Shown: BBB36L2

Model	Description (* Denotes item that must be specified)	UMRP	MSRP
<b>36" Pro Built-In Refrigerator/Freezer – RIGHT HINGE</b>			
BBB36R2	Right Hinge   Stainless Steel   Standard Trim	\$ 13,295	\$ 15,290
BBB36R2PLT	Right Hinge   Stainless Steel   Plated Trim*	\$ 14,590	\$ 16,780
BBB36R2C	Right Hinge   Std RAL Color*   Standard Trim	\$ 14,690	\$ 16,895
BBB36R2CPLT	Right Hinge   Std RAL Color*   Plated Trim*	\$ 15,985	\$ 18,385
BBB36R2CF	Right Hinge   Specialty Finish*   Standard Trim	\$ 15,190	\$ 17,470
BBB36R2CFPLT	Right Hinge   Specialty Finish*   Plated Trim*	\$ 16,485	\$ 18,960
BBB36R2CC	Right Hinge   Custom Color*   Standard Trim	\$ 16,490	\$ 18,965
BBB36R2CCPLT	Right Hinge   Custom Color*   Plated Trim*	\$ 17,785	\$ 20,455
<b>36" Pro Built-In Refrigerator/Freezer – LEFT HINGE</b>			
BBB36L2	Left Hinge   Stainless Steel   Standard Trim	\$ 13,295	\$ 15,290
BBB36L2PLT	Left Hinge   Stainless Steel   Plated Trim*	\$ 14,590	\$ 16,780
BBB36L2C	Left Hinge   Std RAL Color*   Standard Trim	\$ 14,690	\$ 16,895
BBB36L2CPLT	Left Hinge   Std RAL Color*   Plated Trim*	\$ 15,985	\$ 18,385
BBB36L2CF	Left Hinge   Specialty Finish*   Standard Trim	\$ 15,190	\$ 17,470
BBB36L2CFPLT	Left Hinge   Specialty Finish*   Plated Trim*	\$ 16,485	\$ 18,960
BBB36L2CC	Left Hinge   Custom Color*   Standard Trim	\$ 16,490	\$ 18,965
BBB36L2CCPLT	Left Hinge   Custom Color*   Plated Trim*	\$ 17,785	\$ 20,455
<b>ADDITIONAL OPTIONS:</b>			
PAINT REFR GRILL	Painted Top Grill on Built-In Refrigerator	\$ 225	\$ 260
799338 – 36 REFR	90 Degree Pin Stops (*Must be specified on order*)	\$ 35	\$ 40
<b>ACCESSORIES AVAILABLE SEPARATELY:</b>			
799339	Plastic Ice Bin	\$ 115	\$ 130
799627	Ice Scoop	\$ 35	\$ 40
799438	Replacement Water Filter	\$ 85	\$ 100
799700	Replacement Air Filter	\$ 45	\$ 50
950128	Perimeter Trim	N/C	N/C
RSK-950034	42" Refrigerator Handle Assembly, Stainless Steel	\$ 185	\$ 215
RSK-950034PLT	42" Refrigerator Handle Assembly, Plated *	\$ 385	\$ 445
RSK-950035	32" Freezer Handle Assembly, Stainless Steel	\$ 185	\$ 215
RSK-950035PLT	32" Freezer Handle Assembly, Plated *	\$ 385	\$ 445
<b>PLATED TRIM OPTIONS: (Includes door handle, handle ends and logo)</b>			
Antique Brass, Brushed Brass, Polished Brass, Antique Copper, Brushed Copper, Polished Copper, Chrome, Oil Rubbed Bronze & Pewter			

**FEATURES:**

- All Stainless Steel and Glass Interiors
- Dual Compressors
- Oversized Capacity
- Fits Commercial Size Sheet Tray: Refrigerator/Freezer
- Ramp-on LED Lighting
- 1,000+ Color Options
- Automatic Ice Maker
- Designed and Manufactured in USA
- Iron Clad Warranty: 2 years (full), 5 years (sealed system parts & labor) and 13 years (sealed system parts)
- Unit weight: 783 lbs.

## REFRIGERATION: 36" PRO BUILT-IN FRENCH DOOR REFRIGERATOR/FREEZER

BlueStar Model Number Guide:		
<b>Base Model (BBF361)</b> French Door   Stainless Steel Finish   Standard Trim	<b>Add code below for desired color</b> (C) 190 Standard RAL (Semi-Gloss) Colors (CF) Specialty Finish (190 Matte RAL, Precious Metals & Textures) (CC) Custom Colors	<b>Add (PLT) for Plated Trim</b> Includes door handle, handle end and logo. See available options below.



Model	Description (* Denotes item that must be specified)	UMRP	MSRP
<b>36" Pro French Door Built-in Refrigerator/Freezer</b>			
BBBF361	French Door   Stainless Steel   Standard Trim	\$ 13,795	\$ 15,865
BBBF361PLT	French Door   Stainless Steel   Plated Trim*	\$ 15,290	\$ 17,585
BBBF361C	French Door   Std RAL Color*   Standard Trim	\$ 15,290	\$ 17,585
BBBF361CPLT	French Door   Std RAL Color*   Plated Trim*	\$ 16,785	\$ 19,305
BBBF361CF	French Door   Specialty Finish*   Standard Trim	\$ 15,790	\$ 18,160
BBBF361CFPLT	French Door   Specialty Finish*   Plated Trim*	\$ 17,285	\$ 19,880
BBBF361CC	French Door   Custom Color*   Standard Trim	\$ 16,990	\$ 19,540
BBBF361CCPLT	French Door   Custom Color*   Plated Trim*	\$ 18,485	\$ 21,260
<b>ADDITIONAL OPTIONS:</b>			
PAINT REFR GRILL	Painted Top Grill on Built-In Refrigerator	\$ 225	\$ 260
799338 – 36 REFR FD	90 Degree Pin Stops (*Must be specified on order*)	\$ 65	\$ 75
<b>ACCESSORIES AVAILABLE SEPARATELY:</b>			
799339	Plastic Ice Bin	\$ 115	\$ 130
799627	Ice Scoop	\$ 35	\$ 40
799438	Replacement Water Filter	\$ 85	\$ 100
799700	Replacement Air Filter	\$ 45	\$ 50
950128	Perimeter Trim	N/C	N/C
RSK-950034	42" Refrigerator Handle Assembly, Stainless Steel	\$ 185	\$ 215
RSK-950034PLT	42" Refrigerator Handle Assembly, Plated *	\$ 385	\$ 445
RSK-950035	32" Freezer Handle Assembly, Stainless Steel	\$ 185	\$ 215
RSK-950035PLT	32" Freezer Handle Assembly, Plated *	\$ 385	\$ 445
<b>PLATED TRIM OPTIONS: (Includes door handle, handle ends and logo)</b>			
Antique Brass, Brushed Brass, Polished Brass, Antique Copper, Brushed Copper, Polished Copper, Chrome, Oil Rubbed Bronze & Pewter			

**FEATURES:**

- All Stainless Steel and Glass Interiors
- Dual Compressors
- Oversized 22.4 cu. ft. Capacity
- Fits Commercial Size Sheet Tray: Refrigerator/Freezer
- Heavy Duty Construction
- Ramp-on LED Lighting
- 1,000+ Color Options
- Automatic Ice Maker
- Designed and Manufactured in USA
- Iron Clad Warranty: 2 years (full), 5 years (sealed system parts & labor) and 13 years (sealed system parts)
- Unit weight: 783 lbs.

## REFRIGERATOR: 30" COLUMN REFRIGERATOR

BlueStar Model Number Guide:		
<b>Base Model (BIR30R0)</b> Right Hinge   Stainless Steel Finish   Standard Trim	<b>Add code below for desired color</b> (C) 190 Standard RAL (Semi-Gloss) Colors (CF) Specialty Finish (190 Matte RAL, Precious Metals & Textures) (CC) Custom Colors	<b>Add (PLT) for Plated Trim</b> Includes door handle, handle end and logo. See available options below.



Model Shown: BIR30R0

**FEATURES:**

- Industry-leading 17.44 cu. Ft. capacity
- Available in panel-ready, stainless steel or your choice of 1,000+ colors and 10 metal trims
- Flush installation
- Advanced temperature control for longer food preservation
- Extra-bright LED lighting
- Fully extending crisper drawers
- Slide-out tray that fits sheet pan
- Touch screen control with Sabbath & Shopping modes
- Iron Clad Warranty: 2 years (full), 5 years (sealed system parts & labor) and 13 years (sealed system parts)
- Unit weight: 445 lbs.

**COLUMN JOINING KITS**

Joining Kits (#700523) ship automatically with all freezer units. Contains a filler strip to conceal joint between refrigerator and freezer columns & a toe kick finish trim piece to join the two toe kick grills. Joining Kits and Toe Kick Filler Piece for side by side refrigeration units sold separately.

**PLATED TRIM OPTIONS:**

**(Includes door handle, handle ends and logo)**  
 Antique Brass, Brushed Brass, Polished Brass, Antique Copper, Brushed Copper, Polished Copper, Chrome, Oil Rubbed Bronze & Pewter

Model	Description (* Denotes item that must be specified)	UMRP	MSRP
<b>30" Column Refrigerator – RIGHT HINGE</b>			
BIRP30R0	Right Hinge   Panel Ready	\$ 8,595	\$ 9,885
BIR30R0	Right Hinge   Stainless Steel   Standard Trim	\$ 9,495	\$ 10,920
BIR30R0PLT	Right Hinge   Stainless Steel   Plated Trim*	\$ 10,590	\$ 12,180
BIR30R0C	Right Hinge   Std RAL Color*   Standard Trim	\$ 10,790	\$ 12,410
BIR30R0CPLT	Right Hinge   Std RAL Color*   Plated Trim*	\$ 11,885	\$ 13,670
BIR30R0CF	Right Hinge   Specialty Finish*   Standard Trim	\$ 11,390	\$ 13,100
BIR30R0CFPLT	Right Hinge   Specialty Finish*   Plated Trim*	\$ 12,485	\$ 14,360
BIR30R0CC	Right Hinge   Custom Color*   Standard Trim	\$ 12,690	\$ 14,595
BIR30R0CCPLT	Right Hinge   Custom Color*   Plated Trim*	\$ 13,785	\$ 15,855
<b>30" Column Refrigerator – LEFT HINGE</b>			
BIRP30L0	Left Hinge   Panel Ready	\$ 8,595	\$ 9,885
BIR30L0	Left Hinge   Stainless Steel   Standard Trim	\$ 9,495	\$ 10,920
BIR30L0PLT	Left Hinge   Stainless Steel   Plated Trim*	\$ 10,590	\$ 12,180
BIR30L0C	Left Hinge   Std RAL Color*   Standard Trim	\$ 10,790	\$ 12,410
BIR30L0CPLT	Left Hinge   Std RAL Color*   Plated Trim*	\$ 11,885	\$ 13,670
BIR30L0CF	Left Hinge   Specialty Finish*   Standard Trim	\$ 11,390	\$ 13,100
BIR30L0CFPLT	Left Hinge   Specialty Finish*   Plated Trim*	\$ 12,485	\$ 14,360
BIR30L0CC	Left Hinge   Custom Color*   Standard Trim	\$ 12,690	\$ 14,595
BIR30L0CCPLT	Left Hinge   Custom Color*   Plated Trim*	\$ 13,785	\$ 15,855
<b>Additional Options: (**) Painted Toe-Kick Grills Require Painted Column Unit</b>			
798803	Painted Toe-Kick Grill 30" **	\$ 215	\$ 245
950325	60" Continuous Toe Kick –Stainless Clad Column	\$ 825	\$ 950
950326	54" Continuous Toe Kick –Stainless Clad Column	\$ 800	\$ 920
950327	48" Continuous Toe Kick –Stainless Clad Column	\$ 800	\$ 920
950328	42" Continuous Toe Kick –Stainless Clad Column	\$ 775	\$ 890
950325C	60" Continuous Toe Kick – Painted**	\$ 1,040	\$ 1,195
950326C	54" Continuous Toe Kick – Painted **	\$ 1,015	\$ 1,165
950327C	48" Continuous Toe Kick – Painted **	\$ 1,015	\$ 1,165
950328C	42" Continuous Toe Kick – Painted **	\$ 990	\$ 1,140
700523	Column Joining Kit (Required for two column units to be joined – ships automatically with all freezer units)	\$ 145	\$ 165
700622	Toe Kick Filler Piece Only (Ships automatically with Column Joining Kit (#700523))	\$ 50	\$ 60
RSK-1000083	36" Column Handle Assembly, Brushed Stainless Steel	\$ 185	\$ 215
RSK-1000083PLT	36" Column Handle Assembly, Plated *	\$ 385	\$ 445
700588	90 Degree Pin   Right Door Hinges **	\$ 375	\$ 430
700589	90 Degree Pin   Left Door Hinges **	\$ 375	\$ 430
<b>** 90 Degree Pins must be specified at time of order. They can not be added after installation.</b>			

# REFRIGERATOR: 24" COLUMN REFRIGERATOR

BlueStar Model Number Guide:		
<b>Base Model (BIR30R0)</b> Right Hinge   Stainless Steel Finish   Standard Trim	<b>Add code below for desired color</b> (C) 190 Standard RAL (Semi-Gloss) Colors (CF) Specialty Finish (190 Matte RAL, Precious Metals & Textures) (CC) Custom Colors	<b>Add (PLT) for Plated Trim</b> Includes door handle, handle end and logo. See available options below.



Model Shown: BIR24R0

**FEATURES:**

- Over-sized 12.99 cu. ft. capacity
- Available in panel-ready, stainless steel or your choice of 1,000+ colors and 10 metal trims
- Flush installation
- Advanced temperature control for longer food preservation
- Extra-bright LED lighting
- Fully extending crisper drawers
- Slide-out tray that fits sheet pan
- Touch screen control with Sabbath & Shopping modes
- Iron Clad Warranty: 2 years (full), 5 years (sealed system parts & labor) and 13 years (sealed system parts)
- Unit weight: 364 lbs.

**COLUMN JOINING KITS**

Joining Kits (#700523) ship automatically with all freezer units. Contains a filler strip to conceal joint between refrigerator and freezer columns & a toe kick finish trim piece to join the two toe kick grills. Joining Kits and Toe Kick Filler Piece for side by side refrigeration units sold separately.

**PLATED TRIM OPTIONS:**

**(Includes door handle, handle ends and logo)**  
 Antique Brass, Brushed Brass, Polished Brass, Antique Copper, Brushed Copper, Polished Copper, Chrome, Oil Rubbed Bronze & Pewter

Model	Description (* Denotes item that must be specified)	UMRP	MSRP
<b>24" Column Refrigerator – RIGHT HINGE</b>			
BIRP24R0	Right Hinge   Panel Ready	\$ 8,195	\$ 9,425
BIR24R0	Right Hinge   Stainless Steel   Standard Trim	\$ 8,895	\$ 10,230
BIR24R0PLT	Right Hinge   Stainless Steel   Plated Trim*	\$ 9,990	\$ 11,490
BIR24R0C	Right Hinge   Std RAL Color*   Standard Trim	\$ 9,890	\$ 11,375
BIR24R0CPLT	Right Hinge   Std RAL Color*   Plated Trim*	\$ 10,985	\$ 12,635
BIR24R0CF	Right Hinge   Specialty Finish*   Standard Trim	\$ 10,390	\$ 11,950
BIR24R0CFPLT	Right Hinge   Specialty Finish*   Plated Trim*	\$ 11,485	\$ 13,210
BIR24R0CC	Right Hinge   Custom Color*   Standard Trim	\$ 11,690	\$ 13,445
BIR24R0CCPLT	Right Hinge   Custom Color*   Plated Trim*	\$ 12,785	\$ 14,705
<b>24" Column Refrigerator – LEFT HINGE</b>			
BIRP24L0	Left Hinge   Panel Ready	\$ 8,195	\$ 9,425
BIR24L0	Left Hinge   Stainless Steel   Standard Trim	\$ 8,895	\$ 10,230
BIR24L0PLT	Left Hinge   Stainless Steel   Plated Trim*	\$ 9,990	\$ 11,490
BIR24L0C	Left Hinge   Std RAL Color*   Standard Trim	\$ 9,890	\$ 11,375
BIR24L0CPLT	Left Hinge   Std RAL Color*   Plated Trim*	\$ 10,985	\$ 12,635
BIR24L0CF	Left Hinge   Specialty Finish*   Standard Trim	\$ 10,390	\$ 11,950
BIR24L0CFPLT	Left Hinge   Specialty Finish*   Plated Trim*	\$ 11,485	\$ 13,210
BIR24L0CC	Left Hinge   Custom Color*   Standard Trim	\$ 11,690	\$ 13,445
BIR24L0CCPLT	Left Hinge   Custom Color*   Plated Trim*	\$ 12,785	\$ 14,705
<b>Additional Options:</b>			
798804	Painted Toe-Kick Grill 24" (Note: Requires painted column unit)	\$ 215	\$ 245
950325	60" Continuous Toe Kick –Stainless Clad Column	\$ 825	\$ 950
950326	54" Continuous Toe Kick – Stainless Clad Column	\$ 800	\$ 920
950327	48" Continuous Toe Kick – Stainless Clad Column	\$ 800	\$ 920
950328	42" Continuous Toe Kick – Stainless Clad Column	\$ 775	\$ 890
950325C	60" Continuous Toe Kick – Painted**	\$ 1,040	\$ 1,195
950326C	54" Continuous Toe Kick – Painted **	\$ 1,015	\$ 1,165
950327C	48" Continuous Toe Kick – Painted **	\$ 1,015	\$ 1,165
950328C	42" Continuous Toe Kick – Painted **	\$ 990	\$ 1,140
700523	Column Joining Kit (Required for two column units to be joined – ships automatically with all freezer units)	\$ 145	\$ 165
700622	Toe Kick Filler Piece Only (Ships automatically with Column Joining Kit (#700523))	\$ 50	\$ 60
RSK-1000083	36" Column Handle Assembly, Brushed Stainless Steel	\$ 185	\$ 215
RSK-1000083PLT	36" Column Handle Assembly, Plated *	\$ 385	\$ 445
700588	90 Degree Pin   Right Door Hinges **	\$ 375	\$ 430
700589	90 Degree Pin   Left Door Hinges **	\$ 375	\$ 430
<b>** 90 Degree Pins must be specified at time of order. They can not be added after installation.</b>			

# REFRIGERATION : 30" COLUMN FREEZER

**BlueStar Model Number Guide:**

<p><b>Base Model (BIF30R0)</b> Right Hinge   Stainless Steel Finish   Standard Trim</p>	<p><b>Add code below for desired color</b> (C) 190 Standard RAL (Semi-Gloss) Colors (CF) Specialty Finish (190 Matte RAL, Precious Metals &amp; Textures) (CC) Custom Colors</p>	<p><b>Add (PLT) for Plated Trim</b> Includes door handle, handle end and logo. See available options below.</p>
---------------------------------------------------------------------------------------------	----------------------------------------------------------------------------------------------------------------------------------------------------------------------------------------------	-------------------------------------------------------------------------------------------------------------------------



Model Shown: BIF30R0

**FEATURES:**

- Industry-leading 16.84 cu. Ft. capacity
- Available in panel-ready, stainless steel or your choice of 1,000+ colors and 10 metal trims
- Flush installation
- Automatic ice maker with Super Ice function
- Extra-bright LED lighting
- Stainless steel full extension drawers
- Easy-to-use touch control panel
- Iron Clad Warranty: 2 years (full), 5 years (sealed system parts & labor) and 13 years (sealed system parts)
- Unit weight: 445 lbs.

**COLUMN JOINING KITS**

Joining Kits (#700523) ship automatically with all freezer units. Contains a filler strip to conceal joint between refrigerator and freezer columns & a toe kick finish trim piece to join the two toe kick grills. Joining Kits and Toe Kick Filler Piece for side by side refrigeration units sold separately.

**PLATED TRIM OPTIONS:**

**(Includes door handle, handle ends and logo)**  
Antique Brass, Brushed Brass, Polished Brass, Antique Copper, Brushed Copper, Polished Copper, Chrome, Oil Rubbed Bronze & Pewter

Model	Description (* Denotes item that must be specified)	UMRP	MSRP
<b>30" Column Freezer – RIGHT HINGE</b>			
BIFP30R0	Right Hinge   Panel Ready	\$ 8,595	\$ 9,885
BIF30R0	Right Hinge   Stainless Steel   Standard Trim	\$ 9,495	\$ 10,920
BIF30R0PLT	Right Hinge   Stainless Steel   Plated Trim*	\$ 10,590	\$ 12,180
BIF30R0C	Right Hinge   Std RAL Color*   Standard Trim	\$ 10,790	\$ 12,410
BIF30R0CPLT	Right Hinge   Std RAL Color*   Plated Trim*	\$ 11,885	\$ 13,670
BIF30R0CF	Right Hinge   Specialty Finish*   Standard Trim	\$ 11,390	\$ 13,100
BIF30R0CFPLT	Right Hinge   Specialty Finish*   Plated Trim*	\$ 12,485	\$ 14,360
BIF30R0CC	Right Hinge   Custom Color*   Standard Trim	\$ 12,690	\$ 14,360
BIF30R0CCPLT	Right Hinge   Custom Color*   Plated Trim*	\$ 13,785	\$ 15,855
<b>30" Column Freezer – LEFT HINGE</b>			
BIFP30L0	Left Hinge   Panel Ready	\$ 8,595	\$ 9,885
BIF30L0	Left Hinge   Stainless Steel   Standard Trim	\$ 9,495	\$ 10,920
BIF30L0PLT	Left Hinge   Stainless Steel   Plated Trim*	\$ 10,590	\$ 12,180
BIF30L0C	Left Hinge   Std RAL Color*   Standard Trim	\$ 10,790	\$ 12,410
BIF30L0CPLT	Left Hinge   Std RAL Color*   Plated Trim*	\$ 11,885	\$ 13,670
BIF30L0CF	Left Hinge   Specialty Finish*   Standard Trim	\$ 11,390	\$ 13,100
BIF30L0CFPLT	Left Hinge   Specialty Finish*   Plated Trim*	\$ 12,485	\$ 14,360
BIF30L0CC	Left Hinge   Custom Color*   Standard Trim	\$ 12,690	\$ 14,360
BIF30L0CCPLT	Left Hinge   Custom Color*   Plated Trim*	\$ 13,785	\$ 15,855
<b>Additional Options:</b>			
798803	Painted Toe-Kick Grill 30" (Note: Requires painted column unit)	\$ 215	\$ 245
950325	60" Continuous Toe Kick –Stainless Clad Column	\$ 825	\$ 950
950326	54" Continuous Toe Kick –Stainless Clad Column	\$ 800	\$ 920
950327	48" Continuous Toe Kick –Stainless Clad Column	\$ 800	\$ 920
950328	42" Continuous Toe Kick –Stainless Clad Column	\$ 775	\$ 890
950325C	60" Continuous Toe Kick – Painted**	\$ 1,040	\$ 1,195
950326C	54" Continuous Toe Kick – Painted **	\$ 1,015	\$ 1,165
950327C	48" Continuous Toe Kick – Painted **	\$ 1,015	\$ 1,165
950328C	42" Continuous Toe Kick – Painted **	\$ 990	\$ 1,140
700523	Column Joining Kit (Required for two column units to be joined – ships automatically with all freezer units)	\$ 145	\$ 165
700622	Toe Kick Filler Piece Only (Ships automatically with Column Joining Kit (#700523))	\$ 50	\$ 60
RSK-1000083	36" Column Handle Assembly, Brushed Stainless Steel	\$ 185	\$ 215
RSK-1000083PLT	36" Column Handle Assembly, Plated *	\$ 385	\$ 445
700588	90 Degree Pin   Right Door Hinges **	\$ 375	\$ 430
700589	90 Degree Pin   Left Door Hinges **	\$ 375	\$ 430
<b>** 90 Degree Pins must be specified at time of order. They can not be added after installation.</b>			

## REFRIGERATION : 24" COLUMN FREEZER

BlueStar Model Number Guide:		
<b>Base Model (BIF30R0)</b> Right Hinge   Stainless Steel Finish   Standard Trim	<b>Add code below for desired color</b> (C) 190 Standard RAL (Semi-Gloss) Colors (CF) Specialty Finish (190 Matte RAL, Precious Metals & Textures) (CC) Custom Colors	<b>Add (PLT) for Plated Trim</b> Includes door handle, handle end and logo. See available options below.



Model Shown: BIF24R0

**FEATURES:**

- Over-sized 12.64 cu. ft. capacity
- Available in panel-ready, stainless steel or your choice of 1,000+ colors and 10 metal trims
- Flush installation
- Automatic ice maker with Super Ice function
- Extra-bright LED lighting
- Stainless steel full extension drawers
- Easy-to-use touch control panel
- Iron Clad Warranty: 2 years (full), 5 years (sealed system parts & labor) and 13 years (sealed system parts)
- Unit weight: 364 lbs.

**COLUMN JOINING KITS**

Joining Kits (#700523) ship automatically with all freezer units. Contains a filler strip to conceal joint between refrigerator and freezer columns & a toe kick finish trim piece to join the two toe kick grills. Joining Kits and Toe Kick Filler Piece for side by side refrigeration units sold separately.

**PLATED TRIM OPTIONS:**

**(Includes door handle, handle ends and logo)**

Antique Brass, Brushed Brass, Polished Brass, Antique Copper, Brushed Copper, Polished Copper, Chrome, Oil Rubbed Bronze & Pewter

Model	Description (* Denotes item that must be specified)	UMRP	MSRP
<b>24" Column Freezer – RIGHT HINGE</b>			
BIFP24R0	Right Hinge   Panel Ready	\$ 8,195	\$ 9,425
BIF24R0	Right Hinge   Stainless Steel   Standard Trim	\$ 8,895	\$ 10,230
BIF24ROPLT	Right Hinge   Stainless Steel   Plated Trim*	\$ 9,990	\$ 11,490
BIF24ROC	Right Hinge   Std RAL Color*   Standard Trim	\$ 9,890	\$ 11,375
BIF24ROCPLT	Right Hinge   Std RAL Color*   Plated Trim*	\$ 10,985	\$ 12,635
BIF24ROCF	Right Hinge   Specialty Finish*   Standard Trim	\$ 10,390	\$ 11,950
BIF24ROCFPLT	Right Hinge   Specialty Finish*   Plated Trim*	\$ 11,485	\$ 13,210
BIF24ROCC	Right Hinge   Custom Color*   Standard Trim	\$ 11,690	\$ 13,445
BIF24ROCCPLT	Right Hinge   Custom Color*   Plated Trim*	\$ 12,785	\$ 17,705
<b>24" Column Freezer – LEFT HINGE</b>			
BIFP24L0	Left Hinge   Panel Ready	\$ 8,195	\$ 9,425
BIF24L0	Left Hinge   Stainless Steel   Standard Trim	\$ 8,895	\$ 10,230
BIF24LOPLT	Left Hinge   Stainless Steel   Plated Trim*	\$ 9,990	\$ 11,490
BIF24L0C	Left Hinge   Std RAL Color*   Standard Trim	\$ 9,890	\$ 11,375
BIF24L0CPLT	Left Hinge   Std RAL Color*   Plated Trim*	\$ 10,985	\$ 12,635
BIF24L0CF	Left Hinge   Specialty Finish*   Standard Trim	\$ 10,390	\$ 11,950
BIF24L0CFPLT	Left Hinge   Specialty Finish*   Plated Trim*	\$ 11,485	\$ 13,210
BIF24L0CC	Left Hinge   Custom Color*   Standard Trim	\$ 11,690	\$ 13,445
BIF24L0CCPLT	Left Hinge   Custom Color*   Plated Trim*	\$ 12,785	\$ 17,705
<b>Additional Options:</b>			
798804	Painted Toe-Kick Grill 24" (Note: Requires painted column unit)	\$ 215	\$ 245
950325	60" Continuous Toe Kick –Stainless Clad Column	\$ 825	\$ 950
950326	54" Continuous Toe Kick – Stainless Clad Column	\$ 800	\$ 920
950327	48" Continuous Toe Kick – Stainless Clad Column	\$ 800	\$ 920
950328	42" Continuous Toe Kick – Stainless Clad Column	\$ 775	\$ 890
950325C	60" Continuous Toe Kick – Painted**	\$ 1,040	\$ 1,195
950326C	54" Continuous Toe Kick – Painted **	\$ 1,015	\$ 1,165
950327C	48" Continuous Toe Kick – Painted **	\$ 1,015	\$ 1,165
950328C	42" Continuous Toe Kick – Painted **	\$ 990	\$ 1,140
700523	Column Joining Kit (Required for two column units to be joined – ships automatically with all freezer units)	\$ 145	\$ 165
700622	Toe Kick Filler Piece Only (Ships automatically with Column Joining Kit (#700523))	\$ 50	\$ 60
RSK-1000083	36" Column Handle Assembly, Brushed Stainless Steel	\$ 185	\$ 215
RSK-1000083PLT	36" Column Handle Assembly, Plated *	\$ 385	\$ 445
700588	90 Degree Pin   Right Door Hinges **	\$ 375	\$ 430
700589	90 Degree Pin   Left Door Hinges **	\$ 375	\$ 430
<b>** 90 Degree Pins must be specified at time of order. They can not be added after installation.</b>			

## REFRIGERATION : 18" COLUMN FREEZER

### BlueStar Model Number Guide:

<b>Base Model (BIF18R0)</b> Right Hinge   Stainless Steel Finish   Standard Trim	<b>Add code below for desired color</b> (C) 190 Standard RAL (Semi-Gloss) Colors (CF) Specialty Finish (190 Matte RAL, Precious Metals & Textures) (CC) Custom Colors	<b>Add (PLT) for Plated Trim</b> Includes door handle, handle end and logo. See available options below.
-------------------------------------------------------------------------------------	--------------------------------------------------------------------------------------------------------------------------------------------------------------------------------	----------------------------------------------------------------------------------------------------------------



Model Shown: BIF18R0

#### FEATURES:

- Over-sized 8.22 cu. ft. capacity
- Available in panel-ready, stainless steel or your choice of 1,000+ colors and 10 metal trims
- Flush installation
- Automatic ice maker with Super Ice function
- Extra-bright LED lighting
- Stainless steel full extension drawers
- Easy-to-use touch control panel
- Iron Clad Warranty: 2 years (full), 5 years (sealed system parts & labor) and 13 years (sealed system parts)
- Unit weight: 342 lbs.

#### COLUMN JOINING KITS

Joining Kits (#700523) ship automatically with all freezer units. Contains a filler strip to conceal joint between refrigerator and freezer columns & a toe kick finish trim piece to join the two toe kick grills. Joining Kits and Toe Kick Filler Piece for side by side refrigeration units sold separately.

#### PLATED TRIM OPTIONS:

**(Includes door handle, handle ends and logo)**

Antique Brass, Brushed Brass, Polished Brass, Antique Copper, Brushed Copper, Polished Copper, Chrome, Oil Rubbed Bronze & Pewter

Model	Description (* Denotes item that must be specified)	UMRP	MSRP
<b>18" Column Freezer – RIGHT HINGE</b>			
BIFP18R0	Right Hinge   Panel Ready	\$ 7,795	\$ 8,965
BIF18R0	Right Hinge   Stainless Steel   Standard Trim	\$ 8,395	\$ 9,655
BIF18R0PLT	Right Hinge   Stainless Steel   Plated Trim*	\$ 9,490	\$ 10,915
BIF18ROC	Right Hinge   Std RAL Color*   Standard Trim	\$ 9,390	\$ 10,800
BIF18ROCPLT	Right Hinge   Std RAL Color*   Plated Trim*	\$ 10,485	\$ 12,060
BIF18ROCF	Right Hinge   Specialty Finish*   Standard Trim	\$ 9,890	\$ 11,375
BIF18ROCFPLT	Right Hinge   Specialty Finish*   Plated Trim*	\$ 10,985	\$ 12,635
BIF18ROCC	Right Hinge   Custom Color*   Standard Trim	\$ 11,190	\$ 12,870
BIF18ROCCPLT	Right Hinge   Custom Color*   Plated Trim*	\$ 12,285	\$ 14,130
<b>18" Column Freezer – LEFT HINGE</b>			
BIFP18L0	Left Hinge   Panel Ready	\$ 7,795	\$ 8,965
BIF18L0	Left Hinge   Stainless Steel   Standard Trim	\$ 8,395	\$ 9,655
BIF18L0PLT	Left Hinge   Stainless Steel   Plated Trim*	\$ 9,490	\$ 10,915
BIF18L0C	Left Hinge   Std RAL Color*   Standard Trim	\$ 9,390	\$ 10,800
BIF18L0CPLT	Left Hinge   Std RAL Color*   Plated Trim*	\$ 10,485	\$ 12,060
BIF18LOCF	Left Hinge   Specialty Finish*   Standard Trim	\$ 9,890	\$ 11,375
BIF18LOCFPLT	Left Hinge   Specialty Finish*   Plated Trim*	\$ 10,985	\$ 12,635
BIF18LOCC	Left Hinge   Custom Color*   Standard Trim	\$ 11,190	\$ 12,870
BIF18LOCCPLT	Left Hinge   Custom Color*   Plated Trim*	\$ 12,285	\$ 14,130
<b>Additional Options:</b>			
798805	Painted Toe-Kick Grill 18" (Note: Requires painted column unit)	\$ 215	\$ 245
950325	60" Continuous Toe Kick –Stainless Clad Column	\$ 825	\$ 950
950326	54" Continuous Toe Kick –Stainless Clad Column	\$ 800	\$ 920
950327	48" Continuous Toe Kick –Stainless Clad Column	\$ 800	\$ 920
950328	42" Continuous Toe Kick –Stainless Clad Column	\$ 775	\$ 890
950325C	60" Continuous Toe Kick – Painted**	\$ 1,040	\$ 1,195
950326C	54" Continuous Toe Kick – Painted **	\$ 1,015	\$ 1,165
950327C	48" Continuous Toe Kick – Painted **	\$ 1,015	\$ 1,165
950328C	42" Continuous Toe Kick – Painted **	\$ 990	\$ 1,140
700523	Column Joining Kit (Required for two column units to be joined – ships automatically with all freezer units)	\$ 145	\$ 165
700622	Toe Kick Filler Piece Only (Ships automatically with Column Joining Kit (#700523))	\$ 50	\$ 60
RSK-1000083	36" Column Handle Assembly, Brushed Stainless Steel	\$ 185	\$ 215
RSK-1000083PLT	36" Column Handle Assembly, Plated *	\$ 385	\$ 445
700588	90 Degree Pin   Right Door Hinges **	\$ 375	\$ 430
700589	90 Degree Pin   Left Door Hinges **	\$ 375	\$ 430
<b>** 90 Degree Pins must be specified at time of order. They can not be added after installation.</b>			

## REFRIGERATION: 36" FREESTANDING COUNTER-DEPTH REFRIGERATOR WITH FREEZER

BlueStar Model Number Guide:		
<b>Base Model (FBFD360)</b> French Door   Stainless Steel Finish   Standard Trim	<b>Add code below for desired color</b> Not available on this model	<b>Add (PLT) for Plated Trim</b> Not available on this model



Model	Description (* Denotes item that must be specified)	UMRP	MSRP
<b>36" Freestanding Counter-Depth Refrigerator with Freezer</b>			
FBFD361	Freestanding   Stainless Steel   Standard Trim	\$ 4,295	\$ 4,940
Available only in Stainless Steel			

**FEATURES:**

- Counter depth with 19.9 cu-ft of capacity
- Automatic ice maker
- Internal water dispenser
- Electronic control
- Dual evaporator
- Unit weight: 355 lbs.

## DISHWASHER PANEL: 24" DISHWASHER PANEL

BlueStar Model Number Guide:		
<b>Base Model (DWBS24)</b> Stainless Steel Finish   Standard Trim	<b>Add code below for desired color</b> (C) 190 Standard RAL (Semi-Gloss) Colors (CF) Specialty Finish (190 Matte RAL, Precious Metals & Textures) (CC) Custom Colors	<b>Add (PLT) for Plated Trim</b> Includes plated bezels, door handle, handle ends and logo. See available options below.



**FEATURES:**

- Accommodates most major dishwasher brands
- Heavy-duty stainless steel construction
- Available in 1,000+ colors and finishes
- Plated trim options available

Model	Description (* Denotes item that must be specified)	UMRP	MSRP
<b>24" Dishwasher Panel</b>			
DWBS24	Stainless Steel   Standard Trim	\$ 865	\$ 995
DWBS24PLT	Stainless Steel   Plated Trim*	\$ 1,525	\$ 1,755
DWBS24C	Std RAL Color*   Standard Trim	\$ 1,340	\$ 1,540
DWBS24CPLT	Std RAL Color*   Plated Trim*	\$ 2,000	\$ 2,300
DWBS24CF	Specialty Finish*   Standard Trim	\$ 1,590	\$ 1,830
DWBS24CFPLT	Specialty Finish*   Plated Trim*	\$ 2,250	\$ 2,590
DWBS24CC	Custom Color*   Standard Trim	\$ 1,885	\$ 2,170
DWBS24CCPLT	Custom Color*   Plated Trim*	\$ 2,545	\$ 2,925
<b>PLATED TRIM OPTIONS: (Includes bezels, door handle, handle ends and logo)</b>			
Antique Brass, Brushed Brass, Polished Brass, Antique Copper, Brushed Copper, Polished Copper, Chrome, Oil Rubbed Bronze & Pewter			
<b>Accessories:</b>			
DSK-1000008	Handle Assembly Stainless Steel   RCS/RNB Handle Style	\$ 185	\$ 215
DSK-1000008PLT	Handle Assembly Plated *   RCS/RNB Handle Style	\$ 385	\$ 445
DSK-1000009	Handle Assembly Stainless Steel   BSP Handle Style	\$ 185	\$ 215
DSL-1000009PLT	Handle Assembly Plated *   BSP Handle Style	\$ 385	\$ 445



# VENTILATION: PROFESSIONAL SERIES

Get the Look: 30" Proline Vent Hood in Stainless Steel



# Choosing the Perfect Range Hood

## Everything You Need to Know

### 1. Select a Hood Style

Classic, Modern, Contemporary, Farmhouse, choose a hood style that fits best fits with your overall kitchen design.

### 2. Select Hood Width

The hood should be the same width as the cooking appliance below it, or up to 6" wider for maximum capture area.

### 3. Determine Total Hood Height

Ventilation Hoods should be installed 30" – 36" above the cooktop surface. Duct covers can fill any remaining space that the hood does not. See page 74 to determine if a duct cover is needed based on your ceiling height.

### 4. Calculate Hood Power Needed

Hood power is based on CFMs. To determine the CFMs needed, add the total BTU's of your cooking appliance (top burners + ovens), then divide by 150.

### 5. Choose Blower Type

In-hood, In-line and Remote blowers are available from 600 CFM's up to 1,400 CFM's.

### 6. Determine Blower Location

Your hood needs to exhaust through ducting which may be determined by existing ducting or architectural plans for a new build. First decide if this will occur through the top or rear of the hood. Then, install the correct size ducting for the shortest possible distance with the least 90 degree bends possible.

### 7. Customize Your Kitchen

Choose from over 1,000+ colors, finishes and designer metals. Accent with unlimited strapping configurations.

## DUCT COVER SELECTION GUIDE

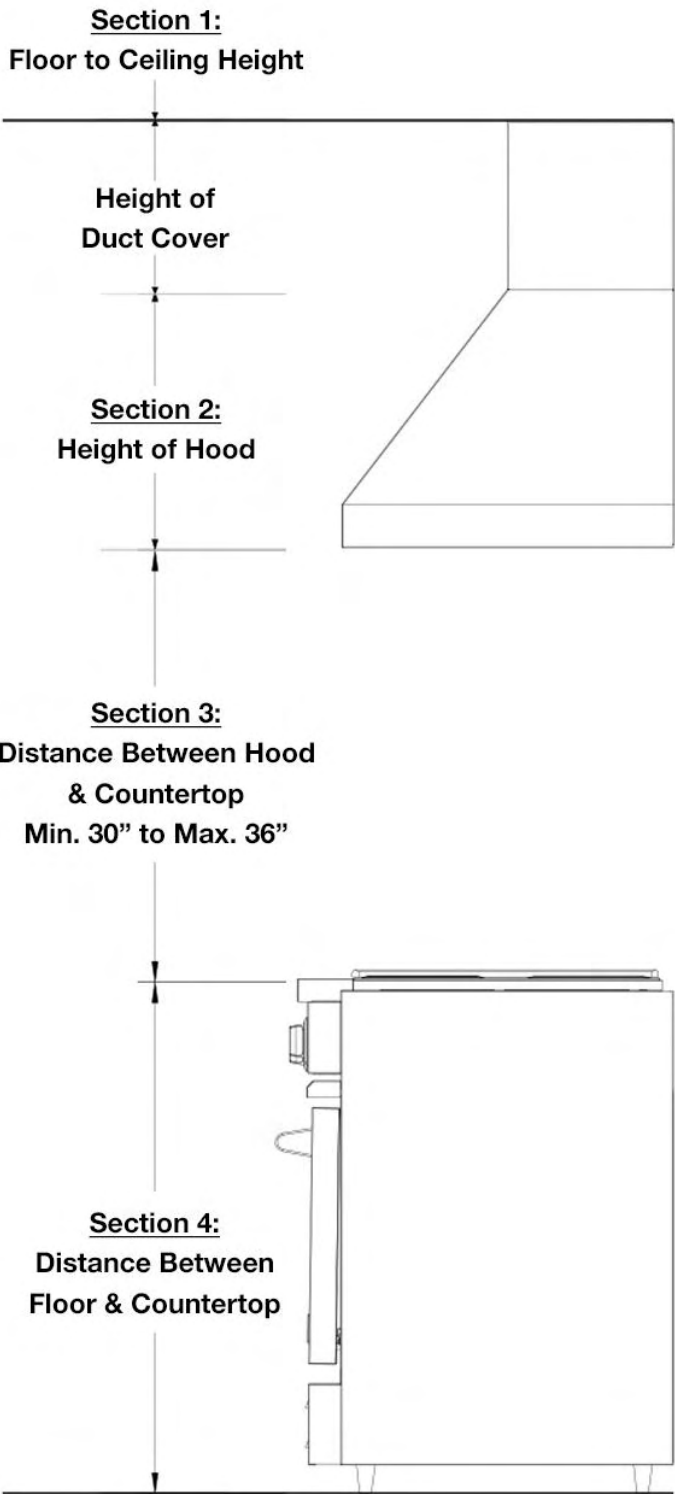

All measurements are to be calculated in inches

Section 1: Floor to Ceiling Height \_\_\_\_\_

**Subtract:**

Section 2: Height of Hood \_\_\_\_\_

Section 3: Distance Between Hood and Countertop \_\_\_\_\_  
(30" min. to 36" max)

Section 4: Distance Between Floor and Countertop \_\_\_\_\_

**Height of Duct Cover Needed:** \_\_\_\_\_

\* Ceiling height may be impacted by crown molding and/or soffit above the hood. Please account for this when calculating available floor to ceiling height

**Available Duct Covers:**

Page 76 Proline

Page 84 Hampton

Page 86 Manhattan (Wall Hoods)

Page 89 Bonanza

Page 94 Wrangler

Page 96 Manhattan (Island Hoods)

# PROFESSIONAL SERIES: PROLINE WALL HOOD

<b>BlueStar Model Number Guide:</b>	<b>Base Model (PLOXXML)</b> Proline   Unit Width   Internal Liner Type	<b>Add code below for desired color</b> (C) 190 Standard RAL (Semi-Gloss) Colors (CF) Specialty Finish (190 Matte RAL, Precious Metals & Textures) (CC) Custom Colors	<b>Add (PLT) for Metal Strapping</b> Available through custom quote only at <a href="mailto:quote@bluestarcooking.com">quote@bluestarcooking.com</a>
-------------------------------------	---------------------------------------------------------------------------	--------------------------------------------------------------------------------------------------------------------------------------------------------------------------------	------------------------------------------------------------------------------------------------------------------------------------------------------------



Standard Height: 18" | Standard Depth: 24"

**FEATURES:**

- Professional-grade performance with three exhaust settings and new Boost feature
- Whisper quiet operation
- Heavy duty, commercial grade materials
- Dimmable LED lighting
- Easy-to-use push-button controls
- Innovative, multi-stage grease capture system
- Stainless baffle filters seamlessly remove for easy dishwasher cleaning
- Choose from stainless steel or 1,000+ colors and finishes
- Simple installation
- 30" & 36" models: 600 CFM internal fan included **(Must be included on order)**
- Available with top or rear discharge - Discharge is field reversible.
- Duct free recirculating kits available for 30", 36", 42" & 48" models (Sold separately – Max. 600CFM)
- In-line, in-hood and remote blower compatible
- Note: Features on 24" models may vary

**CUSTOMIZATION OPTIONS:**

1,000+ Colors & Finishes

Model	Description (* Denotes item that must be specified)	UMRP	MSRP
PL030ML	30" Proline   Stainless Steel   600 CFM Blower	\$ 2,455	\$ 2,825
PL030MLC	30" Proline   Std RAL Color*   600 CFM Blower	\$ 3,550	\$ 4,080
PL030MLCF	30" Proline   Specialty Finish*   600 CFM Blower	\$ 4,540	\$ 5,220
PL030MLCC	30" Proline   Custom Color*   600 CFM Blower	\$ 5,970	\$ 6,865
PL036ML	36" Proline   Stainless Steel   600 CFM Blower	\$ 2,575	\$ 2,960
PL036MLC	36" Proline   Std RAL Color*   600 CFM Blower	\$ 3,670	\$ 4,220
PL036MLCF	36" Proline   Specialty Finish*   600 CFM Blower	\$ 4,660	\$ 5,360
PL036MLCC	36" Proline   Custom Color*   600 CFM Blower	\$ 6,090	\$ 7,005
PL042ML	42" Proline   Stainless Steel	\$ 2,825	\$ 3,250
PL042MLC	42" Proline   Std RAL Color*	\$ 4,250	\$ 4,890
PL042MLCF	42" Proline   Specialty Finish*	\$ 5,350	\$ 6,150
PL042MLCC	42" Proline   Custom Color*	\$ 6,780	\$ 7,795
PL048ML	48" Proline   Stainless Steel	\$ 3,070	\$ 3,530
PL048MLC	48" Proline   Std RAL Color*	\$ 4,495	\$ 5,170
PL048MLCF	48" Proline   Specialty Finish*	\$ 5,595	\$ 6,435
PL048MLCC	48" Proline   Custom Color*	\$ 7,025	\$ 8,080
PL054ML	54" Proline   Stainless Steel	\$ 3,190	\$ 3,670
PL054MLC	54" Proline   Std RAL Color*	\$ 4,615	\$ 5,305
PL054MLCF	54" Proline   Specialty Finish*	\$ 5,715	\$ 6,570
PL054MLCC	54" Proline   Custom Color*	\$ 7,145	\$ 8,215
PL060ML	60" Proline   Stainless Steel	\$ 3,440	\$ 3,955
PL060MLC	60" Proline   Std RAL Color*	\$ 4,865	\$ 5,595
PL060MLCF	60" Proline   Specialty Finish*	\$ 5,965	\$ 6,860
PL060MLCC	60" Proline   Custom Color*	\$ 7,395	\$ 8,505
PL066ML	66" Proline   Stainless Steel	\$ 3,685	\$ 4,240
PL066MLC	66" Proline   Std RAL Color*	\$ 5,110	\$ 5,875
PL066MLCF	66" Proline   Specialty Finish*	\$ 6,210	\$ 7,140
PL066MLCC	66" Proline   Custom Color*	\$ 7,640	\$ 8,785

**VENTILATION HOOD ACCESSORIES:**

Refer to page 76 for all Proline hood duct cover options  
 See page 80 for Duct Free Kits (Duct cover can not be installed with Duct Free Kits)  
 Refer to page 102 for Ventilation Hood Accessories

BLOWER OPTIONS	IN-HOOD		IN-LINE		REMOTE		DISCHARGE	
CFM POWER	600	1200	800	1200	1000	1400	TOP	REAR
MODEL #	BS-CFM-600-IN06	BS-CFM-1200-IN12	ATEX-0.8	ATEX-1.2	HYEX-1.0-GA	HYEX-1.4-GA		
UMRP	\$ 965	\$ 1,385	\$ 1,260	\$ 1,510	\$ 1,385	\$ 1,640	Available at time of order	
PL030ML	•		•	•	•	•		
PL036ML	•	•	•	•	•	•		
PL042ML	•	•	•	•	•	•		
PL048ML	•	•	•	•	•	•		
PL054ML	•	•	•	•	•	•		
PL060ML	•	•	•	•	•	•		
PL066ML	•	•	•	•	•	•		

## DUCT COVERS: PROLINE WALL HOODS

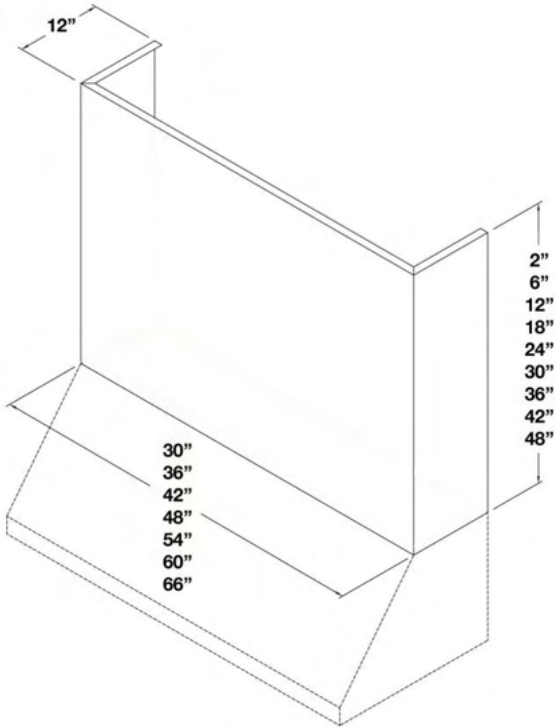

SIZE	MODEL	HEIGHT	UMRP	MSRP
Available Duct Covers for 30" Models	DCSW03002	2"	\$ 550	\$ 635
	DCSW03006	6"	\$ 550	\$ 635
	DCSW03012	12"	\$ 550	\$ 635
	DCSW03018	18"	\$ 550	\$ 635
	DCSW03024	24"	\$ 550	\$ 635
	DCSW03030	30"	\$ 550	\$ 635
	DCSW03036	36"	\$ 550	\$ 635
	DCSW03042	42"	\$ 550	\$ 635
	DCSW03048	48"	\$ 550	\$ 635
Available Duct Covers for 36" Models	DCSW03602	2"	\$ 550	\$ 635
	DCSW03606	6"	\$ 550	\$ 635
	DCSW03612	12"	\$ 575	\$ 660
	DCSW03618	18"	\$ 575	\$ 660
	DCSW03624	24"	\$ 575	\$ 660
	DCSW03630	30"	\$ 575	\$ 660
	DCSW03636	36"	\$ 575	\$ 660
	DCSW03642	42"	\$ 575	\$ 660
	DCSW03648	48"	\$ 575	\$ 660
Available Duct Covers for 42" Models	DCSW04202	2"	\$ 575	\$ 660
	DCSW04206	6"	\$ 575	\$ 660
	DCSW04212	12"	\$ 620	\$ 715
	DCSW04218	18"	\$ 620	\$ 715

SIZE	MODEL	HEIGHT	UMRP	MSRP
Available Duct Covers for 42" Models	DCSW04224	24"	\$ 620	\$ 715
	DCSW04230	30"	\$ 620	\$ 715
	DCSW04236	36"	\$ 620	\$ 715
	DCSW04242	42"	\$ 620	\$ 715
	DCSW04248	48"	\$ 620	\$ 715
Available Duct Covers for 48" Models	DCSW04802	2"	\$ 620	\$ 715
	DCSW04806	6"	\$ 620	\$ 715
	DCSW04812	12"	\$ 690	\$ 795
	DCSW04818	18"	\$ 690	\$ 795
	DCSW04824	24"	\$ 690	\$ 795
	DCSW04830	30"	\$ 690	\$ 795
	DCSW04836	36"	\$ 690	\$ 795
	DCSW04842	42"	\$ 690	\$ 795
	DCSW04848	48"	\$ 690	\$ 795
Available Duct Covers for 54" Models	DCSW05402	2"	\$ 690	\$ 795
	DCSW05406	6"	\$ 690	\$ 795
	DCSW05412	12"	\$ 715	\$ 820
	DCSW05418	18"	\$ 715	\$ 820
	DCSW05424	24"	\$ 715	\$ 820
	DCSW05430	30"	\$ 715	\$ 820
	DCSW05436	36"	\$ 715	\$ 820
Available Duct Covers for 60" Models	DCSW06002	2"	\$ 715	\$ 820
	DCSW06006	6"	\$ 715	\$ 820
	DCSW06012	12"	\$ 830	\$ 955
	DCSW06018	18"	\$ 830	\$ 955
	DCSW06024	24"	\$ 830	\$ 955
	DCSW06030	30"	\$ 830	\$ 955
	DCSW06036	36"	\$ 830	\$ 955
	DCSW06042	42"	\$ 830	\$ 955
	DCSW06048	48"	\$ 830	\$ 955
	Available Duct Covers for 66" Models	DCSW06602	2"	\$ 830
DCSW06606		6"	\$ 830	\$ 955
DCSW06612		12"	\$ 855	\$ 985
DCSW06618		18"	\$ 855	\$ 985
DCSW06624		24"	\$ 855	\$ 985
DCSW06630		30"	\$ 855	\$ 985
DCSW06636		36"	\$ 855	\$ 985
DCSW06642		42"	\$ 855	\$ 985

# PROFESSIONAL SERIES: PYRAMID WALL HOOD

<b>BlueStar Model Number Guide:</b>	<b>Base Model (PYOXXML)</b> Pyramid   Unit Width   Internal Liner Type	<b>Add code below for desired color</b> (C) 190 Standard RAL (Semi-Gloss) Colors (CF) Specialty Finish (190 Matte RAL, Precious Metals & Textures) (CC) Custom Colors	<b>Add (PLT) for Metal Strapping</b> Not available on this model
-------------------------------------	---------------------------------------------------------------------------	--------------------------------------------------------------------------------------------------------------------------------------------------------------------------------	---------------------------------------------------------------------



Standard Height without duct: 18" | Standard Depth: 24"

**FEATURES:**

- Professional-grade performance with three exhaust settings and new Boost feature
- Whisper quiet operation
- Heavy duty, commercial grade materials
- Dimmable LED lighting
- Easy-to-use push-button controls
- Innovative, multi-stage grease capture system
- Stainless baffle filters seamlessly remove for easy dishwasher cleaning
- Available with top or rear discharge - Discharge is field reversible.
- 30" & 36" models: 600 CFM internal fan included **(Must be included on order)**
- **Telescopic Duct DCTWxxS included.** Additional sizes available (Sold separately)
- Duct free recirculating kits available for 30", 36", 42" & 48" models (Sold separately)
- In-line, in-hood and remote blower compatible

**CUSTOMIZATION OPTIONS:**

1,000+ Colors & Finishes

Model	Description (* Denotes item that must be specified)	UMRP	MSRP
PY030ML	30" Pyramid   Stainless Steel   600 CFM Blower	\$ 2,575	\$ 2,960
PY030MLC	30" Pyramid   Std RAL Color*   600 CFM Blower	\$ 3,670	\$ 4,220
PY030MLCF	30" Pyramid   Specialty Finish*   600 CFM Blower	\$ 4,660	\$ 5,360
PY030MLCC	30" Pyramid   Custom Color*   600 CFM Blower	\$ 6,090	\$ 7,005
PY036ML	36" Pyramid   Stainless Steel   600 CFM Blower	\$ 3,190	\$ 3,670
PY036MLC	36" Pyramid   Std RAL Color*   600 CFM Blower	\$ 4,285	\$ 4,930
PY036MLCF	36" Pyramid   Specialty Finish*   600 CFM Blower	\$ 5,275	\$ 6,065
PY036MLCC	36" Pyramid   Custom Color*   600 CFM Blower	\$ 6,705	\$ 7,710
PY042ML	42" Pyramid   Stainless Steel	\$ 3,320	\$ 3,820
PY042MLC	42" Pyramid   Std RAL Color*	\$ 4,745	\$ 5,455
PY042MLCF	42" Pyramid   Specialty Finish*	\$ 5,845	\$ 6,720
PY042MLCC	42" Pyramid   Custom Color*	\$ 7,275	\$ 8,365
PY048ML	48" Pyramid   Stainless Steel	\$ 3,440	\$ 3,955
PY048MLC	48" Pyramid   Std RAL Color*	\$ 4,865	\$ 5,595
PY048MLCF	48" Pyramid   Specialty Finish*	\$ 5,965	\$ 6,860
PY048MLCC	48" Pyramid   Custom Color*	\$ 7,395	\$ 8,505
PY054ML	54" Pyramid   Stainless Steel	\$ 3,685	\$ 4,240
PY054MLC	54" Pyramid   Std RAL Color*	\$ 5,110	\$ 5,875
PY054MLCF	54" Pyramid   Specialty Finish*	\$ 6,210	\$ 7,140
PY054MLCC	54" Pyramid   Custom Color*	\$ 7,640	\$ 8,785
PY060ML	60" Pyramid   Stainless Steel	\$ 4,420	\$ 5,085
PY060MLC	60" Pyramid   Std RAL Color*	\$ 5,845	\$ 6,720
PY060MLCF	60" Pyramid   Specialty Finish*	\$ 6,945	\$ 7,985
PY060MLCC	60" Pyramid   Custom Color*	\$ 8,375	\$ 9,630
PY066ML	66" Pyramid   Stainless Steel	\$ 4,775	\$ 5,490
PY066MLC	66" Pyramid   Std RAL Color*	\$ 6,200	\$ 7,130
PY066MLCF	66" Pyramid   Specialty Finish*	\$ 7,300	\$ 8,395
PY066MLCC	66" Pyramid   Custom Color*	\$ 8,730	\$ 10,040

VENTILATION HOOD ACCESSORIES:	
See page 80 for Duct Free Kits (Duct cover can not be installed with Duct Free Kits)	
Refer to page 102 for Ventilation Hood Accessories	

DUCT COVER OPTIONS: (Must be included on order)				
Hood	Model	Duct Height Range	UMRP	MSRP
30" Models	DCTW12S	Min 12" – Max 24"	N/C	N/C
	DCTW12M	Min 24" – Max 42"	\$ 880	\$ 1,010
	DCTW12T	Min 42" – Max 60"	\$ 1,385	\$ 1,595
36" – 54" Models	DCTW18S	Min 12" – Max 24"	N/C	N/C
	DCTW18M	Min 24" – Max 42"	\$ 1,005	\$ 1,155
	DCTW18T	Min 42" – Max 60"	\$ 1,510	\$ 1,735
60" – 66" Models	DCTW24S	Min 12" – Max 24"	N/C	N/C
	DCTW24M	Min 24" – Max 42"	\$ 1,195	\$ 1,375
	DCTW24T	Min 42" – Max 60"	\$ 1,640	\$ 1,885

BLOWER OPTIONS	IN-HOOD		IN-LINE		REMOTE		DISCHARGE	
	600	1200	800	1200	1000	1400	TOP	REAR
CFM POWER	600	1200	800	1200	1000	1400		
MODEL #	BS-CFM-600-IN06	BS-CFM-1200-IN12	ATEX-0.8	ATEX-1.2	HYEX-1.0-GA	HYEX-1.4-GA		
UMRP	\$ 965	\$ 1,385	\$ 1,260	\$ 1,510	\$ 1,385	\$ 1,640		
PY030ML	•	•	•	•	•	•	•	Available at time of order
PY036ML	•	•	•	•	•	•	•	
PY042ML	•	•	•	•	•	•	•	
PY048ML	•	•	•	•	•	•	•	
PY054ML	•	•	•	•	•	•	•	
PY060ML	•	•	•	•	•	•	•	
PY066ML	•	•	•	•	•	•	•	

## PROFESSIONAL SERIES: LOW PROFILE WALL HOOD

<b>BlueStar Model Number Guide:</b>	<b>Base Model (LP0XXLP)</b> Low Profile   Unit Width   Internal Liner Type	<b>Add code below for desired color</b> (C) 190 Standard RAL (Semi-Gloss) Colors (CF) Specialty Finish (190 Matte RAL, Precious Metals & Textures) (CC) Custom Colors	<b>Add (PLT) for Metal Strapping</b> Not available on this model
-------------------------------------	-------------------------------------------------------------------------------	--------------------------------------------------------------------------------------------------------------------------------------------------------------------------------	---------------------------------------------------------------------



Standard Height: 10" | Standard Depth: 24"

**FEATURES:**

- Commercial grade stainless steel construction
- 600 CFM internal fan included (Only blower option available for this model)
- Welded seamless corners
- Dishwasher safe stainless steel baffles
- 3-speed blower/variable light control

**CUSTOMIZATION OPTIONS:**

- 1,000+ Colors & Finishes

Model	Description (* Denotes item that must be specified)	UMRP	MSRP
LP030LP	30" Low Profile   Stainless Steel   600 CFM Blower	\$ 1,960	\$ 2,255
LP030LPC	30" Low Profile   Std RAL Color*   600 CFM Blower	\$ 3,055	\$ 3,515
LP030LPCF	30" Low Profile   Specialty Finish*   600 CFM Blower	\$ 4,045	\$ 4,650
LP030LPCC	30" Low Profile   Custom Color*   600 CFM Blower	\$ 5,475	\$ 6,295
LP036LP	36" Low Profile   Stainless Steel   600 CFM Blower	\$ 2,145	\$ 2,465
LP036LPC	36" Low Profile   Std RAL Color*   600 CFM Blower	\$ 3,240	\$ 3,725
LP036LPCF	36" Low Profile   Specialty Finish*   600 CFM Blower	\$ 4,230	\$ 4,865
LP036LPCC	36" Low Profile   Custom Color*   600 CFM Blower	\$ 5,660	\$ 6,510

## PROFESSIONAL SERIES: LOW PROFILE RECIRCULATING WALL HOOD



Standard Height: 10" | Standard Depth: 24"

**FEATURES:**

- Commercial grade stainless steel construction
- Welded seamless corners
- Commercial style stainless steel baffle filter system
- 4-speed blower/variable light control
- Designed for non-ducted applications only
- 520 CFM internal fan included (Only blower option available for this model)
- Halogen lamps with dimmer control

**CUSTOMIZATION OPTIONS:**

- 1,000+ Colors & Finishes

Model	Description (* Denotes item that must be specified)	UMRP	MSRP
LR030LP	30" Low Profile Recirc   Stainless Steel   520 CFM Blower	\$ 2,085	\$ 2,400
LR030LPC	30" Low Profile Recirc   Std RAL Color*   520 CFM Blower	\$ 3,180	\$ 3,655
LR030LPCF	30" Low Profile Recirc   Specialty Finish*   520 CFM Blower	\$ 4,170	\$ 4,795
LR030LPCC	30" Low Profile Recirc   Custom Color*   520 CFM Blower	\$ 5,600	\$ 6,440
LR036LP	36" Low Profile Recirc   Stainless Steel   520 CFM Blower	\$ 2,210	\$ 2,540
LR036LPC	36" Low Profile Recirc   Std RAL Color*   520 CFM Blower	\$ 3,305	\$ 3,800
LR036LPCF	36" Low Profile Recirc   Specialty Finish*   520 CFM Blower	\$ 4,295	\$ 4,940
LR036LPCC	36" Low Profile Recirc   Custom Color*   520 CFM Blower	\$ 5,725	\$ 6,585

## LINERS/INSERTS: PROFESSIONAL METAL LINER

<b>BlueStar Model Number Guide:</b>	<b>Base Model (PYOXXML)</b> Liner Insert Model   Unit Width   Internal Liner Type	<b>Add code below for desired color</b> Not available on this model	<b>Add (PLT) for Metal Strapping</b> Not available on this model
-------------------------------------	--------------------------------------------------------------------------------------	------------------------------------------------------------------------	---------------------------------------------------------------------



Model	Description	UMRP	MSRP
PM028ML	28" Metal Liner   600 CFM Blower   26 5/8" x 22 1/8" x 16 1/4"	\$ 1,545	\$ 1,775
PM034ML	34" Metal Liner   600 CFM Blower   33 5/8" x 22 1/8" x 16 1/4"	\$ 1,545	\$ 1,775
PM040ML	40" Metal Liner   39 5/8" x 22 1/8" x 16 1/4"	\$ 1,545	\$ 1,775
PM046ML	46" Metal Liner   45 7/16" x 22 1/8" x 16 1/4"	\$ 1,680	\$ 1,930
PM052ML	52" Metal Liner   51 7/16" x 22 1/8" x 16 1/4"	\$ 1,805	\$ 2,075
PM058ML	58" Metal Liner   57 1/4" x 22 1/8" x 16 1/4"	\$ 1,875	\$ 2,155
PM064ML	64" Metal Liner   63 1/4" x 22 1/8" x 16 1/4"	\$ 2,060	\$ 2,370
PM070ML	70" Metal Liner   67 1/4" x 22 1/8" x 16 1/4"	\$ 2,315	\$ 2,660

Refer to page 102 for Ventilation Hood Accessories

**FEATURES:**

- Professional-grade performance with three exhaust settings and new Boost feature
- Whisper quiet operation
- Heavy duty, commercial grade materials
- Dimmable LED lighting
- Easy-to-use push-button controls
- Innovative, multi-stage grease capture system
- Stainless baffle filters seamlessly remove for easy dishwasher cleaning
- Simple installation
- 28" & 34" models: 600 CFM internal fan included **(Must be included on order)**
- Available with top or rear discharge - Discharge is field reversible.
- In-line, in-hood and remote blower compatible

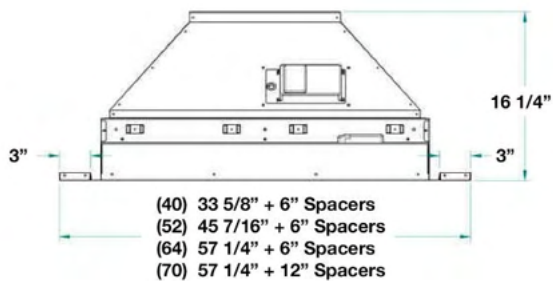
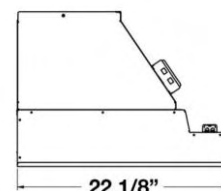
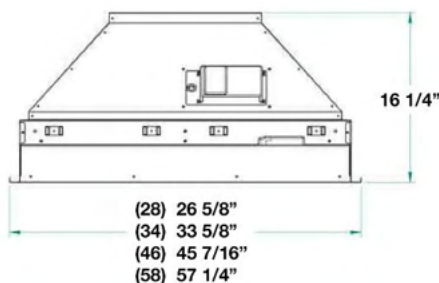

BLOWER OPTIONS	IN-HOOD		IN-LINE		REMOTE		DISCHARGE	
CFM POWER	600	1200	800	1200	1000	1400	TOP	REAR
MODEL #	BS-CFM-600-IN06	BS-CFM-1200-IN12	ATEX-0.8	ATEX-1.2	HYEX-1.0-GA	HYEX-1.4-GA		
UMRP	\$ 965	\$ 1,385	\$ 1,260	\$ 1,510	\$ 1,385	\$ 1,640	Available at time of order	
28" Liners	•		•	•	•	•		
34" Liners	•	•	•	•	•	•		
40" Liners	•	•	•	•	•	•		
46" Liners	•	•	•	•	•	•		
52" Liners	•	•	•	•	•	•		
58" Liners	•	•	•	•	•	•		
64" Liners	•	•	•	•	•	•		
70" Liners	•	•	•	•	•	•		

## RECIRCULATING KITS: STANDARD WALL HOODS

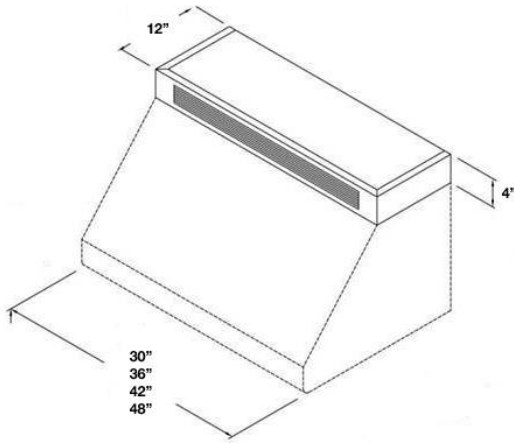

Model	Description	UMRP	MSRP
PH-RHKP-30-SS	30" Recirculating Kit	\$ 1,250	\$ 1,440
PH-RHKP-36-SS	36" Recirculating Kit	\$ 1,325	\$ 1,525
PH-RHKP-42-SS	42" Recirculating Kit	\$ 1,385	\$ 1,595
PH-RHKP-48-SS	48" Recirculating Kit	\$ 1,455	\$ 1,675

### FEATURES:

- Seamed construction
- Includes charcoal filter
- Stainless steel finish
- Use only with 600 CFM In-hood fan – *Sold separately*
- Compatible with Bonanza, Incline and Proline hoods only
- Duct cover can not be attached above recirculating kits

## RECIRCULATING KITS: CHIMNEY WALL HOODS

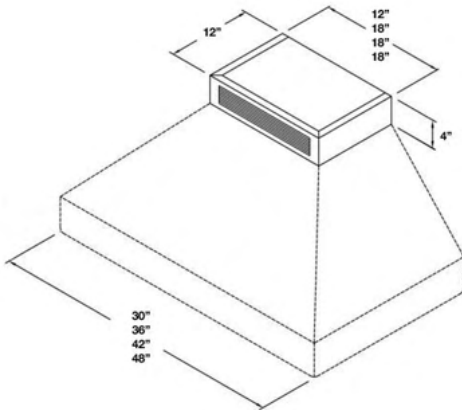

Model	Description	UMRP	MSRP
PH-RHKC-30-SS	30" Chimney Recirculating Kit	\$ 1,250	\$ 1,440
PH-RHKC-36-SS	36" Chimney Recirculating Kit	\$ 1,325	\$ 1,525
PH-RHKC-42-SS	42" Chimney Recirculating Kit	\$ 1,325	\$ 1,525
PH-RHKC-48-SS	48" Chimney Recirculating Kit	\$ 1,325	\$ 1,525

### FEATURES:

- Seamed construction
- Includes charcoal filter
- Stainless steel finish
- Use only with 600 CFM In-hood fan - *Sold separately*
- Compatible with Pyramid and Hampton hoods only
- Duct cover can not be attached above recirculating kits



## **VENTILATION: DESIGNER SERIES**

**Get the Look: 48" Manhattan Style Vent Hood in Brushed Brass & Jet Black (RAL 9005)**

## DESIGNER SERIES: CUSTOMIZATION OPTIONS



### 1,000 + COLORS & FINISHES

BlueStar appliances are available in a painter's palette of colors and finishes. Select from 1,000+ colors plus matte and textured finishes to turn up the heat on discerning kitchen design.



### DESIGNER METALS

Outfit your hood in our collection of Designer Metal finishes like brushed brass, polished brass and copper. Add these luxury finishes to create a kitchen hood worthy of your personal signature and style.



### CUSTOM STRAPPING & RIVETS

Customize your ventilation hood with one of our standard strapping layouts or choose your own. All strapping is available in the Designer Metals above or painted in one of our standard 190 RAL colors. Request a quote from our ventilation team at [quote@bluestarcooking.com](mailto:quote@bluestarcooking.com)

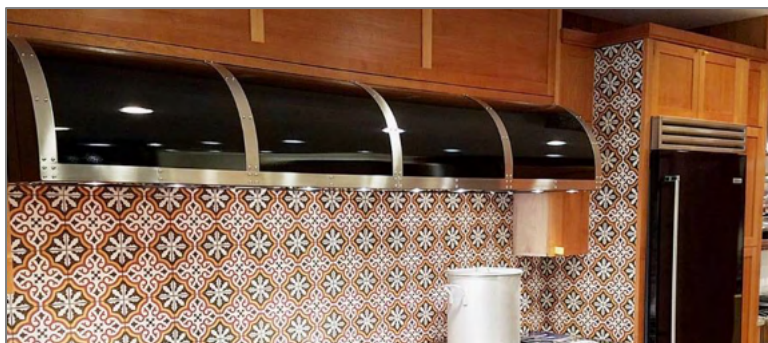

### CUSTOM SIZES

Customize the height or depth of your ventilation hood to accommodate your unique kitchen design. Request a quote from our ventilation team at [quote@bluestarcooking.com](mailto:quote@bluestarcooking.com)

## DESIGNER SERIES: HAMPTON WALL HOODS

BlueStar Model Number Guide:	<b>Base Model (HA0XXML)</b>	<b>Add code below for desired color</b>	<b>Add (PLT) for Metal Strapping</b>
	Hampton   Unit Width   Internal Liner Type	(C) 190 Standard RAL (Semi-Gloss) Colors (CF) Specialty Finish (190 Matte RAL, Precious Metals & Textures) (CC) Custom Colors	Available through custom quote only at quote@bluestarcooking.com



Standard Height: 18" | Standard Depth: 24"

**FEATURES:**

- Professional-grade performance with three exhaust settings and new Boost feature
- Whisper quiet operation
- Heavy duty, commercial grade materials
- Dimmable LED lighting
- Easy-to-use push-button controls
- Innovative, multi-stage grease capture system
- Stainless baffle filters seamlessly remove for easy dishwasher cleaning
- Choose from stainless steel or 1,000+ colors and finishes
- Simple installation
- 30" & 36" models: 600 CFM internal fan included **(Must be included on order)**
- Included duct cover heights: 6", 12", 18", 24" or 30". Must be specified on order.
- Available with top or rear discharge- Discharge is field reversible.
- Duct free recirculating kits available for 30", 36", 42" & 48" models (Sold separately- see page 71)
- In-line, in-hood and remote blower compatible

**CUSTOMIZATION OPTIONS:**

- 1,000+ Colors & Finishes
- Designer Metals like brass & copper
- Custom strapping & rivets
- Full custom options

(\* Trim finishes on Cooking & Refrigeration products are different substrates than the trim finishes on Ventilation hoods. Due to these differing processes and substrates the finishes will coordinate but may not match exactly.

Model	Description (* Denotes item that must be specified)	UMRP	MSRP
HA030ML	30" Hampton   Stainless Steel   600 CFM Blower	\$ 2,890	\$ 3,325
HA030MLC	30" Hampton   Std RAL Color*   600 CFM Blower	\$ 3,985	\$ 4,585
HA030MLCF	30" Hampton   Specialty Finish*   600 CFM Blower	\$ 4,975	\$ 5,720
HA030MLCC	30" Hampton   Custom Color*   600 CFM Blower	\$ 6,405	\$ 7,365
HA036ML	36" Hampton   Stainless Steel   600 CFM Blower	\$ 3,375	\$ 3,880
HA036MLC	36" Hampton   Std RAL Color*   600 CFM Blower	\$ 4,470	\$ 5,140
HA036MLCF	36" Hampton   Specialty Finish*   600 CFM Blower	\$ 5,460	\$ 6,280
HA036MLCC	36" Hampton   Custom Color*   600 CFM Blower	\$ 6,890	\$ 7,925
HA042ML	42" Hampton   Stainless Steel	\$ 4,100	\$ 4,715
HA042MLC	42" Hampton   Std RAL Color*	\$ 5,525	\$ 6,355
HA042MLCF	42" Hampton   Specialty Finish*	\$ 6,625	\$ 7,620
HA042MLCC	42" Hampton   Custom Color*	\$ 8,055	\$ 9,265
HA048ML	48" Hampton   Stainless Steel	\$ 4,220	\$ 4,855
HA048MLC	48" Hampton   Std RAL Color*	\$ 5,645	\$ 6,490
HA048MLCF	48" Hampton   Specialty Finish*	\$ 6,745	\$ 7,755
HA048MLCC	48" Hampton   Custom Color*	\$ 8,175	\$ 9,400
HA054ML	54" Hampton   Stainless Steel	\$ 4,340	\$ 4,990
HA054MLC	54" Hampton   Std RAL Color*	\$ 5,765	\$ 6,630
HA054MLCF	54" Hampton   Specialty Finish*	\$ 6,865	\$ 7,895
HA054MLCC	54" Hampton   Custom Color*	\$ 8,295	\$ 9,540
HA060ML	60" Hampton   Stainless Steel	\$ 4,585	\$ 6,275
HA060MLC	60" Hampton   Std RAL Color*	\$ 6,010	\$ 6,910
HA060MLCF	60" Hampton   Specialty Finish*	\$ 7,110	\$ 8,175
HA060MLCC	60" Hampton   Custom Color*	\$ 8,540	\$ 9,820
HA066ML	60" Hampton   Stainless Steel	\$ 4,705	\$ 5,410
HA066MLC	60" Hampton   Std RAL Color*	\$ 6,130	\$ 7,050
HA066MLCF	60" Hampton   Specialty Finish*	\$ 7,230	\$ 8,315
HA066MLCC	60" Hampton   Custom Color*	\$ 8,660	\$ 9,960

**DUCT COVERS FOR HAMPTON HOODS:**

Refer to page 84 for all Hampton hood duct cover options  
 • Included duct cover heights: 6", 12", 18", 24" & 30" | Also available in 36", 42" & 48" for additional charge

Refer to page 102 for Ventilation Hood Accessories

BLOWER OPTIONS	IN-HOOD		IN-LINE		REMOTE		DISCHARGE	
CFM POWER	600	1200	800	1200	1000	1400	TOP	REAR
MODEL #	BS-CFM-600-IN06	BS-CFM-1200-IN12	ATEX-0.8	ATEX-1.2	HYEX-1.0-GA	HYEX-1.4-GA		
UMRP	\$ 965	\$ 1,385	\$ 1,260	\$ 1,510	\$ 1,385	\$ 1,640	Available at time of order	
HA030ML	•		•	•	•	•		
HA036ML	•	•	•	•	•	•		
HA042ML	•	•	•	•	•	•		
HA048ML	•	•	•	•	•	•		
HA054ML	•	•	•	•	•	•		
HA060ML	•	•	•	•	•	•		
HA066ML	•	•	•	•	•	•		

## DUCT COVERS: HAMPTON WALL HOODS

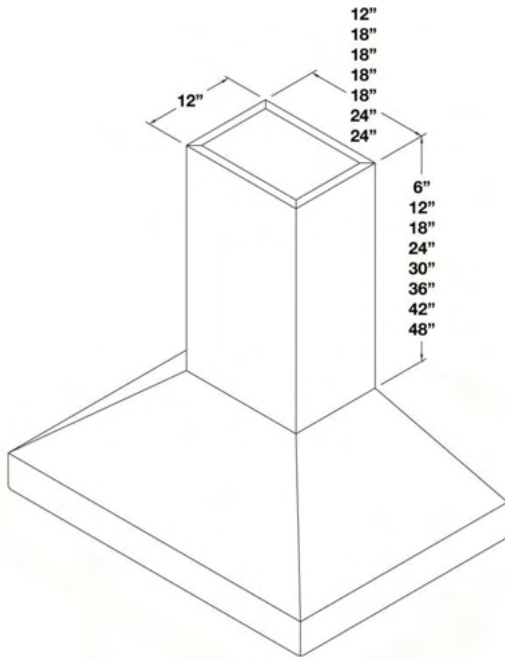

SIZE	MODEL	HEIGHT	UMRP	MSRP
Available Duct Covers for 30" Models	DCCW03006	6"	\$ 885	\$ 1,020
	DCCW03012	12"	\$ 965	\$ 1,110
	DCCW03018	18"	\$ 1,065	\$ 1,225
	DCCW03024	24"	\$ 1,160	\$ 1,335
	DCCW03030	30"	\$ 1,250	\$ 1,440
	DCCW03036	36"	\$ 1,340	\$ 1,540
	DCCW03042	42"	\$ 1,445	\$ 1,660
	DCCW03048	48"	\$ 1,525	\$ 1,755
	Available Duct Covers for 36" Models	DCCW03606	6"	\$ 885
DCCW03612		12"	\$ 965	\$ 1,110
DCCW03618		18"	\$ 1,065	\$ 1,225
DCCW03624		24"	\$ 1,160	\$ 1,335
DCCW03630		30"	\$ 1,250	\$ 1,440
DCCW03636		36"	\$ 1,340	\$ 1,540
DCCW03642		42"	\$ 1,445	\$ 1,660
DCCW03648		48"	\$ 1,525	\$ 1,755
Available Duct Covers for 42" Models		DCCW04206	6"	\$ 885
	DCCW04212	12"	\$ 965	\$ 1,110
	DCCW04218	18"	\$ 1,065	\$ 1,225
	DCCW04224	24"	\$ 1,160	\$ 1,335
	DCCW04230	30"	\$ 1,250	\$ 1,440
	DCCW04236	36"	\$ 1,340	\$ 1,540
	DCCW04242	42"	\$ 1,445	\$ 1,660
	DCCW04248	48"	\$ 1,525	\$ 1,755

SIZE	MODEL	HEIGHT	UMRP	MSRP
Available Duct Covers for 48" Models	DCCW04806	6"	\$ 885	\$ 1,020
	DCCW04812	12"	\$ 965	\$ 1,110
	DCCW04818	18"	\$ 1,065	\$ 1,225
	DCCW04824	24"	\$ 1,160	\$ 1,335
	DCCW04830	30"	\$ 1,250	\$ 1,440
	DCCW04836	36"	\$ 1,340	\$ 1,540
	DCCW04842	42"	\$ 1,445	\$ 1,660
	DCCW04848	48"	\$ 1,525	\$ 1,755
Available Duct Covers for 54" Models	DCCW05406	6"	\$ 885	\$ 1,020
	DCCW05412	12"	\$ 965	\$ 1,110
	DCCW05418	18"	\$ 1,065	\$ 1,225
	DCCW05424	24"	\$ 1,160	\$ 1,335
	DCCW05430	30"	\$ 1,250	\$ 1,440
	DCCW05436	36"	\$ 1,340	\$ 1,540
	DCCW05442	42"	\$ 1,445	\$ 1,660
	DCCW05448	48"	\$ 1,525	\$ 1,755
Available Duct Covers for 60" Models	DCCW06006	6"	\$ 885	\$ 1,020
	DCCW06012	12"	\$ 965	\$ 1,110
	DCCW06018	18"	\$ 1,065	\$ 1,225
	DCCW06024	24"	\$ 1,160	\$ 1,335
	DCCW06030	30"	\$ 1,250	\$ 1,440
	DCCW06036	36"	\$ 1,340	\$ 1,540
	DCCW06042	42"	\$ 1,445	\$ 1,660
	DCCW06048	48"	\$ 1,525	\$ 1,755
Available Duct Covers for 66" Models	DCCW06606	6"	\$ 885	\$ 1,020
	DCCW06612	12"	\$ 965	\$ 1,110
	DCCW06618	18"	\$ 1,065	\$ 1,225
	DCCW06624	24"	\$ 1,160	\$ 1,335
	DCCW06630	30"	\$ 1,250	\$ 1,440
	DCCW06636	36"	\$ 1,340	\$ 1,540
	DCCW06642	42"	\$ 1,445	\$ 1,660
	DCCW06648	48"	\$ 1,525	\$ 1,755

## DESIGNER SERIES: MANHATTAN WALL HOODS

<b>BlueStar Model Number Guide:</b>	<b>Base Model (MH0XXMA)</b> Manhattan   Unit Width   Internal Liner Type	<b>Add code below for desired color</b> (C) 190 Standard RAL (Semi-Gloss) Colors (CF) Specialty Finish (190 Matte RAL, Precious Metals & Textures) (CC) Custom Colors	<b>Add (PLT) for Metal Strapping</b> Available through custom quote only at quote@bluestarcooking.com
-------------------------------------	-----------------------------------------------------------------------------	--------------------------------------------------------------------------------------------------------------------------------------------------------------------------------	-------------------------------------------------------------------------------------------------------------

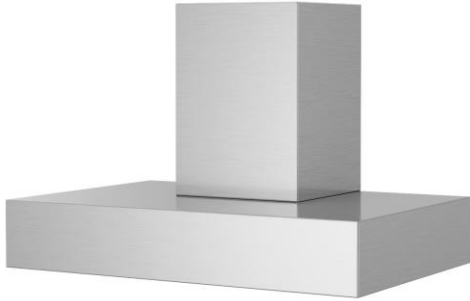

Standard Height: 6 1/4" | Standard Depth: 24"

**FEATURES:**

- Professional-grade performance with three exhaust settings and new Boost feature
- Whisper quiet operation
- Heavy duty, commercial grade materials
- Dimmable LED lighting
- Easy-to-use push-button controls
- Innovative, multi-stage grease capture system
- Stainless baffle filters seamlessly remove for easy dishwasher cleaning
- Choose from stainless steel or 1,000+ colors and finishes
- Simple installation
- 30" & 36" models: 600 CFM internal fan included **(Must be included on order)**
- Accommodates top discharge only
- Included duct cover heights: 18", 24", 30" & 36" **(Must be specified on order.)**
- In-line, in-hood and remote blower compatible

**CUSTOMIZATION OPTIONS:**

- 1,000+ Colors & Finishes
- Designer Metals like brass & copper
- Custom strapping & rivets
- Full custom options

*(\* Trim finishes on Cooking & Refrigeration products are different substrates than the trim finishes on Ventilation hoods. Due to these differing processes and substrates the finishes will coordinate but may not match exactly.)*

**NOTE: HOOD MUST BE MOUNTED TO CEILING AND CEILING ACCESS MAY BE REQUIRED. PLEASE REFERENCE THE INSTALLATION MANUAL ON BLUESTARCOOKING.COM FOR DETAILS**

**NOTE: MUST ORDER DUCT COVER FOR BLOWER & MOUNTING PURPOSES. MINIMUM 18" HIGH**

Model	Description (* Denotes item that must be specified)	UMRP	MSRP
MH030MA	30" Manhattan   Stainless Steel   600 CFM Blower	\$ 2,890	\$ 3,325
MH030MAC	30" Manhattan   Std RAL Color*   600 CFM Blower	\$ 3,985	\$ 4,585
MH030MACF	30" Manhattan   Specialty Finish*   600 CFM Blower	\$ 4,975	\$ 5,720
MH030MACC	30" Manhattan   Custom Color*   600 CFM Blower	\$ 6,405	\$ 7,365
MH036MA	36" Manhattan   Stainless Steel   600 CFM Blower	\$ 3,375	\$ 3,880
MH036MAC	36" Manhattan   Std RAL Color*   600 CFM Blower	\$ 4,470	\$ 5,140
MH036MACF	36" Manhattan   Specialty Finish*   600 CFM Blower	\$ 5,460	\$ 6,280
MH036MACC	36" Manhattan   Custom Color*   600 CFM Blower	\$ 6,890	\$ 7,925
MH042MA	42" Manhattan   Stainless Steel	\$ 3,615	\$ 4,155
MH042MAC	42" Manhattan   Std RAL Color*	\$ 5,040	\$ 5,795
MH042MACF	42" Manhattan   Specialty Finish*	\$ 6,140	\$ 7,060
MH042MACC	42" Manhattan   Custom Color*	\$ 7,570	\$ 8,705
MH048MA	48" Manhattan   Stainless Steel	\$ 3,860	\$ 4,440
MH048MAC	48" Manhattan   Std RAL Color*	\$ 5,285	\$ 6,080
MH048MACF	48" Manhattan   Specialty Finish*	\$ 6,385	\$ 7,345
MH048MACC	48" Manhattan   Custom Color*	\$ 7,815	\$ 8,985
MH054MA	54" Manhattan   Stainless Steel	\$ 5,065	\$ 5,825
MH054MAC	54" Manhattan   Std RAL Color*	\$ 6,490	\$ 7,465
MH054MACF	54" Manhattan   Specialty Finish*	\$ 7,590	\$ 8,730
MH054MACC	54" Manhattan   Custom Color*	\$ 9,020	\$ 10,375
MH060MA	60" Manhattan   Stainless Steel	\$ 5,430	\$ 6,245
MH060MAC	60" Manhattan   Std RAL Color*	\$ 6,855	\$ 7,885
MH060MACF	60" Manhattan   Specialty Finish*	\$ 7,955	\$ 9,150
MH060MACC	60" Manhattan   Custom Color*	\$ 9,385	\$ 10,795
MH066MA	66" Manhattan   Stainless Steel	\$ 5,550	\$ 6,380
MH066MAC	66" Manhattan   Std RAL Color*	\$ 6,975	\$ 8,020
MH066MACF	66" Manhattan   Specialty Finish*	\$ 8,075	\$ 9,285
MH066MACC	66" Manhattan   Custom Color*	\$ 9,505	\$ 10,930

**DUCT COVERS FOR MANHATTAN HOODS:**

Refer to page 86 for all Manhattan hood duct cover options  
 • Included duct cover heights: 18", 24", 30" & 36" | Also available in 42" & 48" for additional charge  
 Refer to page 102 for Ventilation Hood Accessories

BLOWER OPTIONS	IN-HOOD		IN-LINE		REMOTE		DISCHARGE	
	CFM POWER						TOP	REAR
	600	1200	800	1200	1000	1400		
MODEL #	BS-CFM-600-IN06	BS-CFM-1200-IN12	ATEX-0.8	ATEX-1.2	HYEX-1.0-GA	HYEX-1.4-GA		
UMRP	\$ 965	\$ 1,385	\$ 1,260	\$ 1,510	\$ 1,385	\$ 1,640		
MH030MA	•		•				•	
MH036MA	•		•				•	
MH042MA	•		•				•	
MH048MA	•	•	•	•	•	•	•	
MH054MA	•	•	•	•	•	•	•	
MH060MA	•	•	•	•	•	•	•	
MH066MA	•	•	•	•	•	•	•	

## DUCT COVERS: MANHATTAN WALL HOODS

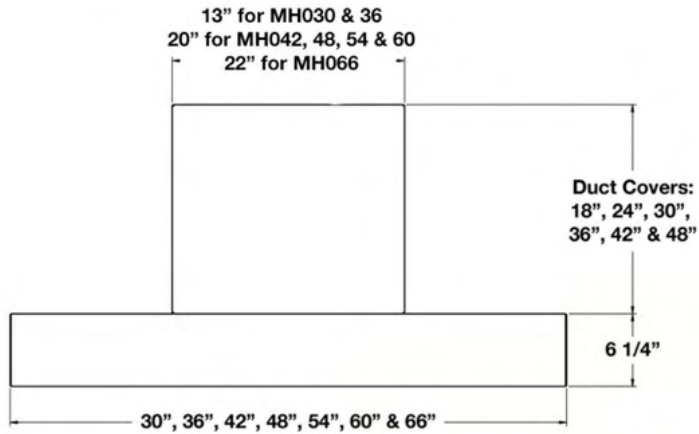

SIZE	MODEL	HEIGHT	UMRP	MSRP
Available Duct Covers for 30" Models	DCMW03018	18"	\$ 690	\$ 795
	DCMW03024	24"	\$ 760	\$ 875
	DCMW03030	30"	\$ 830	\$ 955
	DCMW03036	36"	\$ 895	\$ 1,030
	DCMW03042	42"	\$ 965	\$ 1,110
	DCMW03048	48"	\$ 1,035	\$ 1,190
Available Duct Covers for 36" Models	DCMW03618	18"	\$ 690	\$ 795
	DCMW03624	24"	\$ 760	\$ 875
	DCMW03630	30"	\$ 830	\$ 955
	DCMW03636	36"	\$ 895	\$ 1,030
	DCMW03642	42"	\$ 965	\$ 1,110
	DCMW03648	48"	\$ 1,035	\$ 1,190
Available Duct Covers for 42" Models	DCMW04218	18"	\$ 690	\$ 795
	DCMW04224	24"	\$ 760	\$ 875
	DCMW04230	30"	\$ 830	\$ 955
	DCMW04236	36"	\$ 895	\$ 1,030
	DCMW04242	42"	\$ 965	\$ 1,110
	DCMW04248	48"	\$ 1,035	\$ 1,190
Available Duct Covers for 48" Models	DCMW04818	18"	\$ 690	\$ 795
	DCMW04824	24"	\$ 760	\$ 875
	DCMW04830	30"	\$ 830	\$ 955
	DCMW04836	36"	\$ 895	\$ 1,030
	DCMW04842	42"	\$ 965	\$ 1,110
	DCMW04848	48"	\$ 1,035	\$ 1,190

NOTE: 18", 24", 30" & 36" DUCT COVERS INCLUDED WITH HOOD AT NO CHARGE. BELOW PRICING IS IF PURCHASED SEPARATELY.

NOTE: HOOD MUST BE MOUNTED TO CEILING AND CEILING ACCESS MAY BE REQUIRED. PLEASE REFERENCE THE INSTALLATION MANUAL ON [BLUESTARCOOKING.COM](http://BLUESTARCOOKING.COM) FOR DETAILS

NOTE: MUST ORDER DUCT COVER FOR BLOWER & MOUNTING PURPOSES. MINIMUM 18" HIGH

SIZE	MODEL	HEIGHT	UMRP	MSRP
Available Duct Covers for 54" Models	DCMW05418	18"	\$ 690	\$ 795
	DCMW05424	24"	\$ 760	\$ 875
	DCMW05430	30"	\$ 830	\$ 955
	DCMW05436	36"	\$ 895	\$ 1,030
	DCMW05442	42"	\$ 965	\$ 1,110
	DCMW05448	48"	\$ 1,035	\$ 1,190
Available Duct Covers for 60" Models	DCMW06018	18"	\$ 690	\$ 795
	DCMW06024	24"	\$ 760	\$ 875
	DCMW06030	30"	\$ 830	\$ 955
	DCMW06036	36"	\$ 895	\$ 1,030
	DCMW06042	42"	\$ 965	\$ 1,110
	DCMW06048	48"	\$ 1,035	\$ 1,190
Available Duct Covers for 66" Models	DCMW06618	18"	\$ 690	\$ 795
	DCMW06624	24"	\$ 760	\$ 875
	DCMW06630	30"	\$ 830	\$ 955
	DCMW06636	36"	\$ 895	\$ 1,030
	DCMW06642	42"	\$ 965	\$ 1,110
	DCMW06648	48"	\$ 1,035	\$ 1,190

## DESIGNER SERIES: 30" & 36" BONANZA WALL HOODS

BlueStar Model Number Guide:	<b>Base Model (BZ0XXMLPLT)</b>	<b>Add code below for desired color</b>	<b>Add (PLT) for Metal Strapping</b>
	Bonanza   Unit Width   Internal Liner Type   Brushed Stainless Steel Strapping & Rivets	(C) 190 Standard RAL (Semi-Gloss) Colors (CF) Specialty Finish (190 Matte RAL, Precious Metals & Textures) (CC) Custom Colors	Standard: Brushed Stainless Steel See below for Designer Metal strapping and rivet options

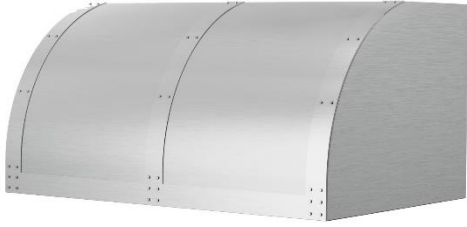

30" & 36" Bonanza Wall Hood

Standard Height: 18" | Standard Depth: 24"

**FEATURES:**

- Professional-grade performance with three exhaust settings and new Boost feature
- Whisper quiet operation
- Heavy duty, commercial grade materials
- Dimmable LED lighting
- Easy-to-use push-button controls
- Innovative, multi-stage grease capture system
- Stainless baffle filters seamlessly remove for easy dishwasher cleaning
- Choose from stainless steel or 1,000+ colors and finishes
- Simple installation
- 30" & 36" models: 600 CFM internal fan included **(Must be included on order)**
- Available with top or rear discharge - Discharge is field reversible.
- Install with or without optional duct cover
- In-line, in-hood and remote blower compatible

**CUSTOMIZATION OPTIONS:**

- 1,000+ Colors & Finishes
- Designer Metals like brass & copper
- Custom strapping & rivets
- Full custom options

(\* Trim finishes on Cooking & Refrigeration products are different substrates than the trim finishes on Ventilation hoods. Due to these differing processes and substrates the finishes will coordinate but may not match exactly.

Model	Description (* Denotes item that must be specified)	UMRP	MSRP
<b>30" BONANZA HOODS: (3 Vertical Straps   1 Horizontal)</b>			
BZ030MLPLT	Body: Stainless Steel   Strap/Rivets: Stainless Steel   600 CFM	\$ 4,460	\$ 5,130
BZ030MLPLTD	Body: Stainless Steel   Strap/Rivets: Des. Metal*   600 CFM	\$ 4,695	\$ 5,400
BZ030MLPLTC	Body: Std RAL Color*   Strap/Rivets: Stainless Steel   600 CFM	\$ 5,555	\$ 6,390
BZ030MLPLTDC	Body: Std RAL Color*   Strap/Rivets: Des Metal*   600 CFM	\$ 5,790	\$ 6,660
BZ030MLPLTCF	Body: Spec. Finish*   Strap/Rivets: Stainless Steel   600 CFM	\$ 6,545	\$ 7,525
BZ030MLPLTD CF	Body: Spec. Finish*   Strap/Rivets: Des. Metal*   600 CFM	\$ 6,780	\$ 7,795
BZ030MLPLTCC	Body: Custom Color*   Strap/Rivets: Stainless Steel   600 CFM	\$ 7,975	\$ 9,170
BZ030MLPLTDCC	Body: Custom Color*   Strap/Rivets: Des. Metal*   600 CFM	\$ 8,210	\$ 9,440
<b>36" BONANZA HOODS: (3 Vertical Straps   1 Horizontal)</b>			
BZ036MLPLT	Body: Stainless Steel   Strap/Rivets: Stainless Steel   600 CFM	\$ 4,825	\$ 5,550
BZ036MLPLTD	Body: Stainless Steel   Strap/Rivets: Des. Metal*   600 CFM	\$ 5,135	\$ 5,905
BZ036MLPLTC	Body: Std RAL Color*   Strap/Rivets: Stainless Steel   600 CFM	\$ 5,920	\$ 6,810
BZ036MLPLTDC	Body: Std RAL Color*   Strap/Rivets: Des Metal*   600 CFM	\$ 6,230	\$ 7,165
BZ036MLPLTCF	Body: Spec. Finish*   Strap/Rivets: Stainless Steel   600 CFM	\$ 6,910	\$ 7,945
BZ036MLPLTD CF	Body: Spec. Finish*   Strap/Rivets: Des. Metal*   600 CFM	\$ 7,220	\$ 8,305
BZ036MLPLTCC	Body: Custom Color*   Strap/Rivets: Stainless Steel   600 CFM	\$ 8,340	\$ 9,590
BZ036MLPLTDCC	Body: Custom Color*   Strap/Rivets: Des. Metal*   600 CFM	\$ 8,650	\$ 9,950
<b>DESIGNER METAL OPTIONS FOR STRAPPING &amp; RIVETS:</b>			
Polished Stainless	Antique Brass	Brushed Brass	Polished Brass
Antique Copper	Brushed Copper	Polished Copper	Pewter
<b>DUCT COVERS FOR BONANZA HOODS:</b>			
See page 80 for Duct Free Kits (Duct cover can not be installed with Duct Free Kits)			
Refer to page 89 for all Bonanza hood duct cover options			
• Available duct cover heights: 2", 6", 12", 18", 24", 30", 36", 42" & 48"			
Refer to page 102 for Ventilation Hood Accessories			

BLOWER OPTIONS	IN-HOOD		IN-LINE		REMOTE		DISCHARGE	
CFM POWER	600	1200	800	1200	1000	1400	TOP	REAR
MODEL #	BS-CFM-600-IN06	BS-CFM-1200-IN12	ATEX-0.8	ATEX-1.2	HYEX-1.0-GA	HYEX-1.4-GA		
UMRP	\$ 965	\$ 1,385	\$ 1,260	\$ 1,510	\$ 1,385	\$ 1,640		
BZ030MLPLT	•	•	•	•	•	•	•	Available at time of order
BZ036MLPLT	•	•	•	•	•	•	•	
BZ042MLPLT	•	•	•	•	•	•	•	
BZ048MLPLT	•	•	•	•	•	•	•	
BZ054MLPLT	•	•	•	•	•	•	•	
BZ060MLPLT	•	•	•	•	•	•	•	
BZ066MLPLT	•	•	•	•	•	•	•	

## DESIGNER SERIES: 42", 48", 54", 60" & 66" BONANZA WALL HOODS



42", 48", 54" & 60" Bonanza Wall Hood

Standard Height: 18" | Standard Depth: 24"



66" Bonanza Wall Hood

Standard Height: 18" | Standard Depth: 24"

42" BONANZA HOODS: (4 Vertical Straps   1 Horizontal)		UMRP	MSRP
BZ042MLPLT	Body: Stainless Steel   Strap/Rivets: Stainless Steel	\$ 5,550	\$ 6,380
BZ042MLPLTD	Body: Stainless Steel   Strap/Rivets: Des. Metal*	\$ 5,860	\$ 6,740
BZ042MLPLTC	Body: Std RAL Color*   Strap/Rivets: Stainless Steel	\$ 6,975	\$ 8,020
BZ042MLPLTDC	Body: Std RAL Color*   Strap/Rivets: Des Metal*	\$ 7,285	\$ 8,380
BZ042MLPLTCF	Body: Spec. Finish*   Strap/Rivets: Stainless Steel	\$ 8,075	\$ 9,285
BZ042MLPLTDCF	Body: Spec. Finish*   Strap/Rivets: Des. Metal*	\$ 8,385	\$ 9,645
BZ042MLPLTCC	Body: Custom Color*   Strap/Rivets: Stainless Steel	\$ 9,505	\$ 10,930
BZ042MLPLTDCC	Body: Custom Color*   Strap/Rivets: Des. Metal*	\$ 9,815	\$ 11,285
48" BONANZA HOODS: (4 Vertical Straps   1 Horizontal)		UMRP	MSRP
BZ048MLPLT	Body: Stainless Steel   Strap/Rivets: Stainless Steel	\$ 6,030	\$ 6,935
BZ048MLPLTD	Body: Stainless Steel   Strap/Rivets: Des. Metal*	\$ 6,340	\$ 7,290
BZ048MLPLTC	Body: Std RAL Color*   Strap/Rivets: Stainless Steel	\$ 7,455	\$ 8,575
BZ048MLPLTDC	Body: Std RAL Color*   Strap/Rivets: Des Metal*	\$ 7,765	\$ 8,930
BZ048MLPLTCF	Body: Spec. Finish*   Strap/Rivets: Stainless Steel	\$ 8,555	\$ 9,840
BZ048MLPLTDCF	Body: Spec. Finish*   Strap/Rivets: Des. Metal*	\$ 8,865	\$ 10,195
BZ048MLPLTCC	Body: Custom Color*   Strap/Rivets: Stainless Steel	\$ 9,985	\$ 11,485
BZ048MLPLTDCC	Body: Custom Color*   Strap/Rivets: Des. Metal*	\$ 10,295	\$ 11,840
54" BONANZA HOODS: (4 Vertical Straps   1 Horizontal)		UMRP	MSRP
BZ054MLPLT	Body: Stainless Steel   Strap/Rivets: Stainless Steel	\$ 6,155	\$ 7,080
BZ054MLPLTD	Body: Stainless Steel   Strap/Rivets: Des. Metal*	\$ 6,465	\$ 7,435
BZ054MLPLTC	Body: Std RAL Color*   Strap/Rivets: Stainless Steel	\$ 7,580	\$ 8,715
BZ054MLPLTDC	Body: Std RAL Color*   Strap/Rivets: Des Metal*	\$ 7,890	\$ 9,075
BZ054MLPLTCF	Body: Spec. Finish*   Strap/Rivets: Stainless Steel	\$ 8,680	\$ 9,980
BZ054MLPLTDCF	Body: Spec. Finish*   Strap/Rivets: Des. Metal*	\$ 8,990	\$ 10,340
BZ054MLPLTCC	Body: Custom Color*   Strap/Rivets: Stainless Steel	\$ 10,110	\$ 11,625
BZ054MLPLTDCC	Body: Custom Color*   Strap/Rivets: Des. Metal*	\$ 10,420	\$ 11,985
60" BONANZA HOODS: (4 Vertical Straps   1 Horizontal)		UMRP	MSRP
BZ060MLPLT	Body: Stainless Steel   Strap/Rivets: Stainless Steel	\$ 6,635	\$ 7,630
BZ060MLPLTD	Body: Stainless Steel   Strap/Rivets: Des. Metal*	\$ 6,945	\$ 7,985
BZ060MLPLTC	Body: Std RAL Color*   Strap/Rivets: Stainless Steel	\$ 8,060	\$ 9,270
BZ060MLPLTDC	Body: Std RAL Color*   Strap/Rivets: Des Metal*	\$ 8,370	\$ 9,625
BZ060MLPLTCF	Body: Spec. Finish*   Strap/Rivets: Stainless Steel	\$ 9,160	\$ 10,535
BZ060MLPLTDCF	Body: Spec. Finish*   Strap/Rivets: Des. Metal*	\$ 9,470	\$ 10,890
BZ060MLPLTCC	Body: Custom Color*   Strap/Rivets: Stainless Steel	\$ 10,590	\$ 12,180
BZ060MLPLTDCC	Body: Custom Color*   Strap/Rivets: Des. Metal*	\$ 10,900	\$ 12,535
66" BONANZA HOODS: (5 Vertical Straps   1 Horizontal)		UMRP	MSRP
BZ066MLPLT	Body: Stainless Steel   Strap/Rivets: Stainless Steel	\$ 6,755	\$ 7,770
BZ066MLPLTD	Body: Stainless Steel   Strap/Rivets: Des. Metal*	\$ 7,065	\$ 8,125
BZ066MLPLTC	Body: Std RAL Color*   Strap/Rivets: Stainless Steel	\$ 8,180	\$ 9,405
BZ066MLPLTDC	Body: Std RAL Color*   Strap/Rivets: Des Metal*	\$ 8,490	\$ 9,765
BZ066MLPLTCF	Body: Spec. Finish*   Strap/Rivets: Stainless Steel	\$ 9,280	\$ 10,670
BZ066MLPLTDCF	Body: Spec. Finish*   Strap/Rivets: Des. Metal*	\$ 9,590	\$ 11,030
BZ066MLPLTCC	Body: Custom Color*   Strap/Rivets: Stainless Steel	\$ 10,710	\$ 12,315
BZ066MLPLTDCC	Body: Custom Color*   Strap/Rivets: Des. Metal*	\$ 11,020	\$ 12,675

## DUCT COVERS: BONANZA WALL HOODS

**NOTE: DUCT COVER MUST BE ORDERED WITH HOOD FOR QUALITY ASSURANCE.**

**NOTE: STRAPPING AND RIVETS ON DUCT COVER MUST MATCH HOOD. MUST BE SPECIFIED ON ORDER.**

SIZE	MODEL	HEIGHT	UMRP	MSRP
<b>Available Duct Covers for 30" Models</b>	DCBZ03002H	2"	\$ 625	\$ 720
	DCBZ03002	2"	No charge when ordered with Bonanza style hood.  Must be ordered with hood for quality assurance.	
	DCBZ03006	6"		
	DCBZ03012	12"		
	DCBZ03018	18"		
	DCBZ03024	24"		
	DCBZ03030	30"		
	DCBZ03036	36"		
	DCBZ03042	42"		
	DCBZ03048	48"		
<b>Available Duct Covers for 36" Models</b>	DCBZ03602H	2"		
	DCBZ03602	2"	No charge when ordered with Bonanza style hood.  Must be ordered with hood for quality assurance.	
	DCBZ03606	6"		
	DCBZ03612	12"		
	DCBZ03618	18"		
	DCBZ03624	24"		
	DCBZ03630	30"		
	DCBZ03636	36"		
	DCBZ03642	42"		
	DCBZ03648	48"		
<b>Available Duct Covers for 42" Models</b>	DCBZ04202H	2"		
	DCBZ04202	2"	No charge when ordered with Bonanza style hood.  Must be ordered with hood for quality assurance.	
	DCBZ04206	6"		
	DCBZ04212	12"		
	DCBZ042018	18"		
	DCBZ04224	24"		
	DCBZ04230	30"		
	DCBZ04236	36"		
	DCBZ04242	42"		
	DCBZ04248	48"		
<b>Available Duct Covers for 48" Models</b>	DCBZ04802H	2"		
	DCBZ04802	2"	No charge when ordered with Bonanza style hood.  Must be ordered with hood for quality assurance.	
	DCBZ04806	6"		
	DCBZ04812	12"		
	DCBZ04818	18"		
	DCBZ04824	24"		
	DCBZ04830	30"		
	DCBZ04836	36"		
	DCBZ04842	42"		
	DCBZ04848	48"		

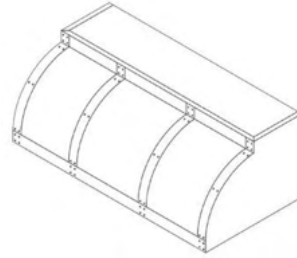

**Version: DCBZ0xx2H**  
Two horizontal straps

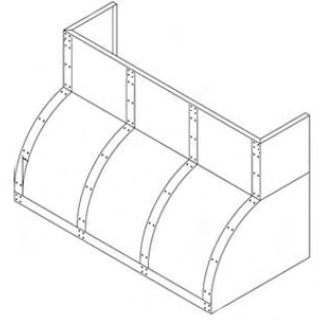

**Version: DCBZ0xxxx**  
One horizontal – All others vertical

SIZE	MODEL	HEIGHT	UMRP	MSRP
<b>Available Duct Covers for 54" Models</b>	DCBZ05402H	2"	\$ 625	\$ 720
	DCBZ05402	2"	No charge when ordered with Bonanza style hood.  Must be ordered with hood for quality assurance.	
	DCBZ05406	6"		
	DCBZ05412	12"		
	DCBZ05418	18"		
	DCBZ05424	24"		
	DCBZ05430	30"		
	DCBZ05436	36"		
	DCBZ05442	42"		
	DCBZ05448	48"		
<b>Available Duct Covers for 60" Models</b>	DCBZ06002H	2"		
	DCBZ06002	2"	No charge when ordered with Bonanza style hood.  Must be ordered with hood for quality assurance.	
	DCBZ06006	6"		
	DCBZ06012	12"		
	DCBZ06018	18"		
	DCBZ06024	24"		
	DCBZ06030	30"		
	DCBZ06036	36"		
	DCBZ06042	42"		
	DCBZ06048	48"		
<b>Available Duct Covers for 66" Models</b>	DCBZ06602H	2"		
	DCBZ06602	2"	No charge when ordered with Bonanza style hood.  Must be ordered with hood for quality assurance.	
	DCBZ06606	6"		
	DCBZ06612	12"		
	DCBZ06618	18"		
	DCBZ06624	24"		
	DCBZ06630	30"		
	DCBZ06636	36"		
	DCBZ06642	42"		
	DCBZ06648	48"		

# DESIGNER SERIES: 30" & 36" SAHARA CURVED SIDES WALL HOODS

REQUEST A QUOTE  
QUOTE@BLUESTARCOOKING.COM

BlueStar Model Number Guide:	<b>Base Model (SC0XXMLPLT)</b>	<b>Add code below for desired color</b>	<b>Add (PLT) for Metal Strapping</b>
	Sahara Curved   Unit Width   Internal Liner Type   Brushed Stainless Steel Strapping & Rivets	(C) 190 Standard RAL (Semi-Gloss) Colors (CF) Specialty Finish (190 Matte RAL, Precious Metals & Textures) (CC) Custom Colors	Standard: Brushed Stainless Steel See below for Designer Metal strapping and rivet options



30" & 36" Sahara Curved Sides Wall Hood

Standard Height: 30" | Standard Depth: 24"

**FEATURES:**

- Professional-grade performance with three exhaust settings and new Boost feature
- Whisper quiet operation
- Heavy duty, commercial grade materials
- Dimmable LED lighting
- Easy-to-use push-button controls
- Innovative, multi-stage grease capture system
- Stainless baffle filters seamlessly remove for easy dishwasher cleaning
- Choose from stainless steel or 1,000+ colors and finishes
- Simple installation
- 30" & 36" models: 600 CFM internal fan included **(Must be included on order)**
- Available with top or rear discharge - Discharge is field reversible.
- In-line, in-hood and remote blower compatible

**CUSTOMIZATION OPTIONS:**

- 1,000+ Colors & Finishes
- Designer Metals like brass & copper
- Custom strapping & rivets
- Full custom options

Model	Description (* Denotes item that must be specified)	UMRP	MSRP
<b>30" SAHARA CURVED SIDES HOODS:</b>			
SC030MLPLT	<b>Body:</b> Stainless Steel   <b>Strap/Rivets:</b> Stainless Steel   600 CFM	\$ 6,030	\$ 6,935
SC030MLPLTD	<b>Body:</b> Stainless Steel   <b>Strap/Rivets:</b> Des. Metal*   600 CFM	\$ 6,265	\$ 7,205
SC030MLPLTC	<b>Body:</b> Std RAL Color*   <b>Strap/Rivets:</b> Stainless Steel   600 CFM	\$ 7,125	\$ 8,195
SC030MLPLTDC	<b>Body:</b> Std RAL Color*   <b>Strap/Rivets:</b> Des Metal*   600 CFM	\$ 7,360	\$ 8,465
SC030MLPLTCF	<b>Body:</b> Spec. Finish*   <b>Strap/Rivets:</b> Stainless Steel   600 CFM	\$ 8,115	\$ 9,330
SC030MLPLTDCF	<b>Body:</b> Spec. Finish*   <b>Strap/Rivets:</b> Des. Metal*   600 CFM	\$ 8,350	\$ 9,605
SC030MLPLTCC	<b>Body:</b> Custom Color*   <b>Strap/Rivets:</b> Stainless Steel   600 CFM	\$ 9,545	\$ 10,975
SC030MLPLTDCC	<b>Body:</b> Custom Color*   <b>Strap/Rivets:</b> Des. Metal*   600 CFM	\$ 9,780	\$ 11,245
<b>36" SAHARA CURVED SIDES HOODS:</b>			
SC036MLPLT	<b>Body:</b> Stainless Steel   <b>Strap/Rivets:</b> Stainless Steel   600 CFM	\$ 6,635	\$ 7,630
SC036MLPLTD	<b>Body:</b> Stainless Steel   <b>Strap/Rivets:</b> Des. Metal*   600 CFM	\$ 6,945	\$ 7,985
SC036MLPLTC	<b>Body:</b> Std RAL Color*   <b>Strap/Rivets:</b> Stainless Steel   600 CFM	\$ 7,730	\$ 8,890
SC036MLPLTDC	<b>Body:</b> Std RAL Color*   <b>Strap/Rivets:</b> Des Metal*   600 CFM	\$ 8,040	\$ 9,245
SC036MLPLTCF	<b>Body:</b> Spec. Finish*   <b>Strap/Rivets:</b> Stainless Steel   600 CFM	\$ 8,720	\$ 10,030
SC036MLPLTDCF	<b>Body:</b> Spec. Finish*   <b>Strap/Rivets:</b> Des. Metal*   600 CFM	\$ 9,030	\$ 10,385
SC036MLPLTCC	<b>Body:</b> Custom Color*   <b>Strap/Rivets:</b> Stainless Steel   600 CFM	\$ 10,150	\$ 11,675
SC036MLPLTDCC	<b>Body:</b> Custom Color*   <b>Strap/Rivets:</b> Des. Metal*   600 CFM	\$ 10,460	\$ 12,030
<b>DESIGNER METAL OPTIONS FOR STRAPPING &amp; RIVETS:</b>			
Polished Stainless	Antique Brass	Brushed Brass	Polished Brass
Antique Copper	Brushed Copper	Polished Copper	Pewter
<b>VENTILATION HOOD ACCESSORIES:</b>			
Refer to page 102 for Ventilation Hood Accessories			

(\* Trim finishes on Cooking & Refrigeration products are different substrates than the trim finishes on Ventilation hoods. Due to these differing processes and substrates the finishes will coordinate but may not match exactly.

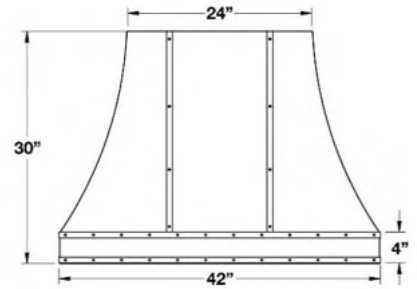
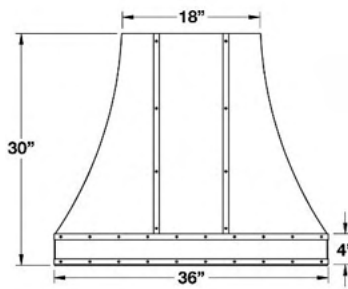
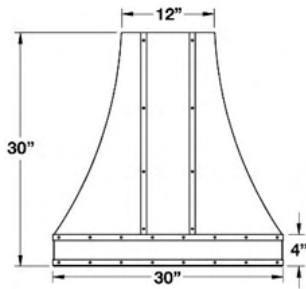

BLOWER OPTIONS	IN-HOOD		IN-LINE		REMOTE		DISCHARGE	
	600	1200	800	1200	1000	1400	TOP	REAR
MODEL #	BS-CFM-600-IN06	BS-CFM-1200-IN12	ATEX-0.8	ATEX-1.2	HYEX-1.0-GA	HYEX-1.4-GA		
UMRP	\$ 965	\$ 1,385	\$ 1,260	\$ 1,510	\$ 1,385	\$ 1,640		
SC030MLPLT	•		•	•	•	•	•	Available at time of order
SC036MLPLT	•	•	•	•	•	•	•	
SC042MLPLT	•	•	•	•	•	•	•	
SC048MLPLT	•	•	•	•	•	•	•	
SC054MLPLT	•	•	•	•	•	•	•	
SC060MLPLT	•	•	•	•	•	•	•	

# DESIGNER SERIES: 42", 48", 54" & 60" SAHARA CURVED SIDES WALL HOODS



42" SAHARA CURVED SIDES HOODS:		UMRP	MSRP
SC042MLPLT	Body: Stainless Steel   Strap/Rivets: Stainless Steel	\$ 6,875	\$ 7,905
SC042MLPLTD	Body: Stainless Steel   Strap/Rivets: Des. Metal*	\$ 7,185	\$ 8,265
SC042MLPLTC	Body: Std RAL Color*   Strap/Rivets: Stainless Steel	\$ 8,300	\$ 9,545
SC042MLPLTDC	Body: Std RAL Color*   Strap/Rivets: Des Metal*	\$ 8,610	\$ 9,900
SC042MLPLTCF	Body: Spec. Finish*   Strap/Rivets: Stainless Steel	\$ 9,400	\$ 10,810
SC042MLPLTDCF	Body: Spec. Finish*   Strap/Rivets: Des. Metal*	\$ 9,710	\$ 11,165
SC042MLPLTCC	Body: Custom Color*   Strap/Rivets: Stainless Steel	\$ 10,830	\$ 12,455
SC042MLPLTDCC	Body: Custom Color*   Strap/Rivets: Des. Metal*	\$ 11,140	\$ 12,810

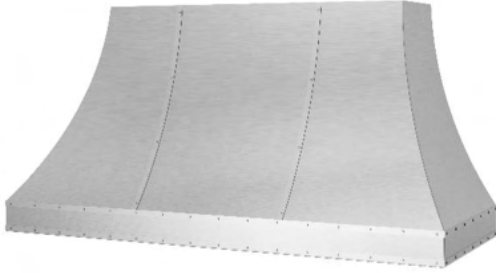

48" SAHARA CURVED SIDES HOODS:		UMRP	MSRP
SC048MLPLT	Body: Stainless Steel   Strap/Rivets: Stainless Steel	\$ 8,810	\$ 10,130
SC048MLPLTD	Body: Stainless Steel   Strap/Rivets: Des. Metal*	\$ 9,120	\$ 10,490
SC048MLPLTC	Body: Std RAL Color*   Strap/Rivets: Stainless Steel	\$ 10,235	\$ 11,770
SC048MLPLTDC	Body: Std RAL Color*   Strap/Rivets: Des Metal*	\$ 10,545	\$ 12,125
SC048MLPLTCF	Body: Spec. Finish*   Strap/Rivets: Stainless Steel	\$ 11,335	\$ 13,035
SC048MLPLTDCF	Body: Spec. Finish*   Strap/Rivets: Des. Metal*	\$ 11,645	\$ 13,390
SC048MLPLTCC	Body: Custom Color*   Strap/Rivets: Stainless Steel	\$ 12,765	\$ 14,680
SC048MLPLTDCC	Body: Custom Color*   Strap/Rivets: Des. Metal*	\$ 13,075	\$ 15,035

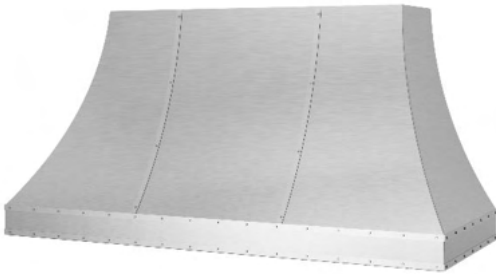

54" SAHARA CURVED SIDES HOODS:		UMRP	MSRP
SC054MLPLT	Body: Stainless Steel   Strap/Rivets: Stainless Steel	\$ 9,170	\$ 10,545
SC054MLPLTD	Body: Stainless Steel   Strap/Rivets: Des. Metal*	\$ 9,480	\$ 10,900
SC054MLPLTC	Body: Std RAL Color*   Strap/Rivets: Stainless Steel	\$ 10,595	\$ 12,185
SC054MLPLTDC	Body: Std RAL Color*   Strap/Rivets: Des Metal*	\$ 10,905	\$ 12,540
SC054MLPLTCF	Body: Spec. Finish*   Strap/Rivets: Stainless Steel	\$ 11,695	\$ 13,450
SC054MLPLTDCF	Body: Spec. Finish*   Strap/Rivets: Des. Metal*	\$ 12,005	\$ 13,805
SC054MLPLTCC	Body: Custom Color*   Strap/Rivets: Stainless Steel	\$ 13,125	\$ 15,095
SC054MLPLTDCC	Body: Custom Color*   Strap/Rivets: Des. Metal*	\$ 13,435	\$ 15,450

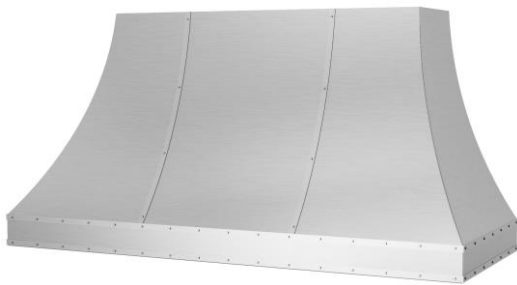

60" SAHARA CURVED SIDES HOODS:		UMRP	MSRP
SC060MLPLT	Body: Stainless Steel   Strap/Rivets: Stainless Steel	\$ 10,620	\$ 12,215
SC060MLPLTD	Body: Stainless Steel   Strap/Rivets: Des. Metal*	\$ 10,930	\$ 12,570
SC060MLPLTC	Body: Std RAL Color*   Strap/Rivets: Stainless Steel	\$ 12,045	\$ 13,850
SC060MLPLTDC	Body: Std RAL Color*   Strap/Rivets: Des Metal*	\$ 12,355	\$ 14,210
SC060MLPLTCF	Body: Spec. Finish*   Strap/Rivets: Stainless Steel	\$ 13,145	\$ 15,115
SC060MLPLTDCF	Body: Spec. Finish*   Strap/Rivets: Des. Metal*	\$ 13,455	\$ 15,475
SC060MLPLTCC	Body: Custom Color*   Strap/Rivets: Stainless Steel	\$ 14,575	\$ 16,760
SC060MLPLTDCC	Body: Custom Color*   Strap/Rivets: Des. Metal*	\$ 14,885	\$ 17,120

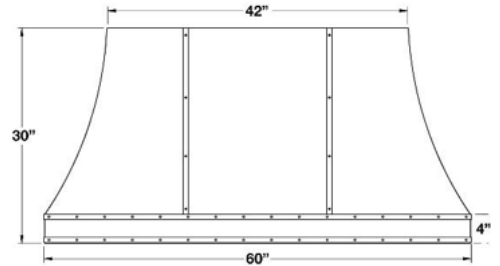
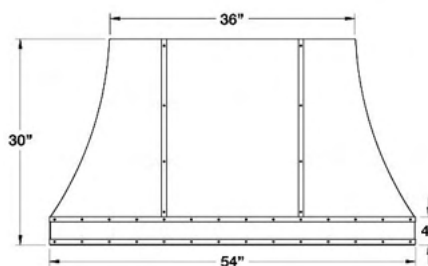
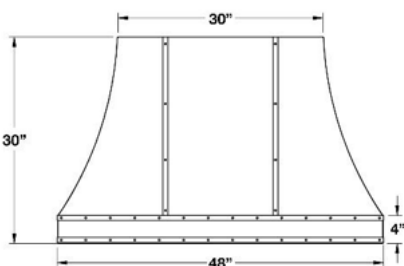

# DESIGNER SERIES: 30" & 36" WRANGLER WALL HOODS

REQUEST A QUOTE  
QUOTE@BLUESTARCOOKING.COM

BlueStar Model Number Guide:	<b>Base Model (WROXXMLPLT)</b>	<b>Add code below for desired color</b>	<b>Add (PLT) for Metal Strapping</b>
	Wrangler   Unit Width   Internal Liner Type   Brushed Stainless Steel Strapping & Rivets	(C) 190 Standard RAL (Semi-Gloss) Colors (CF) Specialty Finish (190 Matte RAL, Precious Metals & Textures) (CC) Custom Colors	Standard: Brushed Stainless Steel See below for Designer Metal strapping and rivet options

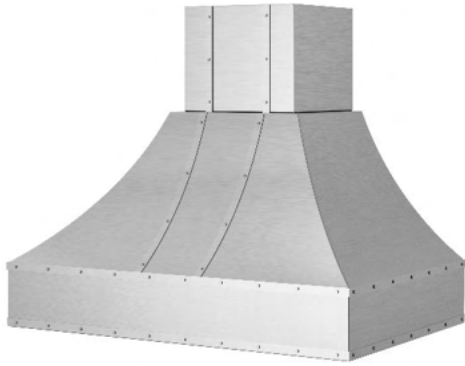

30" & 36" Wrangler Wall Hood

Standard Height: 20" | Bottom Depth: 24" | Top Depth: 13"

**FEATURES:**

- Professional-grade performance with three exhaust settings and new Boost feature
- Whisper quiet operation
- Heavy duty, commercial grade materials
- Dimmable LED lighting
- Easy-to-use push-button controls
- Innovative, multi-stage grease capture system
- Stainless baffle filters seamlessly remove for easy dishwasher cleaning
- Choose from stainless steel or 1,000+ colors and finishes
- Simple installation
- 30" & 36" models: 600 CFM internal fan included **(Must be included on order)**
- Included duct cover heights: 10", 16", 22", 28", 34", 40", 46". Must be specified on order.
- Available with top or rear discharge - Discharge is field reversible.
- In-line, in-hood and remote blower compatible

**CUSTOMIZATION OPTIONS:**

- 1,000+ Colors & Finishes
- Designer Metals like brass & copper
- Custom strapping & rivets
- Full custom options

(\* Trim finishes on Cooking & Refrigeration products are different substrates than the trim finishes on Ventilation hoods. Due to these differing processes and substrates the finishes will coordinate but may not match exactly.

Model	Description (* Denotes item that must be specified)	UMRP	MSRP
<b>30" WRANGLER HOODS:</b>			
WR030MLPLT	Body: Stainless Steel   Strap/Rivets: Stainless Steel   600 CFM	\$ 7,600	\$ 8,740
WR030MLPLTD	Body: Stainless Steel   Strap/Rivets: Des. Metal*   600 CFM	\$ 8,715	\$ 10,020
WR030MLPLTTC	Body: Std RAL Color*   Strap/Rivets: Stainless Steel   600 CFM	\$ 8,695	\$ 10,000
WR030MLPLTDC	Body: Std RAL Color*   Strap/Rivets: Des Metal*   600 CFM	\$ 9,810	\$ 11,280
WR030MLPLTCF	Body: Spec. Finish*   Strap/Rivets: Stainless Steel   600 CFM	\$ 9,685	\$ 11,140
WR030MLPLTDCF	Body: Spec. Finish*   Strap/Rivets: Des. Metal*   600 CFM	\$ 10,800	\$ 12,420
WR030MLPLTCC	Body: Custom Color*   Strap/Rivets: Stainless Steel   600 CFM	\$ 11,115	\$ 12,780
WR030MLPLTDCC	Body: Custom Color*   Strap/Rivets: Des. Metal*   600 CFM	\$ 12,230	\$ 14,065
<b>36" WRANGLER HOODS:</b>			
WR036MLPLT	Body: Stainless Steel   Strap/Rivets: Stainless Steel   600 CFM	\$ 7,845	\$ 9,020
WR036MLPLTD	Body: Stainless Steel   Strap/Rivets: Des. Metal*   600 CFM	\$ 9,230	\$ 10,615
WR036MLPLTTC	Body: Std RAL Color*   Strap/Rivets: Stainless Steel   600 CFM	\$ 8,940	\$ 10,280
WR036MLPLTDC	Body: Std RAL Color*   Strap/Rivets: Des Metal*   600 CFM	\$ 10,325	\$ 11,875
WR036MLPLTCF	Body: Spec. Finish*   Strap/Rivets: Stainless Steel   600 CFM	\$ 9,930	\$ 11,420
WR036MLPLTDCF	Body: Spec. Finish*   Strap/Rivets: Des. Metal*   600 CFM	\$ 11,315	\$ 13,010
WR036MLPLTCC	Body: Custom Color*   Strap/Rivets: Stainless Steel   600 CFM	\$ 11,360	\$ 13,065
WR036MLPLTDCC	Body: Custom Color*   Strap/Rivets: Des. Metal*   600 CFM	\$ 12,745	\$ 14,655
<b>DESIGNER METAL OPTIONS FOR STRAPPING &amp; RIVETS:</b>			
Polished Stainless	Antique Brass	Brushed Brass	Polished Brass
Antique Copper	Brushed Copper	Polished Copper	Pewter
<b>DUCT COVERS FOR WRANGLER HOODS:</b>			
Refer to page 94 for all Wrangler hood duct cover options			
• Included duct cover heights: 10", 16", 22", 28", 34", 40", 46"			
Refer to page 102 for Ventilation Hood Accessories			

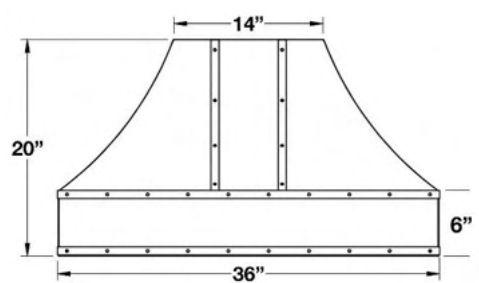
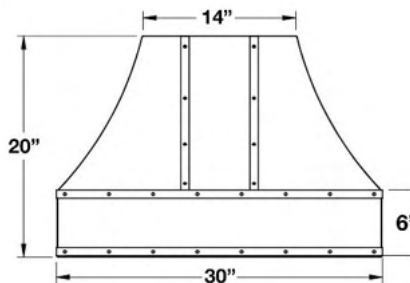

BLOWER OPTIONS	IN-HOOD		IN-LINE		REMOTE		DISCHARGE	
CFM POWER	600	1200	800	1200	1000	1400	TOP	REAR
MODEL #	BS-CFM-600-IN06	BS-CFM-1200-IN12	ATEX-0.8	ATEX-1.2	HYEX-1.0-GA	HYEX-1.4-GA		
UMRP	\$ 965	\$ 1,385	\$ 1,260	\$ 1,510	\$ 1,385	\$ 1,640	Available at time of order	
WR030MLPLT	•		•	•	•	•		
WR036MLPLT	•	•	•	•	•	•		
WR042MLPLT	•	•	•	•	•	•		
WR048MLPLT	•	•	•	•	•	•		
WR054MLPLT	•	•	•	•	•	•		
WR060MLPLT	•	•	•	•	•	•		
WR066MLPLT	•	•	•	•	•	•		

## DESIGNER SERIES: 42", 48", 54", 60" & 66" WRANGLER WALL HOODS

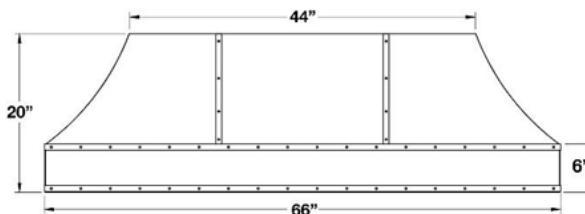
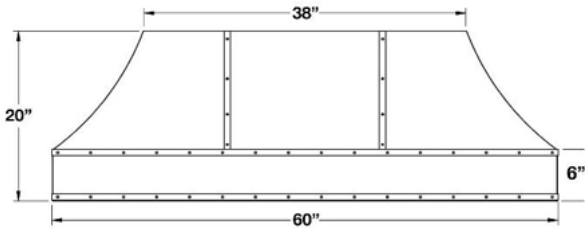
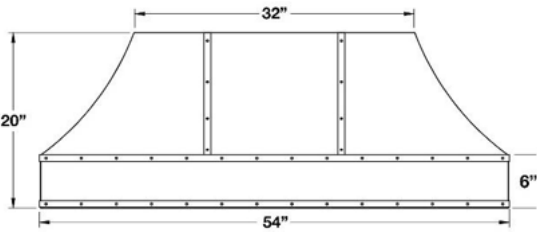
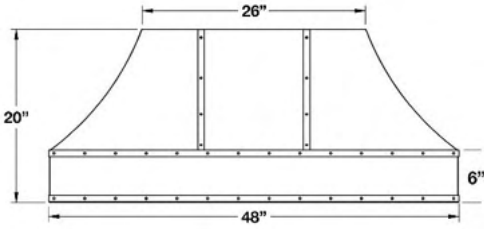
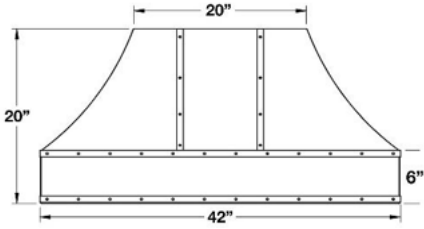

42" WRANGLER HOODS		UMRP	MSRP
WR042MLPLT	Body: Stainless Steel   Strap/Rivets: Stainless Steel	\$ 7,965	\$ 9,160
WR042MLPLTD	Body: Stainless Steel   Strap/Rivets: Des. Metal*	\$ 9,350	\$ 10,755
WR042MLPLTC	Body: Std RAL Color*   Strap/Rivets: Stainless Steel	\$ 9,390	\$ 10,800
WR042MLPLTDC	Body: Std RAL Color*   Strap/Rivets: Des Metal*	\$ 10,775	\$ 12,390
WR042MLPLTCF	Body: Spec. Finish*   Strap/Rivets: Stainless Steel	\$ 10,490	\$ 12,065
WR042MLPLTDCF	Body: Spec. Finish*   Strap/Rivets: Des. Metal*	\$ 11,875	\$ 13,655
WR042MLPLTCC	Body: Custom Color*   Strap/Rivets: Stainless Steel	\$ 11,920	\$ 13,710
WR042MLPLTDCC	Body: Custom Color*   Strap/Rivets: Des. Metal*	\$ 13,305	\$ 15,300
48" WRANGLER HOODS		UMRP	MSRP
WR048MLPLT	Body: Stainless Steel   Strap/Rivets: Stainless Steel	\$ 8,085	\$ 9,300
WR048MLPLTD	Body: Stainless Steel   Strap/Rivets: Des. Metal*	\$ 9,805	\$ 11,275
WR048MLPLTC	Body: Std RAL Color*   Strap/Rivets: Stainless Steel	\$ 9,510	\$ 10,935
WR048MLPLTDC	Body: Std RAL Color*   Strap/Rivets: Des Metal*	\$ 11,230	\$ 12,915
WR048MLPLTCF	Body: Spec. Finish*   Strap/Rivets: Stainless Steel	\$ 10,610	\$ 12,200
WR048MLPLTDCF	Body: Spec. Finish*   Strap/Rivets: Des. Metal*	\$ 12,330	\$ 14,180
WR048MLPLTCC	Body: Custom Color*   Strap/Rivets: Stainless Steel	\$ 12,040	\$ 13,845
WR048MLPLTDCC	Body: Custom Color*   Strap/Rivets: Des. Metal*	\$ 13,760	\$ 15,825
54" WRANGLER HOODS		UMRP	MSRP
WR054MLPLT	Body: Stainless Steel   Strap/Rivets: Stainless Steel	\$ 8,205	\$ 9,435
WR054MLPLTD	Body: Stainless Steel   Strap/Rivets: Des. Metal*	\$ 9,925	\$ 11,415
WR054MLPLTC	Body: Std RAL Color*   Strap/Rivets: Stainless Steel	\$ 9,630	\$ 11,075
WR054MLPLTDC	Body: Std RAL Color*   Strap/Rivets: Des Metal*	\$ 11,350	\$ 13,050
WR054MLPLTCF	Body: Spec. Finish*   Strap/Rivets: Stainless Steel	\$ 10,730	\$ 12,340
WR054MLPLTDCF	Body: Spec. Finish*   Strap/Rivets: Des. Metal*	\$ 12,450	\$ 14,315
WR054MLPLTCC	Body: Custom Color*   Strap/Rivets: Stainless Steel	\$ 12,160	\$ 13,985
WR054MLPLTDCC	Body: Custom Color*   Strap/Rivets: Des. Metal*	\$ 13,880	\$ 15,960
60" WRANGLER HOODS		UMRP	MSRP
WR060MLPLT	Body: Stainless Steel   Strap/Rivets: Stainless Steel	\$ 8,325	\$ 9,575
WR060MLPLTD	Body: Stainless Steel   Strap/Rivets: Des. Metal*	\$ 10,300	\$ 11,845
WR060MLPLTC	Body: Std RAL Color*   Strap/Rivets: Stainless Steel	\$ 9,750	\$ 11,215
WR060MLPLTDC	Body: Std RAL Color*   Strap/Rivets: Des Metal*	\$ 11,725	\$ 13,485
WR060MLPLTCF	Body: Spec. Finish*   Strap/Rivets: Stainless Steel	\$ 10,850	\$ 12,475
WR060MLPLTDCF	Body: Spec. Finish*   Strap/Rivets: Des. Metal*	\$ 12,825	\$ 14,750
WR060MLPLTCC	Body: Custom Color*   Strap/Rivets: Stainless Steel	\$ 12,280	\$ 14,120
WR060MLPLTDCC	Body: Custom Color*   Strap/Rivets: Des. Metal*	\$ 14,255	\$ 16,395
66" WRANGLER HOODS		UMRP	MSRP
WR066MLPLT	Body: Stainless Steel   Strap/Rivets: Stainless Steel	\$ 8,445	\$ 9,710
WR066MLPLTD	Body: Stainless Steel   Strap/Rivets: Des. Metal*	\$ 10,920	\$ 12,560
WR066MLPLTC	Body: Std RAL Color*   Strap/Rivets: Stainless Steel	\$ 9,870	\$ 11,350
WR066MLPLTDC	Body: Std RAL Color*   Strap/Rivets: Des Metal*	\$ 12,345	\$ 14,195
WR066MLPLTCF	Body: Spec. Finish*   Strap/Rivets: Stainless Steel	\$ 10,970	\$ 12,615
WR066MLPLTDCF	Body: Spec. Finish*   Strap/Rivets: Des. Metal*	\$ 13,445	\$ 15,460
WR066MLPLTCC	Body: Custom Color*   Strap/Rivets: Stainless Steel	\$ 12,400	\$ 14,260
WR066MLPLTDCC	Body: Custom Color*   Strap/Rivets: Des. Metal*	\$ 14,875	\$ 17,105

## DUCT COVERS: WRANGLER WALL HOODS

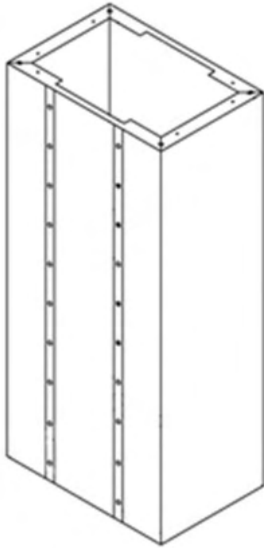

**NOTE: STRAPPING AND RIVETS ON DUCT COVER MUST MATCH HOOD. MUST BE SPECIFIED ON ORDER.**

**NOTE: DUCT COVER MUST BE ORDERED WITH HOOD FOR QUALITY ASSURANCE.**

SIZE	MODEL	HEIGHT	UMRP	MSRP
Available Duct Covers for 30" Models  Duct Width: 12"	DCWW03010	10"	No charge when ordered with Wrangler style hood.  Must be ordered with hood for quality assurance.	
	DCWW03016	16"		
	DCWW03022	22"		
	DCWW03028	28"		
	DCWW03034	34"		
	DCWW03040	40"		
	DCWW03046	46"		
Available Duct Covers for 36" Models  Duct Width: 12"	DCWW03610	10"	No charge when ordered with Wrangler style hood.  Must be ordered with hood for quality assurance.	
	DCWW03616	16"		
	DCWW03622	22"		
	DCWW03628	28"		
	DCWW03634	34"		
	DCWW03640	40"		
	DCWW03646	46"		
Available Duct Covers for 42" Models  Duct Width: 18"	DCWW04210	10"	No charge when ordered with Wrangler style hood.  Must be ordered with hood for quality assurance.	
	DCWW04216	16"		
	DCWW04222	22"		
	DCWW04228	28"		
	DCWW04234	34"		
	DCWW04240	40"		
	DCWW04246	46"		

SIZE	MODEL	HEIGHT	UMRP	MSRP
Available Duct Covers for 48" Models  Duct Width: 24"	DCWW04810	10"	No charge when ordered with Wrangler style hood.  Must be ordered with hood for quality assurance.	
	DCWW04816	16"		
	DCWW04822	22"		
	DCWW04828	28"		
	DCWW04834	34"		
	DCWW04840	40"		
Available Duct Covers for 54" Models  Duct Width: 30"	DCWW05410	10"	No charge when ordered with Wrangler style hood.  Must be ordered with hood for quality assurance.	
	DCWW05416	16"		
	DCWW05422	22"		
	DCWW05428	28"		
	DCWW05434	34"		
	DCWW05440	40"		
Available Duct Covers for 60" Models  Duct Width: 34"	DCWW06010	10"	No charge when ordered with Wrangler style hood.  Must be ordered with hood for quality assurance.	
	DCWW06016	16"		
	DCWW06022	22"		
	DCWW06028	28"		
	DCWW06034	34"		
	DCWW06040	40"		
Available Duct Covers for 66" Models  Duct Width: 42"	DCWW06610	10"	No charge when ordered with Wrangler style hood.  Must be ordered with hood for quality assurance.	
	DCWW06616	16"		
	DCWW06622	22"		
	DCWW06628	28"		
	DCWW06634	34"		
	DCWW06640	40"		
DCWW06646	46"			

DESIGNER SERIES: MANHATTAN ISLAND HOODS

<b>BlueStar Model Number Guide:</b>	<b>Base Model (BS-MANH-I-XX-SS)</b> Manhattan Island   Unit Width	<b>Add code below for desired color</b> Reference color pricing below	<b>Add (PLT) for Metal Strapping</b> Available through custom quote only at <a href="mailto:quote@bluestarcooking.com">quote@bluestarcooking.com</a>
-------------------------------------	----------------------------------------------------------------------	--------------------------------------------------------------------------	---------------------------------------------------------------------------------------------------------------------------------------------------------



Standard Height: 6" | Standard Depth: 34"

**FEATURES:**

- Commercial grade stainless steel construction
- Welded seamless corners
- Commercial style stainless steel baffle filter system
- 3-speed blower/variable light control
- 36" models: 600 CFM internal fan included **(Must be included on order)**
- Accommodates top discharge only
- Included duct cover heights: 18", 24", 30" & 36"
- **(Must be specified on order.)**
- Remote and In-line fans available

**CUSTOMIZATION OPTIONS:**

- 1,000+ Colors & Finishes
- Designer Metals like brass & copper
- Custom strapping & rivets
- Full custom options

(\*) Trim finishes on Cooking & Refrigeration products are different substrates than the trim finishes on Ventilation hoods. Due to these differing processes and substrates the finishes will coordinate but may not match exactly.

Model	Description (* Denotes item that must be specified)	UMRP	MSRP
BS-MANH-I-36-SS	36" Manhattan   Stainless Steel   600 CFM Blower	\$ 4,170	\$ 4,795
BS-MANH-I-42-SS	42" Manhattan   Stainless Steel	\$ 4,675	\$ 5,375
BS-MANH-I-48-SS	48" Manhattan   Stainless Steel	\$ 4,800	\$ 5,520
BS-MANH-I-54-SS	54" Manhattan   Stainless Steel	\$ 4,930	\$ 5,670
BS-MANH-I-60-SS	60" Manhattan   Stainless Steel	\$ 6,320	\$ 7,270
BS-MANH-I-66-SS	66" Manhattan   Stainless Steel	\$ 6,570	\$ 7,555
<b>COLOR OPTIONS:</b>			
Std RAL: 36"	Standard 190 RAL Colors: 36" Models	\$ 995	\$ 1,135
Std RAL: 42" – 66"	Standard 190 RAL Colors: 42" – 66" Models	\$ 1,295	\$ 1,475
Spec Finish: 30" & 36"	Specialty Finish: 30" & 36" Models	\$ 1,895	\$ 2,165
Spec Finish: 42" – 66"	Specialty Finish: 42" – 66" Models	\$ 2,295	\$ 2,615
Custom Color: 30" & 36"	Custom Color: 30" & 36" Models	\$ 3,195	\$ 3,645
Custom Color: 42" – 66"	Custom Color: 42" – 66" Models	\$ 3,595	\$ 4,095
<b>DUCT COVERS FOR MANHATTAN HOODS:</b>			
Refer to page 96 for all Manhattan Island hood duct cover options			
• Included duct cover heights: 18", 24", 30" & 36"   Also available in 42" & 48" for additional charge			
Refer to page 102 for Ventilation Hood Accessories			

**NOTE: HOOD MUST BE MOUNTED TO CEILING AND CEILING ACCESS MAY BE REQUIRED. PLEASE REFERENCE THE INSTALLATION MANUAL ON BLUESTARCOOKING.COM FOR DETAILS**

**NOTE: MUST ORDER DUCT COVER FOR BLOWER & MOUNTING PURPOSES. MINIMUM 18" HIGH**

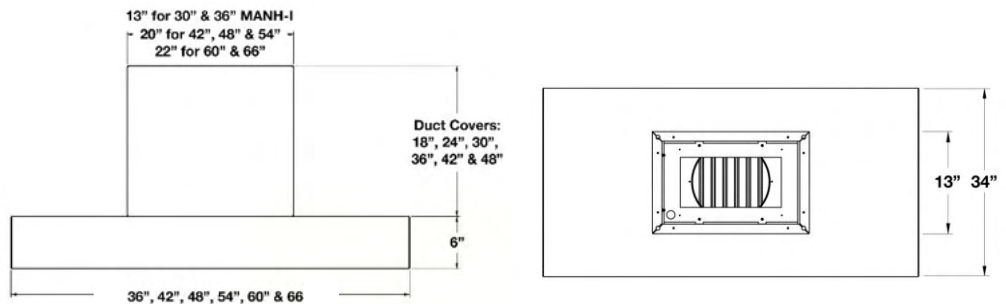

BLOWER OPTIONS	IN-HOOD		IN-LINE		REMOTE		DISCHARGE	
	600	1200	600	1200	1000	1400	TOP	REAR
CFM POWER	600	1200	600	1200	1000	1400		
MODEL #	PH-CFM-600	PH-CFM-1200	PH-INLB600	PH-INBL1200	PH-1000CFMR	PH-1400CFMR		
UMRP	\$ 965	\$ 1,385	\$ 1,520	\$ 1,875	\$ 1,890	\$ 2,020		
BS-MANH-I-36-SS	•		•	•	•	•	•	•
BS-MANH-I-42-SS	•	•	•	•	•	•	•	•
BS-MANH-I-48-SS	•	•	•	•	•	•	•	•
BS-MANH-I-54-SS	•	•	•	•	•	•	•	•
BS-MANH-I-60-SS	•	•	•	•	•	•	•	•
BS-MANH-I-66-SS	•	•	•	•	•	•	•	•

Denotes blower compatible with specific ventilation hood size. ATEX In-line and HY-EX Remote designated blowers are not compatible with this ventilation hood.

## DUCT COVERS: MANHATTAN ISLAND HOODS

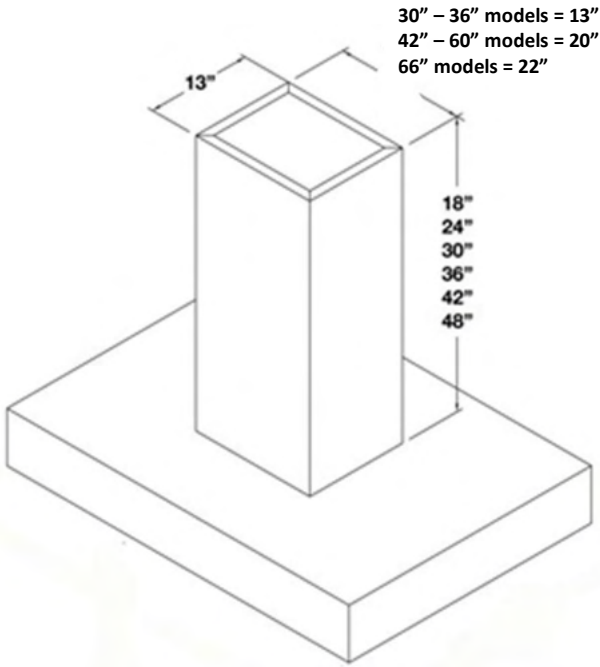

NOTE: 18", 24", 30" & 36" DUCT COVERS INCLUDED WITH HOOD AT NO CHARGE. BELOW PRICING IS IF PURCHASED SEPARATELY.

NOTE: HOOD MUST BE MOUNTED TO CEILING AND CEILING ACCESS MAY BE REQUIRED. PLEASE REFERENCE THE INSTALLATION MANUAL ON [BLUESTARCOOKING.COM](http://BLUESTARCOOKING.COM) FOR DETAILS

NOTE: MUST ORDER DUCT COVER FOR BLOWER & MOUNTING PURPOSES. MINIMUM 18" HIGH

SIZE	MODEL	HEIGHT	UMRP	MSRP
<b>Available Duct Covers for 36" Models</b>	DC18-MANH36ISS	18"	\$ 755	\$ 870
	DC24MANH36ISS	24"	\$ 830	\$ 955
	DC30MANH36ISS	30"	\$ 895	\$ 1,030
	DC36MANH36ISS	36"	\$ 1,035	\$ 1,190
	DC42MANH36ISS	42"	\$ 1,110	\$ 1,275
	DC48MANH36ISS	48"	\$ 1,180	\$ 1,355
<b>Available Duct Covers for 42" Models</b>	DC18MANH42ISS	18"	\$ 755	\$ 870
	DC24MANH42ISS	24"	\$ 830	\$ 955
	DC30MANH42ISS	30"	\$ 895	\$ 1,030
	DC36MANH42ISS	36"	\$ 1,035	\$ 1,190
	DC42MANH42ISS	42"	\$ 1,110	\$ 1,275
	DC48MANH42ISS	48"	\$ 1,180	\$ 1,355
<b>Available Duct Covers for 48" Models</b>	DC18MANH48ISS	18"	\$ 755	\$ 870
	DC24MANH48ISS	24"	\$ 830	\$ 955
	DC30MANH48ISS	30"	\$ 895	\$ 1,030
	DC36MANH48ISS	36"	\$ 1,035	\$ 1,190
	DC42MANH48ISS	42"	\$ 1,110	\$ 1,275
	DC48MANH48ISS	48"	\$ 1,180	\$ 1,355

SIZE	MODEL	HEIGHT	UMRP	MSRP
<b>Available Duct Covers for 54" Models</b>	DC18MANH54ISS	18"	\$ 755	\$ 870
	DC24MANH54ISS	24"	\$ 830	\$ 955
	DC30MANH54ISS	30"	\$ 895	\$ 1,030
	DC36MANH54ISS	36"	\$ 1,035	\$ 1,190
	DC42MANH54ISS	42"	\$ 1,110	\$ 1,275
	DC48MANH54ISS	48"	\$ 1,180	\$ 1,355
<b>Available Duct Covers for 60" Models</b>	DC18MANH60ISS	18"	\$ 755	\$ 870
	DC24MANH60ISS	24"	\$ 830	\$ 955
	DC30MANH60ISS	30"	\$ 895	\$ 1,030
	DC36MANH60ISS	36"	\$ 1,035	\$ 1,190
	DC42MANH60ISS	42"	\$ 1,110	\$ 1,275
	DC48MANH60ISS	48"	\$ 1,180	\$ 1,355
<b>Available Duct Covers for 66" Models</b>	DC18MANH66ISS	18"	\$ 755	\$ 870
	DC24MANH66ISS	24"	\$ 830	\$ 955
	DC30MANH66ISS	30"	\$ 895	\$ 1,030
	DC36MANH66ISS	36"	\$ 1,035	\$ 1,190
	DC42MANH66ISS	42"	\$ 1,110	\$ 1,275
	DC48MANH66ISS	48"	\$ 1,180	\$ 1,355

# ABBAKA SERIES: ATLAS WALL HOODS

REQUEST A QUOTE  
QUOTE@BLUESTARCOOKING.COM

BlueStar Model Number Guide:	<b>Base Model (ATOXXMLPLT)</b>	<b>Add code below for desired color</b>	<b>Add (PLT) for Metal Strapping</b>
	Atlas   Unit Width   Internal Liner Type   Brushed Stainless Steel Strapping & Rivets	(C) 190 Standard RAL (Semi-Gloss) Colors (CF) Specialty Finish (190 Matte RAL, Precious Metals & Textures) (CC) Custom Colors	Standard: Brushed Stainless Steel See below for Designer Metal strapping and rivet options



30" & 36" Atlas Wall Hood

Standard Height: 30" | Standard Depth: 24"

**FEATURES:**

- Professional-grade performance with three exhaust settings and new Boost feature
- Whisper quiet operation
- Heavy duty, commercial grade materials
- Dimmable LED lighting
- Easy-to-use push-button controls
- Innovative, multi-stage grease capture system
- Stainless baffle filters seamlessly remove for easy dishwasher cleaning
- Choose from stainless steel or 1,000+ colors and finishes
- Simple installation
- 30" & 36" models: 600 CFM internal fan included *(Must be included on order)*
- Available with top or rear discharge - Discharge is field reversible.
- In-line, in-hood and remote blower compatible

**CUSTOMIZATION OPTIONS:**

- 1,000+ Colors & Finishes
- Designer Metals like brass & copper
- Custom strapping & rivets
- Full custom options

*(\*) Trim finishes on Cooking & Refrigeration products are different substrates than the trim finishes on Ventilation hoods. Due to these differing processes and substrates the finishes will coordinate but may not match exactly.*

Model	Description (* Denotes item that must be specified)	UMRP	MSRP
<b>30" ATLAS HOODS: (3 Vertical Straps   1 Horizontal)</b>			
AT030MLPLT	<b>Body:</b> Stainless Steel   <b>Strap/Rivets:</b> Stainless Steel   600 CFM	\$ 5,650	\$ 6,495
AT030MLPLTD	<b>Body:</b> Stainless Steel   <b>Strap/Rivets:</b> Des. Metal*   600 CFM	\$ 5,885	\$ 6,770
AT030MLPLTC	<b>Body:</b> Std RAL Color*   <b>Strap/Rivets:</b> Stainless Steel   600 CFM	\$ 6,745	\$ 7,755
AT030MLPLTDC	<b>Body:</b> Std RAL Color*   <b>Strap/Rivets:</b> Des Metal*   600 CFM	\$ 6,980	\$ 8,025
AT030MLPLTCF	<b>Body:</b> Spec. Finish*   <b>Strap/Rivets:</b> Stainless Steel   600 CFM	\$ 7,735	\$ 8,895
AT030MLPLTDCF	<b>Body:</b> Spec. Finish*   <b>Strap/Rivets:</b> Des. Metal*   600 CFM	\$ 7,970	\$ 9,165
AT030MLPLTCC	<b>Body:</b> Custom Color*   <b>Strap/Rivets:</b> Stainless Steel   600 CFM	\$ 9,165	\$ 10,540
AT030MLPLTDCC	<b>Body:</b> Custom Color*   <b>Strap/Rivets:</b> Des. Metal*   600 CFM	\$ 9,400	\$ 10,810
<b>36" ATLAS HOODS: (3 Vertical Straps   1 Horizontal)</b>			
AT036MLPLT	<b>Body:</b> Stainless Steel   <b>Strap/Rivets:</b> Stainless Steel   600 CFM	\$ 5,900	\$ 6,785
AT036MLPLTD	<b>Body:</b> Stainless Steel   <b>Strap/Rivets:</b> Des. Metal*   600 CFM	\$ 6,210	\$ 7,140
AT036MLPLTC	<b>Body:</b> Std RAL Color*   <b>Strap/Rivets:</b> Stainless Steel   600 CFM	\$ 6,995	\$ 8,045
AT036MLPLTDC	<b>Body:</b> Std RAL Color*   <b>Strap/Rivets:</b> Des Metal*   600 CFM	\$ 7,305	\$ 8,400
AT036MLPLTCF	<b>Body:</b> Spec. Finish*   <b>Strap/Rivets:</b> Stainless Steel   600 CFM	\$ 7,985	\$ 9,185
AT036MLPLTDCF	<b>Body:</b> Spec. Finish*   <b>Strap/Rivets:</b> Des. Metal*   600 CFM	\$ 8,295	\$ 9,540
AT036MLPLTCC	<b>Body:</b> Custom Color*   <b>Strap/Rivets:</b> Stainless Steel   600 CFM	\$ 9,415	\$ 10,825
AT036MLPLTDCC	<b>Body:</b> Custom Color*   <b>Strap/Rivets:</b> Des. Metal*   600 CFM	\$ 9,725	\$ 11,185
<b>DESIGNER METAL OPTIONS FOR STRAPPING &amp; RIVETS:</b>			
Polished Stainless	Antique Brass	Brushed Brass	Polished Brass
Antique Copper	Brushed Copper	Polished Copper	Pewter
<b>VENTILATION HOOD ACCESSORIES:</b>			
Refer to page 102 for Ventilation Hood Accessories			

BLOWER OPTIONS-	IN-HOOD		IN-LINE		REMOTE		DISCHARGE			
CFM POWER	600	1200	800	1200	1000	1400	TOP	REAR		
MODEL #	BS-CFM-600-IN06	BS-CFM-1200-IN12	ATEX-0.8	ATEX-1.2	HYEX-1.0-GA	HYEX-1.4-GA				
UMRP	\$ 965	\$ 1,385	\$ 1,260	\$ 1,510	\$ 1,385	\$ 1,640	Available at time of order			
AT030MLPLT	•		•	•	•	•			•	•
AT036MLPLT	•	•	•	•	•	•			•	•
AT042MLPLT	•	•	•	•	•	•			•	•
AT048MLPLT	•	•	•	•	•	•			•	•
AT054MLPLT	•	•	•	•	•	•			•	•
AT060MLPLT	•	•	•	•	•	•			•	•
AT066MLPLT	•	•	•	•	•	•	•	•		

## DESIGNER SERIES: 42", 48", 54" & 66" ATLAS WALL HOODS



42", 48", 54" & 60" Atlas Wall Hood  
Standard Height: 30" | Standard Depth: 24"

42" ATLAS HOODS: (4 Vertical Straps   1 Horizontal)		UMRP	MSRP
AT042MLPLT	Body: Stainless Steel   Strap/Rivets: Stainless Steel	\$ 6,515	\$ 7,490
AT042MLPLTD	Body: Stainless Steel   Strap/Rivets: Des. Metal*	\$ 6,825	\$ 7,850
AT042MLPLTC	Body: Std RAL Color*   Strap/Rivets: Stainless Steel	\$ 7,940	\$ 9,130
AT042MLPLTDC	Body: Std RAL Color*   Strap/Rivets: Des Metal*	\$ 8,250	\$ 9,490
AT042MLPLTCF	Body: Spec. Finish*   Strap/Rivets: Stainless Steel	\$ 9,040	\$ 10,395
AT042MLPLTDCF	Body: Spec. Finish*   Strap/Rivets: Des. Metal*	\$ 9,350	\$ 10,755
AT042MLPLTCC	Body: Custom Color*   Strap/Rivets: Stainless Steel	\$ 10,470	\$ 12,040
AT042MLPLTDCC	Body: Custom Color*   Strap/Rivets: Des. Metal*	\$ 10,780	\$ 12,395

48" ATLAS HOODS: (4 Vertical Straps   1 Horizontal)		UMRP	MSRP
AT048MLPLT	Body: Stainless Steel   Strap/Rivets: Stainless Steel	\$ 6,760	\$ 7,775
AT048MLPLTD	Body: Stainless Steel   Strap/Rivets: Des. Metal*	\$ 7,070	\$ 8,130
AT048MLPLTC	Body: Std RAL Color*   Strap/Rivets: Stainless Steel	\$ 8,185	\$ 9,415
AT048MLPLTDC	Body: Std RAL Color*   Strap/Rivets: Des Metal*	\$ 8,495	\$ 9,770
AT048MLPLTCF	Body: Spec. Finish*   Strap/Rivets: Stainless Steel	\$ 9,285	\$ 10,680
AT048MLPLTDCF	Body: Spec. Finish*   Strap/Rivets: Des. Metal*	\$ 9,595	\$ 11,035
AT048MLPLTCC	Body: Custom Color*   Strap/Rivets: Stainless Steel	\$ 10,715	\$ 12,680
AT048MLPLTDCC	Body: Custom Color*   Strap/Rivets: Des. Metal*	\$ 11,025	\$ 12,680

54" ATLAS HOODS: (4 Vertical Straps   1 Horizontal)		UMRP	MSRP
AT054MLPLT	Body: Stainless Steel   Strap/Rivets: Stainless Steel	\$ 7,010	\$ 8,060
AT054MLPLTD	Body: Stainless Steel   Strap/Rivets: Des. Metal*	\$ 7,320	\$ 8,420
AT054MLPLTC	Body: Std RAL Color*   Strap/Rivets: Stainless Steel	\$ 8,435	\$ 9,700
AT054MLPLTDC	Body: Std RAL Color*   Strap/Rivets: Des Metal*	\$ 8,745	\$ 10,055
AT054MLPLTCF	Body: Spec. Finish*   Strap/Rivets: Stainless Steel	\$ 9,535	\$ 10,965
AT054MLPLTDCF	Body: Spec. Finish*   Strap/Rivets: Des. Metal*	\$ 9,845	\$ 11,320
AT054MLPLTCC	Body: Custom Color*   Strap/Rivets: Stainless Steel	\$ 10,965	\$ 12,610
AT054MLPLTDCC	Body: Custom Color*   Strap/Rivets: Des. Metal*	\$ 11,275	\$ 12,965



66" Atlas Wall Hood  
Standard Height: 30" | Standard Depth: 24"

60" ATLAS HOODS: (4 Vertical Straps   1 Horizontal)		UMRP	MSRP
AT060MLPLT	Body: Stainless Steel   Strap/Rivets: Stainless Steel	\$ 7,375	\$ 8,480
AT060MLPLTD	Body: Stainless Steel   Strap/Rivets: Des. Metal*	\$ 7,685	\$ 8,840
AT060MLPLTC	Body: Std RAL Color*   Strap/Rivets: Stainless Steel	\$ 8,800	\$ 10,120
AT060MLPLTDC	Body: Std RAL Color*   Strap/Rivets: Des Metal*	\$ 9,110	\$ 10,475
AT060MLPLTCF	Body: Spec. Finish*   Strap/Rivets: Stainless Steel	\$ 9,900	\$ 11,385
AT060MLPLTDCF	Body: Spec. Finish*   Strap/Rivets: Des. Metal*	\$ 10,210	\$ 11,740
AT060MLPLTCC	Body: Custom Color*   Strap/Rivets: Stainless Steel	\$ 11,330	\$ 13,030
AT060MLPLTDCC	Body: Custom Color*   Strap/Rivets: Des. Metal*	\$ 11,640	\$ 13,385

66" ATLAS HOODS: (5 Vertical Straps   1 Horizontal)		UMRP	MSRP
AT066MLPLT	Body: Stainless Steel   Strap/Rivets: Stainless Steel	\$ 7,995	\$ 9,195
AT066MLPLTD	Body: Stainless Steel   Strap/Rivets: Des. Metal*	\$ 8,305	\$ 9,550
AT066MLPLTC	Body: Std RAL Color*   Strap/Rivets: Stainless Steel	\$ 9,420	\$ 10,835
AT066MLPLTDC	Body: Std RAL Color*   Strap/Rivets: Des Metal*	\$ 9,730	\$ 11,190
AT066MLPLTCF	Body: Spec. Finish*   Strap/Rivets: Stainless Steel	\$ 10,520	\$ 12,100
AT066MLPLTDCF	Body: Spec. Finish*   Strap/Rivets: Des. Metal*	\$ 10,830	\$ 12,455
AT066MLPLTCC	Body: Custom Color*   Strap/Rivets: Stainless Steel	\$ 11,950	\$ 13,740
AT066MLPLTDCC	Body: Custom Color*   Strap/Rivets: Des. Metal*	\$ 12,260	\$ 14,100

# ABBAKA SERIES: MESA WALL HOODS

**REQUEST A QUOTE**  
QUOTE@BLUESTARCOOKING.COM

<b>BlueStar Model Number Guide:</b>	<b>Base Model (ME0XXML)</b>	<b>Add code below for desired color</b>	<b>Add (PLT) for Metal Strapping</b>
	Mesa   Unit Width   Internal Liner Type	(C) 190 Standard RAL (Semi-Gloss) Colors (CF) Specialty Finish (190 Matte RAL, Precious Metals & Textures) (CC) Custom Colors	Available through custom quote only at quote@bluestarcooking.com



Standard Height: 30" | Standard Depth: 24"

**FEATURES:**

- Professional-grade performance with three exhaust settings and new Boost feature
- Whisper quiet operation
- Heavy duty, commercial grade materials
- Dimmable LED lighting
- Easy-to-use push-button controls
- Innovative, multi-stage grease capture system
- Stainless baffle filters seamlessly remove for easy dishwasher cleaning
- Choose from stainless steel or 1,000+ colors and finishes
- Simple installation
- 30" & 36" models: 600 CFM internal fan included *(Must be included on order)*
- Available with top or rear discharge - Discharge is field reversible.
- In-line, in-hood and remote blower compatible

**CUSTOMIZATION OPTIONS:**

- 1,000+ Colors & Finishes
- Designer Metals like brass & copper
- Custom strapping & rivets
- Full custom options

*(\*) Trim finishes on Cooking & Refrigeration products are different substrates than the trim finishes on Ventilation hoods. Due to these differing processes and substrates the finishes will coordinate but may not match exactly.*

Model	Description (* Denotes item that must be specified)	UMRP	MSRP
ME030ML	30" Mesa   Stainless Steel   600 CFM Blower	\$ 3,685	\$ 4,240
ME030MLC	30" Mesa   Std RAL Color*   600 CFM Blower	\$ 4,780	\$ 5,495
ME030MLCF	30" Mesa   Specialty Finish*   600 CFM Blower	\$ 5,770	\$ 6,635
ME030MLCC	30" Mesa   Custom Color*   600 CFM Blower	\$ 7,200	\$ 8,280
ME036ML	36" Mesa   Stainless Steel   600 CFM Blower	\$ 3,805	\$ 4,375
ME036MLC	36" Mesa   Std RAL Color*   600 CFM Blower	\$ 4,900	\$ 5,635
ME036MLCF	36" Mesa   Specialty Finish*   600 CFM Blower	\$ 5,890	\$ 6,775
ME036MLCC	36" Mesa   Custom Color*   600 CFM Blower	\$ 7,320	\$ 8,420
ME042ML	42" Mesa   Stainless Steel	\$ 4,055	\$ 4,665
ME042MLC	42" Mesa   Std RAL Color*	\$ 5,480	\$ 6,300
ME042MLCF	42" Mesa   Specialty Finish*	\$ 6,580	\$ 7,565
ME042MLCC	42" Mesa   Custom Color*	\$ 8,010	\$ 9,210
ME048ML	48" Mesa   Stainless Steel	\$ 4,300	\$ 4,945
ME048MLC	48" Mesa   Std RAL Color*	\$ 5,725	\$ 6,585
ME048MLCF	48" Mesa   Specialty Finish*	\$ 6,825	\$ 7,850
ME048MLCC	48" Mesa   Custom Color*	\$ 8,255	\$ 9,495
ME054ML	54" Mesa   Stainless Steel	\$ 4,420	\$ 5,085
ME054MLC	54" Mesa   Std RAL Color*	\$ 5,845	\$ 6,720
ME054MLCF	54" Mesa   Specialty Finish*	\$ 6,945	\$ 7,985
ME054MLCC	54" Mesa   Custom Color*	\$ 8,375	\$ 9,630
ME060ML	60" Mesa   Stainless Steel	\$ 4,670	\$ 5,370
ME060MLC	60" Mesa   Std RAL Color*	\$ 6,095	\$ 7,010
ME060MLCF	60" Mesa   Specialty Finish*	\$ 7,195	\$ 8,275
ME060MLCC	60" Mesa   Custom Color*	\$ 8,625	\$ 9,920
ME066ML	66" Mesa   Stainless Steel	\$ 4,915	\$ 5,650
ME066MLC	66" Mesa   Std RAL Color*	\$ 6,340	\$ 7,290
ME066MLCF	66" Mesa   Specialty Finish*	\$ 7,440	\$ 8,555
ME066MLCC	66" Mesa   Custom Color*	\$ 8,870	\$ 10,200
<b>VENTILATION HOOD ACCESSORIES:</b>			
Refer to page 102 for Ventilation Hood Accessories			

BLOWER OPTIONS	IN-HOOD		IN-LINE		REMOTE		DISCHARGE	
CFM POWER	600	1200	800	1200	1000	1400	TOP	REAR
MODEL #	BS-CFM-600-IN06	BS-CFM-1200-IN12	ATEX-0.8	ATEX-1.2	HYEX-1.0-GA	HYEX-1.4-GA		
UMRP	\$ 965	\$ 1,385	\$ 1,260	\$ 1,510	\$ 1,385	\$ 1,640	Available at time of order	
ME030ML	•		•	•	•	•		
ME036ML	•	•	•	•	•	•		
ME042ML	•	•	•	•	•	•		
ME048ML	•	•	•	•	•	•		
ME054ML	•	•	•	•	•	•		
ME060ML	•	•	•	•	•	•		
ME066ML	•	•	•	•	•	•		

# ABBAKA SERIES: 36", 42" & 48" NORMANDY WALL HOODS

REQUEST A QUOTE  
QUOTE@BLUESTARCOOKING.COM

BlueStar Model Number Guide:	<b>Base Model (NR0XXMLPLT)</b>	<b>Add code below for desired color</b>	<b>Add (PLT) for Metal Strapping</b>
	Normandy   Unit Width   Internal Liner Type   Brushed Stainless Steel Lower Reveal	(C) 190 Standard RAL (Semi-Gloss) Colors (CF) Specialty Finish (190 Matte RAL, Precious Metals & Textures) (CC) Custom Colors	Available through custom quote only at quote@bluestarcooking.com



Standard Height: 30" | Standard Depth: 27"

### FEATURES:

- Professional-grade performance with three exhaust settings and new Boost feature
- Whisper quiet operation
- Heavy duty, commercial grade materials
- Dimmable LED lighting
- Easy-to-use push-button controls
- Innovative, multi-stage grease capture system
- Stainless baffle filters seamlessly remove for easy dishwasher cleaning
- Choose from stainless steel or 1,000+ colors and finishes
- Simple installation
- 30" & 36" models: 600 CFM internal fan included (*Must be included on order*)
- Available with top or rear discharge - Discharge is field reversible.
- In-line, in-hood and remote blower compatible

### CUSTOMIZATION OPTIONS:

- 1,000+ Colors & Finishes
- Designer Metals like brass & copper
- Custom strapping & rivets
- Full custom options

Model	Description (* Denotes item that must be specified)	UMRP	MSRP
<b>All hoods include a brushed stainless steel lower reveal. For a lower reveal in a designer metal finish request a quote at quote@bluestarcooking.com</b>			
NR036ML	36" Normandy   Stainless Steel   600 CFM Blower	\$ 6,145	\$ 7,065
NR036MLC	36" Normandy   Std RAL Color*   600 CFM Blower	\$ 7,240	\$ 8,325
NR036MLCF	36" Normandy   Specialty Finish*   600 CFM Blower	\$ 8,230	\$ 9,465
NR036MLCC	36" Normandy   Custom Color*   600 CFM Blower	\$ 9,660	\$ 11,110
NR042ML	42" Normandy   Stainless Steel	\$ 6,515	\$ 7,490
NR042MLC	42" Normandy   Std RAL Color*	\$ 7,940	\$ 9,130
NR042MLCF	42" Normandy   Specialty Finish*	\$ 9,040	\$ 10,395
NR042MLCC	42" Normandy   Custom Color*	\$ 10,470	\$ 12,040
NR048ML	48" Normandy   Stainless Steel	\$ 8,610	\$ 9,900
NR048MLC	48" Normandy   Std RAL Color*	\$ 10,035	\$ 11,540
NR048MLCF	48" Normandy   Specialty Finish*	\$ 11,135	\$ 12,805
NR048MLCC	48" Normandy   Custom Color*	\$ 12,565	\$ 14,450
<b>VENTILATION HOOD ACCESSORIES:</b>			
Refer to page 102 for Ventilation Hood Accessories			

(\* ) Trim finishes on Cooking & Refrigeration products are different substrates than the trim finishes on Ventilation hoods. Due to these differing processes and substrates the finishes will coordinate but may not match exactly.

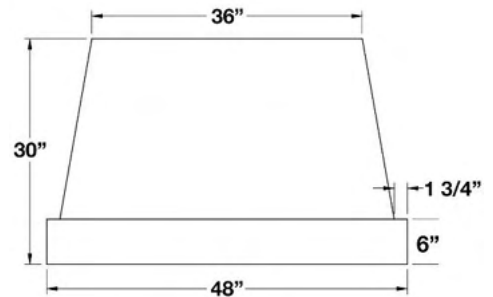
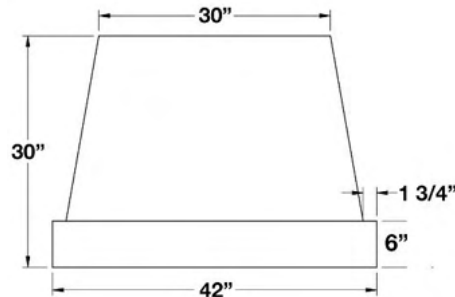
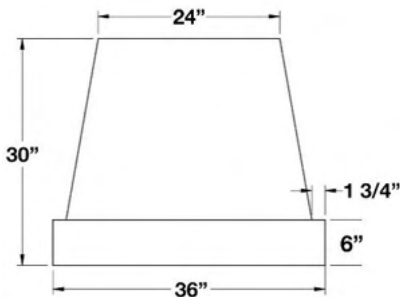

BLOWER OPTIONS	IN-HOOD		IN-LINE		REMOTE		DISCHARGE	
CFM POWER	600	1200	800	1200	1000	1400	TOP	REAR
MODEL #	BS-CFM-600-IN06	BS-CFM-1200-IN12	ATEX-0.8	ATEX-1.2	HYEX-1.0-GA	HYEX-1.4-GA		
UMRP	\$ 965	\$ 1,385	\$ 1,260	\$ 1,510	\$ 1,385	\$ 1,640		
NR036MLPLT	•	•	•	•	•	•	Available at time of order	
NR042MLPLT	•	•	•	•	•	•		
NR048MLPLT	•	•	•	•	•	•		
NR054MLPLT	•	•	•	•	•	•		
NR060MLPLT	•	•	•	•	•	•		
NR066MLPLT	•	•	•	•	•	•		

## ABBAKA SERIES: 54", 60" & 66" NORMANDY WALL HOODS

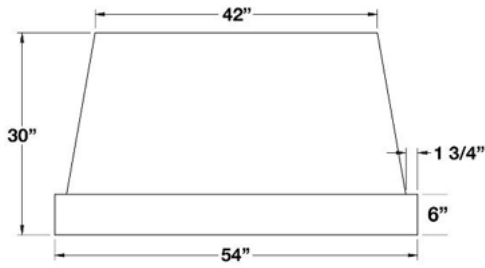

54" NORMANDY HOODS		UMRP	MSRP
NR054ML	54" Normandy   Stainless Steel	\$ 9,100	\$ 10,465
NR054MLC	54" Normandy   Std RAL Color*	\$ 10,525	\$ 12,105
NR054MLCF	54" Normandy   Specialty Finish*	\$ 11,625	\$ 13,370
NR054MLCC	54" Normandy   Custom Color*	\$ 13,055	\$ 15,015

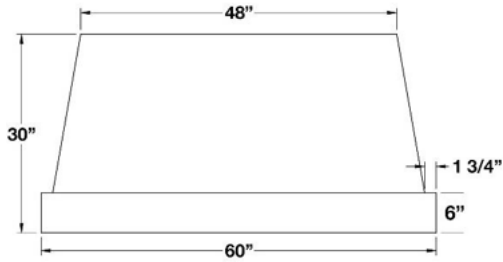

60" NORMANDY HOODS		UMRP	MSRP
NR060ML	60" Normandy   Stainless Steel	\$ 9,840	\$ 11,315
NR060MLC	60" Normandy   Std RAL Color*	\$ 11,265	\$ 12,955
NR060MLCF	60" Normandy   Specialty Finish*	\$ 12,365	\$ 14,220
NR060MLCC	60" Normandy   Custom Color*	\$ 13,795	\$ 15,865

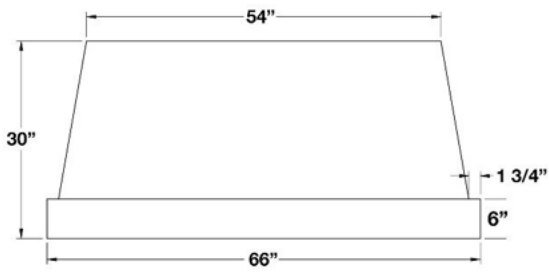

66" NORMANDY HOODS		UMRP	MSRP
NR066ML	66" Normandy   Stainless Steel	\$ 10,455	\$ 12,025
NR066MLC	66" Normandy   Std RAL Color*	\$ 11,880	\$ 13,660
NR066MLCF	66" Normandy   Specialty Finish*	\$ 12,980	\$ 14,925
NR066MLCC	66" Normandy   Custom Color*	\$ 14,410	\$ 16,570

## VENTILATION HOODS: CUSTOMIZATION & ACCESSORY OPTIONS

BLOWERS & TRANSITIONS: BLUESTAR PROFESSIONAL & DESIGNER SERIES HOODS			
Model	Description	UMRP	MSRP
<b>BLOWERS AND TRANSITIONS: PL, PY, BZ, HA, MA, SC,WR &amp; PM</b>			
BS-CFM-600-IN06	INTERNAL 3 speed 600 cfm blower	\$ 965	\$ 1,110
BS-CFM-1200-IN12	INTERNAL 3 speed 1200 cfm blower	\$ 1,385	\$ 1,595
ATEX-0.8	800 CFM IN LINE 8" DUCT	\$ 1,260	\$ 1,450
ATEX-1.2	1200 CFM IN LINE 10" DUCT	\$ 1,510	\$ 1,735
SW-ATEX1.2	Wall Switch for ATEX Series Inline Blowers	\$ 140	\$ 160
HYEX-1.0-GA	1000 CFM 8" DUCT GALVALUME	\$ 1,385	\$ 1,595
HYEX-1.4-GA	1400 CFM 10" DUCT GALVALUME	\$ 1,640	\$ 1,885
781100	Wall Switch for HYEX Series Remote Blowers	\$ 65	\$ 75
SM-10	Muffler & Isolation Clamps - 10" Duct	\$ 620	\$ 715
SM-08	Muffler & Isolation Clamps - 8" Duct	\$ 550	\$ 653

Model	Description	UMRP	MSRP
<b>BLOWERS &amp; TRANSITIONS: MANHATTAN ISLAND &amp; PRE-MAY 2020 VENTILATION HOODS</b>			
PH-CFM-600	INTERNAL 3 speed 600 cfm blower	\$ 965	\$ 1,110
PH-CFM-1200	INTERNAL 3 speed 1200 cfm blower	\$ 1,385	\$ 1,595
PH-CFMR-1000	REMOTE 3 speed 1000 cfm blower	\$ 1,890	\$ 2,175
PH-CFMR-1400	REMOTE 3 speed 1400 cfm blower	\$ 2,020	\$ 2,325
PH-INLB600	INLINE 3 speed 600 cfm INLINE blower	\$ 1,520	\$ 1,750
PH-INLB1200	INLINE 3 speed 1200 cfm INLINE blower	\$ 1,875	\$ 2,155
780038	Transition for top discharge, 6 x 15 to 8" round - 8" h. with damper	\$ 295	\$ 340
780037	Transition for top discharge, 6 x 15 to 10" round - 8" h. with damper	\$ 305	\$ 350
780188	Transition for rear discharge, 6 x 15 to 8" round - 3.5" h. without damper	\$ 295	\$ 340
780189	Transition for rear discharge, 6 x 15 to 10" round - 3.5" h. without damper	\$ 295	\$ 340

WALL LINERS:				
<p>Height 38"</p> <p>30" 36" 42" 48" 54" 60" 66"</p>	WL-30-SS	Wall Liner: 30" w x 38" h	\$ 460	\$ 530
	WL-36-SS	Wall Liner: 36" w x 38" h	\$ 495	\$ 570
	WL-42-SS	Wall Liner: 42" w x 38" h	\$ 525	\$ 605
	WL-48-SS	Wall Liner: 48" w x 38" h	\$ 550	\$ 635
	WL-54-SS	Wall Liner: 54" w x 38" h	\$ 575	\$ 660
	WL-60-SS	Wall Liner: 60" w x 38" h	\$ 610	\$ 700
	WL-66-SS	Wall Liner: 66" w x 38" h	\$ 635	\$ 730

## SUMMARY GUIDE: PAINT & PLATED TRIM PRICES

FREESTANDING RANGES				
Product	Plated Trim (PLT)	Standard RAL Paint (C)	Specialty Finish (CF)	Custom Color Match (CC)
24" Models	\$ 1,465	\$ 1,095	\$ 2,085	\$ 3,515
30" Models	\$ 1,465	\$ 1,095	\$ 2,085	\$ 3,515
36" Models	\$ 1,780	\$ 1,095	\$ 2,085	\$ 3,515
48" Models	\$ 2,095	\$ 1,425	\$ 2,525	\$ 3,955
60" Models	\$ 2,410	\$ 1,425	\$ 2,525	\$ 3,955
30" Precious Metals	\$ 730	N/C	N/C	\$ 3,195
36" Precious Metals	\$ 1,045	N/C	N/C	\$ 3,195
RANGETOPS & DROP-IN COOKTOPS				
Product	Plated Trim (PLT)	Standard RAL Paint (C)	Specialty Finish (CF)	Custom Color Match (CC)
24" Models	\$ 730	N/A	N/A	N/A
30" Models	\$ 730	N/A	N/A	N/A
36" Models	\$ 1,045	N/A	N/A	N/A
48" Models	\$ 1,360	N/A	N/A	N/A
60" Models	\$ 1,675	N/A	N/A	N/A
WALL OVENS				
Product	Plated Trim (PLT)	Standard RAL Paint (C)	Specialty Finish (CF)	Custom Color Match (CC)
24" Models	\$ 1,045	\$ 1,095	\$ 2,085	\$ 3,515
30" Models	\$ 1,570	\$ 1,095	\$ 2,085	\$ 3,515
36" Models	\$ 1,570	\$ 1,095	\$ 2,085	\$ 3,515
30" Double Models	\$ 2,305	\$ 1,315	\$ 2,195	\$ 3,735
SALAMANDER BROILER				
Product	Plated Trim (PLT)	Standard RAL Paint (C)	Specialty Finish (CF)	Custom Color Match (CC)
24" Model	\$ 1,045	N/A	N/A	N/A
REFRIGERATION				
Product	Plated Trim (PLT)	Standard RAL Paint (C)	Specialty Finish (CF)	Custom Color Match (CC)
36" Built-In Single Door	\$ 1,295	\$ 1,395	\$ 1,895	\$ 3,195
36" Built-In French Door	\$ 1,495	\$ 1,495	\$ 1,995	\$ 3,195
18" Columns	\$ 1,095	\$ 995	\$ 1,495	\$ 2,795
24" Columns	\$ 1,095	\$ 995	\$ 1,495	\$ 2,795
30" Columns	\$ 1,095	\$ 1,295	\$ 1,895	\$ 3,195
VENTILATION				
Product	Designer Metal Strapping*	Standard RAL Paint (C)	Specialty Finish (CF)	Custom Color Match (CC)
30" Models	\$ 235	\$ 1,095	\$ 2,085	\$ 3,515
36" Models	\$ 310	\$ 1,095	\$ 2,085	\$ 3,515
42" Models	\$ 310	\$ 1,425	\$ 2,525	\$ 3,955
48" Models	\$ 310	\$ 1,425	\$ 2,525	\$ 3,955
54" Models	\$ 310	\$ 1,425	\$ 2,525	\$ 3,955
60" Models	\$ 310	\$ 1,425	\$ 2,525	\$ 3,955
66" Models	\$ 310	\$ 1,425	\$ 2,525	\$ 3,955

\* Upgrade from standard stainless strapping layout. Excludes Wrangler Hoods with Designer Metal Strapping & Rivets (Done at same rate as Designer Hoods)



318 June Avenue, Blandon, PA 19510  
(800) 449 - 8691