

Miele



Price List
Cleaning
April 2022



Table of Content

Dishwashers	03
Dishwasher Feature Highlights	03
Dishwasher	04
Handle Options	20
Professional for the Home Dishwashers	22
Professional for the Home Dishwasher Feature Highlights	22
Professional for the Home Dishwasher	23
Laundry	34
Laundry Feature Highlights	34
Laundry	35
Rotary Iron	42
Professional for the Home Laundry	43
Professional for the Home Laundry Feature Highlights	43
Professional for the Home Laundry	44
Professional Rotary Iron	46
Accessories & Consumables	47

Product Highlights

Dishwashers

*See specific models for details

FEATURE	DESCRIPTION
EcoPower Technology	With a new water flow system, G7000 dishwashers save both water and energy earning the ENERGY STAR Most Efficient 2022 badge. In the Auto program, run a full cycle using less than 1.6 gallons of water.
3D MultiFlex Cutlery Tray	Provides a new level of convenience by adapting instantly to accommodate larger utensils, as well as taller stemware in the upper basket.
BrilliantLight	Four powerful LED lights illuminate the dishwasher from the inside out.
AutoOpen Drying	The dishwasher door automatically opens at the end of the cycle, allowing air to escape and circulate for perfect drying.
AutoDos with PowerDisk	In G 7000 dishwashers, the integrated PowerDisk® automatically dispenses the correct amount of detergent in accordance with the selected program and degree of soiling.
FlexLine Baskets	Easily adjustable to accommodate a wide array of dishware, utensils, stemware, pots and pans.
Knock2Open	Automatic door opening after two knocks. Integrates seamlessly in a handleless kitchen.
QuickIntenseWash	Excellent cleaning and drying results for normally soiled dishes in only 58 minutes.
SaniWash	High temperature program for deep cleaning results.
Miele@home	Access your appliance from your smart device for maximum convenience.
Certified Hygiene Seal	 <p>Approved by an independent university, Albstadt-Sigmaringen University in Germany, all Miele dishwashers remove more than 99.9% of specific bacteria.*</p>
Golden Virus Seal	 <p>Approved by an independent university, Rhine-Waal University in Germany, all Miele dishwashers remove more than 99.9% of specific bacteria.*</p>

Certified Hygiene Seal

*This certification attests that all G 5000 and G 7000 dishwashers with the SaniWash or Pots & Pans program offer particularly hygienic cleaning. This applies both with (standard) detergent or even without cleaning agent altogether.

Golden Virus Seal

*Depending on the program selected, different types of viruses are getting removed. In all programs, including Economy, enveloped viruses including the Coronavirus are removed. This certification is based on the use of Miele PowerDisk and Miele UltraTabs detergents.

24" Dishwasher - Pre-Finished



MODEL	HANDLE TYPE	MATERIAL	UMRP/RETAIL	OPTIONAL ACCESSORIES	MATERIAL	UMRP
G 5006 SCU Clean Touch Steel™	Integrated Handle	11636690	\$1,299 / \$1,399	GPL 77-1 SS Filler Strips (pair)	6415910	\$67

SPECIFICATIONS

Width	23 ^{9/16} in (598 mm)
Height	33 ^{11/16} - 36 ^{1/4} in (855 - 920 mm)
Depth	22 ^{7/16} in (570 mm)
Shipping Weight	121 lbs (55 kg)
Annual Energy Usage	230 kWh
Decibal rating	44 dBA

FEATURES

- EcoPower Technology
- Controls: DirectSelect, front
- Original Cutlery Basket
- Basket Design: Comfort
- No. of Standard Place Settings: 16
- Double Waterproof System
- Automatic Load Sensor
- Delay Start

PROGRAMS

- Normal
- QuickIntenseWash
- Pots & Pans
- SaniWash
- Rinse & Hold

OPTIONS

- Express
- Extra Clean
- Extra Dry

24" Dishwasher - Fully Integrated



MODEL	HANDLE TYPE	MATERIAL	UMRP/RETAIL
G 5051 SCVi Custom Panel	No Handle	11636710	\$1,299 / \$1,399

SPECIFICATIONS

Width	23 ^{9/16} in (598 mm)
Height	32 ^{1/16} - 34 ^{1/4} in (814 - 870 mm)
Depth	22 ^{7/16} in (570 mm)
Shipping Weight	121 lbs (55 kg)
Annual Energy Usage	230 kWh
Decibal rating	44 dBA
ADA Compliant	Yes

FEATURES

- EcoPower Technology
- Controls: DirectSelect, front
- Original Cutlery Basket
- Basket Design: Comfort
- No. of Standard Place Settings: 16
- Double Waterproof System
- Automatic Load Sensor
- Delay Start

PROGRAMS

- Normal
- QuickIntenseWash
- Pots & Pans
- SaniWash
- Rinse & Hold

OPTIONS

- Express
- Extra Clean
- Extra Dry

OPTIONAL ACCESSORIES	MATERIAL	UMRP/RETAIL
GPL 77-1 SS Filler Strips (pair)	6415910	\$67 / \$67
GFVi 701/72 Fully Integrated Panel Full Size, Clean Touch Steel™, 6" toekick, no handle	10986740	\$329 / \$379
GFVi 701/77 Fully Integrated Panel Full Size, Clean Touch Steel™, 4" toekick, no handle	10986750	\$329 / \$379
GFVi 710/77 Fully Integrated Panel Full Size, Clean Touch Steel™, 4" toekick, PureLine handle	12074350	\$429 / \$479
GFVi 711/72 Fully Integrated Panel Full Size, Clean Touch Steel™, 6" toekick, ContourLine handle	12074400	\$429 / \$479
GFVi 711/77 Fully Integrated Panel Full Size, Clean Touch Steel™, 4" toekick, ContourLine handle	12074450	\$429 / \$479
GFVi 712/77 Fully Integrated Panel Full Size, Clean Touch Steel™, 4" toekick, Range Panel	12074470	\$429 / \$479
GFVi 709/77 Fully Integrated Panel Full Size, Clean Touch Steel™, 4" toekick, Pocket handle	11750840	\$429 / \$479

*Handles sold separately.
See page 20 for full list of handle options.

24" Dishwasher - Fully Integrated



MODEL	HANDLE TYPE	MATERIAL	UMRP/RETAIL
G 5056 SCVi Custom Panel	No Handle	11636720	\$1,299 / \$1,399
G 5056 SCVi SF Clean Touch Steel™	PureLine Handle	11695330	\$1,449 / \$1,549
G 5056 SCVi SFP Clean Touch Steel™	Pocket Handle	11636730	\$1,449 / \$1,549

- OPTIONS**
- Express
 - Extra Clean
 - Extra Dry

SPECIFICATIONS

Width	23 ^{9/16} in (598 mm)
Height	33 ^{11/16} - 36 ^{1/4} in (855 - 920 mm)
Depth	22 ^{7/16} in (570 mm)
Shipping Weight	121 lbs (55 kg)
Annual Energy Usage	230 kWh
Decibal rating	44 dBA

OPTIONAL ACCESSORIES VI	MATERIAL	UMRP/RETAIL
GPL 77-1 SS Filler Strips (pair)	6415910	\$67 / \$67
GFVi 701/72 Fully Integrated Panel Full Size, Clean Touch Steel™, 6" toekick, no handle	10986740	\$329 / \$379
GFVi 701/77 Fully Integrated Panel Full Size, Clean Touch Steel™, 4" toekick, no handle	10986750	\$329 / \$379
GFVi 710/77 Fully Integrated Panel Full Size, Clean Touch Steel™, 4" toekick, PureLine handle	12074350	\$429 / \$479
GFVi 711/72 Fully Integrated Panel Full Size, Clean Touch Steel™, 6" toekick, ContourLine handle	12074400	\$429 / \$479
GFVi 711/77 Fully Integrated Panel Full Size, Clean Touch Steel™, 4" toekick, ContourLine handle	12074450	\$429 / \$479
GFVi 712/77 Fully Integrated Panel Full Size, Clean Touch Steel™, 4" toekick, Range Panel	12074470	\$429 / \$479
GFVi 709/77 Fully Integrated Panel Full Size, Clean Touch Steel™, 4" toekick, Pocket handle	11750840	\$429 / \$479

- FEATURES**
- EcoPower Technology
 - Controls: DirectSelect, hidden
 - Original Cutlery Basket
 - Basket Design: Comfort
 - No. of Standard Place Settings: 16
 - Double Waterproof System
 - Automatic Load Sensor
 - Delay Start

- PROGRAMS**
- Normal
 - QuickIntenseWash
 - Pots & Pans
 - SaniWash
 - Rinse & Hold

OPTIONAL ACCESSORIES SF(P)	MATERIAL	UMRP
GPL 77-1 SS Filler Strips (pair)	6415910	\$67

24" Dishwasher - Fully Integrated



MODEL	HANDLE TYPE	MATERIAL	UMRP/RETAIL
G 5266 SCVi Custom Panel	No Handle	11636740	\$1,499 / \$1,599
G 5266 SCVi SF Clean Touch Steel™	PureLine Handle	11636750	\$1,649 / \$1,749
G 5266 SCVi SFP Clean Touch Steel™	Pocket Handle	11695340	\$1,649 / \$1,749

- OPTIONS**
- Express
 - Extra Clean
 - Extra Dry

SPECIFICATIONS

Width	23 ⁹ / ₁₆ in (598 mm)
Height	33 ¹¹ / ₁₆ - 36 ¹ / ₄ in (855 - 920 mm)
Depth	22 ⁷ / ₁₆ in (570 mm)
Shipping Weight	121 lbs (55 kg)
Annual Energy Usage	230 kWh
Decibal rating	42 dBA

OPTIONAL ACCESSORIES VI	MATERIAL	UMRP/RETAIL
GPL 77-1 SS Filler Strips (pair)	6415910	\$67 / \$67
GFVi 701/72 Fully Integrated Panel Full Size, Clean Touch Steel™, 6" toekick, no handle	10986740	\$329 / \$379
GFVi 701/77 Fully Integrated Panel Full Size, Clean Touch Steel™, 4" toekick, no handle	10986750	\$329 / \$379
GFVi 710/77 Fully Integrated Panel Full Size, Clean Touch Steel™, 4" toekick, PureLine handle	12074350	\$429 / \$479
GFVi 711/72 Fully Integrated Panel Full Size, Clean Touch Steel™, 6" toekick, ContourLine handle	12074400	\$429 / \$479
GFVi 711/77 Fully Integrated Panel Full Size, Clean Touch Steel™, 4" toekick, ContourLine handle	12074450	\$429 / \$479
GFVi 712/77 Fully Integrated Panel Full Size, Clean Touch Steel™, 4" toekick, Range Panel	12074470	\$429 / \$479
GFVi 709/77 Fully Integrated Panel Full Size, Clean Touch Steel™, 4" toekick, Pocket handle	11750840	\$429 / \$479

- FEATURES**
- EcoPower Technology
 - Controls: DirectSelect, hidden
 - 3D MultiFlex Cutlery Tray
 - Basket Design: Comfort
 - AutoOpen Drying
 - SensorDry
 - No. of Standard Place Settings: 16
 - Double Waterproof System
 - Automatic Load Sensor
 - Water Softner
 - Delay Start

OPTIONAL ACCESSORIES SF(P)	MATERIAL	UMRP
GPL 77-1 SS Filler Strips (pair)	6415910	\$67

- PROGRAMS**
- Normal
 - QuickIntenseWash
 - Pots & Pans
 - SaniWash
 - Rinse & Hold

*Handles sold separately.
See page 20 for full list of handle options.

24" Dishwasher - Pre-Finished



MODEL	HANDLE TYPE	MATERIAL	UMRP/RETAIL
G 7106 SCU Clean Touch Steel™	Integrated Handle	11387580	\$1,699 / \$1,799

OPTIONAL ACCESSORIES	MATERIAL	UMRP
GPL 77-1 SS Filler Strips (pair)	6415910	\$67

SPECIFICATIONS

Width	23 ^{9/16} in (598 mm)
Height	33 ^{11/16} - 36 ^{1/4} in (855 - 920 mm)
Depth	22 ^{7/16} in (570 mm)
Shipping Weight	121 lbs (55 kg)
Annual Energy Usage	230 kWh
Decibal rating	43 dBA

FEATURES

- EcoPower Technology
- Controls: DirectSelect, front
- 3D MultiFlex Cutlery Tray
- AutoOpen Drying
- SensorDry
- Basket Design: ExtraComfort
- No. of Standard Place Settings: 16
- Double Waterproof System
- Automatic Load Sensor
- Water Softner
- Delay Start

PROGRAMS

- Normal
- QuickIntenseWash
- Pots & Pans
- SaniWash
- Rinse & Hold
- China & Crystal

OPTIONS

- Express
- Extra Clean
- Extra Dry
- Intense Zone

24" Dishwasher - Fully Integrated



MODEL	HANDLE TYPE	MATERIAL	UMRP/RETAIL
G 7156 SCVi Custom Panel	No Handle	11387590	\$1,699 / \$1,799
G 7156 SCVi SF Clean Touch Steel™	ContourLine Handle	12055090	\$1,849 / \$1,949

SPECIFICATIONS

Width	23 ^{9/16} in (598 mm)
Height	33 ^{11/16} - 36 ^{1/4} in (855 - 920 mm)
Depth	22 ^{7/16} in (570 mm)
Shipping Weight	121 lbs (55 kg)
Annual Energy Usage	230 kWh
Decibal rating	43 dBA

FEATURES

- EcoPower Technology
- Controls: DirectSelect, hidden
- 3D MultiFlex Cutlery Tray
- AutoOpen Drying
- SensorDry
- Basket Design: ExtraComfort
- No. of Standard Place Settings: 16
- Double Waterproof System
- Automatic Load Sensor
- Water Softner
- Delay Start

PROGRAMS

- Normal
- QuickIntenseWash
- Pots & Pans
- SaniWash
- Rinse & Hold
- China & Crystal

OPTIONS

- Express
- Extra Clean
- Extra Dry
- Intense Zone

OPTIONAL ACCESSORIES VI	MATERIAL	UMRP/RETAIL
GPL 77-1 SS Filler Strips (pair)	6415910	\$67 / \$67
GFVi 701/72 Fully Integrated Panel Full Size, Clean Touch Steel™, 6" toekick, no handle	10986740	\$329 / \$379
GFVi 701/77 Fully Integrated Panel Full Size, Clean Touch Steel™, 4" toekick, no handle	10986750	\$329 / \$379
GFVi 710/77 Fully Integrated Panel Full Size, Clean Touch Steel™, 4" toekick, PureLine handle	12074350	\$429 / \$479
GFVi 711/72 Fully Integrated Panel Full Size, Clean Touch Steel™, 6" toekick, ContourLine handle	12074400	\$429 / \$479
GFVi 711/77 Fully Integrated Panel Full Size, Clean Touch Steel™, 4" toekick, ContourLine handle	12074450	\$429 / \$479
GFVi 712/77 Fully Integrated Panel Full Size, Clean Touch Steel™, 4" toekick, Range Panel	12074470	\$429 / \$479
GFVi 709/77 Fully Integrated Panel Full Size, Clean Touch Steel™, 4" toekick, Pocket handle	11750840	\$429 / \$479

OPTIONAL ACCESSORIES SF(P)	MATERIAL	UMRP
GPL 77-1 SS Filler Strips (pair)	6415910	\$67

*Handles sold separately.
See page 20 for full list of handle options.

24" Dishwasher - Pre-Finished



MODEL	HANDLE TYPE	MATERIAL	UMRP/RETAIL
G 7316 SCU Clean Touch Steel™	Integrated Handle	11388020	\$2,049 / \$2,149

OPTIONAL ACCESSORIES	MATERIAL	UMRP
GPL 77-1 SS Filler Strips (pair)	6415910	\$67

SPECIFICATIONS

Width	23 ⁹ / ₁₆ in (598 mm)
Height	33 ¹¹ / ₁₆ - 36 ¹ / ₄ in (855 - 920 mm)
Depth	22 ⁷ / ₁₆ in (570 mm)
Shipping Weight	121 lbs (55kg)
Annual Energy Usage	230 kWh
Decibal rating	42 dBA

FEATURES

- EcoPower Technology
- Controls: DirectSensor, front
- 3D MultiFlex Cutlery Tray
- AutoOpen Drying
- SensorDry
- AutoDos with PowerDisk
- Basket Design: ExtraComfort
- No. of Standard Place Settings: 16
- Double Waterproof System
- Miele@home/AutoStart
- Automatic Load Sensor
- Water Softner
- Delay Start

PROGRAMS

- Normal
- QuickIntenseWash
- Pots & Pans
- SaniWash
- Rinse & Hold
- China & Crystal
- Economy
- Extra Quiet: 40dBA
- Grates & Filters
- Clean Machine

OPTIONS

- Express
- FlexiTimer
- Extra Economical
- Extra Clean
- Extra Dry
- Intense Zone

24" Dishwasher - Fully Integrated



MODEL	HANDLE TYPE	MATERIAL	UMRP/RETAIL
G 7366 SCVi Custom Panel	No Handle	11388030	\$2,049 / \$2,149
G 7366 SCVi SF Clean Touch Steel™	ContourLine Handle	12055100	\$2,199 / \$2,299

SPECIFICATIONS

Width	23 ⁹ / ₁₆ in (598 mm)
Height	33 ¹¹ / ₁₆ - 36 ¹ / ₄ in (855 - 920 mm)
Depth	22 ⁷ / ₁₆ in (570 mm)
Shipping Weight	121 lbs (55 kg)
Annual Energy Usage	230 kWh
Decibal rating	42 dBA

FEATURES

- EcoPower Technology
- Controls: DirectSensor, hidden
- 3D MultiFlex Cutlery Tray
- AutoOpen Drying
- SensorDry
- AutoDos with PowerDisk
- Basket Design: ExtraComfort
- No. of Standard Place Settings: 16
- Double Waterproof System
- Miele@home/AutoStart
- Automatic Load Sensor
- Water Softner
- Delay Start

PROGRAMS

- Normal
- QuickIntenseWash
- Pots & Pans
- SaniWash
- Rinse & Hold
- China & Crystal
- Economy
- Extra Quiet: 40dBA
- Grates & Filters
- Clean Machine

OPTIONS

- Express
- FlexiTimer
- Extra Economical
- Extra Clean
- Extra Dry
- Intense Zone

OPTIONAL ACCESSORIES VI	MATERIAL	UMRP/RETAIL
GPL 77-1 SS Filler Strips (pair)	6415910	\$67 / \$67
GFVi 701/72 Fully Integrated Panel Full Size, Clean Touch Steel™, 6" toekick, no handle	10986740	\$329 / \$379
GFVi 701/77 Fully Integrated Panel Full Size, Clean Touch Steel™, 4" toekick, no handle	10986750	\$329 / \$379
GFVi 710/77 Fully Integrated Panel Full Size, Clean Touch Steel™, 4" toekick, PureLine handle	12074350	\$429 / \$479
GFVi 711/72 Fully Integrated Panel Full Size, Clean Touch Steel™, 6" toekick, ContourLine handle	12074400	\$429 / \$479
GFVi 711/77 Fully Integrated Panel Full Size, Clean Touch Steel™, 4" toekick, ContourLine handle	12074450	\$429 / \$479
GFVi 712/77 Fully Integrated Panel Full Size, Clean Touch Steel™, 4" toekick, Range Panel	12074470	\$429 / \$479
GFVi 709/77 Fully Integrated Panel Full Size, Clean Touch Steel™, 4" toekick, Pocket handle	11750840	\$429 / \$479

OPTIONAL ACCESSORIES SF(P)

OPTIONAL ACCESSORIES SF(P)	MATERIAL	UMRP
GPL 77-1 SS Filler Strips (pair)	6415910	\$67

*Handles sold separately.
See page 20 for full list of handle options.

24" Dishwasher - Integrated



MODEL	HANDLE TYPE	MATERIAL	UMRP/RETAIL
G 7516 SCI Custom Panel	Integrated Handle	11388120	\$2,399 / \$2,499

SPECIFICATIONS

Width	23 ⁹ / ₁₆ in (598 mm)
Height	33 ¹¹ / ₁₆ - 36 ¹ / ₄ in (855 - 920 mm)
Depth	22 ⁷ / ₁₆ in (570 mm)
Shipping Weight	121 lbs (55 kg)
Annual Energy Usage	230 kWh
Decibal Rating	40 dBA

FEATURES

- EcoPower Technology
- Controls: DirectSensor, front
- 3D MultiFlex Cutlery Tray
- BrilliantLight
- AutoOpen Drying
- SensorDry
- AutoDos with PowerDisk
- Basket Design: MaxiComfort
- No. of Standard Place Settings: 16
- Double Waterproof System
- Miele@home/AutoStart
- Automatic Load Sensor
- Water Softner
- Delay Start

PROGRAMS

- Normal
- QuickIntenseWash
- Pots & Pans
- SaniWash
- Rinse & Hold
- China & Crystal
- Economy
- Extra Quiet: 38 dBA
- Grates & Filters
- Clean Machine
- Energy Saver
- SensorWash

OPTIONS

- Express
- FlexiTimer
- Extra Economical
- Extra Clean
- Extra Dry
- Intense Zone

OPTIONAL ACCESSORIES	MATERIAL	UMRP/RETAIL
GPL 77-1 SS Filler Strips (pair)	6415910	\$67 / \$67
GFV 60/60-7 Integrated Panel Full Size, Clean Touch Steel™, 6" toekick	10986720	\$269 / \$319
GFV 60/65-7 Integrated Panel Full Size, Clean Touch Steel™, 4" toekick	10986730	\$269 / \$319

24" Dishwasher - Fully Integrated



MODEL	HANDLE TYPE	MATERIAL	UMRP/RETAIL
G 7566 SCVi Custom Panel	No Handle	11388140	\$2,499 / \$2,599

G 7566 SCVi SF Clean Touch Steel™	ContourLine Handle	12055110	\$2,649 / \$2,749
--------------------------------------	--------------------	----------	-------------------

SPECIFICATIONS

Width	23 ⁹ / ₁₆ in (598 mm)
Height	33 ¹¹ / ₁₆ - 36 ¹ / ₄ in (855 - 920 mm)
Depth	22 ⁷ / ₁₆ in (570 mm)
Shipping Weight	121 lbs (55 kg)
Annual Energy Usage	230 kWh
Decibal rating	40 dBA

FEATURES

- EcoPower Technology
- Controls: DirectSensor, hidden
- 3D MultiFlex Cutlery Tray
- BrilliantLight
- AutoOpen Drying
- SensorDry
- AutoDos with PowerDisk
- Basket Design: MaxiComfort
- No. of Standard Place Settings: 16
- Double Waterproof System
- Miele@home/AutoStart
- Automatic Load Sensor
- Water Softner
- Delay Start

PROGRAMS

- Normal
- QuickIntenseWash
- Pots & Pans
- SaniWash
- Rinse & Hold
- China & Crystal
- Economy
- Extra Quiet: 38 dBA
- Grates & Filters
- Clean Machine
- Energy Saver
- SensorWash

OPTIONS

- Express
- FlexiTimer
- Extra Economical
- Extra Clean
- Extra Dry
- Intense Zone

OPTIONAL ACCESSORIES VI	MATERIAL	UMRP/RETAIL
-------------------------	----------	-------------

GPL 77-1 SS Filler Strips (pair)	6415910	\$67 / \$67
----------------------------------	---------	-------------

GFVi 701/72 Fully Integrated Panel Full Size, Clean Touch Steel™, 6" toe-kick, no handle	10986740	\$329 / \$379
--	----------	---------------

GFVi 701/77 Fully Integrated Panel Full Size, Clean Touch Steel™, 4" toe-kick, no handle	10986750	\$329 / \$379
--	----------	---------------

GFVi 710/77 Fully Integrated Panel Full Size, Clean Touch Steel™, 4" toe-kick, PureLine handle	12074350	\$429 / \$479
--	----------	---------------

GFVi 711/72 Fully Integrated Panel Full Size, Clean Touch Steel™, 6" toe-kick, ContourLine handle	12074400	\$429 / \$479
---	----------	---------------

GFVi 711/77 Fully Integrated Panel Full Size, Clean Touch Steel™, 4" toe-kick, ContourLine handle	12074450	\$429 / \$479
---	----------	---------------

GFVi 712/77 Fully Integrated Panel Full Size, Clean Touch Steel™, 4" toe-kick, Range Panel	12074470	\$429 / \$479
--	----------	---------------

GFVi 709/77 Fully Integrated Panel Full Size, Clean Touch Steel™, 4" toe-kick, Pocket handle	11750840	\$429 / \$479
--	----------	---------------

OPTIONAL ACCESSORIES SF(P)	MATERIAL	UMRP
----------------------------	----------	------

GPL 77-1 SS Filler Strips (pair)	6415910	\$67
----------------------------------	---------	------

*Handles sold separately.
See page 20 for full list of handle options.

24" Dishwasher - Fully Integrated Knock2Open



MODEL	HANDLE TYPE	MATERIAL	UMRP/RETAIL
G 7591 SCVi K2O ADA Custom Panel	No Handle	11388260	\$2,799 / \$2,899

SPECIFICATIONS

Width	23 ^{9/16} in (598 mm)
Height	32 ^{1/16} - 34 ^{1/4} in (814 - 870 mm)
Depth	22 ^{7/16} in (570 mm)
Shipping Weight	121 lbs (55 kg)
Annual Energy Usage	230 kWh
Decibal rating	40 dBA
ADA Compliant	Yes

FEATURES

- EcoPower Technology
- Controls: DirectSensor, hidden
- 3D MultiFlex Cutlery Tray
- BrilliantLight
- AutoOpen Drying
- SensorDry
- AutoDos with PowerDisk
- Basket Design: MaxiComfort
- No. of Standard Place Settings: 16
- Double Waterproof System
- Miele@home/AutoStart
- Knock2Open
- Automatic Load Sensor
- Water Softner
- Delay Start

PROGRAMS

- Normal
- QuickIntenseWash
- Pots & Pans
- SaniWash
- Rinse & Hold
- China & Crystal
- Economy
- Extra Quiet: 38 dBA
- Grates & Filters
- Clean Machine
- Energy Saver
- SensorWash

OPTIONS

- Express
- FlexiTimer
- Extra Economical
- Extra Clean
- Extra Dry
- Intense Zone

OPTIONAL ACCESSORIES

	MATERIAL	UMRP/RETAIL
GPL 77-1 SS Filler Strips (pair)	6415910	\$67 / \$67
GFVi 701/72 Fully Integrated Panel Full Size, Clean Touch Steel™, 6" toekick, no handle	10986740	\$329 / \$379
GFVi 701/77 Fully Integrated Panel Full Size, Clean Touch Steel™, 4" toekick, no handle	10986750	\$329 / \$379
GFVi 710/77 Fully Integrated Panel Full Size, Clean Touch Steel™, 4" toekick, PureLine handle	12074350	\$429 / \$479
GFVi 711/72 Fully Integrated Panel Full Size, Clean Touch Steel™, 6" toekick, ContourLine handle	12074400	\$429 / \$479
GFVi 711/77 Fully Integrated Panel Full Size, Clean Touch Steel™, 4" toekick, ContourLine handle	12074450	\$429 / \$479
GFVi 712/77 Fully Integrated Panel Full Size, Clean Touch Steel™, 4" toekick, Range Panel	12074470	\$429 / \$479
GFVi 709/77 Fully Integrated Panel Full Size, Clean Touch Steel™, 4" toekick, Pocket handle	11750840	\$429 / \$479

24" Dishwasher - Fully Integrated Knock2Open



MODEL	HANDLE TYPE	MATERIAL	UMRP/RETAIL
G 7596 SCVi K2O Custom Panel	No Handle	11388280	\$2,799 / \$2,899

SPECIFICATIONS

Width	23 ^{9/16} in (598 mm)
Height	33 ^{11/16} - 36 ^{1/4} in (855 - 920 mm)
Depth	22 ^{7/16} in (570 mm)
Shipping Weight	121 lbs (55 kg)
Annual Energy Usage	230 kWh
Decibal rating	40 dBA

FEATURES

- EcoPower Technology
- Controls: DirectSensor, hidden
- 3D MultiFlex Cutlery Tray
- BrilliantLight
- AutoOpen Drying
- SensorDry
- AutoDos with PowerDisk
- Basket Design: MaxiComfort
- No. of Standard Place Settings: 16
- Double Waterproof System
- Miele@home/AutoStart
- Knock2Open
- Automatic Load Sensor
- Water Softner
- Delay Start

PROGRAMS

- Normal
- QuickIntenseWash
- Pots & Pans
- SaniWash
- Rinse & Hold
- China & Crystal
- Economy
- Extra Quiet: 38 dBA
- Grates & Filters
- Clean Machine
- Energy Saver
- SensorWash

OPTIONS

- Express
- FlexiTimer
- Extra Clean
- Extra Dry
- Extra Economical
- Intense Zone

OPTIONAL ACCESSORIES

OPTIONAL ACCESSORIES	MATERIAL	UMRP/RETAIL
GPL 77-1 SS Filler Strips (pair)	6415910	\$67 / \$67
GFVi 701/72 Fully Integrated Panel Full Size, Clean Touch Steel™, 6" toekick, no handle	10986740	\$329 / \$379
GFVi 701/77 Fully Integrated Panel Full Size, Clean Touch Steel™, 4" toekick, no handle	10986750	\$329 / \$379
GFVi 710/77 Fully Integrated Panel Full Size, Clean Touch Steel™, 4" toekick, PureLine handle	12074350	\$429 / \$479
GFVi 711/72 Fully Integrated Panel Full Size, Clean Touch Steel™, 6" toekick, ContourLine handle	12074400	\$429 / \$479
GFVi 711/77 Fully Integrated Panel Full Size, Clean Touch Steel™, 4" toekick, ContourLine handle	12074450	\$429 / \$479
GFVi 712/77 Fully Integrated Panel Full Size, Clean Touch Steel™, 4" toekick, Range Panel	12074470	\$429 / \$479
GFVi 709/77 Fully Integrated Panel Full Size, Clean Touch Steel™, 4" toekick, Pocket handle	11750840	\$429 / \$479

24" Dishwasher - Integrated



MODEL	HANDLE TYPE	MATERIAL	UMRP/RETAIL
G 7916 SCI Custom Panel	No Handle	11388290	\$3,399 / \$3,499

SPECIFICATIONS

Width	23 ^{9/16} in (598 mm)
Height	33 ^{11/16} - 36 ^{1/4} in (855 - 920 mm)
Depth	22 ^{7/16} in (570 mm)
Shipping Weight	121 lbs (55 kg)
Annual Energy Usage	230 kWh
Decibal rating	40 dBA

FEATURES

- EcoPower Technology
- Controls: M Touch, front
- 3D MultiFlex Cutlery Tray
- BrilliantLight
- AutoOpen Drying
- SensorDry
- AutoDos with PowerDisk
- Basket Design: MaxiComfort
- No. of Standard Place Settings: 16
- Double Waterproof System
- Miele@home/AutoStart
- Automatic Load Sensor
- Water Softner
- Delay Start

PROGRAMS

- Normal
- QuickIntenseWash
- Pots & Pans
- SaniWash
- Rinse & Hold
- China & Crystal
- Economy
- Extra Quiet: 38 dBA
- Grates & Filters
- Clean Machine
- Energy Saver
- Tall Items
- Glass - No Rinse Aid (Warm)
- SensorWash

OPTIONS

- Express
- FlexiTimer
- Extra Economical
- Extra Clean
- Extra Dry
- Intense Zone
- Soak
- Pre-Rinse

OPTIONAL ACCESSORIES	MATERIAL	UMRP/RETAIL
GPL 77-1 SS Filler Strips (pair)	6415910	\$67 / \$67
GFV 60/60-7 Integrated Panel Full Size, Clean Touch Steel™, 6" toe-kick	10986720	\$269 / \$319
GFV 60/65-7 Integrated Panel Full Size, Clean Touch Steel™, 4" toe-kick	10986730	\$269 / \$319

24" Dishwasher - Fully Integrated



MODEL	HANDLE TYPE	MATERIAL	UMRP/RETAIL
G 7966 SCVi K2O Custom Panel	No Handle	11388300	\$3,499 / \$3,599

SPECIFICATIONS

Width	23 ⁹ / ₁₆ in (598 mm)
Height	33 ¹¹ / ₁₆ - 36 ¹ / ₄ in (855 - 920 mm)
Depth	22 ⁷ / ₁₆ in (570 mm)
Shipping Weight	121 lbs (55 kg)
Annual Energy Usage	230 kWh
Decibal rating	40 dBA

FEATURES

- EcoPower Technology
- Controls: M Touch, hidden
- 3D MultiFlex Cutlery Tray
- BrilliantLight
- AutoOpen Drying
- SensorDry
- AutoDos with PowerDisk
- Basket Design: MaxiComfort
- No. of Standard Place Settings: 16
- Double Waterproof System
- Miele@home/AutoStart
- Knock2Open
- Automatic Load Sensor
- Water Softner
- Delay Start

PROGRAMS

- Normal
- QuickIntenseWash
- Pots & Pans
- SaniWash
- Rinse & Hold
- China & Crystal
- Economy
- Extra Quiet: 38 dBA
- Grates & Filters
- Clean Machine
- Energy Saver
- Tall Items
- Glass - No Rinse Aid (Warm)
- SensorWash

OPTIONS

- Express
- FlexiTimer
- Extra Clean
- Extra Dry
- Intense Zone
- Soak
- Pre-Rinse

OPTIONAL ACCESSORIES

	MATERIAL	UMRP/RETAIL
GPL 77-1 SS Filler Strips (pair)	6415910	\$67 / \$67
GFVi 701/72 Fully Integrated Panel Full Size, Clean Touch Steel™, 6" toekick, no handle	10986740	\$329 / \$379
GFVi 701/77 Fully Integrated Panel Full Size, Clean Touch Steel™, 4" toekick, no handle	10986750	\$329 / \$379
GFVi 710/77 Fully Integrated Panel Full Size, Clean Touch Steel™, 4" toekick, PureLine handle	12074350	\$429 / \$479
GFVi 711/72 Fully Integrated Panel Full Size, Clean Touch Steel™, 6" toekick, ContourLine handle	12074400	\$429 / \$479
GFVi 711/77 Fully Integrated Panel Full Size, Clean Touch Steel™, 4" toekick, ContourLine handle	12074450	\$429 / \$479
GFVi 712/77 Fully Integrated Panel Full Size, Clean Touch Steel™, 4" toekick, Range Panel	12074470	\$429 / \$479
GFVi 709/77 Fully Integrated Panel Full Size, Clean Touch Steel™, 4" toekick, Pocket handle	11750840	\$429 / \$479

18" Dishwasher - SlimLine Fully Integrated



MODEL	HANDLE TYPE	MATERIAL	UMRP/RETAIL
G5482 SCVi Custom Panel	No Handle	11636760	\$1,299 / \$1,399

SPECIFICATIONS

Width	17 ⁵ / ₈ in (448 mm)
Height	32 ¹ / ₁₆ - 34 ¹ / ₄ in (814 - 880 mm)
Depth	22 ⁷ / ₁₆ in (570 mm)
Shipping Weight	121 lbs (55 kg)
Annual Energy Usage	230 kWh
Decibal rating	44 dBA
ADA Compliant	Yes

FEATURES

- EcoPower Technology
- Controls: DirectSelect, hidden
- Original Cutlery Basket
- Basket Design: Comfort
- No. of Standard Place Settings; 10
- Double Waterproof System
- Automatic Load Sensor

PROGRAMS

- Normal
- QuickIntenseWash
- Pots & Pans
- SaniWash
- Rinse & Hold

OPTIONS

- Express
- Extra Clean
- Extra Dry

OPTIONAL ACCESSORIES	MATERIAL	UMRP/RETAIL
GFVi 453/72-7 Fully Integrated Panel SlimLine, Clean Touch Steel™, 6" toekick, no handle	11526970	\$269 / \$319
GFVi 453/77-7 Fully Integrated Panel SlimLine, Clean Touch Steel™, 4" toekick, no handle	11573740	\$269 / \$319

18" Dishwasher - SlimLine Fully Integrated



MODEL	HANDLE TYPE	MATERIAL	UMRP/RETAIL
G5892 SCVi Custom Panel	No Handle	11636790	\$1,999 / \$2,099

SPECIFICATIONS

Width	17 ^{5/8} in (448 mm)
Height	32 ^{1/16} - 34 ^{1/4} in (814 - 880 mm)
Depth	22 ^{7/16} in (570 mm)
Shipping Weight	107 lbs (48.5kg)
Annual Energy Usage	200 kWh
Decibal rating	42 dBA
ADA Compliant	Yes

FEATURES

- EcoPower Technology
- Controls: DirectSelect, hidden
- 3D MultiFlex Cutlery Tray
- BrilliantLight
- AutoOpen Drying
- SensorDry
- Basket Design: MaxiComfort
- No. of Standard Place Settings; 10
- Double Waterproof System
- Miele@home/AutoStart
- Automatic Load Sensor
- Water Softner

PROGRAMS

- Normal
- QuickIntenseWash
- Pots & Pans
- SaniWash
- Rinse & Hold
- China & Crystal
- Economy
- Extra Quiet: 40dBA
- Grates & Filters
- Clean Machine
- Energy Saver
- SensorWash







OPTIONS

- Express
- Extra Clean
- Extra Dry
- Intense Zone





OPTIONAL ACCESSORIES

OPTIONAL ACCESSORIES	MATERIAL	UMRP
GFVi 453/72-7 Fully Integrated Panel SlimLine, Clean Touch Steel™, 6" toekick, no handle	11526970	\$269 / \$319
GFVi 453/77-7 Fully Integrated Panel SlimLine, Clean Touch Steel™, 4" toekick, no handle	11573740	\$269 / \$319

Handle Options

GEN 7	MODEL	MATERIAL	TRIM / COLOR	APPLIANCE WIDTH
	DS 7000	11345890	PureLine Stainless Steel	24 in
	DS 7000	11345930	VitroLine Obsidian black	24 in
	DS 7000	11345940	VitroLine Brillant white	24 in
	DS 7000	11345950	VitroLine Graphite grey	24 in
	DS 7308	12047020	ContourLine Stainless Steel standard handle	30 in
	DS 7708	12047000	ContourLine Stainless Steel swiveling handle	30 in
	DS 7808	12047030	VitroLine Obsidian black	30 in
	DS 7808	12047050	VitroLine Graphite grey	30 in
	DS 7808	12047060	VitroLine Brillant white	30 in
	DS 7808	12046910	PureLine Stainless Steel	30 in
GEN 6	MODEL	MATERIAL	TRIM / COLOR	APPLIANCE WIDTH
	DS 6000	10490600	GEN6000 PureLine Handle*	24 in
	DS 6000	9824160	GEN6000 ContourLine Handle*	24 in

Slimline Dishwasher Handle Options

	MATERIAL	TRIM / COLOR	APPLIANCE WIDTH
	7482860	Straight Slimline Handle	18 in
	7479080	Profi Slimline Handle	18 in
	9225620	Square Slimline Handle	18 in
	9225630	Signature Slimline Handle	18 in

	COOKING	VI DISHWASHER	SF DISHWASHER	VI COOLING	SF MASTERCOOL	UMRP
	X	X		X		\$149
	X	X		X		\$309
	X	X		X		\$309
	X	X		X		\$309
	X	X		X	X	\$169
	X	X		X	X	\$209
	X	X		X		\$349
	X	X		X		\$349
	X	X		X		\$349
	X	X		X		\$169
	COOKING	VI DISHWASHER	SF DISHWASHER	VI COOLING	SF MASTERCOOL	UMRP
			x (G 5000 SF)			Contact Parts Dept.
			x (G 7000 SF)			Contact Parts Dept.

	COOKING	VI DISHWASHER	SF DISHWASHER	VI COOLING	SF MASTERCOOL	UMRP
						\$160.65
						\$257.50
						\$177.89
						\$257.40

Product Highlights

Professional for the Home Dishwashers

*See specific models for details

ProfiLine

With their impressively short cycle times, ProfiLine Dishwashers are 2.5x faster than domestic dishwashers with only a 24-minute cycle time.

FEATURE	DESCRIPTION
Exemplary Hygiene	Special 'SaniWash' program achieve temperatures of 180°F 82°C. Final rinse temperatures for selected programs can also be increased for even greater hygiene.
12,500 Program Cycles	ProfiLine dishwashers are tested under laboratory conditions to ensure that they last 12,500 typical cycles and are designed for up to 5 cycles per day.
Intuitive Operation	All programs use intuitive sensor controls. Self-explanatory symbols and key content in plain text speed up program selection and avoid operating errors.
Versatile Baskets	For simple loading and a large volume of dishware ProfiLine represents the perfect stepping stone into the world of commercial dish care.
Golden Virus Seal 	All Miele dishwashers remove more than 99.9% of all viruses.*

Freshwater

Intelligent dishwashing technology and a powerful heater pump ensure optimum program durations and cleaning results.

FEATURE	DESCRIPTION
Plastic Baskets on two levels	Plastic baskets can be used on two levels in dishwasher models PG 8056 and PG 8061. Three spray arms allow perfect cleaning results to be achieved on both washing levels.
Connection for Dispenser Module	To simplify the use of liquid detergents and rinse aid, up to 2 liquid dispensing modules can be optionally connected, in the PG 8056 and PG 8061 dishwashers.
Perfect GlassCare	Miele Professional dishwashers use Perfect GlassCare in the glasses program. This technology adjusts the water hardness precisely so that all the glasses are thoroughly but gently cleaned.
NSF/ANSI 3 Certified for Sanitization	For facilities that require a NSF/ANSI 3 certified dishwasher, the PG 8061 features a final rinse temperature of 185°F with a 1 minute holding time.

Golden Virus Seal

*According to the InFluenc_H - Institute for Integrative Hygiene and Virology, cleaning with ProfiLine dishwashers using Miele's ProCare Shine 12 GC cleaning agents removes enveloped and non-enveloped viruses (e.g. coronavirus, influenza, or noroviruses) in the Pots & Pans and Sanitize programs, as well as enveloped viruses (excluding Hepatitis B) in the QuickIntenseWash and Universal programs, even if load items are difficult to reprocess.

24" Dishwasher - Pre-Finished



MODEL	HANDLE TYPE	MATERIAL	UMRP/RETAIL
PFD 101U Clean Touch Steel™	Integrated Handle	11605420	\$3,155 /\$3,255

SPECIFICATIONS

Width	23 ^{9/16} in (598 mm)
Height	31 ^{11/16} - 34 ^{1/4} in (805 - 870 mm)
Depth	22 ^{7/16} in (570 mm)
Shipping Weight	113 lbs (51 kg)
Decibal Rating	48 dBA
ADA Compliant	Yes
Electrical Configuration	AC 120V 60 Hz, 15A
Plug	NEMA 5-15P

FEATURES

- Ideal for Offices, Showrooms, Active Kitchens and Private Homes
- Original Cutlery Basket
- ExtraComfort Basket Design
- No of Standard Place Settings: 13
- Up to 5 Wash Cycles per Day
- AutoOpen Assisted Drying
- Integrated Water Softener
- WiFiConn@ct
- Tested for 12,500 Program Cycles
- Final Rinse Temperature Up to 180°F (82°C) with a Holding Time of 2 Min
- Shortest Cycle with Hot Water Connection: 52 min.

PROGRAMS

- QuickIntenseWash
- Universal
- Pots & Pans
- Plastic
- China & Crystal
- SaniWash
- Rinse & Hold
- ECO

OPTIONAL ACCESSORIES

	MATERIAL	UMRP/RETAIL
BU 500 Additional Cutlery Basket (Lower Basket)	9614020	\$40 / \$40

24" Dishwasher - Integrated



MODEL	HANDLE TYPE	MATERIAL	UMRP/RETAIL
PFD 102i Custom Panel	Integrated Handle	11605430	\$3,890 /\$3,990

SPECIFICATIONS

Width	23 ^{9/16} in (598 mm)
Height	31 ^{11/16} - 34 ^{1/4} in (805 - 870 mm)
Depth	22 ^{7/16} in (570 mm)
Shipping Weight	109 lbs (49 kg)
Decibal Rating	48 dBA
ADA Compliant	Yes
Electrical Configuration	AC 120V 60 Hz, 15A
Plug	NEMA 5-15P

FEATURES

- Ideal for Offices, Showrooms, Active Kitchens and Private Homes
- Original Cutlery Basket
- ExtraComfort Basket Design
- No of Standard Place Settings: 13
- Up to 5 Wash Cycles per Day
- AutoOpen Assisted Drying
- Integrated Water Softener
- WiFiConn@ct
- BrilliantLight Interior Lighting
- Tested for 12,500 Program Cycles
- Final Rinse Temperature Up to 180°F (82°C) with a Holding Time of 2 Min
- Shortest Cycle with Hot Water Connection: 52 min.

PROGRAMS

- QuickIntenseWash
- Universal
- Pots & Pans
- Plastic
- China & Crystal
- SaniWash
- Rinse & Hold
- ECO

OPTIONAL ACCESSORIES

	MATERIAL	UMRP/RETAIL
BU 500 Additional Cutlery Basket (Lower Basket)	9614020	\$40 / \$40
GFV 60/60-7 Integrated Panel Full Size Clean Touch Steel™, 6" toekick, no handle	10986720	\$269 / \$319
GFV 60/65-7 Integrated Panel Full Size, Clean Touch Steel™, 4" toekick, no handle	10986730	\$269 / \$319

24" Dishwasher



MODEL	HANDLE TYPE	MATERIAL	UMRP/RETAIL
PFD 102i Custom Panel	Integrated Handle	11605500	\$3,890 / \$3,990

SPECIFICATIONS

Width	23 ^{9/16} in (598 mm)
Height	31 ^{11/16} - 34 ^{1/4} in (805 - 870 mm)
Depth	22 ^{7/16} in (570 mm)
Shipping Weight	109 lbs (49 kg)
Decibal Rating	48 dBA
ADA Compliant	Yes
Electrical Configuration	2N AC 120/208-240V, 60 Hz, 2x30A
Plug	NEMA 14-30P

FEATURES

- Ideal for Offices, Showrooms, Active Kitchens and Private Homes
- Original Cutlery Basket
- ExtraComfort Basket Design
- No of Standard Place Settings: 13
- Up to 5 Wash Cycles per Day
- AutoOpen Assisted Drying
- Integrated Water Softener
- WiFiConn@ct
- BrilliantLight Interior Lighting
- Tested for 12,500 Program Cycles
- Final Rinse Temperature Up to 180°F (82°C) with a Holding Time of 2 Min
- Shortest Cycle with Hot Water Connection: 24 min.

PROGRAMS

- QuickIntenseWash
- Universal
- Pots & Pans
- Plastic
- China & Crystal
- SaniWash
- Rinse & Hold
- ECO

OPTIONAL ACCESSORIES

	MATERIAL	UMRP/RETAIL
BU 500 Additional Cutlery Basket (Lower Basket)	9614020	\$40 / \$40
GFV 60/60-7 Integrated Panel Full Size Clean Touch Steel™, 6" toekick, no handle	10986720	\$269 / \$319
GFV 60/65-7 Integrated Panel Full Size, Clean Touch Steel™, 4" toekick, no handle	10986730	\$269 / \$319

24" Dishwasher - Fully Integrated



MODEL	HANDLE TYPE	MATERIAL	UMRP/RETAIL
-------	-------------	----------	-------------

PFD 104 SCVi Custom Panel	No Handle	11605450	\$4,520 / \$4,620
------------------------------	-----------	----------	-------------------

SPECIFICATIONS

Width	23 ^{9/16} in (598 mm)
Height	33 ^{1/4} - 35 ^{13/16} in (845 - 910 mm)
Depth	22 ^{7/16} in (570 mm)
Shipping Weight	128 lbs (58 kg)
Decibal Rating	45 dBA
ADA Compliant	No
Electrical Configuration	AC 120V 60 Hz, 15A
Plug	NEMA 5-15P

FEATURES

- Ideal for Offices, Showrooms, Active Kitchens and Private Homes
- 3D MultiFlex Cutlery Basket
- MaxiComfort Basket Design with 3D MultiFlex Drawer
- No of Standard Place Settings: 16
- Up to 5 Wash Cycles per Day
- AutoOpen Assisted Drying
- Integrated Water Softener
- WiFiConn@ct
- BrilliantLight Interior Lighting
- Knock2open
- AutoOpen and AutoClose
- Tested for 12,500 Program Cycles
- Final Rinse Temperature Up to 180°F (82°C) with a Holding Time of 2 Min
- Shortest Cycle with Hot Water Connection: 52 min.

PROGRAMS

- QuickIntenseWash
- Universal
- Pots & Pans
- Plastic
- China & Crystal
- SaniWash
- Rinse & Hold
- ECO

OPTIONAL ACCESSORIES

	MATERIAL	UMRP/RETAIL
BU 500 Additional Cutlery Basket (Lower Basket)	9614020	\$40 / \$40
GFVi 701/72 Fully Integrated Panel Full Size, Clean Touch Steel™, 6" toekick, no handle	10986740	\$329 / \$379
GFVi 701/77 Fully Integrated Panel Full Size, Clean Touch Steel™, 4" toekick, no handle	10986750	\$329 / \$379

24" Dishwasher - Fully Integrated



MODEL	HANDLE TYPE	MATERIAL	UMRP/RETAIL
PFD 104 SCVi Custom Panel	No Handle	11605520	\$4,520 / \$4,620

SPECIFICATIONS

Width	23 ^{9/16} in (598 mm)
Height	33 ^{1/4} - 35 ^{13/16} in (845 - 910 mm)
Depth	22 ^{7/16} in (570 mm)
Shipping Weight	128 lbs (58 kg)
Decibal Rating	45 dBA
ADA Compliant	No
Electrical Configuration	2N AC 120/208-240V, 60 Hz, 2x30A
Plug	NEMA 14-30P

FEATURES

- Ideal for Offices, Showrooms, Active Kitchens and Private Homes
- 3D MultiFlex Cutlery Basket
- MaxiComfort Basket Design with 3D MultiFlex Drawer
- No of Standard Place Settings: 16
- Up to 5 Wash Cycles per Day
- AutoOpen Assisted Drying
- Integrated Water Softener
- WiFiConn@ct
- BrilliantLight Interior Lighting
- Knock2open
- AutoOpen and AutoClose
- Tested for 12,500 Program Cycles
- Final Rinse Temperature Up to 180°F (82°C) with a Holding Time of 2 Min
- Shortest Cycle with Hot Water Connection: 52 min.

PROGRAMS

- QuickIntenseWash
- Universal
- Pots & Pans
- Plastic
- China & Crystal
- SaniWash
- Rinse & Hold
- ECO

OPTIONAL ACCESSORIES

	MATERIAL	UMRP/RETAIL
BU 500 Additional Cutlery Basket (Lower Basket)	9614020	\$40 / \$40
GFVi 701/72 Fully Integrated Panel Full Size, Clean Touch Steel™, 6" toekick, no handle	10986740	\$329 / \$379
GFVi 701/77 Fully Integrated Panel Full Size, Clean Touch Steel™, 4" toekick, no handle	10986750	\$329 / \$379

24" Dishwasher - Pre-Finished



MODEL	HANDLE TYPE	MATERIAL	UMRP/RETAIL
PG 8056 Stainless Steel	Integrated Handle	9862620	\$5,895 / \$5,995

SPECIFICATIONS

Width	23 ^{9/16} in (598 mm)
Height	32 ^{1/4} in (820 mm)
Depth	22 ^{13/16} in (580 mm)
Shipping Weight	153 lbs (69 kg)
Decibal Rating	57 dBA
ADA Compliant	Yes
Electrical Configuration	2AC 208V, 60 Hz, 2x30A
Plug	NEMA L6-30

FEATURES

- Suitable for Offices, Active Kitchens, Private Homes, Restaurants, Bars etc.
- Large Variety of Baskets and Inserts, Including Commercial Plastic Baskets
- Integrated Water Softener
- Large Capacity and Multi-Level Cleaning for High Throughput
- Connection for Dispenser Modules
- Tested for Up to 40 Cycles per Day
- Tested for at Least 15,000 Operating Hours
- Final Rinse Temperature Up to 158°F (60°C) with a Holding Time of 10 Min
- Shortest Cycle Time: 6 min.

PROGRAMS

- Rapid
- Normal plus
- Sanitize
- Normal
- Intensive
- China & Crystal
- Glasses
- Utensils
- Plastic
- Economy
- Reactivation
- Rinse & Hold
- Drain

INCLUDED ACCESSORIES	MATERIAL	UMRP
1 x O 891 Upper Basket for Cups (Height Adjustable)	9548970	\$185
1 x U 890 Lower Basket for Inserts	9549130	\$120
1 x E 810 Insert for Dessert Plates	9549010	\$45
2 x E 816 Inserts for Plates	9549190	\$45
2 x E 165 Inserts for Cutlery	3808830	\$15

*Optional Accessories: See Pages 30-31

24" Dishwasher - Pre-Finished

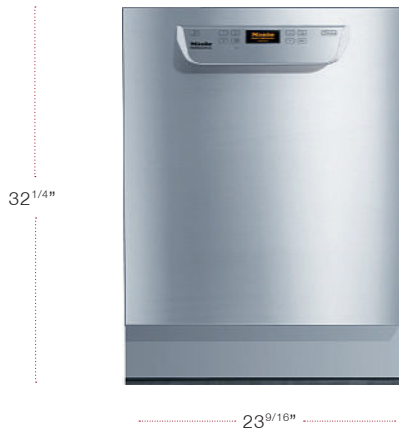

MODEL	HANDLE TYPE	MATERIAL	UMRP/RETAIL
PG 8056 Stainless Steel	Integrated Handle	9862610	\$5,895 / \$5,995

SPECIFICATIONS

Width	23 ^{9/16} in (598 mm)
Height	32 ^{1/4} in (820 mm)
Depth	22 ^{13/16} in (580 mm)
Shipping Weight	153 lbs (69 kg)
Decibal Rating	57 dBA
ADA Compliant	Yes
Electrical Configuration	2AC 240V, 60 Hz, 2x30A
Plug	NEMA L6-30

FEATURES

- Suitable for Offices, Active Kitchens, Private Homes, Restaurants, Bars etc.
- Large Variety of Baskets and Inserts, Including Commercial Plastic Baskets
- Integrated Water Softener
- Large Capacity and Multi-Level Cleaning for High Throughput
- Connection for Dispenser Modules
- Tested for Up to 40 Cycles per Day
- Tested for at Least 15,000 Operating Hours
- Final Rinse Temperature Up to 158°F (60°C) with a Holding Time of 10 Min
- Shortest Cycle Time: 6 min.

PROGRAMS

- Rapid
- Normal plus
- Sanitize
- Normal
- Intensive
- China & Crystal
- Glasses
- Utensils
- Plastic
- Economy
- Reactivation
- Rinse & Hold
- Drain

INCLUDED ACCESSORIES	MATERIAL	UMRP
1 x O 891 Upper Basket for Cups (Height Adjustable)	9548970	\$185
1 x U 890 Lower Basket for Inserts	9549130	\$120
1 x E 810 Insert for Dessert Plates	9549010	\$45
2 x E 816 Inserts for Plates	9549190	\$45
2 x E 165 Inserts for Cutlery	3808830	\$15

*Optional Accessories: See Pages 30-31

24" Dishwasher - Pre-Finished



MODEL	HANDLE TYPE	MATERIAL	UMRP/RETAIL
PG 8061 Stainless Steel	Integrated Handle	9799780	\$6,430 / \$6,530

SPECIFICATIONS

Width	23 ^{9/16} in (598 mm)
Height	32 ^{1/4} in (820 mm)
Depth	23 ^{7/16} in (595 mm)
Shipping Weight	153 lbs (69 kg)
Decibal Rating	57 dBA
ADA Compliant	Yes
NSF/ANSI 3	Yes
Electrical Configuration	2AC 208V, 60 Hz, 2x30A
Plug	NEMA L15-20

FEATURES

- Suitable for Customers That Require a NSF 3 Classified Dishwasher like Pre-Schools, Assisted Living, Medical Offices etc.
- Large Variety of Baskets and Inserts, Including Commercial Plastic Baskets
- Up to 40 Wash Cycles per Day
- Integrated Water Softener
- Large Capacity and Multi-Level Cleaning
- Connection for Dispenser Modules
- Designed for at least 15,000 operating hours
- Final Rinse Temperature Up to 185°F (60°C) with a Holding Time of 1 min
- Shortest Cycle Time: 15 min.

PROGRAMS

- Short
- Universal
- Intensive
- Reactivation
- Rinse & Hold
- Drain

INCLUDED ACCESSORIES

INCLUDED ACCESSORIES	MATERIAL	UMRP
1 x O 891 Upper Basket for Cups (Height Adjustable)	9548970	\$185
1 x U 890 Lower Basket for Inserts	9549130	\$120
1 x E 810 Insert for Dessert Plates	9549010	\$45
2 x E 816 Inserts for Plates	9549190	\$45
2 x E 165 Inserts for Cutlery	3808830	\$15

*Optional Accessories: See Pages 30-31

24" Dishwasher - Pre-Finished



MODEL	HANDLE TYPE	MATERIAL	UMRP/RETAIL
PG 8061 Stainless Steel	Integrated Handle	9801160	\$6,430 / \$6,530

SPECIFICATIONS

Width	23 ^{9/16} in (598 mm)
Height	32 ^{1/4} in (820 mm)
Depth	23 ^{7/16} in (595 mm)
Shipping Weight	153 lbs (69 kg)
Decibal Rating	57 dBA
ADA Compliant	Yes
NSF/ANSI 3	Yes
Electrical Configuration	2AC 240V, 60 Hz, 2x30A
Plug	NEMA L15-20

FEATURES

- Suitable for Customers That Require a NSF 3 Classified Dishwasher like Pre-Schools, Assisted Living, Medical Offices etc.
- Large Variety of Baskets and Inserts, Including Commercial Plastic Baskets
- Up to 40 Wash Cycles per Day
- Integrated Water Softener
- Large Capacity and Multi-Level Cleaning
- Connection for Dispenser Modules
- Designed for at least 15,000 operating hours
- Final Rinse Temperature Up to 185°F (60°C) with a Holding Time of 1 min
- Shortest Cycle Time: 15 min.

PROGRAMS

- Reactivation
- Rinse & Hold
- Drain
- Short
- Universal
- Intensive

INCLUDED ACCESSORIES

INCLUDED ACCESSORIES	MATERIAL	UMRP
1 x O 891 Upper Basket for Cups (Height Adjustable)	9548970	\$185
1 x U 890 Lower Basket for Inserts	9549130	\$120
1 x E 810 Insert for Dessert Plates	9549010	\$45
2 x E 816 Inserts for Plates	9549190	\$45
2 x E 165 Inserts for Cutlery	3808830	\$15

*Optional Accessories: See Pages 30-31

Optional Accessories (Models PG 8056 - 8061)

BASKETS AND INSERTS	MATERIAL	UMRP
O 891 Upper Basket For Cups/Saucers, Etc.	9548970	\$185
O 892 Upper Basket For Glasses	9548990	\$215
U 890 Lower Basket For Inserts	9549130	\$120
U 881 Lower Basket With Fixed Insert For Saucers	4906620	\$215
O 899 Upper Basket For Inserts	9549040	\$270
O 885 Upper Basket For Inserts	9548960	\$325
U 876 Lower Basket For Inserts	9549160	\$325
O 898 Upper Basket For Inserts	10114490	\$485
E 816 Plate Insert For Lower Basket	9549190	\$45
E 216 Plate Insert For Lower Basket	3809080	\$45
E 810 Plate Insert For Upper Basket	9549010	\$45
E 888 Plate Insert For Lower Basket	5018690	\$65
E 809 Top Insert For Lower Basket	5018650	\$90
E 9 Insert For Large Individual Items	3808260	\$65
E 165 Cutlery Holder, 3 Compartments	3808830	\$15
E 167 Cutlery Holder, 7 Compartments	9508730	\$45
E 437 Cutlery Holder, 36 Compartments	4326640	\$390
E 884 Insert For Baking Sheets, Platters	5018680	\$65
Apfd 400 Holding Bracket	10869860	\$45
Apfd 401 Insert For Medication Cups	10869810	\$150
Apfd 402 Insert For Medication Cup Lids	10869850	\$15
E 205 Glassware Insert	3808980	\$70
E 459 Glassware Insert	4326630	\$390
E 815 Glassware Insert	5018670	\$90
E 812 Glassware Insert	9742240	\$130
E 166 Perforated Plate	3808850	\$90
E 10 Perforated Plate	9627360	\$185
E 11 Perforated Plate	9752140	\$100
U 502 Plate Basket	9508610	\$150
U 503 Cutlery Basket	9508660	\$150
U 504 Cutlery Basket	9508670	\$195
U 505 Multi-Purpose Basket	9508680	\$195
U 506 Plate Basket	9508640	\$185
U 507 Bistro Basket	9508700	\$185
U 508 Basket For Cups	9508650	\$165
U 313/2 Basket For Trays	9688930	\$240

BASKETS AND INSERTS	MATERIAL	UMRP
U 520 Glassware Basket	9581370	\$110
U 524/1 Glassware Basket	10094770	\$195
U 525/1 Glassware Basket	10094780	\$195
U 534 16 Glasses, Shallow Top Frame	6997120	\$195
U 535 25 Glasses, Shallow Top Frame	6984150	\$195
U 536 36 Glasses, Shallow Top Frame	6984090	\$195
U 537 42 Glasses, Shallow Top Frame	6984200	\$195
U 544 16 Glasses, Deep Top Frame	6984190	\$195
U 545 25 Glasses, Deep Top Frame	6984170	\$195
U 546 36 Glasses, Deep Top Frame	6984130	\$195
U 547 42 Glasses, Deep Top Frame	6984210	\$195
U 634-S 16 Glasses, With Sloping Bases	10322510	\$250
U 635-S 20 Glasses, With Sloping Bases	10322530	\$250
U 644-S 16 Glasses, With Sloping Bases	10322500	\$250
U 645-S 20 Glasses, With Sloping Bases	10322520	\$250

Optional Accessories (Models PG 8056 - 8061)

INSTALLATION	MATERIAL	UMRP
ABL 50 Spacer Trim, Stainless Steel	9378030	\$60
ABL 110 Spacer Trim, Stainless Steel	10271160	\$120
Stand 2 Toe-Kick, Stainless Steel	9456060	\$70
Stand 1-80 Freestanding Conversion Kit, Stainless Steel	9688950	\$205
DEF-80 Lid In Stainless Steel	9715550	\$195
BKS-80 Mounting Kit To Fix A Support Facing At The End Of A Kitchen Island	9715630	\$60
ADB Cover Plate For Built-In Dishwasher	9715590	\$65
BBF-80 Floor Anchoring	9715690	\$55
VGF-900 Extended Machine Feet	9742270	\$55
Conversion Fee. To Convert PG 8061 from 3AC to 2AC (3AC requires 20A, 2AC requires 30A Requires 30 Amp)	94001810	\$270



PLINTHS AND BASES	MATERIAL	UMRP
UO 30-60/80 Open Base, 11 ^{13/16} in (30cm)	9688890	\$645
UO 52-60/80 Open Base, 20 ^{1/2} in (52cm)	9688900	\$810
UG 30-60/80 Box Base, 11 ^{13/16} in (30cm)	9688910	\$645
UG 52-60/80 Box Base 20 ^{1/2} in (52cm)	9688920	\$810
UG 70-60/80 Box Plinth With Door, 27 ^{9/16} in (30cm)	10031420	\$1,940

DISPENSING	MATERIAL	UMRP
DOS G 80 Flex Dispenser Module, 13 7/8" Suction Lance	10730850	\$455
DTD 1 Drip Tray	10695460	\$45

Product Highlights

Washing Machines

*See specific models for details

FEATURE	DESCRIPTION
Honeycomb Drum	The Honeycomb drum has a special sculptured surface which allows fabrics to glide on a thin cushion of water.
TwinDos	Liquid detergent automatic dispensing system for achieving the best wash results. Save up to 30% detergent compared to manual dispensing.
IntenseWash	IntenseWash offers the highest level of cleaning, with Spin&Spray technology using less water and heating energy.
QuickIntenseWash	Utilizing the IntenseWash technology, the QuickIntenseWash program provides excellent cleanliness in just 49 minutes.
SingleWash	An efficient solution for washing single garments quickly, while saving water and energy.
CapDosing	Dispense special detergent for different types of fabric by placing a portioned capsule into the fabric softener compartment.
Certified Hygiene Seal 	All Miele W1 Washing Machines remove more than 99.99% of specific bacteria.*
Golden Virus Seal 	WXI 860 WCS and WXR 860 WCS Miele Washing Machines remove more than 99.9% of all viruses.*

Dryers

FEATURE	DESCRIPTION
Honeycomb Drum	Fewer creases and easier ironing, the honeycomb structure allows laundry to be dried gently and evenly.
Heat-Pump Technology	Saving up to 60% in energy consumption, the heat generated is reused and low temperatures protect the high-quality fibers in the most delicate fabrics.
FragranceDos and FragranceDos ²	Miele fragrance flacons add your favorite scent to your laundry during the drying process. With FragranceDos ² , you can insert two flacons into the machine at once to switch between your two favorite fragrances.
SteamFinish	A great alternative to ironing, steam and smooth your laundry during the drying process.
PerfectDry	PerfectDry takes the mineral content of your water into account and modifies the drying process accordingly.

Certified Hygiene Seal

*Proven by Rhine-Waal University of Applied Sciences, all Miele W1 Washing Machines remove more than 99.99% of specific bacteria when using the Sanitize Program.

Golden Virus Seal

*Select Miele Washing Machines remove more than 99.9% of all viruses. Applies to W1 Washing Machines with TwinDos and IntenseWash, in combination with the Sanitize Program and AllergyWash option.

W1 Washing Machines



MODEL	MATERIAL	UMRP/RETAIL
WXD 160 WCS	11614070	\$1,399 / \$1,599

SPECIFICATIONS

Overall Width	23 1/2" in (596 mm)
Overall Height	33 1/2" in (850 mm)
Overall Depth	25 5/16" in (643 mm)
Shipping weight	221 lbs (100 kg)
Capacity	17.6 lbs. / 2.26 cu. ft.
Electrical Connection	120V, 15A

FEATURES

- HoneyComb drum
- 11 Wash Programs including SoftSteam option
- DirectSensor user interface
- WiFiConn@ct and Mobile Control
- CapDos
- Add Laundry Feature
- 1600 rpm max spin speed

WASH PROGRAMS

- Darks/Denims
- Express
- Handwash
- Delicates
- Proofing
- Shirts
- Outdoor
- Drain/spin
- Normal
- Extra White
- Sanitize

WASH OPTIONS

- SoftSteam
- Buzzer

MATCHING DRYERS	MATERIAL
TXD 160 WP	11619650

ACCESSORIES	MATERIAL	UMRP/RETAIL
WTV 502 (Stacking Kit)	9256140	\$99 / \$99
WTV 512 (Stacking Kit w/ Drawer 4 5/8" H)	9351790	\$249 / \$299
WTS 510 (Pedestal 13 7/8" H)	9322300	\$499 / \$549
Adaptor NEMA 14-30	10983750	\$55 / \$65

W1 Washing Machines



MODEL	MATERIAL	UMRP/RETAIL
WXF 660 WCS	11614130	\$1,599 / \$1,799

SPECIFICATIONS	
Overall Width	23 1/2" in (596 mm)
Overall Height	33 1/2" in (850 mm)
Overall Depth	25 5/16" in (643 mm)
Shipping Weight	221 lbs (100 kg)
Capacity	17.6 lbs. / 2.26 cu. ft.
Electrical Connection	120V, 15A

FEATURES	
- HoneyComb drum	- DirectSensor user interface
- TwinDos automatic detergent dispensing	- WiFiConn@ct and mobile control
- 20 Wash Programs including SoftSteam option	- CapDos
	- Add Laundry feature
	- 1600 rpm max spin speed

WASH PROGRAMS		
- Darks/Denims	- Shirts	- Table Linens/Drapes
- Express	- Outdoor	- Normal
- Handwash	- Wrinkle-free	- Extra White
- Delicates	- Silks	- Sanitize
- Proofing	- Towels	- Downs
- Pillows	- Sportswear	
- Baby clothes	- Woolens	
- Quick rinse		

WASH OPTIONS	
- SoftSteam	- Pre-rinse
- Buzzer	- AllergyWash
- Soak	- SingleWash

MATCHING DRYERS	MATERIAL
TXI 680 WP	11619850

ACCESSORIES	MATERIAL	UMRP/RETAIL
WTV 502 (Stacking Kit)	9256140	\$99 / \$99
WTV 512 (Stacking Kit w/ Drawer 4 ^{5/8} " H)	9351790	\$249 / \$299
WTS 510 (Pedestal 13 ^{7/8} " H)	9322300	\$499 / \$549
Adaptor NEMA 14-30	10983750	\$55 / \$65

W1 Washing Machines



MODEL	MATERIAL	UMRP/RETAIL
WXI 860 WCS	11614140	\$1,999 / \$2,199

SPECIFICATIONS

Overall Width	23 ^{1/2} " in (596 mm)
Overall Height	33 ^{1/2} " in (850 mm)
Overall Depth	25 ^{5/16} " in (643 mm)
Shipping weight	221 lbs (100 kg)
Capacity	17.6 lbs. / 2.26 cu. ft.
Electrical Connection	120V, 15A

FEATURES

- HoneyComb drum
- TwinDos automatic detergent dispensing
- 21 Wash Programs including SoftSteam option
- QuickIntenseWash and Single-Wash option
- WiFiConn@ct and Mobile Control
- CapDos
- 1600 rpm max spin speed

WASH PROGRAMS

- Darks/Denims
- Express
- Handwash
- Delicates
- Proofing
- Pillows
- Baby clothes
- Quick rinse
- Shirts
- Outdoor
- Wrinkle-free
- QuickIntense-Wash
- Silks
- Towels
- Sportswear
- Woolens
- Table Linens/Drapes
- Normal
- Extra White
- Sanitize
- Downs

WASH OPTIONS

- SoftSteam
- Buzzer
- Soak
- Pre-rinse
- AllergyWash
- SingleWash

MATCHING DRYERS	MATERIAL
TXI 680 WP	11619850

ACCESSORIES	MATERIAL	UMRP/RETAIL
WTV 502 (Stacking Kit)	9256140	\$99 / \$99
WTV 512 (Stacking Kit w/ Drawer 4 ^{5/8} " H)	9351790	\$249 / \$299
WTS 510 (Pedestal 13 ^{7/8} " H)	9322300	\$499 / \$549
Adaptor NEMA 14-30	10983750	\$55 / \$65

W1 Washing Machines



MODEL	MATERIAL	UMRP/RETAIL
WXR 860 WCS	11613700	\$2,299 / \$2,499

SPECIFICATIONS

Overall Width	23 ^{1/2} " in (596 mm)
Overall Height	33 ^{1/2} " in (850 mm)
Overall Depth	25 ^{5/16} " in (643 mm)
Shipping weight	221 lbs (100 kg)
Capacity	17.6 lbs. / 2.26 cu. ft.
Electrical Connection	120V, 15A

FEATURES

- HoneyComb drum
- M Touch premium user interface
- TwinDos automatic detergent dispensing
- 25 Wash Programs including SoftSteam option
- QuickIntenseWash and SingleWash option
- CapDos
- 1600 rpm max spin speed

WASH PROGRAMS

- Express
- Handwash
- Delicates
- Curtains
- Proofing
- Denim
- Pillows
- Baby clothes
- Quick rinse
- Sneakers
- Shirts
- Outdoor
- Wrinkle-free
- QuickIntenseWash
- Silks
- Towels
- Sportswear
- Starch
- Woolens
- Table Linens/ Drapes
- Normal
- Extra White
- Sanitize
- Downs
- Dark garments

WASH OPTIONS

- SoftSteam
- Buzzer
- Soak
- Pre-rinse
- AllergyWash
- SingleWash

MATCHING DRYERS	MATERIAL
TXR 860 WP	11620030

ACCESSORIES	MATERIAL	UMRP/RETAIL
WTV 502 (Stacking Kit)	9256140	\$99 / \$99
WTV 512 (Stacking Kit w/ Drawer 4 ^{5/8} " H)	9351790	\$249 / \$299
WTS 510 (Pedestal 13 ^{7/8} " H)	9322300	\$499 / \$549
Adaptor NEMA 14-30	10983750	\$55 / \$65

T1 Heat Pump Dryers



MODEL	MATERIAL	UMRP/RETAIL
TXD 160 WP	11619650	\$1,499 / \$1,699

SPECIFICATIONS	
Overall Width	23 1/2" in (596 mm)
Overall Height	33 1/2" in (850 mm)
Overall Depth	25 5/16" in (643 mm)
Shipping weight	137 lbs (62 kg)
Capacity	4.02 cu. ft.
Electrical Connection	120V, 15A

FEATURES

- Ventless Heat-Pump Dryer
- Honeycomb drum
- PerfectDry moisture sensing technology
- DirectSensor user interface
- WiFiConn@ct and Mobile Control
- FragranceDos
- EnergyStar Most Efficient

DRYING PROGRAMS

- Normal
- Bed linens
- Express
- Delicates
- Woolens/Silks
- Proofing
- Denim
- Time dry/DryFresh
- Shirts
- Outdoor

DRYING OPTIONS

- Anti-Crease
- Gentle
- Buzzer

MATCHING WASHERS	MATERIAL
WXD 160 WCS	11614070

ACCESSORIES	MATERIAL	UMRP/RETAIL
WTV 502 (Stacking Kit)	9256140	\$99 / \$99
WTV 512 (Stacking Kit w/ Drawer 4 5/8" H)	9351790	\$249 / \$299
WTS 510 (Pedestal 13 7/8" H)	9322300	\$499 / \$549
Adaptor NEMA 14-30	10983750	\$55 / \$65
TRK 555 Dryer Basket	9614800	\$75 / \$85

T1 Heat Pump Dryers



MODEL	MATERIAL	UMRP/RETAIL
TXI 680 WP	11619850	\$1,699 / \$1,899

SPECIFICATIONS

Overall Width	23 1/2" in (596 mm)
Overall Height	33 1/2" in (850 mm)
Overall Depth	25 5/16" in (643 mm)
Shipping weight	137 lbs (62 kg)
Capacity	4.02 cu. ft.
Electrical Connection	120V, 15A

FEATURES

- Ventless Heat-Pump Dryer
- Honeycomb drum
- PerfectDry moisture sensing technology
- ComfortSensor user interface
- 19 Programs including SoftSteam
- FragranceDos²
- EnergyStar Most Efficient

DRYING PROGRAMS

- Table Linens/Drapes
- Normal
- Bed linens
- Express
- Delicates
- SoftSteam
- Woolens/Silks
- Proofing
- Denim
- Pillows
- Basket
- Cold air
- Time dry
- DryFresh
- Shirts
- Outdoor
- Wrinkle-free
- Sportswear
- Smoothing

DRYING OPTIONS

- Anti-Crease
- Gentle
- Buzzer
- Freshen Up

MATCHING WASHERS	MATERIAL
WXF 660 WCS	11614130
WXI 860 WCS	11614140

ACCESSORIES	MATERIAL	UMRP/RETAIL
WTV 502 (Stacking Kit)	9256140	\$99 / \$99
WTV 512 (Stacking Kit w/ Drawer 4 ^{5/8} " H)	9351790	\$249 / \$299
WTS 510 (Pedestal 13 ^{7/8} " H)	9322300	\$499 / \$549
Adaptor NEMA 14-30	10983750	\$55 / \$65
TRK 555 Dryer Basket	9614800	\$75 / \$85

T1 Heat Pump Dryers



MODEL	MATERIAL	UMRP/RETAIL
TXR 860 WP	11620030	\$2,299 / \$2,499

SPECIFICATIONS

Overall Width	23 ^{1/2} " in (596 mm)
Overall Height	33 ^{1/2} " in (850 mm)
Overall Depth	25 ^{5/16} " in (643 mm)
Shipping weight	137 lbs (62 kg)
Capacity	4.02 cu. ft.
Electrical Connection	120V, 15A

FEATURES

- Ventless Heat-Pump Dryer
- Honeycomb drum
- PerfectDry moisture sensing technology
- M Touch premium user interface
- 19 Programs including SoftSteam
- FragranceDos²
- EnergyStar Most Efficient

DRYING PROGRAMS

- Table Linens/Drapes
- Normal
- Bed linens
- Express
- Delicates
- SoftSteam
- Woolens/Silks
- Proofing
- Denim
- Pillows
- Basket
- Cold air
- Time dry
- DryFresh
- Shirts
- Outdoor
- Wrinkle-free
- Sportswear
- Smoothing

DRYING OPTIONS

- Anti-Crease
- Gentle
- Buzzer
- Freshen Up

MATCHING WASHERS	MATERIAL
WXR 860 WCS 11620030	11620030

ACCESSORIES	MATERIAL	UMRP/RETAIL
WTV 502 (Stacking Kit)	9256140	\$99 / \$99
WTV 512 (Stacking Kit w/ Drawer 4 ^{5/8} " H)	9351790	\$249 / \$299
WTS 510 (Pedestal 13 ^{7/8} " H)	9322300	\$499 / \$549
Adaptor NEMA 14-30	10983750	\$55 / \$65
TRK 555 Dryer Basket	9614800	\$75 / \$85

Rotary Ironer

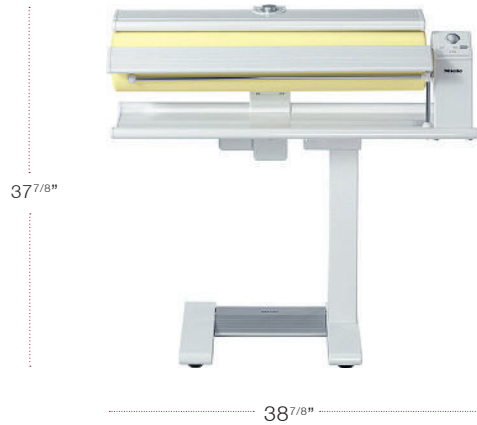

MODEL	MATERIAL	UMRP/RETAIL
B 990 Rotary Ironer	7222730	\$2,199 / \$2,399

FINISH

Lotus White

SPECIFICATIONS

Width	38 ^{7/8} in (985 mm)
Height	37 ^{7/8} in (959 mm)
Depth	15 in (380 mm)
Shipping Weight	92.5 lbs (45 kg)
Roller Width	32.5 in

FEATURES

- 32.5" Wide Roller
- Three Heating Elements for Optimum Heat Distribution
- Variable Roller Speed
- Temperature Selection to Suit Textiles
- Laundry Feed Board for Easy Laundry Handling
- Convenient Infeed Board with Ample Storage Space
- Airing Bar for Crease-Free Cooling
- Moisture - Absorbing Roller Padding
- Convenient Folding Mechanism
- Easily Maneuverable with Four Castors
- Wide Foot Control Bar
- Automatic Finger Guard
- Emergency Release

Product Highlights

Professional for the Home Laundry

*See specific models for details

Washing Machines

FEATURE	DESCRIPTION
Honeycomb Drum	Has a perforated rear panel for fast wetting of laundry. The perforated rear panel Honeycomb Drum combined with high spin speeds supports shorter cycle time without compromising on performance.
Express Wash	Providing excellent cleanliness in just 25-minutes.
Ultimate Convenience	With intuitive M Touch controls, easily select your settings with the swipe of a finger. Choose from 50+ programs; 5 are customizable.
CapDosing	Dispense special detergent for different types of fabric by placing a portioned capsule into the fabric softener compartment.
Professional Grade Laundry for the Home	The Little Giant Washers have a 19-gallon drum size and provide professional-grade disinfection and fabric care in a high-efficiency, compact system.

Dryers

FEATURE	DESCRIPTION
Honeycomb Drum	Fewer creases and easier ironing, the honeycomb structure allows laundry to be dried gently and evenly.
Heat-Pump Technology	Saving on energy consumption, the heat generated is reused and low temperatures protect the high-quality fibers in the most delicate fabrics.
Ultimate Convenience	With intuitive M Touch controls, easily select your settings with the swipe of a finger. Choose from 35 programs; 5 are customizable.
PerfectDry	PerfectDry takes the mineral content of your washer into account and modifies the drying process accordingly.
Powerful Drive System	Two separate motors for a quicker and more efficient drying process with even less creasing.

Little Giant Washer - Performance Plus



MODEL	MATERIAL	UMRP/RETAIL
PWM 908 DP Lotus White	11204460	\$5,045 / \$5,245
PWM 908 DP Stainless Steel	11204470	\$5,365 / \$5,565

MATCHING DRYERS	MATERIAL
PDR 908 HP Lotus White	11204480
PDR 908 HP Stainless Steel	11204490

SPECIFICATIONS

Width	23 ^{7/16} in (596 mm)
Height	33 ^{7/16} in (850 mm)
Depth	28 ^{1/8} in (714 mm)
Shipping Weight	230 lbs (104 kg)
Front Material (Lotus White Model)	Porcelain Enameled White
Front Material (Stainless Steel Model)	Stainless Steel
Side Panels (both models)	Powder Coated White
Electrical Connection	2 AC 208-240V, 60 Hz, 30 A
Plug	NEMA L6-30
Capacity	2.58 cu.ft; 73 Liter

FEATURES

- Spin Speed; 1600 rpm
- Detergent Dispenser Drawer, 3 Compartments
- CapDosing
- Possible Connections to Dispensing Pumps: 6
- M Touch Flex User Interface (No Buttons or Dials)
- 49-minute Cotton 140°F Program (with Hot Water Connection)
- 25-minute Express Wash Cycle
- 50+ Programs: 5 Customizable
- High Temperature Disinfection Programs (up to 200°F)
- Bearing Designed for 30,000 Operating Hours
- Stackable or Side-by-Side Configuration
- 3D Imbalance Monitoring
- Commercial Soft-Mounted
- HoneyComb Drum (for Washers) with Perforated Rear Wall

PROGRAMS

- Standard Programs: 16
- Sport Programs: 4
- Down Filled Items
- Outwear
- Proofing
- Wellness/ Hair Salon Programs: 3
- Work Wear like Oil/fat Special, Dust/ Flour Special
- Thermal Disinfection: 16
- Wet Care Programs: 5

OPTIONAL ACCESSORIES	MATERIAL	UMRP
TAK 555 Dryer Basket	9614800	\$75
APCL 001 Stainless Steel Stacking Kit	11167420	\$280
APCL 084 Iron-Grey Base, Open, 6 in. Tall	11776560	\$470
APCL 085 Iron-Grey Base, Open, 12 in. Tall	11776570	\$490
APCL 087 Iron-Grey Base, Open, 19 in. Tall	11776600	\$685
APCL 005 Stainless Steel Base, Closed, 12 in. Tall	11318800	\$670
APCL 011 Stainless Steel Base, Closed 19 in. Tall	11318830	\$840

Little Giant Dryer - Performance Plus



MODEL	MATERIAL	UMRP/RETAIL
PDR 908 HP Lotus White	11204480	\$3,975 / \$4,175
PDR 908 HP Stainless Steel	11204490	\$4,295 / \$4,495

SPECIFICATIONS

Width	23 ^{7/16} in (596 mm)
Height	33 ^{7/16} in (850 mm)
Depth	30 ^{9/16} in (777 mm)
Shipping Weight	170 lbs (77 kg)
Front Material (Lotus White Model)	Porcelain Enameled White
Front Material (Stainless Steel Model)	Stainless Steel
Side Panels (both models)	Powder Coated White
Electrical Connection	2 AC 208-240V, 60 Hz, 30 A
Plug	NEMA L6-30
Capacity	4.59 cu.ft; 130 Liter

FEATURES

- M Touch Flex User Interface (No Buttons or Dials)
- Stackable or Side-by-Side Configuration
- Heat Pump Dryer Technology
- 50+ Programs; 5 Customizable Rated Energy Star Most Efficient
- FragranceDos Capable
- Dryer Featuring 4D Filtration System
- HoneyComb Drum (for Dryers) with Perforated Rear Wall
- PerfectDry System: Residual Moisture Controlled
- Axial Airflow

MATCHING WASHERS	MATERIAL
PWM 908 DP Lotus White	11204460
PWM 908 DP Stainless Steel	11204470

PROGRAMS

- Standard Programs: 17
- Sport Programs: 4
- Down Bedding
- Synthetic Bedding
- Large Items
- Hygiene Programs: 3
- Wet Care Programs: 3
- Flatwork Programs: 3
- Special Programs: 5
- Timed Drying Programs: 4

OPTIONAL ACCESSORIES	MATERIAL	UMRP
TAK 555 Dryer Basket	9614800	\$75
APCL 001 Stainless Steel Stacking Kit	11167420	\$280
APCL 084 Iron-Grey Base, Open, 6 in. Tall	11776560	\$470
APCL 085 Iron-Grey Base, Open, 12 in. Tall	11776570	\$490
APCL 087 Iron-Grey Base, Open, 19 in. Tall	11776600	\$685
APCL 005 Stainless Steel Base, Closed, 12 in. Tall	11318800	\$670
APCL 011 Stainless Steel Base, Closed 19 in. Tall	11318830	\$840

Professional Rotary Ironer



MODEL	MATERIAL	UMRP/RETAIL
HM 16-80 Lotus White	10238590	\$3,300 / \$3,690

SPECIFICATIONS

Width	38 ^{3/4} in (985 mm)
Height	37 ^{3/4} in (959 mm)
Depth	14 ^{15/16} in (380 mm)
Drum Diameter	6 ^{5/16} in (160 mm)
Working Width	32 ^{11/16} in (830 mm)
Shipping Weight	100 lbs (45 kg)
Electrical Connection	2 AC 208-240V, 50-60 Hz, 20 A
Plug	NEMA L6-20

FEATURES

- Heater Plate Material; Aluminium
- Padding; Polyester Needle-Felt Cloth
- Control System; Rotary Selector
- Minimum Ironer Speed, Can Be Set in ft/min; 2
- Feed-In Board
- Minimum Ironer Speed, Can Be Set in ft/min; 4.5
- Steam Function
- Fold-Away Function
- Foot Switch
- Airing Bar

Accessories & Consumables

Laundry

W1 TWINDOS CARTRIDGES	MATERIAL	UMRP/
TwinDos Cartridge UltraPhase 1	10803670	\$22.99
TwinDos Cartridge UltraPhase 2	10803750	\$22.99
TwinDos Cartridge UltraPhase 1 Refresh Elixir	11614970	\$23.99
TwinDos Cartridge UltraPhase 2 Refresh Elixir	11615060	\$23.99
TwinDosCare	11171450	\$16.99

W1 CAPDOS CAPSULES	MATERIAL	UMRP
Sport - Box of 6	10756450	\$10.49
Booster - Box of 6	10755980	\$10.49
Outdoor - Box of 6	10757030	\$10.49
Aqua - Box of 9	10755290	\$9.49
WoolCare - Box of 9	10755570	\$10.49
ImpraProtect - Box of 3	10757720	\$20.99
DownCare - Box of 6	10756370	\$10.49
SilkCare - Box of 6	10756190	\$10.49
Nature - Box of 9	10755460	\$9.49
Cocoon - Box of 9	10755520	\$9.49
UltraDark - Box of 9	10755680	\$10.49
CottonRepair - Box of 3	10757450	\$20.99

T1 FLACON	MATERIAL	UMRP
Nature Flacon Capsule (Box of 1)	10813410	\$9.49
Aqua Flacon Capsule (Box of 1)	10813390	\$9.49
Cocoon Flacon Capsule (Box of 1)	10813430	\$9.49
DryFresh Flacon Capsule (Box of 1)	11520920	\$9.49
Set 3x Aqua Flacon Capsules	11614550	\$45.99
Set 3x Cocoon Flacon Capsules	11614700	\$45.99
Set 3x DryFresh Flacon Capsules	11614780	\$45.99
Set 3x Nature Flacon Capsules	11614600	\$45.99

Accessories & Consumables

Dishwashers

PRODUCT	MATERIAL	UMRP
UltraTabs All in 1 (3-Pack, 60 Tabs)	11295860	\$32.99
PowerDisk (6-pack)	11841390	\$79.99
PowerDisk (Single Pack)	11346690	\$14.99
Dishwasher Salt	10248600	\$12.99
Dishwasher Rinse Aid	10198910	\$12.99
DishClean Dishwasher Conditioner	9959340	\$15.99
Dishwasher Freshener	10118510	\$9.99

Professional for the Home Dishwashers

PRODUCT	MATERIAL	UMRP
ProCare Shine 12 GC Dishwasher Tabs - 80 tabs	11712580	\$45
ProCare Shine 10 MA Liquid Detergent - 5 L	10923610	\$45
ProCare Shine 40 Rinse Aid - 1 L	10923710	\$25
ProCare Universal Dishwasher Salt	9195780	\$55
CK/1 DIN 51 Canister Key	11851600	\$20

Miele

Miele, Inc.
9 Independence Way
Princeton, NJ 08540

mieleusa.com
800.843.7231

Visit one of Miele's Experience Centers:

Beverly Hills
Boca Raton
Chicago
Coral Gables
Manhattan
Princeton
San Francisco
Scottsdale
Seattle
Tysons Corner

Prices effective April 2022.

Prices subject to change without notice.

Miele reserves the right to accept or deny all orders at its Princeton, NJ offices.

Alteration rights reserved / April 2022 / MAT 94003860