

ARC

AKW Resource Center



Let's build together

Since being founded in 2009, we have been driven by our mission to help people live better, fuller lives by removing common obstacles that impede our everyday activities.

Our diverse range of bathroom and daily living products have been intelligently designed to make your home safer, more comfortable, stylish, and easier to use for everyone - and with over 20 years' experience in the industry, we can confidently say we know what we're doing.

We have a team of market experts at hand who know exactly how to create the bathroom you and your family deserve. We are here to help, so let's build together.

The ARC Team

Contents

01

About Us

- 04 Why choose ARC?
- 06 Our specialty
- 07 How we can help

03

Shower Screens & Accessories

- 41 Glass Shower Screens
- 45 Curtains & Rails
- 47 Caregiver Doors

05

Shower Seats

- 65 Velena Series Seats
- 67 2000 Series Seats
- 69 4000 Series Seats

02

Shower Systems

- 11 TrueDEK Classic Shower Bases
- 15 TrueDEK Classic8 Shower Bases
- 18 TrueDEK Classic Drains
- 21 TrueDEK Linear Shower Bases
- 24 TrueDEK Linear Drains
- 27 TruePITCH Extension
- 29 FastDEK Shower Bases
- 33 FastDEK Linear Shower Bases
- 35 Waterproofing & Installation Supplies

04

Walls & Decor

- 53 Origins Wall Panels
- 58 FastNICHE Shower Niches
- 61 TrueBOARD Tileable Wall Kit

06

Grab Bars

- 75 Comfort Grip
- 77 Specialty Grip
- 79 Fold-up Supports

Why choose ARC?

For over ten years, ARC has proudly been a master importer of daily living products from European-based specialists, AKW, the manufacturers behind our TrueDEK and FastDEK shower bases.



HIGH LEVELS OF STOCK AVAILABLE FROM OUR WAREHOUSE IN NEILLSVILLE, WI



OUR DEDICATED SALES TEAM ARE HERE TO HELP TRAIN YOUR TEAMS



ARC 'MADE FOR LIFE' GUARANTEE ON MANY OF OUR PRODUCTS



This strong relationship has continuously supported the expansion of our product range, which has increased exponentially over the last two decades. As well as providing level-entry curbless shower bases for a variety of needs and installations, we also offer a collection of contemporary glass screens, grab bars and shower seats, as well as long-lasting, decorative wall panels and shower niches.

At ARC, we are here to help our customers create bathrooms they need and deserve.



WE SUPPLY
DISTRIBUTORS ACROSS
THE US AND CANADA



ORDERS SHIPPED
24-48HRS AFTER
BEING PLACED



ROBUST SUPPLY
CHAIN SUPPORTED BY
WORLDWIDE PARTNERSHIPS



Our specialty

ARC bathroom solutions are intelligently designed to offer a stylish aesthetic, high level of functionality and incredible versatility. This makes our products suitable for use across both domestic and commercial environments, and for people with a wide range of different needs.



Remodels

Transforming bathrooms is our passion, every single day we help people turn their houses into truly beautiful homes that they love and can be proud of for years to come.



Accessibility

As experts on the manufacture and installation of curbless, level-entry shower bases, we know how simple changes to a bathroom can make a huge difference to the lives of our customers.



Nursing Homes

We know that as healthcare professionals you are looking for tried and tested, reliable products that offer unrivaled support and are excellent value for money, which is exactly where we come in.



Accessories

Everyone needs a helping hand at some point in their lifetime, we are here to help you find the right level of support that makes everyday tasks easier.



Hotels

Let us help you create an accessible, relaxing oasis, somewhere your guests can enjoy an invigorating start to their morning or find a moment of calm at the end of a long day.

How we can help

Visit our website

Find everything you need to complete your project and more:

- + Product details & visuals
- + Specification sheets
- + Installation instructions
- + Compliance documents
- + Brochures & guides



www.arcfirst.net

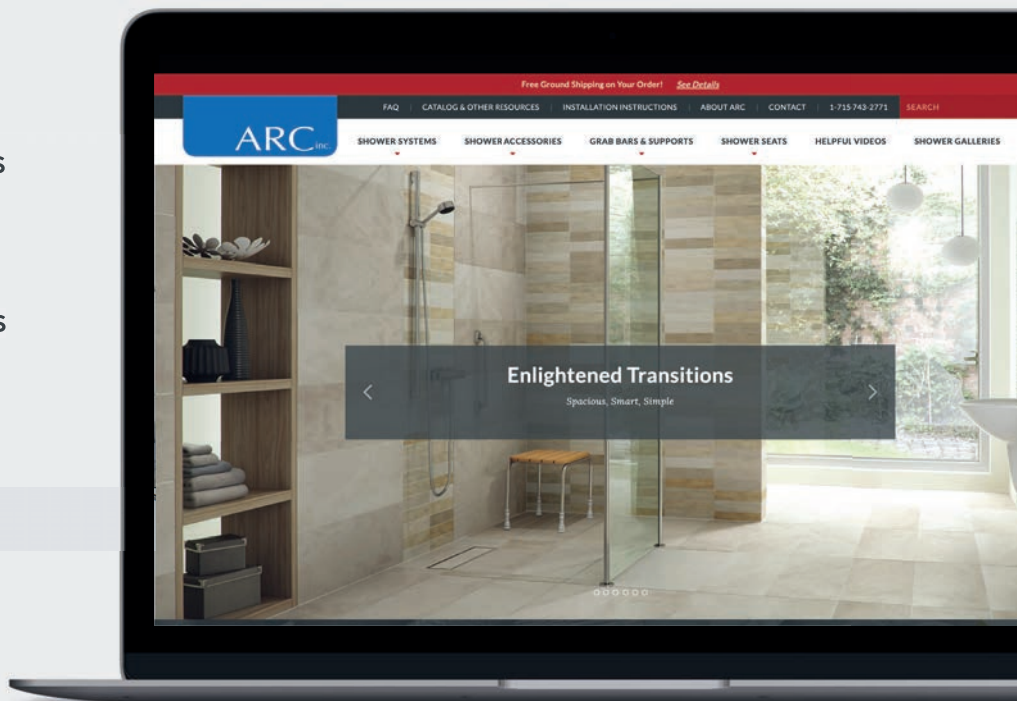

Call our team

Our experienced sales team are here to help you find the right products, answer any technical questions you may have, place your order, they can even train your teams!



715.743.2771

Follow us

You can follow ARC across social media for all our latest news, product updates and design inspiration.

Our YouTube channel is also the perfect place to find out how to install our products, with videos showing you just how easy it can be.







02

Shower Systems

- 11 TrueDEK Classic Shower Bases
- 15 TrueDEK Classic8 Shower Bases
- 18 TrueDEK Classic Drains
- 21 TrueDEK Linear Shower Bases
- 24 TrueDEK Linear Drains
- 27 TruePITCH Extension
- 29 FastDEK Shower Bases
- 33 FastDEK Linear Shower Bases
- 35 Waterproofing & Installation Supplies

Shower bases are the foundation of any bathroom and helping you choose the right product for your project is what we do best.

Our wide range of practical and stylish curbless, level-entry shower bases are made from incredibly strong yet lightweight materials, can be installed quickly and easily, are suitable for use across several different environments, and most can be covered in custom tile or weldable vinyl to create a showering area that is uniquely yours.



TrueDEK Classic Shower Bases



- + An ARC favorite with over half a million sold worldwide!
- + Structural support and level-access showering for everyone
- + Can be cut on site to any size or shape

TrueDEK Classic shower bases are pre-sloped with a 1% per foot or greater gradient (varies due to length of pitch) and constructed using lightweight, compression mold fiberglass reinforced plastic (GRP).

With a ribbed underside that provides strength while reducing weight, TrueDEK Classic bases can support a maximum capacity of 840lb when installed on joists, ideal for wheelchair users or those requiring assistance when showering.

Installation is easy – it can be completed in just a few hours in most cases – with pre-bored, countersunk pilot holes and no need to cut into joists, meaning you can prepare the showering area for custom tile or weldable vinyl in just one day.

Designed for superior durability, TrueDEK Classic bases come with a lifetime guarantee that ensures you can remove flooring when you want to refresh your bathroom, redo any waterproofing, and re-tile without damaging the foundation.

Showers built on TrueDEK bases offer the timeless advantages of level-entry access, which makes it easier to clean, safer to use, and suitable for the whole family.

For over 30 years, people have been enjoying TrueDEK systems across the US, Canada, and Europe, so why not ask a member of our team why it is such a favorite with customers worldwide.

Complete your new shower with a stylish drain (see page 18) and browse our waterproofing supplies (see page 35) to make installation even easier.

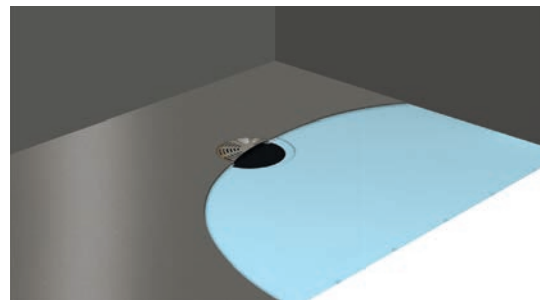
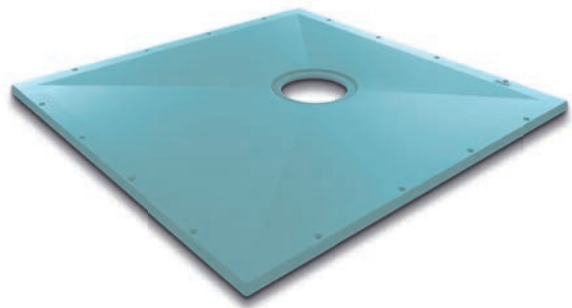

TrueDEK Classic with weldable vinyl

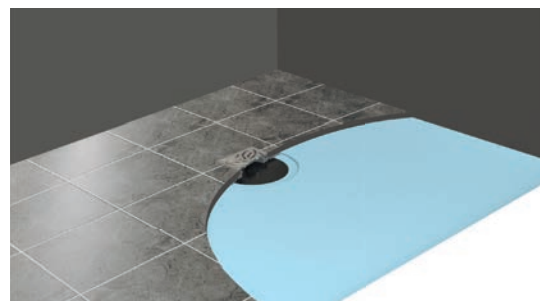

TrueDEK Classic with custom tile

Size options and product codes

TrueDEK Classic bases are available in ten sizes that cater to a number of different shower installations.

TrueDEK Classic - 35 1/2" x 35 1/2" **\$675.00**

21000

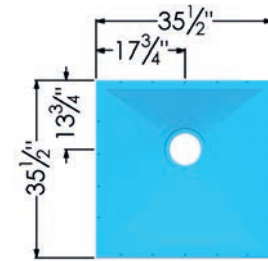

TrueDEK Classic - 39 3/8" x 39 3/8" **\$675.00**

21008

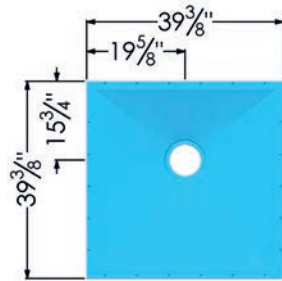

TrueDEK Classic - 44 3/4" x 30 1/4" **\$675.00**

21012

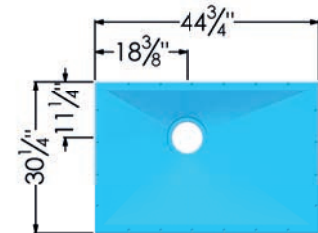

TrueDEK Classic - 47 1/4" x 47 1/4" **\$675.00**

21018

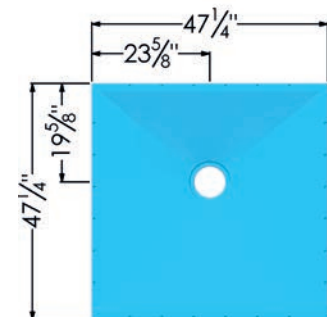

TrueDEK Classic - 51 1/4" x 32 1/4" **\$675.00**

21027

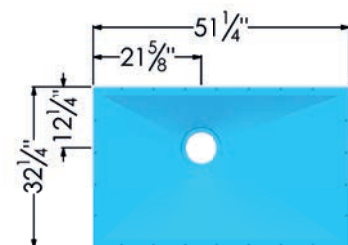

TrueDEK Classic - 55 1/8" x 35 1/2"

\$675.00

21028

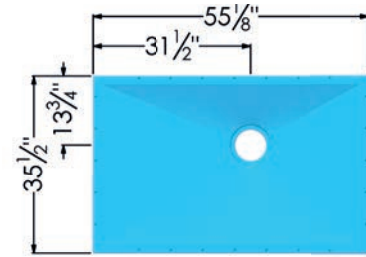

TrueDEK Classic - 59" x 32 1/4"

\$675.00

21036

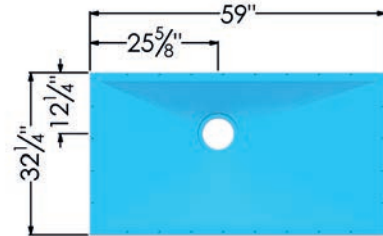

TrueDEK Classic - 60" x 36"

\$675.00

21035

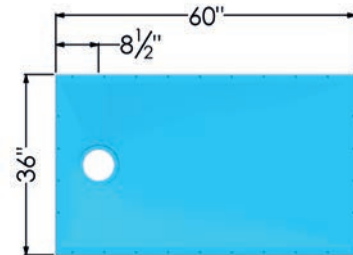

TrueDEK Classic - 59" x 47 1/4"

\$725.00

21045

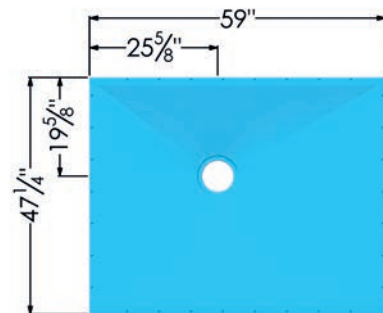

TrueDEK Classic - 70 7/8" x 32 1/4"

\$725.00

21050

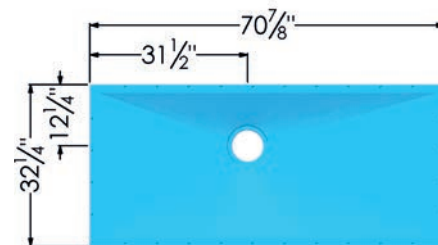



TrueDEK Classic8 Shower Bases



- + Up to 15 different drain positions for quick installation
- + Safe and accessible level-entry showering
- + Create a unique space by covering with tile or weldable vinyl

The TrueDEK Classic8 line of pre-formed, sloped shower bases are a fast and safe way to create a level-entry showering area. The 1% per foot or greater gradient (varies due to length of pitch) provides a continual fall all the way to the drain which helps to eliminate water pooling.

What makes TrueDEK Classic8 stand out from the rest is its innovative rotating drain plate, which enables you to easily change the drain position to avoid any joists or obstructions beneath the floor.

As depicted opposite, each 45° turn of the waste plate moves the center of the waste and helps you to achieve up to 15 different positions, so you can get the best drain position for your installation.

With a maximum capacity of 840lbs when supported by wooden joists, TrueDEK Classic8 is suitable for use by wheelchair users and those who require assistance when showering.

Manufactured from fiberglass reinforced plastic (GRP), all TrueDEK Classic8 models share the same durable strength, structural properties and installation characteristics as our TrueDEK Classic shower bases, which is why they are one of our most popular products.

To finish off your shower, select from our range of drains (**see page 18**) and browse our waterproofing products (**see page 35**). You can then choose to cover the base in decorative tile or weldable vinyl to create a showering area that reflects who you are.

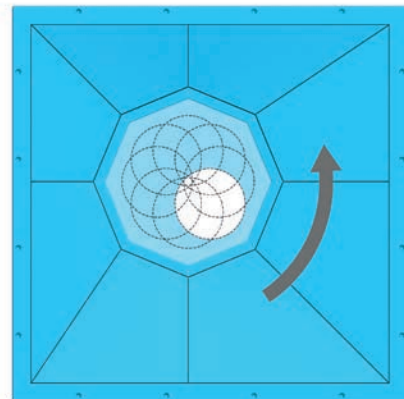
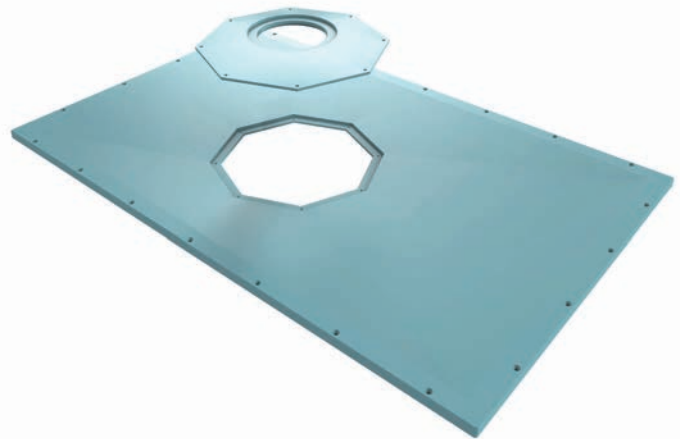

Size options and product codes

TrueDEK Classic8 is currently available in nine sizes to suit a wide variety of shower installations.

TrueDEK Classic8 - 35 1/2" x 35 1/2" \$800.00

21130

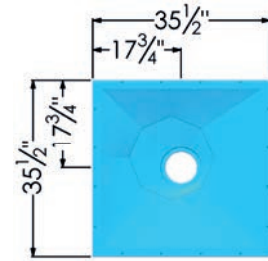

TrueDEK Classic8 - 39 3/8" x 39 3/8" \$800.00

21131

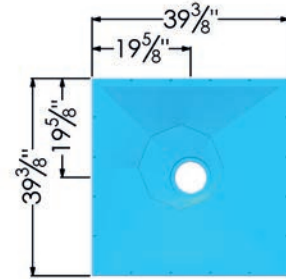

TrueDEK Classic8 - 44 3/4" x 30 1/4" \$800.00

21132

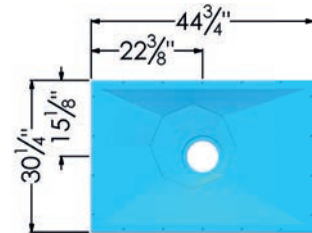

TrueDEK Classic8 - 47 1/4" x 47 1/4" \$800.00

21133

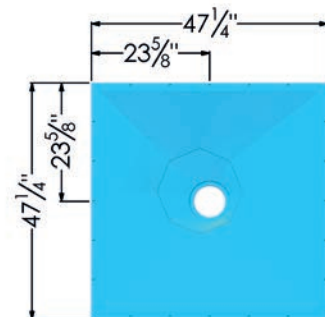

TrueDEK Classic8 - 51 1/4" x 32 1/4" \$850.00

21134

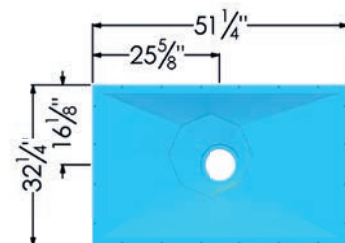

TrueDEK Classic8 - 55 1/8" x 35 1/2"

\$800.00

21135

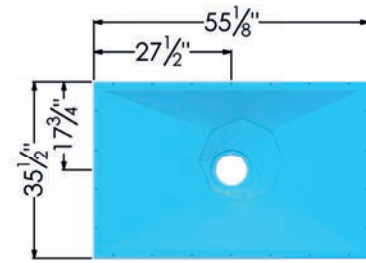

TrueDEK Classic8 - 59" x 32 1/4"

\$800.00

21136

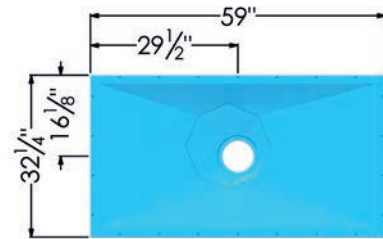

TrueDEK Classic8 - 59" x 47 1/4"

\$850.00

21137

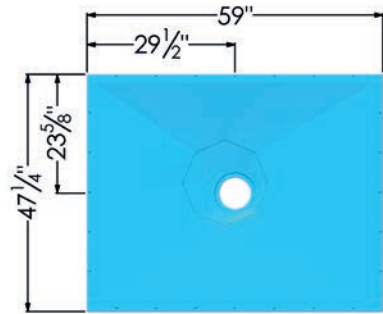

TrueDEK Classic8 - 70 7/8" x 32 1/4"

\$850.00

21138

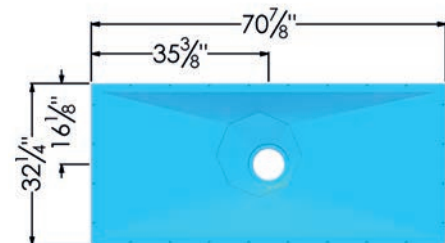

TrueDEK Classic Drains



- + Styles for tile and vinyl showers
- + Made from durable materials
- + Range of grate designs to choose from

Finish your TrueDEK Classic or TrueDEK Classic8 shower base with our range of drains, available in several colors and stylish patterns, for tile and commercial-grade weldable vinyl.

All drain assemblies include a PVC drain connector for connecting to the drain line. Drains suitable for tile also include a gasket which is needed for waterproofing the shower area.

Each drain has been constructed to last; all metal parts are made of 304 stainless steel for rust resistance, with black and oil rubbed drains featuring a color coating for additional durability. The grate for our plastic drain – ideal for use with weldable vinyl – is made of strong, white ABS plastic.

Classic drains are compliant with plumbing codes and come with a minimum 10-year guarantee for peace of mind and years of regular use.



CD1250-VL **\$50.00**

Grate constructed from strong ABS plastic
White finish

Drains for vinyl showers

- + Includes grate, frame, height adjustment collar, lock key, clamping ring, adaptor, drain connector and drain gasket
- + Made from ABS plastic with PVC drain connector
- + For use with commercial-grade weldable vinyl
- + 6 gallons per minute max. flow rate (consult plumber to calculate needs for high flow shower)
- + Solvent weld drain connector to 2" diameter drain line



CDI250-BS **\$150.00**

Pinhole pattern
Brushed steel finish



CDI210-BS **\$150.00**

Swirl pattern
Brushed steel finish



CDI280-CH **\$200.00**

Pinhole pattern
Polished stainless steel finish



CDI290-CH **\$200.00**

Swirl pattern
Polished stainless steel finish



CDI240-ORB **\$250.00**

Pinhole pattern
Oil rubbed bronze finish



CDI230-ORB **\$250.00**

Swirl pattern
Oil rubbed bronze finish



CDI222-ORB **\$250.00**

Grid pattern
Oil rubbed bronze finish



CDI233-BK **\$250.00**

Pinhole pattern
Matte black finish



CDI213-BK **\$250.00**

Swirl pattern
Matte black finish

Drains for tiled showers

- + Includes grate, frame, height adjustment collar, lock key, clamping ring, adaptor, drain connector and drain gasket
- + Grate and frame made from stainless steel
- + Assembly parts made from ABS plastic
- + Connector made of PVC plastic
- + Height adjustment allows for matching grate elevation to match tile surface (from 1/4" to 1")
- + 6 gallons per minute max. flow rate (consult plumber to calculate needs for high flow shower)
- + Solvent weld drain connector to 2" diameter drain line



TrueDEK Linear Shower Bases



- + Contemporary, effective drainage
- + Suitable for use in tiled showers
- + Flexibility to cope with high flow volumes

Our range of TrueDEK Linear shower bases feature a fully integrated drain gully that is molded directly into a structural, pre-pitched base with a maximum capacity of 560lbs.

The drain gully offers up to three drain connector locations to ease installation – simply choose the location best for your project or install multiple drains to process higher flow volumes of up to 17 gallons per minute.

As a structural shower foundation, a TrueDEK Linear base may be installed directly onto joists to create a curbless shower that is flush with the rest of the bathroom floor.

Precisely pre-sloped, each base ensures swift and accurate drainage without putting any demands on the installer; all you have to do is make sure the base is level.

TrueDEK Linear bases are thin yet strong, meaning that expensive joist modifications are unnecessary. Plus, with a lifetime guarantee, remodelling your shower in the future is simple, you can remove the existing tile, repair the waterproofing (**see page 35**), and lay new tile in its place without affecting the structural integrity of the base.

Pair your TrueDEK Linear base with a stylish drain cover (**see page 24**) and then cover with your choice of custom tile for a truly unique bathroom.

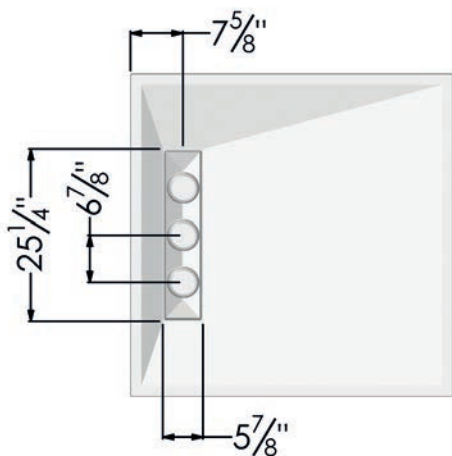

Size options and product codes

TrueDEK Linear bases are available in four different sizes for a range of installations. Please note, these shower bases cannot be cut or trimmed, please see our TrueDEK Linear Tub Replacement Shower Base on **page 23** should you require a linear base that can be cut on site.

TrueDEK Linear - 35 1/2" x 35 1/2"

\$725.00

21205

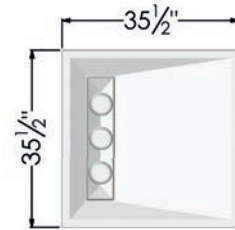

TrueDEK Linear - 39 3/8" x 39 3/8"

\$725.00

21206

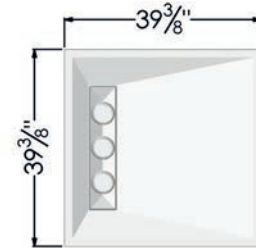

TrueDEK Linear - 51 1/4" x 32 1/4"

\$725.00

21207

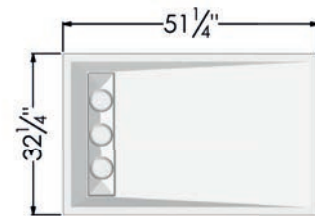

TrueDEK Linear - 47 1/4" x 47 1/4"

\$725.00

21208

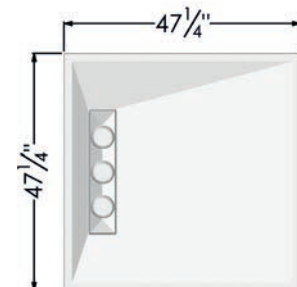

TrueDEK Linear Tub Replacement Shower Base

+ Can be cut to size on site!

With all the fantastic qualities of our TrueDEK Linear bases but with even greater flexibility when installing, we highly recommend the TrueDEK Linear Tub Replacement Base.

Composed from the same structural, lightweight materials as our TrueDEK Classic and TrueDEK Classic8 bases – fiberglass reinforced plastic (GRP) – this incredibly durable shower base can be trimmed to size on site, if required.

Choose from two stylish drain cover options to complete your shower ([see page 24](#)).

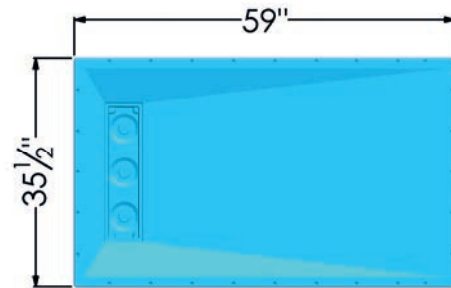

TrueDEK Linear Tub Replacement Base - 59" x 35 1/2" **\$725.00**

21210



TrueDEK Linear Drains

+ Stylish, reversible stainless-steel drain covers for a choice of contemporary looks

TrueDEK Linear drain covers are made to complete our range of TrueDEK Linear shower bases and can be installed with a brushed stainless-steel finish or flipped over and tiled to match the rest of the shower.

Both the solid and slotted drain covers, as well as the tile spacer and adaptor, are constructed of heavy gauge stainless steel. As for adjustability, hardware is included to match the cover to tile from 1/4" to 5/8" thick.

All TrueDEK Linear drain assemblies come with one PVC drain line connector. For higher flow showers, order additional drain line connectors as a la carte items.



TrueDEK Linear Drain Covers

Product Name	Product Code	Price
Solid Cover	21213	\$725.00
Slotted Cover	21215	\$725.00

TrueDEK Linear Tub Replacement Drain Covers

Product Name	Product Code	Price
Solid Cover	21211	\$725.00
Slotted Cover	21228	\$725.00

A La Carte Items

Product Name	Product Code	Price
PVC Drain Connector	DC5500-PVC	\$15.00



Reversible Stainless
Steel Cover (Tiled side)



Reversible Stainless
Steel Cover (Stainless Steel side)



TruePITCH Extension



- + The easy way to enlarge your TrueDEK shower base
- + Compatible with TrueDEK Classic, TrueDEK Classic8 & TrueDEK Linear shower bases

Expand any of our TrueDEK shower bases by an additional 12" with sloped TruePITCH Extension panels.

Measuring 12" x 48" with a 1/4" per foot slope, our extension panels are an ideal substitution for tile backer boards or uncoupling membrane alongside our shower bases.

If you are wrapping a corner of a shower base, we recommend keeping the pitch extensions the same width so that mitered corners are symmetrical and give you the best-looking results.

Install pitch extensions on top of the subfloor using ceramic coated cement board screws and Tank/10 polyurethane adhesive (**see page 37**), or on concrete, use concrete-style, ceramic coated screws and modified thin-set mortar.

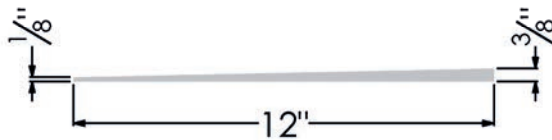
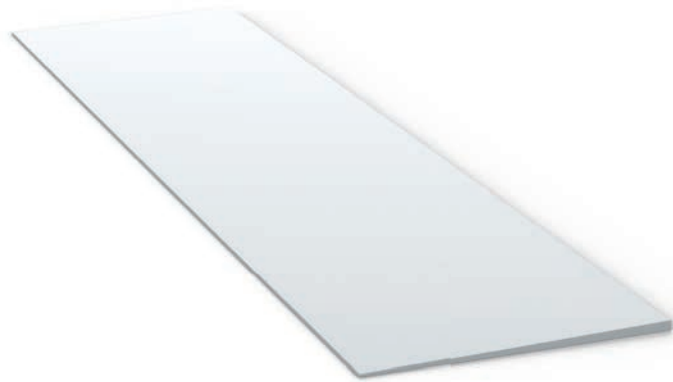

TruePITCH Extension - 12" x 48"

\$85.00

TB4812-PXT



FastDEK Shower Bases



- + Available in three bold, monochromatic colors
- + Slate-effect finish helps with drainage and slip resistance
- + Incredibly lightweight (less than 55lbs) but exceptionally strong

Constructed using durable sheet-molded fiberglass (SMC), the underside of our FastDEK shower bases feature a grid design to achieve greater strength – enabling it to support a maximum capacity of 440lbs – while also being lightweight, which makes installation quick and easy.

Each FastDEK base features a contemporary, textured surface that is designed to replicate natural slate for enhanced aesthetic, to improve drainage and to aid with slip-resistance. FastDEK shower bases are available in cool white, subtle gray or bold black for a simple yet modern finish.

FastDEK bases are only an inch deep meaning they can sit on top of or be built into the floor for low or level access. They can also be cut to fit on site, giving you additional flexibility when installing.

Fit quickly and easily using our FastDEK installation kit (**see page 36**). Each kit comes with a PVC drain connector for a leakproof connection with the drain line; the connector will be concealed beneath the decorative drain cover.



Size options and product codes

FastDEK shower bases are available in six sizes and in a choice of three monochromatic styles – white, black or gray.

FastDEK Shower Base - 47 1/4" x 31 1/2"

\$575.00

White: 11853
 Black: 11854
 Gray: 11876

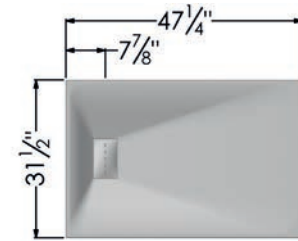

FastDEK Shower Base - 47 1/4" x 35 1/2"

\$575.00

White: 11855
 Black: 11856
 Gray: 11877

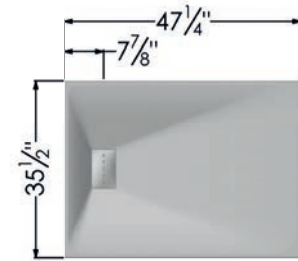

FastDEK Shower Base - 63" x 31 1/2"

\$625.00

White: 11857
 Black: 11858
 Gray: 11880

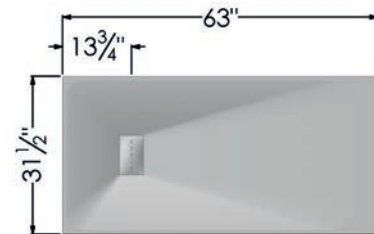

FastDEK Shower Base - 63" x 35 1/2"

\$625.00

White: 11859
 Black: 11860
 Gray: 11881

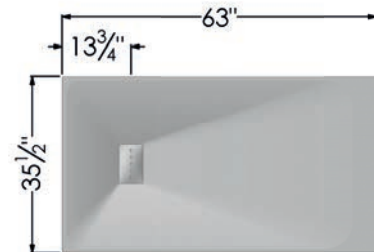

FastDEK Shower Base - 71" x 31 1/2"

\$675.00

- White: 11865
- Black: 11866
- Gray: 11884

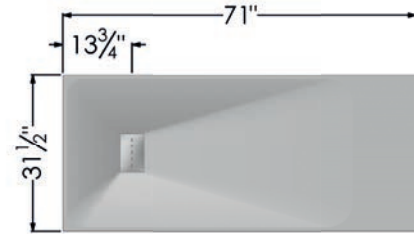

FastDEK Shower Base - 71" x 35 1/2"

\$675.00

- White: 11867
- Black: 11868
- Gray: 11885

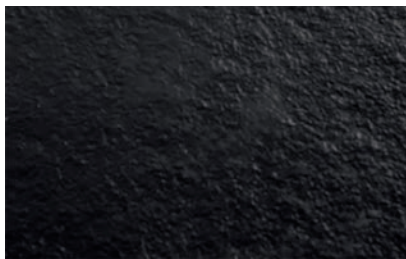
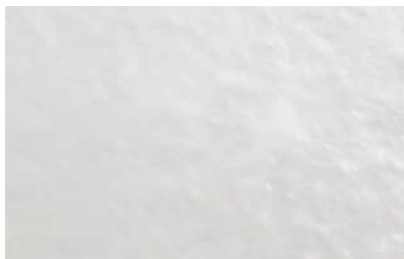
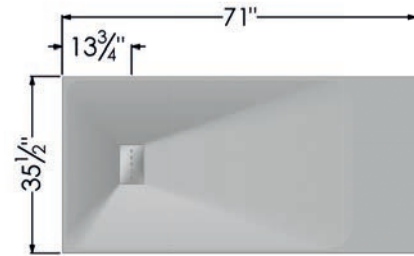



FastDEK Linear Shower Bases



- + Stylish, linear drain cover
- + Superior strength with 546lb maximum capacity
- + Stone-effect, slip-resistant finish

With its chic art deco inspired linear drain cover (included), our FastDEK Linear shower bases offer superior strength with a maximum capacity of 546lbs, and contemporary styling with a truly luxurious stone-effect, slip-resistant finish.

At just over an inch deep, FastDEK Linear bases can be installed above the floor or they can be recessed into it to enable level-access showering and is currently available in three sizes.

FastDEK Linear - 47 1/4" x 35 1/2"

\$625.00

23964-WH

Spare Stainless Steel Drain Cover 21 3/4" - 23957-WH

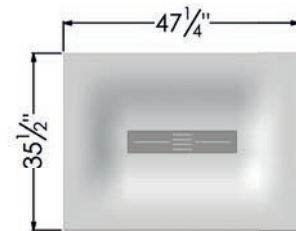

FastDEK Linear - 59" x 35 1/2"

\$675.00

23977-WH

Spare Stainless Steel Drain Cover 25 1/3" - 23958-WH

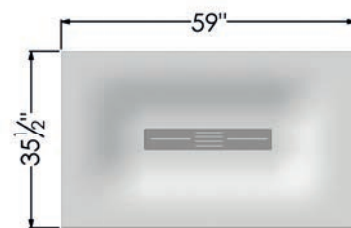

FastDEK Linear - 71" x 35 1/2"

\$725.00

23975-WH

Spare Stainless Steel Drain Cover 29 1/2" - 23959-WH

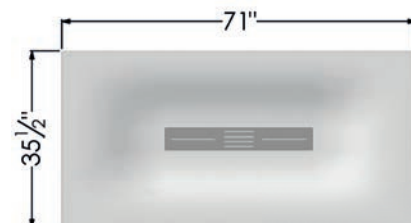



Waterproofing & Installation Supplies

To help you install and waterproof your shower area, we have a number of reliable products and useful kits available to make the job even easier, with Tank/10 adhesive, paintable caulk, reinforcement tape, pre-formed corners and more.

You can purchase your waterproofing supplies separately or invest in one of our handy kits; our Pro Kit has enough materials to waterproof any ARC shower base, while the Premium Kit includes enough supplies to cover a base plus the walls of an alcove shower.

Waterproofing Kits



Premium Kit

\$475.00

WP1000-PRE

Kit includes:

- + Tank/10 waterproofing compound (2 gallons – covers approx. 120 sq. ft. with two coats)
- + Joint reinforcement tape (3 x 25 ft. rolls)
- + Internal corners x 4
- + External corners x 2
- + Supply gasket x 1
- + Mixer valve gasket x 1
- + #9 x 2½" premium Torx screws x 32
- + Torx bit driver x 1
- + Tank/10 polyurethane construction adhesive (6 x 10 oz. tubes)
- + 100% silicone caulk (1 x 10 oz. tube)
- + Nitrile gloves x 2 pairs
- + Paint roller handle x 1
- + Paint roller covers x 2
- + Paint brush x 1



Pro Kit

\$240.00

WP1090-PRO

Kit includes:

- + Tank/10 waterproofing compound (1/2 gallon – covers approx. 30 sq. ft. with two coats)
- + Joint reinforcement tape (1 x 25 ft. roll)
- + Internal corners x 2
- + External corners x 2
- + #9 x 2½" premium Torx screws x 32
- + Torx bit driver x 1
- + Tank/10 polyurethane construction adhesive (6 x 10 oz. tubes)
- + 100% silicone caulk (1 x 10 oz. tube)
- + Nitrile gloves x 2 pairs
- + Paint roller handle x 1
- + Paint roller covers x 2
- + Paint brush x 1

Installation Kits

A convenient kit to assist when installing our range of FastDEK shower bases. Use Tank/10 adhesive to bond shower base to joists or wooden subfloor; modified thin set mortar may be used to bond shower base to concrete or to subfloor. Use the silicone caulk as the final joint seal after the shower base and all decorative flooring and wall materials are installed.

FastDEK Installation Kit

\$100.00

FB1000-1K

Kit includes:

- + Tank/10 polyurethane construction adhesive (6 x 10 oz. tubes)
- + 100% silicone caulk (2 x 10 oz. tubes)
- + 20' Joint reinforcement tape with adhesive strip along one edge
- + Drain connector x 1



A La Carte Items

We recommend using Tank/10 products when installing and waterproofing your shower, these items are easy to apply, ensure long-lasting protection and allow you to bond a range of materials, including plastic shower bases and wooden joists.

Use these key tools along with our reinforcement tape, pre-formed corners and screws, to get the job done right. Please note, you may need additional materials if you are going to add a built-in bench or other features in your shower area.

Product Name	Product Code	Price
Tank/10 Waterproofing (1/2 gallon)	WP2000-TNK	\$75.00
Tank/10 Waterproofing (1 gallon)	WP2001-TNK	\$120.00
Tank/10 Waterproofing (2 gallons)	WP2002-TNK	\$185.00
Tank/10 Waterproofing (5 gallons)	WP2005-TNK	\$430.00
Tank/10 Polyurethane Construction Adhesive x 1 tube (10 oz. tubes)	WP2101-TNK	\$10.00
Tank/10 Polyurethane Construction Adhesive x 12 tubes (10 oz. tubes)	WP2112-TNK	\$100.00
Painter's Acrylic Latex Caulk x 6 tubes (10 oz. tubes)	WP4010-PAC	\$35.00
Internal Corner x 1	WP3101-INT	\$10.00
Internal Corner x 12	WP3112-INT	\$100.00
External Corner x 1	WP3201-EXT	\$10.00
External Corner x 12	WP3212-EXT	\$100.00
PVC Drain Connector	DC5500-PVC	\$15.00
Supply Gasket	WP3301-SUP	\$12.00
Supply Gasket x 12	WP3312-SUP	\$120.00
Drain Gasket	WP3401-DRN	\$25.00
Mixer Valve Gasket	WP5000-MXV	\$20.00
Joint Reinforcement Tape (25 ft.)	WP3425-JRT	\$55.00
Joint Reinforcement Tape (50 ft.)	WP3450-JRT	\$100.00





03

Shower Screens & Accessories

- 41 Glass Shower Screens
- 45 Curtains & Rails
- 47 Caregiver Doors

Choose from a range of modern, durable and highly practical solutions to transform your showering area into the haven you deserve.

Our collection of contemporary, wall-mounted glass screens are the ideal way to make a style statement, create the illusion of greater space in your bathroom, and aid with water retention.

For those who require a helping hand, we offer a caregiver door to support assisted showering and breathable curtains that have been designed to make the bathroom a safer, more accessible place for everyone.



Glass Shower Screens



- + Compatible with all our shower bases
- + Choice of polished chrome or matte black finish
- + Strong toughened glass for increased safety

Finish off your shower with our stylish glass shower screens which are available with or without a deflector panel to further help with water retention.

The toughened glass is designed for extra safety and is easy to clean, with end posts available in a choice of polished chrome or matte black.

Our wall-mounted screens are simple to install and heighten the aesthetic of any space for a modern, contemporary appearance.

All wall-mounted screens include an end post, wall channel, leveling hardware, and one wall brace.



Wall-mounted screen with polished chrome finish



Wall-mounted screen and deflector panel with matte black finish

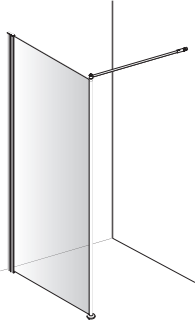

Screens

Configuration	Product Code	Width	Height	Finish	Price	
	Wall-mounted	LB00105	27 1/2"	76 3/4"	Chrome	\$550.00
	Wall-mounted	LB00106	31 1/2"	76 3/4"	Chrome	\$575.00
	Wall-mounted	LB00107	35 1/2"	76 3/4"	Chrome	\$640.00
	Wall-mounted	LB00108	39 3/8"	76 3/4"	Chrome	\$670.00
	Wall-mounted	LB00216BK	31 1/2"	76 3/4"	Black	\$575.00
	Wall-mounted	LB00217BK	35 1/2"	76 3/4"	Black	\$640.00
	Wall-mounted	LB00218BK	39 1/2"	76 3/4"	Black	\$670.00

Screens & Deflector Panels

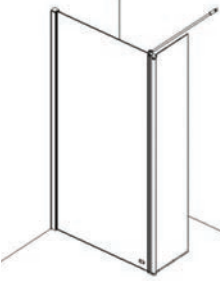
Configuration	Product Code	Panel Width	Screen Width	Height	Finish	Price
	27019	13 3/4"	23 2/3"	74 3/4"	Chrome	\$826.00
	27020	13 3/4"	27 1/2"	74 3/4"	Chrome	\$874.00
	27021	13 3/4"	31 1/2"	74 3/4"	Chrome	\$922.00
	27022	13 3/4"	35 1/2"	74 3/4"	Chrome	\$970.00
	27028	13 3/4"	39 1/3"	74 3/4"	Chrome	\$1018.00
	27018BK	15 3/4"	31 1/2"	74 3/4"	Black	\$922.00
	27031BK	15 3/4"	35 1/2"	74 3/4"	Black	\$970.00
	27017BK	15 3/4"	39 1/3"	74 3/4"	Black	\$1018.00

Tie Bars

Product Code	Length	Finish	Price
LB00123	27 1/2"	Chrome	\$80.00
LB00124	31 1/2"	Chrome	\$110.00
LB00125	35 1/2"	Chrome	\$125.00



Curtains & Rails

Breathable Shower Curtain

+ Quick drying breathable fabric

Available in three lengths, our shower curtains hang straight and “heavy” when wet, so they do not billow out during showering while quickly shedding water and drying fast. Breathable shower curtains allow air to pass through tiny pores of the fabric which increases safety if someone should trip or fall and become entangled in a curtain.

When hung from our hook and glide connectors on a bendy curtain rail track, opening and closing these curtains is quick and easy, as they are designed to be used by people of all abilities.

Product Name	Size (W x H)	Product Code	Price
Breathable Shower Curtain	70 ¾" x 74 ¾"	24077	\$55.00
Breathable Shower Curtain	70 ¾" x 78 ¾"	24078	\$60.00
Breathable Shower Curtain	70 ¾" x 82 ½"	24079	\$60.00

Bendy Curtain Rail

+ Shaped by hand and cut to any length!

Bendy curtain rails come in three different lengths, although these can be cut on site to suit your installation. They can be shaped to fit any curve; customize your curtain rail to match any tile design on the floor or bend it into a long arch to increase shoulder room in the shower.

The plastic is flexible enough to be easily bent by hand. Every rail comes with a pair of wall brackets and a drop rod which can also be cut to length. One pack of eleven hook and glide connectors is included with every bendy curtain rail to allow it to easily move along the track.

Product Name	Size (W x H)	Product Code	Price
Bendy Rail	78"	24033	\$95.00
Bendy Rail	98"	24034	\$110.00
Bendy Rail	118"	24044	\$125.00
Hook and Glide Connectors (11 pack)		24092	\$10.00



Caregiver Doors



- + Double bi-fold doors for greater access
- + Suitable for use with all our shower bases
- + Shatterproof plastic panels for safety

Our caregiver doors are an ideal solution for those who require assistance when showering, with double bi-folding doors that open and fold to allow maximum space – particularly useful for wheelchair users.

With shatterproof plastic panels and easy-grip latch handles, our caregiver doors come complete with an L-shaped curtain rail and all hardware required to install, as well as two 71" x 71" breathable

curtains (**see page 45**), and two packs of hooks & glide connectors.

To find out which size is best for your space, go to **page 48** for a full breakdown of measurements, including the maximum and minimum spatial requirements.

Need to extend the screen to fit a slightly larger space? Try our extra-wide compensator for 4 1/8" extra width, details below.

Additional Extras

Replacement Door Handle **\$40.00**

24106-WH



Replacement Door Latch **\$40.00**

24105-WH



Extra-wide Compensator **\$80.00**

24130



Size options and product codes

Available in five lengths, our caregiver doors feature double bi-folding doors and compensator profiles to enable installation. Compensators are set at mid-point giving approximately 2/5" in and out adjustment on both sides.

The table below details the sizes available and includes the minimum and maximum length of each screen. If further adjustment is required, an Extra Wide Compensator ([see page 47](#)) can be ordered to provide 4 1/8" additional length.

Product Name	Code	Price	Door 1	Door 2	Door 3	Door 4	Area Height 5	Screen Length 6	Screen Height 7	
Alcove Caregiver Doors (29 1/2" x 47 1/4")	91110	\$1200.00	11 1/2"	10 1/8"	10 1/2"	11 1/2"	74"	47 1/4"	29 1/2"	
			Minimum Length			Maximum Length				
			46 1/4"			47 3/4"				
Alcove Caregiver Doors (29 1/2" x 51 1/4")	91111	\$1200.00	12 1/2"	11 1/8"	11 1/8"	12 1/2"	74"	54 1/4"	29 1/2"	
			Minimum Length			Maximum Length				
			50 1/4"			51 3/4"				
Alcove Caregiver Doors (29 1/2" x 55 7/8")	91113	\$1200.00	13 2/3"	12 1/3"	12 1/3"	13 2/3"	74"	55 7/8"	29 1/2"	
			Minimum Length			Maximum Length				
			54 3/4"			56 1/4"				
Alcove Caregiver Doors (29 1/2" x 59")	91114	\$1200.00	14 1/2"	13 3/4"	13 3/4"	14 1/2"	74"	59"	29 1/2"	
			Minimum Length			Maximum Length				
			58 1/4"			59 3/4"				
Alcove Caregiver Doors* (29 1/2" x 60")	91115	\$1200.00	14 2/3"	13 1/4"	13 1/4"	14 2/3"	74"	60"	29 1/2"	
			Minimum Length			Maximum Length				
			56 3/4"			58 1/4"				

*Cannot accommodate an extra wide compensator

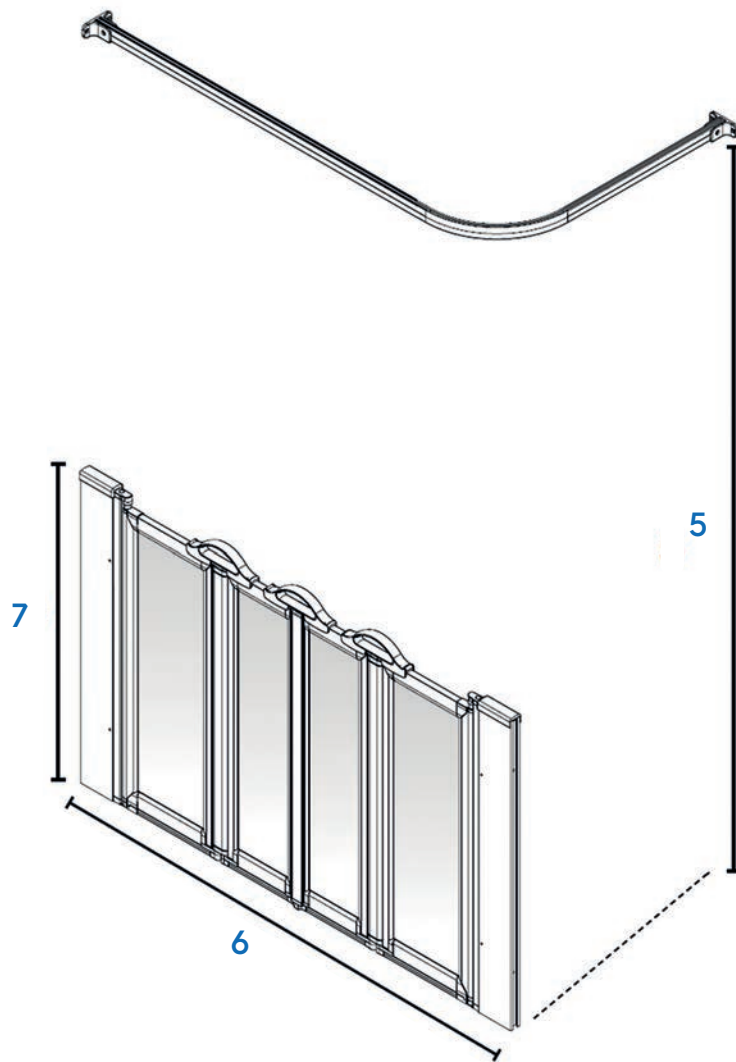

Non-handed

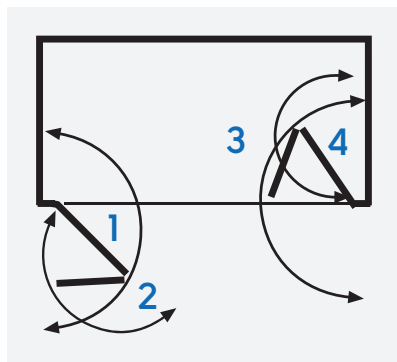





04

Walls & Decor

- 53 Origins Wall Panels
- 58 FastNICHE Shower Niches
- 61 TrueBOARD Tileable Wall Kit

Achieve a superior, stylish finish in your bathroom with help from the experts.

Whether you need materials to prepare your walls for custom tile or have decided to break the mold and install our attractive range of water-resistant wall panels, we have got everything you need to get your project started.

Looking to incorporate storage into your shower? Read on to find out about our brand-new shower niches...



Origins Wall Panels



- + Available in 16 contemporary colors that are inspired by the latest interior design trends
- + Quick and easy to fit with the items in your toolbox
- + Low maintenance and incredibly easy to clean, with no need for additional grouting

Featuring subtle but complex textures in a range of stylish colors, this highly durable and easy to install wall covering system ensures perfect results every time.

Our wall panels are made of structural WPS plywood substrate, which means fixtures such as shower seats and grab bars can be fitted securely, without impacting weight loading.

To achieve a durable finish, the printed paper design is infused with phenolic and melamine resins, dried and compressed to form a hard-wearing, high-pressure laminate coating.

Origins' tongue and groove click system provides a subtle, seamless finish and is an alternative to installing two panels with a straight joint profile. Each panel is available in three sizes: 47 $\frac{1}{4}$ " square edge, 35 $\frac{7}{16}$ " and 23 $\frac{2}{3}$ " tongue and groove, with all panels $\frac{2}{5}$ " deep.

A wide variety of profiles are available, offering a solution to any installation challenges.

Dimensions:

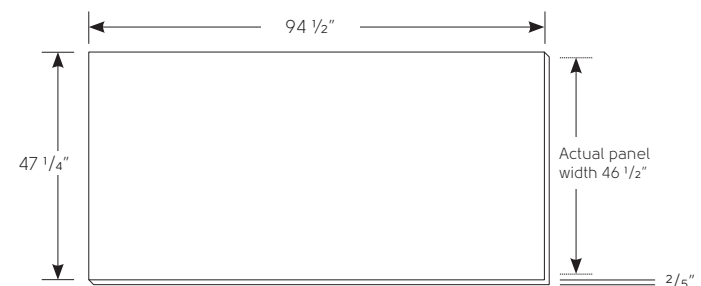
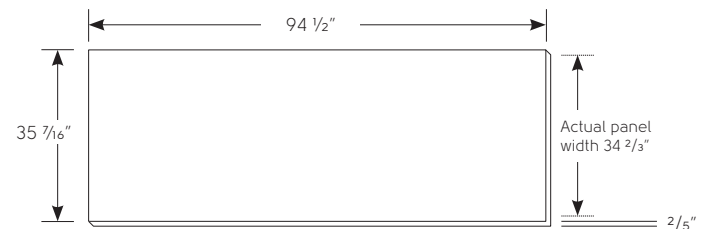
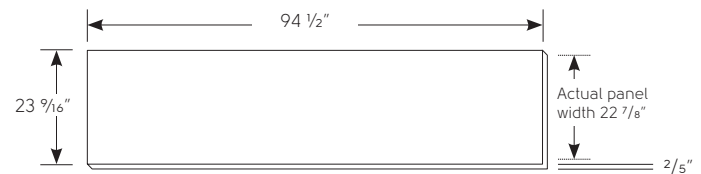



Alpino

47 1/4" | 27722ALP
35 2/5" | 27723ALP
23 2/3" | 27724ALP

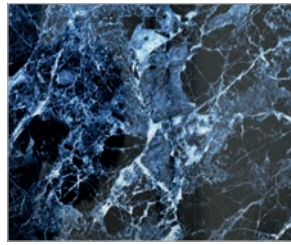

Aqua Bonito

47 1/4" | 27722AQB
35 2/5" | 27723AQB
23 2/3" | 27724AQB



Arctic Shimmer

47 1/4" | 27722ATS
35 2/5" | 27723ATS
23 2/3" | 27724ATS



Beige Eiger

47 1/4" | 27722BGE
35 2/5" | 27723BGE
23 2/3" | 27724BGE

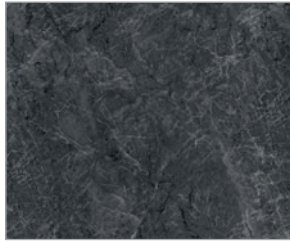

Black Bonito*

47 1/4" | 27722BKB
35 2/5" | 27723BKB
23 2/3" | 27724BKB



Blue Eiger

47 1/4" | 27722BLE
35 2/5" | 27723BLE
23 2/3" | 27724BLE



Cloudy Marble*

47 1/4" | 27722CLM
35 2/5" | 27723CLM
23 2/3" | 27724CLM



Grey Bonito*

47 1/4" | 27722GYB
35 2/5" | 27723GYB
23 2/3" | 27724GYB



Moonlight Shimmer

47 1/4" | 27722MLS
35 2/5" | 27723MLS
23 2/3" | 27724MLS



Oyster Marble

47 1/4" | 27722OSM
35 2/5" | 27723OSM
23 2/3" | 27724OSM



Toffee Marble*

47 1/4" | 27722TFM
35 2/5" | 27723TFM
23 2/3" | 27724TFM



Travertino*

47 1/4" | 27722TRA
35 2/5" | 27723TRA
23 2/3" | 27724TRA



Twilight Marble

47 1/4" | 27722TLM
35 2/5" | 27723TLM
23 2/3" | 27724TLM

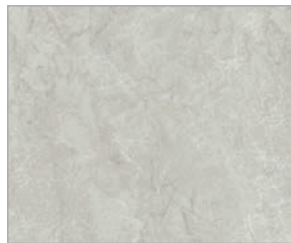

White Bonito

47 1/4" | 27722WBO
35 2/5" | 27723WBO
23 2/3" | 27724WBO



White Frost*

47 1/4" | 27722WFS
35 2/5" | 27723WFS
23 2/3" | 27724WFS

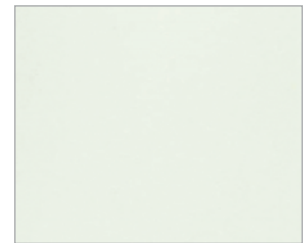

White Gloss

47 1/4" | 27722WHT
35 2/5" | 27723WHT
23 2/3" | 27724WHT

*Stocked color

Wall Panels – See swatches for color codes

Product Name	Size	Price
Square Edged Panels	47 1/4"	\$272.00
Tongue & Groove Panels	35 2/5"	\$272.00
Tongue & Groove Panels	23 2/3"	\$163.00

H-Sections

Product Name	Product Code	Price	In Stock
White H-Section	27726	\$65.00	Stocked
Satin Anodized Aluminum H-Section	27718	\$65.00	Stocked
Polished Chrome Silver H-Section	27732	\$65.00	Stocked
Black Bonito Aluminum H-Section	27726BKB	\$65.00	Stocked
Cloudy Marble Aluminum H-Section	27726CLM	\$65.00	Stocked
Grey Bonito Aluminum H-Section	27726GYB	\$65.00	Stocked
Travertino Aluminum H-Section	27726TRA	\$65.00	Stocked
Toffee Marble Aluminum H-Section	27726TFM	\$65.00	Stocked
White Frost Aluminum H-Section	27726WFS	\$65.00	Stocked
Black H-Section	27726BLK	\$65.00	Stocked

End Caps

Product Name	Product Code	Price	In Stock
White End Cap	27728	\$60.00	Stocked
Satin Anodized Aluminum End Cap	27719	\$60.00	Stocked
Polished Chrome Silver End Cap	27730	\$60.00	Stocked
Black Bonito Aluminum End Cap	27728BKB	\$60.00	Stocked
Cloudy Marble Aluminum End Cap	27728CLM	\$60.00	Stocked
Grey Bonito Aluminum End Cap	27728GYB	\$60.00	Stocked
Travertino Aluminum End Cap	27728TRA	\$60.00	Stocked
Toffee Marble Aluminum End Cap	27728TFM	\$60.00	Stocked
White Frost Aluminum H-Section	27728WFS	\$60.00	Stocked
Black End Cap	27728BLK	\$60.00	Stocked

Internal Corners

Product Name	Product Code	Price	In Stock
White Internal corner	27725	\$70.00	Stocked
Satin Anodized Aluminum Internal Corner	27716	\$70.00	Stocked
Polished Chrome Silver Internal Corner	27733	\$70.00	Stocked
Black Bonito Aluminum Internal Corner	27725BKB	\$70.00	Stocked
Cloudy Marble Aluminum Internal Corner	27725CLM	\$70.00	Stocked
Grey Bonito Aluminum Internal Corner	27725GYB	\$70.00	Stocked
Travertino Aluminum Internal Corner	27725TRA	\$70.00	Stocked
Toffee Marble Aluminum Internal Corner	27725TFM	\$70.00	Stocked
White Frost Aluminum Internal Corner	27725WFS	\$70.00	Stocked
Black Internal Corner	27725BLK	\$70.00	Stocked

External Corners

Product Name	Product Code	Price	In Stock
White External Corner	27727	\$70.00	Stocked
Satin Anodized Aluminum External Corner	27717	\$70.00	Stocked
Polished Chrome Silver External Corner	27731	\$70.00	Stocked
Black Bonito Aluminum External Corner	27727BKB	\$70.00	Stocked
Cloudy Marble Aluminum External Corner	27727CLM	\$70.00	Stocked
Grey Bonito Aluminum External Corner	27727GYB	\$70.00	Stocked
Travertino Aluminum External Corner	27727TRA	\$70.00	Stocked
Toffee Marble Aluminum External Corner	27727TFM	\$70.00	Stocked
White Frost Aluminum External Corner	27727WFS	\$70.00	Stocked
Black External Corner	27727BLK	\$70.00	Stocked

Profile types:

98 2/5"



Bottom Profiles

Product Name	Product Code	Price	In Stock
Transeal Profile	27720	\$60.00	Not Stocked
Wallboard Bottom onto Tray PVC	27689	\$60.00	Future Stock
Wallboard Bottom onto Vinyl PVC	27690	\$60.00	Not Stocked
Wallboard Bottom to skirting Aluminium	27684	\$60.00	Not Stocked

Profile types:

118"

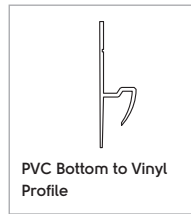
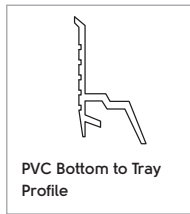

Wall Panel Kits

Product Name	Product Code	Price	In Stock
Origins Wall Panel Kit in Black Bonito (includes: 4-27723BKB, 2-27728BKB, 2-27725BKB, 6-WP2201-TNK, 4-WP2301-TNK)	OW6036-BKB	\$1,445.00	Stocked
Origins Wall Panel Kit in White Frost (includes: 4-27723WFS, 2-27728WFS, 2-27725WFS, 6-WP2201-TNK, 4-WP2301-TNK)	OW6036-WFS	\$1,445.00	Stocked
Origins Wall Panel Kit in Grey Bonito (includes: 4-27723GYB, 2-27728-GYB, 2-27725-GYB, 6-WP2201-TNK, 4-WP2301-TNK)	OW6036-GYB	\$1,445.00	Stocked
Origins Wall Panel Kit in Toffee Marble (includes: 4-27723TFM, 2-27728TFM, 2-27725TFM, 6-WP2201-TNK, 4-WP2301-TNK)	OW6036-TFM	\$1,445.00	Stocked
Origins Wall Panel Kit in Cloudy Marble (includes: 4-27723CLM, 2-27728CLM, 2-27725CLM, 6-WP2201-TNK, 4-WP2301-TNK)	OW6036-CLM	\$1,445.00	Stocked
Origins Wall Panel Kit in Travertino (includes: 4-27723TRA, 2-27728TRA, 2-27725TRA, 6-WP2201-TNK, 4-WP2301-TNK)	OW6036-TRA	\$1,445.00	Stocked

FastNICHE Shower Niches



- + Simple way of creating extra space in your bathroom
- + Recess directly into the wall for an immediate transformation
- + Durable SMC construction for a lifetime of use

Wall niches are a highly contemporary yet simple way to create more space in your bathroom and allows you to build storage into your showering area with relatively little effort.

Quick and easy to install, FastNICHE shower niches are constructed from sheet-molded compound plastic (SMC) for strength and durability. All sizes are available in a glossy white finish with full niches also offered in bold matte black.

Our range of FastNICHE shower niches are supplied in one structural piece that is between 3 1/2" - 3 3/4" deep and can be simply recessed into the wall.

There are three sizes to choose from – double, triple or full – giving you plenty flexibility based on your needs.

Once installed, FastNICHE shower niches do not require any additional finishing, meaning you don't need to factor in the extra time or cost of covering the niche in tile or with wall panels – it's ready to go when you are.

FastNICHE can be perfectly paired with either custom tile or our range of stylish Origins wall panels (**see page 53**), and benefit from a lifetime guarantee for lasting peace of mind.

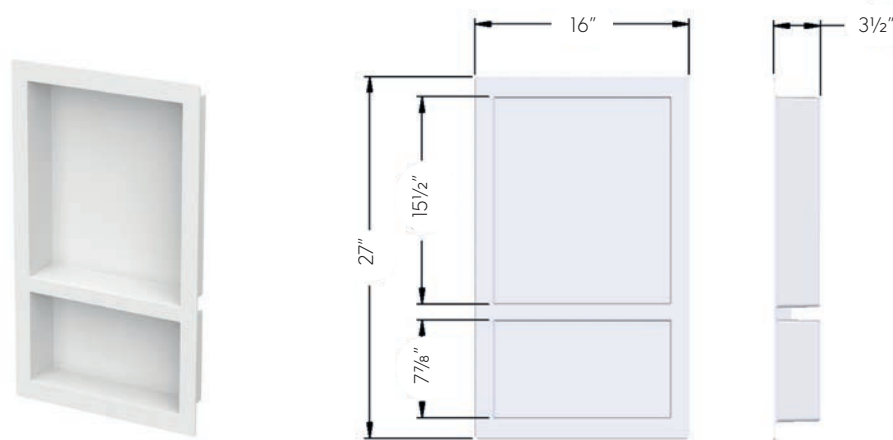

FastNICHE Double

\$145.00

White: 27802-WH

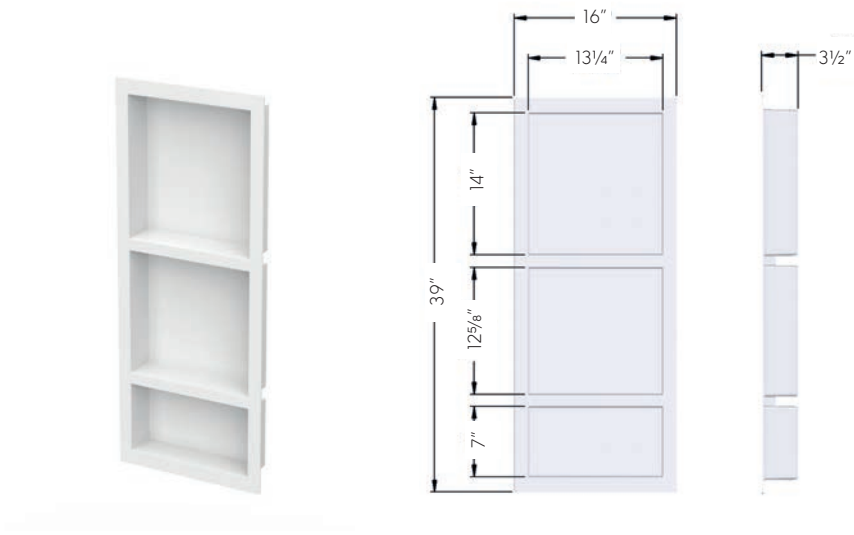

FastNICHE Triple

\$165.00

White: 27801-WH



FastNICHE Full

\$485.00

White: 27800-WH

Black: 27800-BK



TrueBOARD Tileable Wall Kit

- + Simple and effective way to prepare your bathroom for custom tile

Prepare your bathroom walls for custom tile with our TrueBOARD tileable wall kit which contains all the materials you need to create a flush foundation for your walls.

TrueBOARD Tileable Wall Kit

\$607.00

27738

Kit includes:

- + 8 x TrueBOARD 3' x 5' x 1/2" walls (approx. 120 sq ft coverage)
- + 120 screws
- + 120 washers

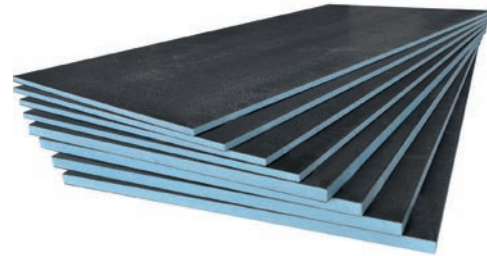

TrueBOARD Installation Kit

\$400.00

WPI080-TRU

Kit includes:

- + Tank/10 waterproofing compound (1 gallon – covers approx. 60 sq. ft. with two coats)
- + 75' Joint reinforcement tape (3 x 25 ft. rolls)
- + Internal corners x 4
- + External corners x 2
- + Supply gasket x 1
- + Mixer valve gasket x 1
- + #9 x 2 1/2" premium Torx screws x 32
- + Torx bit driver x 1
- + Tank/10 polyurethane construction adhesive (6 x 10 oz. tubes)
- + Latex caulk (1 x 10 oz. tube)
- + Nitrile gloves x 2 pairs
- + Paint roller handle x 1
- + Paint roller covers x 2
- + Paint brush x 1

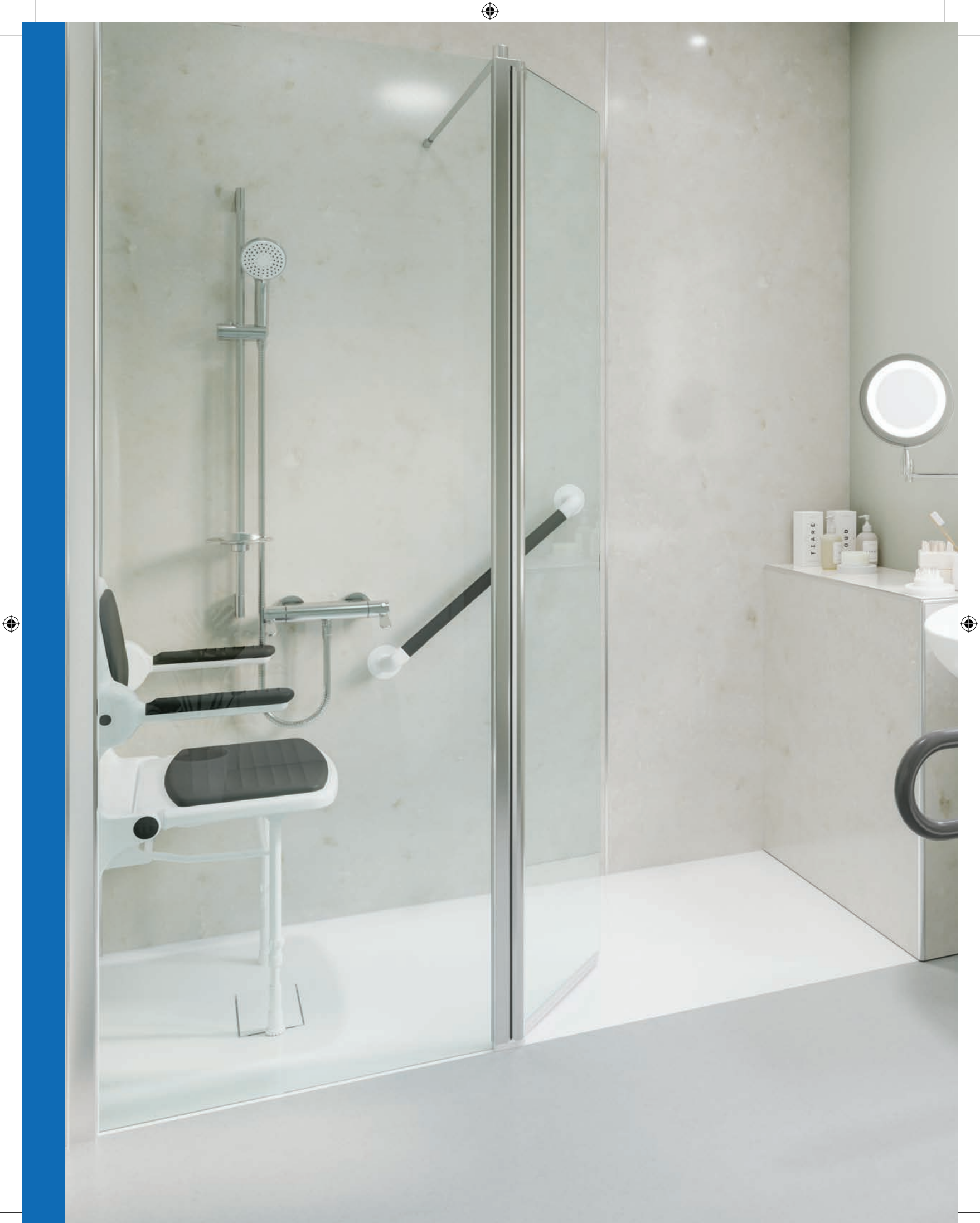



05

Shower Seats

- 65 Velena Series Seats
- 67 2000 Series Seats
- 69 4000 Series Seats

Ideal for wheelchair users, seniors or those with reduced mobility and health conditions, shower seats are an effective way to make showering an easier, more dignified experience.

With a number of useful features tailored to meet a variety of specific needs, our broad range of versatile shower seats has been developed in consultation with occupational therapists, users and contractors to ensure the highest levels of functionality and safety without compromising on style.



Velena Series Seats



- + Stylish, modern design in multiple colors
- + Folds away to save space when not in use
- + Adjustable leg model offers a flexible height range

From the Velena range of ultra-stylish mobility aids comes an ergonomic fold-up shower seat with soft-close mechanism and contemporary styling which promotes the importance of aesthetics when designing an accessible bathroom.

Made from strong, durable materials, Velena seats can withstand a maximum capacity of 440lbs and are ideal for a wide variety of users. They also benefit from a robust aluminum leg which not only offers fantastic support, but also vastly reduces the impact of weight loading on the wall and fixings, meaning they are incredibly safe to use.

The ergonomic seat has been designed for comfort, features a water drainage slot for fast drying, and comes in a choice of two monochromatic colors: simple white or matte black.

Standard Velena seats offer a height of 18¹/₂". For greater flexibility when installing, our adjustable leg model can be fixed to a height of between 16³/₅" – 23²/₃".



Velena Seat

\$300.00

White
Black

02801-WH
02801-BK

Velena Seat with Adjustable Leg

\$325.00

White
Black

02810-WH
02810-BK



2000 Series Seats



- + Strong, durable aluminum frame
- + Comfortable, removable foam pads
- + Folds away to save space when not in use

Economy 2000 Series shower seats offer comfort, safety and security with a weight capacity of 350lbs, and a medium-duty, slim profile that folds away when not in use.

2000 Series seats gain their strength from a durable, rust-proof aluminum frame and legs, which provide safe and stable support, ensuring the wall fixings are not impacted by weight loading. The legs allow height adjustments in 3/4" increments, with the fine-tuning feature on one foot able to compensate for floor slope.

These seats feature a molded polyethylene seat fitted with removable closed-cell foam pads which do not absorb water, providing increased comfort and peace of mind.

Since the seat and both arms fold up and down independently, they can be quickly and easily adjusted to meet the needs of the user, whether that involves raising a single arm to ensure easy access to the seat, or folding the entire unit against the wall to increase space when entering and exiting the shower.



Compact Seat	\$175.00
Gray	02000P
Blue	02200P



Standard Seat	\$225.00
Gray	02010P
Blue	02210P



Standard Seat with back & arms	\$350.00
Gray	02130P
Blue	02230P



4000 Series Seats



- + Sturdy stainless-steel frame
- + Folds away to save space when not in use
- + Wide range of widths and seat shapes

Shower comfortably and safely with our range of deluxe 4000 Series shower seats. All seats can support a weight capacity of 560lbs, with many supplied with removable foam pads that are simple to clean and will not absorb water.

Quick and easy to install, our 4000 Series seats are constructed from rust-proof stainless steel and molded polyethylene, meaning durability and safety are assured, especially as the sturdy legs ensure the wall fixings are not impacted by weight loading.

The wide range of height adjustability makes individual fit and comfort easy to achieve, with all models generously sized to allow for movement when showering while staying secure.

As the seat and arms swing independently, users can make adjustments for any situation. For example, position one arm up for easier entry from the side, swing the seat and arms up to make more space available in the shower, or have both arms down to maximize security and balance while seated.

Versatility and comfort define these superior shower seats which are guaranteed to give you a lifetime of service.

Looking for an ADA compliant shower seat?

Take a look at our Extra Wide Seat which is specially designed for larger users to offer comfort and stability, with an increased maximum weight capacity of 700lbs.

Extra-wide Seat

\$500.00

Gray
Blue

04570P
04580P





Slatted Seat **\$425.00**

Wooden 04030



Standard Seat **\$275.00**

Gray 04270P
Blue 04070P



Standard 'U' Seat **\$325.00**

Gray 04200P
Blue 04100P



Wide 'U' Seat **\$375.00**

Gray 04220P
Blue 04120P



Standard Seat with back & arms **\$525.00**

Gray 04230P
Blue 04130P



Wide Seat with back & arms **\$625.00**

Gray 04240P
Blue 04140P



Standard 'U' Seat with back & arms **\$600.00**

Gray 04260P
Blue 04160P



Wide 'U' Seat with back & arms **\$675.00**

Gray 04250P
Blue 04150P





06

Grab Bars

- 75 Comfort Grip
- 77 Specialty Grip
- 79 Fold-up Supports

The first step in creating a safe space for those with reduced mobility is often to install a load-bearing grab bar for support with standing, sitting, balancing, and moving around the home.

Our wide range of grab bars are available in a variety of styles, colors and have been designed to be strong, providing reassurance when you need it most.



Comfort Grip Grab Bars



- + Easy to grip fluted overlay
- + Warm to touch exterior
- + All models meet ADA requirements

Excellent grip and a surface that is warm to touch is what sets our comfort grip grab bars apart from the rest.

Unlike steel bars that can be cold to touch, comfort grip bars offer a warmer alternative that is easy to hold, even when wet. Vinyl material overlays a tubular metal core designed to provide strength and rigidity when you need it most, while comfort and the ability to grip the bar comes from the fluted overlay material.

With a choice of five fixing points to easy installation, these bars are available in many customary straight lengths, we also supply two popular angled models, and two kits to make it even easier to create a grab bar design that is tailored to your space and needs.

All models are tried and tested to meet ADA requirements with a maximum load capacity of 420lbs.



**Cut-to-length
Extension Bar Kit** **\$45.00**
White 01943-WH



**Cut-to-length
Corner Grab Bar Kit** **\$275.00**
White 01942-WH

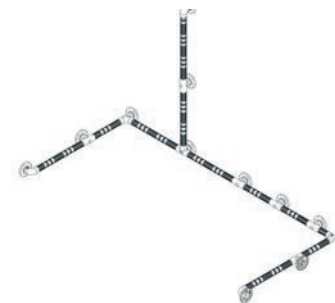

**Cut-to-length
Alcove Grab Bar Kit** **\$350.00**
White 01941-WH



**12" Comfort Grip
Grab Bar** **\$35.00**

White	01900-WH
Blue	01900-BU
Gray	01900-GR



**16" Comfort Grip
Grab Bar** **\$40.00**

White	01905-WH
Blue	01905-BU
Gray	01905-GR



**18" Comfort Grip
Grab Bar** **\$45.00**

White	01910-WH
Blue	01910-BU
Gray	01910-GR



**24" Comfort Grip
Grab Bar** **\$50.00**

White	01920-WH
Blue	01920-BU
Gray	01920-GR



**32" Comfort Grip
Grab Bar** **\$60.00**

White	01930-WH
Blue	01930-BU
Gray	01930-GR



**36" Comfort Grip
Grab Bar** **\$70.00**

White	01940-WH
Blue	01940-BU
Gray	01940-GR



**42" Comfort Grip
Grab Bar** **\$80.00**

White	01950-WH
Blue	01950-BU
Gray	01950-GR



**90° Angled Comfort
Grip Grab Bar** **\$130.00**

White	01925-WH
Blue	01925-BU



**135° Angled Comfort
Grip Grab Bar** **\$90.00**

White	01915-WH
Blue	01915-BU

Specialty Grip Grab Bars



- + Easy and quick to install
- + Improve user safety and balance

Our range of simple, affordable specialty grab bars have been designed to improve user safety, mobility, and balance around the home, with unique shapes that make them more accessible and enhance grip.



12" Flat End Grab Bar **\$25.00**
 White 01200-WH



18" Flat End Grab Bar **\$35.00**
 White 01210-WH



18" Cranked Grab Bar **\$25.00**
 White 01760-WH



24" Cranked Grab Bar **\$35.00**
 White 01750-WH



Newel Grab Bar **\$60.00**
 Hand: Left - Ivory 01745-L
 Hand: Right - Ivory 01745-R



Padded Back Rest **\$60.00**
 Blue 01190-BU
 Gray 01190-GR



Fold-up Supports



- + Provides stability when using the toilet
- + Folds away when not in use
- + Maximum weight capacity of 440lbs

Fold-up supports have been designed to provide additional stability when using the toilet, with the trombone shape allowing users to find the best possible grip and leverage.

Ideal for use in a multi-user bathroom, all fold-up supports can be held securely in the upright position to save space when not in use, with them releasing safely and easily when required.

With maximum weight loads of up to 440lbs, these inclusive support bars have been developed with durability in mind. They also feature a chrome finish or epoxy resin coating, with a rust inhibiting treatment to protect them from water ingress.

Our range of fold-up supports are available with optional toilet roll holders, fixed or adjustable legs, with multiple color options to cater to your style preference.



Fold-up Support with Adjustable Leg **\$275.00**

(max. capacity 440lbs)

White	01830-WH
Blue	01830-BU
Stainless steel	01830-SS



Fold-up Support with Fixed Leg **\$225.00**

(max. capacity 440lbs)

White	01820-WH
Blue	01820-BU



Fold-up Support without Leg **\$250.00**

(max. capacity 220lbs)

White	01810-WH
-------	----------

Terms & Conditions

PLACING ORDERS

Orders may be submitted by email to orders@arcfirst.net or by fax to 1-715-743-2738. Orders submitted to ARC, Inc. (ARC) must be on the Buyer's valid purchase order form bearing the company's name, billing address, current email address, and the ship-to address including a phone number of the recipient (required by carriers for delivery purposes). No orders will be accepted other than in writing. Purchase orders must list the desired ARC item codes and the quantity of each item. ARC will make every reasonable effort to fill all orders, however, we do not guarantee that every product is in stock at the time of an order. We will inform Buyer of any backordered items and offer the opportunity to cancel or preserve the order. ARC reserves the right to discontinue items and add new items at any time without notice. All shipping weights described, other than those on actual shipping documentation, are approximate and intended solely to assist Buyers with estimating shipping costs.

CONDITIONS OF SALE

All sales are prepaid by credit card unless Buyer has an approved credit account with ARC. Terms of credit accounts are established by ARC. Payments on credit accounts must be made with a check, money order, or by ACH transfer. Payment of a credit account with a credit card requires pre-approval and will result in a 4% surcharge. Overdue amounts (that is, any amount not received by the due date shown on the invoice) are subject to a finance charge of 1.5% per month (18% per year). An administrative fee of fifty percent (50%) of the invoice total will be added to any interest charges on any overdue amount when payment is obtained using a collection agency. Returned checks are subject to a \$50.00 fee.

PRICING

Prices shown in ARC publications are in US dollars. Prices do not include shipping, handling, or sales tax, which will be added to Buyer's invoice. Without a valid Reseller's Certificate on file at ARC, sales tax will be added to all invoices when applicable. All prices are subject to change without notice. All special offers or discounts are time limited to the month of issuance unless otherwise noted in writing by ARC. ARC makes every effort to display accurate prices, however, in the event that an order is placed for any item priced incorrectly, and the error is discovered prior to shipping the item, ARC reserves the right to correct the inaccuracy or cancel the order. Should this occur, ARC will contact Buyer, inform Buyer of the error and provide the actual price of the item, at which time Buyer will have the option to either confirm the order at the actual price or cancel the order. The price of an item is not final until the item is shipped.

RETURNS

Returns require pre-approval. Please call ARC to obtain a Return Authorization (RA) form. Returns are subject to a 35% restocking fee. Shipping charges are not refundable. In the event that a return is required, a valid Return Authorization number will be issued. An RA will not be issued more than thirty (30) days after the product's purchase date, except for approved stock rotations and other pre-approved arrangements with authorized ARC distributors. Return Authorizations expire thirty (30) days after the date they are issued, and returns must be received by ARC, Inc. within that thirty (30) day period or no credit will be issued. The RA number must be clearly written on the outside of all shipping boxes and pallet wrapping. All merchandise must be returned 100% complete in original packaging with all product, parts, packaging material, manuals, and accessories included, and must be in "as new" saleable condition. All products must be returned freight prepaid to ARC. Incomplete or unauthorized returns will be refused. All returned product will be inspected, and, if deemed damaged or used, refunds will not be issued. Items cannot be returned if they were special ordered, made to customer specifications, or are non-inventory or non-stock items.

TECHNICAL ACCURACY

ARC attempts to be as accurate as possible in describing product specifications, maintenance, usage, care, and installation. ARC does not, however, warrant that product information or other content of any ARC publication or website is accurate, complete, current, or error-free. If a product offered by ARC is not as described, Buyer's sole remedy is to return it in unused condition for an exchange or refund of the original purchase price. All products must be returned freight prepaid to ARC. Shipping charges are not refundable.

FedEx, UPS, or SPEE DEE SHIPMENTS

Buyers must inspect any shipment upon arrival, and if the package is damaged, refuse the shipment. If the damaged products were shipped to Buyer on ARC's account, the carrier will return the shipment to ARC and we will file a claim and promptly send a new shipment to Buyer; if the products were shipped to Buyer on an account other than ARC's, all returns and claims must be processed through that account holder. If Buyer finds concealed damage, call ARC at once. Again, if the damaged products were shipped on ARC's account, we will instruct the carrier to pick up the package and return it to us for a claim, and we will reship Buyer's order; if products were shipped on a different account, all returns and claims must be processed through the holder of that shipping account.

MOTOR FREIGHT SHIPMENTS

Safe delivery of a freight shipment is the responsibility of the carrier. Please examine your shipment carefully before signing the freight bill. By your acceptance of the shipment from the carrier, affirmed once you sign a freight bill, you acknowledge that the product has been delivered in good condition, relieving ARC and the carrier from further responsibility. If damage is discovered, or if the number of pieces received does not match the number on the freight bill, do not accept the shipment without noting the shortage or damage on the freight bill and insist that the carrier's agent (the driver) sign and date the freight bill near the notation. Failure to complete these steps may jeopardize recovery of the goods or reimbursement for them, and relieve the carrier and ARC from all responsibility. If any concealed damage or shortage is discovered while unpacking, leave the material and the packing as is and ask the carrier for a concealed damage or shortage inspection. Consult the carrier for the necessary claim form. When checking shipments, compare what was received with quantities listed on the packing list or invoice. If the carrier leaves the facility before you find a shortage or damage, contact ARC immediately—claims with motor freight companies must be made promptly. You must contact ARC within three (3) business days after receipt of a shipment to report any issues. ARC is not responsible for shortages or damage to goods that are not reported within three (3) business days after receipt of a shipment. Claims for loss or damaged material and transportation charges may not be deducted from any ARC invoice and the payment of ARC invoices must not be withheld awaiting adjustment of such claims since it is the function of the carrier to guarantee safe delivery and to remedy shortage or damage claims.

COPYRIGHT AND TRADEMARKS

All content, such as text, graphics, logos, icons, images, video and audio clips, digital downloads, and data, included in ARC catalogs, brochures, flyers, websites, videos, and other branded materials, is the property of ARC or a manufacturer of products sold by ARC, and is protected by international copyright laws. The use of such content is prohibited without the express written consent of ARC.

WARRANTIES AND LIABILITY

All manufacturer warranties are detailed on ARC's website: www.arcfirst.net. ARC makes these warranties available, without recourse to ARC to the extent permissible, to authorized distributors and dealers, and extends such warranties to the first retail purchaser who puts a product into service after purchasing it from an authorized distributor or dealer. No representative of ARC is authorized to give or make any other representation or warranty or modify any warranty in any way. The provisions of these warranties do not apply to products: a) used for purposes for which

they are not designed or intended; b) which have been subjected to alteration, abuse, misuse, negligence, or accident; c) which have been improperly stored, installed, maintained, or operated; d) which have been damaged due to neglect or lack of proper maintenance, cleaning, or care; e) which have been damaged due to the use of inappropriate cleaners, solvents, abrasives, or other chemical or mechanical causes. Proof of purchase is required for any warranty claim. Products shipped to ARC for warranty service, replacement, or refund, that were not purchased from an authorized ARC distributor or dealer, will not qualify for warranty service, and ARC will hold such products only for a limited time and ship them back at the sender's cost upon their request after shipping and handling fees have been prepaid. Buyer's sole and exclusive remedy against ARC for any cause of action arising out of the sale or use of any product purchased from ARC shall be replacement of the product or refund of the purchase price paid for the product. In no event shall ARC be liable for special, indirect, incidental, or consequential damages howsoever arising, including without limitation, lost revenues or profits, labor costs, shipping and freight costs, or expenses incurred due to the installation, removal, or replacement of any product. Any cause of action for breach of warranty must be brought by Buyer, if at all, within one (1) year from the date the cause of action occurred. Any discrepancy in pricing or other charges shall be deemed waived by Buyer unless Buyer notifies ARC thereof in writing within sixty (60) days from the date of invoice on which such disputed transaction is reflected. In no event shall ARC have any responsibility or liability to a Buyer for any failure or delay in performance by ARC which results, directly or indirectly, in whole or in part, from any cause or circumstance beyond the reasonable control of ARC. Such causes and circumstances shall include, but are not limited to, acts of God, acts of Buyer, acts or orders of any governmental authority, strikes or other labor disputes, natural disasters, accidents, wars, civil disturbances, unavailability of supplies from usual suppliers, difficulties or delays in transportation, mail or delivery services, or any other cause beyond ARC's reasonable control.

SOLE AGREEMENT AND INTERPRETATION

The Terms and Conditions set forth herein, together with any additions or revisions which may be agreed in writing by ARC, embody the whole agreement of the parties and provide the only remedies available. There are no promises, terms, conditions, understandings, obligations, or agreements other than those contained herein. These Terms and Conditions, and any transactions or agreements to which they apply, shall be governed both as to interpretation and performance by the laws of the State of Wisconsin.

ARC

AKW Resource Center

General inquiries

1-715-743-2771

info@arcfirst.net

ARC, Inc.

7 Tiff Ave.

Neillsville,

WI 54456

www.arcfirst.net

