

Alape[®]

Price Book

MSRP in US \$ Prices effective as of June 1, 2021

A[®]form – Glazed Steel
Washbasins, washstands
and washplaces

Ãform

WP / AG

WT / WT.RX

AB / SB

EB / HB

UB

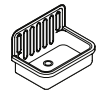
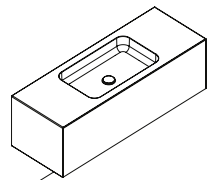
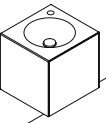
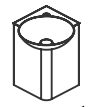
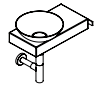
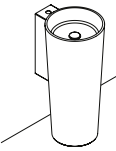
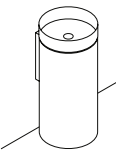
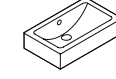
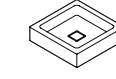
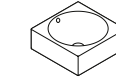
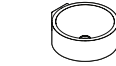
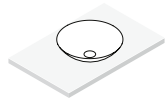
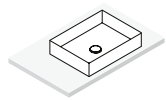
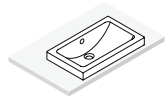
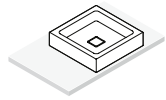
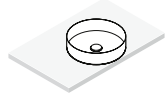
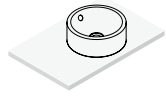
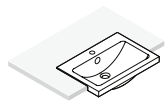
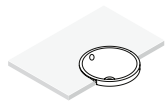
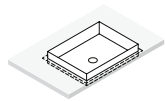
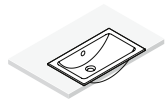
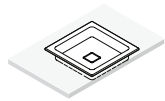
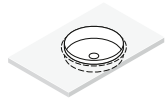
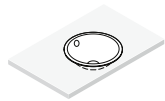
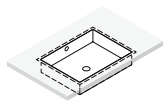
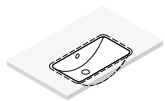
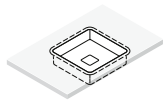
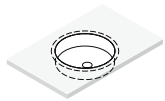
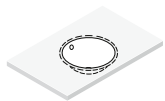

UB – Undermount basins

EB – Built-in basins
HB – Semi-recessed basins

AB – Sit-on basins
SB – Dish basins

WT – Washstands

WP – Washplaces
AG – Bucket sinks

Contents

A~form

General notes	004
Novelties 2021/ Discontinued articles 2021	005-006
Article index	007-010

Installation types	011
---------------------------	-----

Material

Glazed Steel	012-013
--------------	---------

Individualization

Made-to-measure washplace	014-015
Individualization in detail	016-017

Faucet and drill holes information	018
---	-----

Technical information

UB Undermount basins	020-031
Overview of basins	021
UB.K, .KE, .SO, .O, .ME, .SR, .R, .RE, .Q,	022-031

EB Built-in basins	032-057
Overview of basins	033
EB Built-in basins	034-056
EW, EB.S, .K, .KE, .O, .ME, .SR, .R, .RE, .Q	
HB Semi-recessed basins	057
HB.S, .R	

AB Sit-on basins	058-071
Overview of basins	059
AB.K, .KE, .SO, .ME, .SR, .R, .RE, .Q,	060-071

SB Dish basins	072-077
Overview of basins	073
SB.K, .CO, .O, .SR	074-077

Special glazing	078-089
Overview	079
Aqua	
SB.Aqua300, SB.Aqua360, SB.Aqua450	080-081
Terra	
SB.Terra300, SB.Terra360, SB.Terra450	082-083
Bicolor	
AB.KE400, AB.SO450.1, SB.K360GS, WT.RX400KE	084-085
Metallic	
UB.K400, UB.O525, AB.SO450.1, SB.K360.GS, WT.PX400K	086-089

WT Washstands	090-123
Washstand overview (WT)	091
WT Floor-standing washstands	092-098
WT.RX – with wall connection	092-096
WT.RX – freestanding	097-098

WT Wall-mounted washstands	099-123
WT.RS	099-100
Scopio (WT.CO)	101
WT.IC	102-103
WT.MC	104-105
Fusion.S (WT.XXS)	106-107
WT.QS	108-112
Xplore.S (WT.XS)	113-114
Stream (WT.SR)	115
WT.PR	116-119
WT.GR	120-121
X.plicit (WT.RE)	122-123

WP Washplaces	124-139
Overview of washplaces (WP)	125
Insert (WP.Insert)	126
Piccolo Novo (WP.PN)	126-127
FO (WP.FO)	128-133
Accessories FO	134
Units.SR	136-139

AG Bucket sinks	140-141
------------------------	---------

Assist shelf system	142-147
Overview shelves	143
Shelves	144-147

Accessories	148-151
Accessories for basins, washstands, and washplaces	150-151
Mounting and connection measurements	152-162
Return goods policy/ Conditions of sale and limited warranties	164-165
General information	166
Alape Representation abroad	167-169
Overview colors	171

General notes

With this price list, we are pleased to offer you our optimized range of basins, washstands and washplaces. You can expect a market-oriented portfolio which stands for variety and meets many different requirements of the individual bathroom design.

In these times, the issues of hygiene and sustainability are becoming more and more important. We are strongly committed to this and are now equipping white basins and washstands with the new ProShield surface.

The new Alape ProShield surface: no more chance for bacteria and fungi

Due to the material and the manufacturing process, our surfaces are almost pore-free and have therefore always been very easy to care for and hygienic. ProShield now ensures even more hygiene: the surface of the glazed steel frees itself from bacteria thanks to the addition of silver ions. ProShield is now available as a standard for every white basin and every white washstand. Find out more at www.alape.com/en/proshield/.

Novelties | Current range

From page 5 you will find a list of our novelties, the discontinued articles and the article index of our current portfolio.

Variable installation types for basins

With regards to systematic variety, Alape's extensive range remains unsurpassed. It includes undermount, built-in, semi-recessed basins, sit-on and dish basins. These small, subtle differences allow Alape to set accents in bathroom design. On page 11 you will find information about the benefits of every installation type.

Fittings information

Please refer to the price list in the product descriptions for information on the optimum water impact area on the basin mold.

Colors

Our basins, washbasins and washing plates made of glazed steel are by default in white surface. On page 173 you will find an overview of which series are for surcharge also available in the current glossy and matte colors.

Service team

Our service team provides partner-like and competent support. You can reach the team on +1 (800)-774-1181 or mail.usa@alape.com.

Technical Data

We have collated all important information for you as a planning professional at www.alape.com. Here you can find more extensive information and technical details for each product, such as CAD data, descriptive texts or declarations of performance.

Novelties

Article	Name	Finish	Page
---------	------	--------	------

EB Built-in basins without overflow

2000 000 000	EB.K325	white, ProShield	037
2001 100 000	EB.K400	white, ProShield	039
2002 100 000	EB.K450	white, ProShield	041
2003 000 000	EB.K400H	white, ProShield	038
2004 100 000	EB.K450H	white, ProShield	040
2005 100 000	EW 3	white, ProShield	034
2018 100 000	EW 3.2	white, ProShield	035
2100 100 000	EB.O425	white, ProShield	044
2101 100 000	EB.O525	white, ProShield	046
2102 100 000	EB.O500H	white, ProShield	045
2104 100 000	EB.O600H	white, ProShield	047
2201 100 000	EB.R585	white, ProShield	052
2202 100 000	EB.R585H	white, ProShield	051
2203 000 000	EB.R800	white, ProShield	054
2204 000 000	EB.R800H	white, ProShield	053
2218 500 000	EB.SR650	white, ProShield	050
2219 800 000	EB.SR650H	white, ProShield	049
2406 100 000	EB.S450H	white, ProShield	036

Washplace FO

5165 516 000	WP.FO2	Oak brushed	129
5165 816 000	WP.FO1	Oak brushed	129
5166 516 000	WP.FO4	Oak brushed	130
5166 816 000	WP.FO3	Oak brushed	130
5167 516 000	WP.FO6	Oak brushed	131
5167 816 000	WP.FO5	Oak brushed	131
5168 516 000	WP.FO8	Oak brushed	132
5168 816 000	WP.FO7	Oak brushed	132
5169 516 000	WP.FO10	Oak brushed	133
5169 816 000	WP.FO9	Oak brushed	133
5171 516 000	WP.FO12	Oak brushed	128
5171 816 000	WP.FO11	Oak brushed	128

FO Cupboards

6324 990 016	HS.FO1250.L	Oak brushed	134
6324 690 016	HS.FO1250.R	Oak brushed	134

Article	Name	Finish	Page
---------	------	--------	------

Assist – Shelves

8270 000 331	AS.400.S	Matte white	144
8271 000 331	AS.600.S	Matte white	144
8272 000 331	AS.800.S	Matte white	144
8271 140 331	AS.600.HT	Matte white	144
8270 221 331	AS.400.HT.L	Matte white	145
8270 321 331	AS.400.HT.R	Matte white	145

Assist – Shower shelves

8270 000 982	AS.400.S	Matte white	146
8270 000 981	AS.400.S	Matte black	146
8274 111 982	AS.134.LO2	Matte white	146
8274 111 981	AS.134.LO2	Matte black	146
8274 112 982	AS.225.LO3	Matte white	146
8274 112 981	AS.225.LO3	Matte black	146

Assist – Toiletry

8274 170 982	AS.160.TPH	Matte white	146
8274 170 981	AS.160.TPH	Matte black	146

Accessories

Bottle trap			
8312 000 331	Sl.3	white	150
8312 000 980	Sl.3	Matte black	150
Overflow rosette			
8321 000 980	UR.1	Matte black	151
8321 000 330	UR.1	Platinum matte	151
8321 000 331	UR.1	white	151

Discontinued items

Article	Name
---------	------

Floor-standing washstand

4700 500 000	WT.RX500.ME
--------------	-------------

Assist - Shelves

8270 210 980	AS. 400.LO.L
--------------	--------------

8270 310 980	AS. 400.LO.R
--------------	--------------

8271 210 980	AS. 600.LO.L
--------------	--------------

8271 230 980	AS. 600.HT.L
--------------	--------------

8271 310 980	AS. 600.LO.R
--------------	--------------

8271 330 980	AS. 600.HT.R
--------------	--------------

8272 150 980	AS. 800.HT
--------------	------------

8272 210 980	AS. 800.LO.L
--------------	--------------

8272 240 980	AS. 800.HT.L
--------------	--------------

8272 310 980	AS. 800.LO.R
--------------	--------------

8272 340 980	AS. 800.HT.R
--------------	--------------

8273 000 980	AS. 1000.S
--------------	------------

8273 210 980	AS. 1000.LO.L
--------------	---------------

8273 310 980	AS. 1000.LO.R
--------------	---------------

Accessories

Towel rails

8250 000 921	HTH.220.L1
--------------	------------

8251 000 921	HTH.220.L2
--------------	------------

8252 000 921	HTH.220.L3
--------------	------------

8253 000 921	HTH.320.L1
--------------	------------

8260 000 921	HTH.220.R1
--------------	------------

8261 000 921	HTH.220.R2
--------------	------------

8262 000 921	HTH.220.R3
--------------	------------

8263 000 921	HTH.320.R1
--------------	------------

Designer overflow rosette

8311 000 978	ÜB.2
--------------	------

Article index

Article	Name	Price in US \$	Page	Article	Name	Price in US \$	Page
Undermount basins				2203 000 000	EB . R800	876.00	054
2030 700 000	UB . K325	216.00	022	2203 200 000	EB . R800	876.00	054
2031 700 000	UB . K400	247.00	022	2204 000 000	EB . R800H	927.00	053
2032 700 000	UB . K450	268.00	023	2204 200 000	EB . R800H	927.00	053
2110 700 000	UB . 0425	258.00	026	2207 000 000	EB . RE700 . 4	824.00	055
2111 700 000	UB . 0525	278.00	026	2208 000 000	EB . RE700H . 2	927.00	055
2250 700 000	UB . R585	412.00	028	2218 500 000	EB . SR650	670.00	050
2251 700 000	UB . R800	824.00	029	2218 700 000	EB . SR650	670.00	050
2255 700 000	UB . SR650	618.00	029	2219 600 000	EB . SR650H	721.00	049
2258 500 000	UB . RE700 . 4	773.00	030	2219 800 000	EB . SR650H	721.00	049
2312 500 000	UB . Q450	649.00	030	2226 503 000	EB . ME500	1,391.00	048
3223 501 000	UB . KE325	845.00	023	2227 503 000	EB . ME750	1,494.00	048
3224 501 000	UB . KE375	896.00	024	2302 000 000	EB . Q450	700.00	056
3225 501 000	UB . KE400	948.00	024	2303 000 000	EB . Q450H	752.00	056
3226 701 000	UB . ME500	1,339.00	027	2406 000 000	EB . S450H	330.00	036
3227 701 000	UB . ME750	1,442.00	027	2406 100 000	EB . S450H	330.00	036
3228 701 000	UB . ME1000	1,751.00	028	Semi recessed basins			
3505 501 000	UB . S0450 . 1	948.00	025	2700 000 000	HB . R585H	773.00	057
3506 501 000	UB . S0450 . 2	979.00	025	2900 000 000	HB . S450H	618.00	057
Built-in-basins				Sit-on basins			
2000 000 000	EB . K325	268.00	037	3000 200 000	AB . K325 . 2	793.00	060
2000 200 000	EB . K325	268.00	037	3002 200 000	AB . K400 . 2	803.00	061
2001 000 000	EB . K400	299.00	039	3004 200 000	AB . K400H . 2	855.00	060
2001 100 000	EB . K400	299.00	039	3006 200 000	AB . K450 . 2	927.00	062
2002 000 000	EB . K450	319.00	041	3008 000 000	AB . K450H . 2	979.00	061
2002 100 000	EB . K450	319.00	041	3202 000 000	AB . R585H . 1	979.00	068
2003 000 000	EB . K400H	340.00	038	3205 000 000	AB . R585 . 1	927.00	068
2003 200 000	EB . K400H	340.00	038	3206 200 000	AB . R800H	1,288.00	069
2004 000 000	EB . K450H	361.00	040	3207 200 000	AB . R800	1,236.00	069
2004 100 000	EB . K450H	361.00	040	3208 000 000	AB . RE700 . 4	1,030.00	070
2005 000 000	EW 3	155.00	034	3209 000 000	AB . RE700H . 2	1,133.00	070
2005 100 000	EW 3	155.00	034	3212 000 000	AB . ME500	1,391.00	065
2018 000 000	EW 3 . 2	227.00	035	3213 000 000	AB . ME750	1,494.00	065
2018 100 000	EW 3 . 2	227.00	035	3214 000 000	AB . ME1000	1,803.00	066
2023 503 000	EB . KE325	896.00	042	3220 000 000	AB . KE325	896.00	063
2024 503 000	EB . KE375	948.00	042	3221 000 000	AB . KE375	948.00	063
2025 503 000	EB . KE400	999.00	043	3222 000 000	AB . KE400	999.00	064
2100 000 000	EB . 0425	309.00	044	3230 700 000	AB . SR650	670.00	067
2100 100 000	EB . 0425	309.00	044	3231 600 000	AB . SR650H	721.00	067
2101 000 000	EB . 0525	330.00	046	3302 000 000	AB . Q450 . 1	1,082.00	071
2101 100 000	EB . 0525	330.00	046	3304 000 000	AB . Q450H . 1	1,133.00	071
2102 000 000	EB . 0500H	350.00	045	3503 000 000	AB . S0450 . 1	1,133.00	064
2102 100 000	EB . 0500H	350.00	045	Dish basins			
2104 000 000	EB . 0600H	402.00	047	3500 000 000	SB . K300 . GS	515.00	074
2104 100 000	EB . 0600H	402.00	047	3501 000 000	SB . K360 . GS	567.00	074
2201 000 000	EB . R585	464.00	052	3502 000 000	SB . K450 . GS	639.00	075
2201 100 000	EB . R585	464.00	052	3507 500 000	SB . SR650	1,442.00	076
2202 000 000	EB . R585H	515.00	051				
2202 100 000	EB . R585H	515.00	051				

Article index

Article	Name	Price in US \$	Page	Article	Name	Price in US \$	Page
3508 500 000	SB . C0375	700.00	075	4232 000 000	WT . MC800H . R	1,442.00	105
3520 000 000	SB . 0700 . GS	1,185.00	076	4236 200 000	WT . IC325H	1,185.00	102
Special glazes				4238 200 000	WT . IC600H	1,391.00	102
2031 500 190	UB . K400	340.00	086	4239 200 000	WT . IC600H . L	1,391.00	103
2111 500 190	UB . 0525	361.00	086	4240 200 000	WT . IC600H . R	1,391.00	103
3222 000 180	AB . KE400	1,020.00	084	4261 200 000	WT . GR800H	1,545.00	120
3501 000 180	SB . K360 . GS	608.00	085	4270 000 000	WT . QS325	979.00	108
3501 000 190	SB . K360 . GS	639.00	087	4272 000 000	WT . QS325X	2,009.00	109
3503 000 180	AB . S0450 . 1	1,185.00	084	4273 000 000	WT . QS525 . L	1,236.00	111
3503 000 190	AB . S0450 . 1	1,288.00	087	4274 000 000	WT . QS525 . R	1,236.00	112
3900 000 081	SB . Terra300	575.00	082	4275 000 000	WT . QS450	1,030.00	110
3900 000 082	SB . Terra300	575.00	082	4276 000 000	WT . QS450H	1,082.00	110
3900 000 083	SB . Terra300	575.00	082	4277 000 000	WT . QS325H	979.00	108
3900 000 084	SB . Terra300	575.00	082	4278 000 000	WT . QS450HX	2,060.00	109
3900 000 091	SB . Aqua300	600.00	080	4279 000 000	WT . QS525H . L	1,288.00	111
3900 000 092	SB . Aqua300	600.00	080	4280 000 000	WT . QS525H . R	1,288.00	112
3900 000 093	SB . Aqua300	600.00	080	4281 600 000	WT . SR800H . L	1,442.00	115
3901 000 081	SB . Terra360	633.00	082	4282 600 000	WT . SR800H . R	1,442.00	115
3901 000 082	SB . Terra360	633.00	082	4287 200 000	WT . GR1250H	1,906.00	120
3901 000 083	SB . Terra360	633.00	082	4288 200 000	WT . GR1250H . L	1,906.00	121
3901 000 084	SB . Terra360	633.00	082	4289 200 000	WT . GR1250H . R	1,906.00	121
3901 000 091	SB . Aqua360	660.00	080	4290 000 000	WT . XS500H . L	1,082.00	113
3901 000 092	SB . Aqua360	660.00	080	4291 000 000	WT . XS500 . L	1,030.00	113
3901 000 093	SB . Aqua360	660.00	080	4292 000 000	WT . XS500H . R	1,082.00	114
3902 000 081	SB . Terra450	713.00	083	4293 000 000	WT . XS500 . R	1,030.00	114
3902 000 082	SB . Terra450	713.00	083	4295 000 000	WT . XXS450H . L	1,082.00	106
3902 000 083	SB . Terra450	713.00	083	4296 000 000	WT . XXS450 . L	1,030.00	106
3902 000 084	SB . Terra450	713.00	083	4297 000 000	WT . XXS450H . R	1,082.00	107
3902 000 091	SB . Aqua450	744.00	081	4298 000 000	WT . XXS450 . R	1,030.00	107
3902 000 092	SB . Aqua450	744.00	081	4500 000 000	WT . RX400KH	2,524.00	092
3902 000 093	SB . Aqua450	744.00	081	4501 000 000	WT . RX325K	2,266.00	092
4503 000 190	WT . RX400K	2,678.00	088	4502 000 000	WT . RX325K	2,266.00	097
4506 500 180	WT . RX400 . KE	3,760.00	085	4503 000 000	WT . RX400K	2,472.00	093
Washstands				4504 000 000	WT . RX400K	2,472.00	097
4102 000 000	WT . RE1000H . L	1,545.00	122	4505 500 000	WT . RX325 . KE	3,296.00	095
4104 000 000	WT . RE1000H . R	1,545.00	123	4506 500 000	WT . RX400 . KE	3,605.00	095
4105 000 000	WT . RE800H	1,339.00	122	4507 500 000	WT . RX400 . CO	2,575.00	094
4200 000 000	WT . PR585	1,082.00	116	4507 800 000	WT . RX400H . CO	2,575.00	094
4201 000 000	WT . PR585H	1,133.00	116	4801 000 000	WT . RX325QS	2,575.00	096
4203 000 000	WT . PR800H	1,391.00	117	4802 000 000	WT . RX325QS	2,472.00	098
4203 300 000	WT . PR800	1,339.00	117	4804 000 000	WT . RX450QS	3,811.00	096
4205 000 000	WT . PR800H . L	1,391.00	118	4805 000 000	WT . RX450QS	3,811.00	098
4205 300 000	WT . PR800 . L	1,339.00	118	5042 000 000	WT . RS325	1,545.00	099
4207 000 000	WT . PR800H . R	1,391.00	119	5042 500 000	WT . C0400	1,700.00	101
4207 300 000	WT . PR800 . R	1,339.00	119	5042 800 000	WT . C0400H	1,700.00	101
4228 000 000	WT . MC450H	1,236.00	104	5052 000 000	WT . RS400	1,545.00	099
4230 000 000	WT . MC800H	1,442.00	104	5054 000 000	WT . RS450	1,648.00	100
4231 000 000	WT . MC800H . L	1,442.00	105				

Article index

Article	Name	Price in US \$	Page	Article	Name	Price in US \$	Page
Washplaces				5168 511 000	WP . F08	4,532.00	132
5139 620 611	Unit . SR1	1,700.00	137	5168 513 000	WP . F08	4,532.00	132
5139 620 620	Unit . SR1	1,700.00	137	5168 514 000	WP . F08	4,532.00	132
5139 620 621	Unit . SR1	1,700.00	137	5168 516 000	WP . F08	4,300.00	132
5141 620 611	Unit . SR3	1,803.00	138	5168 810 000	WP . F07	4,532.00	132
5141 620 620	Unit . SR3	1,803.00	138	5168 811 000	WP . F07	4,532.00	132
5141 620 621	Unit . SR3	1,803.00	138	5168 813 000	WP . F07	4,532.00	132
5143 620 611	Unit . SR5	1,957.00	139	5168 814 000	WP . F07	4,532.00	132
5143 620 620	Unit . SR5	1,957.00	139	5168 816 000	WP . F07	4,300.00	132
5143 620 621	Unit . SR5	1,957.00	139	5169 510 000	WP . F010	4,532.00	133
5147 620 611	Unit . SR2	1,700.00	137	5169 511 000	WP . F010	4,532.00	133
5147 620 620	Unit . SR2	1,700.00	137	5169 513 000	WP . F010	4,532.00	133
5147 620 621	Unit . SR2	1,700.00	137	5169 514 000	WP . F010	4,532.00	133
5149 620 611	Unit . SR4	1,803.00	138	5169 516 000	WP . F010	4,300.00	133
5149 620 620	Unit . SR4	1,803.00	138	5169 810 000	WP . F09	4,532.00	133
5149 620 621	Unit . SR4	1,803.00	138	5169 811 000	WP . F09	4,532.00	133
5151 620 611	Unit . SR6	1,957.00	139	5169 813 000	WP . F09	4,532.00	133
5151 620 620	Unit . SR6	1,957.00	139	5169 814 000	WP . F09	4,532.00	133
5151 620 621	Unit . SR6	1,957.00	139	5169 816 000	WP . F09	4,300.00	133
5165 510 000	WP . F02	3,502.00	129	5171 510 000	WP . F012	2,266.00	128
5165 511 000	WP . F02	3,502.00	129	5171 511 000	WP . F012	2,266.00	128
5165 513 000	WP . F02	3,502.00	129	5171 513 000	WP . F012	2,266.00	128
5165 514 000	WP . F02	3,502.00	129	5171 514 000	WP . F012	2,266.00	128
5165 516 000	WP . F02	3,325.00	129	5171 516 000	WP . F012	2,150.00	128
5165 810 000	WP . F01	3,502.00	129	5171 810 000	WP . F011	2,266.00	128
5165 811 000	WP . F01	3,502.00	129	5171 811 000	WP . F011	2,266.00	128
5165 813 000	WP . F01	3,502.00	129	5171 813 000	WP . F011	2,266.00	128
5165 814 000	WP . F01	3,502.00	129	5171 814 000	WP . F011	2,266.00	128
5165 816 000	WP . F01	3,325.00	129	5171 816 000	WP . F011	2,150.00	128
5166 510 000	WP . F04	3,811.00	130	5245 000 000	WP . INSERT5	1,133.00	126
5166 511 000	WP . F04	3,811.00	130	5245 000 110	WP . INSERT5	1,133.00	126
5166 513 000	WP . F04	3,811.00	130	5256 000 000	WP . PN1	1,545.00	126
5166 514 000	WP . F04	3,811.00	130	5256 000 081	WP . PN1	1,675.00	126
5166 516 000	WP . F04	3,620.00	130	5256 000 083	WP . PN1	1,675.00	126
5166 810 000	WP . F03	3,811.00	130	5256 000 084	WP . PN1	1,675.00	126
5166 811 000	WP . F03	3,811.00	130	5257 000 000	WP . PN2	1,545.00	127
5166 813 000	WP . F03	3,811.00	130	5257 000 081	WP . PN2	1,675.00	127
5166 814 000	WP . F03	3,811.00	130	5257 000 083	WP . PN2	1,675.00	127
5166 816 000	WP . F03	3,620.00	130	5257 000 084	WP . PN2	1,675.00	127
5167 510 000	WP . F06	4,326.00	131	Bucket sinks			
5167 511 000	WP . F06	4,326.00	131	1201 000 000	AG . Stahlform 510Ü	261.00	141
5167 513 000	WP . F06	4,326.00	131	1205 000 180	AG . Stahlform 510Ü	353.00	141
5167 514 000	WP . F06	4,326.00	131	8902 000 980	UTENSILO	225.00	141
5167 516 000	WP . F06	4,110.00	131	Assist Shelves			
5167 810 000	WP . F05	4,326.00	131	8266 000 671	AS . Box1	77.00	145
5167 811 000	WP . F05	4,326.00	131	8267 000 671	AS . Box2	113.00	145
5167 813 000	WP . F05	4,326.00	131	8270 000 331	AS . 400 . S	220.00	144
5167 814 000	WP . F05	4,326.00	131	8270 000 980	AS . 400 . S	220.00	144
5167 816 000	WP . F05	4,110.00	131				
5168 510 000	WP . F08	4,532.00	132				

Article index

Article	Name	Price in US \$	Page	Article	Name	Price in US \$	Page
8270 000 981	AS . 400 . S	210.00	146	Accessories Folio			
8270 000 982	AS . 400 . S	210.00	146	6324 690 010	HS . F01250 . R	2,215.00	134
8270 221 331	AS . 400 . HT . L	291.00	145	6324 690 011	HS . F01250 . R	2,215.00	134
8270 221 980	AS . 400 . HT . L	291.00	145	6324 690 013	HS . F01250 . R	2,215.00	134
8270 321 331	AS . 400 . HT . R	291.00	145	6324 690 014	HS . F01250 . R	2,215.00	134
8270 321 980	AS . 400 . HT . R	291.00	145	6324 690 016	HS . F01250 . R	2,100.00	134
8271 000 331	AS . 600 . S	255.00	144	6324 990 010	HS . F01250 . L	2,215.00	134
8271 000 980	AS . 600 . S	255.00	144	6324 990 011	HS . F01250 . L	2,215.00	134
8271 140 331	AS . 600 . HT	291.00	144	6324 990 013	HS . F01250 . L	2,215.00	134
8271 140 980	AS . 600 . HT	291.00	144	6324 990 014	HS . F01250 . L	2,215.00	134
8272 000 331	AS . 800 . S	291.00	144	6324 990 016	HS . F01250 . L	2,100.00	134
8272 000 980	AS . 800 . S	291.00	144				
8274 111 981	AS . 134 . L02	192.00	146				
8274 111 982	AS . 134 . L02	192.00	146				
8274 112 981	AS . 225 . L03	204.00	146				
8274 112 982	AS . 225 . L03	204.00	146				
8274 170 981	AS . 160 . TPH	204.00	146				
8274 170 982	AS . 160 . TPH	204.00	146				

Accessories

8302 000 978	VT . 1	247.00	150
8309 000 000	VT . 2	237.00	150
8309 000 978	VT . 2	216.00	150
8310 000 000	VT . 3	252.00	151
8310 000 978	VT . 3	232.00	151
8306 000 978	SI . 2	314.00	150
8312 000 331	SI . 3	310.00	150
8312 000 978	SI . 3	288.00	150
8312 000 980	SI . 3	310.00	150
8321 000 330	UR . 1	57.00	151
8321 000 331	UR . 1	45.00	151
8321 000 980	UR . 1	45.00	151
9500 280 000	Overflow set B.1	29.00	151
9500 410 000	Overflow set C	15.00	151



WARNING:

Products listed in this price book can expose you to chemicals including Cobalt (II) Oxid, which is known to the State of California to cause cancer and birth defects or other reproductive harm.

For more information go to www.P65Warnings.ca.gov

Note:

- The basins and washstands are standard equipped with overflow (with some exceptions)

Alape installation overview

With regards to systematic variety, Alape's extensive range remains unsurpassed. It includes undermount, built-in, semi-recessed basins, sit-on and dish basins. These small, subtle differences allow Alape to set accents in bathroom design.

UB Undermount basins



Undermount

Classic undermounting variant. With its integrating character, it creates a harmonious overall impression at the washplace. Material-specific special sets are not required for assembly. It can be installed with all standard counter top materials and thicknesses.

EB Built-in basins

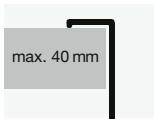

Drop-in

The most traditional and widespread installation solution. Distinctive edge defines the basin above the counter top. Assembly and sealing take place in a straightforward and fast manner using a polystyrene ring located on the basin edge, supplied adhesive, and in some cases additional mechanical bracket elements. It can be installed with all modern counter top materials up to a max. thickness of 40 mm.



Built-in basins with 3 mm edge

Filigree Alape special solution for basins with 3 mm wall thickness. As standard with the series, basin edge protrudes 25 mm and beyond. Sealing takes place with a sealing material to be chosen by the installer, which should be coordinated with the counter top in terms of color. It can be installed with all mineral-bound, 30 mm-thick counter top materials.

AB / SB Sit-on and dish basins

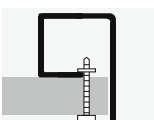

Traditional sit-on basins

Classic installation variant, lending the basin a dominant character at the washplace. Classic mechanical assembly using the supplied mounting set. It can be installed with all standard counter top materials from 12 to 40 mm thickness.

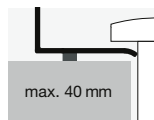

Sit-on basins with 3 mm edge

Filigree basin variant for the sit-on basin with a mere 3 mm-thick edge. A spacer ring under the basin underscores the filigree shape and simplifies cleaning. Mounting is straightforward thanks to the supplied shaft valve that can be adjusted to the counter thickness. It can be installed with all standard counter top materials from 12 to 40 mm thickness.

Glazed steel:
A material with many advantages.

With “A” form”, we have gone from producing wash jugs, pitchers and bowls over 125 years ago to one of the most diverse ranges of basins and washstands in the industry.

Besides the vast range of variants with regard to design and assembly, our basins and washstands made from glazed steel offer further benefits resulting from the material. In day-to-day use, you benefit from these positive characteristics.



Surface Glazed Steel

In the glaze firing, an almost pore-free surface of glass-smooth quality is created, on which neither microorganisms nor dirt particles can find a hold. In addition, the surface does not become statically charged and does not attract dust. This makes our surfaces very easy to care for and hygienic.

The new Alape ProShield surface : additional protection against bacteria and fungi

The surface of the glazed steel frees itself from bacteria and fungi thanks to the addition of silver ions. It acts like a protective shield. Our white basins and washstands are equipped with the ProShield surface as standard.

Resistant to impacts, scratches and abrasions

The glaze, a wafer-thin skin up to a maximum of 300 µm, is immune to external influences. Thin and robust, the glaze deals with the day-to-day household challenges thanks to its innate resistance. Therefore, it is a rare occurrence for scratch marks, abrasions or flaking to arise.

Colorfast and resistant to UV light

Our basin and washstand colors do not fade, regardless of how intensive your shade of color is. This is due to the specific pigments in the glaze, which do not adopt their final color until the firing process. After this, the glaze is perfectly protected against all types of influences.



Stable shape

Our basins and washstands enjoy a tolerance of +2/-0 millimeters. With intricate manufacturing from the titanium reinforced steel and fired at 830 degrees Celsius, Alape basins always retain their shape and withstand external influences such as varying temperatures and mechanical loads.

Lightness

Traditionally, our basins and washstands have wall thicknesses between 1.5 and 3 millimetres. Therefore, they are significantly lighter than equivalent products made from other materials.

Resistant to heat and cold

The glaze is fired into the steel at 830 degrees Celsius and withstands temperature differences of between -60 and +450 degrees Celsius. Even temperature shocks, in other words sudden effects of heat and cold, cannot harm the material.

Resistant to acids and chemicals

Our glazing has the same acid resistance as glass, meaning that hydrofluoric acid could damage the surface long-term. This is based upon glass-forming oxides, which fuse with the steel during the firing process as a protective coating.



Made-to-measure washplaces

Regardless of the construction task at hand, we can adjust our products to meet a project's requirements above and beyond the series standard in terms of color, dimensions and functionality. Our washstands can practically be freely configured with respect to width, depth and height. Because of their structural design, functional elements such as waste bins, lotion dispensers, tissue holders, and towel bars can be integrated as needed.

We are pleased to undertake made-to-measure manufacturing for niches. We can provide washplaces for tight or complex blueprints or oblique sections and notches in the washstand. Even in the case of custom specifications, our basins and washstands always retain their precision with a dimension tolerance of a mere $+2/-0$ millimeter.

Whether it is an extremely small space, hotel bathroom, semi-public restroom or spa area, our abilities go beyond basins and washstands. We are able to integrate countertops and furniture pieces, whether utilizing a single or multiple sinks in a design.

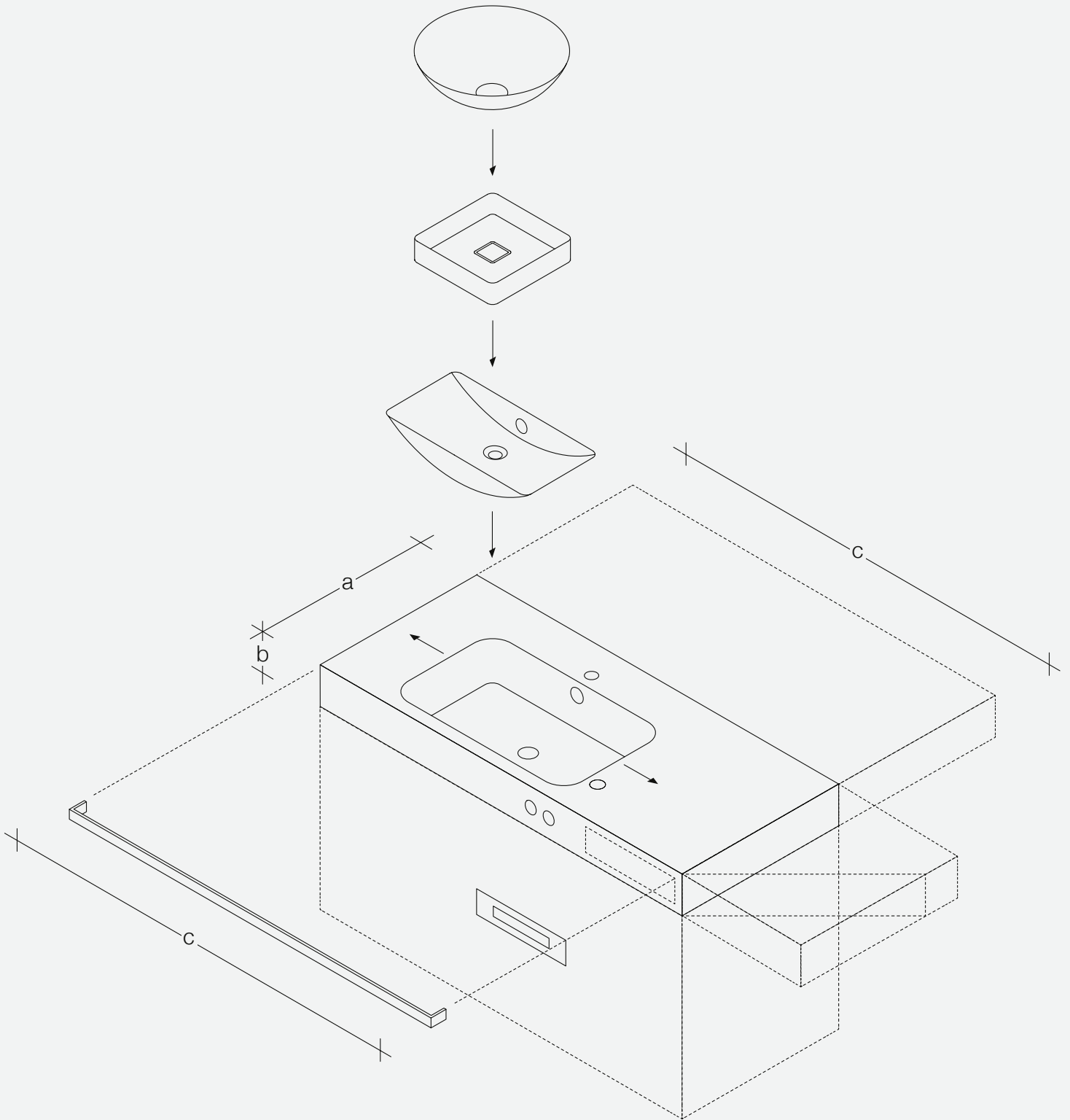

Individualization in detail

Project-specific solutions for built-in basins

The edge height can be set variably on built-in basins made from 3 mm glazed steel. The standard here is 25 millimetre edge height above the counter top; however, other overhangs can be set with equally exact precision and stress the basin's filigree shape.

Custom-made products

Sit-on basins can be adjusted to meet project-specific requirements in terms of external height and width dimension; this applies to washstands in terms of depth, width and height.

Drill holes

We can provide custom drill holes in basins and washstands in line with a specification. Not only the bore hole's diameter can be varied, but also its position on the washstand or tap area. Additional drill holes can be integrated upon request and adjusted in terms of position and diameter.

Functional integration

The design-related benefits of glazed steel enable additional functions to be integrated on a straightforward basis. For example, tissue dispensers can be integrated into washstands or towel holders assembled onto them.

Notches and oblique sections

In complex room situations, washplaces can be implemented often only with made-to-measure products. Through oblique sections, or making notches in corners, we are able to adjust washstands to the exact millimeter. Therefore, we are able to react quickly to such planning challenges. We can also manufacture fixtures according to your specifications.



**Custom engraving and free colour choice**

Logos or lettering can be engraved to achieve your own custom branding. Our laser engraving, done in the top most layer of glaze, is discreet and long-lasting. We can accommodate custom color requests according to RAL in quantities of ten or more. According to your specification, our production department can create color samples from glazed steel for you to choose from and approve.

Adjusting semi-recessed basins

To guarantee a harmonious overall appearance, semi built-in basins can be coordinated precisely in terms of their inner radius to suit the radius of the counter top material. Furthermore, the front skirt's height can be varied.



Faucet and drill hole information



Faucets with a vertical outlet and aerator provide the optimum flow of water onto the surface below (angle of impact: 90°). We ensure here that the outlet on the stand or wall faucets aligns with the vent in the basin, and that water does not impact to the left or right of the valve cap in the basin. To minimize splashing we also recommend to use a flow restrictor of maximum 7,5l/min. or to reduce the water pressure to maximum 4,5 bar.

In regard to the mounting height of a wall outlet faucet, please adhere to the respective instructions or recommendations of the manufacturer. The distance between the top edge of the basin and bottom edge of the outlet is normally between 140 to 200 mm.

Please refer to the price list in the product descriptions for information on the optimum water impact area on the basin mould.

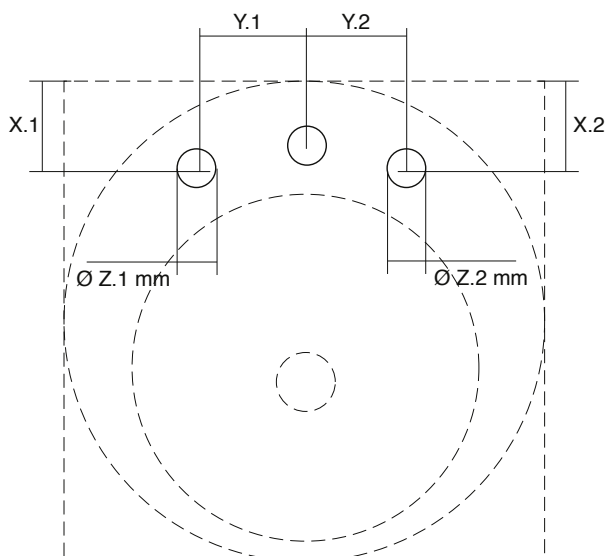

The standard dimensions for tap drill holes is 36 mm according to EN 111. The hole spacing is 100 mm.

All special versions, such as tap hole variants of series products as well as three-hole and lotion dispenser drillings are available on request.

Pricing / Technical Information

Alape website

For comprehensive information on our A™form product range, please visit the www.alape.com. All product documentation and tender specifications planning data are available for download. Use this database to make product specifications quickly and directly.

www.alape.com



















2021 USA/Canada, MSRP in US \$, Prices effective as of June 1, 2021
Dimensions shown in inches

Undermount basins

UB



Undermount basin
UB . K450
ø 16 1/8 x 6 1/4"

Basin width				
12 3/4 – 16 3/4"	17 3/4 – 23"	23 5/8 – 27 1/2"	29 1/2 – 39 3/8"	
 <p>UB . K325 Basin ø 11 1/8" Page 22</p>	 <p>UB . K450 Basin ø 16 1/8" Page 23</p>			Round
 <p>UB . K400 Basin ø 14 1/8" Page 22</p>	 <p>UB . S0450 . 1 Basin ø 18" Page 25</p>			
 <p>UB . KE325 Basin ø 12 1/2" Page 23</p>	 <p>UB . S0450 . 2 Basin ø 18" Page 25</p>			
 <p>UB . KE375 Basin ø 14 1/2" Page 24</p>				
 <p>UB . KE400 Basin ø 15 1/2" Page 24</p>				
 <p>UB . 0425 Basin 14 7/8 x 11 1/8" Page 26</p>	 <p>UB . 0525 Basin 18 7/8 x 15 1/8" Page 26</p>			Oval
	 <p>UB . Q450 Basin 14 5/8 x 14 5/8" Page 30</p>	 <p>UB . SR650 Basin 24 x 14 1/8" Page 29</p>	 <p>UB . ME750 Basin 29 5/8 x 14 7/8" Page 27</p>	Square and rectangular
	 <p>UB . ME500 Basin 19 7/8 x 14 7/8" Page 27</p>	 <p>UB . RE700 . 4 Basin 24 7/8 x 13" Page 30</p>	 <p>UB . R800 Basin 27 5/8 x 14 1/8" Page 29</p>	
	 <p>UB . R585 Basin 20 x 10 3/4" Page 28</p>		 <p>UB . ME1000 Basin 39 1/2 x 14 7/8" Page 28</p>	

Undermount basins – K-series, KE-series

All prices in US \$
Cut-out dimensions: Download www.alape.com

UB . K325

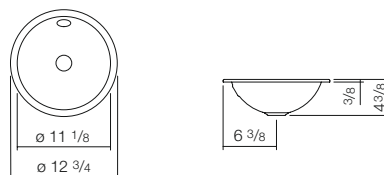

Undermount basin, round, Ø 11 1/8", height 4 3/8", glazed steel, without faucet hole, with overflow, included installation kit, overflow set



	Art.-No.	Price	Version	Surcharge
white, ProShield	2030 700 000	216.00	Without overflow	20 %
			Glossy, matte, special color	30 %

Faucet information

Impact area approx. 3 3/8 – 4 1/2" from rear edge of basin.
For parameters, see page 18.

Recommended article > s. p. 148

	Art.-No.	Price
Bottle trap, Sl.2	8306 000 978	314.00
Bottle trap, Sl.3	8312 000 978	288.00
Drain valve, VT.1	8302 000 978	247.00

UB . K400

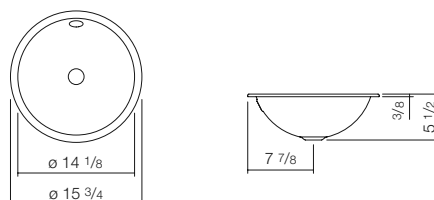

Undermount basin, round, Ø 14 1/8", height 5 1/2", glazed steel, without faucet hole, with overflow, included installation kit, overflow set



	Art.-No.	Price	Version	Surcharge
white, ProShield	2031 700 000	247.00	Without overflow	20 %
			Glossy, matte, special color	30 %

Faucet information

Impact area approx. 4 3/8 – 5 7/8" from rear edge of basin.
For parameters, see page 18.

Recommended article > s. p. 148

	Art.-No.	Price
Bottle trap, Sl.2	8306 000 978	314.00
Bottle trap, Sl.3	8312 000 978	288.00
Drain valve, VT.1	8302 000 978	247.00

Undermount basins – K-series, KE-series

All prices in US \$

Cut-out dimensions: Download www.alape.com

UB . K450



Undermount basin, round, Ø 16 1/8", height 6 1/4", glazed steel, without faucet hole, with overflow, included installation kit, overflow set

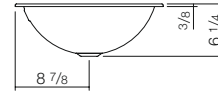
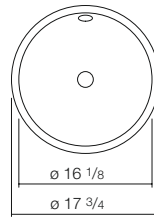

	Art.-No.	Price	Version	Surcharge
white, ProShield	2032 700 000	268.00	Without overflow	20 %
			Glossy, matte, special color	30 %

Faucet information

Impact area approx. 4 3/8 – 6 3/4" from rear edge of basin.
For parameters, see page 18.

Recommended article > s. p. 148

	Art.-No.	Price
Bottle trap, Sl.2	8306 000 978	314.00
Bottle trap, Sl.3	8312 000 978	288.00
Drain valve, VT.1	8302 000 978	247.00

UB . KE325



Undermount basin, round, Ø 12 1/2", height 4 1/8", glazed steel, without faucet hole, without overflow, included installation kit, drain valve, valve cap, chrome-plated

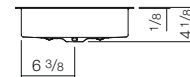
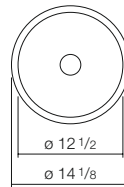

	Art.-No.	Price	Version	Surcharge
white, ProShield	3223 501 000	845.00	Glossy, matte, special color	30 %

Faucet information

Impact area approx. 4 – 5 3/8" from rear edge of basin.
For parameters, see page 18.

Recommended article > s. p. 148

	Art.-No.	Price
Bottle trap, Sl.2	8306 000 978	314.00
Bottle trap, Sl.3	8312 000 978	288.00

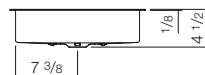
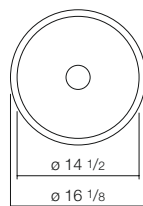
Undermount basins – KE-series (Unisono)**UB . KE375**

Undermount basin, round, Ø 14 1/2", height 4 1/2", glazed steel, without faucet hole, without overflow, included installation kit, drain valve, valve cap, chrome-plated



	Art.-No.	Price	Version	Surcharge
white, ProShield	3224 501 000	896.00	Glossy, matte, special color	30 %

Faucet information

Impact area approx. 4 5/8 – 6 3/8" from rear edge of basin.
For parameters, see page 18.

Recommended article > s. p. 148

	Art.-No.	Price
Bottle trap, Sl.2	8306 000 978	314.00
Bottle trap, Sl.3	8312 000 978	288.00

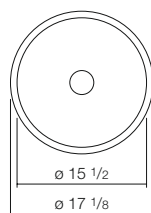
UB . KE400

Undermount basin, round, Ø 15 1/2", height 4 1/2", glazed steel, without faucet hole, without overflow, included installation kit, drain valve, valve cap, chrome-plated



	Art.-No.	Price	Version	Surcharge
white, ProShield	3225 501 000	948.00	Glossy, matte, special color	30 %

Faucet information

Impact area approx. 4 3/4 – 6 5/8" from rear edge of basin.
For parameters, see page 18.

Recommended article > s. p. 148

	Art.-No.	Price
Bottle trap, Sl.2	8306 000 978	314.00
Bottle trap, Sl.3	8312 000 978	288.00

Undermount basins – SO-series (Sondo)

All prices in US \$

Cut-out dimensions: Download www.alape.com

UB . S0450 . 1



Undermount basin, round, Ø 18", height 4 1/2", glazed steel, without faucet hole, without overflow, included installation kit, drain valve, valve cap, chrome-plated

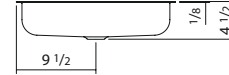
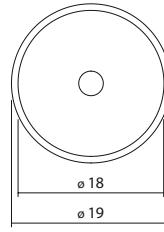

	Art.-No.	Price	Version	Surcharge
white, ProShield	3505 501 000	948.00	Glossy, matte, special color	30 %

Faucet information

Impact area approx. 3 – 7 3/8" from rear edge of basin.
For parameters, see page 18.

Recommended article > s. p. 148

	Art.-No.	Price
Bottle trap, Sl.2	8306 000 978	314.00
Bottle trap, Sl.3	8312 000 978	288.00

UB . S0450 . 2



Undermount basin, round, Ø 18", height 5 3/4", glazed steel, without faucet hole, without overflow, included installation kit, drain valve, valve cap, chrome-plated

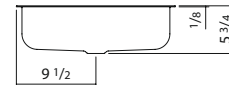
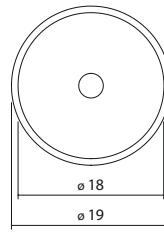

	Art.-No.	Price	Version	Surcharge
white, ProShield	3506 501 000	979.00	Glossy, matte, special color	30 %

Faucet information

Impact area approx. 3 – 7 3/8" from rear edge of basin.
For parameters, see page 18.

Recommended article > s. p. 148

	Art.-No.	Price
Bottle trap, Sl.2	8306 000 978	314.00
Bottle trap, Sl.3	8312 000 978	288.00

Undermount basins – O-series**UB . 0425**

Undermount basin, oval, wxhxd 14 7/8 x 4 3/8 x 11 1/8", glazed steel, without faucet hole, with overflow, included installation kit, overflow set

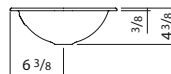
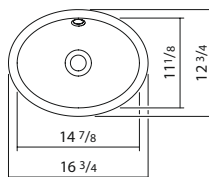

	Art.-No.	Price	Version	Surcharge
white, ProShield	2110 700 000	258.00	Without overflow	20 %
			Glossy, matte, special color	30 %

Faucet information

Impact area approx. 3 7/8 – 4 7/8" from rear edge of basin.
For parameters, see page 18.

Recommended article > s. p. 148

	Art.-No.	Price
Bottle trap, Sl.2	8306 000 978	314.00
Bottle trap, Sl.3	8312 000 978	288.00
Drain valve, VT.1	8302 000 978	247.00

UB . 0525

Undermount basin, oval, wxhxd 18 7/8 x 5 7/8 x 15 1/8", glazed steel, without faucet hole, with overflow, included installation kit, overflow set

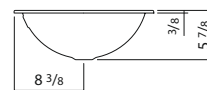
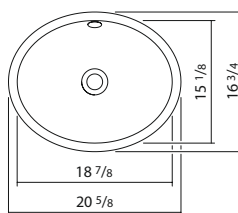

	Art.-No.	Price	Version	Surcharge
white, ProShield	2111 700 000	278.00	Without overflow	20 %
			Glossy, matte, special color	30 %

Faucet information

Impact area approx. 4 3/4 – 6 1/2" from rear edge of basin.
For parameters, see page 18.

Recommended article > s. p. 148

	Art.-No.	Price
Bottle trap, Sl.2	8306 000 978	314.00
Bottle trap, Sl.3	8312 000 978	288.00
Drain valve, VT.1	8302 000 978	247.00

Undermount basins – ME-series, R-series

All prices in US \$

Cut-out dimensions: Download www.alape.com

UB . ME500



Undermount basin, rectangular, wxhxd 19 7/8 x 4 3/8 x 14 7/8", glazed steel, without faucet hole, with overflow, included installation kit, overflow set

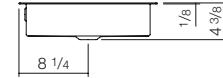
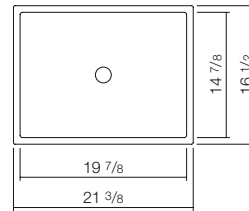

	Art.-No.	Price	Version	Surcharge
white, ProShield	3226 701 000	1,339.00	Without overflow	20 %
			Glossy, matte, special color	30 %

Faucet information

Impact area approx. 4 3/8 – 6 1/8" from rear edge of basin.
For parameters, see page 18.

Recommended article > s. p. 148

	Art.-No.	Price
Bottle trap, Sl.2	8306 000 978	314.00
Bottle trap, Sl.3	8312 000 978	288.00
Drain valve, VT.1	8302 000 978	247.00

UB . ME750



Undermount basin, rectangular, wxhxd 29 5/8 x 4 3/8 x 14 7/8", glazed steel, without faucet hole, with overflow, included installation kit, overflow set

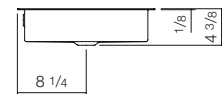
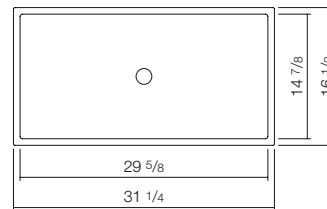

	Art.-No.	Price	Version	Surcharge
white, ProShield	3227 701 000	1,442.00	Without overflow	20 %
			Glossy, matte, special color	30 %

Faucet information

Impact area approx. 4 3/8 – 6 1/8" from rear edge of basin.
For parameters, see page 18.

Recommended article > s. p. 148

	Art.-No.	Price
Bottle trap, Sl.2	8306 000 978	314.00
Bottle trap, Sl.3	8312 000 978	288.00
Drain valve, VT.1	8302 000 978	247.00

Undermount basins – ME-series, R-series

All prices in US \$
Cut-out dimensions: Download www.alape.com

UB . ME1000

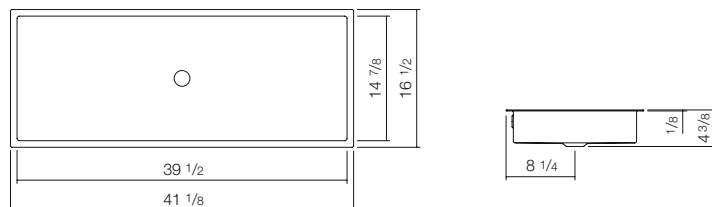

Undermount basin, rectangular, wxhxd 39 1/2 x 4 3/8 x 14 7/8", glazed steel, without faucet hole, with overflow, included installation kit, overflow set



	Art.-No.	Price	Version	Surcharge
white, ProShield	3228 701 000	1,751.00	Without overflow	20 %
			Glossy, matte, special color	30 %

Faucet information

Impact area approx. 4 3/8 – 6 1/8" from rear edge of basin.
For parameters, see page 18.

Recommended article > s. p. 148

	Art.-No.	Price
Bottle trap, Sl.2	8306 000 978	314.00
Bottle trap, Sl.3	8312 000 978	288.00
Drain valve, VT.1	8302 000 978	247.00

UB . R585

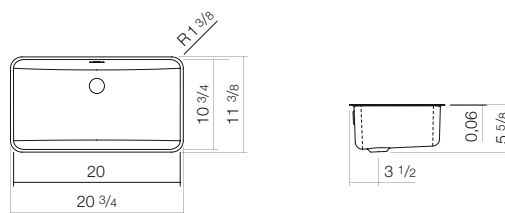

Undermount basin, rectangular, wxhxd 20 x 5 5/8 x 10 3/4", glazed steel, without faucet hole, with overflow, included installation kit, overflow set



	Art.-No.	Price	Version	Surcharge
white, ProShield	2250 700 000	412.00	Without overflow	20 %
			Glossy, matte, special color	30 %

Faucet information

Impact area approx. 5 1/4 – 6" from rear edge of basin.
For parameters, see page 18.

Recommended article > s. p. 148

	Art.-No.	Price
Bottle trap, Sl.2	8306 000 978	314.00
Bottle trap, Sl.3	8312 000 978	288.00
Drain valve, VT.1	8302 000 978	247.00

Undermount basins – R-series, SR-series

All prices in US \$

Cut-out dimensions: Download www.alape.com

UB . R800



Undermount basin, rectangular, wxhxd 27 5/8 x 4 3/4 x 14 1/8", glazed steel, without faucet hole, with overflow, included installation kit, overflow set

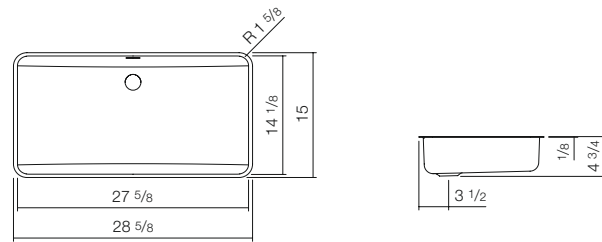

	Art.-No.	Price	Version	Surcharge
white, ProShield	2251 700 000	824.00	Without overflow	20 %
			Glossy, matte, special color	30 %

Faucet information

Impact area approx. 5 3/4 – 7 7/8" from rear edge of basin.
For parameters, see page 18.

Recommended article > s. p. 148

	Art.-No.	Price
Bottle trap, Sl.2	8306 000 978	314.00
Bottle trap, Sl.3	8312 000 978	288.00
Drain valve, VT.1	8302 000 978	247.00

UB . SR650



Undermount basin, rectangular, wxhxd 24 x 5 x 14 1/8", glazed steel, without faucet hole, with overflow, included installation kit, overflow set

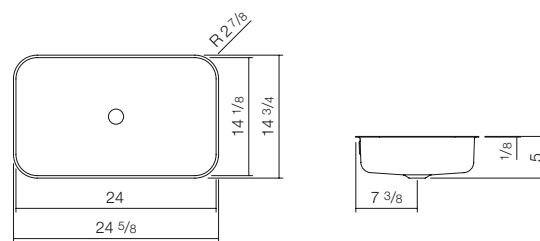

	Art.-No.	Price	Version	Surcharge
white, ProShield	2255 700 000	618.00	Without overflow	20 %
			Glossy, matte, special color	30 %

Faucet information

Impact area approx. 2 3/4 – 4 3/4" from rear edge of basin.
For parameters, see page 18.

Recommended article > s. p. 148

	Art.-No.	Price
Bottle trap, Sl.2	8306 000 978	314.00
Bottle trap, Sl.3	8312 000 978	288.00
Drain valve, VT.1	8302 000 978	247.00

Undermount basins – RE-series, Q-series**UB . RE700 . 4**

Undermount basin, rectangular, wxhxd 24 7/8 x 3 1/2 x 13", glazed steel, without faucet hole, without overflow, included installation kit, drain valve, valve cap, white glazed

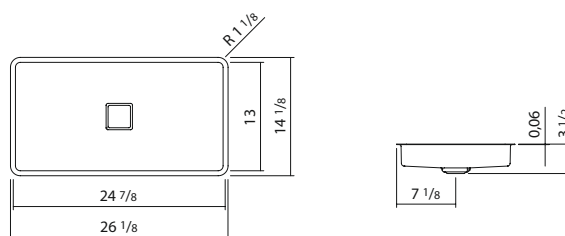

	Art.-No.	Price	Version	Surcharge
white, ProShield	2258 500 000	773.00	Glossy, matte, special color	30 %

Faucet information

Impact area approx. 3 3/8 – 4 3/4" from rear edge of basin.
For parameters, see page 18.

Recommended article > s. p. 148

	Art.-No.	Price
Bottle trap, Sl.2	8306 000 978	314.00
Bottle trap, Sl.3	8312 000 978	288.00

UB . Q450

Undermount basin, square, wxhxd 14 5/8 x 3 5/8 x 14 5/8", glazed steel, without faucet hole, without overflow, included installation kit, drain valve, valve cap, white glazed

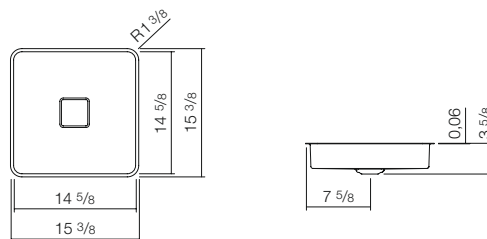

	Art.-No.	Price	Version	Surcharge
white, ProShield	2312 500 000	649.00	Glossy, matte, special color	30 %

Faucet information

Impact area approx. 3 3/8 – 5 1/2" from rear edge of basin.
For parameters, see page 18.

Recommended article > s. p. 148

	Art.-No.	Price
Bottle trap, Sl.2	8306 000 978	314.00
Bottle trap, Sl.3	8312 000 978	288.00































Undermount basin
UB . 0425
14 5/8 x 4 3/8 x 10 3/4"

Built-in basins

EB



Built-in basin
EB . R585H
23 x 5 ⁵/₈ x 16"

Basin width				
12 3/4 – 16 3/4"	17 3/4 – 23"	23 5/8 – 27 1/2"	29 1/2 – 31 1/2"	
 <p>EB . K325 ø 12 3/4" I.P. 37</p>  <p>EB . K400 ø 15 3/4" I.P. 39</p>  <p>EB . K400H ø 15 3/4" I.P. 38</p>  <p>EB . KE325 ø 12 3/4" I.P. 42</p>  <p>EB . KE375 ø 14 3/4" I.P. 42</p>  <p>EB . KE400 ø 15 3/4" I.P. 43</p>	 <p>EB . K450 ø 17 3/4" I.P. 41</p>  <p>EB . K450H ø 17 3/4" I.P. 40</p>  <p>EB . S450H ø 17 3/4" I.P. 36</p>  <p>HB . S450H ø 17 3/4" I.P. 57</p>  <p>EW 3/EW 3.2 ø 18 3/4" I.P. 34/35</p>			Round
 <p>EB . 0425 16 3/4 x 12 3/4" I.P. 44</p>	 <p>EB . 0525 20 5/8 x 16 3/4" I.P. 46</p>  <p>EB . 0500H 19 5/8 x 15 3/4" I.P. 45</p>	 <p>EB . 0600H 23 5/8 x 19 5/8" I.P. 47</p>		Oval
	 <p>EB . Q450 17 3/4 x 17 3/4" I.P. 56</p>  <p>EB . Q450H 17 3/4 x 19 5/8" I.P. 56</p>  <p>EB . ME500 19 5/8 x 14 3/4" I.P. 48</p>  <p>EB . R585 23 x 13 5/8" I.P. 52</p>  <p>EB . R585H 23 x 16" I.P. 51</p>  <p>HB . R585H 23 x 16" I.P. 57</p>	 <p>EB . SR650 25 5/8 x 16 3/8" I.P. 50</p>  <p>EB . SR650H 25 5/8 x 18 5/8" I.P. 49</p>  <p>EB . RE700H . 2 27 1/2 x 18 1/8" I.P. 55</p>  <p>EB . RE700 . 4 27 1/2 x 15 5/8" I.P. 55</p>	 <p>EB . ME750 29 1/2 x 14 3/4" I.P. 48</p>  <p>EB . R800 31 1/2 x 17 3/4" I.P. 54</p>  <p>EB . R800H 31 1/2 x 19 5/8" I.P. 53</p>	Square and rectangular

Built-in basins – EW-series

All prices in US \$

Cut-out dimensions: Download www.alape.com

EW 3



Built-in basin, round, Ø 18 3/4", height 7 3/8", glazed steel, with one faucet hole, with overflow, included installation kit, overflow set, PVC seal

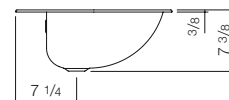
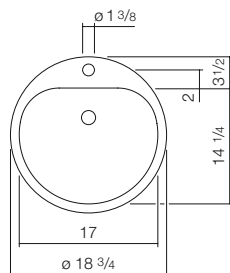

	Art.-No.	Price	Version	Surcharge
white, ProShield	2005 000 000	155.00	Without faucet hole	20 %
			3 Drill holes	20 %
			Drill hole for lotion dispenser	20 %
			Glossy, matte, special color	30 %

Faucet information

Impact area approx. 7 1/2 – 10 5/8" from middle faucet hole.
For parameters, see page 18.

Recommended article > s. p. 148

	Art.-No.	Price
Bottle trap, Sl.2	8306 000 978	314.00
Bottle trap, Sl.3	8312 000 978	288.00
Drain valve, VT.1	8302 000 978	247.00

EW 3



Built-in basin, round, Ø 18 3/4", height 7 3/8", glazed steel, with one faucet hole, without overflow, included installation kit, PVC seal

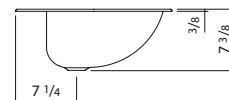
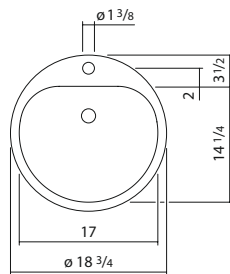

	Art.-No.	Price	Version	Surcharge
white, ProShield	2005 100 000	155.00	Without faucet hole	20 %
			3 Drill holes	20 %
			Drill hole for lotion dispenser	20 %
			Glossy, matte, special color	30 %

Faucet information

Impact area approx. 7 1/2 – 10 5/8" from middle faucet hole.
For parameters, see page 18.

Recommended article > s. p. 148

	Art.-No.	Price
Bottle trap, Sl.2	8306 000 978	314.00
Bottle trap, Sl.3	8312 000 978	288.00
Drain valve, VT.3	8310 000 000	252.00

Built-in basins – EW-series**EW 3.2**

Built-in basin, round, Ø 18 3/4", height 7 3/8", glazed steel, with one faucet hole, with overflow, included installation kit, overflow set

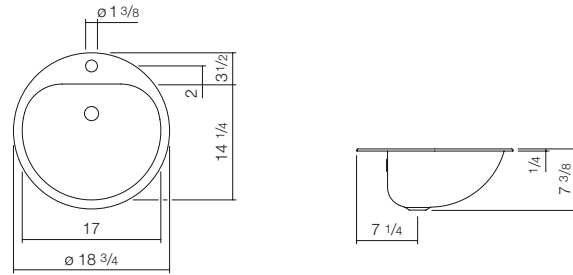

	Art.-No.	Price	Version	Surcharge
white, ProShield	2018 000 000	227.00	Without faucet hole	20 %
			3 Drill holes	20 %
			Drill hole for lotion dispenser	20 %
			Glossy, matte, special color	30 %

Faucet information

Impact area approx. 7 1/2 – 10 5/8" from middle faucet hole.
For parameters, see page 18.

Recommended article > s. p. 148

Art.-No.	Price
Bottle trap, Sl.2	8306 000 978 314.00
Bottle trap, Sl.3	8312 000 978 288.00
Drain valve, VT.1	8302 000 978 247.00

EW 3.2

Built-in basin, round, Ø 18 3/4", height 7 3/8", glazed steel, with one faucet hole, without overflow, included installation kit

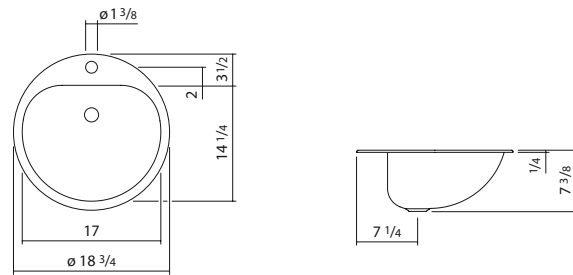

	Art.-No.	Price	Version	Surcharge
white, ProShield	2018 100 000	227.00	Without faucet hole	20 %
			3 Drill holes	20 %
			Drill hole for lotion dispenser	20 %
			Glossy, matte, special color	30 %

Faucet information

Impact area approx. 7 1/2 – 10 5/8" from middle faucet hole.
For parameters, see page 18.

Recommended article > s. p. 148

Art.-No.	Price
Bottle trap, Sl.2	8306 000 978 314.00
Bottle trap, Sl.3	8312 000 978 288.00
Drain valve, VT.3	8310 000 000 252.00

Built-in basins – S-series

All prices in US \$

Cut-out dimensions: Download www.alape.com**EB . S450H**

Built-in basin, round, Ø 17 3/4", height 6 3/8", glazed steel, with one faucet hole, with overflow, included installation kit, overflow set

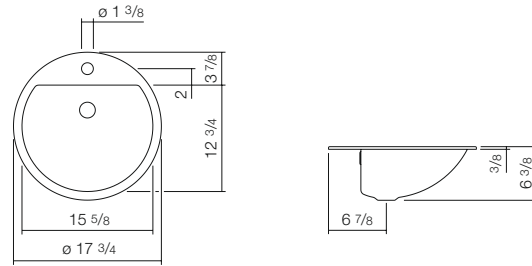

	Art.-No.	Price	Version	Surcharge
white, ProShield	2406 000 000	330.00	Without faucet hole	20 %
			3 Drill holes	20 %
			Drill hole for lotion dispenser	20 %
			Glossy, matte, special color	30 %

Faucet information

Impact area approx. 6 3/4 – 8 1/4" from middle faucet hole.
For parameters, see page 18.

Recommended article > s. p. 148

	Art.-No.	Price
Bottle trap, Sl.2	8306 000 978	314.00
Bottle trap, Sl.3	8312 000 978	288.00
Drain valve, VT.1	8302 000 978	247.00

EB . S450H

Built-in basin, round, Ø 17 3/4", height 6 3/8", glazed steel, with one faucet hole, without overflow, included installation kit

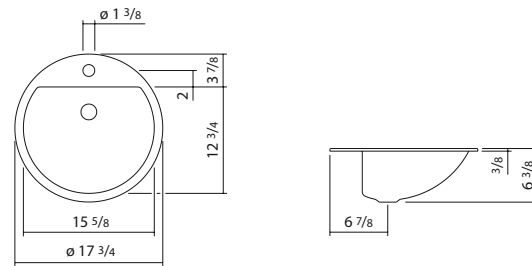

	Art.-No.	Price	Version	Surcharge
white, ProShield	2406 100 000	330.00	Without faucet hole	20 %
			3 Drill holes	20 %
			Drill hole for lotion dispenser	20 %
			Glossy, matte, special color	30 %

Faucet information

Impact area approx. 6 3/4 – 8 1/4" from middle faucet hole.
For parameters, see page 18.

Recommended article > s. p. 148

	Art.-No.	Price
Bottle trap, Sl.2	8306 000 978	314.00
Bottle trap, Sl.3	8312 000 978	288.00
Drain valve, VT.3	8310 000 000	252.00

Built-in basins – K-series**EB . K325**

Built-in basin, round, Ø 12 3/4", height 4 1/4", glazed steel, without faucet hole, with overflow, included installation kit, overflow set

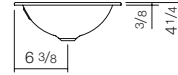
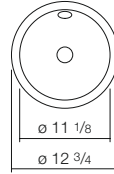

	Art.-No.	Price	Version	Surcharge
white, ProShield	2000 200 000	268.00	Glossy, matte, special color	30 %

Faucet information

Impact area approx. 3 3/8 – 4 1/2" from rear edge of basin.
For parameters, see page 18.

Recommended article > s. p. 148

	Art.-No.	Price
Bottle trap, Sl.2	8306 000 978	314.00
Bottle trap, Sl.3	8312 000 978	288.00
Drain valve, VT.1	8302 000 978	247.00

EB . K325

Built-in basin, round, Ø 12 3/4", height 4 1/4", glazed steel, without faucet hole, without overflow, included installation kit

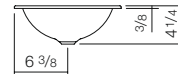
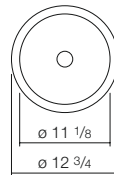

	Art.-No.	Price	Version	Surcharge
white, ProShield	2000 000 000	268.00	Glossy, matte, special color	30 %

Faucet information

Impact area approx. 3 3/8 – 4 1/2" from rear edge of basin.
For parameters, see page 18.

Recommended article > s. p. 148

	Art.-No.	Price
Bottle trap, Sl.2	8306 000 978	314.00
Bottle trap, Sl.3	8312 000 978	288.00
Drain valve, VT.2	8309 000 000	237.00

Built-in basins – K-series**EB . K400H**

Built-in basin, round, Ø 15 3/4", height 4 1/4", glazed steel, with one faucet hole, with overflow, included installation kit, overflow set

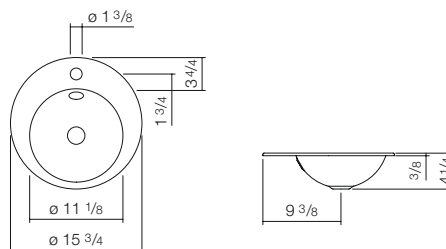

	Art.-No.	Price	Version	Surcharge
white, ProShield	2003 200 000	340.00	Without faucet hole	20 %
			3 Drill holes	20 %
			Drill hole for lotion dispenser	20 %
			Glossy, matte, special color	30 %

Faucet information

Impact area approx. 4 3/8 – 5 1/2" from middle faucet hole.
For parameters, see page 18.

Recommended article > s. p. 148

	Art.-No.	Price
Bottle trap, Sl.2	8306 000 978	314.00
Bottle trap, Sl.3	8312 000 978	288.00
Drain valve, VT.1	8302 000 978	247.00

EB . K400H

Built-in basin, round, Ø 15 3/4", height 4 1/4", glazed steel, with one faucet hole, without overflow, included installation kit

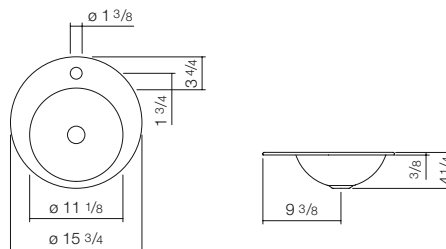

	Art.-No.	Price	Version	Surcharge
white, ProShield	2003 000 000	340.00	Without faucet hole	20 %
			3 Drill holes	20 %
			Drill hole for lotion dispenser	20 %
			Glossy, matte, special color	30 %

Faucet information

Impact area approx. 4 3/8 – 5 1/2" from middle faucet hole.
For parameters, see page 18.

Recommended article > s. p. 148

	Art.-No.	Price
Bottle trap, Sl.2	8306 000 978	314.00
Bottle trap, Sl.3	8312 000 978	288.00
Drain valve, VT.2	8309 000 000	237.00

Built-in basins – K-series**EB . K400**

Built-in basin, round, Ø 15 3/4", height 5 1/2", glazed steel, without faucet hole, with overflow, included installation kit, overflow set

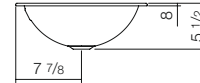
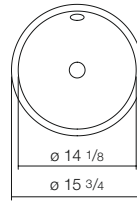

	Art.-No.	Price	Version	Surcharge
white, ProShield	2001 000 000	299.00	Glossy, matte, special color	30 %

Faucet information

Impact area approx. 4 3/8" – 5 7/8" from rear edge of basin.
For parameters, see page 18.

Recommended article > s. p. 148

	Art.-No.	Price
Bottle trap, Sl.2	8306 000 978	314.00
Bottle trap, Sl.3	8312 000 978	288.00
Drain valve, VT.1	8302 000 978	247.00

EB . K400

Built-in basin, round, Ø 15 3/4", height 5 1/2", glazed steel, without faucet hole, without overflow, included installation kit

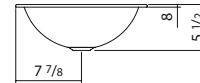
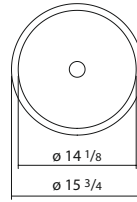

	Art.-No.	Price	Version	Surcharge
white, ProShield	2001 100 000	299.00	Glossy, matte, special color	30 %

Faucet information

Impact area approx. 4 3/8" – 5 7/8" from rear edge of basin.
For parameters, see page 18.

Recommended article > s. p. 148

	Art.-No.	Price
Bottle trap, Sl.2	8306 000 978	314.00
Bottle trap, Sl.3	8312 000 978	288.00
Drain valve, VT.3	8305 000 000	0.00
Drain valve, VT.3	8310 000 000	252.00

Built-in basins – K-series

All prices in US \$

Cut-out dimensions: Download www.alape.com**EB . K450H**

Built-in basin, round, Ø 17 3/4", height 5 1/8", glazed steel, with one faucet hole, with overflow, included installation kit, overflow set

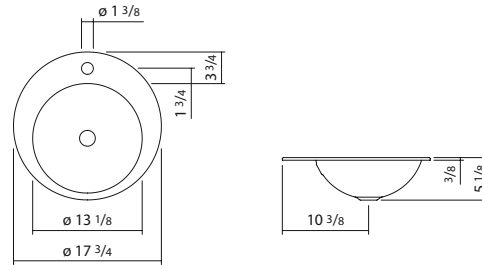

	Art.-No.	Price	Version	Surcharge
white, ProShield	2004 000 000	361.00	Without faucet hole	20 %
			3 Drill holes	20 %
			Drill hole for lotion dispenser	20 %
			Glossy, matte, special color	30 %

Faucet information

Impact area approx. 5 1/2 – 6 1/4" from middle faucet hole.
For parameters, see page 18.

Recommended article > s. p. 148

	Art.-No.	Price
Bottle trap, Sl.2	8306 000 978	314.00
Bottle trap, Sl.3	8312 000 978	288.00
Drain valve, VT.1	8302 000 978	247.00

EB . K450H

Built-in basin, round, Ø 17 3/4", height 5 1/8", glazed steel, with one faucet hole, without overflow, included installation kit

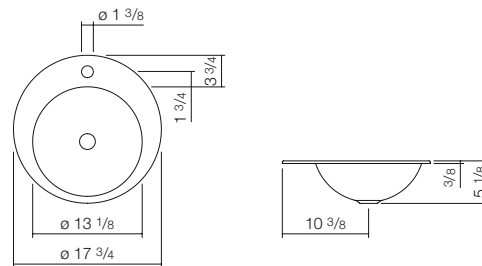

	Art.-No.	Price	Version	Surcharge
white, ProShield	2004 100 000	361.00	Without faucet hole	20 %
			3 Drill holes	20 %
			Drill hole for lotion dispenser	20 %
			Glossy, matte, special color	30 %

Faucet information

Impact area approx. 5 1/2 – 6 1/4" from middle faucet hole.
For parameters, see page 18.

Recommended article > s. p. 148

	Art.-No.	Price
Bottle trap, Sl.2	8306 000 978	314.00
Bottle trap, Sl.3	8312 000 978	288.00
Drain valve, VT.3	8310 000 000	252.00

Built-in basins – K-series**EB . K450**

Built-in basin, round, Ø 17 3/4", height 6 1/4", glazed steel, without faucet hole, with overflow, included installation kit, overflow set

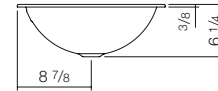
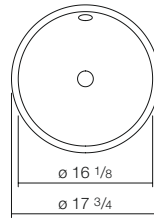

	Art.-No.	Price	Version	Surcharge
white, ProShield	2002 000 000	319.00	Glossy, matte, special color	30 %

Faucet information

Impact area approx. 4 3/8 – 6 3/4" from rear edge of basin.
For parameters, see page 18.

Recommended article > s. p. 148

	Art.-No.	Price
Bottle trap, Sl.2	8306 000 978	314.00
Bottle trap, Sl.3	8312 000 978	288.00
Drain valve, VT.1	8302 000 978	247.00

EB . K450

Built-in basin, round, Ø 17 3/4", height 6 1/4", glazed steel, without faucet hole, without overflow, included installation kit

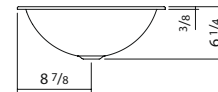
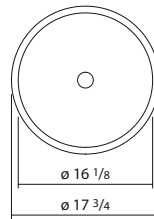

	Art.-No.	Price	Version	Surcharge
white, ProShield	2002 100 000	319.00	Glossy, matte, special color	30 %

Faucet information

Impact area approx. 4 3/8 – 6 3/4" from rear edge of basin.
For parameters, see page 18.

Recommended article > s. p. 148

	Art.-No.	Price
Bottle trap, Sl.2	8306 000 978	314.00
Bottle trap, Sl.3	8312 000 978	288.00
Drain valve, VT.3	8310 000 000	252.00

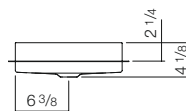
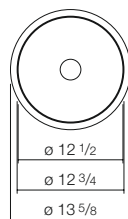
Built-in basins – KE-series (Unisono)**EB . KE325**

Built-in basin for 30mm thick counter tops, round, Ø 12 3/4", height 4 1/8", extending 1" over counter top, glazed steel, without faucet hole, without overflow, included installation kit, drain valve, valve cap, chrome-plated

	Art.-No.	Price	Version	Surcharge
white, ProShield	2023 503 000	896.00	Glossy, matte, special color	30 %

Faucet information

Impact area approx. 3 3/4 – 5 1/8" from rear edge of basin.
For parameters, see page 18.

Recommended article > s. p. 148

	Art.-No.	Price
Bottle trap, Sl.2	8306 000 978	314.00
Bottle trap, Sl.3	8312 000 978	288.00

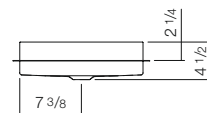
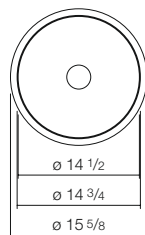
EB . KE375

Built-in basin for 30mm thick counter tops, round, Ø 14 3/4", height 4 1/2", extending 1" over counter top, glazed steel, without faucet hole, without overflow, included installation kit, drain valve, valve cap, chrome-plated

	Art.-No.	Price	Version	Surcharge
white, ProShield	2024 503 000	948.00	Glossy, matte, special color	30 %

Faucet information

Impact area approx. 4 3/8 – 6 1/8" from rear edge of basin.
For parameters, see page 18.

Recommended article > s. p. 148

	Art.-No.	Price
Bottle trap, Sl.2	8306 000 978	314.00
Bottle trap, Sl.3	8312 000 978	288.00

Built-in basins – KE-series (Unisono)**EB . KE400**

Built-in basin for 30mm thick counter tops, round, Ø 15 3/4", height 4 1/2", extending 1" over counter top, glazed steel, without faucet hole, without overflow, included installation kit, drain valve, valve cap, chrome-plated

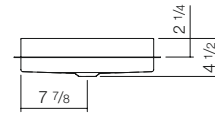
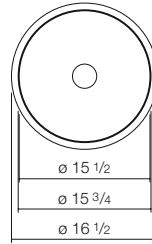

	Art.-No.	Price	Version	Surcharge
white, ProShield	2025 503 000	999.00	Glossy, matte, special color	30 %

Faucet information

Impact area approx. 4 1/2 – 6 1/4" from rear edge of basin.
For parameters, see page 18.

Recommended article > s. p. 148

	Art.-No.	Price
Bottle trap, Sl.2	8306 000 978	314.00
Bottle trap, Sl.3	8312 000 978	288.00

Built-in basins – O-series

All prices in US \$

Cut-out dimensions: Download www.alape.com**EB . 0425**

Built-in basin, oval, wxhxd 16 3/4 x 4 3/8 x 12 3/4", glazed steel, without faucet hole, with overflow, included installation kit, overflow set

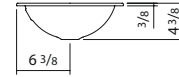
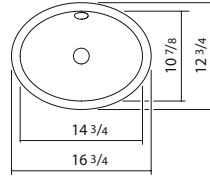

	Art.-No.	Price	Version	Surcharge
white, ProShield	2100 000 000	309.00	Glossy, matte, special color	30 %

Faucet information

Impact area approx. 3 7/8 – 4 7/8" from rear edge of basin.
For parameters, see page 18.

Recommended article > s. p. 148

	Art.-No.	Price
Bottle trap, Sl.2	8306 000 978	314.00
Bottle trap, Sl.3	8312 000 978	288.00
Drain valve, VT.1	8302 000 978	247.00

EB . 0425

Built-in basin, oval, wxhxd 16 3/4 x 4 3/8 x 12 3/4", glazed steel, without faucet hole, without overflow, included installation kit

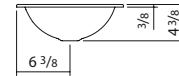
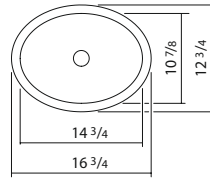

	Art.-No.	Price	Version	Surcharge
white, ProShield	2100 100 000	309.00	Glossy, matte, special color	30 %

Faucet information

Impact area approx. 3 7/8 – 4 7/8" from rear edge of basin.
For parameters, see page 18.

Recommended article > s. p. 148

	Art.-No.	Price
Bottle trap, Sl.2	8306 000 978	314.00
Bottle trap, Sl.3	8312 000 978	288.00
Drain valve, VT.2	8309 000 000	237.00

Built-in basins – O-series**EB . 0500H**

Built-in basin, oval, wxhxd 19 5/8 x 4 3/8 x 15 3/4", glazed steel, with one faucet hole, with overflow, included installation kit, overflow set

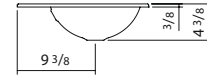
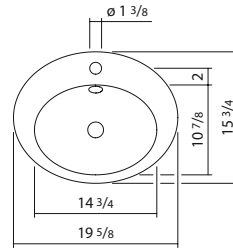

	Art.-No.	Price	Version	Surcharge
white, ProShield	2102 000 000	350.00	Without faucet hole	20 %
			3 Drill holes	20 %
			Drill hole for lotion dispenser	20 %
			Glossy, matte, special color	30 %

Faucet information

Impact area approx. 4 3/4 – 5 1/2" from middle faucet hole.
For parameters, see page 18.

Recommended article > s. p. 148

	Art.-No.	Price
Bottle trap, Sl.2	8306 000 978	314.00
Bottle trap, Sl.3	8312 000 978	288.00
Drain valve, VT.1	8302 000 978	247.00

EB . 0500H

Built-in basin, oval, wxhxd 19 5/8 x 4 3/8 x 15 3/4", glazed steel, with one faucet hole, without overflow, included installation kit

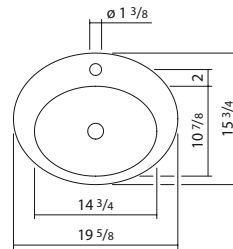

	Art.-No.	Price	Version	Surcharge
white, ProShield	2102 100 000	350.00	Without faucet hole	20 %
			3 Drill holes	20 %
			Drill hole for lotion dispenser	20 %
			Glossy, matte, special color	30 %

Faucet information

Impact area approx. 4 3/4 – 5 1/2" from middle faucet hole.
For parameters, see page 18.

Recommended article > s. p. 148

	Art.-No.	Price
Bottle trap, Sl.2	8306 000 978	314.00
Bottle trap, Sl.3	8312 000 978	288.00
Drain valve, VT.2	8309 000 000	237.00

Built-in basins – O-series

All prices in US \$

Cut-out dimensions: Download www.alape.com**EB . 0525**

Built-in basin, oval, wxhxd 20 5/8 x 5 7/8 x 16 3/4", glazed steel, without faucet hole, with overflow, included installation kit, overflow set

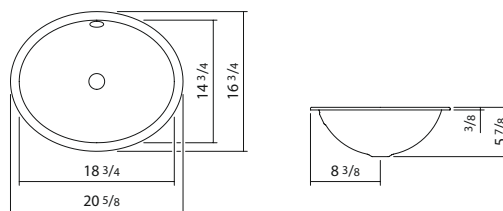

	Art.-No.	Price	Version	Surcharge
white, ProShield	2101 000 000	330.00	Glossy, matte, special color	30 %

Faucet information

Impact area approx. 4 3/4 – 6 1/2" from rear edge of basin.
For parameters, see page 18.

Recommended article > s. p. 148

	Art.-No.	Price
Bottle trap, Sl.2	8306 000 978	314.00
Bottle trap, Sl.3	8312 000 978	288.00
Drain valve, VT.1	8302 000 978	247.00

EB . 0525

Built-in basin, oval, wxhxd 20 5/8 x 5 7/8 x 16 3/4", glazed steel, without faucet hole, without overflow, included installation kit

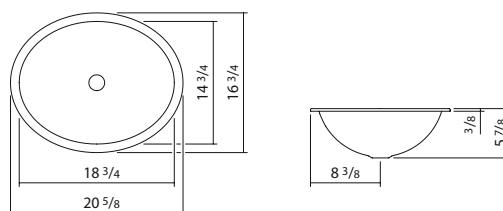

	Art.-No.	Price	Version	Surcharge
white, ProShield	2101 100 000	330.00	Glossy, matte, special color	30 %

Faucet information

Impact area approx. 4 3/4 – 6 1/2" from rear edge of basin.
For parameters, see page 18.

Recommended article > s. p. 148

	Art.-No.	Price
Bottle trap, Sl.2	8306 000 978	314.00
Bottle trap, Sl.3	8312 000 978	288.00
Drain valve, VT.3	8310 000 000	252.00

Built-in basins – O-series**EB .0600H**

Built-in basin, oval, wxhxd 23 5/8 x 5 7/8 x 19 5/8", glazed steel, with one faucet hole, with overflow, included installation kit, overflow set

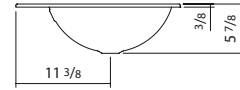
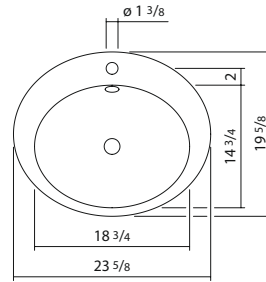

	Art.-No.	Price	Version	Surcharge
white, ProShield	2104 000 000	402.00	Without faucet hole	20 %
			3 Drill holes	20 %
			Drill hole for lotion dispenser	20 %
			Glossy, matte, special color	30 %

Faucet information

Impact area approx. 6 1/4 – 7 1/8" from middle faucet hole.
For parameters, see page 18.

Recommended article > s. p. 148

	Art.-No.	Price
Bottle trap, Sl.2	8306 000 978	314.00
Bottle trap, Sl.3	8312 000 978	288.00
Drain valve, VT.1	8302 000 978	247.00

EB .0600H

Built-in basin, oval, wxhxd 23 5/8 x 5 7/8 x 19 5/8", glazed steel, with one faucet hole, without overflow, included installation kit

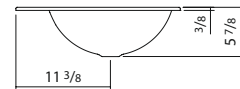
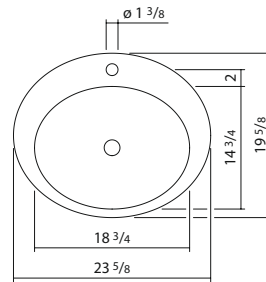

	Art.-No.	Price	Version	Surcharge
white, ProShield	2104 100 000	402.00	Without faucet hole	20 %
			3 Drill holes	20 %
			Drill hole for lotion dispenser	20 %
			Glossy, matte, special color	30 %

Faucet information

Impact area approx. 6 1/4 – 7 1/8" from middle faucet hole.
For parameters, see page 18.

Recommended article > s. p. 148

	Art.-No.	Price
Bottle trap, Sl.2	8306 000 978	314.00
Bottle trap, Sl.3	8312 000 978	288.00
Drain valve, VT.3	8310 000 000	252.00

Built-in basins – ME-series (Metaphor)**EB . ME500**

Built-in basin for 30mm thick counter tops, rectangular, wxhxd 19 5/8 x 4 3/8 x 14 3/4", extending 1" over counter top, glazed steel, without faucet hole, without overflow, included installation kit, drain valve, valve cap, chrome-plated

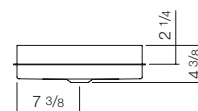
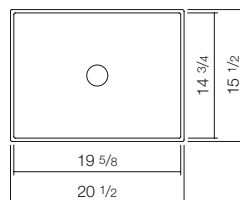

	Art.-No.	Price	Version	Surcharge
white, ProShield	2226 503 000	1,391.00	Glossy, matte, special color	30 %

Faucet information

Impact area approx. 3 7/8 – 5 3/4" from rear edge of basin.
For parameters, see page 18.

Recommended article > s. p. 148

	Art.-No.	Price
Bottle trap, Sl.2	8306 000 978	314.00
Bottle trap, Sl.3	8312 000 978	288.00

EB . ME750

Built-in basin for 30mm thick counter tops, rectangular, wxhxd 29 1/2 x 4 3/8 x 14 3/4", extending 1" over counter top, glazed steel, without faucet hole, without overflow, included installation kit, drain valve, valve cap, chrome-plated

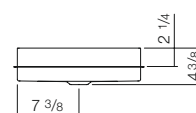
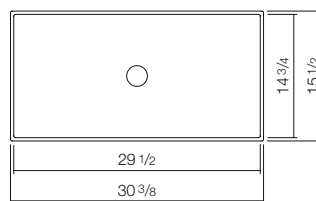

	Art.-No.	Price	Version	Surcharge
white, ProShield	2227 503 000	1,494.00	Glossy, matte, special color	30 %

Faucet information

Impact area approx. 3 7/8 – 5 3/4" from rear edge of basin.
For parameters, see page 18.

Recommended article > s. p. 148

	Art.-No.	Price
Bottle trap, Sl.2	8306 000 978	314.00
Bottle trap, Sl.3	8312 000 978	288.00

Built-in basins – SR-series (Stream)

All prices in US \$

Cut-out dimensions: Download www.alape.com

EB . SR650H



Built-in basin, rectangular, wxhxd 25 5/8 x 5 x 18 5/8", glazed steel, with one faucet hole, with overflow, included installation kit, overflow set

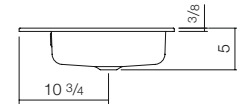
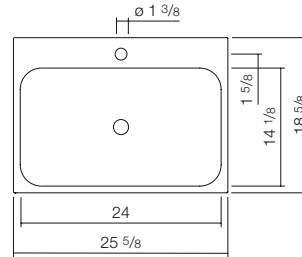

	Art.-No.	Price	Version	Surcharge
white, ProShield	2219 600 000	721.00	Without faucet hole	20 %
			3 Drill holes	20 %
			Drill hole for lotion dispenser	20 %
			Glossy, matte, special color	30 %

Faucet information

Impact area approx. 4 1/8 – 6 1/8" from middle faucet hole.
For parameters, see page 18.

Recommended article > s. p. 148

	Art.-No.	Price
Bottle trap, Sl.2	8306 000 978	314.00
Bottle trap, Sl.3	8312 000 978	288.00
Drain valve, VT.1	8302 000 978	247.00

EB . SR650H



Built-in basin, rectangular, wxhxd 25 5/8 x 5 x 18 5/8", glazed steel, with one faucet hole, without overflow, included installation kit

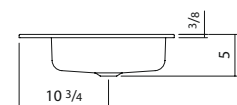
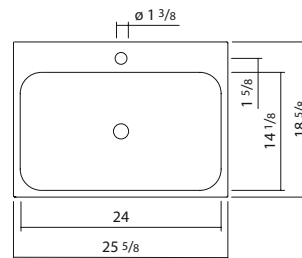

	Art.-No.	Price	Version	Surcharge
white, ProShield	2219 800 000	721.00	Without faucet hole	20 %
			3 Drill holes	20 %
			Drill hole for lotion dispenser	20 %
			Glossy, matte, special color	30 %

Faucet information

Impact area approx. 4 1/8 – 6 1/8" from middle faucet hole.
For parameters, see page 18.

Recommended article > s. p. 148

	Art.-No.	Price
Bottle trap, Sl.2	8306 000 978	314.00
Bottle trap, Sl.3	8312 000 978	288.00
Drain valve, VT.3	8310 000 000	252.00

Built-in basins – SR-series (Stream)

All prices in US \$

Cut-out dimensions: Download www.alape.com**EB . SR650**

Built-in basin, rectangular, wxhxd 25 5/8 x 5 x 16 3/8", glazed steel, without faucet hole, with overflow, included installation kit, overflow set

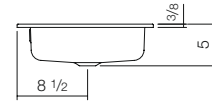
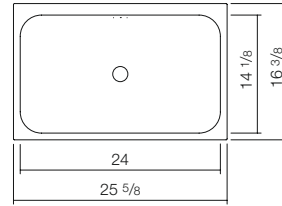

	Art.-No.	Price	Version	Surcharge
white, ProShield	2218 700 000	670.00	Glossy, matte, special color	30 %

Faucet information

Impact area approx. 3 7/8 – 5 7/8" from middle faucet hole.
For parameters, see page 18.

Recommended article > s. p. 148

	Art.-No.	Price
Bottle trap, Sl.2	8306 000 978	314.00
Bottle trap, Sl.3	8312 000 978	288.00
Drain valve, VT.1	8302 000 978	247.00

EB . SR650

Built-in basin, rectangular, wxhxd 25 5/8 x 5 x 16 3/8", glazed steel, without faucet hole, without overflow, included installation kit

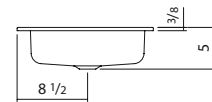
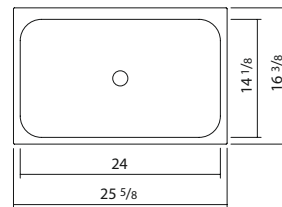

	Art.-No.	Price	Version	Surcharge
white, ProShield	2218 500 000	670.00	Glossy, matte, special color	30 %

Faucet information

Impact area approx. 3 7/8 – 5 7/8" from middle faucet hole.
For parameters, see page 18.

Recommended article > s. p. 148

	Art.-No.	Price
Bottle trap, Sl.2	8306 000 978	314.00
Bottle trap, Sl.3	8312 000 978	288.00
Drain valve, VT.3	8310 000 000	252.00

Built-in basins – R-series**EB . R585H**

Built-in basin, rectangular, wxhxd 23 x 5 5/8 x 16", glazed steel, with one faucet hole, with overflow, included installation kit, overflow set

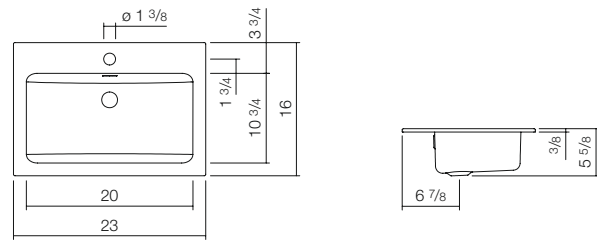

	Art.-No.	Price	Version	Surcharge
white, ProShield	2202 000 000	515.00	Without faucet hole	20 %
			3 Drill holes	20 %
			Drill hole for lotion dispenser	20 %
			Glossy, matte, special color	30 %

Faucet information

Impact area approx. 6 3/4 – 7 1/2" from middle faucet hole.
For parameters, see page 18.

Recommended article > s. p. 148

	Art.-No.	Price
Bottle trap, Sl.2	8306 000 978	314.00
Bottle trap, Sl.3	8312 000 978	288.00
Drain valve, VT.1	8302 000 978	247.00

EB . R585H

Built-in basin, rectangular, wxhxd 23 x 5 5/8 x 16", glazed steel, with one faucet hole, without overflow, included installation kit

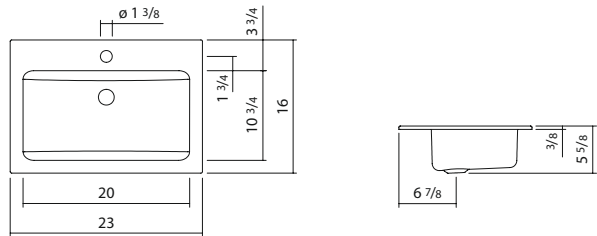

	Art.-No.	Price	Version	Surcharge
white, ProShield	2202 100 000	515.00	Without faucet hole	20 %
			3 Drill holes	20 %
			Drill hole for lotion dispenser	20 %
			Glossy, matte, special color	30 %

Faucet information

Impact area approx. 6 3/4 – 7 1/2" from middle faucet hole.
For parameters, see page 18.

Recommended article > s. p. 148

	Art.-No.	Price
Bottle trap, Sl.2	8306 000 978	314.00
Bottle trap, Sl.3	8312 000 978	288.00
Drain valve, VT.3	8310 000 000	252.00

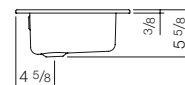
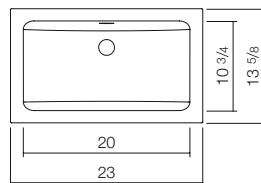
Built-in basins – R-series**EB . R585**

Built-in basin, rectangular, wxhxd 23 x 5 5/8 x 13 5/8", glazed steel, without faucet hole, with overflow, included installation kit, overflow set

	Art.-No.	Price	Version	Surcharge
white, ProShield	2201 000 000	464.00	Glossy, matte, special color	30 %

Faucet information

Impact area approx. 6 1/4 – 7 1/8" from rear edge of basin.
For parameters, see page 18.

Recommended article > s. p. 148

	Art.-No.	Price
Bottle trap, Sl.2	8306 000 978	314.00
Bottle trap, Sl.3	8312 000 978	288.00
Drain valve, VT.1	8302 000 978	247.00

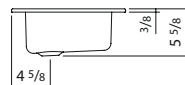
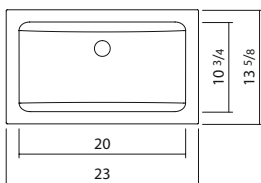
EB . R585

Built-in basin, rectangular, wxhxd 23 x 5 5/8 x 13 5/8", glazed steel, without faucet hole, without overflow, included installation kit

	Art.-No.	Price	Version	Surcharge
white, ProShield	2201 100 000	464.00	Glossy, matte, special color	30 %

Faucet information

Impact area approx. 6 1/4 – 7 1/8" from rear edge of basin.
For parameters, see page 18.

Recommended article > s. p. 148

	Art.-No.	Price
Bottle trap, Sl.2	8306 000 978	314.00
Bottle trap, Sl.3	8312 000 978	288.00
Drain valve, VT.3	8310 000 000	252.00

Built-in basins – R-series**EB . R800H**

Built-in basin, rectangular, wxhxd 31 1/2 x 4 3/4 x 19 5/8", glazed steel, with one faucet hole, with overflow, included installation kit, overflow set

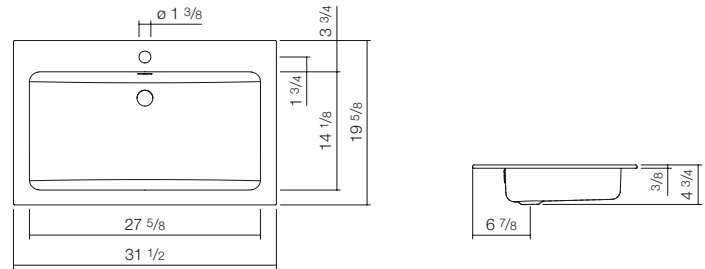

	Art.-No.	Price	Version	Surcharge
white, ProShield	2204 200 000	927.00	Without faucet hole	20 %
			3 Drill holes	20 %
			Drill hole for lotion dispenser	20 %
			Glossy, matte, special color	30 %

Faucet information

Impact area approx. 7 1/4 – 9 1/2" from middle faucet hole.
For parameters, see page 18.

Recommended article > s. p. 148

Art.-No.	Price
8306 000 978	314.00
8312 000 978	288.00
8302 000 978	247.00

EB . R800H

Built-in basin, rectangular, wxhxd 31 1/2 x 4 3/4 x 19 5/8", glazed steel, with one faucet hole, without overflow, included installation kit

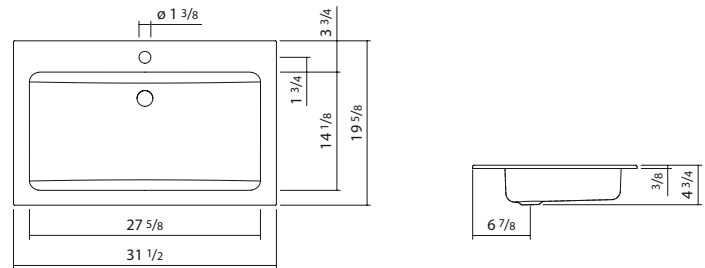

	Art.-No.	Price	Version	Surcharge
white, ProShield	2204 000 000	927.00	Without faucet hole	20 %
			3 Drill holes	20 %
			Drill hole for lotion dispenser	20 %
			Glossy, matte, special color	30 %

Faucet information

Impact area approx. 7 1/4 – 9 1/2" from middle faucet hole.
For parameters, see page 18.

Recommended article > s. p. 148

Art.-No.	Price
8306 000 978	314.00
8312 000 978	288.00
8310 000 000	252.00

Built-in basins – R-series**EB . R800**

Built-in basin, rectangular, wxhxd 31 1/2 x 4 3/4 x 17 3/4", glazed steel, without faucet hole, with overflow, included installation kit, overflow set

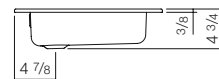
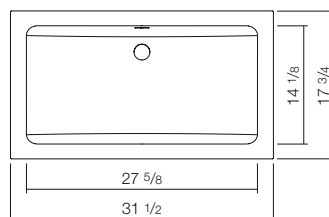

	Art.-No.	Price	Version	Surcharge
white, ProShield	2203 200 000	876.00	Glossy, matte, special color	30 %

Faucet information

Impact area approx. 7 1/4 – 9 1/2" from rear edge of basin.
For parameters, see page 18.

Recommended article > s. p. 148

	Art.-No.	Price
Bottle trap, Sl.2	8306 000 978	314.00
Bottle trap, Sl.3	8312 000 978	288.00
Drain valve, VT.1	8302 000 978	247.00

EB . R800

Built-in basin, rectangular, wxhxd 31 1/2 x 4 3/4 x 17 3/4", glazed steel, without faucet hole, without overflow, included installation kit

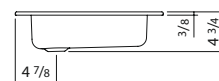
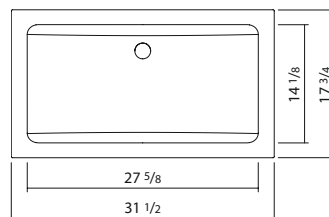

	Art.-No.	Price	Version	Surcharge
white, ProShield	2203 000 000	876.00	Glossy, matte, special color	30 %

Faucet information

Impact area approx. 7 1/4 – 9 1/2" from rear edge of basin.
For parameters, see page 18.

Recommended article > s. p. 148

	Art.-No.	Price
Bottle trap, Sl.2	8306 000 978	314.00
Bottle trap, Sl.3	8312 000 978	288.00
Drain valve, VT.3	8305 000 000	0.00

Built-in basins – RE-series (X.plicit)**EB . RE700H . 2**

Built-in basin, rectangular, wxhxd 27 1/2 x 3 1/2 x 18 1/8", glazed steel, with one faucet hole, without overflow, included installation kit, drain valve, valve cap, white glazed

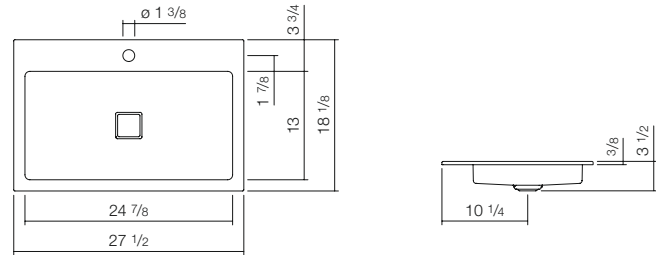

	Art.-No.	Price	Version	Surcharge
white, ProShield	2208 000 000	927.00	Without faucet hole	20 %
			3 Drill holes	20 %
			Drill hole for lotion dispenser	20 %
			Glossy, matte, special color	30 %

Faucet information

Impact area approx. 4 3/4 – 5 7/8" from middle faucet hole.
For parameters, see page 18.

Recommended article > s. p. 148

	Art.-No.	Price
Bottle trap, Sl.2	8306 000 978	314.00
Bottle trap, Sl.3	8312 000 978	288.00

EB . RE700 . 4

Built-in basin, rectangular, wxhxd 27 1/2 x 3 1/2 x 15 5/8", glazed steel, without faucet hole, without overflow, included installation kit, drain valve, valve cap, white glazed

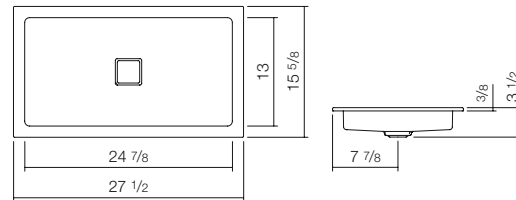

	Art.-No.	Price	Version	Surcharge
white, ProShield	2207 000 000	824.00	Glossy, matte, special color	30 %

Faucet information

Impact area approx. 4 1/8 – 5 1/2" from rear edge of basin.
For parameters, see page 18.

Recommended article > s. p. 148

	Art.-No.	Price
Bottle trap, Sl.2	8306 000 978	314.00
Bottle trap, Sl.3	8312 000 978	288.00

Built-in basins – Q-series

All prices in US \$

Cut-out dimensions: Download www.alape.com**EB . Q450H**

Built-in basin, rectangular, wxhxd 17 3/4 x 3 5/8 x 19 5/8", glazed steel, with one faucet hole, without overflow, included installation kit, drain valve, valve cap, white glazed

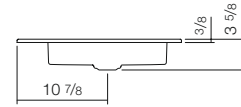
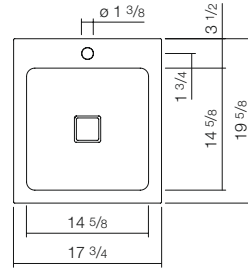

	Art.-No.	Price	Version	Surcharge
white, ProShield	2303 000 000	752.00	3 Drill holes	20 %
			Drill hole for lotion dispenser	20 %
			Glossy, matte, special color	30 %

Faucet information

Impact area approx. 4 3/4 – 6 7/8" from middle faucet hole.
For parameters, see page 18.

Recommended article > s. p. 148

	Art.-No.	Price
Bottle trap, Sl.2	8306 000 978	314.00
Bottle trap, Sl.3	8312 000 978	288.00

EB . Q450

Built-in basin, square, wxhxd 17 3/4 x 3 5/8 x 17 3/4", glazed steel, without faucet hole, without overflow, included installation kit, drain valve, valve cap, white glazed

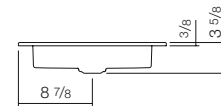
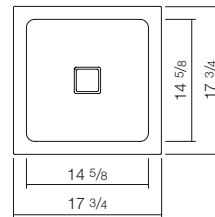

	Art.-No.	Price	Version	Surcharge
white, ProShield	2302 000 000	700.00	Glossy, matte, special color	30 %

Faucet information

Impact area approx. 4 1/2 – 6 3/4" from rear edge of basin.
For parameters, see page 18.

Recommended article > s. p. 148

	Art.-No.	Price
Bottle trap, Sl.2	8306 000 978	314.00
Bottle trap, Sl.3	8312 000 978	288.00

Semi recessed basins – S-series, R-series

All prices in US \$

Cut-out dimensions: Download www.alape.com

HB . S450H

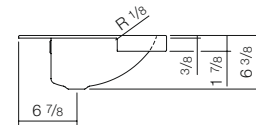
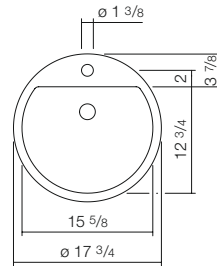

Semi-recessed basin, round, $\phi 17 \frac{3}{4}$ ", height $6 \frac{3}{8}$ ", glazed steel, with one faucet hole, with overflow, included installation kit, overflow set

	Art.-No.	Price	Version	Surcharge
white, ProShield	2900 000 000	618.00	Without faucet hole	20 %
			Without overflow	20 %
			3 Drill holes	20 %
			Drill hole for lotion dispenser	20 %
			Glossy, matte, special color	30 %
Faucet information			Recommended article > s. p. 148	Art.-No.
Impact area approx. $6 \frac{3}{4}$ – $8 \frac{1}{4}$ " from middle faucet hole.			Bottle trap, Sl.2	8306 000 978
For parameters, see page 18.			Bottle trap, Sl.3	8312 000 978
			Drain valve, VT.1	8302 000 978
				Price
				314.00
				288.00
				247.00

HB . R585H

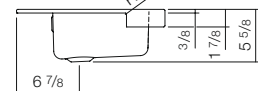
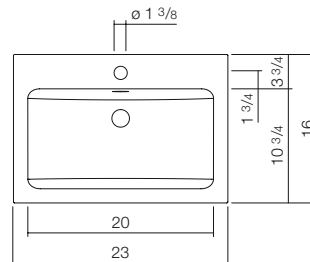

Semi-recessed basin, rectangular, wxhxd $23 \times 5 \frac{5}{8} \times 16$ ", glazed steel, with one faucet hole, with overflow, included installation kit, overflow set























	Art.-No.	Price	Version	Surcharge
white, ProShield	2700 000 000	773.00	Without faucet hole	20 %
			Without overflow	20 %
			3 Drill holes	20 %
			Drill hole for lotion dispenser	20 %
			Glossy, matte, special color	30 %
Faucet information			Recommended article > s. p. 148	Art.-No.
Impact area approx. $6 \frac{3}{4}$ – $7 \frac{1}{2}$ " from middle faucet hole.			Bottle trap, Sl.2	8306 000 978
For parameters, see page 18.			Bottle trap, Sl.3	8312 000 978
			Drain valve, VT.1	8302 000 978
				Price
				314.00
				288.00
				247.00

Sit-on basins

AB



Unisono
Sit-on basin
AB . KE400
ø 15 3/4 x 4 1/2"

Basin width				
12 3/4 – 14 3/4"	15 3/4 – 27 1/2"	29 1/2 – 39 3/8"		
 <p>AB.K325.2 ø 12 3/4", height 4 7/8" Page 60</p>  <p>AB.KE325 ø 12 3/4", height 4 1/8" Page 63</p>  <p>AB.KE375 ø 14 3/4", height 4 1/2" Page 63</p>	 <p>AB.KE400 ø 15 3/4", height 4 1/2" Page 64</p>  <p>AB.K400.2 ø 15 3/4", height 6 1/8" Page 61</p>  <p>AB.K400H.2 ø 15 3/4", height 6 1/8" Page 60</p>	 <p>AB.K450.2 ø 17 3/4", height 6 3/4" Page 62</p>  <p>AB.K450H.2 ø 17 3/4", height 6 3/4" Page 61</p>  <p>AB.S0450.1 ø 17 3/4", height 4 5/8" Page 64</p>	Round	
	 <p>AB.ME500 19 5/8 x 14 3/4", height 4 1/2" Page 65</p>  <p>AB.R585.1 23 x 13 5/8", height 2 3/8" Page 68</p>  <p>AB.R585H.1 23 x 16", height 2 3/8" Page 68</p>  <p>AB.Q450.1 17 3/4 x 17 3/4", height 4 3/8" Page 71</p>  <p>AB.Q450H.1 17 3/4 x 19 5/8", height 4 3/8" Page 71</p>	 <p>AB.SR650 25 5/8 x 16 3/8", height 2" Page 67</p>  <p>AB.SR650H 25 5/8 x 18 5/8", height 2" Page 67</p>  <p>AB.RE700H.2 27 1/2 x 18 1/8", height 3" Page 70</p>  <p>AB.RE700.4 27 1/2 x 15 5/8", height 3" Page 70</p>	 <p>AB.ME750 29 1/2 x 14 3/4", height 4 1/2" Page 65</p>  <p>AB.R800 31 1/2 x 17 7/8", height 3" Page 69</p>  <p>AB.R800H 31 1/2 x 19 5/8", height 3" Page 69</p>  <p>AB.ME1000 39 3/8 x 14 3/4", height 4 1/2" Page 66</p>	Square and rectangular

Sit-on basins – K-series**AB . K325 . 2**

Sit-on basin, round, Ø 12 3/4", height 4 7/8", glazed steel, without faucet hole, with overflow, included installation kit, overflow set

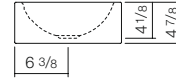
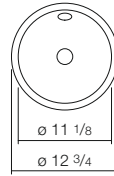

	Art.-No.	Price	Version	Surcharge
white, ProShield	3000 200 000	793.00	Without overflow	20 %
			Glossy, matte, special color	30 %

Faucet information

Impact area approx. 3 3/8 – 4 1/2" from rear edge of basin.
For parameters, see page 18.

Recommended article > s. p. 148

	Art.-No.	Price
Bottle trap, Sl.2	8306 000 978	314.00
Bottle trap, Sl.3	8312 000 978	288.00
Drain valve, VT.1	8302 000 978	247.00

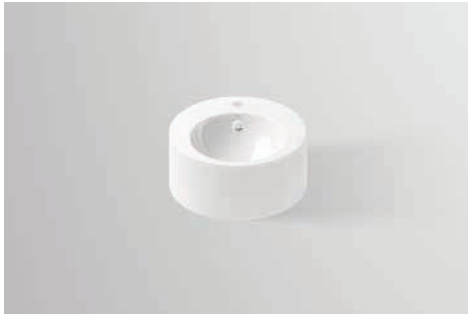
AB . K400H . 2

Sit-on basin, round, Ø 15 3/4", height 6 1/8", glazed steel, with one faucet hole, with overflow, included installation kit, overflow set

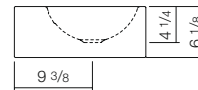
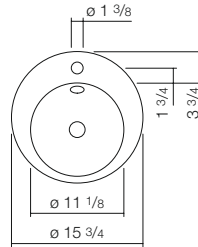

	Art.-No.	Price	Version	Surcharge
white, ProShield	3004 200 000	855.00	Without overflow	20 %
			3 Drill holes	20 %
			Drill hole for lotion dispenser	20 %
			Glossy, matte, special color	30 %

Faucet information

Impact area approx. 4 3/8 – 5 1/2" from middle faucet hole.
For parameters, see page 18.

Recommended article > s. p. 148

	Art.-No.	Price
Bottle trap, Sl.2	8306 000 978	314.00
Bottle trap, Sl.3	8312 000 978	288.00
Drain valve, VT.1	8302 000 978	247.00

Sit-on basins – K-series**AB . K400 . 2**

Sit-on basin, round, Ø 15 3/4", height 6 1/8", glazed steel, without faucet hole, with overflow, included installation kit, overflow set

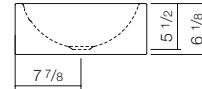
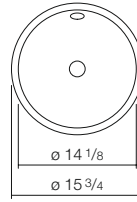

	Art.-No.	Price	Version	Surcharge
white, ProShield	3002 200 000	803.00	Without overflow	20 %
			Glossy, matte, special color	30 %

Faucet information

Impact area approx. 4 3/8" – 5 7/8" from rear edge of basin.
For parameters, see page 18.

Recommended article > s. p. 148

	Art.-No.	Price
Bottle trap, Sl.2	8306 000 978	314.00
Bottle trap, Sl.3	8312 000 978	288.00
Drain valve, VT.1	8302 000 978	247.00

AB . K450H . 2

Sit-on basin, round, Ø 17 3/4", height 6 3/4", glazed steel, with one faucet hole, with overflow, included installation kit, overflow set

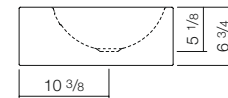
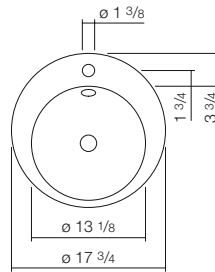

	Art.-No.	Price	Version	Surcharge
white, ProShield	3008 000 000	979.00	Without overflow	20 %
			3 Drill holes	20 %
			Drill hole for lotion dispenser	20 %
			Glossy, matte, special color	30 %

Faucet information

Impact area approx. 5 1/2" – 6 1/4" from middle faucet hole.
For parameters, see page 18.

Recommended article > s. p. 148

	Art.-No.	Price
Bottle trap, Sl.2	8306 000 978	314.00
Bottle trap, Sl.3	8312 000 978	288.00
Drain valve, VT.1	8302 000 978	247.00

Sit-on basins – K-series**AB . K450 . 2**

Sit-on basin, round, Ø 17 3/4", height 6 3/4", glazed steel, without faucet hole, with overflow, included installation kit, overflow set

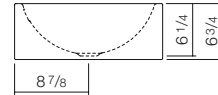
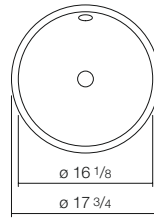

	Art.-No.	Price	Version	Surcharge
white, ProShield	3006 200 000	927.00	Without overflow	20 %
			Glossy, matte, special color	30 %

Faucet information

Impact area approx. 4 3/8 – 6 3/4" from rear edge of basin.
For parameters, see page 18.

Recommended article > s. p. 148

	Art.-No.	Price
Bottle trap, SI.2	8306 000 978	314.00
Bottle trap, SI.3	8312 000 978	288.00
Drain valve, VT.1	8302 000 978	247.00

Sit-on basins – KE-series (Unisono)

All prices in US \$

Cut-out dimensions: Download www.alape.com**AB . KE325**

Sit-on basin, round, Ø 12 3/4", height 4 1/8", glazed steel, without faucet hole, without overflow, included installation kit, drain valve, valve cap, chrome-plated, black spacer ring

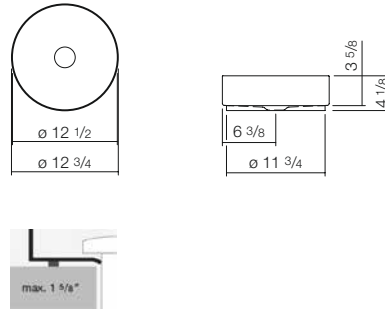

	Art.-No.	Price	Version	Surcharge
white, ProShield	3220 000 000	896.00	Glossy, matte, special color	30 %

Faucet information

Impact area approx. 3 3/8 – 4 3/4" from rear edge of basin.
For parameters, see page 18.

Recommended article > s. p. 148

	Art.-No.	Price
Bottle trap, Sl.2	8306 000 978	314.00
Bottle trap, Sl.3	8312 000 978	288.00

AB . KE375

Sit-on basin, round, Ø 14 3/4", height 4 1/2", glazed steel, without faucet hole, without overflow, included installation kit, drain valve, valve cap, chrome-plated, black spacer ring

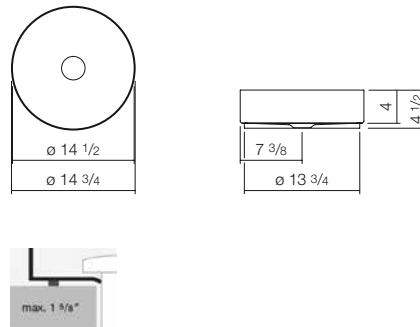

	Art.-No.	Price	Version	Surcharge
white, ProShield	3221 000 000	948.00	Glossy, matte, special color	30 %

Faucet information

Impact area approx. 3 7/8 – 5 3/4" from rear edge of basin.
For parameters, see page 18.

Recommended article > s. p. 148

	Art.-No.	Price
Bottle trap, Sl.2	8306 000 978	314.00
Bottle trap, Sl.3	8312 000 978	288.00

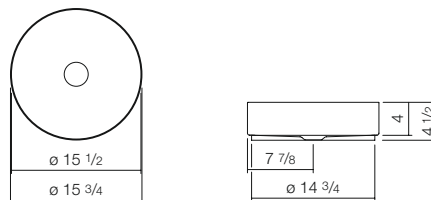
Sit-on basins – KE-series, SO-series**AB . KE400**

Sit-on basin, round, \varnothing 15 $\frac{3}{4}$ ", height 4 $\frac{1}{2}$ ", glazed steel, without faucet hole, without overflow, included installation kit, drain valve, valve cap, chrome-plated, black spacer ring

	Art.-No.	Price	Version	Surcharge
white, ProShield	3222 000 000	999.00	Glossy, matte, special color	30 %

Faucet information

Impact area approx. 4 $\frac{1}{8}$ – 5 $\frac{7}{8}$ " from rear edge of basin.
For parameters, see page 18.

Recommended article > s. p. 148

	Art.-No.	Price
Bottle trap, Sl.2	8306 000 978	314.00
Bottle trap, Sl.3	8312 000 978	288.00

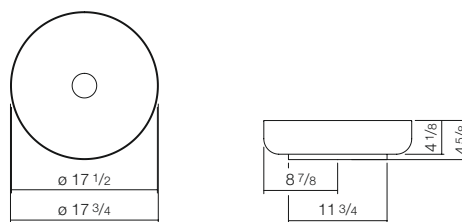
AB . S0450 . 1

Sit-on basin, round, \varnothing 17 $\frac{3}{4}$ ", height 4 $\frac{5}{8}$ ", glazed steel, without faucet hole, without overflow, included installation kit, drain valve, valve cap, chrome-plated, white spacer ring

	Art.-No.	Price	Version	Surcharge
white, ProShield	3503 000 000	1,133.00	Glossy, matte, special color	30 %

Faucet information

Impact area approx. 2 $\frac{3}{8}$ – 6 $\frac{3}{4}$ " from rear edge of basin.
For parameters, see page 18.

Recommended article > s. p. 148

	Art.-No.	Price
Bottle trap, Sl.2	8306 000 978	314.00
Bottle trap, Sl.3	8312 000 978	288.00

Sit-on basins – ME-series (Metaphor)

All prices in US \$

Cut-out dimensions: Download www.alape.com**AB . ME500**

Sit-on basin, rectangular, wxhxd 19 5/8 x 4 1/2 x 14 3/4", glazed steel, without faucet hole, without overflow, included installation kit, drain valve, valve cap, chrome-plated, black spacer frame

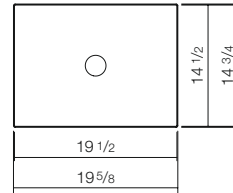

	Art.-No.	Price	Version	Surcharge
white, ProShield	3212 000 000	1,391.00	Glossy, matte, special color	30 %

Faucet information

Impact area approx. 3 1/2 – 5 3/8" from rear edge of basin.
For parameters, see page 18.

Recommended article > s. p. 148

	Art.-No.	Price
Bottle trap, Sl.2	8306 000 978	314.00
Bottle trap, Sl.3	8312 000 978	288.00

AB . ME750

Sit-on basin, rectangular, wxhxd 29 1/2 x 4 1/2 x 14 3/4", glazed steel, without faucet hole, without overflow, included installation kit, drain valve, valve cap, chrome-plated, black spacer frame

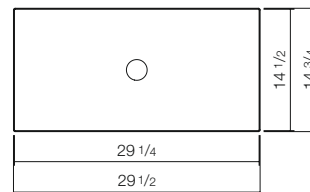

	Art.-No.	Price	Version	Surcharge
white, ProShield	3213 000 000	1,494.00	Glossy, matte, special color	30 %

Faucet information

Impact area approx. 3 1/2 – 5 3/8" from rear edge of basin.
For parameters, see page 18.

Recommended article > s. p. 148

	Art.-No.	Price
Bottle trap, Sl.2	8306 000 978	314.00
Bottle trap, Sl.3	8312 000 978	288.00

Sit-on basins – ME-series (Metaphor)**AB . ME1000**

Sit-on basin, rectangular, wxhxd 39 3/8 x 4 1/2 x 14 3/4", glazed steel, without faucet hole, without overflow, included installation kit, drain valve, valve cap, chrome-plated, black spacer frame

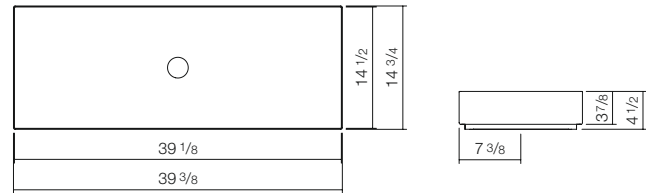

	Art.-No.	Price	Version	Surcharge
white, ProShield	3214 000 000	1,803.00	Glossy, matte, special color	30 %

Faucet information

Impact area approx. 3 1/2 – 5 3/8" from rear edge of basin.
For parameters, see page 18.

Recommended article > s. p. 148

	Art.-No.	Price
Bottle trap, SI.2	8306 000 978	314.00
Bottle trap, SI.3	8312 000 978	288.00

Sit-on basins – SR-series (Stream)

All prices in US \$

Cut-out dimensions: Download www.alape.com

AB . SR650H



Sit-on basin, rectangular, wxhxd 25 5/8 x 5 x 18 5/8", glazed steel, with one faucet hole, with overflow, included installation kit, overflow set

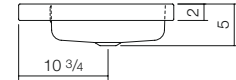
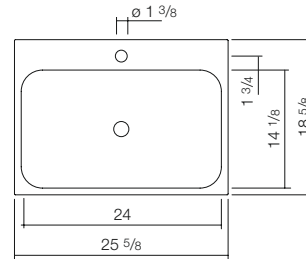

	Art.-No.	Price	Version	Surcharge
white, ProShield	3231 600 000	721.00	Without overflow	20 %
			3 Drill holes	20 %
			Drill hole for lotion dispenser	20 %
			Glossy, matte, special color	30 %

Faucet information

Impact area approx. 4 1/8 – 6 1/8" from middle faucet hole.
For parameters, see page 18.

Recommended article > s. p. 148

	Art.-No.	Price
Bottle trap, Sl.2	8306 000 978	314.00
Bottle trap, Sl.3	8312 000 978	288.00
Drain valve, VT.1	8302 000 978	247.00

AB . SR650



Sit-on basin, rectangular, wxhxd 25 5/8 x 5 x 16 3/8", glazed steel, without faucet hole, with overflow, included installation kit, overflow set

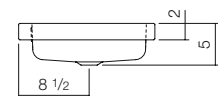
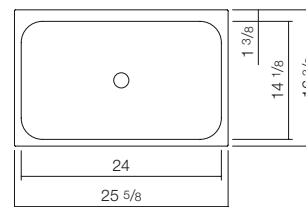

	Art.-No.	Price	Version	Surcharge
white, ProShield	3230 700 000	670.00	Without overflow	20 %
			Glossy, matte, special color	30 %

Faucet information

Impact area approx. 3 7/8 – 5 7/8" from rear edge of basin.
For parameters, see page 18.

Recommended article > s. p. 148

	Art.-No.	Price
Bottle trap, Sl.2	8306 000 978	314.00
Bottle trap, Sl.3	8312 000 978	288.00
Drain valve, VT.1	8302 000 978	247.00

Sit-on basins – R-series**AB . R585H . 1**

Sit-on basin, rectangular, wxhxd 23 x 5 5/8 x 16", glazed steel, with one faucet hole, with overflow, included installation kit, overflow set

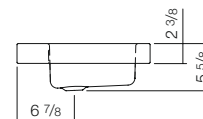
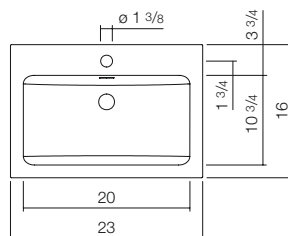

	Art.-No.	Price	Version	Surcharge
white, ProShield	3202 000 000	979.00	Without overflow	20 %
			3 Drill holes	20 %
			Drill hole for lotion dispenser	20 %
			Glossy, matte, special color	30 %

Faucet information

Impact area approx. 6 3/4 – 7 1/2" from middle faucet hole.
For parameters, see page 18.

Recommended article > s. p. 148

	Art.-No.	Price
Bottle trap, Sl.2	8306 000 978	314.00
Bottle trap, Sl.3	8312 000 978	288.00
Drain valve, VT.1	8302 000 978	247.00

AB . R585 . 1

Sit-on basin, rectangular, wxhxd 23 x 5 5/8 x 13 5/8", glazed steel, without faucet hole, with overflow, included installation kit, overflow set

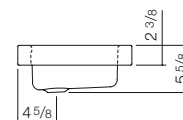
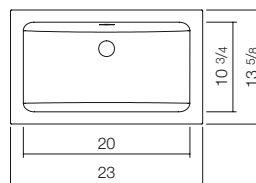

	Art.-No.	Price	Version	Surcharge
white, ProShield	3205 000 000	927.00	Without overflow	20 %
			Glossy, matte, special color	30 %

Faucet information

Impact area approx. 6 1/4 – 7 1/8" from rear edge of basin.
For parameters, see page 18.

Recommended article > s. p. 148

	Art.-No.	Price
Bottle trap, Sl.2	8306 000 978	314.00
Bottle trap, Sl.3	8312 000 978	288.00
Drain valve, VT.1	8302 000 978	247.00

Sit-on basins – R-series**AB . R800H**

Sit-on basin, rectangular, wxhxd 31 1/2 x 4 3/4 x 19 5/8", glazed steel, with one faucet hole, with overflow, included installation kit, overflow set

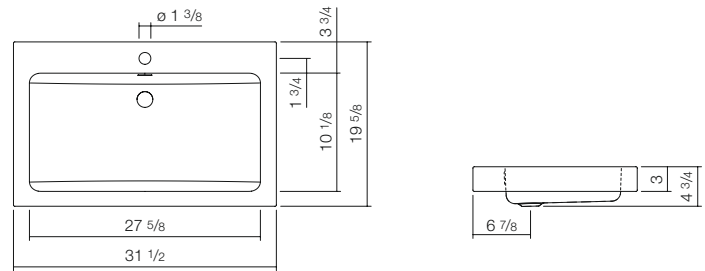

	Art.-No.	Price	Version	Surcharge
white, ProShield	3206 200 000	1,288.00	Without overflow	20 %
			3 Drill holes	20 %
			Drill hole for lotion dispenser	20 %
			Glossy, matte, special color	30 %

Faucet information

Impact area approx. 7 1/4 – 9 1/2" from middle faucet hole.
For parameters, see page 18.

Recommended article > s. p. 148

	Art.-No.	Price
Bottle trap, Sl.2	8306 000 978	314.00
Bottle trap, Sl.3	8312 000 978	288.00
Drain valve, VT.1	8302 000 978	247.00

AB . R800

Sit-on basin, rectangular, wxhxd 31 1/2 x 4 3/4 x 17 7/8", glazed steel, without faucet hole, with overflow, included installation kit, overflow set

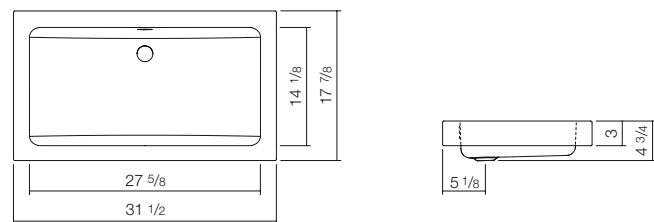

	Art.-No.	Price	Version	Surcharge
white, ProShield	3207 200 000	1,236.00	Without overflow	20 %
			Glossy, matte, special color	30 %

Faucet information

Impact area approx. 7 1/2 – 9 5/8" from rear edge of basin.
For parameters, see page 18.

Recommended article > s. p. 148

	Art.-No.	Price
Bottle trap, Sl.2	8306 000 978	314.00
Bottle trap, Sl.3	8312 000 978	288.00
Drain valve, VT.1	8302 000 978	247.00

Sit-on basins – RE-series (X.plicit)**AB.RE700H.2**

Sit-on basin, rectangular, wxhxd 27 1/2 x 3 1/2 x 18 1/8", glazed steel, with one faucet hole, without overflow, included installation kit, drain valve, valve cap, white glazed

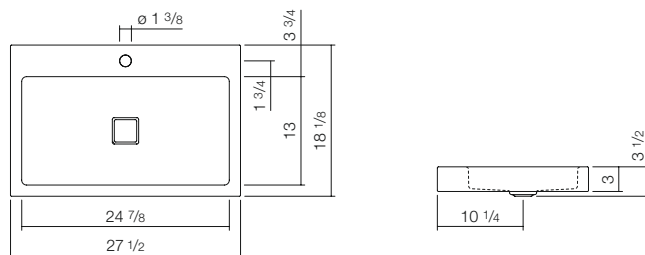

	Art.-No.	Price	Version	Surcharge
white, ProShield	3209 000 000	1,133.00	Without faucet hole	20 %
			3 Drill holes	20 %
			Drill hole for lotion dispenser	20 %
			Glossy, matte, special color	30 %

Faucet information

Impact area approx. 4 3/4 – 5 7/8" from middle faucet hole.
For parameters, see page 18.

Recommended article > s. p. 148

	Art.-No.	Price
Bottle trap, Sl.2	8306 000 978	314.00
Bottle trap, Sl.3	8312 000 978	288.00

AB.RE700.4

Sit-on basin, rectangular, wxhxd 27 1/2 x 3 1/2 x 15 5/8", glazed steel, without faucet hole, without overflow, included installation kit, drain valve, valve cap, white glazed

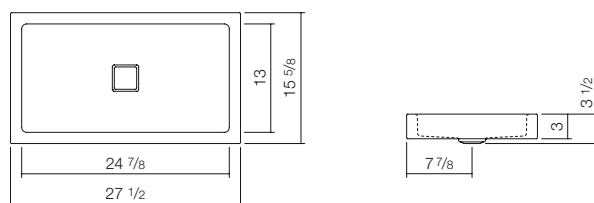

	Art.-No.	Price	Version	Surcharge
white, ProShield	3208 000 000	1,030.00	Glossy, matte, special color	30 %

Faucet information

Impact area approx. 4 1/8 – 5 1/2" from rear edge of basin.
For parameters, see page 18.

Recommended article > s. p. 148

	Art.-No.	Price
Bottle trap, Sl.2	8306 000 978	314.00
Bottle trap, Sl.3	8312 000 978	288.00

Sit-on basins – Q-series

All prices in US \$

Cut-out dimensions: Download www.alape.com

AB . Q450H . 1



Sit-on basin, rectangular, wxhxd 17 3/4 x 4 3/8 x 19 5/8", glazed steel, with one faucet hole, without overflow, included installation kit, drain valve, valve cap, white glazed

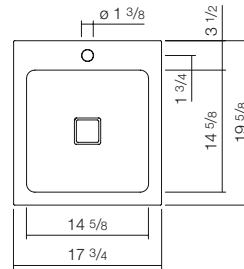

	Art.-No.	Price	Version	Surcharge
white, ProShield	3304 000 000	1,133.00	3 Drill holes	20 %
			Drill hole for lotion dispenser	20 %
			Glossy, matte, special color	30 %

Faucet information

Impact area approx. 4 3/4 – 6 7/8" from middle faucet hole.
For parameters, see page 18.

Recommended article > s. p. 148

	Art.-No.	Price
Bottle trap, Sl.2	8306 000 978	314.00
Bottle trap, Sl.3	8312 000 978	288.00

AB . Q450 . 1



Sit-on basin, square, wxhxd 17 3/4 x 4 3/8 x 17 3/4", glazed steel, without faucet hole, without overflow, included installation kit, drain valve, valve cap, white glazed

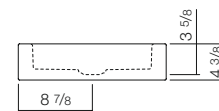
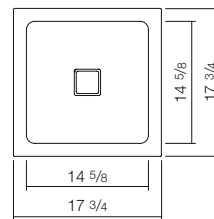

	Art.-No.	Price	Version	Surcharge
white, ProShield	3302 000 000	1,082.00	Glossy, matte, special color	30 %

Faucet information

Impact area approx. 4 1/2 – 6 3/4" from rear edge of basin.
For parameters, see page 18.

Recommended article > s. p. 148







	Art.-No.	Price
Bottle trap, Sl.2	8306 000 978	314.00
Bottle trap, Sl.3	8312 000 978	288.00

Dish Basins

SB



Scopio
Dish basin
SB . C0375
ø 14 3/4 x 4 5/8"

		Basin width				
		12 3/4 – 16 3/4"	17 3/4 – 23"	23 5/8 – 27 1/2"	31 1/2 – 39 3/8"	
Round	 SB . K300 . GS ø 11 3/4" Page 74	 SB . K450 . GS ø 17 3/4" Page 75				
	 SB . K360 . GS ø 14 1/8" Page 74					
	 SB . C0375 ø 14 3/4" Page 75					
Oval			 SB . 0700 . GS 27 5/8 x 15 7/8" Page 76			
Square and rectangular			 SB . SR650 23 5/8 x 13 3/4" Page 76			

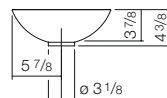
Dish basins – GS-series**SB . K300 . GS**

Dish basin, round, \varnothing 11 $\frac{3}{4}$ ", height 4 $\frac{3}{8}$ ", glazed steel, without faucet hole, without overflow, included drain valve, valve cap, chrome-plated, chrome-plated spacer ring

	Art.-No.	Price	Version	Surcharge
white, ProShield	3500 000 000	515.00	Glossy, matte, special color	30 %

Faucet information

Impact area approx. 3 $\frac{1}{8}$ – 4 $\frac{3}{8}$ " from rear edge of basin.
For parameters, see page 18.

Recommended article > s. p. 148

	Art.-No.	Price
Bottle trap, Sl.2	8306 000 978	314.00
Bottle trap, Sl.3	8312 000 978	288.00

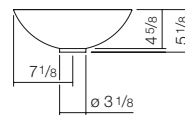
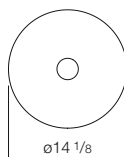
SB . K360 . GS

Dish basin, round, \varnothing 14 $\frac{1}{8}$ ", height 5 $\frac{1}{8}$ ", glazed steel, without faucet hole, without overflow, included drain valve, valve cap, chrome-plated, chrome-plated spacer ring

	Art.-No.	Price	Version	Surcharge
white, ProShield	3501 000 000	567.00	Glossy, matte, special color	30 %

Faucet information

Impact area approx. 3 $\frac{7}{8}$ – 5 $\frac{1}{2}$ " from rear edge of basin.
For parameters, see page 18.

Recommended article > s. p. 148

	Art.-No.	Price
Bottle trap, Sl.2	8306 000 978	314.00
Bottle trap, Sl.3	8312 000 978	288.00

Dish basins – GS-series, CO-series

All prices in US \$

Cut-out dimensions: Download www.alape.com

SB . K450 . GS



Dish basin, round, \varnothing 17 $\frac{3}{4}$ ", height 5 $\frac{5}{8}$ ", glazed steel, without faucet hole, without overflow, included drain valve, valve cap, chrome-plated, chrome-plated spacer ring

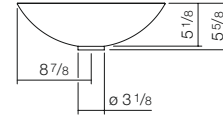
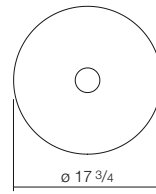

	Art.-No.	Price	Version	Surcharge
white, ProShield	3502 000 000	639.00	Glossy, matte, special color	30 %

Faucet information

Impact area approx. 5 $\frac{1}{8}$ – 7 $\frac{1}{8}$ " from rear edge of basin.
For parameters, see page 18.

Recommended article > s. p. 148

	Art.-No.	Price
Bottle trap, Sl.2	8306 000 978	314.00
Bottle trap, Sl.3	8312 000 978	288.00

SB . C0375



Dish basin, round, \varnothing 14 $\frac{3}{4}$ ", height 4 $\frac{5}{8}$ ", glazed steel, without faucet hole, without overflow, included drain valve, valve cap, white glazed, black spacer ring

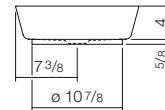
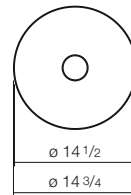

	Art.-No.	Price	Version	Surcharge
white, ProShield	3508 500 000	700.00	Glossy, matte, special color	30 %

Faucet information

Impact area approx. 3 $\frac{7}{8}$ – 5 $\frac{3}{8}$ " from rear edge of basin.
For parameters, see page 18.

Recommended article > s. p. 148

	Art.-No.	Price
Bottle trap, Sl.2	8306 000 978	314.00
Bottle trap, Sl.3	8312 000 978	288.00

Dish basins – GS-series, SR-series**SB.0700.GS**

Dish basin, oval, wxhxd 27 5/8 x 3 3/8 x 15 7/8", glazed steel, without faucet hole, without overflow, included drain valve, valve cap, white glazed, white spacer frame

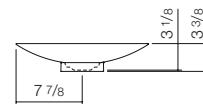
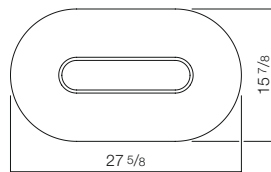

	Art.-No.	Price	Version	Surcharge
white, ProShield	3520 000 000	1,185.00	Glossy, matte, special color	30 %

Faucet information

Impact area approx. 4 3/4 – 5 7/8" from rear edge of basin.
For parameters, see page 18.

Recommended article > s. p. 148

	Art.-No.	Price
Bottle trap, Sl.2	8306 000 978	314.00
Bottle trap, Sl.3	8312 000 978	288.00

SB.SR650

Dish basin, rectangular, wxhxd 23 5/8 x 4 5/8 x 13 3/4", glazed steel, without faucet hole, without overflow, included drain valve, valve cap, chrome-plated, chrome-plated spacer frame

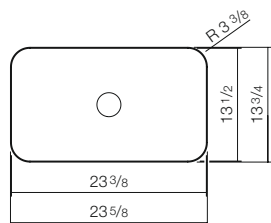

	Art.-No.	Price	Version	Surcharge
white, ProShield	3507 500 000	1,442.00	Glossy, matte, special color	30 %

Faucet information

Impact area approx. 2 1/4 – 4 1/4" from rear edge of basin.
For parameters, see page 18.

Recommended article > s. p. 148

	Art.-No.	Price
Bottle trap, Sl.2	8306 000 978	314.00
Bottle trap, Sl.3	8312 000 978	288.00



Stream
Dish basin
SB.SR650
23 5/8 x 4 5/8 x 13 3/4"



Special glazes





Aqua
Dish basin

Basin width			
12 3/4 – 16 3/4"	17 3/4 – 23"	23 5/8 – 27 1/2"	31 1/2 – 39 3/8"





Aqua

 <p>SB.Aqua300 ø 11 3/4" Page 80</p>	 <p>SB.Aqua450 ø 17 3/4" Page 81</p>	Round
 <p>SB.Aqua360 ø 14 1/8" Page 80</p>		



Terra

 <p>SB.Terra300 ø 11 3/4" Page 82</p>	 <p>SB.Terra450 ø 17 3/4" Page 83</p>	Round
 <p>SB.Terra360 ø 14 1/8" Page 82</p>		

Bicolor

 <p>SB.K360.GS ø 14 1/8" Page 85</p>	 <p>WT.RX400.KE ø 15 3/4" Page 85</p>	Round
 <p>AB.KE400 ø 15 3/4" Page 84</p>	 <p>AB.S0450.1 ø 17 3/4" Page 84</p>	

Metallic

 <p>SB.K360.GS ø 14 1/8" Page 87</p>	 <p>AB.S0450.1 ø 17 3/4" Page 87</p>	Round
 <p>UB.K400 Basin ø 14 1/8" Page 86</p>		
 <p>WT.RX400.K ø 15 7/8" Page 88</p>		
	 <p>UB.0525 Basin 18 5/8" x 14 5/8" Page 86</p>	Oval

Aqua**SB . Aqua300**

Dish basin, round, \varnothing 11 $\frac{3}{4}$ ", height 4 $\frac{5}{8}$ ", glazed steel, without faucet hole, without overflow, included drain valve, valve cap, glazed in the basin color

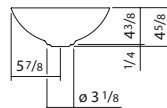
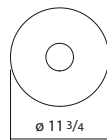

deep green



deep blue



deep indigo

	Art.-No.	Price	Recommended article > s. p. 148	Art.-No.	Price
deep green	3900 000 091	600.00	Bottle trap, Sl.2	8306 000 978	314.00
deep blue	3900 000 092	600.00	Bottle trap, Sl.3	8312 000 978	288.00
deep indigo	3900 000 093	600.00			

Faucet information

Impact area approx. 3 $\frac{1}{8}$ – 4 $\frac{3}{8}$ " from rear edge of basin.
For parameters, see page 18.

SB . Aqua360

Dish basin, round, \varnothing 14 $\frac{1}{8}$ ", height 5 $\frac{3}{8}$ ", glazed steel, without faucet hole, without overflow, included drain valve, valve cap, glazed in the basin color

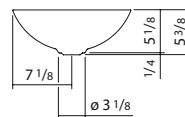
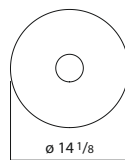

deep green



deep blue



deep indigo

	Art.-No.	Price	Recommended article > s. p. 148	Art.-No.	Price
deep green	3901 000 091	660.00	Bottle trap, Sl.2	8306 000 978	314.00
deep blue	3901 000 092	660.00	Bottle trap, Sl.3	8312 000 978	288.00
deep indigo	3901 000 093	660.00			

Faucet information

Impact area approx. 3 $\frac{7}{8}$ – 5 $\frac{1}{2}$ " from rear edge of basin.
For parameters, see page 18.

Aqua**SB . Aqua450**

Dish basin, round, \varnothing 17 ³/₄", height 5 ⁷/₈", glazed steel, without faucet hole, without overflow, included drain valve, valve cap, glazed in the basin color

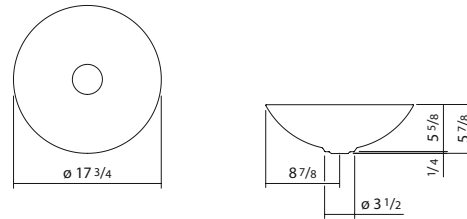

deep green



deep blue



deep indigo

	Art.-No.	Price	Recommended article > s. p. 148	Art.-No.	Price
deep green	3902 000 091	744.00	Bottle trap, Sl.2	8306 000 978	314.00
deep blue	3902 000 092	744.00	Bottle trap, Sl.3	8312 000 978	288.00
deep indigo	3902 000 093	744.00			

Faucet information

Impact area approx. 5 ¹/₈ – 7 ¹/₈" from rear edge of basin.
For parameters, see page 18.

Terra**SB . Terra300**

Dish basin, round, \varnothing 11 $\frac{3}{4}$ ", height 4 $\frac{5}{8}$ ", glazed steel, without faucet hole, without overflow, included drain valve, valve cap, glazed in the basin color

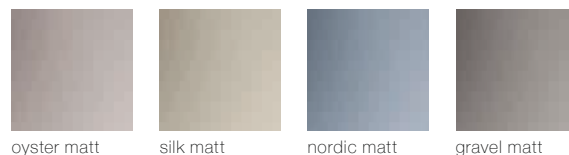
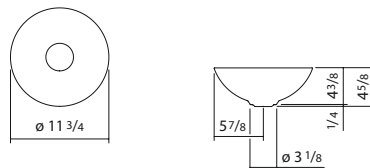

	Art.-No.	Price	Recommended article > s. p. 148	Art.-No.	Price
oyster matt	3900 000 081	575.00	Bottle trap, Sl.2	8306 000 978	314.00
silk matt	3900 000 082	575.00	Bottle trap, Sl.3	8312 000 978	288.00
nordic matt	3900 000 083	575.00			
gravel matt	3900 000 084	575.00			

Faucet information

Impact area approx. 3 $\frac{1}{8}$ – 4 $\frac{3}{8}$ " from rear edge of basin.
For parameters, see page 18.

SB . Terra360

Dish basin, round, \varnothing 14 $\frac{1}{8}$ ", height 5 $\frac{3}{8}$ ", glazed steel, without faucet hole, without overflow, included drain valve, valve cap, glazed in the basin color

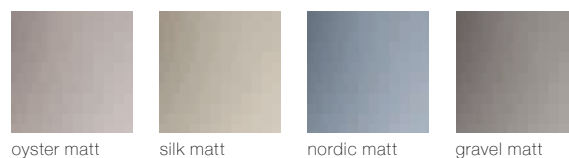
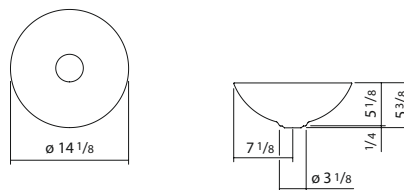

	Art.-No.	Price	Recommended article > s. p. 148	Art.-No.	Price
oyster matt	3901 000 081	633.00	Bottle trap, Sl.2	8306 000 978	314.00
silk matt	3901 000 082	633.00	Bottle trap, Sl.3	8312 000 978	288.00
nordic matt	3901 000 083	633.00			
gravel matt	3901 000 084	633.00			

Faucet information

Impact area approx. 3 $\frac{7}{8}$ – 5 $\frac{1}{2}$ " from rear edge of basin.
For parameters, see page 18.

Terra**SB . Terra450**

Dish basin, round, \varnothing 17 ³/₄", height 5 ⁷/₈", glazed steel, without faucet hole, without overflow, included drain valve, valve cap, glazed in the basin color

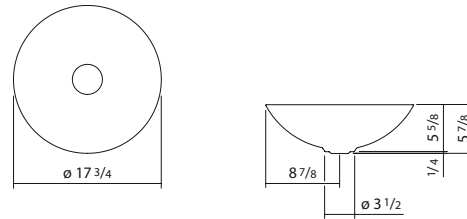

oyster matt



silk matt



nordic matt



gravel matt

	Art.-No.	Price	Recommended article > s. p. 148	Art.-No.	Price
oyster matt	3902 000 081	713.00	Bottle trap, Sl.2	8306 000 978	314.00
silk matt	3902 000 082	713.00	Bottle trap, Sl.3	8312 000 978	288.00
nordic matt	3902 000 083	713.00			
gravel matt	3902 000 084	713.00			

Faucet information

Impact area approx. 5 ¹/₈ – 7 ¹/₈" from rear edge of basin.
For parameters, see page 18.

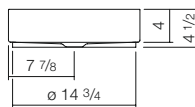
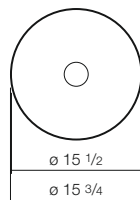
Bicolor**AB . KE400**

Sit-on basin, round, \varnothing 15 $\frac{3}{4}$ ", height 4 $\frac{1}{2}$ ", glazed steel, matt black/glossy white, without faucet hole, without overflow, included installation kit, drain valve, valve cap, white glazed, black spacer ring

	Art.-No.	Price	Recommended article > s. p. 148	Art.-No.	Price
matt black/glossy white	3222 000 180	1,020.00	Bottle trap, Sl.2	8306 000 978	314.00
			Bottle trap, Sl.3	8312 000 978	288.00

Faucet information

Impact area approx. 4 $\frac{1}{8}$ – 5 $\frac{7}{8}$ " from rear edge of basin.
For parameters, see page 18.

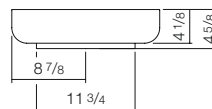
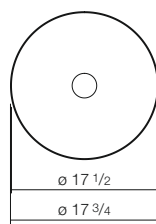
AB . S0450 . 1

Sit-on basin, round, \varnothing 17 $\frac{3}{4}$ ", height 4 $\frac{5}{8}$ ", glazed steel, matt black/glossy white, without faucet hole, without overflow, included installation kit, drain valve, valve cap, white glazed, black spacer ring

	Art.-No.	Price	Recommended article > s. p. 148	Art.-No.	Price
matt black/glossy white	3503 000 180	1,185.00	Bottle trap, Sl.2	8306 000 978	314.00
			Bottle trap, Sl.3	8312 000 978	288.00

Faucet information

Impact area approx. 2 $\frac{3}{8}$ – 6 $\frac{3}{4}$ " from rear edge of basin.
For parameters, see page 18.

Bicolor

All prices in US \$

Cut-out dimensions: Download www.alape.com**SB . K360 . GS**

Dish basin, round, \varnothing 14 1/8", height 5 1/8", glazed steel, matt black/glossy white, without faucet hole, without overflow, included drain valve, valve cap, white glazed, black spacer ring

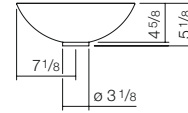
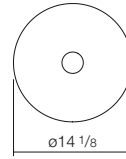

	Art.-No.	Price	Recommended article > s. p. 148	Art.-No.	Price
matt black/glossy white	3501 000 180	608.00	Bottle trap, Sl.2	8306 000 978	314.00
			Bottle trap, Sl.3	8312 000 978	288.00

Faucet information

Impact area approx. 3 7/8" – 5 1/2" from rear edge of basin.
For parameters, see page 18.

WT . RX400 . KE

Washstand, round, wxhxd 15 3/4 x 35 3/8 x 17 3/8", sink round, centred, \varnothing 15 1/2", sink 3 7/8", glazed steel, matt black/glossy white, without faucet hole, without overflow, included installation kit, drain valve, valve cap, white glazed, bottle trap, chrome-plated spacer ring, black wall bracket

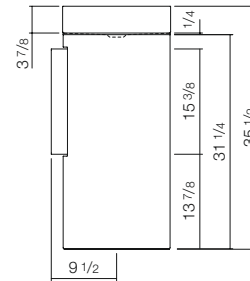
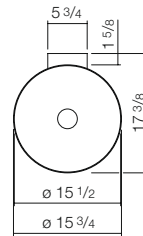

	Art.-No.	Price
bicolor	4506 500 180	3,760.00

Faucet information

Impact area approx. 5 3/4" – 7 1/2" from rear edge of basin.
For parameters, see page 18.

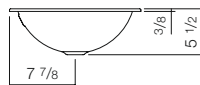
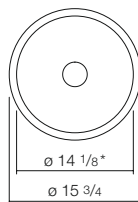
Metallic**UB . K400**

Undermount basin, round, $\varnothing 14 \frac{1}{8}$ ", height $5 \frac{1}{2}$ ", glazed steel, metallic, without faucet hole, without overflow, included installation kit, drain valve, valve cap, metallic dark iron glazed

	Art.-No.	Price	Recommended article > s. p. 148	Art.-No.	Price
dark iron	2031 500 190	340.00	Bottle trap, Sl.2	8306 000 978	314.00
			Bottle trap, Sl.3	8312 000 978	288.00

Faucet information

Impact area approx. $4 \frac{3}{8}$ – $5 \frac{7}{8}$ " from rear edge of basin.
For parameters, see page 18.

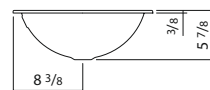
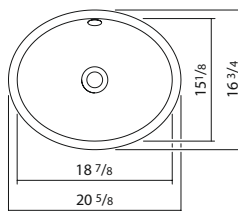
UB . 0525

Undermount basin, oval, wxhxd $18 \frac{7}{8}$ x $5 \frac{7}{8}$ x $15 \frac{1}{8}$ ", glazed steel, metallic, without faucet hole, without overflow, included installation kit, drain valve, valve cap, metallic dark iron glazed

	Art.-No.	Price	Recommended article > s. p. 148	Art.-No.	Price
dark iron	2111 500 190	361.00	Bottle trap, Sl.2	8306 000 978	314.00
			Bottle trap, Sl.3	8312 000 978	288.00

Faucet information

Impact area approx. $4 \frac{3}{4}$ – $6 \frac{1}{2}$ " from rear edge of basin.
For parameters, see page 18.

Metallic**AB.S0450.1**

Sit-on basin, round, \varnothing 17 $\frac{3}{4}$ ", height 4 $\frac{5}{8}$ ", glazed steel, metallic, without faucet hole, without overflow, included installation kit, drain valve, valve cap, metallic dark iron glazed, black spacer ring

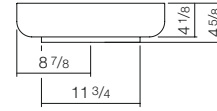
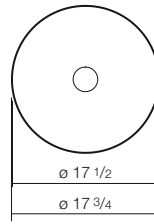

	Art.-No.	Price	Recommended article > s. p. 148	Art.-No.	Price
dark iron	3503 000 190	1,288.00	Bottle trap, Sl.2	8306 000 978	314.00
			Bottle trap, Sl.3	8312 000 978	288.00

Faucet information

Impact area approx. 2 $\frac{3}{8}$ – 6 $\frac{3}{4}$ " from rear edge of basin.
For parameters, see page 18.

SB.K360.GS

Dish basin, round, \varnothing 14 $\frac{1}{8}$ ", height 5 $\frac{1}{8}$ ", glazed steel, metallic, without faucet hole, without overflow, included drain valve, valve cap, metallic dark iron glazed, black spacer ring

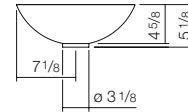
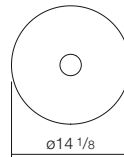

	Art.-No.	Price	Recommended article > s. p. 148	Art.-No.	Price
dark iron	3501 000 190	639.00	Bottle trap, Sl.2	8306 000 978	314.00
			Bottle trap, Sl.3	8312 000 978	288.00

Faucet information

Impact area approx. 3 $\frac{7}{8}$ – 5 $\frac{1}{2}$ " from rear edge of basin.
For parameters, see page 18.

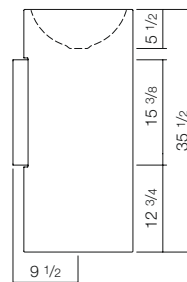
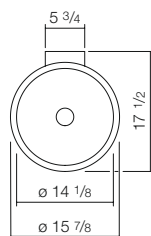
Metallic**WT .RX400K**

Washstand, round, wxhxd 15 7/8 x 35 1/2 x 17 1/2", sink round, centred, Ø 14 1/8", sink 5 1/2", glazed steel, metallic, without faucet hole, without overflow, included installation kit, drain valve, valve cap, metallic dark iron glazed, bottle trap, black wall bracket

	Art.-No.	Price
dark iron	4503 000 190	2,678.00

Faucet information

Impact area approx. 6 – 7 1/2" from rear edge of basin.
For parameters, see page 18.



Washstand
Metallic Dark Iron
WT. RX400K
15 7/8 x 35 1/2 x 17 1/2"

Washstands

WT



Scopio
Washstand
WT.RX400H.CO
400 x 900 x 500mm

Basin width

12 3/4"

15 3/4 - 23 5/8"

25 5/8 - 31 1/2"

39 3/8 - 49 1/4"



WT. RS325
ø 13" I.P. 99



WT. C0400
ø 15 3/4" I.P. 101



WT. C0400H
ø 15 3/4" I.P. 101



WT. RS400
ø 15 3/4" I.P. 99



WT. RS450
ø 17 3/4" I.P. 100



WT. RX400.KE
ø 15 3/4" I.P. 95



WT. RX400K
ø 15 7/8" I.P. 93/97



WT. RX400KH
ø 15 7/8" I.P. 92



WT. RX400H.CO
ø 15 3/4" I.P. 94



WT. RX400.CO
ø 15 3/4" I.P. 94



WT. RX325.KE
ø 12 3/4" I.P. 95



WT. RX325K
ø 13" I.P. 92/97

Columns

Columns

Round



WT. IC325H
12 3/4 x 12 3/4" I.P. 102



WT. QS325
12 3/4 x 12 3/4" I.P. 108

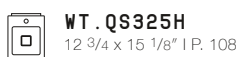

WT. QS325H
12 3/4 x 15 1/8" I.P. 108



WT. QS325X
13 x 13 3/4" I.P. 109

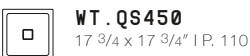

WT. QS450
17 3/4 x 17 3/4" I.P. 110

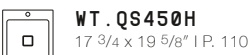

WT. QS450H
17 3/4 x 19 5/8" I.P. 110



WT. MC450H
17 3/4 x 17 7/8" I.P. 104

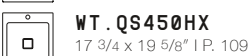

WT. QS450HX
17 3/4 x 19 5/8" I.P. 109



WT. XXS450.L/R
17 3/4 x 9 1/4" I.P. 106/107



WT. XXS450H.L/R
17 3/4 x 9 1/4" I.P. 106/107



WT. XS500.L/R
19 5/8 x 10 1/2" I.P. 113/114



WT. XS500H.L/R
19 5/8 x 10 1/2" I.P. 113/114



WT. QS525.L/R
20 5/8 x 12 3/4" I.P. 111/112

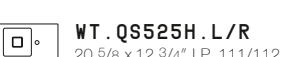

WT. QS525H.L/R
20 5/8 x 12 3/4" I.P. 111/112



WT. PR585
23 x 13 5/8" I.P. 116



WT. PR585H
23 x 16" I.P. 116

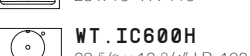

WT. IC600H
23 5/8 x 12 3/4" I.P. 102

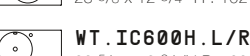

WT. IC600H.L/R
23 5/8 x 12 3/4" I.P. 103



WT. SR800H.L/R
31 1/2 x 18 5/8" I.P. 115



WT. MC800H
31 1/2 x 17 7/8" I.P. 104



WT. MC800H.L/R
31 1/2 x 17 7/8" I.P. 105



WT. RE800H
31 1/2 x 18 1/8" I.P. 122



WT. PR800
31 1/2 x 16" I.P. 117



WT. PR800H
31 1/2 x 16" I.P. 117



WT. PR800.L/R
31 1/2 x 16" I.P. 118/119



WT. PR800H.L/R
31 1/2 x 16" I.P. 118/119



WT. GR800H
31 1/2 x 19 5/8" I.P. 120



WT. RE1000H.L/R
39 3/8 x 18 1/8" I.P. 122/123



WT. GR1250H
49 1/4 x 19 5/8" I.P. 120



WT. GR1250H.L/R
49 1/4 x 19 5/8" I.P. 121

Columns

Columns

Square and rectangular



WT. RX325QS
13 x 13" I.P. 96/98

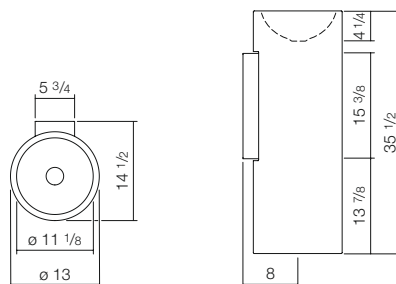

WT. RX450QS
17 7/8 x 17 7/8" I.P. 96/98

Floor-standing washstands – K-series – wall-mounted**WT . RX325K**

Washstand, round, wxhxd 13 x 35 1/2 x 14 1/2", sink round, centred, $\phi 11 \frac{1}{8}$ ", sink 4 3/8", glazed steel, without faucet hole, without overflow, included installation kit, drain valve, valve cap, chrome-plated, bottle trap, white wall bracket

	Art.-No.	Price	Version	Surcharge
white, ProShield	4501 000 000	2,266.00	Glossy, matte, special color	30 %

Faucet information

Impact area approx. 4 7/8 – 6 1/8" from rear edge of basin.
For parameters, see page 18.

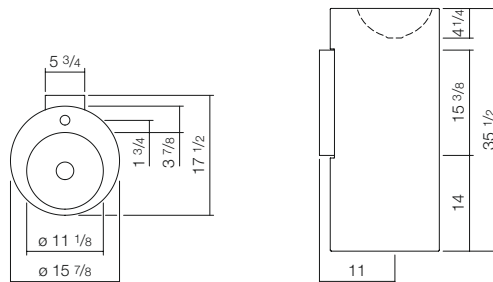
WT . RX400KH

Washstand, round, wxhxd 15 7/8 x 35 1/2 x 17 1/2", sink round, centred, $\phi 11 \frac{1}{8}$ ", sink 4 3/8", glazed steel, with one faucet hole, without overflow, included installation kit, drain valve, valve cap, chrome-plated, bottle trap, white wall bracket

	Art.-No.	Price	Version	Surcharge
white, ProShield	4500 000 000	2,524.00	Glossy, matte, special color	30 %

Faucet information

Impact area approx. 4 3/8 – 5 1/2" from middle faucet hole.
For parameters, see page 18.

Floor-standing washstands – K-series – wall-mounted

All prices in US \$

Mounting and connection measurements > see Page 153

WT .RX400K

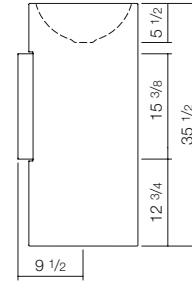
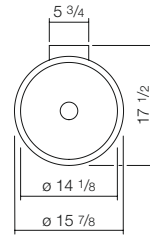

Washstand, round, wxhxd 15 7/8 x 35 1/2 x 17 1/2", sink round, centred, Ø 14 1/8", sink 5 1/2", glazed steel, without faucet hole, without overflow, included installation kit, drain valve, valve cap, chrome-plated, bottle trap, white wall bracket

	Art.-No.	Price	Version	Surcharge
white, ProShield	4503 000 000	2,472.00	Glossy, matte, special color	30 %

Faucet information

Impact area approx. 6 – 7 1/2" from rear edge of basin.
For parameters, see page 18.

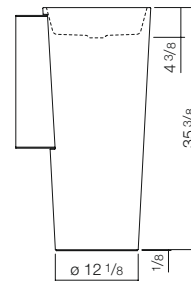
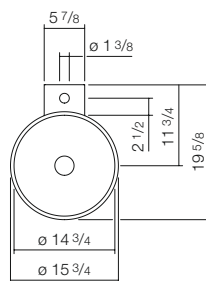
Floor-standing washstands – CO-series – wall-mounted**WT . RX400H . CO**

Washstand, round, wxhxd 15 3/4 x 35 1/2 x 19 5/8", sink round, centred, Ø 14 3/4", sink 4 3/8", glazed steel, with one faucet hole, without overflow, included installation kit, drain valve, valve cap, white glazed, bottle trap, white wall bracket

	Art.-No.	Price	Version	Surcharge
white, ProShield	4507 800 000	2,575.00	Glossy, matte, special color	30 %

Faucet information

Impact area approx. 6 3/8 – 7 3/4" from middle faucet hole.
For parameters, see page 18.

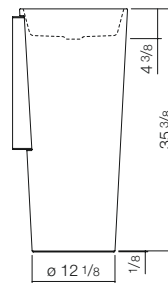
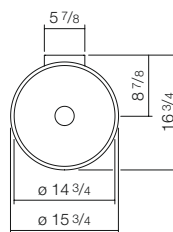
WT . RX400 . CO

Washstand, round, wxhxd 15 3/4 x 35 1/2 x 16 3/4", sink round, centred, Ø 14 3/4", sink 4 3/8", glazed steel, without faucet hole, without overflow, included installation kit, drain valve, valve cap, white glazed, bottle trap, white wall bracket

	Art.-No.	Price	Version	Surcharge
white, ProShield	4507 500 000	2,575.00	Glossy, matte, special color	30 %

Faucet information

Impact area approx. 5 3/8 – 6 3/4" from rear edge of basin.
For parameters, see page 18.

Floor-standing washstands – KE-series – wall-mounted

All prices in US \$

Mounting and connection measurements > see Page 153

WT . RX325 . KE

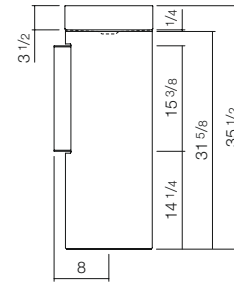
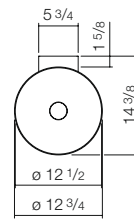

Washstand, round, wxhxd 12 3/4 x 35 1/2 x 14 3/8", sink round, centred, \varnothing 12 1/2", sink 3 1/2", glazed steel, without faucet hole, without overflow, included installation kit, drain valve, valve cap, chrome-plated, bottle trap, chrome-plated spacer ring, white wall bracket

	Art.-No.	Price	Version	Surcharge
white, ProShield	4505 500 000	3,296.00	Glossy, matte, special color	30 %

Faucet information

Impact area approx. 4 7/8 – 6 1/4" from rear edge of basin.
For parameters, see page 18.

WT . RX400 . KE

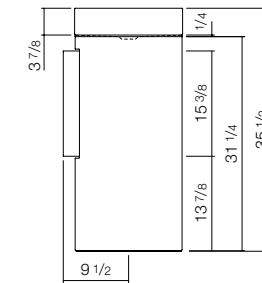
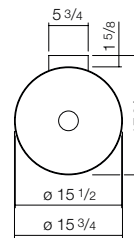

Washstand, round, wxhxd 15 3/4 x 35 1/2 x 17 3/8", sink round, centred, \varnothing 15 1/2", sink 3 7/8", glazed steel, without faucet hole, without overflow, included installation kit, drain valve, valve cap, chrome-plated, bottle trap, chrome-plated spacer ring, white wall bracket

	Art.-No.	Price	Version	Surcharge
white, ProShield	4506 500 000	3,605.00	Glossy, matte, special color	30 %

Faucet information

Impact area approx. 5 3/4 – 7 1/2" from rear edge of basin.
For parameters, see page 18.

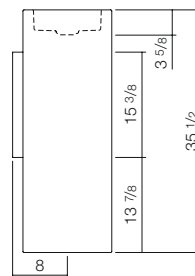
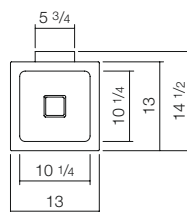
Floor-standing washstands – Q-series – wall-mounted**WT .RX325QS**

Washstand, square, wxhxd 13 x 35 1/2 x 14 1/2", sink square, centred, wxhxd 10 1/4 x 3 3/4 x 10 1/4", glazed steel, without faucet hole, without overflow, included installation kit, drain valve, valve cap, white glazed, bottle trap, white wall bracket

	Art.-No.	Price	Version	Surcharge
white, ProShield	4801 000 000	2,575.00	Glossy, matte, special color	30 %

Faucet information

Impact area approx. 5 – 5 7/8" from rear edge of basin.
For parameters, see page 18.

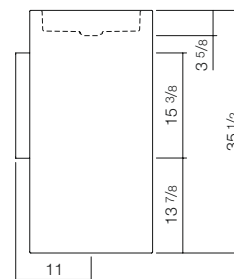
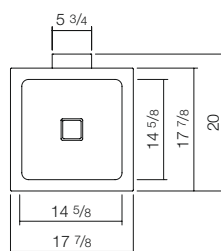
WT .RX450QS

Washstand, square, wxhxd 17 7/8 x 35 1/2 x 20", sink square, centred, wxhxd 14 5/8 x 3 3/4 x 14 5/8", glazed steel, without faucet hole, without overflow, included installation kit, drain valve, valve cap, white glazed, bottle trap, white wall bracket

	Art.-No.	Price	Version	Surcharge
white, ProShield	4804 000 000	3,811.00	Glossy, matte, special color	30 %

Faucet information

Impact area approx. 6 5/8 – 8 7/8" from rear edge of basin.
For parameters, see page 18.

Floor-standing washstands – K-series – freestanding

All prices in US \$

Mounting and connection measurements > see www.alape.com

WT . RX325K

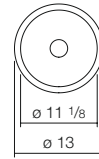

Washstand, round, wxhxd 13 x 35 1/2 x 13", sink round, centred, Ø 11 1/8", sink 4 3/8", glazed steel, without faucet hole, without overflow, included installation kit, drain valve, valve cap, chrome-plated, bottle trap, floor bracket

	Art.-No.	Price	Version	Surcharge
white, ProShield	4502 000 000	2,266.00	Glossy, matte, special color	30 %

Faucet information

Impact area approx. 3 3/8 – 4 5/8" from rear edge of basin.
For parameters, see page 18.

WT . RX400K

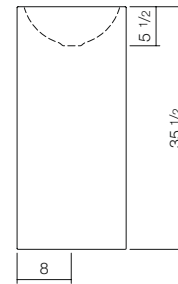
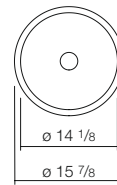

Washstand, round, wxhxd 15 7/8 x 35 1/2 x 15 7/8", sink round, centred, Ø 14 1/8", sink 5 1/2", glazed steel, without faucet hole, without overflow, included installation kit, drain valve, valve cap, chrome-plated, bottle trap, floor bracket

	Art.-No.	Price	Version	Surcharge
white, ProShield	4504 000 000	2,472.00	Glossy, matte, special color	30 %

Faucet information

Impact area approx. 4 3/8 – 6" from rear edge of basin.
For parameters, see page 18.

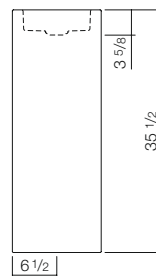
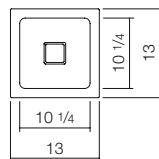
Floor-standing washstands – Q-series – freestanding**WT . RX325QS**

Washstand, square, wxhxd 13 x 35 1/2 x 13", sink square, centred, wxhxd 10 1/4 x 3 3/4 x 10 1/4", glazed steel, without faucet hole, without overflow, included installation kit, drain valve, valve cap, white glazed, bottle trap, floor bracket

	Art.-No.	Price	Version	Surcharge
white, ProShield	4802 000 000	2,472.00	Glossy, matte, special color	30 %

Faucet information

Impact area approx. 3 1/2 – 4 3/8" from rear edge of basin.
For parameters, see page 18.

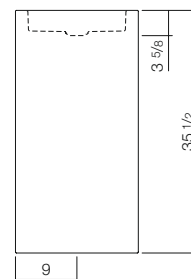
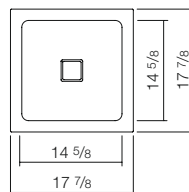
WT . RX450QS

Washstand, square, wxhxd 17 7/8 x 35 1/2 x 17 7/8", sink square, centred, wxhxd 14 5/8 x 3 3/4 x 14 5/8", glazed steel, without faucet hole, without overflow, included installation kit, drain valve, valve cap, white glazed, bottle trap, floor bracket

	Art.-No.	Price	Version	Surcharge
white, ProShield	4805 000 000	3,811.00	Glossy, matte, special color	30 %

Faucet information

Impact area approx. 4 5/8 – 6 3/4" from rear edge of basin.
For parameters, see page 18.

Washstands – RS-series

All prices in US \$

Mounting and connection measurements > see Page 154

WT . RS325

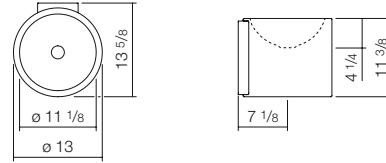

Washstand, round, wxhxd 13 x 11 ³/₈ x 13 ⁵/₈", sink round, centred, Ø 11 ¹/₈", sink 4 ³/₈", glazed steel, without faucet hole, without overflow, included installation kit, white wall bracket

	Art.-No.	Price	Version	Surcharge
white	5042 000 000	1,545.00	Glossy, matte, special color	30 %

Faucet information

Impact area approx. 4 ¹/₈ – 5 ³/₈" from rear edge of basin.
For parameters, see page 18.

Recommended article > s. p. 148

	Art.-No.	Price
Bottle trap, Sl.2	8306 000 978	314.00
Bottle trap, Sl.3	8312 000 978	288.00
Drain valve, VT.2	8309 000 000	237.00

WT . RS400

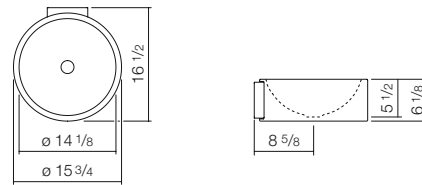

Washstand, round, wxhxd 15 ³/₄ x 6 ¹/₈ x 16 ¹/₂", sink round, centred, Ø 14 ¹/₈", sink 5 ¹/₂", glazed steel, without faucet hole, without overflow, included installation kit, white wall bracket

	Art.-No.	Price	Version	Surcharge
white, ProShield	5052 000 000	1,545.00	Glossy, matte, special color	30 %

Faucet information

Impact area approx. 5 ¹/₈ – 6 ³/₄" from rear edge of basin.
For parameters, see page 18.

Recommended article > s. p. 148

	Art.-No.	Price
Bottle trap, Sl.2	8306 000 978	314.00
Bottle trap, Sl.3	8312 000 978	288.00
Drain valve, VT.3	8310 000 000	252.00

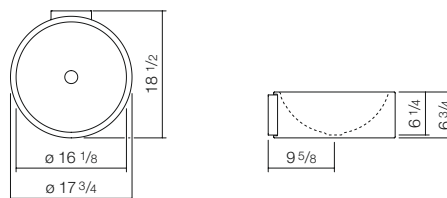
Washstands – RS-series**WT . RS450**

Washstand, round, wxhxd 17 3/4 x 6 3/4 x 18 1/2", sink round, centred, Ø 16 1/8", sink 6 1/4", glazed steel, without faucet hole, without overflow, included installation kit, white wall bracket

	Art.-No.	Price	Version	Surcharge
white, ProShield	5054 000 000	1,648.00	Glossy, matte, special color	30 %

Faucet information

Impact area approx. 5 1/8 – 7 1/2" from rear edge of basin.
For parameters, see page 18.

Recommended article > s. p. 148

	Art.-No.	Price
Bottle trap, SI.2	8306 000 978	314.00
Bottle trap, SI.3	8312 000 978	288.00
Drain valve, VT.3	8310 000 000	252.00

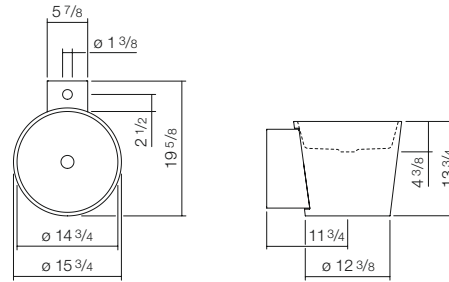
Washstands – CO-series (Scopio)**WT . C0400H**

Washstand, round, wxhxd 15 3/4 x 13 3/4 x 19 5/8", sink round, centred, Ø 14 3/4", sink 4 3/8", glazed steel, with one faucet hole, without overflow, included installation kit, drain valve, valve cap, white glazed, white wall bracket

	Art.-No.	Price	Version	Surcharge
white, ProShield	5042 800 000	1,700.00	Glossy, matte, special color	30 %

Faucet information

Impact area approx. 6 3/8 – 7 3/4" from middle faucet hole.
For parameters, see page 18.

Recommended article > s. p. 148

	Art.-No.	Price
Bottle trap, Sl.2	8306 000 978	314.00
Bottle trap, Sl.3	8312 000 978	288.00

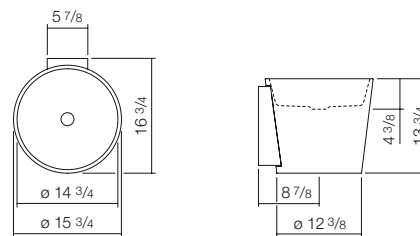
WT . C0400

Washstand, round, wxhxd 15 3/4 x 13 3/4 x 16 3/4", sink round, centred, Ø 14 3/4", sink 4 3/8", glazed steel, without faucet hole, without overflow, included installation kit, drain valve, valve cap, white glazed, white wall bracket

	Art.-No.	Price	Version	Surcharge
white, ProShield	5042 500 000	1,700.00	Glossy, matte, special color	30 %

Faucet information

Impact area approx. 5 3/8 – 6 3/4" from rear edge of basin.
For parameters, see page 18.

Recommended article > s. p. 148

	Art.-No.	Price
Bottle trap, Sl.2	8306 000 978	314.00
Bottle trap, Sl.3	8312 000 978	288.00

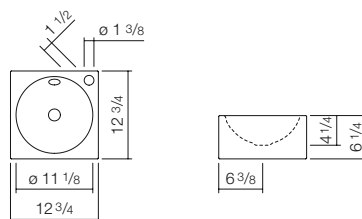
Washstands – IC-series**WT . IC325H**

Washstand, square, wxhxd 12 3/4 x 6 1/4 x 12 3/4", sink round, centred, Ø 11 1/8", sink 4 3/8", glazed steel, with one faucet hole, with overflow, included installation kit, overflow set

	Art.-No.	Price	Version	Surcharge
white, ProShield	4236 200 000	1,185.00	Without overflow	20 %
			Glossy, matte, special color	30 %

Faucet information

Impact area approx. 4 1/8 – 5 1/4" from middle faucet hole.
For parameters, see page 18.

Recommended article > s. p. 148

	Art.-No.	Price
Bottle trap, Sl.2	8306 000 978	314.00
Bottle trap, Sl.3	8312 000 978	288.00
Drain valve, VT.1	8302 000 978	247.00

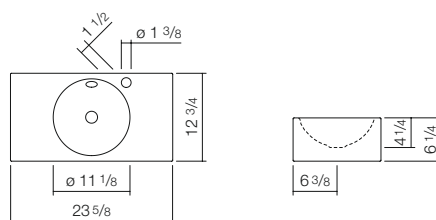
WT . IC600H

Washstand, rectangular, wxhxd 23 5/8 x 6 1/4 x 12 3/4", sink round, centred, Ø 11 1/8", sink 4 3/8", glazed steel, with one faucet hole, with overflow, included installation kit, overflow set

	Art.-No.	Price	Version	Surcharge
white, ProShield	4238 200 000	1,391.00	Without faucet hole	20 %
			Without overflow	20 %
			Glossy, matte, special color	30 %

Faucet information

Impact area approx. 4 1/8 – 5 1/4" from middle faucet hole.
For parameters, see page 18.

Recommended article > s. p. 148

	Art.-No.	Price
Bottle trap, Sl.2	8306 000 978	314.00
Bottle trap, Sl.3	8312 000 978	288.00
Drain valve, VT.1	8302 000 978	247.00

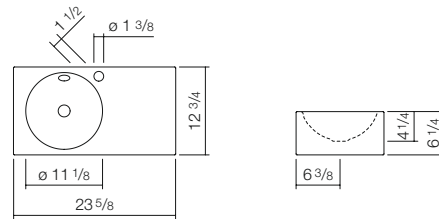
Washstands – IC-series**WT . IC600H . L**

Washstand, rectangular, wxhxd 23 5/8 x 6 1/4 x 12 3/4", sink round, left, Ø 11 1/8", sink 4 3/8", glazed steel, with one faucet hole, with overflow, included installation kit, overflow set

	Art.-No.	Price	Version	Surcharge
white, ProShield	4239 200 000	1,391.00	Without faucet hole	20 %
			Without overflow	20 %
			Glossy, matte, special color	30 %

Faucet information

Impact area approx. 4 1/8 – 5 1/4" from middle faucet hole.
For parameters, see page 18.

Recommended article > s. p. 148

	Art.-No.	Price
Bottle trap, Sl.2	8306 000 978	314.00
Bottle trap, Sl.3	8312 000 978	288.00
Drain valve, VT.1	8302 000 978	247.00

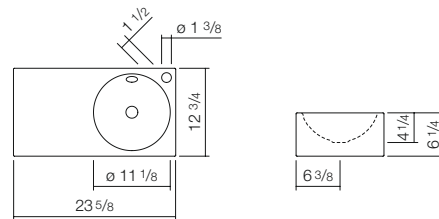
WT . IC600H . R

Washstand, rectangular, wxhxd 23 5/8 x 6 1/4 x 12 3/4", sink round, right, Ø 11 1/8", sink 4 3/8", glazed steel, with one faucet hole, with overflow, included installation kit, overflow set

	Art.-No.	Price	Version	Surcharge
white, ProShield	4240 200 000	1,391.00	Without faucet hole	20 %
			Without overflow	20 %
			Glossy, matte, special color	30 %

Faucet information

Impact area approx. 4 1/8 – 5 1/4" from middle faucet hole.
For parameters, see page 18.

Recommended article > s. p. 148

	Art.-No.	Price
Bottle trap, Sl.2	8306 000 978	314.00
Bottle trap, Sl.3	8312 000 978	288.00
Drain valve, VT.1	8302 000 978	247.00

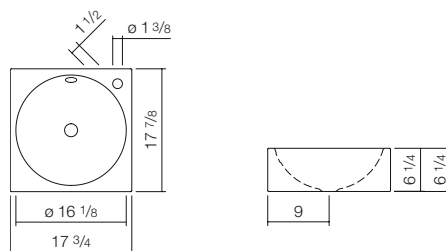
Washstands – MC-series**WT . MC450H**

Washstand, rectangular, wxhxd 17 3/4 x 6 1/4 x 17 7/8", sink round, centred, Ø 16 1/8", sink 6 1/4", glazed steel, with one faucet hole, with overflow, included installation kit, overflow set

	Art.-No.	Price	Version	Surcharge
white, ProShield	4228 000 000	1,236.00	Without overflow	20 %
			Glossy, matte, special color	30 %

Faucet information

Impact area approx. 5 1/8 – 7 1/2" from middle faucet hole.
For parameters, see page 18.

Recommended article > s. p. 148

	Art.-No.	Price
Bottle trap, Sl.2	8306 000 978	314.00
Bottle trap, Sl.3	8312 000 978	288.00
Drain valve, VT.1	8302 000 978	247.00

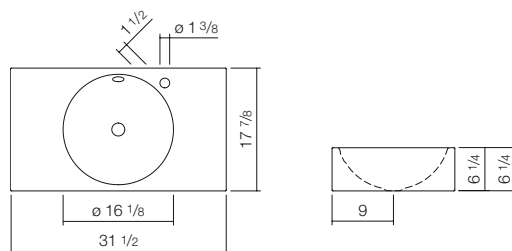
WT . MC800H

Washstand, rectangular, wxhxd 31 1/2 x 6 1/4 x 17 7/8", sink round, centred, Ø 16 1/8", sink 6 1/4", glazed steel, with one faucet hole, with overflow, included installation kit, overflow set

	Art.-No.	Price	Version	Surcharge
white, ProShield	4230 000 000	1,442.00	Without overflow	20 %
			Glossy, matte, special color	30 %

Faucet information

Impact area approx. 5 1/8 – 7 1/2" from middle faucet hole.
For parameters, see page 18.

Recommended article > s. p. 148

	Art.-No.	Price
Bottle trap, Sl.2	8306 000 978	314.00
Bottle trap, Sl.3	8312 000 978	288.00
Drain valve, VT.1	8302 000 978	247.00

Washstands – MC-series**WT . MC800H . L**

Washstand, rectangular, wxhxd 31 1/2 x 6 1/4 x 17 7/8", sink round, left, Ø 16 1/8", sink 6 1/4", glazed steel, with one faucet hole, with overflow, included installation kit, overflow set

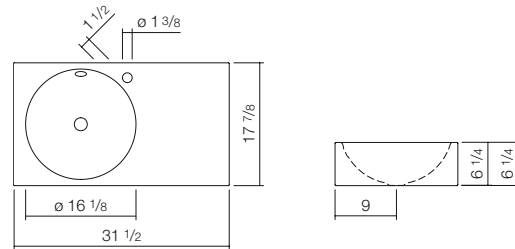

	Art.-No.	Price	Version	Surcharge
white, ProShield	4231 000 000	1,442.00	Without faucet hole	20 %
			Without overflow	20 %
			Glossy, matte, special color	30 %

Faucet information

Impact area approx. 5 1/8 – 7 1/2" from middle faucet hole.
For parameters, see page 18.

Recommended article > s. p. 148

	Art.-No.	Price
Bottle trap, Sl.2	8306 000 978	314.00
Bottle trap, Sl.3	8312 000 978	288.00
Drain valve, VT.1	8302 000 978	247.00

WT . MC800H . R

Washstand, rectangular, wxhxd 31 1/2 x 6 1/4 x 17 7/8", sink round, right, Ø 16 1/8", sink 6 1/4", glazed steel, with one faucet hole, with overflow, included installation kit, overflow set

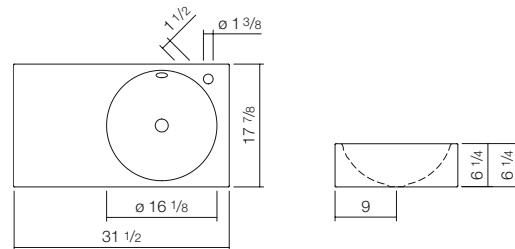

	Art.-No.	Price	Version	Surcharge
white, ProShield	4232 000 000	1,442.00	Without faucet hole	20 %
			Without overflow	20 %
			Glossy, matte, special color	30 %

Faucet information

Impact area approx. 5 1/8 – 7 1/2" from middle faucet hole.
For parameters, see page 18.

Recommended article > s. p. 148

	Art.-No.	Price
Bottle trap, Sl.2	8306 000 978	314.00
Bottle trap, Sl.3	8312 000 978	288.00
Drain valve, VT.1	8302 000 978	247.00

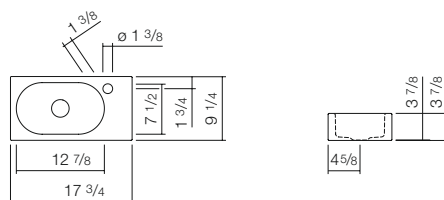
Washstands – XXS-series (Fusion.S)**WT . XXS450H . L**

Washstand, rectangular, wxhxd 17 3/4 x 3 7/8 x 9 1/4", sink oval, left, wxhxd 12 7/8 x 3 7/8 x 7 1/2", glazed steel, with one faucet hole, without overflow, included installation kit, drain valve, valve cap, chrome-plated

	Art.-No.	Price	Version	Surcharge
white, ProShield	4295 000 000	1,082.00	Glossy, matte, special color	30 %

Faucet information

Impact area approx. 2 3/4 – 5 3/4" from middle faucet hole.
For parameters, see page 18.

Recommended article > s. p. 148

	Art.-No.	Price
Bottle trap, Sl.2	8306 000 978	314.00
Bottle trap, Sl.3	8312 000 978	288.00

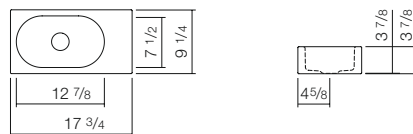
WT . XXS450 . L

Washstand, rectangular, wxhxd 17 3/4 x 3 7/8 x 9 1/4", sink oval, left, wxhxd 12 7/8 x 3 7/8 x 7 1/2", glazed steel, without faucet hole, without overflow, included installation kit, drain valve, valve cap, chrome-plated

	Art.-No.	Price	Version	Surcharge
white, ProShield	4296 000 000	1,030.00	Glossy, matte, special color	30 %

Faucet information

Impact area approx. 2 3/8 – 3" from rear edge of basin.
For parameters, see page 18.

Recommended article > s. p. 148

	Art.-No.	Price
Bottle trap, Sl.2	8306 000 978	314.00
Bottle trap, Sl.3	8312 000 978	288.00

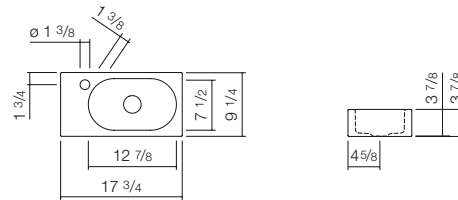
Washstands – XXS-series (Fusion.S)**WT . XXS450H . R**

Washstand, rectangular, wxhxd 17 3/4 x 3 7/8 x 9 1/4", sink oval, right, wxhxd 12 7/8 x 3 7/8 x 7 1/2", glazed steel, with one faucet hole, without overflow, included installation kit, drain valve, valve cap, chrome-plated

	Art.-No.	Price	Version	Surcharge
white, ProShield	4297 000 000	1,082.00	Glossy, matte, special color	30 %

Faucet information

Impact area approx. 2 3/4 – 5 3/4" from middle faucet hole.
For parameters, see page 18.

Recommended article > s. p. 148

	Art.-No.	Price
Bottle trap, Sl.2	8306 000 978	314.00
Bottle trap, Sl.3	8312 000 978	288.00

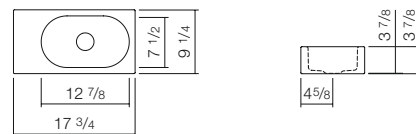
WT . XXS450 . R

Washstand, rectangular, wxhxd 17 3/4 x 3 7/8 x 9 1/4", sink oval, right, wxhxd 12 7/8 x 3 7/8 x 7 1/2", glazed steel, without faucet hole, without overflow, included installation kit, drain valve, valve cap, chrome-plated

	Art.-No.	Price	Version	Surcharge
white, ProShield	4298 000 000	1,030.00	Glossy, matte, special color	30 %

Faucet information

Impact area approx. 2 3/8 – 3" from rear edge of basin.
For parameters, see page 18.

Recommended article > s. p. 148

	Art.-No.	Price
Bottle trap, Sl.2	8306 000 978	314.00
Bottle trap, Sl.3	8312 000 978	288.00

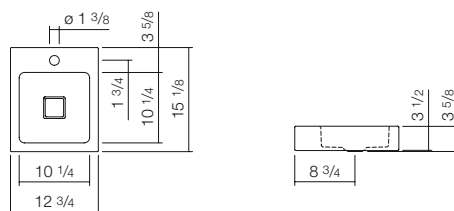
Washstands – Q-series**WT . QS325H**

Washstand, rectangular, wxhxd 12 3/4 x 3 5/8 x 15 1/8", sink square, centred, wxhxd 10 1/4 x 3 1/2 x 10 1/4", glazed steel, with one faucet hole, without overflow, included installation kit, drain valve, valve cap, white glazed

	Art.-No.	Price	Version	Surcharge
white, ProShield	4277 000 000	979.00	Without faucet hole	20 %
			3 Drill holes	20 %
			Drill hole for lotion dispenser	20 %
			Glossy, matte, special color	30 %

Faucet information

Impact area approx. 3 7/8 – 4 3/4" from middle faucet hole.
For parameters, see page 18.

Recommended article > s. p. 148

Art.-No.	Price
8306 000 978	314.00
8312 000 978	288.00

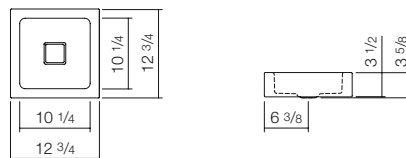
WT . QS325

Washstand, square, wxhxd 12 3/4 x 3 5/8 x 12 3/4", sink square, centred, wxhxd 10 1/4 x 3 1/2 x 10 1/4", glazed steel, without faucet hole, without overflow, included installation kit, drain valve, valve cap, white glazed

	Art.-No.	Price	Version	Surcharge
white, ProShield	4270 000 000	979.00	Glossy, matte, special color	30 %

Faucet information

Impact area approx. 3 1/2 – 4 1/4" from rear edge of basin.
For parameters, see page 18.

Recommended article > s. p. 148

Art.-No.	Price
8306 000 978	314.00
8312 000 978	288.00

Washstands – Q-series

All prices in US \$

Mounting and connection measurements > see Page 157

WT . QS325X

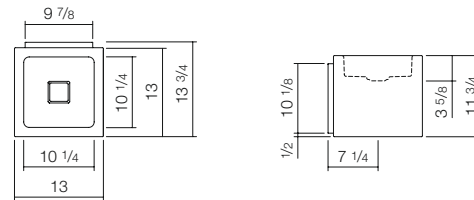

Washstand, square, wxhxd 13 x 11 3/4 x 13 3/4", sink square, centred, wxhxd 10 1/4 x 3 1/2 x 10 1/4", glazed steel, without faucet hole, without overflow, included installation kit, drain valve, valve cap, white glazed

	Art.-No.	Price	Version	Surcharge
white	4272 000 000	2,009.00	Glossy, matte, special color	30 %

Faucet information

Impact area approx. 4 3/8 – 5 1/8" from rear edge of basin.
For parameters, see page 18.

WT . QS450HX

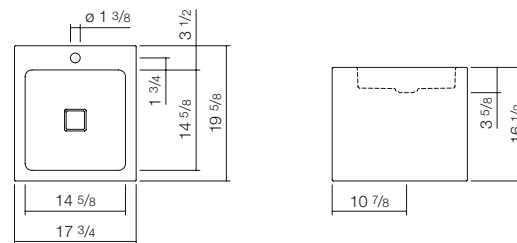

Washstand, rectangular, wxhxd 17 3/4 x 16 1/2 x 19 5/8", sink square, centred, wxhxd 14 5/8 x 3 3/4 x 14 5/8", glazed steel, with one faucet hole, without overflow, included installation kit, drain valve, valve cap, white glazed

	Art.-No.	Price	Version	Surcharge
white, ProShield	4278 000 000	2,060.00	Without faucet hole	20 %
			3 Drill holes	20 %
			Drill hole for lotion dispenser	20 %
			Glossy, matte, special color	30 %

Faucet information

Impact area approx. 4 3/4 – 6 7/8" from middle faucet hole.
For parameters, see page 18.

Recommended article > s. p. 148	Art.-No.	Price
Bottle trap, Sl.3	8312 000 978	288.00
Bottle trap, Sl.2	8306 000 978	314.00

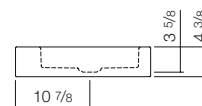
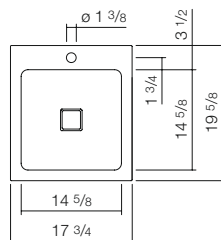
Washstands – Q-series**WT . QS450H**

Washstand, rectangular, wxhxd 17 3/4 x 4 3/8 x 19 5/8", sink square, centred, wxhxd 14 5/8 x 3 3/4 x 14 5/8", glazed steel, with one faucet hole, without overflow, included installation kit, drain valve, valve cap, white glazed

	Art.-No.	Price	Version	Surcharge
white, ProShield	4276 000 000	1,082.00	Without faucet hole	20 %
			3 Drill holes	20 %
			Drill hole for lotion dispenser	20 %
			Glossy, matte, special color	30 %

Faucet information

Impact area approx. 4 3/4 – 6 7/8" from middle faucet hole.
For parameters, see page 18.

Recommended article > s. p. 148

Art.-No.	Price
8306 000 978	314.00
8312 000 978	288.00

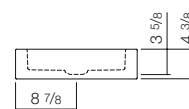
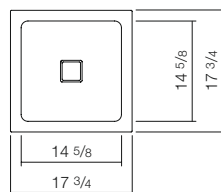
WT . QS450

Washstand, square, wxhxd 17 3/4 x 4 3/8 x 17 3/4", sink square, centred, wxhxd 14 5/8 x 3 3/4 x 14 5/8", glazed steel, without faucet hole, without overflow, included installation kit, drain valve, valve cap, white glazed

	Art.-No.	Price	Version	Surcharge
white, ProShield	4275 000 000	1,030.00	Glossy, matte, special color	30 %

Faucet information

Impact area approx. 4 1/2 – 6 3/4" from rear edge of basin.
For parameters, see page 18.

Recommended article > s. p. 148

Art.-No.	Price
8306 000 978	314.00
8312 000 978	288.00

Washstands – Q-series

WT . QS525H . L

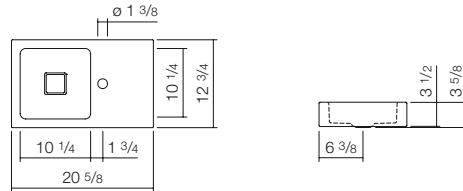

Washstand, rectangular, wxhxd 20 5/8 x 3 5/8 x 12 3/4", sink square, left, wxhxd 10 1/4 x 3 1/2 x 10 1/4", glazed steel, with one faucet hole, without overflow, included installation kit, drain valve, valve cap, white glazed

	Art.-No.	Price	Version	Surcharge
white, ProShield	4279 000 000	1,288.00	Glossy, matte, special color	30 %

Faucet information

Impact area approx. 3 7/8 – 4 3/4" from middle faucet hole.
For parameters, see page 18.

Recommended article > s. p. 148

	Art.-No.	Price
Bottle trap, Sl.2	8306 000 978	314.00
Bottle trap, Sl.3	8312 000 978	288.00

WT . QS525 . L

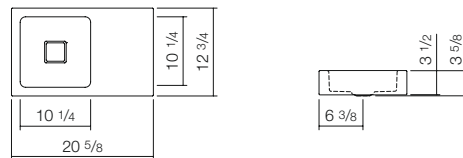

Washstand, rectangular, wxhxd 20 5/8 x 3 5/8 x 12 3/4", sink square, left, wxhxd 10 1/4 x 3 1/2 x 10 1/4", glazed steel, without faucet hole, without overflow, included installation kit, drain valve, valve cap, white glazed

	Art.-No.	Price	Version	Surcharge
white, ProShield	4273 000 000	1,236.00	Glossy, matte, special color	30 %

Faucet information

Impact area approx. 3 1/2 – 4 1/4" from rear edge of basin.
For parameters, see page 18.

Recommended article > s. p. 148

	Art.-No.	Price
Bottle trap, Sl.2	8306 000 978	314.00
Bottle trap, Sl.3	8312 000 978	288.00

Washstands – Q-series

WT . QS525H . R

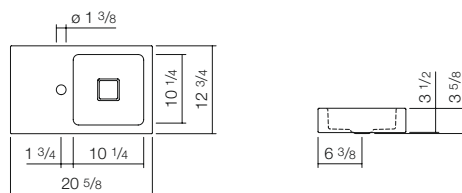

Washstand, rectangular, wxhxd $20 \frac{5}{8} \times 3 \frac{5}{8} \times 12 \frac{3}{4}$ ", sink square, right, wxhxd $10 \frac{1}{4} \times 3 \frac{1}{2} \times 10 \frac{1}{4}$ ", glazed steel, with one faucet hole, without overflow, included installation kit, drain valve, valve cap, white glazed

	Art.-No.	Price	Version	Surcharge
white, ProShield	4280 000 000	1,288.00	Glossy, matte, special color	30 %

Faucet information

Impact area approx. $3 \frac{7}{8} - 4 \frac{3}{4}$ " from middle faucet hole.
For parameters, see page 18.

Recommended article > s. p. 148

	Art.-No.	Price
Bottle trap, Sl.2	8306 000 978	314.00
Bottle trap, Sl.3	8312 000 978	288.00

WT . QS525 . R

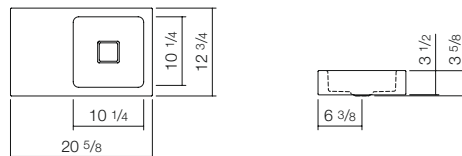

Washstand, rectangular, wxhxd $20 \frac{5}{8} \times 3 \frac{5}{8} \times 12 \frac{3}{4}$ ", sink square, right, wxhxd $10 \frac{1}{4} \times 3 \frac{1}{2} \times 10 \frac{1}{4}$ ", glazed steel, without faucet hole, without overflow, included installation kit, drain valve, valve cap, white glazed

	Art.-No.	Price	Version	Surcharge
white, ProShield	4274 000 000	1,236.00	Glossy, matte, special color	30 %

Faucet information

Impact area approx. $3 \frac{1}{2} - 4 \frac{1}{4}$ " from rear edge of basin.
For parameters, see page 18.

Recommended article > s. p. 148

	Art.-No.	Price
Bottle trap, Sl.2	8306 000 978	314.00
Bottle trap, Sl.3	8312 000 978	288.00

Washstands – XS-series (X.plore.S)

WT . XS500H . L

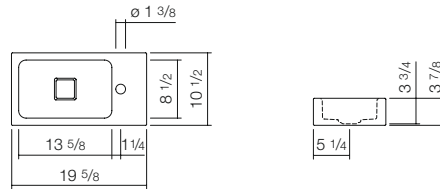

Washstand, rectangular, wxhxd 19 5/8 x 3 7/8 x 10 1/2", sink rectangular, left, wxhxd 13 5/8 x 3 3/4 x 8 1/2", glazed steel, with one faucet hole, without overflow, included installation kit, drain valve, valve cap, white glazed

	Art.-No.	Price	Version	Surcharge
white, ProShield	4290 000 000	1,082.00	Glossy, matte, special color	30 %

Faucet information

Impact area approx. 4 3/8 – 8 1/8" from middle faucet hole.
For parameters, see page 18.

Recommended article > s. p. 148

	Art.-No.	Price
Bottle trap, Sl.2	8306 000 978	314.00
Bottle trap, Sl.3	8312 000 978	288.00

WT . XS500 . L

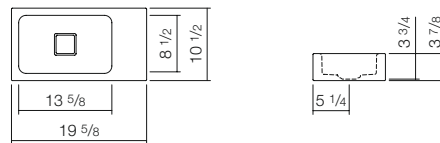

Washstand, rectangular, wxhxd 19 5/8 x 3 7/8 x 10 1/2", sink rectangular, left, wxhxd 13 5/8 x 3 3/4 x 8 1/2", glazed steel, without faucet hole, without overflow, included installation kit, drain valve, valve cap, white glazed

	Art.-No.	Price	Version	Surcharge
white, ProShield	4291 000 000	1,030.00	Glossy, matte, special color	30 %

Faucet information

Impact area approx. 3 – 5 3/8" from rear edge of basin.
For parameters, see page 18.

Recommended article > s. p. 148

	Art.-No.	Price
Bottle trap, Sl.2	8306 000 978	314.00
Bottle trap, Sl.3	8312 000 978	288.00

Washstands – XS-series (X.plore.S)

WT . XS500H . R

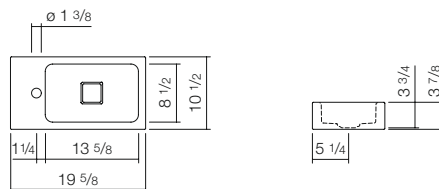

Washstand, rectangular, wxhxd 19 5/8 x 3 7/8 x 10 1/2", sink rectangular, right, wxhxd 13 5/8 x 3 3/4 x 8 1/2", glazed steel, with one faucet hole, without overflow, included installation kit, drain valve, valve cap, white glazed

	Art.-No.	Price	Version	Surcharge
white, ProShield	4292 000 000	1,082.00	Glossy, matte, special color	30 %

Faucet information

Impact area approx. 4 3/8 – 8 1/8" from middle faucet hole.
For parameters, see page 18.

Recommended article > s. p. 148

	Art.-No.	Price
Bottle trap, Sl.2	8306 000 978	314.00
Bottle trap, Sl.3	8312 000 978	288.00

WT . XS500 . R

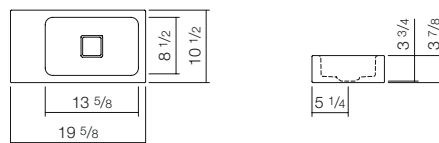

Washstand, rectangular, wxhxd 19 5/8 x 3 7/8 x 10 1/2", sink rectangular, right, wxhxd 13 5/8 x 3 3/4 x 8 1/2", glazed steel, without faucet hole, without overflow, included installation kit, drain valve, valve cap, white glazed

	Art.-No.	Price	Version	Surcharge
white, ProShield	4293 000 000	1,030.00	Glossy, matte, special color	30 %

Faucet information

Impact area approx. 3 – 5 3/8" from rear edge of basin.
For parameters, see page 18.

Recommended article > s. p. 148

	Art.-No.	Price
Bottle trap, Sl.2	8306 000 978	314.00
Bottle trap, Sl.3	8312 000 978	288.00

Washstands – SR-series (Stream)

WT . SR800H . L



Washstand, rectangular, wxhxd 31 1/2 x 5 x 18 5/8", sink rectangular, left, wxhxd 24 x 3 7/8 x 14 1/8", glazed steel, with one faucet hole, with overflow, included installation kit, overflow set

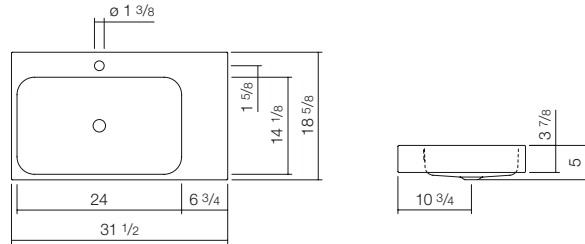

	Art.-No.	Price	Version	Surcharge
white, ProShield	4281 600 000	1,442.00	Without faucet hole	20 %
			Without overflow	20 %
			3 Drill holes	20 %
			Drill hole for lotion dispenser	20 %
			Glossy, matte, special color	30 %

Faucet information

Impact area approx. 4 1/8 – 6 1/8" from middle faucet hole.
For parameters, see page 18.

Recommended article > s. p. 148	Art.-No.	Price
Bottle trap, Sl.2	8306 000 978	314.00
Bottle trap, Sl.3	8312 000 978	288.00
Drain valve, VT.1	8302 000 978	247.00

WT . SR800H . R



Washstand, rectangular, wxhxd 31 1/2 x 5 x 18 5/8", sink rectangular, right, wxhxd 24 x 3 7/8 x 14 1/8", glazed steel, with one faucet hole, with overflow, included installation kit, overflow set

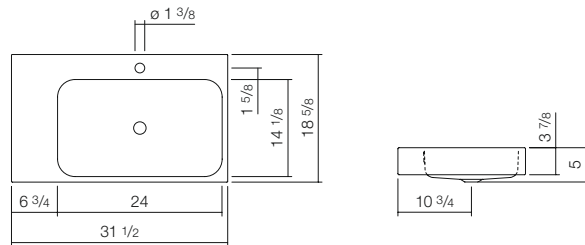

	Art.-No.	Price	Version	Surcharge
white, ProShield	4282 600 000	1,442.00	Without faucet hole	20 %
			Without overflow	20 %
			3 Drill holes	20 %
			Drill hole for lotion dispenser	20 %
			Glossy, matte, special color	30 %

Faucet information

Impact area approx. 4 1/8 – 6 1/8" from middle faucet hole.
For parameters, see page 18.

Recommended article > s. p. 148	Art.-No.	Price
Bottle trap, Sl.2	8306 000 978	314.00
Bottle trap, Sl.3	8312 000 978	288.00
Drain valve, VT.1	8302 000 978	247.00

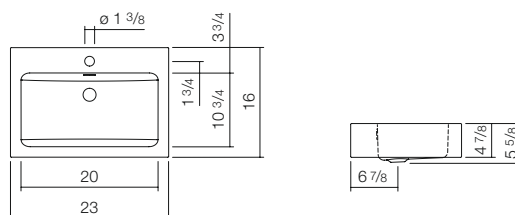
Washstands – PR-series**WT . PR585H**

Washstand, rectangular, wxhxd 23 x 5 5/8 x 16", sink rectangular, centred, wxhxd 20 x 4 7/8 x 10 3/4", glazed steel, with one faucet hole, with overflow, included installation kit, overflow set

	Art.-No.	Price	Version	Surcharge
white, ProShield	4201 000 000	1,133.00	Without faucet hole	20 %
			Without overflow	20 %
			3 Drill holes	20 %
			Drill hole for lotion dispenser	20 %
			Glossy, matte, special color	30 %
Faucet information			Recommended article > s. p. 148	Art.-No.
Impact area approx. 6 5/8 – 7 3/8" from middle faucet hole.			Bottle trap, Sl.2	8306 000 978
For parameters, see page 18.			Bottle trap, Sl.3	8312 000 978
			Drain valve, VT.1	8302 000 978
				Price
				314.00
				288.00
				247.00

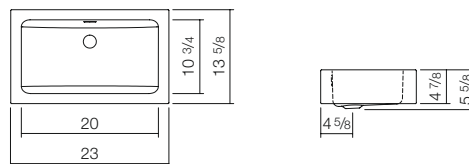
WT . PR585

Washstand, rectangular, wxhxd 23 x 5 5/8 x 13 5/8", sink rectangular, centred, wxhxd 20 x 4 7/8 x 10 3/4", glazed steel, without faucet hole, with overflow, included installation kit, overflow set

	Art.-No.	Price	Version	Surcharge
white, ProShield	4200 000 000	1,082.00	Without overflow	20 %
			Glossy, matte, special color	30 %
Faucet information			Recommended article > s. p. 148	Art.-No.
Impact area approx. 6 3/8 – 7 1/8" from rear edge of basin.			Bottle trap, Sl.2	8306 000 978
For parameters, see page 18.			Bottle trap, Sl.3	8312 000 978
			Drain valve, VT.1	8302 000 978
				Price
				314.00
				288.00
				247.00

Washstands – PR-series

WT . PR800H

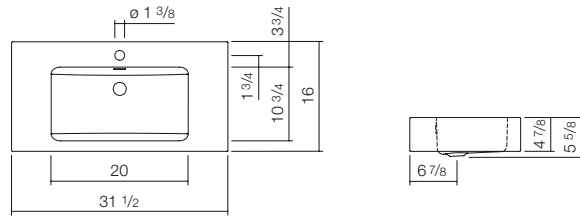

Washstand, rectangular, wxhxd 31 1/2 x 5 5/8 x 16", sink rectangular, centred, wxhxd 20 x 4 7/8 x 10 3/4", glazed steel, with one faucet hole, with overflow, included installation kit, overflow set

	Art.-No.	Price	Version	Surcharge
white, ProShield	4203 000 000	1,391.00	Without overflow	20 %
			3 Drill holes	20 %
			Drill hole for lotion dispenser	20 %
			Glossy, matte, special color	30 %
			Recommended article > s. p. 148	
			Bottle trap, Sl.2	8306 000 978 314.00
			Bottle trap, Sl.3	8312 000 978 288.00
			Drain valve, VT.1	8302 000 978 247.00

Faucet information

Impact area approx. 6 5/8 – 7 3/8" from middle faucet hole.
For parameters, see page 18.

WT . PR800

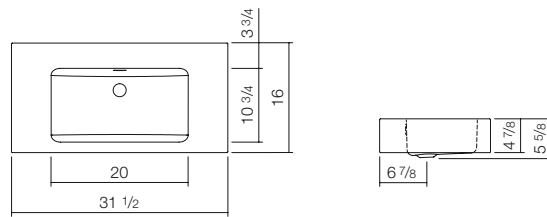

Washstand, rectangular, wxhxd 31 1/2 x 5 5/8 x 16", sink rectangular, centred, wxhxd 20 x 4 7/8 x 10 3/4", glazed steel, without faucet hole, with overflow, included installation kit, overflow set

	Art.-No.	Price	Version	Surcharge
white, ProShield	4203 300 000	1,339.00	Without overflow	20 %
			3 Drill holes	20 %
			Drill hole for lotion dispenser	20 %
			Glossy, matte, special color	30 %
			Recommended article > s. p. 148	
			Bottle trap, Sl.2	8306 000 978 314.00
			Bottle trap, Sl.3	8312 000 978 288.00
			Drain valve, VT.1	8302 000 978 247.00

Faucet information

Impact area approx. 8 5/8 – 9 3/8" from rear edge of basin.
For parameters, see page 18.

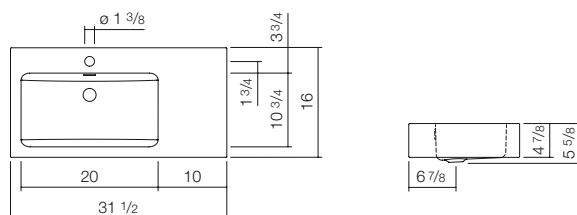
Washstands – PR-series**WT . PR800H . L**

Washstand, rectangular, wxhxd 31 1/2 x 5 5/8 x 16", sink rectangular, left, wxhxd 20 x 4 7/8 x 10 3/4", glazed steel, with one faucet hole, with overflow, included installation kit, overflow set

	Art.-No.	Price	Version	Surcharge
white, ProShield	4205 000 000	1,391.00	Without overflow	20 %
			3 Drill holes	20 %
			Drill hole for lotion dispenser	20 %
			Glossy, matte, special color	30 %

Faucet information

Impact area approx. 6 5/8 – 7 3/8" from middle faucet hole.
For parameters, see page 18.

Recommended article > s. p. 148

	Art.-No.	Price
Bottle trap, Sl.2	8306 000 978	314.00
Bottle trap, Sl.3	8312 000 978	288.00
Drain valve, VT.1	8302 000 978	247.00

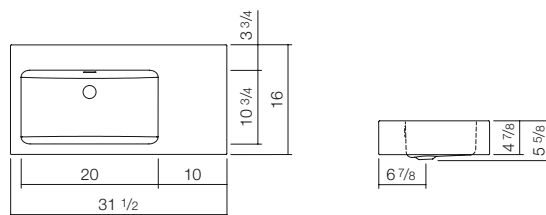
WT . PR800 . L

Washstand, rectangular, wxhxd 31 1/2 x 5 5/8 x 16", sink rectangular, left, wxhxd 20 x 4 7/8 x 10 3/4", glazed steel, without faucet hole, with overflow, included installation kit, overflow set

	Art.-No.	Price	Version	Surcharge
white, ProShield	4205 300 000	1,339.00	Without overflow	20 %
			3 Drill holes	20 %
			Drill hole for lotion dispenser	20 %
			Glossy, matte, special color	30 %

Faucet information

Impact area approx. 8 5/8 – 9 3/8" from rear edge of basin.
For parameters, see page 18.

Recommended article > s. p. 148

	Art.-No.	Price
Bottle trap, Sl.2	8306 000 978	314.00
Bottle trap, Sl.3	8312 000 978	288.00
Drain valve, VT.1	8302 000 978	247.00

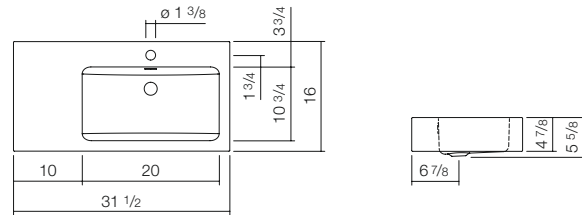
Washstands – PR-series**WT . PR800H . R**

Washstand, rectangular, wxhxd 31 1/2 x 5 5/8 x 16", sink rectangular, right, wxhxd 20 x 4 7/8 x 10 3/4", glazed steel, with one faucet hole, with overflow, included installation kit, overflow set

	Art.-No.	Price	Version	Surcharge
white, ProShield	4207 000 000	1,391.00	Without overflow	20 %
			3 Drill holes	20 %
			Drill hole for lotion dispenser	20 %
			Glossy, matte, special color	30 %

Faucet information

Impact area approx. 6 5/8 – 7 3/8" from middle faucet hole.
For parameters, see page 18.

Recommended article > s. p. 148

Art.-No.	Price
8306 000 978	314.00
8312 000 978	288.00
8302 000 978	247.00

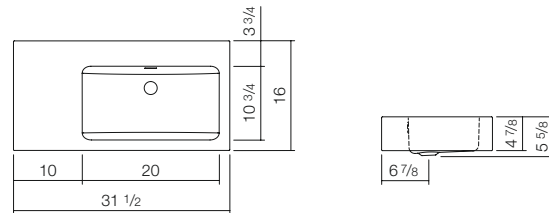
WT . PR800 . R

Washstand, rectangular, wxhxd 31 1/2 x 5 5/8 x 16", sink rectangular, right, wxhxd 20 x 4 7/8 x 10 3/4", glazed steel, without faucet hole, with overflow, included installation kit, overflow set

	Art.-No.	Price	Version	Surcharge
white, ProShield	4207 300 000	1,339.00	Without overflow	20 %
			3 Drill holes	20 %
			Drill hole for lotion dispenser	20 %
			Glossy, matte, special color	30 %

Faucet information

Impact area approx. 8 5/8 – 9 3/8" from rear edge of basin.
For parameters, see page 18.

Recommended article > s. p. 148

Art.-No.	Price
8306 000 978	314.00
8312 000 978	288.00
8302 000 978	247.00

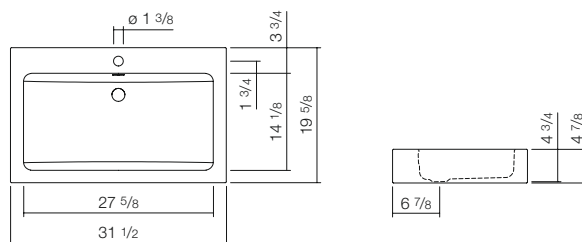
Washstands – GR-series**WT . GR800H**

Washstand, rectangular, wxhxd 31 1/2 x 4 7/8 x 19 5/8", sink rectangular, centred, wxhxd 27 5/8 x 4 3/4 x 14 1/8", glazed steel, with one faucet hole, with overflow, included installation kit, overflow set

	Art.-No.	Price	Version	Surcharge
white, ProShield	4261 200 000	1,545.00	Without faucet hole	20 %
			Without overflow	20 %
			3 Drill holes	20 %
			Drill hole for lotion dispenser	20 %
			Glossy, matte, special color	30 %
Faucet information			Recommended article > s. p. 148	Art.-No.
Impact area approx. 7 1/4 – 9 1/2" from middle faucet hole.			Bottle trap, Sl.2	8306 000 978
For parameters, see page 18.			Bottle trap, Sl.3	8312 000 978
			Drain valve, VT.1	8302 000 978
				Price
				314.00
				288.00
				247.00

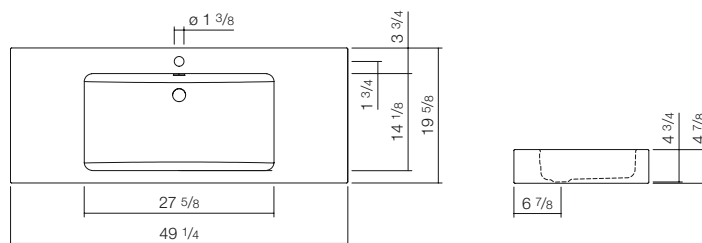
WT . GR1250H

Washstand, rectangular, wxhxd 49 1/4 x 4 7/8 x 19 5/8", sink rectangular, centred, wxhxd 27 5/8 x 4 3/4 x 14 1/8", glazed steel, with one faucet hole, with overflow, included installation kit, overflow set

	Art.-No.	Price	Version	Surcharge
white, ProShield	4287 200 000	1,906.00	Without faucet hole	20 %
			Without overflow	20 %
			3 Drill holes	20 %
			Drill hole for lotion dispenser	20 %
			Glossy, matte, special color	30 %
Faucet information			Recommended article > s. p. 148	Art.-No.
Impact area approx. 7 1/4 – 9 1/2" from middle faucet hole.			Bottle trap, Sl.2	8306 000 978
For parameters, see page 18.			Bottle trap, Sl.3	8312 000 978
			Drain valve, VT.1	8302 000 978
				Price
				314.00
				288.00
				247.00

Washstands – GR-series**WT . GR1250H . L**

Washstand, rectangular, wxhxd 49 1/4 x 4 7/8 x 19 5/8", sink rectangular, left, wxhxd 27 5/8 x 4 3/4 x 14 1/8", glazed steel, with one faucet hole, with overflow, included installation kit, overflow set

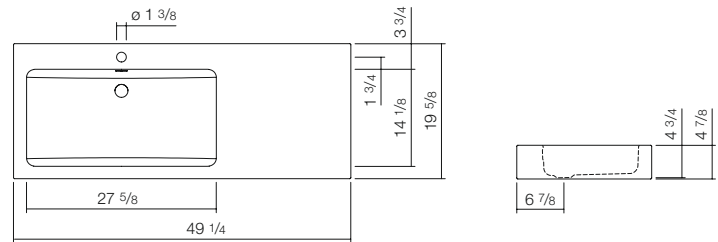

	Art.-No.	Price	Version	Surcharge
white, ProShield	4288 200 000	1,906.00	Without faucet hole	20 %
			Without overflow	20 %
			3 Drill holes	20 %
			Drill hole for lotion dispenser	20 %
			Glossy, matte, special color	30 %
Faucet information			Recommended article > s. p. 148	Art.-No.
Impact area approx. 7 1/4 – 9 1/2" from middle faucet hole.			Bottle trap, Sl.2	8306 000 978
For parameters, see page 18.			Bottle trap, Sl.3	8312 000 978
			Drain valve, VT.1	8302 000 978
				Price
				314.00
				288.00
				247.00

WT . GR1250H . R

Washstand, rectangular, wxhxd 49 1/4 x 4 7/8 x 19 5/8", sink rectangular, right, wxhxd 27 5/8 x 4 3/4 x 14 1/8", glazed steel, with one faucet hole, with overflow, included installation kit, overflow set

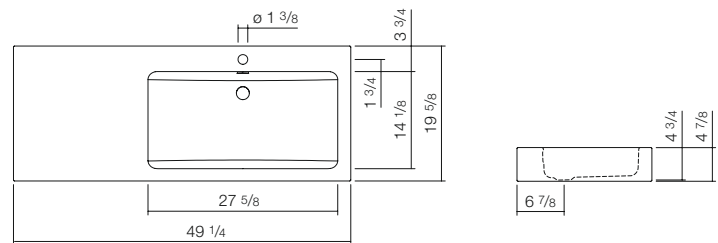

	Art.-No.	Price	Version	Surcharge
white, ProShield	4289 200 000	1,906.00	Without faucet hole	20 %
			Without overflow	20 %
			3 Drill holes	20 %
			Drill hole for lotion dispenser	20 %
			Glossy, matte, special color	30 %
Faucet information			Recommended article > s. p. 148	Art.-No.
Impact area approx. 7 1/4 – 9 1/2" from middle faucet hole.			Bottle trap, Sl.2	8306 000 978
For parameters, see page 18.			Bottle trap, Sl.3	8312 000 978
			Drain valve, VT.1	8302 000 978
				Price
				314.00
				288.00
				247.00

Washstands – RE-series (X.plicit)

WT . RE800H

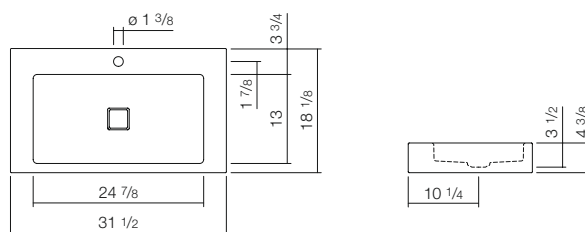

Washstand, rectangular, wxhxd 31 1/2 x 4 3/8 x 18 1/8", sink rectangular, centred, wxhxd 24 7/8 x 3 1/2 x 13", glazed steel, with one faucet hole, without overflow, included installation kit, drain valve, valve cap, white glazed

	Art.-No.	Price	Version	Surcharge
white, ProShield	4105 000 000	1,339.00	3 Drill holes	20 %
			Drill hole for lotion dispenser	20 %
			Glossy, matte, special color	30 %

Faucet information

Impact area approx. 4 3/4 – 5 7/8" from middle faucet hole.
For parameters, see page 18.

Recommended article > s. p. 148

Art.-No.	Price
8306 000 978	314.00
8312 000 978	288.00

WT . RE1000H . L

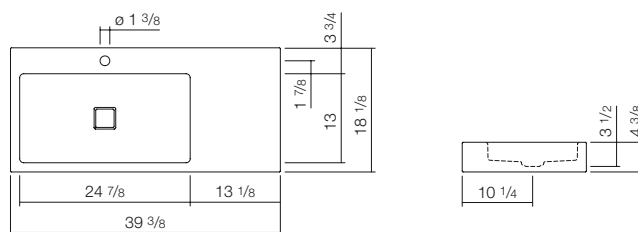

Washstand, rectangular, wxhxd 39 3/8 x 4 3/8 x 18 1/8", sink rectangular, left, wxhxd 25 3/8 x 3 1/2 x 13 1/2", glazed steel, with one faucet hole, without overflow, included installation kit, drain valve, valve cap, white glazed

	Art.-No.	Price	Version	Surcharge
white, ProShield	4102 000 000	1,545.00	3 Drill holes	20 %
			Drill hole for lotion dispenser	20 %
			Glossy, matte, special color	30 %

Faucet information

Impact area approx. 4 3/4 – 5 7/8" from middle faucet hole.
For parameters, see page 18.

Recommended article > s. p. 148

Art.-No.	Price
8306 000 978	314.00
8312 000 978	288.00

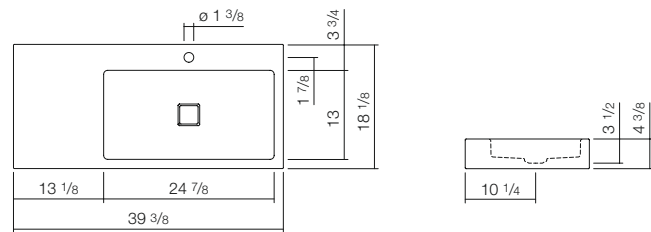
Washstands – RE-series (X.plicit)**WT.RE1000H.R**

Washstand, rectangular, wxhxd $39 \frac{3}{8} \times 4 \frac{3}{8} \times 18 \frac{1}{8}$ ", sink rectangular, right, wxhxd $25 \frac{3}{8} \times 3 \frac{1}{2} \times 13 \frac{1}{2}$ ", glazed steel, with one faucet hole, without overflow, included installation kit, drain valve, valve cap, white glazed

	Art.-No.	Price	Version	Surcharge
white, ProShield	4104 000 000	1,545.00	3 Drill holes	20 %
			Drill hole for lotion dispenser	20 %
			Glossy, matte, special color	30 %

Faucet information

Impact area approx. $4 \frac{3}{4} - 5 \frac{7}{8}$ " from middle faucet hole.
For parameters, see page 18.

Recommended article > s. p. 148











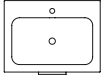
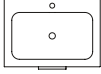
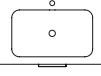
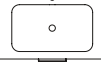

	Art.-No.	Price
Bottle trap, SI.2	8306 000 978	314.00
Bottle trap, SI.3	8312 000 978	288.00

Washplaces

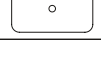
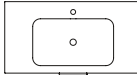
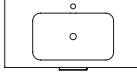
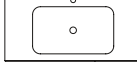
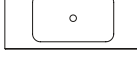
WP

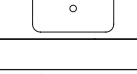

Washplace
WP . F08
Moonstone
49 ³/₈ x 13 ³/₄ x 17 ³/₄"

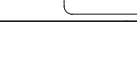
Width of washplace			
13 3/4" – 22 7/8"	25 3/8" – 31 5/8"	over 39 3/8"	
 <p>WP.Insert5 14 x 13 3/4" Page 126</p>  <p>WP.PN1 21 7/8 x 12 5/8" Page 126</p>  <p>WP.PN2 21 7/8 x 12 5/8" Page 127</p>	 <p>WP.F011 15 x 14 1/4" Page 128</p>  <p>WP.F012 15 x 14 1/4" Page 128</p>	<p>Round, wall-mounted</p>	
	 <p>Unit.SR1 27 1/2 x 20 5/8" Page 137</p>  <p>Unit.SR2 27 1/2 x 20 5/8" Page 137</p>  <p>Unit.SR3 31 1/2 x 20 5/8" Page 138</p>  <p>Unit.SR4 31 1/2 x 20 5/8" Page 138</p>  <p>WP.F01 31 5/8 x 19 3/4" Page 129</p>  <p>WP.F02 31 5/8 x 17 3/4" Page 129</p>	 <p>Unit.SR5 39 3/8 x 20 5/8" Page 139</p>  <p>Unit.SR6 39 3/8 x 20 5/8" Page 139</p>  <p>WP.F03 39 1/2 x 19 3/4" Page 130</p>  <p>WP.F04 39 1/2 x 17 3/4" Page 130</p>  <p>WP.F05 49 3/8 x 19 3/4" Page 131</p>  <p>WP.F06 49 3/8 x 17 3/4" Page 131</p>  <p>WP.F07 49 3/8 x 19 3/4" Page 132</p>  <p>WP.F08 49 3/8 x 17 3/4" Page 132</p>  <p>WP.F09 49 3/8 x 19 3/4" Page 133</p>  <p>WP.F010 49 3/8 x 17 3/4" Page 133</p>	<p>Rectangular, wall-mounted</p>

Washplaces – Insert-series, PN-series

All prices in US \$

Mounting and connection measurements > see Page 160

WP . INSERT5

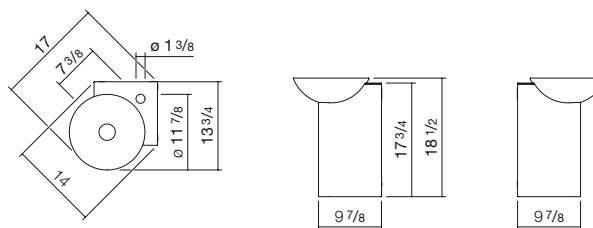

Corner washplace, rectangular, wxhxd 14 x 18 1/2 x 13 3/4", dish basin, sink centred, with one faucet hole, without overflow, frame, chrome steel, powder finish, white, installation kit, drain valve, valve cap, chrome-plated, drain valve

	Art.-No.	Price
white glazed steel shelf	5245 000 000	1,133.00
anthracite brown glazed steel shelf	5245 000 110	1,133.00

Faucet information

Impact area approx. 4 5/8 – 5 3/4" from middle faucet hole.

For parameters, see page 18.

WP . PN1

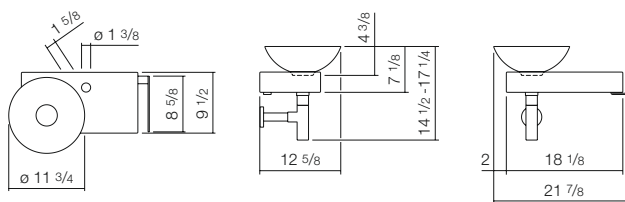

Washplace, rectangular, wxhxd 21 7/8 x 15 3/4 x 12 5/8", dish basin, sink left, Ø 11 3/4", sink depth 4 3/8", glazed steel, ProShield, with one faucet hole, without overflow, steel, glazed, polished stainless steel, included installation kit, drain valve, valve cap, glazed in the basin color, chrome-plated bottle trap

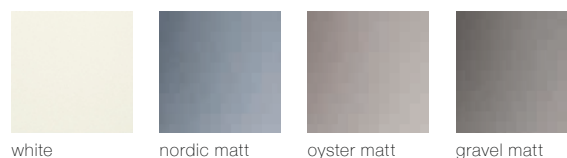

	Art.-No.	Price
white	5256 000 000	1,545.00
nordic matt	5256 000 083	1,675.00
oyster matt	5256 000 081	1,675.00
gravel matt	5256 000 084	1,675.00

Faucet information

Impact area approx. 4 3/4 – 6" from middle faucet hole.

For parameters, see page 18.

Washplaces – PN-series (Piccolo Novo)**WP . PN2**

Washplace, rectangular, wxhxd 21 7/8 x 15 3/4 x 12 5/8", dish basin, sink right, Ø 11 3/4", sink depth 4 3/8", glazed steel, ProShield, with one faucet hole, without overflow, steel, glazed, polished stainless steel, included installation kit, drain valve, valve cap, glazed in the basin color, chrome-plated bottle trap

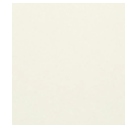
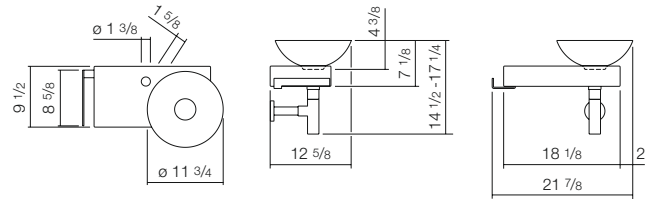

white



nordic matt



oyster matt



gravel matt

	Art.-No.	Price
white	5257 000 000	1,545.00
nordic matt	5257 000 083	1,675.00
oyster matt	5257 000 081	1,675.00
gravel matt	5257 000 084	1,675.00

Faucet information

Impact area approx. 4 3/4 – 6" from middle faucet hole.
For parameters, see page 18.

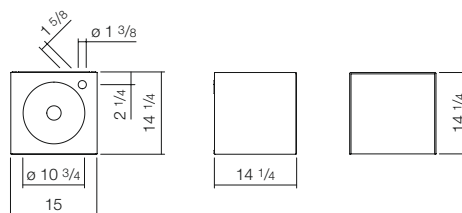
Washplaces – FO-series**WP . F011**

Washplace, rectangular, wxhxd 15 x 14 1/4 x 14 1/4", sink round, centred, glazed steel, ProShield, with one faucet hole, without overflow, washable cabinet, handle-free with push-to-open, door strike to the left, installation kit, drain valve, valve cap, white glazed, space-saving bottle trap



brushed oak



grey fossil



moonstone



shadow earth

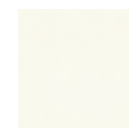

white

	Art.-No.	Price
wood effect laminate brushed oak	5171 816 000	2,150.00
silk-matt finish grey fossil	5171 810 000	2,266.00
silk-matt finish moonstone	5171 811 000	2,266.00
silk-matt finish shadow earth	5171 813 000	2,266.00
silk-matt finish white	5171 814 000	2,266.00

Faucet information

Impact area approx. 4 1/4 – 5 1/2" from middle faucet hole.
For parameters, see page 18.

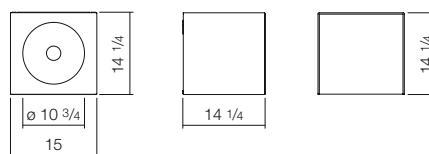
WP . F012

brushed oak



grey fossil



moonstone



shadow earth

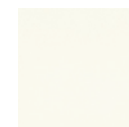

white

Washplace, rectangular, wxhxd 15 x 14 1/4 x 14 1/4", sink round, centred, glazed steel, ProShield, without faucet hole, without overflow, washable cabinet, handle-free with push-to-open, door strike to the left, installation kit, drain valve, valve cap, white glazed, space-saving bottle trap

	Art.-No.	Price
wood effect laminate brushed oak	5171 516 000	2,150.00
silk-matt finish grey fossil	5171 510 000	2,266.00
silk-matt finish moonstone	5171 511 000	2,266.00
silk-matt finish shadow earth	5171 513 000	2,266.00
silk-matt finish white	5171 514 000	2,266.00

Faucet information

Impact area approx. 4 3/8 – 5 1/2" from rear edge of basin.
For parameters, see page 18.

Washplaces – FO-series

WP . F01



Washplace, rectangular, wxhxd 31 5/8 x 13 3/4 x 19 3/4", sink rectangular, centred, glazed steel, ProShield, with one faucet hole, without overflow, washable cabinet, handle-free with push-to-open, full extension, installation kit, drain valve, valve cap, white glazed, space-saving bottle trap

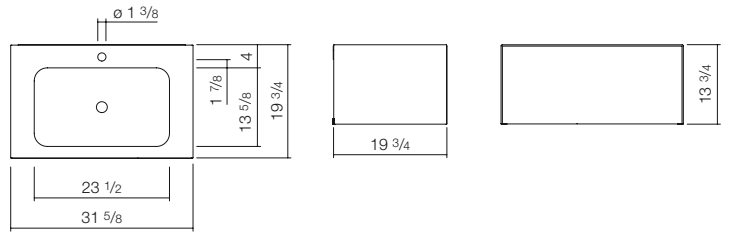

	Art.-No.	Price	Version	Surcharge
wood effect laminate brushed oak	5165 816 000	3,325.00	With overflow	20 %
silk-matt finish grey fossil	5165 810 000	3,502.00		
silk-matt finish moonstone	5165 811 000	3,502.00		
silk-matt finish shadow earth	5165 813 000	3,502.00		
silk-matt finish white	5165 814 000	3,502.00		

Faucet information

Impact area approx. 5 1/8 – 6 1/2" from middle faucet hole.
For parameters, see page 18.

WP . F02



Washplace, rectangular, wxhxd 31 5/8 x 13 3/4 x 17 3/4", sink rectangular, centred, glazed steel, ProShield, without faucet hole, without overflow, washable cabinet, handle-free with push-to-open, full extension, installation kit, drain valve, valve cap, white glazed, space-saving bottle trap

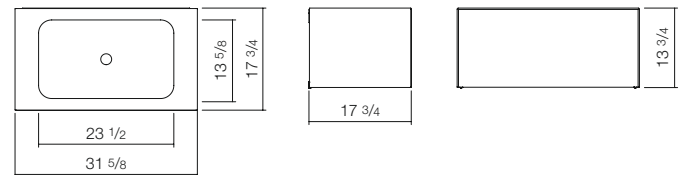

	Art.-No.	Price	Version	Surcharge
wood effect laminate brushed oak	5165 516 000	3,325.00	With overflow	20 %
silk-matt finish grey fossil	5165 510 000	3,502.00		
silk-matt finish moonstone	5165 511 000	3,502.00		
silk-matt finish shadow earth	5165 513 000	3,502.00		
silk-matt finish white	5165 514 000	3,502.00		

Faucet information

Impact area approx. 5 3/8 – 6 3/4" from rear edge of basin.
For parameters, see page 18.

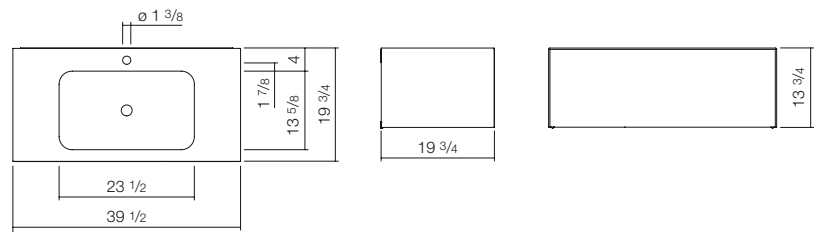
Washplaces – FO-series**WP . F03**

Washplace, rectangular, wxhxd 39 1/2 x 13 3/4 x 19 3/4", sink rectangular, centred, glazed steel, ProShield, with one faucet hole, without overflow, washable cabinet, handle-free with push-to-open, full extension, installation kit, drain valve, valve cap, white glazed, space-saving bottle trap



brushed oak



grey fossil



moonstone



shadow earth

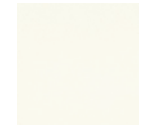

white

	Art.-No.	Price	Version	Surcharge
wood effect laminate brushed oak	5166 816 000	3,620.00	With overflow	20 %
silk-matt finish grey fossil	5166 810 000	3,811.00		
silk-matt finish moonstone	5166 811 000	3,811.00		
silk-matt finish shadow earth	5166 813 000	3,811.00		
silk-matt finish white	5166 814 000	3,811.00		

Faucet information

Impact area approx. 5 1/8 – 6 1/2" from middle faucet hole.
For parameters, see page 18.

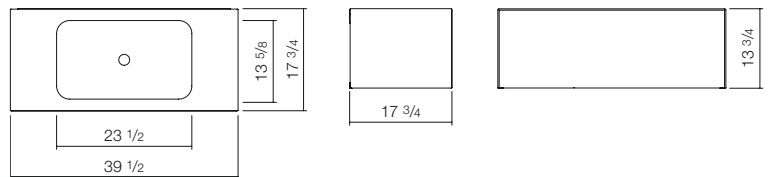
WP . F04

brushed oak



grey fossil



moonstone



shadow earth

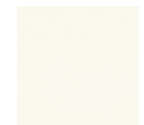

white

Washplace, rectangular, wxhxd 39 1/2 x 13 3/4 x 17 3/4", sink rectangular, centred, glazed steel, ProShield, without faucet hole, without overflow, washable cabinet, handle-free with push-to-open, full extension, installation kit, drain valve, valve cap, white glazed, space-saving bottle trap

	Art.-No.	Price	Version	Surcharge
wood effect laminate brushed oak	5166 516 000	3,620.00	With overflow	20 %
silk-matt finish grey fossil	5166 510 000	3,811.00		
silk-matt finish moonstone	5166 511 000	3,811.00		
silk-matt finish shadow earth	5166 513 000	3,811.00		
silk-matt finish white	5166 514 000	3,811.00		

Faucet information

Impact area approx. 5 3/8 – 6 3/4" from rear edge of basin.
For parameters, see page 18.

Washplaces – FO-series

WP . F05

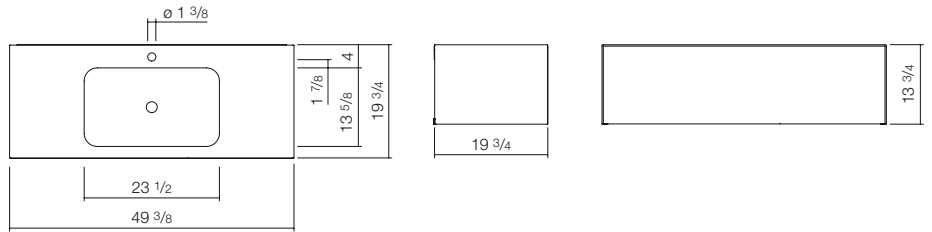

Washplace, rectangular, wxhxd 49 3/8 x 13 3/4 x 19 3/4", sink rectangular, centred, glazed steel, ProShield, with one faucet hole, without overflow, washable cabinet, handle-free with push-to-open, full extension, installation kit, drain valve, valve cap, white glazed, space-saving bottle trap



	Art.-No.	Price	Version	Surcharge
wood effect laminate brushed oak	5167 816 000	4,110.00	With overflow	20 %
silk-matt finish grey fossil	5167 810 000	4,326.00		
silk-matt finish moonstone	5167 811 000	4,326.00		
silk-matt finish shadow earth	5167 813 000	4,326.00		
silk-matt finish white	5167 814 000	4,326.00		

Faucet information

Impact area approx. 5 1/8 – 6 1/2" from middle faucet hole.
For parameters, see page 18.

WP . F06

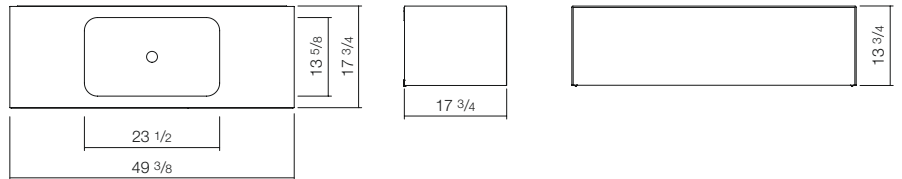

Washplace, rectangular, wxhxd 49 3/8 x 13 3/4 x 17 3/4", sink rectangular, centred, glazed steel, ProShield, without faucet hole, without overflow, washable cabinet, handle-free with push-to-open, full extension, installation kit, drain valve, valve cap, white glazed, space-saving bottle trap



	Art.-No.	Price	Version	Surcharge
wood effect laminate brushed oak	5167 516 000	4,110.00	With overflow	20 %
silk-matt finish grey fossil	5167 510 000	4,326.00		
silk-matt finish moonstone	5167 511 000	4,326.00		
silk-matt finish shadow earth	5167 513 000	4,326.00		
silk-matt finish white	5167 514 000	4,326.00		

Faucet information

Impact area approx. 5 3/8 – 6 3/4" from rear edge of basin.
For parameters, see page 18.

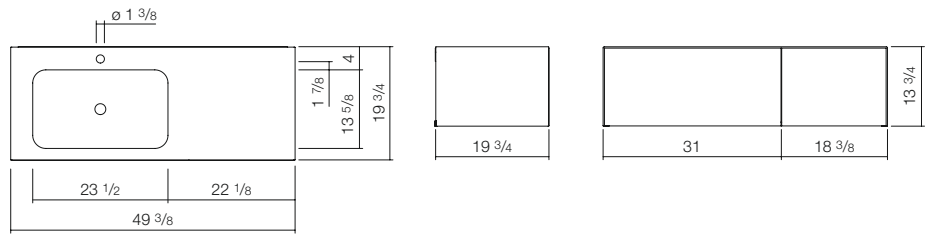
Washplaces – FO-series**WP . F07**

Washplace, rectangular, wxhxd 49 3/8 x 13 3/4 x 19 3/4", sink rectangular, left, glazed steel, ProShield, with one faucet hole, without overflow, wash-table cabinet, handle-free with push-to-open, two full extensions, installation kit, drain valve, valve cap, white glazed, space-saving bottle trap



brushed oak



grey fossil



moonstone



shadow earth

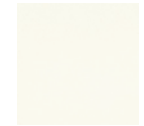

white

	Art.-No.	Price	Version	Surcharge
wood effect laminate brushed oak	5168 816 000	4,300.00	With overflow	20 %
silk-matt finish grey fossil	5168 810 000	4,532.00		
silk-matt finish moonstone	5168 811 000	4,532.00		
silk-matt finish shadow earth	5168 813 000	4,532.00		
silk-matt finish white	5168 814 000	4,532.00		

Faucet information

Impact area approx. 5 1/8 – 6 1/2" from middle faucet hole.

For parameters, see page 18.

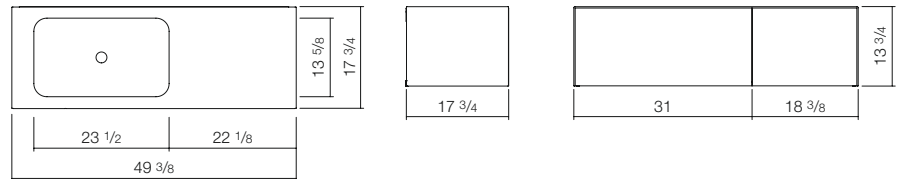
WP . F08

Washplace, rectangular, wxhxd 49 3/8 x 13 3/4 x 17 3/4", sink rectangular, left, glazed steel, ProShield, without faucet hole, without overflow, wash-table cabinet, handle-free with push-to-open, two full extensions, installation kit, drain valve, valve cap, white glazed, space-saving bottle trap



brushed oak



grey fossil



moonstone



shadow earth

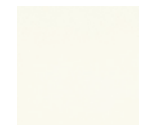

white

	Art.-No.	Price	Version	Surcharge
wood effect laminate brushed oak	5168 516 000	4,300.00	With overflow	20 %
silk-matt finish grey fossil	5168 510 000	4,532.00		
silk-matt finish moonstone	5168 511 000	4,532.00		
silk-matt finish shadow earth	5168 513 000	4,532.00		
silk-matt finish white	5168 514 000	4,532.00		

Faucet information

Impact area approx. 5 3/8 – 6 3/4" from rear edge of basin.

For parameters, see page 18.

Washplaces – FO-series

WP . F09

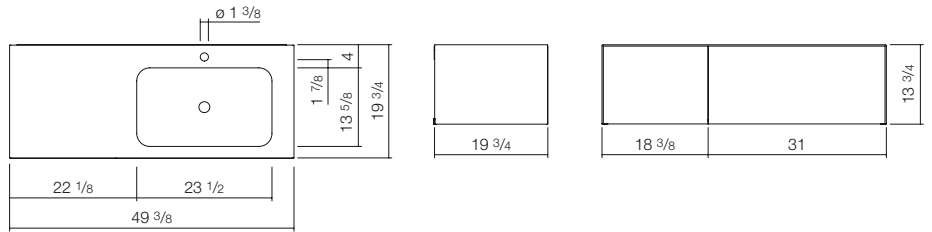

Washplace, rectangular, wxhxd 49 3/8 x 13 3/4 x 19 3/4", sink rectangular, right, glazed steel, ProShield, with one faucet hole, without overflow, washable cabinet, handle-free with push-to-open, two full extensions, installation kit, drain valve, valve cap, white glazed, space-saving bottle trap



	Art.-No.	Price	Version	Surcharge
wood effect laminate brushed oak	5169 816 000	4,300.00	With overflow	20 %
silk-matt finish grey fossil	5169 810 000	4,532.00		
silk-matt finish moonstone	5169 811 000	4,532.00		
silk-matt finish shadow earth	5169 813 000	4,532.00		
silk-matt finish white	5169 814 000	4,532.00		

Faucet information

Impact area approx. 5 1/8 – 6 1/2" from middle faucet hole.
For parameters, see page 18.

WP . F010

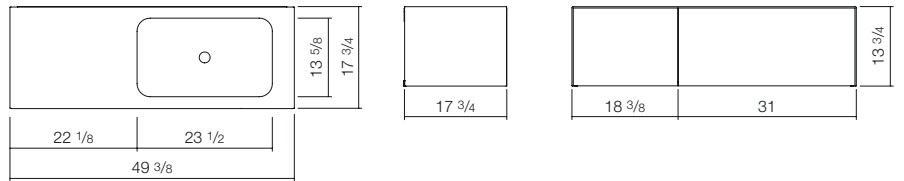

Washplace, rectangular, wxhxd 49 3/8 x 13 3/4 x 17 3/4", sink rectangular, right, glazed steel, ProShield, without faucet hole, without overflow, washable cabinet, handle-free with push-to-open, two full extensions, installation kit, drain valve, valve cap, white glazed, space-saving bottle trap



	Art.-No.	Price	Version	Surcharge
wood effect laminate brushed oak	5169 516 000	4,300.00	With overflow	20 %
silk-matt finish grey fossil	5169 510 000	4,532.00		
silk-matt finish moonstone	5169 511 000	4,532.00		
silk-matt finish shadow earth	5169 513 000	4,532.00		
silk-matt finish white	5169 514 000	4,532.00		

Faucet information

Impact area approx. 5 3/8 – 6 3/4" from rear edge of basin.
For parameters, see page 18.

Accessories – FO-series

All prices in US \$

HS . F01250 . L

Cupboard, rectangular, wxhxd 15 1/2 x 63 x 9 7/8", one door, handle-free with push-to-open, door strike on the left, width with door open 355mm (opening angle 105°), glazed side bracket on the right, white, included installation kit, 4 glass shelves, without dowels (to be adjusted to constructional situation)

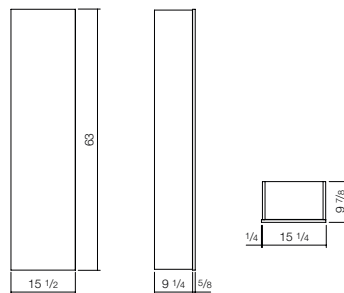

brushed oak



grey fossil



moonstone



shadow earth

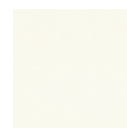

white

	Art.-No.	Price
wood effect laminate brushed oak	6324 990 016	2,100.00
silk-matt finish grey fossil	6324 990 010	2,215.00
silk-matt finish moonstone	6324 990 011	2,215.00
silk-matt finish shadow earth	6324 990 013	2,215.00
silk-matt finish white	6324 990 014	2,215.00

HS . F01250 . R

Cupboard, rectangular, wxhxd 15 1/2 x 63 x 9 7/8", one door, handle-free with push-to-open, door strike on the right, width with door open 355mm (opening angle 105°), glazed side bracket on the left, white, included installation kit, 4 glass shelves, without dowels (to be adjusted to constructional situation)

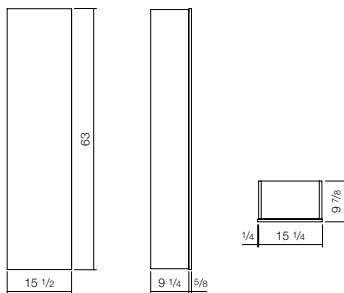

brushed oak



grey fossil



moonstone



shadow earth

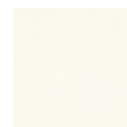

white

	Art.-No.	Price
wood effect laminate brushed oak	6324 690 016	2,100.00
silk-matt finish grey fossil	6324 690 010	2,215.00
silk-matt finish moonstone	6324 690 011	2,215.00
silk-matt finish shadow earth	6324 690 013	2,215.00
silk-matt finish white	6324 690 014	2,215.00



Washplace
WP.F08
Oak brushed
49 3/8 x 13 3/4 x 17 3/4"



Washplace
Unit. SR6
39 5/8 x 20 5/8", x 18 5/8"
Walnut

Washplaces – Units.SR

Unit .SR1

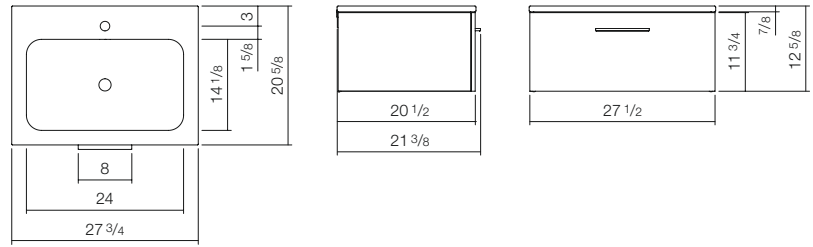

Washplace, rectangular, B/H/T 27 1/2/12 5/8/20 5/8 mm, with one faucet hole, with overflow, washstand base cabinet, chipboard, chrome-plated handle, internal drawer with bottle trap cutout, installation kit, space-saving bottle trap, overflow set, without dowels (to be adjusted to constructional situation)

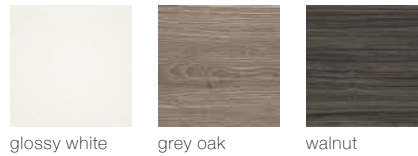

Note: Faucets are not included

	Art.-No.	Price	Version	Surcharge
glossy white	5139 620 611	1,700.00	Without overflow	20 %
grey oak	5139 620 620	1,700.00		
walnut	5139 620 621	1,700.00		

Faucet information

Impact area approx. 4 1/8 – 6 1/8" from middle faucet hole.
For parameters, see page 18.

Recommended article > s. p. 148

Art.-No.	Price
Drain valve, VT.1	8302 000 978 247.00

Unit .SR2

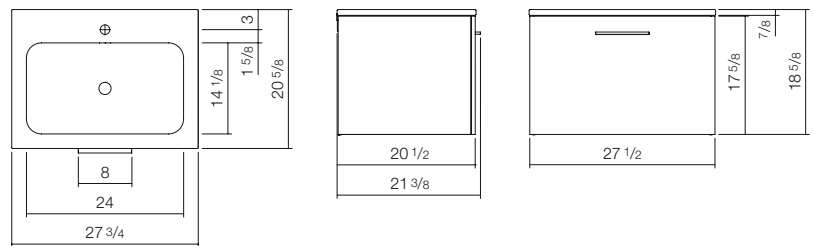

Washplace, rectangular, wxhxd 27 1/2 x 18 5/8 x 20 5/8", with one faucet hole, with overflow, washstand base cabinet, chipboard, chrome-plated handle, internal drawer with bottle trap cutout, installation kit, space-saving bottle trap, overflow set, without dowels (to be adjusted to constructional situation)

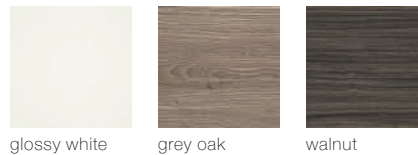

Note: Faucets are not included

	Art.-No.	Price	Version	Surcharge
glossy white	5147 620 611	1,700.00	Without overflow	20 %
grey oak	5147 620 620	1,700.00		
walnut	5147 620 621	1,700.00		

Faucet information

Impact area approx. 4 1/8 – 6 1/8" from middle faucet hole.
For parameters, see page 18.

Recommended article > s. p. 148

Art.-No.	Price
Drain valve, VT.1	8302 000 978 247.00

Washplaces – Units.SR

Unit .SR3

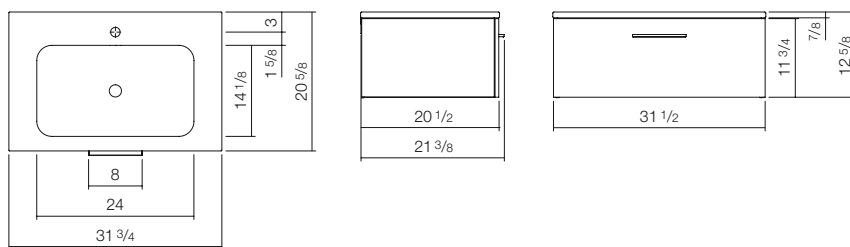

Washplace, rectangular, wxhxd 31 1/2 x 12 5/8 x 20 5/8", with one faucet hole, with overflow, washstand base cabinet, chipboard, chrome-plated handle, internal drawer with bottle trap cutout, installation kit, space-saving bottle trap, overflow set, without dowels (to be adjusted to constructional situation)

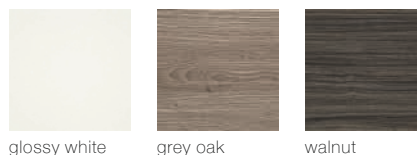

Note: Faucets are not included

	Art.-No.	Price	Version	Surcharge
glossy white	5141 620 611	1,803.00	Without overflow	20 %
grey oak	5141 620 620	1,803.00		
walnut	5141 620 621	1,803.00		

Faucet information

Impact area approx. 4 1/8 – 6 1/8" from middle faucet hole.
For parameters, see page 18.

Recommended article > s. p. 148

Art.-No.	Price
Drain valve, VT.1	8302 000 978 247.00

Unit .SR4

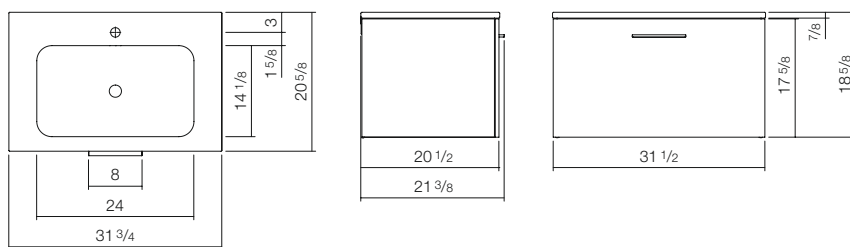

Washplace, rectangular, wxhxd 31 1/2 x 18 5/8 x 20 5/8", with one faucet hole, with overflow, washstand base cabinet, chipboard, chrome-plated handle, internal drawer with bottle trap cutout, installation kit, space-saving bottle trap, overflow set, without dowels (to be adjusted to constructional situation)

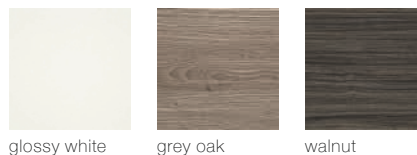

Note: Faucets are not included

	Art.-No.	Price	Version	Surcharge
glossy white	5149 620 611	1,803.00	Without overflow	20 %
grey oak	5149 620 620	1,803.00		
walnut	5149 620 621	1,803.00		

Faucet information

Impact area approx. 4 1/8 – 6 1/8" from middle faucet hole.
For parameters, see page 18.

Recommended article > s. p. 148

Art.-No.	Price
Drain valve, VT.1	8302 000 978 247.00

Washplaces – Units.SR

Unit .SR5

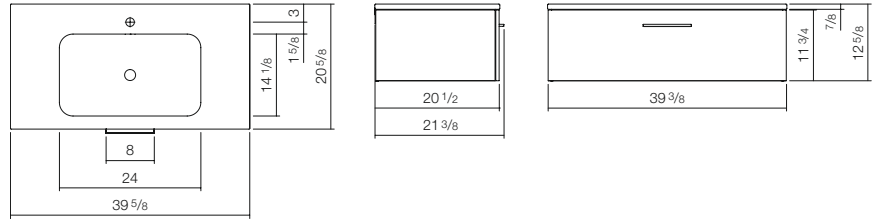

Washplace, rectangular, wxhxd 39 3/8 x 12 5/8 x 20 5/8", with one faucet hole, with overflow, washstand base cabinet, chipboard, chrome-plated handle, internal drawer with bottle trap cutout, installation kit, space-saving bottle trap, overflow set, without dowels (to be adjusted to constructional situation)

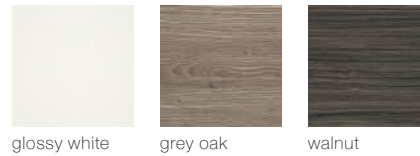

Note: Faucets are not included

	Art.-No.	Price	Version	Surcharge
glossy white	5143 620 611	1,957.00	Without overflow	20 %
grey oak	5143 620 620	1,957.00		
walnut	5143 620 621	1,957.00		

Faucet information

Impact area approx. 4 1/8 – 6 1/8" from middle faucet hole.
For parameters, see page 18.

Recommended article > s. p. 148

Art.-No.	Price
Drain valve, VT.1	8302 000 978 247.00

Unit .SR6

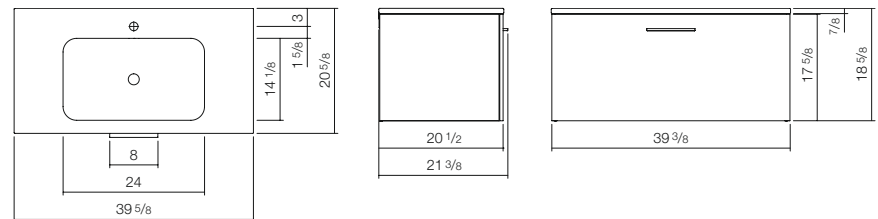

Washplace, rectangular, wxhxd 39 3/8 x 18 5/8 x 20 5/8", with one faucet hole, with overflow, washstand base cabinet, chipboard, chrome-plated handle, internal drawer with bottle trap cutout, installation kit, space-saving bottle trap, overflow set, without dowels (to be adjusted to constructional situation)

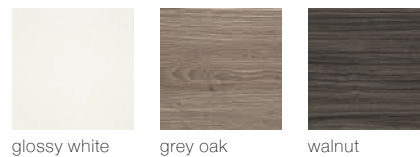

Note: Faucets are not included

	Art.-No.	Price	Version	Surcharge
glossy white	5151 620 611	1,957.00	Without overflow	20 %
grey oak	5151 620 620	1,957.00		
walnut	5151 620 621	1,957.00		

Faucet information

Impact area approx. 4 1/8 – 6 1/8" from middle faucet hole.
For parameters, see page 18.

Recommended article > s. p. 148

Art.-No.	Price
Drain valve, VT.1	8302 000 978 247.00

Bucket sinks

AG



Bucket sink
AG . STAHLFORM510Ü
20 1/8 x 14 3/8 x 13"

Bucket sinks – AG-series

All prices in US \$

AG.Stahlform 510Ü



Bucket sink, rectangular, wxhxd 20 1/8 x 14 3/8 x 13", without faucet hole, with overflow, PVC edge, black, including fixing set and drain and overflow fitting with chain and plug, Minimum order quantity 1 pallet (24 pc)

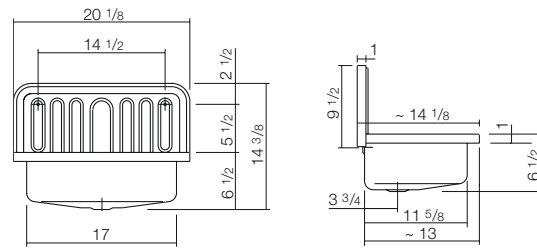

	Art.-No.	Price
white	1201 000 000	261.00

AG.Stahlform 510Ü



Bucket sink, rectangular, wxhxd 20 1/8 x 14 3/8 x 13", without faucet hole, with overflow, PVC edge, black, bottle trap, drain and overflow fitting with chain and plug

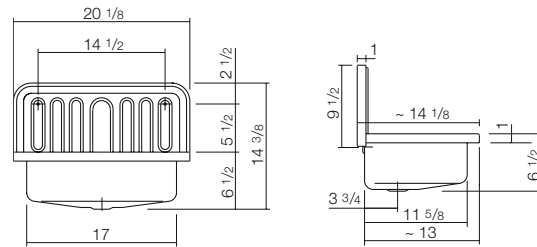

	Art.-No.	Price
matt black/glossy white white	1205 000 180	353.00

UTENSILO

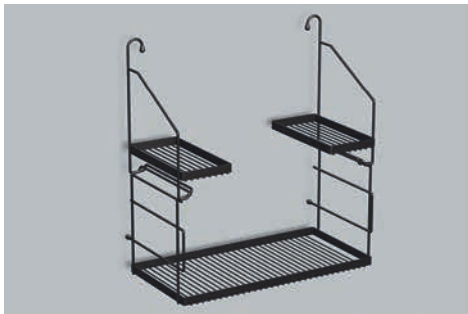

Shelf, wxhxd 20 3/8 x 22 x 10 5/8", Powder coated, steel shelf suitable for Alape AG.STAHLFORM510Ü bucket sinks

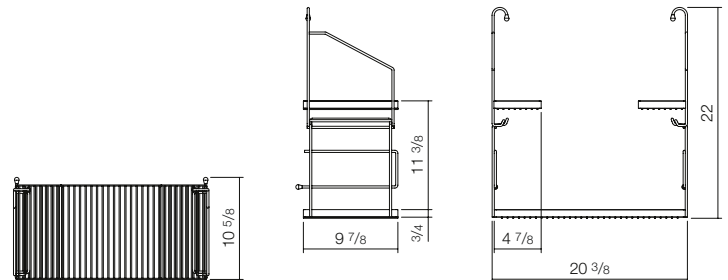

	Art.-No.	Price
matt black	8902 000 980	225.00

Shelf system – Assist

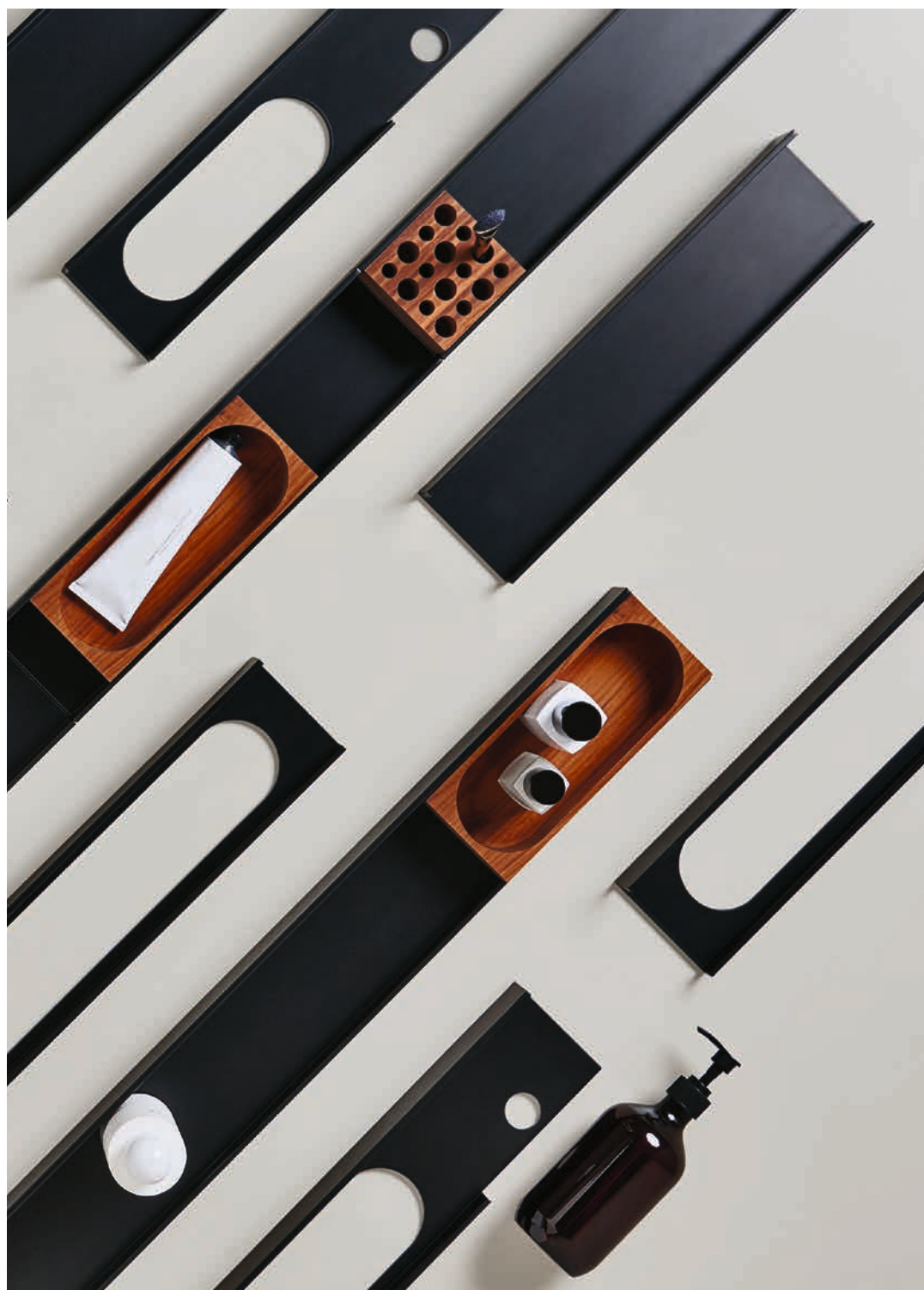

Width — Shelves

Assist — Shelves

400mm

600mm

800mm

AS . 400 . S
 15 3/4 x 2 x 3 7/8"
 Page 144

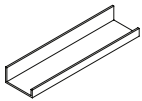

AS . 600 . S
 23 5/8 x 2 x 3 7/8"
 Page 144

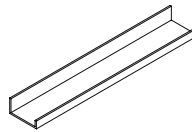

AS . 800 . S
 31 1/2 x 2 x 3 7/8"
 Page 144

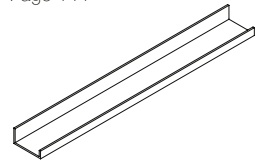

AS . 400 . HT . L/R
 15 3/4 x 7 3/4 x 4 3/8"
 Page 145

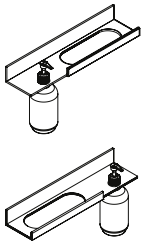

AS . 600 . HT
 23 5/8 x 2 x 3 7/8"
 Page 144

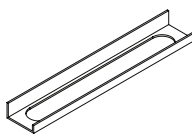

Assist — Accessories

AS . Box1
 3 1/2 x 1 3/4 x 3 1/2"
 Page 145



AS . Box2
 8 7/8 x 1 3/4 x 3 1/2"
 Page 145



AS . 160 . TPH
 6 1/4 x 2 x 3 7/8"
 Page 146



Assist — Shower shelves

AS . 400 . S
 15 3/4 x 2 x 3 7/8"
 Page 146

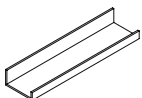

AS . 134 . L02
 5 1/4 x 2 x 3 3/8"
 Page 146



AS . 225 . L03
 8 7/8 x 2 x 3 3/8"
 Page 146



Assist – Shelves

All prices in US \$

AS. 400.S

Shelf, rectangular, wxhxd 15 3/4 x 2 x 3 7/8", aluminium, Powder coated, without cutouts, included installation kit, without dowels (to be adjusted to constructional situation)



	Art.-No.	Price
matt black	8270 000 980	220.00
matt white	8270 000 331	220.00

AS. 600.S

Shelf, rectangular, wxhxd 23 5/8 x 2 x 3 7/8", aluminium, Powder coated, without cutouts, included installation kit, without dowels (to be adjusted to constructional situation)



	Art.-No.	Price
matt black	8271 000 980	255.00
matt white	8271 000 331	255.00

AS. 800.S

Shelf, rectangular, wxhxd 31 1/2 x 2 x 3 7/8", aluminium, Powder coated, without cutouts, included installation kit, without dowels (to be adjusted to constructional situation)



	Art.-No.	Price
matt black	8272 000 980	291.00
matt white	8272 000 331	291.00

AS. 600.HT

Shelf, rectangular, wxhxd 23 5/8 x 2 x 3 7/8", aluminium, Powder coated, towel cutout central, included installation kit, without dowels (to be adjusted to constructional situation)

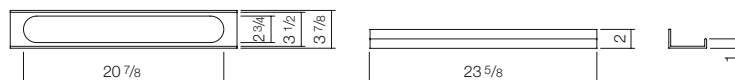

	Art.-No.	Price
matt black	8271 140 980	291.00
matt white	8271 140 331	291.00

Assist – Shelves

All prices in US \$

AS . 400 . HT . L



Shelf, rectangular, wxhxd 15 3/4 x 7 3/4 x 4 3/8", aluminium, Powder coated, lotion dispenser cutout right, towel cutout left, included installation kit, plastic bottle, without dowels (to be adjusted to constructional situation)

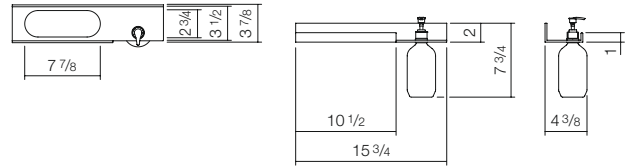

	Art.-No.	Price
matt black	8270 221 980	291.00
matt white	8270 221 331	291.00

AS . 400 . HT . R



Shelf, rectangular, wxhxd 15 3/4 x 7 3/4 x 4 3/8", aluminium, Powder coated, lotion dispenser cutout left, towel cutout, right, included installation kit, plastic bottle, without dowels (to be adjusted to constructional situation)

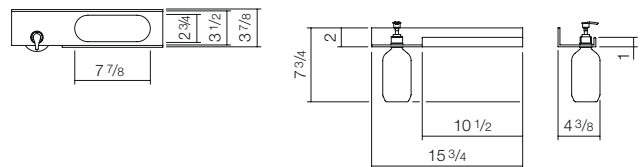

	Art.-No.	Price
matt black	8270 321 980	291.00
matt white	8270 321 331	291.00

AS . Box1

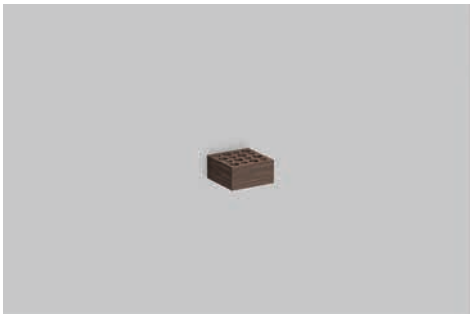

Perforated block, rectangular, wxhxd 3 1/2 x 1 3/4 x 3 1/2", American walnut, Oiled, with 16 drill holes, 12 and 17 mm diameter

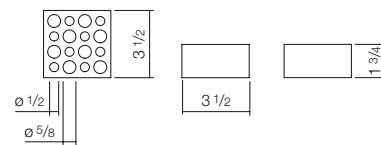

	Art.-No.	Price
	8266 000 671	77.00

AS . Box2



Box, rectangular, wxhxd 8 7/8 x 1 3/4 x 3 1/2", American walnut, Oiled, with oval cutout, approx. width: 215 mm

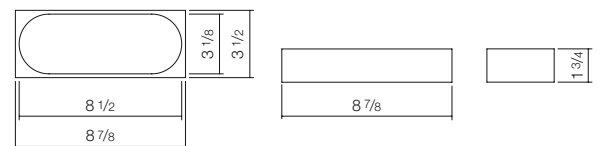

	Art.-No.	Price
	8267 000 671	113.00

Assist – Shelves, Shower shelves

All prices in US \$

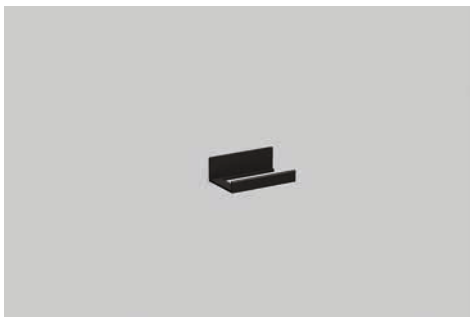
AS.160.TPH

Toiletry, rectangular, wxhxd 6 1/4 x 2 x 3 7/8", aluminium, Powder coated, included installation kit, without dowels (to be adjusted to constructional situation)

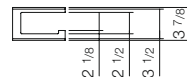

	Art.-No.	Price
matt black	8274 170 981	204.00
matt white	8274 170 982	204.00

AS.400.S

Shower shelf, rectangular, wxhxd 15 3/4 x 2 x 3 7/8", aluminium, Powder coated, without cutouts, included installation kit, without dowels (to be adjusted to constructional situation)

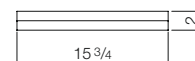

	Art.-No.	Price
matt black	8270 000 981	220.00
matt white	8270 000 982	220.00

AS.134.L02

Shower shelf, rectangular, wxhxd 5 1/4 x 2 x 3 3/8", aluminium, Powder coated, two lotion dispenser cutouts, included installation kit, two plastic bottles, without dowels (to be adjusted to constructional situation)

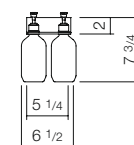

	Art.-No.	Price
matt black	8274 111 981	192.00
matt white	8274 111 982	192.00

AS.225.L03

Shower shelf, rectangular, wxhxd 8 7/8 x 2 x 3 3/8", aluminium, Powder coated, three lotion dispenser cutouts, included installation kit, three plastic bottles, without dowels (to be adjusted to constructional situation)

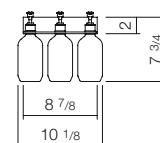
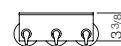

	Art.-No.	Price
matt black	8274 112 981	204.00
matt white	8274 112 982	204.00



Assist
Shower shelves
AS.400.S
AS.225.L03

Accessories

Along with built-in, sit-on, and dish basins, washstands, and washplaces, Alape's wide product range includes matching accessories. The range extends from bottle traps, drain valves to overflow rosettes.



Undermount basin
UB.K450
Ø 16 1/8 x 6 1/4"

Accessories

All prices in US \$

SI . 2



Bottle trap, wxhxd $1\frac{3}{4} \times 11\frac{3}{4} \times 14\frac{5}{8}$ ", chrome-plated, $1\frac{1}{4}$ " connection thread, immersion tube, adjustable in height from 135 to 205 mm, adjustable depth from 90 to 370 mm

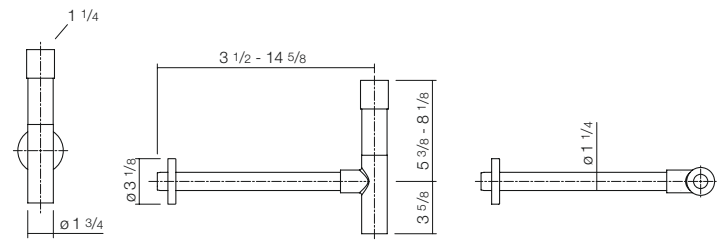

	Art.-No.	Price
Chrome-plated	8306 000 978	314.00

SI . 3



Bottle trap, wxhxd $1\frac{3}{4} \times 16\frac{1}{2} \times 15\frac{3}{8}$ ", $1\frac{1}{4}$ " connection thread, immersion tube, adjustable in height from 75 to 330 mm, adjustable depth from 90 to 390 mm

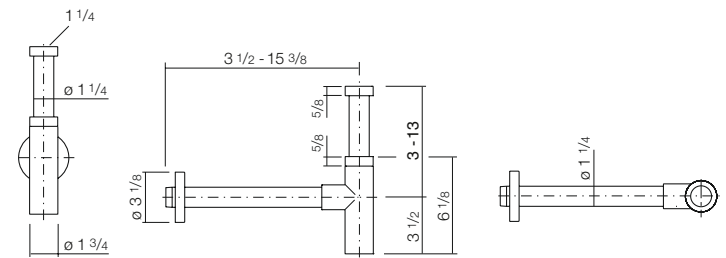

	Art.-No.	Price
Chrome-plated	8312 000 978	288.00
matt black	8312 000 980	310.00
white	8312 000 331	310.00

VT . 1



Drain valve, round, wxhxd $2\frac{1}{2} \times 2\frac{7}{8} \times 2\frac{1}{2}$ ", chrome-plated, $\varnothing 1\frac{1}{4}$ ", with open/closed function, this basin requires an overflow, valve cap, chrome-plated

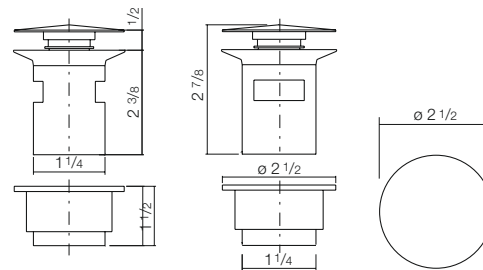

	Art.-No.	Price
Chrome-plated	8302 000 978	247.00

VT . 2



Drain valve, round, wxhxd $2\frac{1}{2} \times 3\frac{7}{8} \times 2\frac{1}{2}$ ", $\varnothing 1\frac{1}{4}$ ", valve cap, for basins without overflow

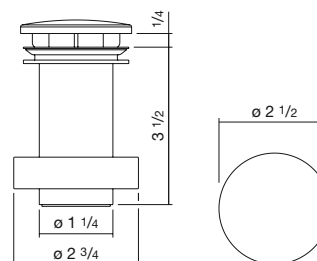

	Art.-No.	Price
Chrome-plated	8309 000 978	216.00
white	8309 000 000	237.00

Accessories

All prices in US \$

VT.3



Drain valve, round, wxhxd 2 7/8 x 3 7/8 x 2 7/8", Ø 1 1/4", valve cap, for basins without overflow

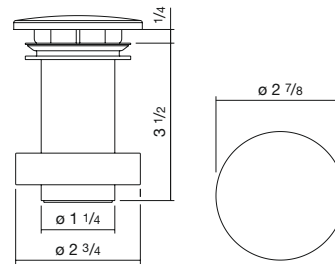

Chrome-plated
white

Art.-No.	Price
8310 000 978	232.00
8310 000 000	252.00

UR.1



Overflow rosette, round, wxhxd 1 3/8 x 1 3/8 x 1/2", suitable for Alape overflow set

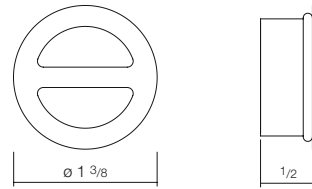

matt black
platinum matt
white

Art.-No.	Price
8321 000 980	45.00
8321 000 330	57.00
8321 000 331	45.00

Overflow set B.1



Overflow set, w/h/d 2 3/4/9 1/4 inch, equipped for eccentric and drain valve, for basins and washstands with overflow

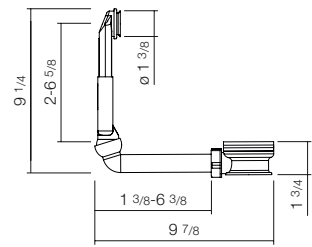

Art.-No.	Price
9500 280 000	29.00

Overflow set C



Overflow set, wxhxd 2 3/4 x 2 x 3 3/8", equipped for drain and universal valve, for basins and washstands without overflow

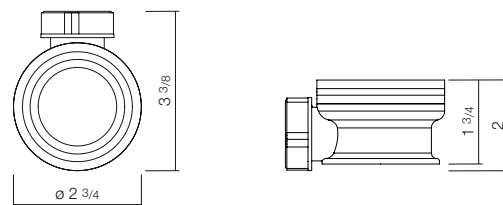

Art.-No.	Price
9500 410 000	15.00

Mounting and Connection Measurements

The following mounting and connection measurements can also be downloaded at www.alape.com. Installation instructions for freestanding washstands are available at www.alape.com.

Our customer service team is available to answer your questions. You can reach us at +1 (800)-774-1181.

Mounting and connection measurements

WT.RX325K

No. 4501 000 000 – with wall bracket cover

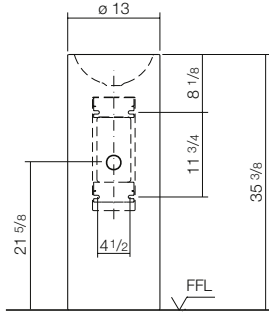

WT.RX400KH

No. 4500 000 000 – with wall bracket cover

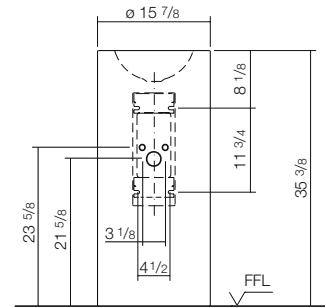

WT.RX400K

No. 4503 000 000 – with wall bracket cover

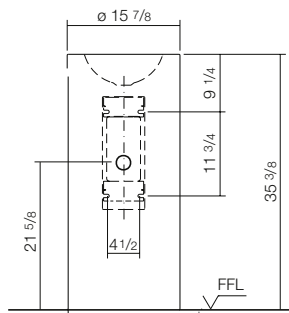

WT.RX325.KE

No. 4505 500 000 – with wall bracket cover

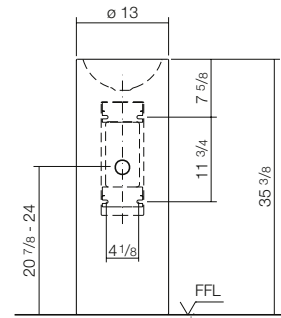

WT.RX400.KE

No. 4506 500 000 – with wall bracket cover

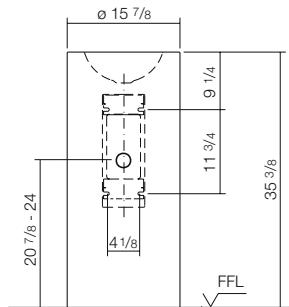

WT.RX400H.CO

Nr. 4507 800 000 – with wall bracket cover

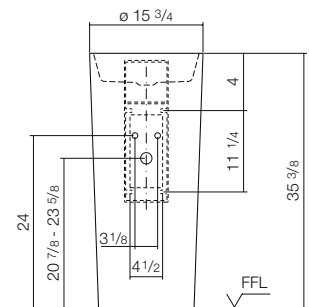

WT.RX400CO

No. 4507 500 000 – with wall bracket cover

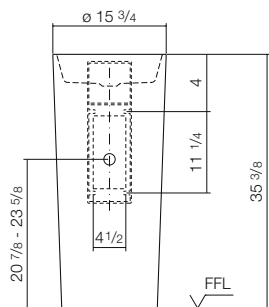

WT.RX325QS

No. 4801 000 000 – with wall bracket cover

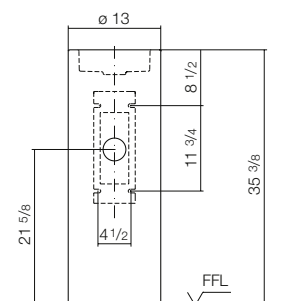

Mounting and connection measurements

WT.RX450QS

No. 4804 000 000 – with wall bracket cover

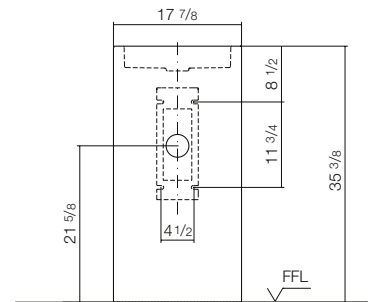

WT.RS450

No. 5054 000 000

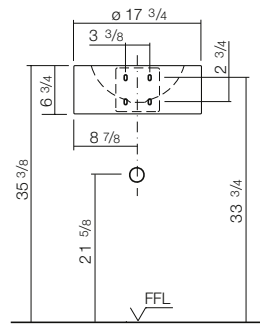

WT.RS400

No. 5052 000 000

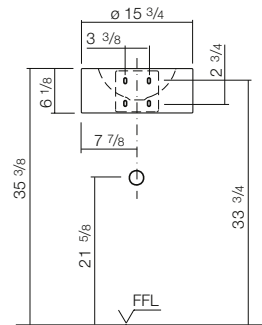

WT.RS325

No. 5042 000 000 – Visible drain

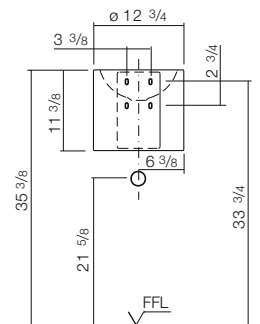

WT.RS325

No. 5042 000 000 – Covered drain

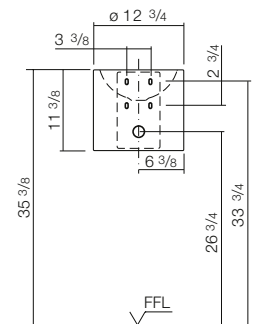

We recommend:
Viega chrome-plated
pipe siphon for bidet,
model 5535,
product no. 103781.

WT.C0400H

No. 5042 800 000 – with wall bracket cover

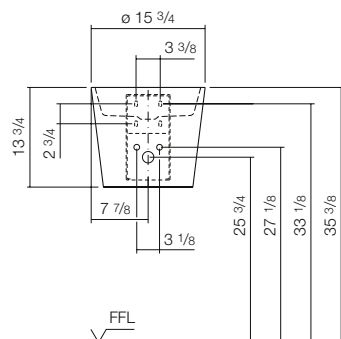

We recommend:
Space-saving trap
from Geberit
Art. No. 151.113.11.1

WT.C0400

No. 5042 500 000 – with wall bracket cover

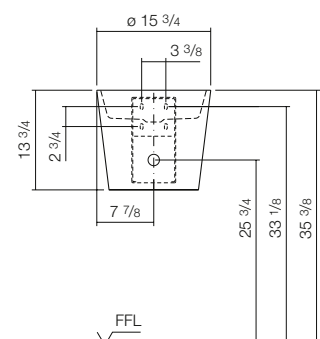

We recommend:
Space-saving trap
from Geberit
Art. No. 151.113.11.1

Mounting and connection measurements

WT.IC325H
No. 4236 000 000

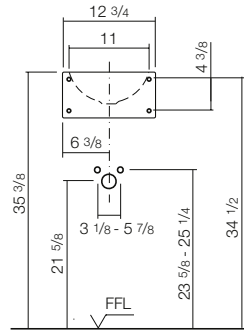

WT.IC600H
No. 4238 000 000

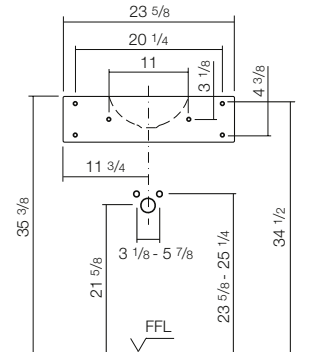

WT.IC600H.L
No. 4239 000 000

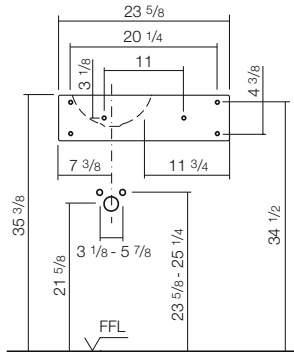

WT.IC600H.R
No. 4240 000 000

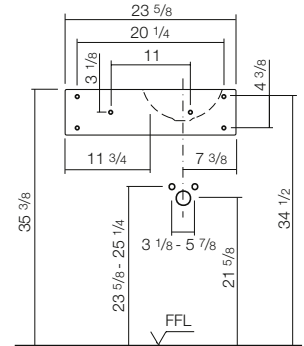

WT.MC450H
No. 4228 000 000

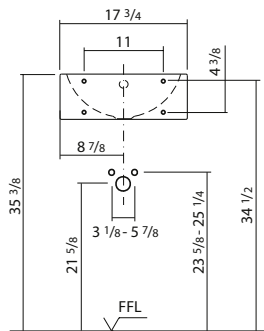

WT.MC800H
No. 4230 000 000

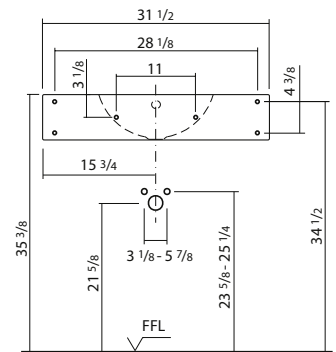

WT.MC800H.L
No. 4231 000 000

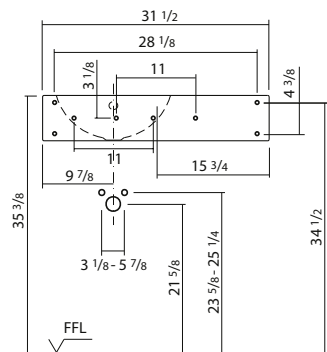

WT.MC800H.R
No. 4232 000 000

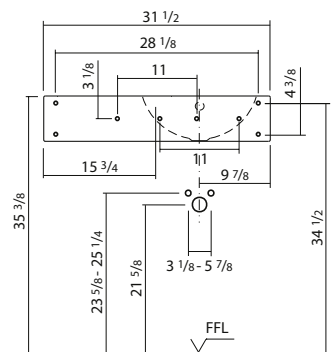

Mounting and connection measurements

WT.XXS450H.L
No. 4295 000 000

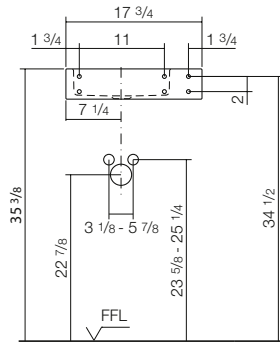

WT.XXS450H.R
No. 4297 000 000

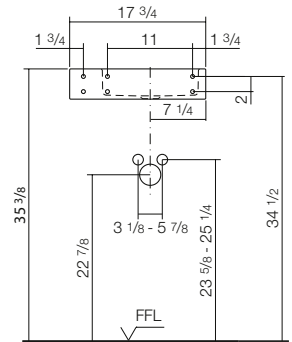

WT.XXS450.L
No. 4296 000 000

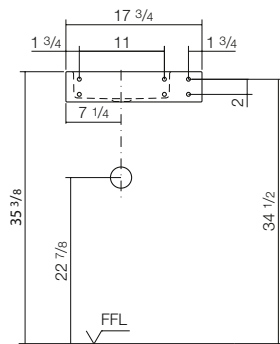

WT.XXS450.R
No. 4298 000 000

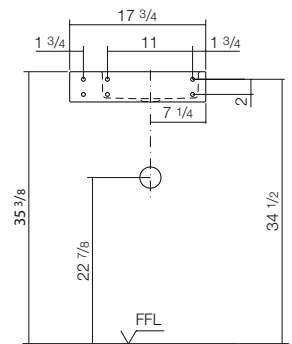

WT.XS500H.L
No. 4290 000 000

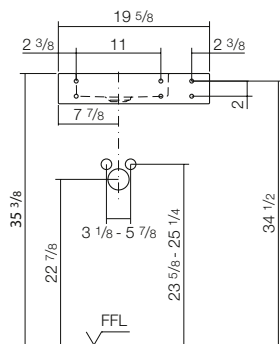

WT.XS500H.R
No. 4292 000 000

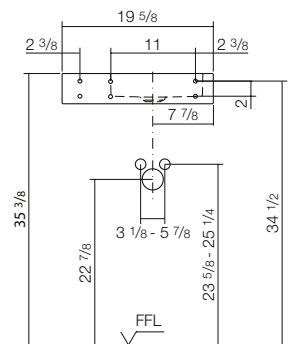

WT.XS500.L
No. 4291 000 000

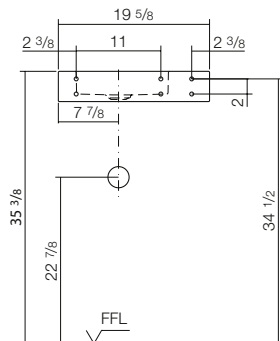

WT.XS500.R
No. 4293 000 000

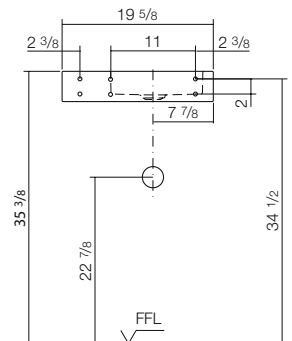

Mounting and connection measurements

WT.SR800H.R
No. 4282 600 000

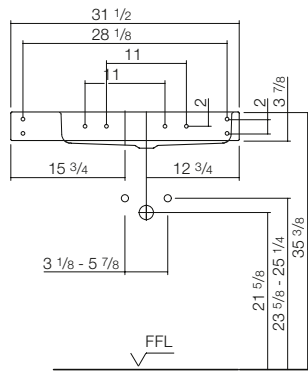

WT.SR800H.L
No. 4281 600 000

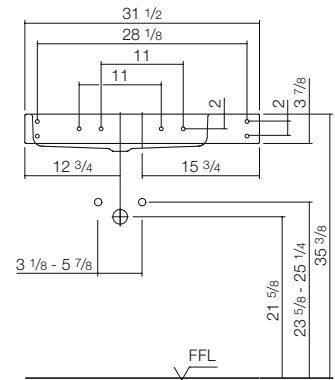

WT.PR585H
No. 4201 000 000

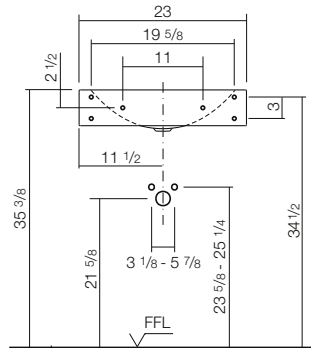

WT.PR585
No. 4200 000 000

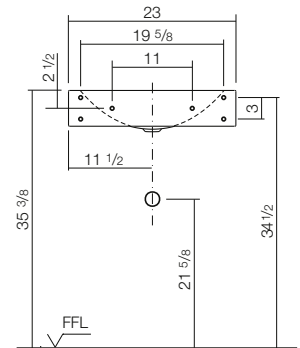

WT.PR800H
No. 4203 000 000

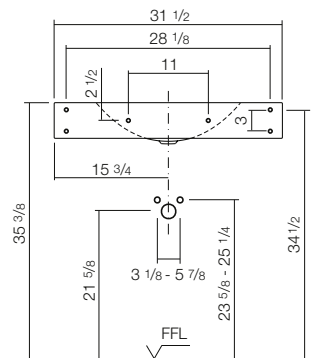

WT.PR800
No. 4203 300 000

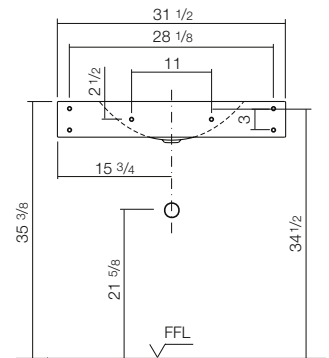

WT.PR800H.L
No. 4205 000 000

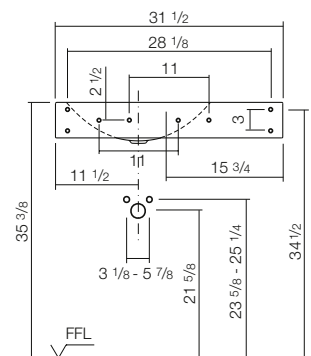

WT.PR800H.R
No. 4207 000 000

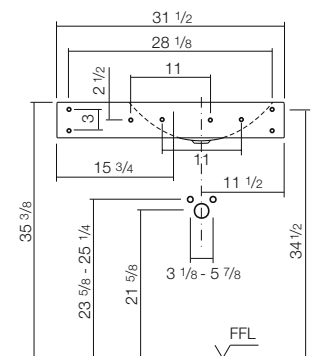

Mounting and connection measurements

WT.PR800.L
No. 4205 300 000

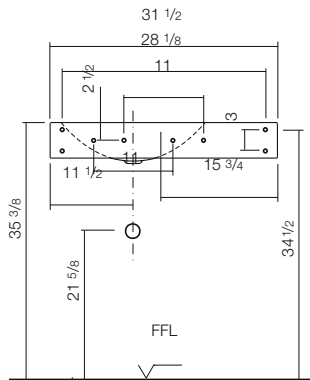

WT.PR800.R
No. 4207 300 000

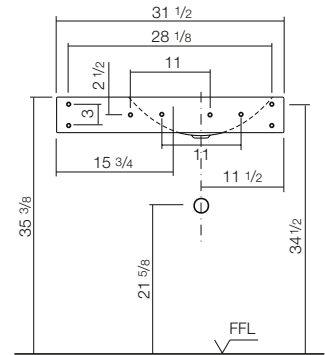

WT.GR800H
No. 4261 000 000

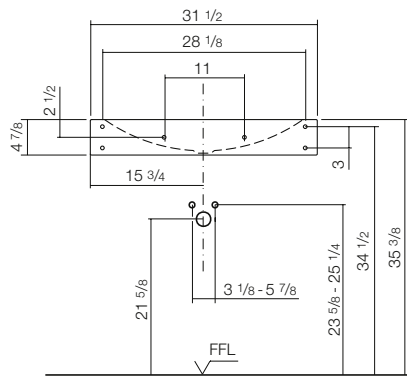

WT.GR1250H
No. 4287 000 000

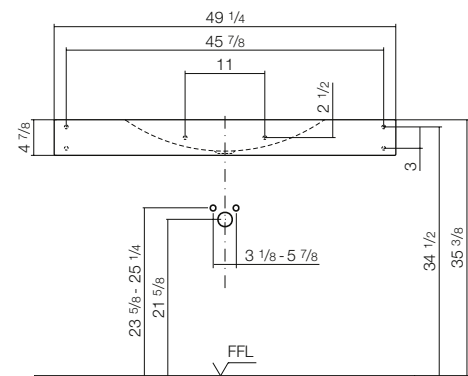

WT.GR1250H.R
No. 4289 000 000

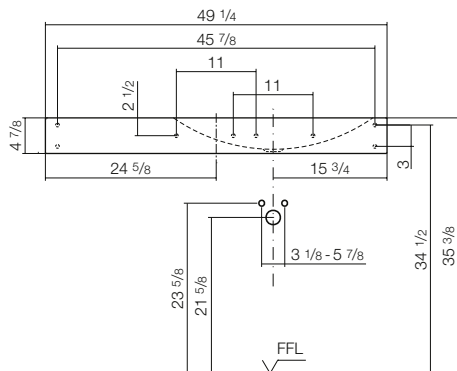

WT.GR1250H.L
No. 4288 000 000

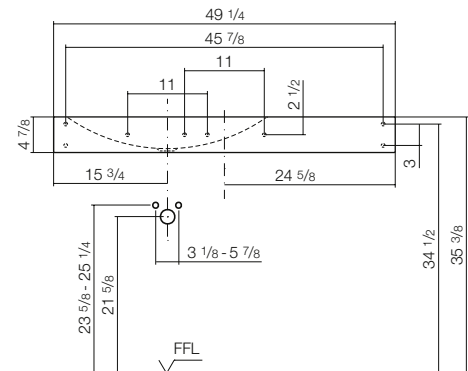

WT.RE800H
No. 4105 000 000

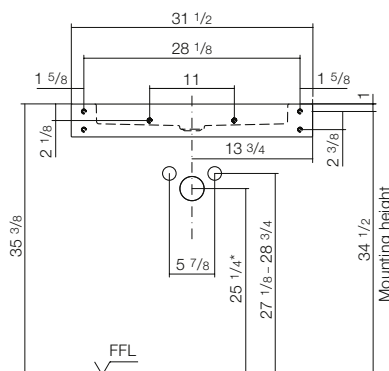

In case of deviating connection measurements, it should be ensured that a bottle trap with an immersion tube of approx. 300mm in length is used (e.g. SI.3 by Alape).

WT.RE1000H.L
No. 4102 000 000

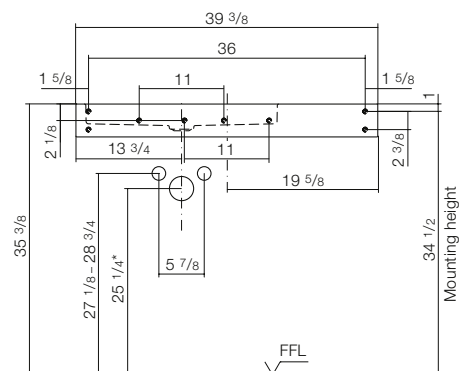

In case of deviating connection measurements, it should be ensured that a bottle trap with an immersion tube of approx. 300mm in length is used (e.g. SI.3 by Alape).

Mounting and connection measurements

WT.RE1000H.R
No. 4104 000 000

In case of deviating connection measurements, it should be ensured that a bottle trap with an immersion tube of approx. 300mm in length is used (e.g. SI.3 by Alape).

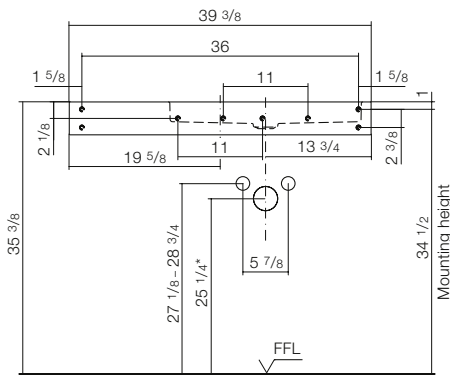

WP.Insert5
No. 5245 000 000

Plastic bottle trap with flexible outlet pipe is included
* Install angle valves without wall rosettes

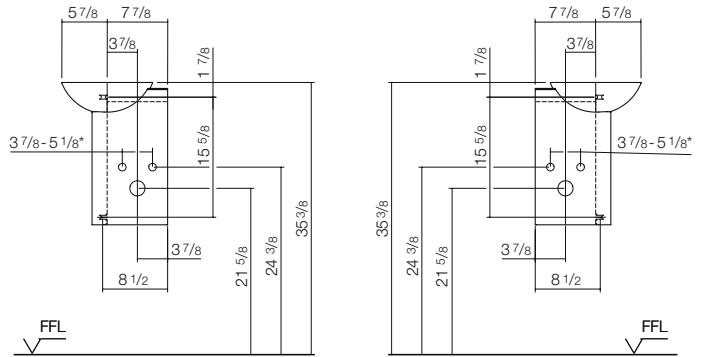

WP.PN1
No. 5256 000 XXX

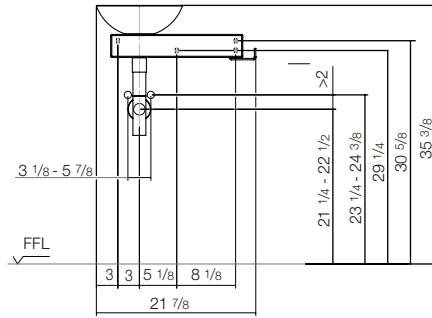

WP.PN2
No. 5257 000 XXX

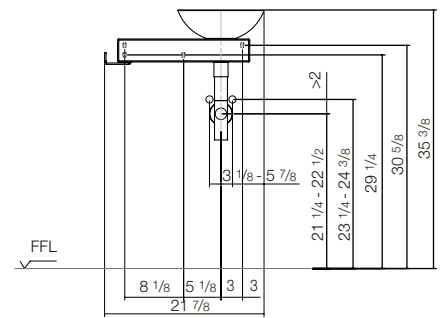

WP.F011
No. 5171 8XX 000

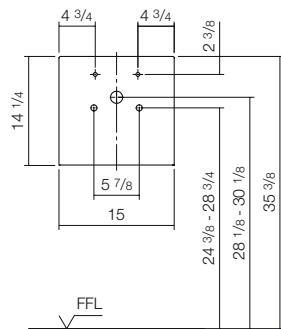

WP.F012
No. 5171 5XX 000

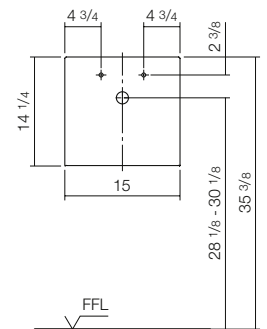

WP.F01
No. 5165 8XX 000

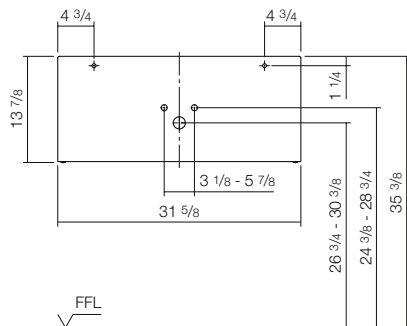

WP.F02
No. 5165 5XX 000

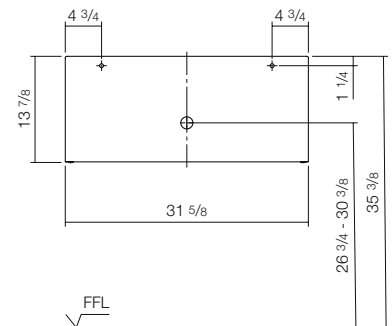

Mounting and connection measurements

WP . F03
No. 5166 8XX 000

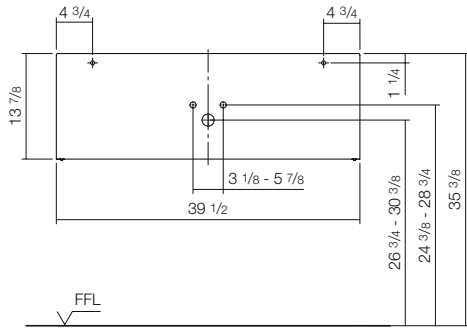

WP . F04
No. 5166 5XX 000

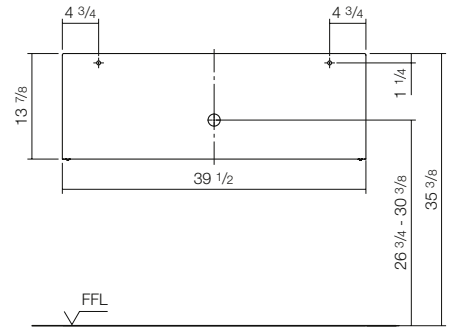

WP . F05
No. 5167 8XX 000

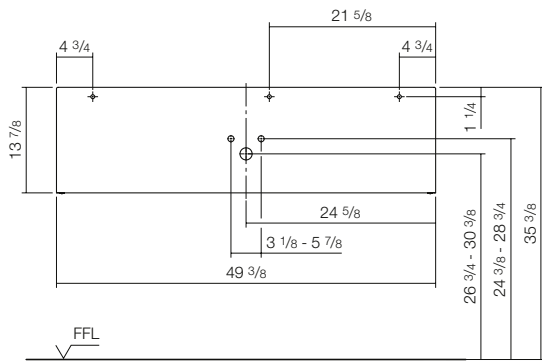

WP . F06
No. 5167 5XX 000

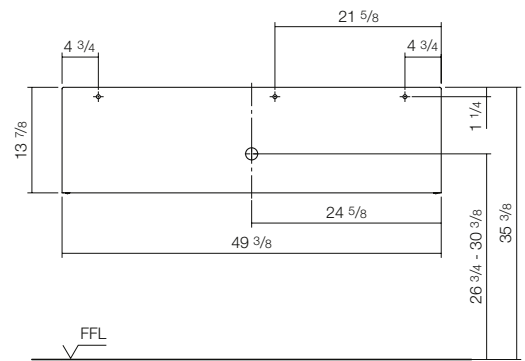

WP . F07
No. 5168 8XX 000

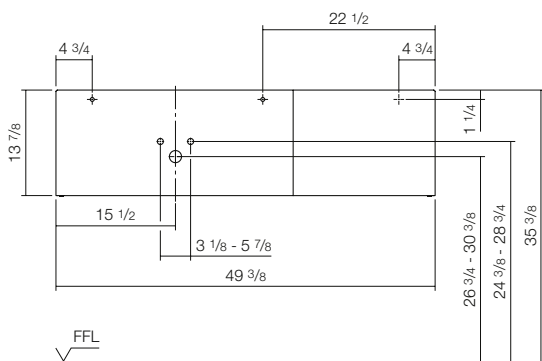

WP . F08
No. 5168 5XX 000

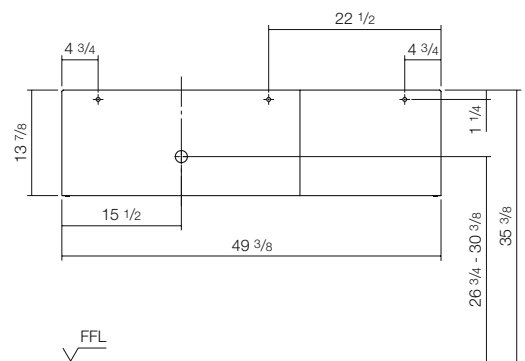

WP . F09
No. 5169 8XX 000

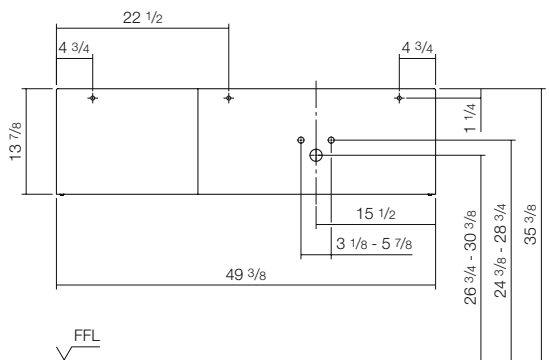

WP . F010
No. 5169 5XX 000

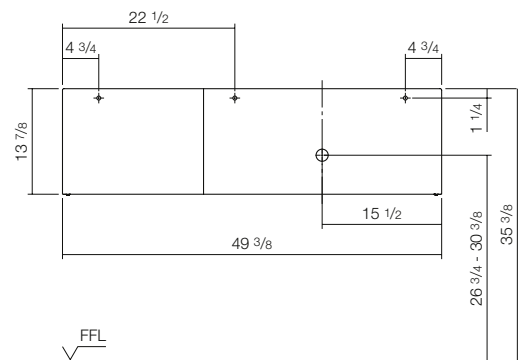

Return goods policy

- I. Alape will accept as return goods only products which are defective because of poor workmanship or materials.
- II. Authorization for the return of goods will be determined under the Conditions of Sale and Limited Warranties, as expressed in this pricelist. Please refer to the Warranty section for more information.
- III. Under no circumstances will merchandise be accepted for return without prior express written authorization.
- IV. Customers will submit requests for returns and must provide all of the following information:
 - A. Quantity
 - B. Article number and description
 - C. Purchase order or invoice number
 - D. Reason for return
- V. A copy of the Return Goods Authorization (R.G.A.) form authorizing you to return only the items listed will be send to you. A Return Shipping label will also be send to you. Any product returned that has not been authorized and included on the RGA form will be considered unauthorized and no credit will be issued. Unauthorized items will be returned to you at your expense.
- VI. Preparation of products for return: All products must be individually packed either in their original carton and packing materials, or carefully wrapped and boxed to prevent damage while in transit. Any Alape cartons must be placed in a proper shipping box with adequate packing materials. Please clearly indicate the contents on all internal boxes. Please tape all boxes closed.
- VII. The return shipment should be sent to Dornbracht Americas, freight prepaid, prior to the expiration date of the R.G.A. Any material returned after the expiration date will be refused and will not be accepted for credit at a later date. Please return goods via UPS GROUND SERVICE if possible. If weight or size of package prohibits using UPS, please ship freight collect. Enclose one copy of the R.G.A. form. The R.G.A. authorization number must be clearly written on all exterior boxes returned. Cartons not properly identified will not be accepted.
- VIII. The value of the returned merchandise will be determined following a physical inspection of the materials received. A credit for those items determined defective will then be issued.
- IX. The value of the items returned will be determined as follows:
 - A. Factory defective items or incorrectly shipped items – a full credit will be given upon receipt and inspection, if packaged properly. Credit for incorrectly shipped items will only be provided if the items are returned in the original carton and are in resalable condition.
 - B. Authorized return of resalable material – invoice price minus restocking charge based upon the time elapsed since the invoice date:
 1. Within 120 days of receipt – 25 percent restocking charge
 2. Over 120 days of receipt – merchandise will not be authorized for return
 - C. Unauthorized return – no credit issued.
 - D. Non-current goods – no credit will be issued for items that are returned that are no longer listed in our current catalog and pricelist.
- X. Special order items are not subject to return.
- XI. Proper packaging, labeling and protection of the return goods shipment is the responsibility of the shipper.

Return goods checkinglist

In order to receive credit on any return goods, please use the following check list:

- Have the returned products been carefully wrapped to prevent any damage?
- Are the returned products in the original packaging, or properly boxed and clearly marked with the product number?
- Has the product packaging been placed in a shipping carton with adequate packing materials?
- Is a copy of the R.G.A. form included with the returned products?

Conditions of sale and limited warranties

Over the years, Alape has earned a reputation for excellence in technology, design and quality control. Every effort has gone into making each Alape product perform to its own high standards and to satisfy the Customer. Alape provides the following limited warranties on its products: Alape warrants its products, installed in a residential application, to be free from manufacturing defects in materials and workmanship for a period of five (5) years from the date of purchase by the original consumer owner. This limited warranty is subject to the warranty conditions and limitations as set forth below.

General Finish Limited Warranty: Alape warrants the finish of its products installed in a residential application, to be free from manufacturing defects in materials and workmanship for a period of five (5) years from the date of purchase by the original consumer owner.

Warranty Conditions and Limitations: Alape does not assume liability for labor charges, removal and reinstallation expenses, freight or postage, injuries, or any incidental or consequential damages resulting from a defective product. Alape does not assume any responsibility other than to repair or replace the defective part(s) after Alape, upon its examination, has determined the product to be defective and the defective part(s) are covered by a limited warranty expressed in these Conditions of Sale and Limited Warranties. Whether to repair or replace the product or its finish shall be at the sole election of Alape. All of the limited warranties set forth in these Conditions of Sale and Limited Warranties are in lieu of any other warranties, express or implied.

All Alape warranties are strictly limited to the first residential consumer of its product. Alape Finish warranties are strictly limited to products correctly installed and used in a residential environment. Product problems which result from abuse, misuse, improper installation and/or maintenance, hard water, proximity to bodies of salt water, or accidental damage are not covered by any warranty set forth in these Conditions of Sale and Limited Warranties. Finish problems which result from abuse, misuse, improper installations and/or maintenance, hard water, proximity to bodies of salt water, exposure to direct sunlight or accidental damage are not covered by this warranty. The use of plumber's putty will void this warranty. A non-corrosive Epoxy Silicon sealing compound may be used.

Some states do not allow limitations on how long an implied warranty lasts, so the above limitation may not apply to you. Some states do not allow the exclusion or limitation of incidental or consequential damages, so the above limitation or exclusion may not apply to you. This warranty gives you specific legal rights and you may also have other rights which vary from state to state.

Warranty Claims: Alape warranties are limited to the first residential consumer of its product. These warranties are in effect for Alape products purchased on January 2004 and thereafter. For warranty claims, please contact your Alape dealer, or you may write to:

Dornbracht Americas Inc.
1700 Executive Drive South, Suite 600
Duluth GA 30096.

Please include the original receipt with a description of the problem, model number, store and date of purchase, name of installer, and your name, address and telephone number.

General Information

For Alape, comprehensive support in all planning phases is a matter of course. So if you need information on our product range or have any other questions, the representatives responsible for your region are happy to assist. Furthermore, you can reach our German office on +49(0)5321.558-111. Our service team provides partner-like and competent support. You can also find out more quickly and easily in the Internet.

Under www.alape.com you have the following services at your fingertips:

- Cutout dimensions for built-in, semi-built-in, sit-on and dish basins
- 2D and 3D drawings of all the Basic Components in dxf file format
- Technical data sheets and installation instructions as pdf
- Tender specifications in pdf format

Alape Representations abroad

Australia

Reece Australia Ltd
118 Burwood Highway
3125 Burwood Victoria
Australia
Phone: +61 (0)3.92740000
Fax: +61 (0)3.92740197
E-Mail: marketing@reece.com.au

Austria

Dornbracht Austria GmbH
IZ NÖ Süd, Straße 7, Objekt 58D, Top 6
2355 Wiener Neudorf
Austria
Phone: +43 (0) 1 417 06 90
E-Mail: mail@dornbrachtgroup.at

Baltic States

Arūnas Jazukevičius
P.d. 290, Kauno CP
44004 Kaunas
Lithuania
Phone: +370.686.30313
Fax: +370.37.202767
E-Mail: arunas.jazukevicius@burgbad-baltics.com

Belgium

Onderdeel van Dornbracht BV
Rivium Boulevard 21
2909 LK Capelle aan den IJssel
Nederland
Phone: +32 (0) 53 810 279
E-Mail: sales.bn@dornbrachtgroup.com

Bulgaria

Reallize Consult S.R.L.
Sönke Martin
Strada Varful Inalt 75
13132 Bucharest
Romania
Phone: +40(21)5280-391
Fax: +40(21)5280-390
E-Mail: sonke.martin@gmail.com

China (P.R.)

Dornbracht (Shanghai) Commercial Ltd.
Lingling Rd, No 899
Crossplaza, 28L.200030, Shanghai
China
Phone: +86-21 6360 6930
E-Mail: mail@dornbrachtgroup.com.cn

Czech Republic

Katja Kramárová
Seydlerova 2150
158 00 Prague
Czech Republic
Phone: +420 (0) 724.207.528
Fax: +420 (0) 602.273.113
E-Mail: kramarova@dornbrachtgroup.cz

France

Dornbracht France SARL
2, rue de la Roquette
75011 Paris
France
Phone: +33 (0) 1 40 21 10 70
Fax: +33 (0) 1 40 21 37 01
E-Mail: france@dornbrachtgroup.com

Finland

Dornbracht Nordic A/S
Masteskurene, skur 7, Galionsvej 33
1437 Copenhagen K
Denmark
Phone: +45 50 84 54 00
E-Mail: nordic@dornbrachtgroup.com

Greece

Klimatechniki S.A
Areopoleos 1
14564 Kifissia - Athens
Greece
Phone: +30(210) 81 60 061
Fax: +30(210) 81 61 255
E-Mail: info@davoline.gr

Germany

Alape GmbH
Am Gräbicht 1-9
38644 Goslar
Germany
Phone: +49(0)5321 558-0
Fax: +49(0)5321 558-400
E-Mail: info@alape.com

Hong Kong

The B.S.C. Group of Companies
19th Floor, Sino Favour Centre
1 On Yip Street, Chai Wan
Hong Kong
Phone: +852-2510 2328
Fax: +852-2807 1903
E-Mail: bsc@bschk.com

Hong Kong

Other Asia Pacific Countries:

Dornbracht Asia Pacific Ltd
Room 1305 & 1307, Sino Favour Centre,
1 On Yip Street, Chai Wan
Hong Kong
Phone: +852-2505 6254
Fax: +852-2505 9722
E-Mail: mail@dornbrachtgroup.hk

Hungary

Z-A Design Stúdió Kft.
Panoráma utca 9.
2016 Leányfalu
Hungary
Phone: +36 (0) 70.775 0954
Fax: +36 (0) 70.900 5613

Iceland

Dornbracht Nordic A/S
Masteskurene, skur 7, Galionsvej 33
1437 Copenhagen K
Denmark
Phone: +45 50 84 54 00
E-Mail: nordic@dornbrachtgroup.com

India

Dornbracht India Pvt Ltd.
1102, Wing-A, Cello Triumph, I.B. Patel
Road, Opp. Laghu Udyog, Goregaon (East),
Mumbai-400063 / India
Phone: +91 22 26853900
+91 22 26853912
Fax: +91 22 26853900
E-Mail: mail@dornbrachtgroup.in

Indonesia

PT CJ Trading
Jakarta Design Center 4th Floor No. SR 15
Jl. Gatot Subroto 53, Slipi
10260 Jakarta
Indonesia
Phone: +62-21 572 0519
Fax: +62-21 572 0539
E-Mail: cjsales@cbn.net.id

Italy

Dornbracht Italia s.r.l.
Via Morimondo 2/5
20143 Milano
Italy
Phone: +3902 818 343 1
Fax: +3902 818 343 215
E-Mail: mail@dornbrachtgroup.it

Alape Representations abroad

Japan

Reliance Inc.
Shinkoku Kokusai New Bldg 1F 6-3,
Nishishinjuku6-chome Shinjuku-ku,
Tokyo 160-0023 / JAPAN
Mari Kaneko
Phone: +81 3 5909 0535
Fax: +81 3 5909 0537
E-Mail: kaneko@reliance.co.jp

Lebanon

Naji Kanafani & Fils
Corniche Mazraa, Habib Building
Beirut 1105-2040
Lebanon
Phone: +961 1 307 400
Fax: +961 1 307 403
E-Mail: info@kanafani.com.lb

Malaysia

GC Building Technologies (M) Sdn Bhd
No. 7 Jalan Perintis U1/52
Temasya Industrial Park, Section U1
Glenmarie
40150 Shah Alam, Selangor / Malaysia
Phone: +603 5569-9689
Fax: +603 5569-8689
E-Mail: gcmal@gcbuildtech.com.my

Marocco

Medisol. c/o Najib Laghmar
138, Angle Bd Omar El Khayam et Rue
Banafsaj 20200 - Beauséjour - Casablanca
Marocco
Phone: +212 522.9451-32/35
Fax: +212 522.9451-39
E-Mail: nlaghmar@medisol.ma

Moldova

Reallize Consult S.R.L.
Sönke Martin
Strada Varful Inalt 75
13132 Bucharest
Romania
Phone: +40 (21) 5280-391
Fax: +40 (21) 5280-390
E-Mail: sonke.martin@gmail.com

Netherlands

Onderdeel van Dornbracht BV
Rivium Boulevard 21
2909 LK Capelle aan den IJssel
Netherlands
Phone: +31 (0) 10 52 43 400
E-Mail: sales.bnl@dornbrachgroup.com

New Zealand

Metrix Import Ltd.
Parnell, Auckland 1010,
PO BOX 100-840
NSMC 0745
New Zealand
Phone: +64-9 444 5656
Fax: +64-9 444 5151
E-Mail: info@metrix.co.nz

Nordic

Dornbracht Nordic A/S
Masteskurene, skur 7
Galionsvej 33
1437 Copenhagen K
Denmark
Phone: +45 50 84 54 00
E-Mail: nordic@dornbrachgroup.com

Philippine

Focus Global Inc.
Pioneer Corner Reliance Streets,
Mandaluyong Manila
Philippine
Phone: +63 2 634 8587
Fax: +63 2 634 8738
E-Mail: customerservice@focusglobalinc.com

Poland

Honorata Broniowska
Ul. Janockiego 41
66-400 Gorzow WLKP.
Poland
Phone: +48 602 471 319
Fax: +48 95 728 261 7
E-Mail: biuro@dornbrachgroup.pl

Romania

Reallize Consult S.R.L.
Sönke Martin
Strada Varful Inalt 75
13132 Bucharest
Romania
Phone: +40 (21) 5280-391
Fax: +40 (21) 5280-390
E-Mail: sonke.martin@gmail.com

Russia

OSA GmbH & Co. KG
Am Tyrol 21
58636 Iserlohn
Germany
Phone: +49 (0) 2371.23311
Fax: +49 (0) 2371.26317
E-Mail: b.danielson@o-s-a.de

Singapore

Dornbracht South East Asia Pte. Ltd.
Level 18, Republic Plaza II
9 Raffles Place
Singapore 048619
Phone: +65-6823 6813
E-Mail: mail@dornbrachgroup.sg

Slovakia

Agentura kramarova
Seydlerova 2150
158 00 Prague
Czech Republic
Phone: +420 (0) 724 207 528
Fax: +420 (0) 602 273 113
E-Mail: mkramar@email.cz

Slovenia

Leon Ladic s.p.
Nikova ulica 10
2000 Maribor
Slovenia
Phone: +386 51 387 458
E-Mail: leon.ladic@gmail.com

South Africa

Flush Bathrooms Interiors
Siebhan Thomas
PO Box 148
Paarden Eiland
Cape Town
7420
South Africa
Phone: +27 825 742 432
E-Mail: siobhan@flushbathrooms.co.za

South Korea

E.L. Systems
4th Fl., Jaemyeong Bldg., 893-12
Bangbae 1-dong, Seocho-gu, Seoul
South Korea
Phone: +82 (0) 2.3445-3781
Fax: +82 (0) 2.3445-3784
E-Mail: importing@chol.com

Spain

Dornbracht España S.L.
c / Folgueroles 17-25, local 3
08022 Barcelona
Spain
Phone: + 34 932 723 910
Fax: + 34 932 723 913
E-Mail: mail@dornbrachgroup.es

Alape Representations abroad

Switzerland

Dornbracht Schweiz AG
Letziweg 9
CH-4663 Aarburg
Switzerland
Phone: +41 (0) 62 787 20 30
Fax: +41 (0) 62 787 20 40
E-Mail: swiss@dornbrachtgroup.com

Taiwan R. O. C.

Lafon Trading Co. Ltd.
11F-3, No.12, FU-Hsing 4th Rd.
Chien-Chen Dist.
80661 Kaohsiung
Taiwan
Phone: +886-7 338 2000
Fax: +886-7 331 8000
E-Mail: info@lafon.com.tw

Thailand

Arkitektura
125/1 Thong Lor Soi 10
Sukhumvit 55 Rd., Wattana, Bangkok 10110
Thailand
Phone: +662 392 5460-4
E-Mail: info@arkitektura.co.th

Tunisia

SOTEM Distribution
Siège: 5 Avenue Med V
2015 Le Kram
Tunisia
Phone: +216 719 74-774/775
Fax: +216 719 76-421
E-Mail: showroomtunis@sotemtn.com
www.sotemtn.com

Turkey/Central Asia

Dornbracht Turkey/Central Asia
Karanfil Caddesi
Karanfil Aralığı Sokak No:6
34330 2. Levent / İstanbul
Turkey
Phone: +90 (212) 284 94 95
Fax: +90 (212) 284 00 23

Ukraine

Lesia Khelemendyk
Saksaganskogo str. 89a, of 1
01032 Kiev
Ukraine
Phone: +38 (044) 225.4117
E-Mail: office@dornbracht.com.ua

United Arab Emirates /Middle East

Dornbracht International GmbH
Rep Office
PO Box 114268
Dubai
UAE
Phone: +971.4 380 6611
Fax: +971.4 380 6606
E-Mail: dornbrachtme@dornbrachtgroup.com

United Kingdom

Dornbracht UK Ltd.
Unit 8 & 9 Bow Court
Fletchworth Gate
Coventry
CV5 6SP / UK
Phone: +44 (0) 2476 717 129
Fax: +44 (0) 2476 718 907
uk@dornbrachtgroup.com

USA

North American Headquarters
Dornbracht/Alape
1700 Executive Drive South
Suite 600
Duluth, GA 30096
USA
Phone: +1 (800) 774 1181
Fax: +1 (800) 899 8527
E-Mail: usa@alape.com

Imprint

Publisher Alape GmbH Goslar/Germany

Graphics Heine/Lenz/Zizka Projekte GmbH, Frankfurt/Berlin

Printing Meinders & Elstermann, Belm/Germany

Design Partner busalt design, Traunreut/Germany - Lykouria Design, London/Great Britain - sieger design, Sassenberg/Germany

Reprinting or reproduction of this manual or extracts thereof, irrespective of the method used, is only permitted with the consent of the manufacturer. If you require a components manual, we would be pleased to provide you with one.

The listed dollar prices are trade prices intended for bath showrooms (MSRP – Manufacturer Suggested Retail Prices). Value-added tax is not included in the prices.

Subject to model, program and technical changes, as well as errors.

The General Terms and Conditions of Alape GmbH apply (see www.alape.com).

All previous pricelists become invalid with the publication of this Price book.

Dimensions in inch
The Price book is effective June 1, 2021.

Art.No. 0167 000 021

Color matrix – Glossy and matte colors

Standard Color

000 white

Glossy Colors

Surcharge 30% of the gross list price of the model.

156 Grey

201 Black

Matte Colors

Surcharge 30% of the gross list price of the model.

004 Matte white

154 Matte grey

240 Matte black

UB Undermount basins / EB Built-in basins / HB Semi-recessed basins															
Mould	S, K, O, R			Sondo		Q		RE		Stream		ME (3mm)		KE (3mm)	
Basin type	UB	EB	HB	UB	EB	UB	EB	UB	EB	UB	EB	UB	EB	UB	EB
Grey 156	X	X	X	X	X	X	X	X	X	X	X	-	-	X	X
Black 201	X	X	X	X	X	X	X	X	X	X	X	X	X	X	X
Matte white 004	X	X	X	X	X	X	X	X	X	X	X	X	X	X	X
Matte grey 154	X	X	X	X	X	X	X	X	X	X	X	-	-	X	X
Matte black 240	X	X	X	X	X	X	X	X	X	X	X	-	-	X	X

AB Sit-on basins / SB Dish basins											
Mould	K	R	K, O	CO	Sondo	Q	RE	Stream		ME (3mm)	KE (3mm)
Basin type	AB	AB	SB	SB	AB	AB	AB	AB	SB	AB	AB
Grey 156	X	-	X	o. r.	X	-	-	-	X	-	X
Black 201	X	X	X	o. r.	X	X	X	X	X	X	X
Matte white 004	X	X	X	o. r.	X	X	X	X	X	X	X
Matte grey 154	X	-	X	o. r.	X	-	-	-	X	-	X
Matte black 240	X	-	X	o. r.	X	-	-	-	X	-	X

WT Washstands															
Mould	IC, MC	K	CO	CO	RS	QS		RE	PR	GR	Stream	XS	XXS	WT.RX...KE	
Basin type	WT	WT.RX	WT	WT.RX	WT	WT	WT.RX	WT	WT	WT	WT	WT	WT	Basin	Pillar
Grey 156	-	-	o. r.	o. r.	X	-	-	-	-	-	-	-	-	X	X
Black 201	X	X	o. r.	o. r.	X	-	X	-	X	X	-	-	X	X	X
Matte white 004	X	X	o. r.	o. r.	X	X	X	X	X	X	X	X	X	X	X
Matte grey 154	-	-	o. r.	o. r.	X	-	-	-	-	-	-	-	-	X	X
Matte black 240	-	-	o. r.	o. r.	X	-	-	-	-	-	-	-	-	X	X

UB – Undermount basin **EB** – Built-in basin **HB** – Semi-recessed basin **AB** – Sit-on basin **SB** – Dish basin **WT** – Washstand

X: available in this color - : not available in this color o. r. : on request

Pillar washstand

If a matte color is chosen, the wall bracket of the pillar washstands is either Matte white or matte black, thus varying from the color of the pillar.

- matte white wall bracket if the color is: matte white.
- matte black wall bracket if the color is: black/grey/matte black/matte grey

Please note:

- Special colors on request
- You can find information on special glazes in the corresponding section

Alape GmbH
Am Gräbicht 1–9
38644 Goslar

Postfach 2812
38628 Goslar
Germany

Tel +49 (0)5321 558 0
Fax +49 (0)5321 558 400
export@alape.com

Service Hotline
Tel +49 (0)5321 558 111

www.alape.com

North American Headquarters:
Alape / Dornbracht
1700 Executive Drive South
Suite 600
Duluth, GA 30096
USA

Tel + 1 (800) 774 1181
Fax + 1 (800) 899 8527
mail.usa@alape.com

Alape[™]

~form Washboasins, Washstands and washplacces

2021 USA | Valid from the 1st of June 2021

~

Alape
USA