

# CATALOG 2021

---

a company of  
**Hansgrohe Group**





# ABOUT ESS

---

## TRENDSETTING BATHROOM SOLUTIONS

ESS stands for Easy Sanitary Solutions, and at the same time is the best and most appropriate statement to describe our products. Simple, practical and advantageous for installation specialists and end users, and of the very highest quality.

As a Dutch family business, dealing with water is second nature to us. That is why we provide excellent drainage solutions to suit every need and situation. We are the inventors, developers and official suppliers of Easy Drain linear shower drains. As the initiators of barrier-free bathroom layouts, we have proven that our bathroom solutions are simple, practical and elegant.

A bathroom should be as aesthetically pleasing as it is functional, which is why we place great emphasis on technical development and design. This translates into beautiful and unique container bathroom accessories.



# OUR HISTORY

---



## 1928

---

### WERE IT STARTED

It all began in 1928, in the small village of Losser (the Netherlands) where our family-owned company, Keizers, began designing, manufacturing and selling sanitary solutions. It was here that we laid the foundations for ESS's achievements, and our success continues today.

### WHERE WE ARE NOW

We have grown from our humble beginnings, and now operate in two state-of-the-art factories in the Netherlands and Germany, selling and distributing to over 40 countries and delivering high-quality and innovative design that has transformed bathrooms worldwide.

### HEAD OFFICE

In 2013, we opened our head office in Oldenzaal, Netherlands. This is the global center for product development, sales, marketing and finance. Our head office is located less than 10 km from where the Easy Drain was first invented.



## 2013

### KEIZERS SHOWROOM

The family business, Keizers, opened its showroom in Losser, where it started to sell bathrooms, kitchens and tiles. This place saw the conception and development of many of our innovative products and solutions.



1972

### INVENTING THE LINEAR SHOWER DRAIN

When the Keizers brothers invented the Easy Drain linear shower drain, it established floor-level showering and transformed bathrooms worldwide. This invention led to Easy Sanitary Solutions (ESS) being established as a company.

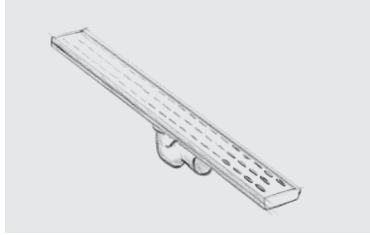

2002

### FACTORY & TRAINING CENTER

In 2009, we opened our ultra-modern factory and training center in Bad Bentheim, Germany. It's here that all of our innovative products, including the Easy Drain, are manufactured and prepared to send to clients all over the world.



2009

### EXPERIENCE CENTER

In 2014, we relocated the Keizers showroom from Losser. Now, it's right next to the ESS head office in Oldenzaal. This state-of-the-art experience center showcases bathrooms, tiles and other ESS products.



2014

### FACTORY EXPANSION

We have a strong global presence and our cutting-edge, innovative products are in high demand worldwide. 2017 saw the expansion of ESS's factory and warehouse in Germany to allow us to increase production.



2017







### FIT FOR THE FUTURE

Innovation is at the heart of everything we do at ESS. 2020 saw a significant digital transformation, enhancing our traditional manufacturing process with advanced technology and ensuring our business is fit for the future.

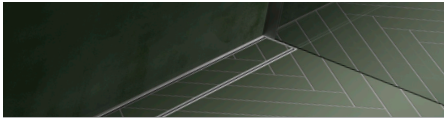

2020

## LINEAR SHOWER DRAINS

	Modulo TAF / TAF Wall	<b>18</b>
	Modulo Stone	<b>26</b>
	M-line	<b>28</b>
	S-line	<b>30</b>
	Xs	<b>32</b>
	Vinyl	<b>34</b>

## POINT DRAINS

	Aqua Jewels	<b>36</b>
---	-------------	-----------

## ACCESSORIES

	Accessories	<b>42</b>
---	-------------	-----------

## WATERPROOFING

	Easy Seal	<b>44</b>
---	-----------	-----------

## WALL NICHES

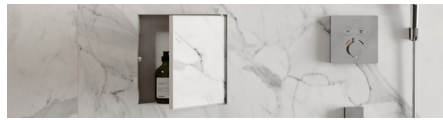

T-BOX

**52**



C-BOX

**54**



BOX

**56**

## BATHROOM & TOILET ACCESSORIES

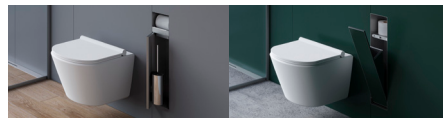

T-ROLL

**60**

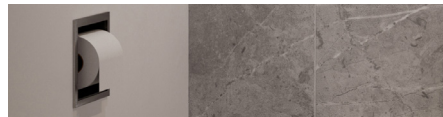

ROLL

**62**

# INSTALLATION

---



## WALL INSTALLATION

Installation against the wall and between the two side walls. This type of installation requires a one-sided slope and offers high drainage capacity.

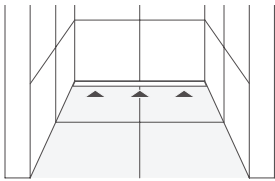

\* Requires an exact length of the shower drain



## ENTRANCE INSTALLATION

Installation at the entrance of the shower between the two walls. This type of installation requires a one-sided slope.

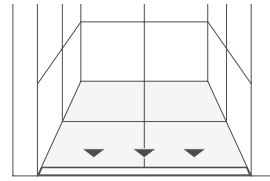

\* Requires an exact length of the shower drain



## FREE IN THE FLOOR INSTALLATION

Installation with floor tiles on all four sides of the shower drain. This installation requires a four-sided slope.

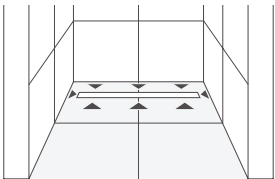

## ONE-SIDED INSTALLATION

Installation against the wall with tiles on the other three sides. This type of installation requires a three-sided slope and offers high drainage capacity.

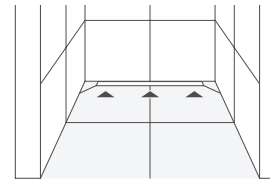

## WALL TO WALL INSTALLATION

Installation between the walls, with floor tiles on either side of the shower drain. This type of installation requires a two-sided slope.

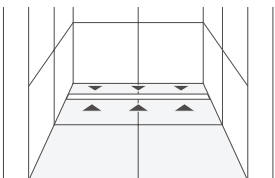

\* Requires an exact length of the shower drain



## FREE IN THE FLOOR INSTALLATION

Installation with floor tiles on all four sides of the shower drain. This installation requires a four-sided slope.

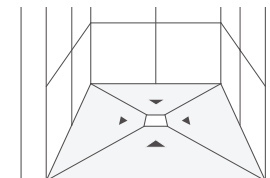

# WATER PROTECTION SYSTEM (WPS)

Easy Drain's innovative Water Protection System (WPS) provides an easy-to-install and safe-to-assemble seal system for shower drains. This WPS-system consists of a flexible waterproofing membrane which is connected to the linear drain's stainless steel flanges or the floor drain's special cuff. This way, leaking as a result of faulty installation due to unfavorable conditions is eliminated.

## Preferred by professionals worldwide

Easy Drain's WPS-system is developed with over more than 16 years of experience in the sanitary industry and is preferred by professional installers and tilers worldwide. This shows once again, that the easy and safe solutions of ESS are a milestone in shower drainage design and development.

## Perfect waterproof connection

WPS forms the perfect waterproof connection between a drain and its surrounding floor when using a rapid-drying flexible sealing compound. Unique to this system is that it's pre-assembled in a controlled manufacturing environment, therefore preventing assembling mistakes or adhesive problems caused by working in an unclean construction site.

## Advantages

- > Guaranteed a 100% watertight installation
- > 10-year warranty
- > Factory pre-assembled waterproofing membrane
- > Tear resistant
- > Can be installed on Hotmop (after the Hotmop is cooling down)

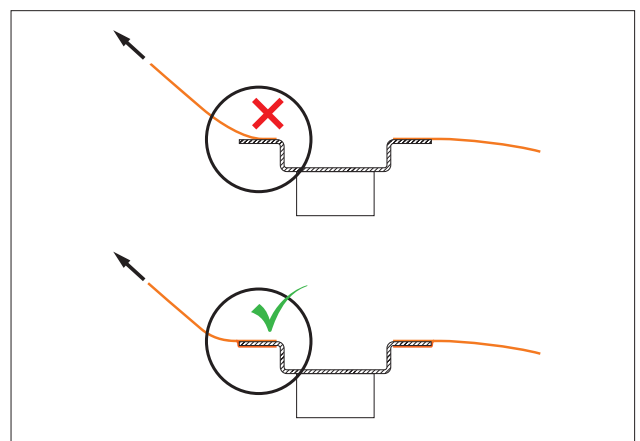
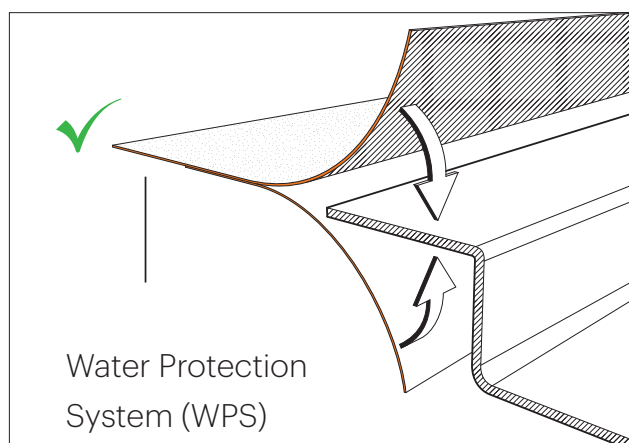
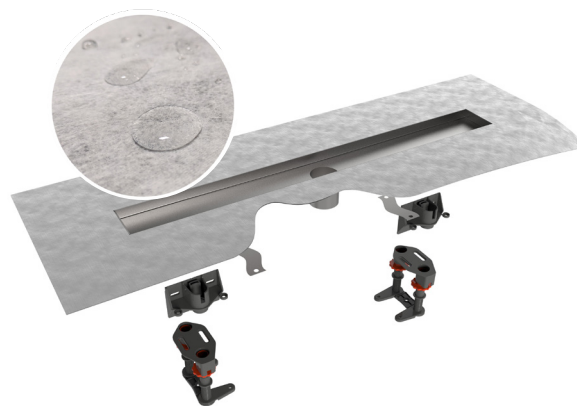

# TILE ADJUSTABLE FRAME (TAF)

- > Perfect finish with closed tile edges
- > Saves time and eliminates guesswork
- > Frame length adjustable using extension set
- > Available sizes up to 78 3/4" (2000 mm)

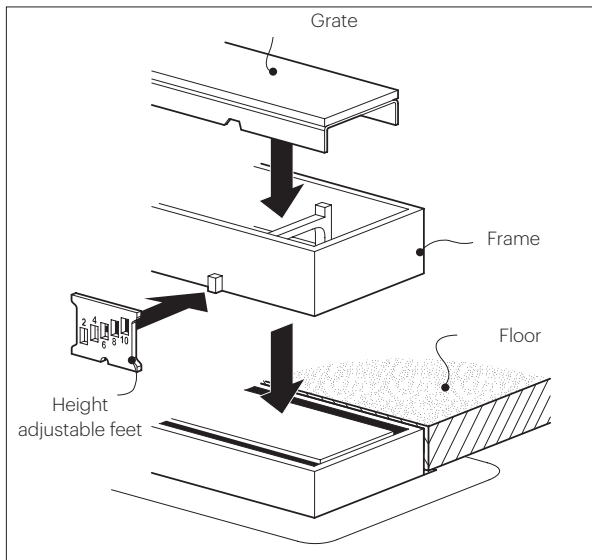

## TAF

- > Standard thickness flooring
- > 1/4" - 3/4" (7 - 18 mm)
- > Tile

## INSTALLATION

### 1. Position

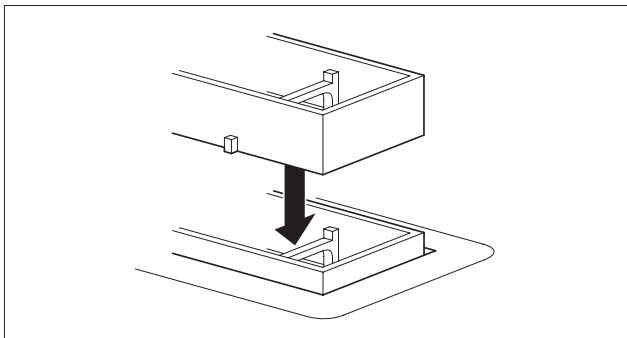

### 2. Measure

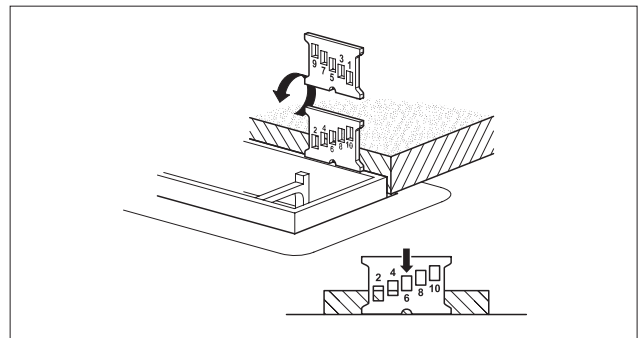

### 3. Adjust

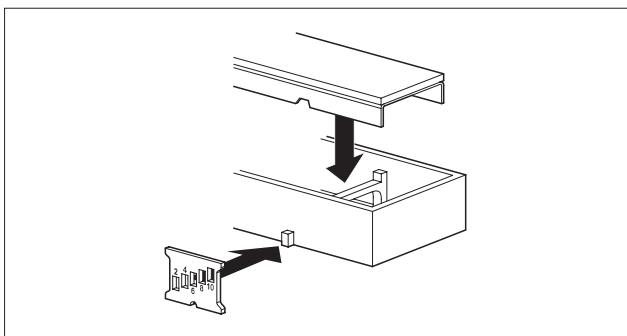

### 4. Level

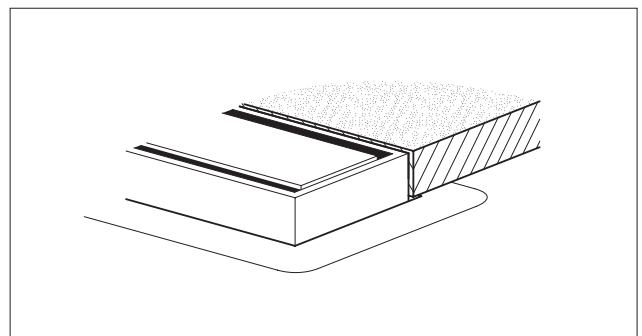

# SECONDARY WATER DRAINAGE

---

With our patented TAF-system (Tile Adjustable Frame) we offer a unique option to apply secondary drainage in a barrier-free installation. This way, any water leaking under the tiles due to porous sealant or cracks can flow back into the shower drain. The stainless steel TAF frame can be easily adjusted in height, after installing the drain's rough, to match the level of the surrounding tiled floor. All shower drains with TAF-system are also equipped with our pre-assembled sealing membrane (WPS).

## Advantages

- > Any water leaking under the tiles can flow back into the shower drain
- > Tile Adjustable Frame for easy leveling to any tile thickness
- > Water Protection System for a 100% watertight installation
- > 10-year warranty with our Easy-seal system

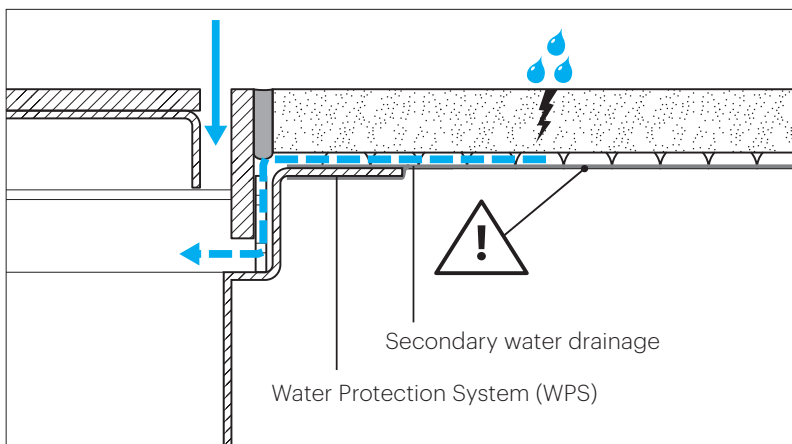

# SELF-ADHESIVE WATERPROOFING MEMBRANE (SAM)

---

SAM is a revolutionary seal system based on elastic foam technology. The self-adhesive waterproofing membrane can be applied directly to wall and floor surfaces without using additional liquid sealing material. The top side is fleece-coated with an anti-bacterial film and offers an ideal base surface for every type of tile adhesive.

## 100% Watertight

Most moisture related damages result from improper installation of liquid sealed sealing membranes, wall-to-floor transfers and drainage systems. The patented SAM seal system avoids moisture damage by using fleece free impact bonding. The non-woven zones interrupt the capillary movement of moisture and ensure a 100% watertightness.

The following primed base surfaces can be sealed with SAM:

- > Concrete
- > Existing ceramics (tiles)
- > Cement screeds
- > Plasterboard
- > Dry screed
- > Timber

## Advantages

- > Time-saving installation (no drying time)
- > Surface immediately ready for tiling
- > Suitable for all types of building chemicals
- > No more liquid sealing necessary
- > 100% watertight warranty - 10-year warranty
- > Antibacterial fleece coating to prevent mold formation
- > High material elasticity prevents cracking
- > Acoustic decoupling between finished surface and building construction
- > Instantly high adhesive force (20 ton / ft<sup>2</sup>)
- > Can be installed on Hotmop (after the Hotmop is cooling down)



Uniform Plumbing Code includes Sam (Easy Seal). ANSI A118:10-2014, which is a component standard of the ANSI A108, A118, A136 Specifications for the Installation of Ceramic Tile (Material & Installation Standards). See [Easy Seal](#) for more information.



# CONTAINER

---

With our Container Series storage solutions, you can conveniently hide away all your bathroom and toilet items. The series has been specifically developed for use in wet areas and offers a 100% watertight installation. Because of its perfect and sleek design, Container Series products will fit harmoniously into any bathroom.

## Easy installation

Our Container storage solutions are available in various dimensions and color finishes. Installation and waterproofing are made easy thanks to included built-in element and self-adhesive sealing membrane. All the products are suitable for recess and semi recess mounting in drywall and offer uncomplicated tiling. Find out what our Container Series can do for your bathroom.

## Advantages

- > High-quality stainless steel
- > Easy to install with uncomplicated sealing and tiling
- > Specifically developed for application in wet area
- > Various design finishes

### Recess and semi recess installation

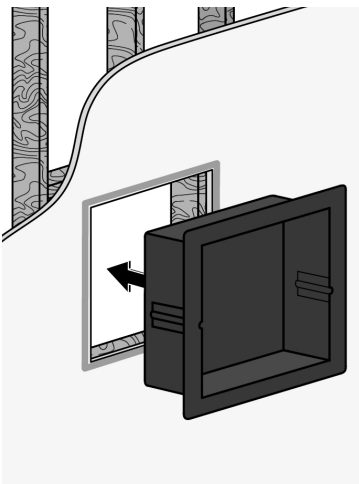

### Waterproofing installation kit





# MODULO

## Step 1. Rough

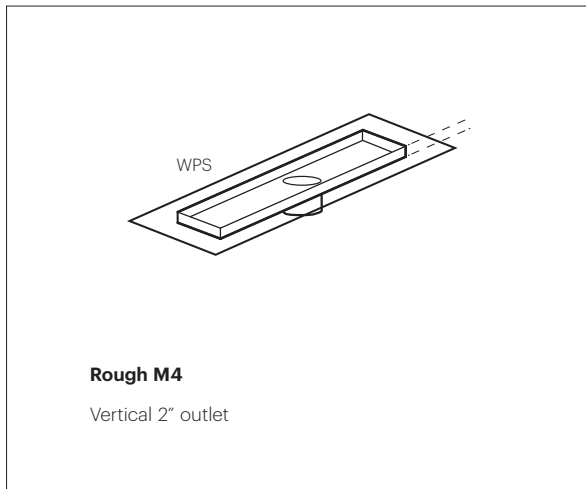

## Step 2. Trim

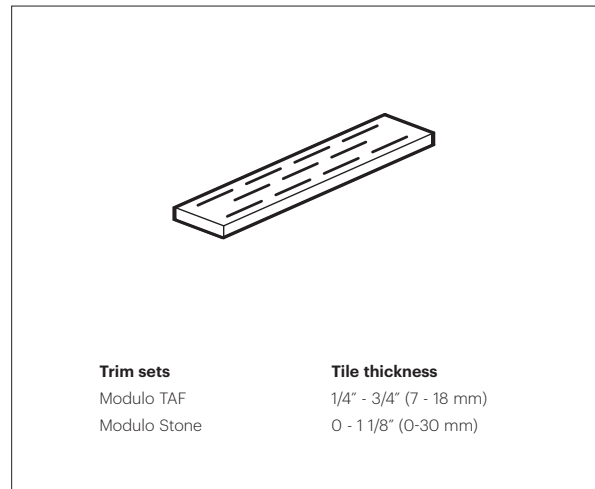

Both parts are displayed according to length. Make sure to order both rough and trim set in the same length.



# MODULO TAF | SPECIAL FINISHES

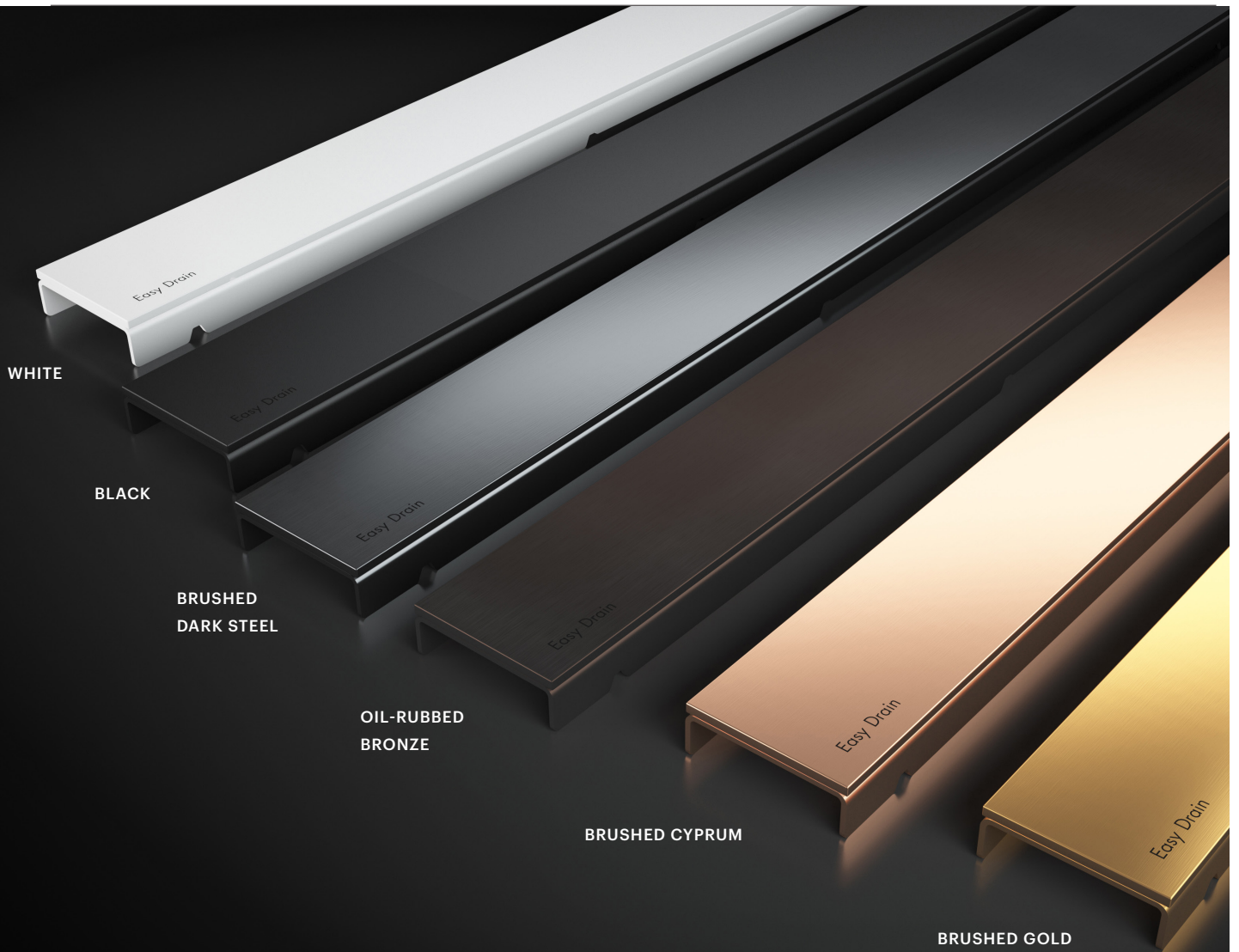

WHITE

BLACK

BRUSHED  
DARK STEEL

OIL-RUBBED  
BRONZE

BRUSHED CYPRUM

BRUSHED GOLD

# MODULO

ROUGH

## M4 | VERTICAL 2" OUTLET

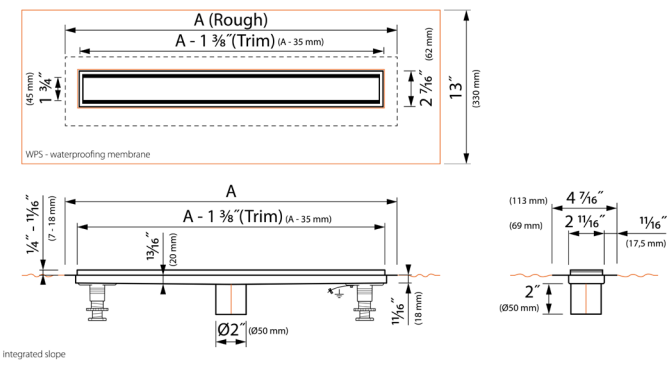

### FEATURES

- TAF Tile Adjustable Frame 1/4" - 3/4" (7-18 mm)
- WPS Pre-assembled membrane - 10-year warranty
- 🧽 Easy to clean
- 💧 High capacity
- INOX High-quality stainless steel
- 🏆 Certified: cUPC

### INSTALLATION

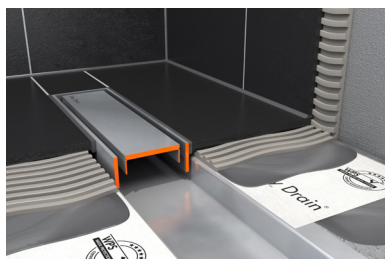

Modulo

### ACCESSORIES



**10**  
YEAR  
WARRANTY

Waterproofing: SAM - Seal System  
P. 47

# MODULO TAF

## ZERO / TILE | REVERSIBLE TRIM

**TAF**  
1/4" - 3/4" (7-18 mm)

**Tile inlay depth**  
1/2" (12 mm)

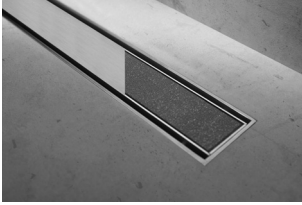

Tile not included  
See page 18 for rough.

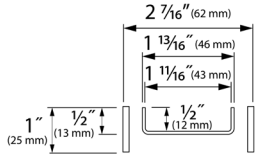

Tile

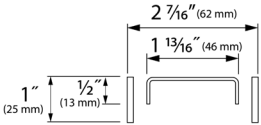

Zero

M4	Length	Trim		+ Rough		Total price
19 3/4"	500 mm	MLZT 500	\$ 281.19	EDM4-500	\$ 502.64	\$ 783.83
23 5/8"	600 mm	MLZT 600	\$ 302.82	EDM4-600	\$ 508.82	\$ 811.64
27 5/8"	700 mm	MLZT 700	\$ 319.30	EDM4-700	\$ 513.97	\$ 833.27
31 1/2"	800 mm	MLZT 800	\$ 335.78	EDM4-800	\$ 519.12	\$ 854.90
35 1/2"	900 mm	MLZT 900	\$ 346.08	EDM4-900	\$ 530.45	\$ 876.53
39 3/8"	1000 mm	MLZT 1000	\$ 351.23	EDM4-1000	\$ 540.75	\$ 891.98
43 3/8"	1100 mm	MLZT 1100	\$ 372.86	EDM4-1100	\$ 557.23	\$ 930.09
47 1/4"	1200 mm	MLZT 1200	\$ 384.19	EDM4-1200	\$ 567.53	\$ 951.72
51 1/8"	1300 mm	MLZT 1300	\$ 457.32	EDM4-1300	\$ 599.46	\$1,056.78
55 1/8"	1400 mm	MLZT 1400	\$ 496.46	EDM4-1400	\$ 631.39	\$1,127.85
59 1/8"	1500 mm	MLZT 1500	\$ 535.60	EDM4-1500	\$ 660.23	\$1,195.83
63	1600 mm	MLZT 1600	\$ 569.59	EDM4-1600	\$ 690.10	\$1,259.69
66 7/8"	1700 mm	MLZT 1700	\$ 606.67	EDM4-1700	\$ 705.55	\$1,312.22
70 7/8"	1800 mm	MLZT 1800	\$ 638.60	EDM4-1800	\$ 718.94	\$1,357.54
74 7/8"	1900 mm	MLZT 1900	\$ 670.53	EDM4-1900	\$ 744.69	\$1,415.22
78 3/4"	2000 mm	MLZT 2000	\$ 702.46	EDM4-2000	\$ 770.44	\$1,472.90

## ZERO BLACK / TILE | REVERSIBLE TRIM

**TAF**  
1/4" - 3/4" (7-18 mm)

**Tile inlay depth**  
1/2" (12 mm)

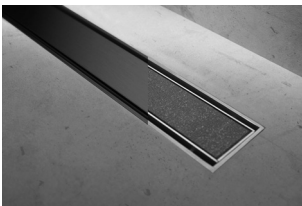

Tile not included  
See page 18 for rough.

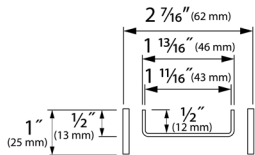

Tile

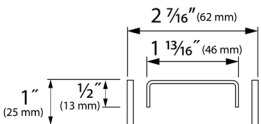

Zero

M4	Length	Trim		+ Rough		Total price
19 3/4"	500 mm	MLZT 500WB	\$ 551.67	EDM4-500	\$ 502.64	\$1,054.31
23 5/8"	600 mm	MLZT 600WB	\$ 579.99	EDM4-600	\$ 508.82	\$1,088.81
27 5/8"	700 mm	MLZT 700WB	\$ 603.17	EDM4-700	\$ 513.97	\$1,117.14
31 1/2"	800 mm	MLZT 800WB	\$ 626.34	EDM4-800	\$ 519.12	\$1,145.46
35 1/2"	900 mm	MLZT 900WB	\$ 642.00	EDM4-900	\$ 530.45	\$1,172.45
39 3/8"	1000 mm	MLZT 1000WB	\$ 653.84	EDM4-1000	\$ 540.75	\$1,194.59
43 3/8"	1100 mm	MLZT 1100WB	\$ 682.17	EDM4-1100	\$ 557.23	\$1,239.40
47 1/4"	1200 mm	MLZT 1200WB	\$ 700.19	EDM4-1200	\$ 567.53	\$1,267.72
51 1/8"	1300 mm	MLZT 1300WB	\$ 780.02	EDM4-1300	\$ 599.46	\$1,379.48
55 1/8"	1400 mm	MLZT 1400WB	\$ 825.85	EDM4-1400	\$ 631.39	\$1,457.24
59 1/8"	1500 mm	MLZT 1500WB	\$ 871.69	EDM4-1500	\$ 660.23	\$1,531.92
63	1600 mm	MLZT 1600WB	\$ 912.37	EDM4-1600	\$ 690.10	\$1,602.47
66 7/8"	1700 mm	MLZT 1700WB	\$ 956.15	EDM4-1700	\$ 705.55	\$1,661.70
70 7/8"	1800 mm	MLZT 1800WB	\$ 994.77	EDM4-1800	\$ 718.94	\$1,713.71
74 7/8"	1900 mm	MLZT 1900WB	\$1,033.40	EDM4-1900	\$ 744.69	\$1,778.09
78 3/4"	2000 mm	MLZT 2000WB	\$1,073.36	EDM4-2000	\$ 770.44	\$1,843.80

# MODULO TAF WALL

*Elegant stainless steel frame*



## FEATURES

- TAF** Tile Adjustable Frame 1/4" - 3/4" (7-18 mm)
- WPS** Pre-assembled membrane - 10-year warranty
- Easy to clean**
- High capacity**
- INOX** High-quality stainless steel
- Certified: cUPC**

## INSTALLATION

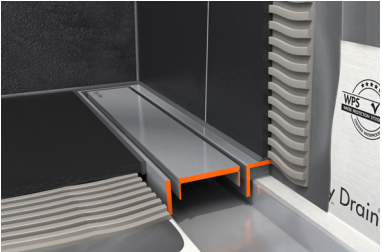

Modulo TAF Wall

## ACCESSORIES



**10 YEAR WARRANTY**

Waterproofing: SAM - Seal System  
P. 47

# MODULO TAF WALL

## ZERO / TILE | REVERSIBLE TRIM

**TAF**  
1/4" - 3/4" (7-18 mm)

**Tile inlay depth**  
1/2" (12 mm)



Tile not included

See page 18 for rough.

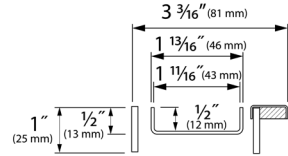

Tile

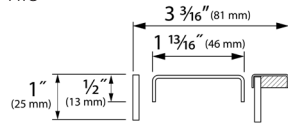

Zero

M4	Length	Trim		+ Rough		Total price
19 3/4"	500 mm	MLWZT 500	\$ 281.19	EDM4-500	\$ 502.64	\$ 783.83
23 5/8"	600 mm	MLWZT 600	\$ 302.82	EDM4-600	\$ 508.82	\$ 811.64
27 5/8"	700 mm	MLWZT 700	\$ 319.30	EDM4-700	\$ 513.97	\$ 833.27
31 1/2"	800 mm	MLWZT 800	\$ 335.78	EDM4-800	\$ 519.12	\$ 854.90
35 1/2"	900 mm	MLWZT 900	\$ 346.08	EDM4-900	\$ 530.45	\$ 876.53
39 3/8"	1000 mm	MLWZT 1000	\$ 351.23	EDM4-1000	\$ 540.75	\$ 891.98
43 3/8"	1100 mm	MLWZT 1100	\$ 372.86	EDM4-1100	\$ 557.23	\$ 930.09
47 1/4"	1200 mm	MLWZT 1200	\$ 384.19	EDM4-1200	\$ 567.53	\$ 951.72
51 1/8"	1300 mm	MLWZT 1300	\$ 457.32	EDM4-1300	\$ 599.46	\$1,056.78
55 1/8"	1400 mm	MLWZT 1400	\$ 496.46	EDM4-1400	\$ 631.39	\$1,127.85
59 1/8"	1500 mm	MLWZT 1500	\$ 535.60	EDM4-1500	\$ 660.23	\$1,195.83
63	1600 mm	MLWZT 1600	\$ 569.59	EDM4-1600	\$ 690.10	\$1,259.69
66 7/8"	1700 mm	MLWZT 1700	\$ 606.67	EDM4-1700	\$ 705.55	\$1,312.22
70 7/8"	1800 mm	MLWZT 1800	\$ 638.60	EDM4-1800	\$ 718.94	\$1,357.54
74 7/8"	1900 mm	MLWZT 1900	\$ 670.53	EDM4-1900	\$ 744.69	\$1,415.22
78 3/4"	2000 mm	MLWZT 2000	\$ 702.46	EDM4-2000	\$ 770.44	\$1,472.90

# MODULO STONE

*For any type of natural stone*

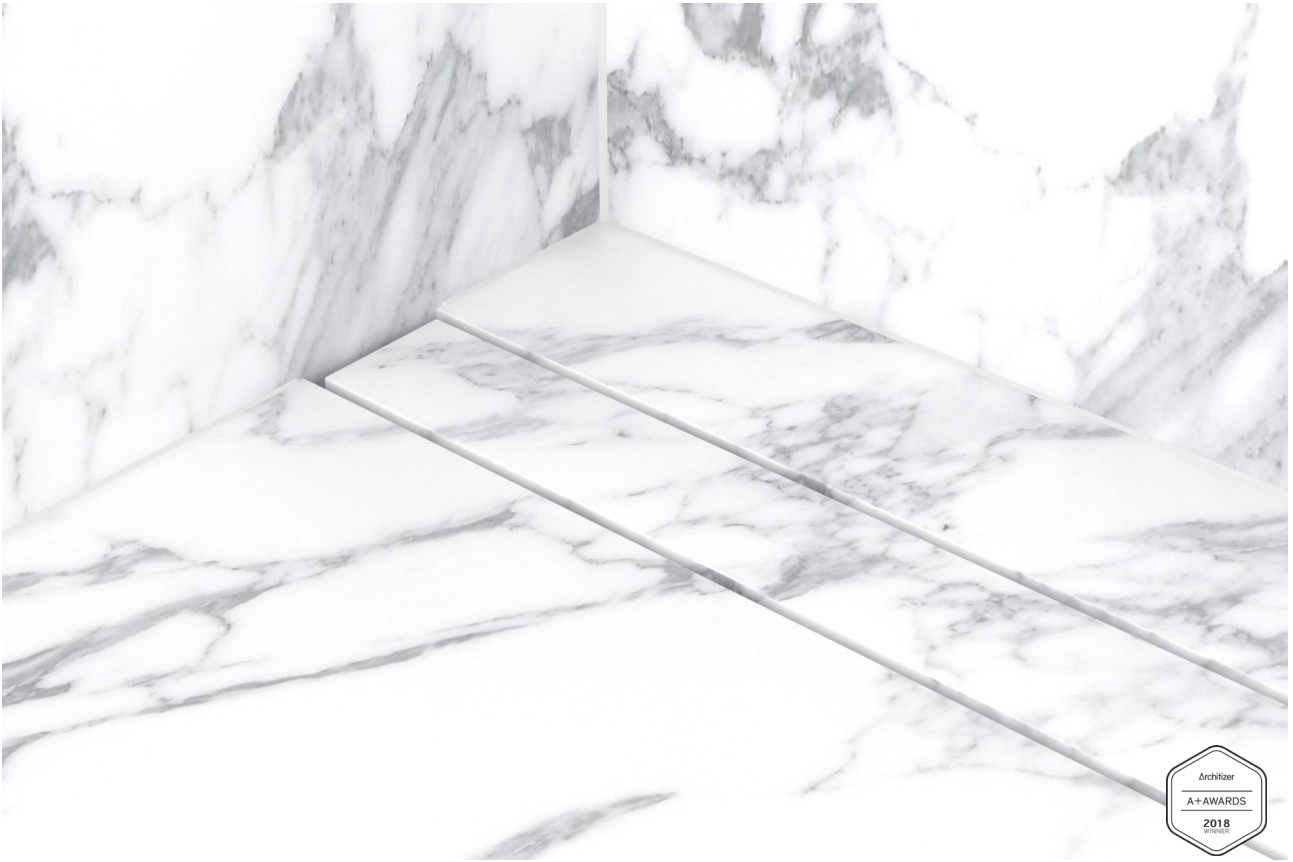

## FEATURES

- ✓

Frameless design
- ✓

Can be adjusted in size (Stone Flex)
- ✓

Suitable for any thickness of natural stone, color-body tile and marble
- WPS

Pre-assembled membrane - 10-year warranty
- INOX

High-quality stainless steel

## INSTALLATION



Modulo Stone



## ACCESSORIES



**10**  
YEAR  
WARRANTY

Waterproofing: SAM - Seal System  
P. 47

# MODULO STONE

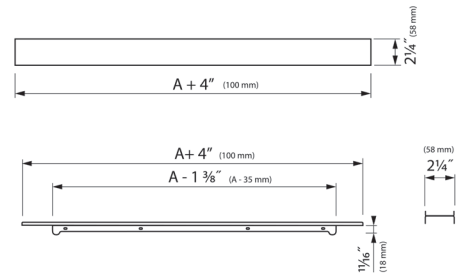

## MODULO STONE FLEX

**Tile thickness**  
0 - 1 1/8" (0-30 mm)

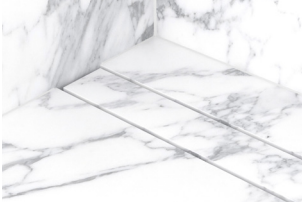

Tile not included  
See page 18 for rough.

M4	Adjustable length	Trim		+ Rough	Total price
19 3/4" - 23 3/4"	500 - 600 mm	MB-NAT-500-FL	\$ 226.83	EDM4-500 \$ 502.64	\$ 729.47
23 5/8" - 27 5/8"	600 - 700 mm	MB-NAT-600-FL	\$ 234.33	EDM4-600 \$ 508.82	\$ 743.15
27 5/8" - 31 1/2"	700 - 800 mm	MB-NAT-700-FL	\$ 245.57	EDM4-700 \$ 513.97	\$ 759.54
31 1/2" - 35 1/2"	800 - 900 mm	MB-NAT-800-FL	\$ 277.44	EDM4-800 \$ 519.12	\$ 796.56
35 1/2" - 39 3/8"	900 - 100 mm	MB-NAT-900-FL	\$ 283.06	EDM4-900 \$ 530.45	\$ 813.51
39 3/8" - 43 3/8"	1000 - 1100 mm	MB-NAT-1000-FL	\$ 294.31	EDM4-1000 \$ 540.75	\$ 835.06
43 3/8" - 47 1/4"	1100 - 1200 mm	MB-NAT-1100-FL	\$ 337.43	EDM4-1100 \$ 557.23	\$ 894.66
47 1/4" - 51 1/8"	1200 - 1300 mm	MB-NAT-1200-FL	\$ 337.43	EDM4-1200 \$ 567.53	\$ 904.96
51 1/8" - 55 1/8"	1300 - 1400 mm	MB-NAT-1300-FL	\$ 361.80	EDM4-1300 \$ 599.46	\$ 961.26
55 1/8" - 59 1/8"	1400 - 1500 mm	MB-NAT-1400-FL	\$ 376.79	EDM4-1400 \$ 631.39	\$1,008.18
59 1/8" - 63	1500 - 1600 mm	MB-NAT-1500-FL	\$ 391.79	EDM4-1500 \$ 660.23	\$1,052.02
63 - 66 7/8"	1600 - 1700 mm	MB-NAT-1600-FL	\$ 404.91	EDM4-1600 \$ 690.10	\$1,095.01
66 7/8" - 70 7/8"	1700 - 1800 mm	MB-NAT-1700-FL	\$ 419.91	EDM4-1700 \$ 705.55	\$1,125.46
70 7/8" - 74 7/8"	1800 - 1900 mm	MB-NAT-1800-FL	\$ 438.66	EDM4-1800 \$ 718.94	\$1,157.60
74 7/8" - 78 3/4"	1900 - 2000 mm	MB-NAT-1900-FL	\$ 453.65	EDM4-1900 \$ 744.69	\$1,198.34
78 3/4" - 82 3/4"	2000 - 2100 mm	MB-NAT-2000-FL	\$ 472.40	EDM4-2000 \$ 770.44	\$1,242.84

## MODULO STONE

**Tile thickness**  
0 - 1 1/8" (0-30 mm)

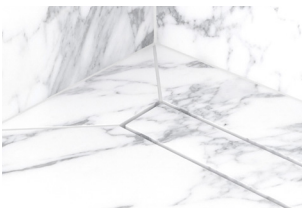

Tile not included  
See page 18 for rough.

M4	Length	Trim	Price
19 3/4"	500 mm	MB-NAT-500	\$ 221.45
23 5/8"	600 mm	MB-NAT-600	\$ 236.90
27 5/8"	700 mm	MB-NAT-700	\$ 250.29
31 1/2"	800 mm	MB-NAT-800	\$ 263.68
35 1/2"	900 mm	MB-NAT-900	\$ 275.01
39 3/8"	1000 mm	MB-NAT-1000	\$ 281.19
43 3/8"	1100 mm	MB-NAT-1100	\$ 296.64
47 1/4"	1200 mm	MB-NAT-1200	\$ 310.03
59 1/8"	1500 mm	MB-NAT-1500	\$ 373.77

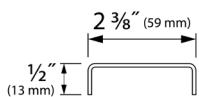

# M-LINE

COMPLETE SET

*Hidden and sleek wall drainage*

## M4 | VERTICAL 2" OUTLET

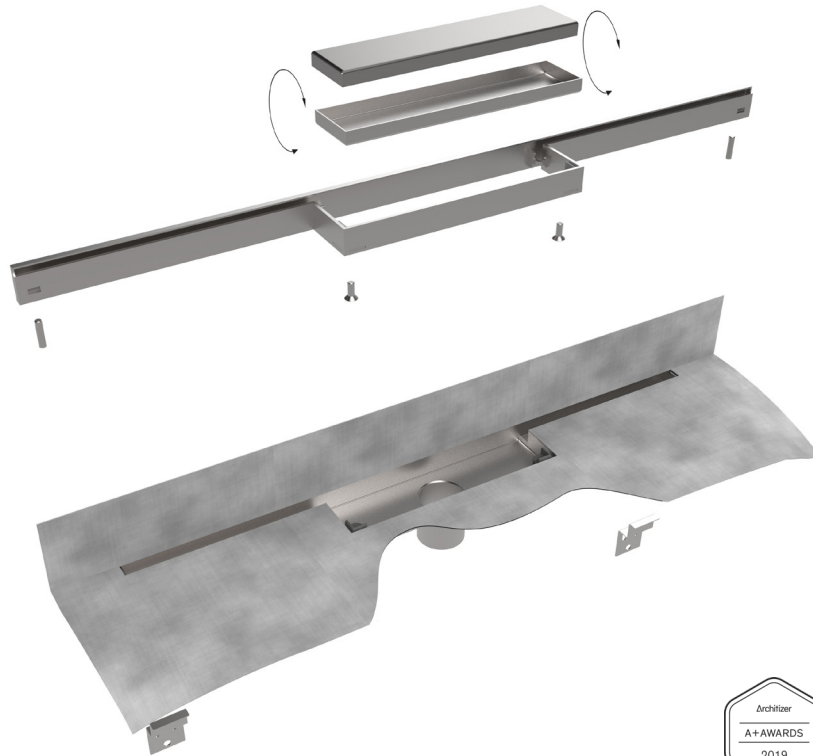

### FEATURES

- TAF

Tile Adjustable Frame 1/4" - 3/4" (7-18 mm)
- WPS

Pre-assembled membrane - 10-year warranty
- E

Easy to clean
- H

High capacity
- I

High-quality stainless steel
- C

Certified: cUPC

### INSTALLATION



M-Line

### ACCESSORIES



**10**  
YEAR  
WARRANTY

Waterproofing: SAM - Seal System  
P. 47

## M-LINE | ZERO / TILE REVERSIBLE



**TAF**

1/4" - 3/4" (7 - 18 mm)



**Tile inlay depth**

1/2" (12 mm)



Tile not included

	Length	Article code	Price
27	5/8" 700 mm	M-Line4-700	\$1,084.59
31	1/2" 800 mm	M-Line4-800	\$1,111.37
35	1/2" 900 mm	M-Line4-900	\$1,149.48
39	3/8" 1000 mm	M-Line4-1000	\$1,209.22
47	1/4" 1200 mm	M-Line4-1200	\$1,295.74

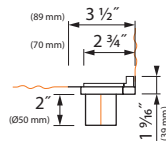
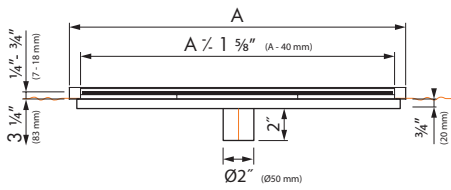
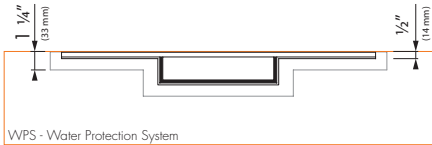

# S-LINE

COMPLETE SET

*Invisible and stylish*

## M4 | VERTICAL 2" OUTLET

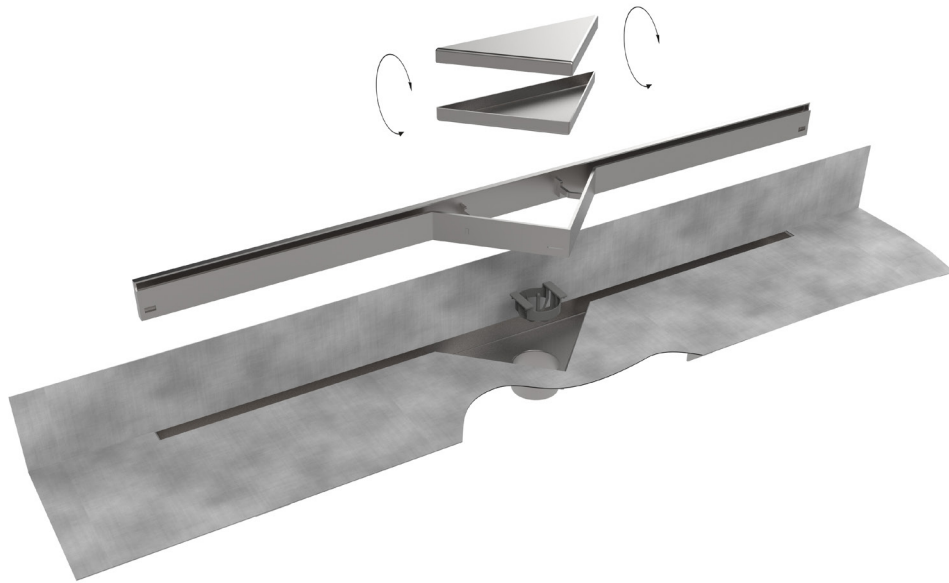

### FEATURES

- TAF

Tile Adjustable Frame 1/4" - 3/4"
- WPS

Pre-assembled membrane - 10-year warranty
- Easy to clean
- High capacity
- INOX

High-quality stainless steel
- Certified: cUPC

### INSTALLATION

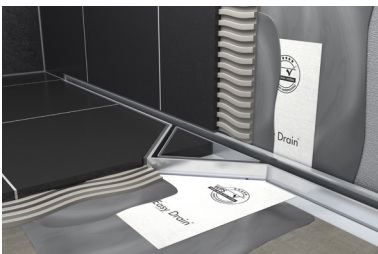

S-Line

### ACCESSORIES



**10**  
YEAR  
WARRANTY

Waterproofing: SAM - Seal System  
P. 47



Small, smaller... Xs

M4 | VERTICAL 2" OUTLET

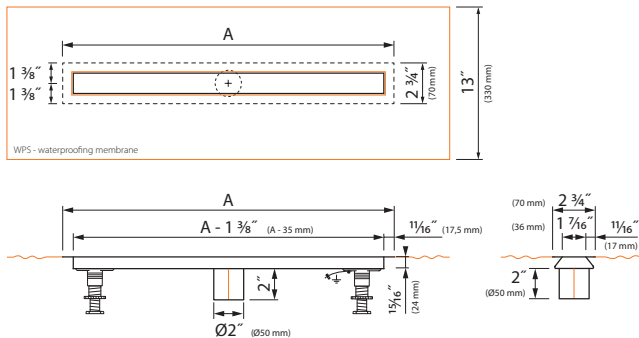

FEATURES

- TAF** Tile Adjustable Frame 1/4" - 1" (5-25 mm)
- WPS** Pre-assembled membrane - 10-year warranty
- Easy to clean**

- High capacity**
- INOX** High-quality stainless steel
- Certified: cUPC**

INSTALLATION

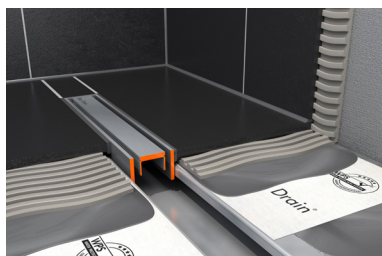

Xs

ACCESSORIES



**10 YEAR WARRANTY**

Waterproofing: SAM - Seal System  
 P. 47

# XS Z-1

## XS Z-1 ZERO+ | BRUSHED STAINLESS STEEL | FRAME BRUSHED STAINLESS STEEL

**TAF**  
1/4" - 1" (5-25 mm)



M4	Length	Trim		+ Rough		Total price
19 3/4"	500 mm	XS-Z1M-M-500	\$ 475.86	XS4-ROH-500	\$ 578.86	\$ 1,054.72
23 5/8"	600 mm	XS-Z1M-M-600	\$ 481.01	XS4-ROH-600	\$ 584.01	\$ 1,065.02
27 5/8"	700 mm	XS-Z1M-M-700	\$ 492.34	XS4-ROH-700	\$ 600.49	\$ 1,092.83
31 1/2"	800 mm	XS-Z1M-M-800	\$ 513.97	XS4-ROH-800	\$ 622.12	\$ 1,136.09
35 1/2"	900 mm	XS-Z1M-M-900	\$ 530.45	XS4-ROH-900	\$ 632.42	\$ 1,162.87
39 3/8"	1000 mm	XS-Z1M-M-1000	\$ 540.75	XS4-ROH-1000	\$ 660.23	\$ 1,200.98
43 3/8"	1100 mm	XS-Z1M-M-1100	\$ 552.08	XS4-ROH-1100	\$ 675.68	\$ 1,227.76
47 1/4"	1200 mm	XS-Z1M-M-1200	\$ 578.86	XS4-ROH-1200	\$ 681.86	\$ 1,260.72

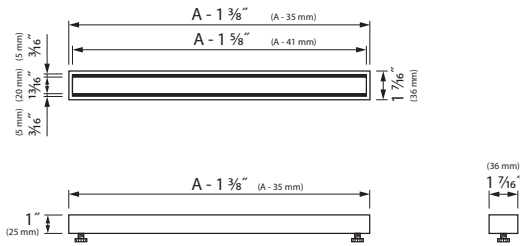

*The solution for vinyl flooring*

## M4 | VERTICAL 2" OUTLET



### FEATURES

- ✓
Vinyl can easily be clamped to the drain
- ✓
Suitable for new construction and renovation projects
- 🧽
Easy to clean
- 💧
High capacity
- INOX
High-quality stainless steel
- 🏆
Certified: cUPC

### INSTALLATION

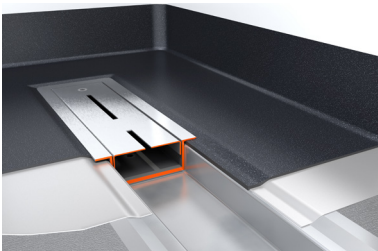

Vinyl

### ACCESSORIES



**10**  
YEAR  
WARRANTY

Waterproofing: SAM - Seal System  
P. 47

VINYL | BRUSHED STAINLESS STEEL



	Length	Article code	Price
27	5/8" 700 mm	EDVIN-M4-700	\$ 835.00
31	1/2" 800 mm	EDVIN-M4-800	\$ 868.00
35	1/2" 900 mm	EDVIN-M4-900	\$ 899.00
39	3/8" 1000 mm	EDVIN-M4-1000	\$ 937.00
47	1/4" 1200 mm	EDVIN-M4-1200	\$ 984.00

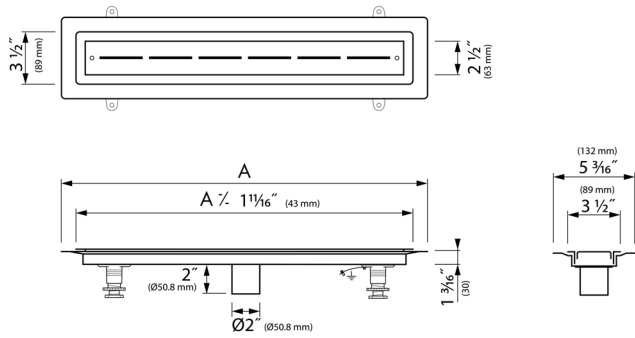

# AQUA JEWELS

COMPLETE SET

*A jewel in your bathroom*

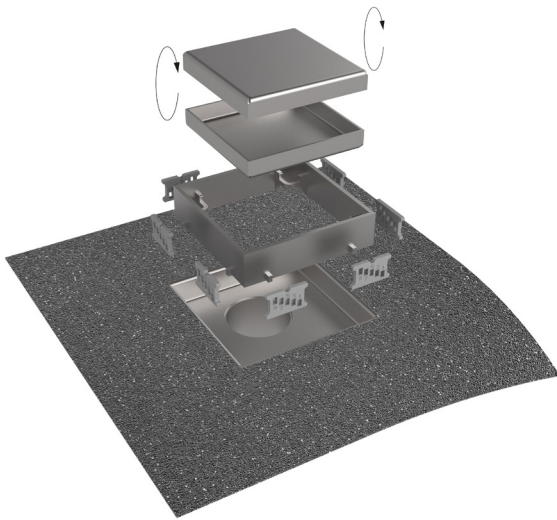

Aqua Jewels Quattro

## FEATURES

- TAF

Tile Adjustable Frame 3/4" - 5/8" (5 - 16 mm)
- WPS

Pre-assembled membrane - 10-year warranty
- ✓

Suitable for new construction and renovation projects
- ✓

Haircatcher included
- ✓

Certified: cUPC

## INSTALLATION



Aqua Jewels Quattro

## ACCESSORIES



**10**  
YEAR  
WARRANTY

Waterproofing: SAM - Seal System  
P. 47

## AQUA JEWELS QUATTRO | ZERO+ STAINLESS STEEL

**TAF**  
3/4" - 5/8" (5 - 16 mm)

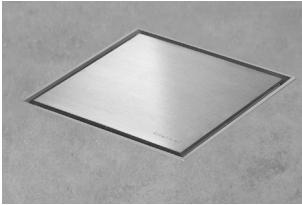

	Length	Article code	Price
4' x 4'	100 x 100 mm	AJQ4-10X10-ZM	\$ 487.19
6' x 6'	150 x 150 mm	AJQ4-15X15-ZM	\$ 519.12
8' x 8'	200 x 200 mm	AJQ4-20X20-ZM	\$ 540.75

## AQUA JEWELS QUATTRO | TILE

**TAF**  
3/4" - 5/8" (5 - 16 mm)

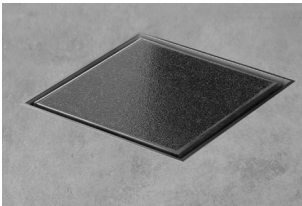

Tile not included

	Length	Article code	Price
4' x 4'	100 x 100 mm	AJQ4-10X10-T	\$ 416.12
6' x 6'	150 x 150 mm	AJQ4-15X15-T	\$ 443.93
8' x 8'	200 x 200 mm	AJQ4-20X20-T	\$ 459.38

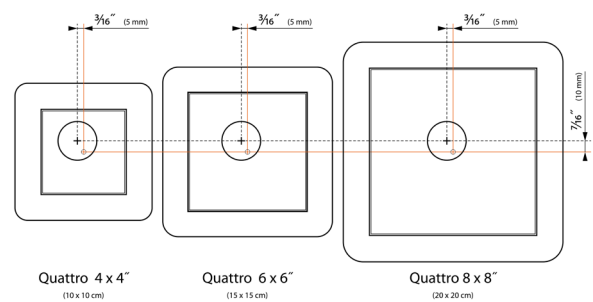
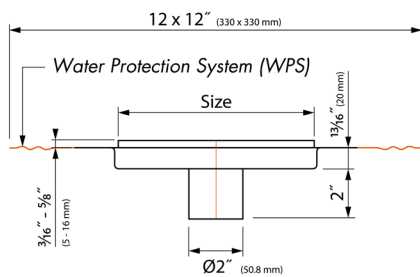

# AQUA JEWELS STONE

COMPLETE SET

## AQUA JEWELS STONE | NATURAL STONE

**T** **Tile thickness**  
0 - 1 1/8" (0-30 mm)



Tile not included

	Length	Article code	Price
4' x 4'	100 x 100 mm	AJQ4-10X10-S	\$ 374.92
6' x 6'	150 x 150 mm	AJQ4-15X15-S	\$ 399.64
8' x 8'	200 x 200 mm	AJQ4-20X20-S	\$ 414.06

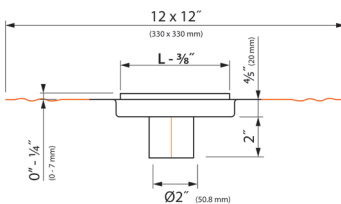
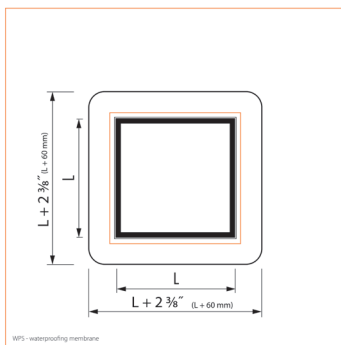

## ACCESSORIES



**10**  
**YEAR**  
**WARRANTY**

Waterproofing: SAM - Seal System  
P. 47

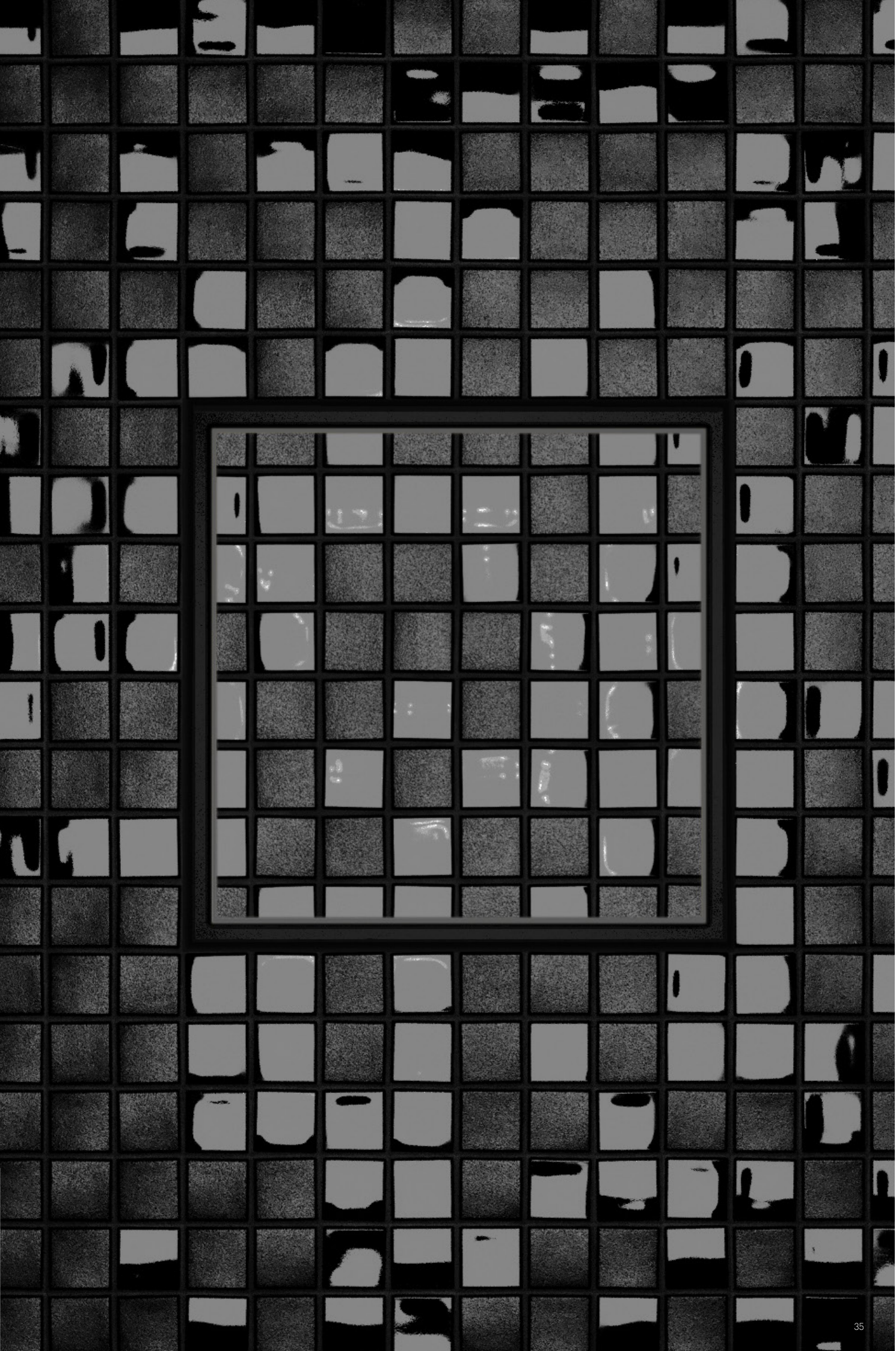

# ACCESSORIES

## MODULO TAF

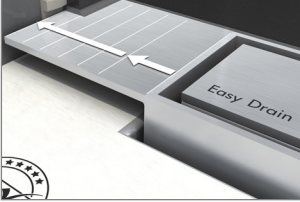

	Article code	Price
STD	MTAF-VER-STD	\$ 84.00
20	MTAF-VER-20	\$ 84.00
40	MTAF-VER-40	\$ 84.00
60	MTAF-VER-60	\$ 84.00
80	MTAF-VER-80	\$ 84.00
100	MTAF-VER-100	\$ 84.00

## MODULO TAF WALL

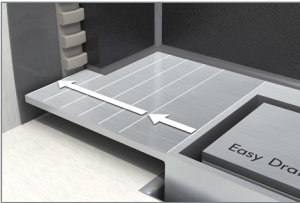

	Article code	Price
STD	MTAFW-VER-STD	\$ 84.00
20	MTAFW-VER-20	\$ 84.00
40	MTAFW-VER-40	\$ 84.00
60	MTAFW-VER-60	\$ 84.00
80	MTAFW-VER-80	\$ 84.00
100	MTAFW-VER-100	\$ 84.00

## EXTENSION SETS

For Modulo TAF or TAF Wall

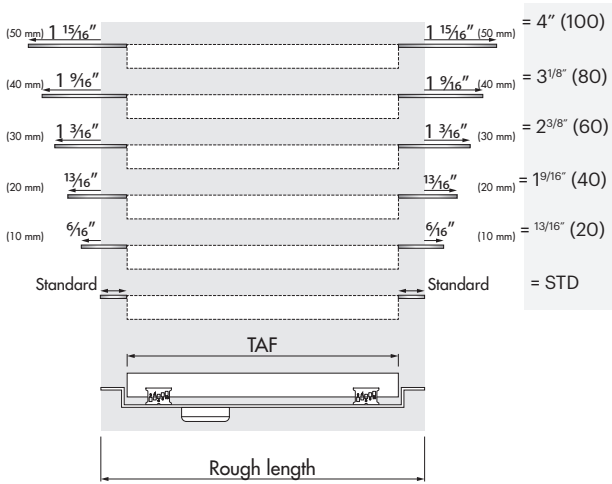



# SAM (SELF-ADHESIVE WATERPROOFING MEMBRANE)

SAM is a self-adhesive membrane system, which creates easy and secure waterproofing. With this seal set, we guarantee 100% watertightness of the entire shower or bathroom area, and a certificate is included with all standard packages. SAM is certified in accordance with c-UPC, ETAG 022, ab (P) and ANSI 18110.

The SAM system is based on elastic foam technology, and the self-adhesive membrane can be applied directly to wall and floor surfaces without using any additional liquid material. The top side is coated with an anti-bacterial film, and offers an ideal base surface for every type of tile adhesive.

The patented SAM system avoids moisture damage by using fleece-free impact bonding. The non-woven zones interrupt the capillary movement of moisture and ensure 100% watertightness.

You should always prepare the walls and floors with a primer before installing the self-adhesive membrane. The walls and floors must be solid, dry and dust free.

SAM offers two options to waterproof: only the wet area, or the complete bathroom. The sets are suitable for most situations, and can be combined.

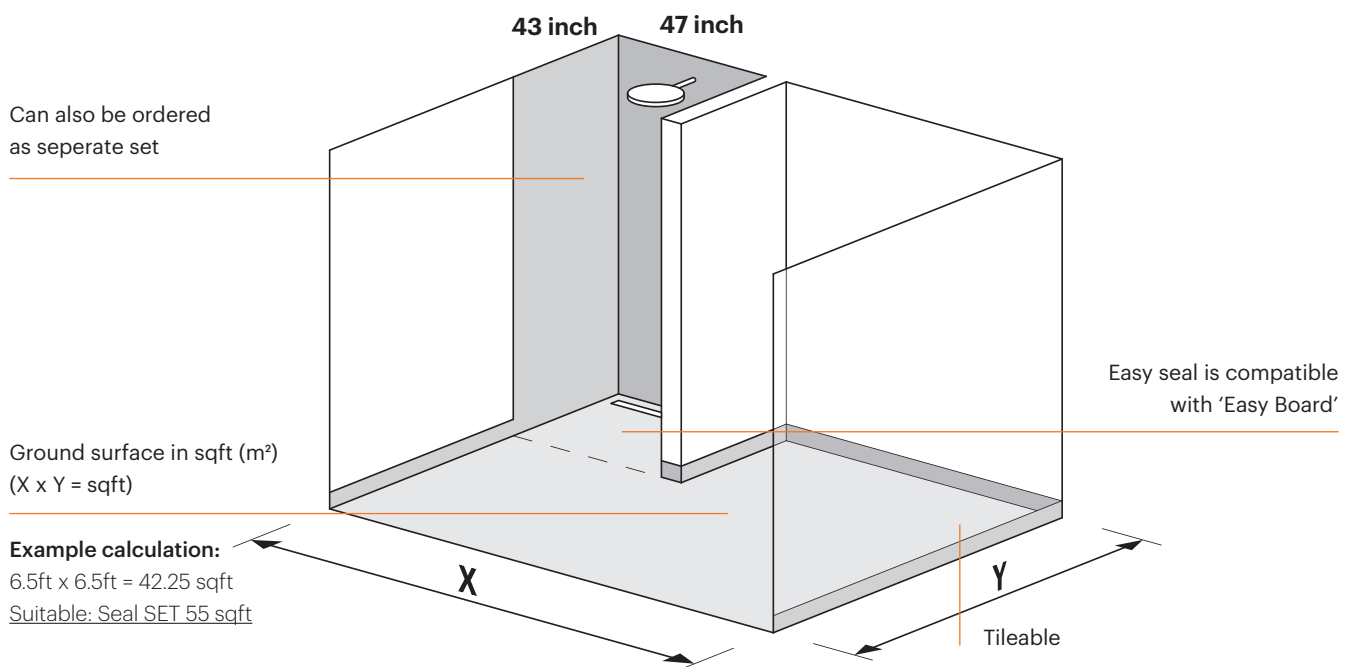

## SAM SETS for bathroom:

- 55 sqft max
- 80 sqft max
- 105 sqft max

SAM SETS for shower area are max. 43" x 47".

SAM SETS for bathroom include sufficient material to waterproof the entire bathroom and the shower area with U-Shape.

# EASY SEAL SETS | FOR BATHROOM

## SEAL SET SAM - FW 55 SQFT (5 M<sup>2</sup>)

Compatible with Easy Boards, see 'Easy Board'. SET contains material sufficient for 188 sqft total surface (floor, walls etc.) Wet area with U-shape (niche) is included.

### Content:

- > 6 x Inside corner self-adhesive
- > 1 x Outside corner self-adhesive
- > 3 x SEAL Wall sleeve self-adhesive 1/2"
- > 1 x SEAL Corner tape self-adhesive 65ft x 4" (20 m1 x 10 cm)
- > 1 x SEAL Finishing tape self-adhesive 32ft x 4" (10 m1 x 10 cm)
- > 1 x SEAL Finishing tape self-adhesive 32ft x 11<sup>13/16</sup>" (10 m1 x 30 cm)
- > 1 x SEAL Seal membrane self-adhesive, incl. processing aid 98ft x 19<sup>3/4</sup>" (30 m1 x 50 cm)
- > 2 x Test sample
- > 1 x Sleeve DN 100
- > 1 x Certificate

Complete set	Article code	Price	Price sqft
188 sqft	SEAL-BOX-5	\$1,583.40	\$ 8.40

- \* Tileable surface
- \* The price per foot is for estimation purpose only.
- \* Please use complete price for orders.

## SEAL SET SAM - FW 80 SQFT (7,5 M<sup>2</sup>)

Compatible with Easy Boards, see 'Easy Board'. SET contains material sufficient for 204 sqft total surface (floor, walls etc.) Wet area with U-shape (niche) is included.

### Content:

- > 6 x Inside corner self-adhesive
- > 1 x Outside corner self-adhesive
- > 3 x SEAL Wall sleeve self-adhesive 1/2"
- > 1 x SEAL Corner tape self-adhesive 65ft x 4" (20 m1 x 10 cm)
- > 1 x SEAL Finishing tape self-adhesive 32ft x 4" (10 m1 x 10 cm)
- > 1 x SEAL Finishing tape self-adhesive 32ft x 11<sup>13/16</sup>" (10 m1 x 30 cm)
- > 1 x SEAL Seal membrane self-adhesive, incl. processing aid 98ft x 19<sup>3/4</sup>" (30 m1 x 50 cm)
- > 1 x Test sample
- > 1 x Sleeve DN 100
- > 1 x Certificate

Complete set	Article code	Price	Price sqft
204 sqft	SEAL-BOX-7	\$1,683.50	\$ 8.23

- \* Tileable surface
- \* The price per foot is for estimation purpose only.
- \* Please use complete price for orders.

## SEAL SET SAM - FW 105 SQFT (10 M<sup>2</sup>)

Compatible with Easy Boards, see 'Easy Board'. SET contains material sufficient for 247 sqft total surface (floor, walls, etc.) Wet area with U-shape (niche) is included.

### Content:

- > 6 x Inside corner self-adhesive
- > 1 x Outside corner self-adhesive
- > 3 x SEAL Wall sleeve self-adhesive 1/2"
- > 1 x SEAL Corner tape self-adhesive 65ft x 4" (20 m1 x 10 cm)
- > 1 x SEAL Finishing tape self-adhesive 32ft x 4" (10 m1 x 10 cm)
- > 1 x SEAL Finishing tape self-adhesive 32ft x 11<sup>13/16</sup>" (10 m1 x 30 cm)
- > 1 x SEAL Seal membrane self-adhesive, incl. processing aid 98ft x 19<sup>3/4</sup>" (30 m1 x 50 cm)
- > 2 x Test sample
- > 1 x Sleeve DN 100
- > 1 x Certificate

Complete set	Article code	Price	Price sqft
247 sqft	SEAL-BOX-10	\$2,002.00	\$ 8.08

- \* Tileable surface
- \* The price per foot is for estimation purpose only.
- \* Please use complete price for orders.

# EASY SEAL SETS | FOR BATHROOM

## SEAL SET SAM - L | SELF-ADHESIVE FOR SHOWER AREA WITH L - SHAPE



43" x 47" (max. 110 x 120 cm)

Compatible with ESS Easy Boards, see 'Easy Board'. The SET contains material sufficient for 80 sqft total surface (floor, walls etc.)

**Content:**

- > 1 x SEAL Corner tape self-adhesive 32ft (10 m)
- > 1 x SEAL Sealing membrane self-adhesive, incl. processing aid 32ft x 19<sup>11/16"</sup> (10 m1 x 50 cm)
- > 3 x Wall sleeve self-adhesive 1/2"
- > 1 x SEAL Finishing tape self-adhesive 32ft x 12" (10 m1 x 30 cm)
- > 2 x Test sample
- > 1 x Certificate
- > 2 x Inside corner self-adhesive

Complete set	Article code	Price	Price sqft
80 sqft	SEAL-BOX-L	\$ 637.00	\$ 7.96

\* Tileable surface  
 \* The price per foot is for estimation purpose only.  
 \* Please use complete price for orders.

## SEAL SET SAM - U | SELF-ADHESIVE FOR SHOWER AREA WITH U - SHAPE



43" x 47" (max. 110 x 120 cm)

Compatible with ESS Easy Boards, see 'Easy Board'. The SET contains material sufficient for 105 sqft total surface (floor, walls etc.)

**Content:**

- > 1 x SEAL Corner tape self-adhesive 49ft (15 m)
- > 1 x SEAL Sealing membrane self-adhesive, incl. processing aid 49 sqft (15 m1 x 50 cm)
- > 3 x SEAL Wall sleeve self-adhesive 1/2"
- > 1 x SEAL Finishing tape self-adhesive 32ft x 12" (10 m1 x 30 cm)
- > 2 x Test sample
- > 1 x Certificate
- > 2 x Inside corner self-adhesive

Complete set	Article code	Price	Price sqft
105 sqft	SEAL-BOX-U	\$ 837.20	\$ 7.97

\* Tileable surface  
 \* The price per foot is for estimation purpose only.  
 \* Please use complete price for orders.

# SELF-ADHESIVE MEMBRANE

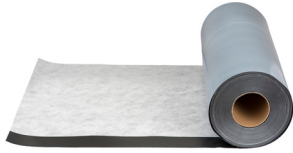

## SEAL SELF-ADHESIVE WATERPROOFING MEMBRANE

Article code	Article description	Price / roll	Price / sqft
SEAL-PARTS-1	SEAL self-adhesive waterproofing membrane, L= 98 ft, W= 191 1/16" (L=30m, W=50 cm), incl. installation tool	\$ 693.00	\$ 4.29
SEAL-PARTS-2	SEAL self-adhesive waterproofing membrane, L= 65 ft, W= 191 1/16" (L=20m, W=50 cm) incl. installation tool	\$ 491.00	\$ 4.57
SEAL-PARTS-3	SEAL self-adhesive waterproofing membrane, L= 49 ft, W= 191 1/16" (L=15m, W=50 cm), incl. installation tool	\$ 374.00	\$ 4.64
SEAL-PARTS-4	SEAL self-adhesive waterproofing membrane, L= 32 ft, W= 191 1/16" (L=10m, W=50 cm), incl. installation tool	\$ 270.00	\$ 5.02

\* The price per foot is for estimation purpose only.

\* Please use complete price for orders.



## SEAL FINISHING TAPE SELF-ADHESIVE

Article code	Article description	Price / roll	Price / sqft
SEAL-PARTS-5	SEAL Finishing tape, L= 98ft, W= 4" (L=30m, B=10 cm)	\$ 260.00	\$ 2.65
SEAL-PARTS-6	SEAL Finishing tape, L= 65ft, W= 4" (L=20m, B=10 cm)	\$ 137.00	\$ 2.10
SEAL-PARTS-7	SEAL Finishing tape, L= 32ft, W= 4" (L=10m, B=10cm)	\$ 111.00	\$ 3.43

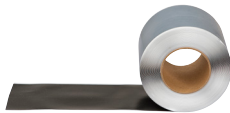

## SEAL CORNERS TAPE SELF-ADHESIVE

Article code	Article description	Price / roll	Price / sqft
SEAL-PARTS-8	SEAL Corner tape, L=98ft, W= 4" (L=30m, B=10 cm)	\$ 250.00	\$ 2.55
SEAL-PARTS-9	SEAL Corner tape, L=65ft, W= 4" (L=20m, B=10 cm)	\$ 176.00	\$ 2.70
SEAL-PARTS-10	SEAL Corner tape, L=32ft, W= 4" (L=10m, B=10 cm)	\$ 100.00	\$ 3.12
SEAL-PARTS-11	SEAL Corner tape, L=16ft, W= 4" (L=5m, B=10 cm)	\$ 55.00	\$ 3.43

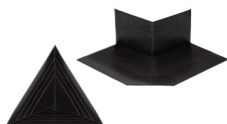

## SEAL CORNERS

Article code	Article description	Price
SEAL-PARTS-12	SEAL Inside corner	\$ 22.75 / Piece.
SEAL-PARTS-13	SEAL Outside corner	\$ 22.75 / Piece.

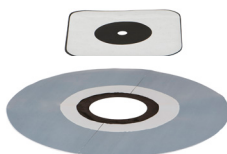

## SEAL WALL SLEEVE

Article code	Article description	Price
SEAL-PARTS-14	SEAL Wall sleeve 1/2"	\$ 16.90 / Piece.
SEAL-PARTS-15	SEAL Wall sleeve DN 50	\$ 23.40 / Piece.
SEAL-PARTS-16	SEAL Wall sleeve DN 100	\$ 29.90 / Piece.

# Container<sup>®</sup>

by ess

## WALL NICHES

With our Container Series storage solutions, you can conveniently store all your bathroom and toilet items. The series has been specifically developed for use in wet areas and offers a 100% watertight installation. Because of its perfect and sleek design, Container Series products will fit harmoniously into any bathroom.

Our storage solutions are available in various dimensions and color finishes. Installation is easy thanks to the built-in part for wall fixing. All the products are suitable for recessed mounting in drywall and offer uncomplicated sealing and tiling. Find out what our Container Series can do for your bathroom.



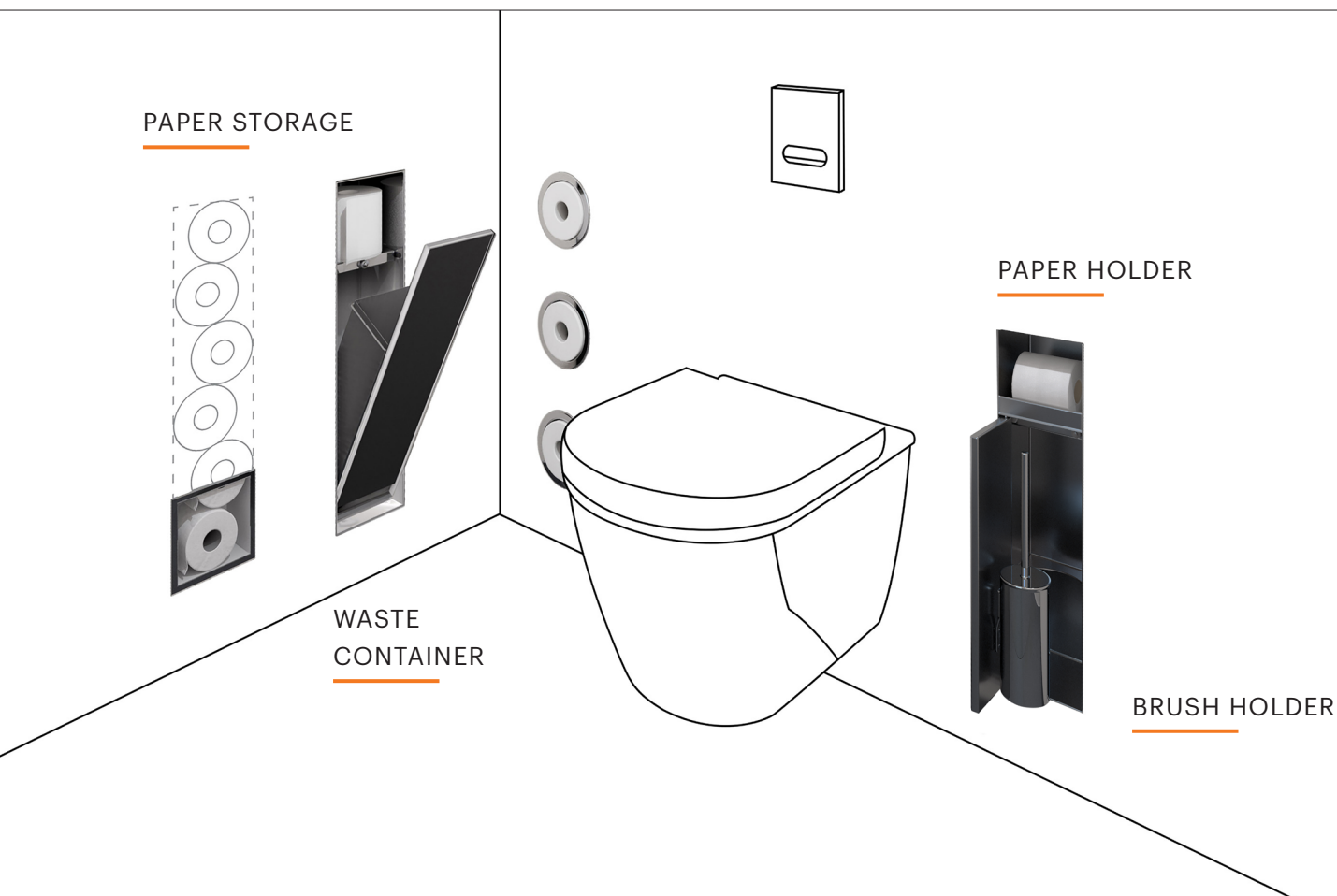

PAPER STORAGE

PAPER HOLDER

WASTE  
CONTAINER

BRUSH HOLDER

## BATHROOM & TOILET ACCESSORIES

- > Toilet brush holder, paper holder, toilet paper storage and waste container
- > Time-saving installation - Uncomplicated sealing and tiling
- > Designed for in the shower / wet area
- > Recessed mounting in drywall
- > High-quality stainless steel: scratch resistant & easy to clean



Incl. built-in element & waterproofing installation kit

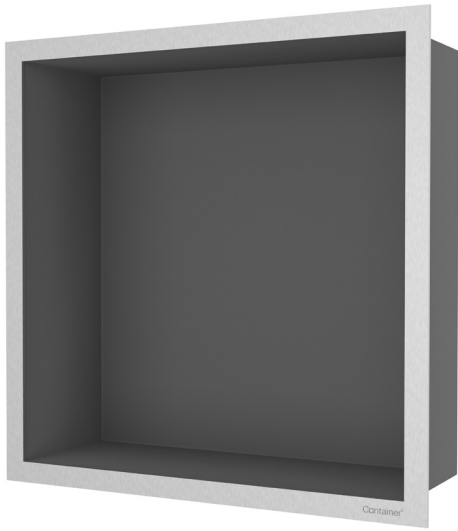

## WITH FRAME

---

Design wall niches with door and mirror

- > Options - mirror and door
- > Dimensions - 6" x 12" up to 48" x 12" (15 x 30 to 120 x 30 cm)
- > Installation depth - 4" (10 cm)



## FRAMELESS

---

Elegant wall niches with variable installation depth

- > Material stainless steel or solid surface
- > Dimensions - 6" x 12", 12" x 12" and 24" x 12" (15 x 30, 30 x 30 and 60 x 30 cm)
- > Variable installation depth



## TILEABLE

---

Invisible niches with push-to-open door

- > Tileable door - every material possible
- > Dimensions - 6" x 12" and 12" x 12" (15 x 30 and 30 x 30 cm)
- > Installation depth - 4" x 5 1/2" (10 and 14 cm)



BOX\*



TCL-4



TCL-7



\*Incl. built-in element & waterproofing installation kit

FINISH



C-BOX



TCL-14



Incl. built-in element & waterproofing installation kit

FINISH



T-BOX



TCL-12



TCL-9



Incl. built-in element & waterproofing installation kit

FINISH



# T-BOX

## COMPLETE SET

(Incl. built-in element & waterproofing installation kit)



Make your bathroom items disappear

### WALL NICHE | WITH TILEABLE DOOR

6" x 12" x 4" | 15 x 30 x 10 cm  
6" x 12" x 5 1/2" | 15 x 30 x 14 cm



Finish	Depth 4"	Depth 5 1/2"
Stainless steel	BOXT-15x30x10	BOXT-15x30x14
Anthracite	BOXT-A-15x30x10	BOXT-A-15x30x14
Black	BOXT-B-15x30x10	BOXT-B-15x30x14
White	BOXT-W-15x30x10	BOXT-W-15x30x14
Creme	BOXT-C-15x30x10	BOXT-C-15x30x14

Price \$ 674.65

### WALL NICHE | WITH TILEABLE DOOR

12" x 12" x 4" | 30 x 30 x 10 cm  
12" x 12" x 5 1/2" | 30 x 30 x 14 cm



Finish	Depth 4"	Depth 5 1/2"
Stainless steel	BOXT-30x30x10	BOXT-30x30x14
Anthracite	BOXT-A-30x30x10	BOXT-A-30x30x14
Black	BOXT-B-30x30x10	BOXT-B-30x30x14
White	BOXT-W-30x30x10	BOXT-W-30x30x14
Creme	BOXT-C-30x30x10	BOXT-C-30x30x14

Price \$ 770.44

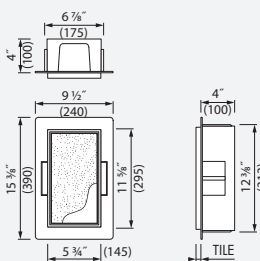

Depth 4" (100 mm)

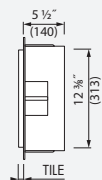

Depth 5 1/2" (140 mm)

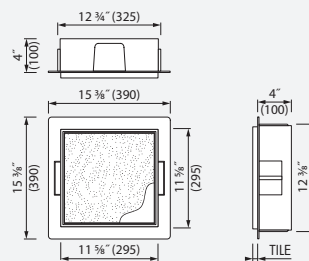

Depth 4" (100 mm)

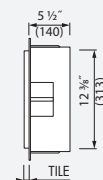

Depth 5 1/2" (140 mm)



# C-BOX

**COMPLETE SET**  
(Incl. built-in element & waterproofing installation kit)



Colored wall niches

## WALL NICHE

6" x 12" x 4" | 15 x 30 x 10 cm



### Finish

Stainless steel	BOX10C-15x30x10
Anthracite	BOX10C-A-15x30x10
Black	BOX10C-B-15x30x10
White	BOX10C-W-15x30x10
Creme	BOX10C-C-15x30x10

**Price** \$ 558.26

## WALL NICHE

12" x 12" x 4" | 30 x 30 x 10 cm



### Finish

Stainless steel	BOX10C-30x30x10
Anthracite	BOX10C-A-30x30x10
Black	BOX10C-B-30x30x10
White	BOX10C-W-30x30x10
Creme	BOX10C-C-30x30x10

**Price** \$ 646.84

## WALL NICHE

24" x 12" x 4" | 60 x 30 x 10 cm



### Finish

Stainless steel	BOX10C-60x30x10
Anthracite	BOX10C-A-60x30x10
Black	BOX10C-B-60x30x10
White	BOX10C-W-60x30x10
Creme	BOX10C-C-60x30x10

**Price** \$ 852.84

C-BOX

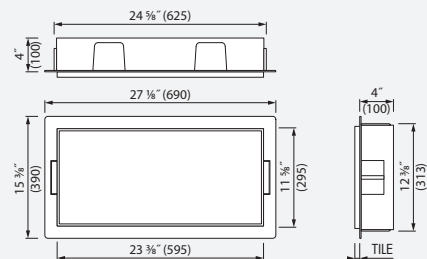
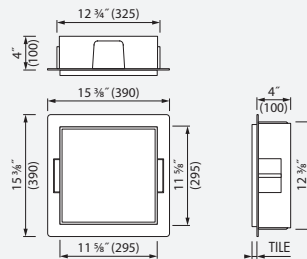
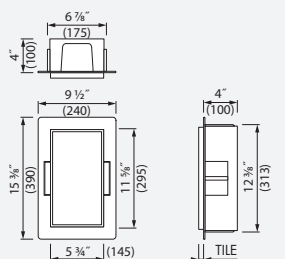



# BOX

Add more space and style to your bathroom

## WALL NICHE

6" x 12" x 4" | 15 x 30 x 10 cm



Finish	Frame brushed stainless steel	Frame polished	Price
Stainless steel	BOX-15x30x10	BOX-15x30x10-P	\$ 450.11
Anthracite	BOX-15x30x10-A	BOX-15x30x10-PA	\$ 652.36
Black	BOX-15x30x10-B	BOX-15x30x10-PB	\$ 652.36
White	BOX-15x30x10-W	BOX-15x30x10-PW	\$ 652.36
Creme	BOX-15x30x10-C	BOX-15x30x10-PC	\$ 652.36

## WALL NICHE

12" x 12" x 4" | 30 x 30 x 10 cm



Finish	Frame brushed stainless steel	Frame polished	Price
Stainless steel	BOX-30x30x10	BOX-30x30x10-P	\$ 513.97
Anthracite	BOX-30x30x10-A	BOX-30x30x10-PA	\$ 740.47
Black	BOX-30x30x10-B	BOX-30x30x10-PB	\$ 740.47
White	BOX-30x30x10-W	BOX-30x30x10-PW	\$ 740.47
Creme	BOX-30x30x10-C	BOX-30x30x10-PC	\$ 740.47

## WALL NICHE

24" x 12" x 4" | 60 x 30 x 10 cm



Finish	Frame brushed stainless steel	Frame polished	Price
Stainless steel	BOX-60x30x10	BOX-60x30x10-P	\$ 605.64
Anthracite	BOX-60x30x10-A	BOX-60x30x10-PA	\$ 948.55
Black	BOX-60x30x10-B	BOX-60x30x10-PB	\$ 948.55
White	BOX-60x30x10-W	BOX-60x30x10-PW	\$ 948.55
Creme	BOX-60x30x10-C	BOX-60x30x10-PC	\$ 948.55

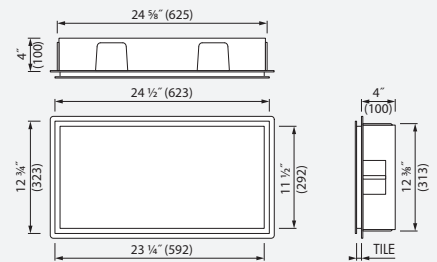
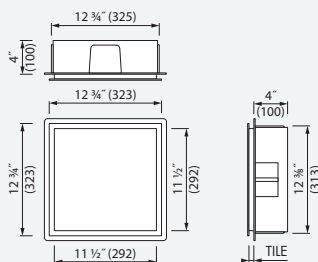
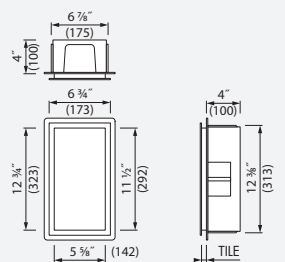

6" x 12" x 4" | 15 x 30 x 10 cm

12" x 12" x 4" | 30 x 30 x 10 cm

24" x 12" x 4" | 60 x 30 x 10 cm

# BOX

## COMPLETE SET

(Incl. built-in element & waterproofing installation kit)



### WALL NICHE

36" x 12" x 4" | 90 x 30 x 10



Finish	Frame	Frame	Price
Stainless steel	brushed stainless steel BOX-90x30x10	polished BOX-90x30x10-P	\$1,062.90

### WALL NICHE

48" x 12" x 4" | 120 x 30 x 10 cm

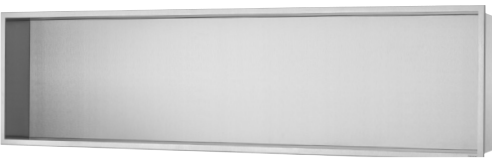

Finish	Frame	Frame	Price
Stainless steel	brushed stainless steel BOX-120x30x10	polished BOX-120x30x10-P	\$1,308.47

## ACCESSORIES

### BUILT-IN ELEMENT

6" x 12" | 12" x 12" | 24" x 12" (15 x 30 | 30 x 30 | 60 x 30)



Size	Article code	Price
6" x 12"	SPA-BOX-01	\$ 184.68
12" x 12"	SPA-BOX-02	\$ 184.68
24" x 12"	SPA-BOX-03	\$ 184.68

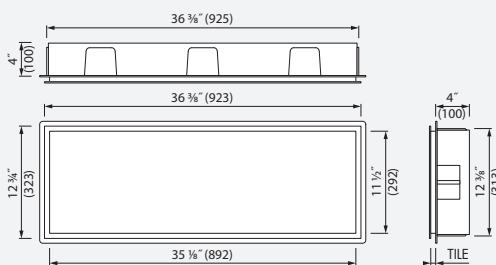

36" x 12" x 4" | 90 x 30 x 10 cm

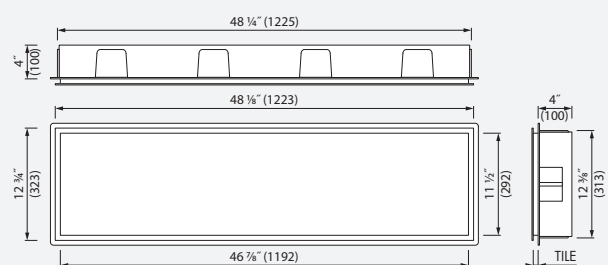

48" x 12" x 4" | 120 x 30 x 10 cm

# BOX

## COMPLETE SET

(Incl. built-in element & waterproofing installation kit)



### WALL NICHE | WITH DOOR

6" x 12" x 4" | 12" x 12" x 4" | 24" x 12" x 4"

15 x 30 x 10 | 30 x 30 x 10 | 60 x 30 x 10 cm

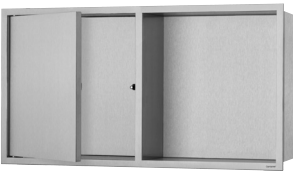

Finish	Article code	Size	Price
Stainless steel	BOX-15x30x10-D	6" x 6" x 4" 15 x 30 x 10 cm	\$ 572.68
Stainless steel	BOX-30x30x10-D	12" x 12" x 4" 30 x 30 x 10 cm	\$ 664.35
Stainless steel	BOX-60x30x10-D	24" x 12" x 4" 60 x 30 x 10 cm	\$ 760.14

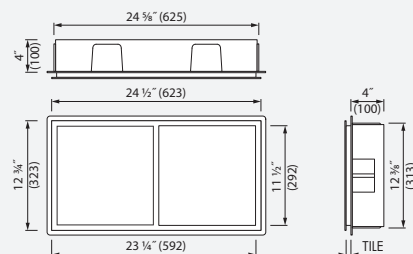
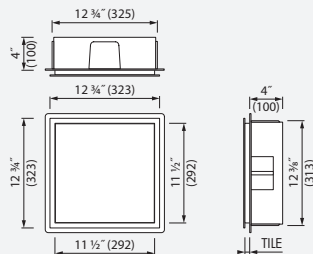
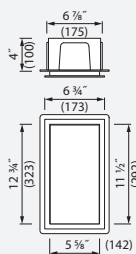



# T-ROLL

Make your toilet items disappear

## BUILT-IN TOILET BRUSH HOLDER & WALL NICHE | WITH TILEABLE DOOR



Finish	Article code
Stainless steel	TCL-8
Anthracite	TCL-8-A
Black	TCL-8-B
White	TCL-8-W
Creme	TCL-8-C

Price \$ 936.27

## BUILT-IN TOILET BRUSH HOLDER & PAPER HOLDER | WITH TILEABLE DOOR



Finish	Article code
Stainless steel	TCL-9
Anthracite	TCL-9-A
Black	TCL-9-B
White	TCL-9-W
Creme	TCL-9-C

Price \$ 936.27

## BUILT-IN TOILET BRUSH HOLDER & PAPER HOLDER | WITH TILEABLE DOOR



Finish	Article code
Stainless steel	TCL-10
Anthracite	TCL-10-A
Black	TCL-10-B
White	TCL-10-W
Creme	TCL-10-C

Price \$1,383.20

## BUILT-IN WASTE CONTAINER & WALL NICHE | WITH TILEABLE DOOR



Finish	Article code
Stainless steel	TCL-11
Anthracite	TCL-11-A
Black	TCL-11-B
White	TCL-11-W
Creme	TCL-11-C

Price \$1,383.20

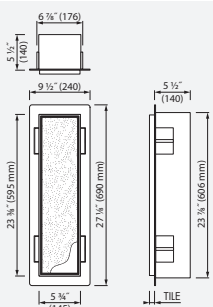

TCL-8 | Built-in toilet brush holder & wall niche

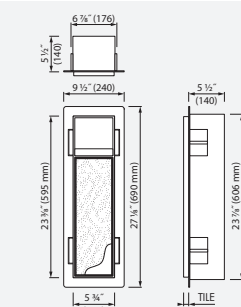

TCL-9 | Built-in toilet brush holder & paper holder

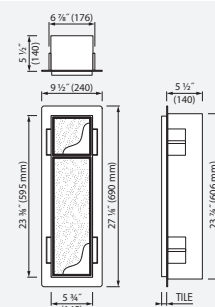

TCL-10 | Built-in toilet brush holder & paper holder

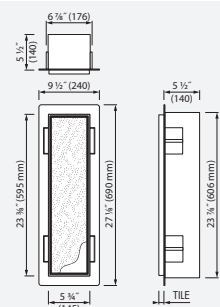

TCL-11 | Built-in waste container & wall niche

# T-ROLL

## COMPLETE SET

(Incl. built-in element & waterproofing installation kit)



### WALL NICHE / PAPER HOLDER WITH TILEABLE DOOR

6" x 6" x 5 1/2" (15 x 15 x 14 cm)



Finish	Article code
Stainless steel	BOXT-15x15x14
Anthracite	BOXT-A-15x15x14
Black	BOXT-B-15x15x14
White	BOXT-W-15x15x14
Creme	BOXT-C-15x15x14

Price \$ 584.88

### WALL NICHE / SHELF WITH TILEABLE DOOR

6" x 12" x 5 1/2" (15 x 30 x 14 cm)



Finish	Article code
Stainless steel	TCL-12
Anthracite	TCL-12-A
Black	TCL-12-B
White	TCL-12-W
Creme	TCL-12-C

Price \$ 655.20

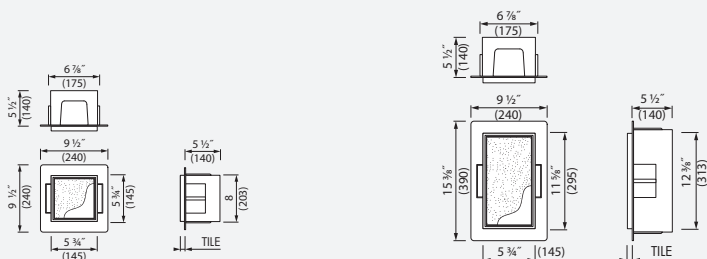

**BOX-T-15x15-14** | Wall niche / paper holder 6" x 6" (15 x 15 cm)

**TCL-12** | Wall niche with shelf 6" x 12" (15 x 30 cm)

Store your toilet accessories easily

**BUILT-IN TOILET BRUSH HOLDER & WALL NICHE**

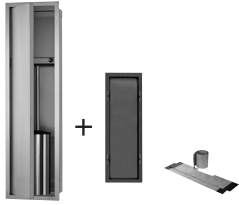

Incl. built-in element & waterproofing installation kit

Finish	Article code	Price
Stainless steel	TCL-6	\$ 936.27

**BUILT-IN TOILET BRUSH HOLDER & PAPER HOLDER**



Incl. built-in element & waterproofing installation kit

Finish	Article code	Price
Stainless steel	TCL-7	\$ 998.00

**TOILET PAPER STORAGE FOR 6 ROLLS**

Tileable



Finish	Article code	Price
Stainless steel	TCL-1	\$ 484.10

**TOILET PAPER HOLDER & TOILET PAPER STORAGE FOR 5 ROLLS**

Tileable



Finish	Article code	Price
Stainless steel	TCL-5	\$ 771.47

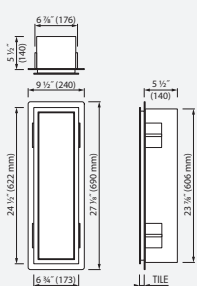

**TCL-6** | Built-in toilet brush holder & wall niche

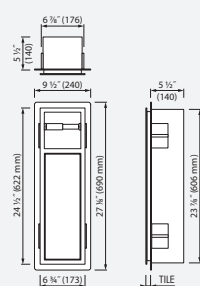

**TCL-7** | Built-in toilet brush holder & paper holder

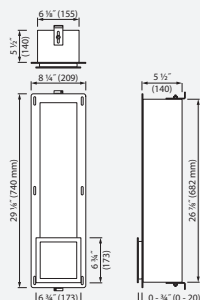

**TCL-1** | Toilet paper storage for 6 rolls

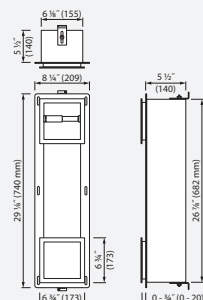

**TCL-5** | Toilet paper holder & toilet paper storage for 5 rolls

TOILET PAPER ROLL STORAGE SQUARE



Finish	Article code
Stainless steel	TCL-14
Anthracite	TCL-14-A
Black	TCL-14-B
White	TCL-14-W
Creme	TCL-14-C

Price \$ 444.96

TOILET PAPER ROLL STORAGE SQUARE



Finish	Article code	Price
Stainless steel	TCL-2	\$ 210.12

TOILET PAPER ROLL STORAGE ROUND



Finish	Article code	Price
Stainless steel	TCL-3	\$ 210.12

TOILET PAPER HOLDER SQUARE



Finish	Article code	Price
Stainless steel	TCL-4	\$ 264.71

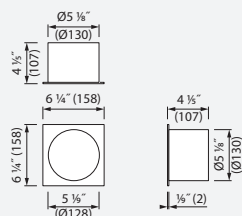

TCL-2 | Toilet paper roll storage square

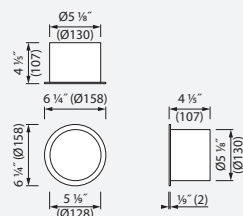

TCL-3 | Toilet paper roll storage round

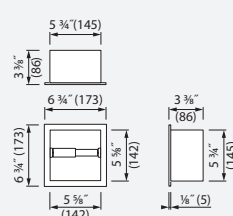

TCL-4 | Toilet paper holder square



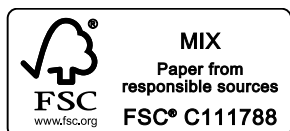

© ESS

The information in this brochure was carefully drawn up by ESS. In connection with the continuous improvement of existing products and the development of new products, ESS reserves the right to adjust specifications. It is the responsibility of the fitter and the user to determine that the ESS product is suitable for the planned application and is installed according to the prevalent fitting instructions. No rights may be derived from the recommendations and suggestions, because the installation and usage conditions are outside the scope of control of ESS.

a company of  
**Hansgrohe Group**



DEALER

**ESS Headquarters**

Nijverheidsstraat 60  
7575 BK Oldenzaal  
The Netherlands  
T: +31 541 200 800  
F: +31 541 200 899  
info@esspost.com  
[easydrain.com](http://easydrain.com)

**ESS Factory**

Warschauerstraße 1  
48455 Bad Bentheim  
Deutschland  
T: +49 59 24 29 91 568  
F: +49 59 24 29 91 537  
verkauf@esspost.com  
[easydrain.de](http://easydrain.de)

**Hansgrohe, Inc.**

1490 Bluegrass Lakes Pkwy  
Alpharetta, GA 30004  
North America  
T: +1 800 334 04 55  
sales-usa@esspost.com  
[easydrainusa.com](http://easydrainusa.com)



ESS PRODUCTS ARE PATENTED AND REGISTERED TRADEMARKS MADE BY ESS  
Technical amendments and printing mistakes reserved  
Warranty: [easydrain.com/warranty](http://easydrain.com/warranty) © 2021