



**THE
FURNITURE GUILD**

ESTD 1984

HOME
Retail Pricing 2020

Effective 4/1/2020

furnitureguild.com

The Furniture Guild, Inc
ph (888) 479-4108 - fax (770) 479-0176



Features

Made to Order in the USA.
 Limited Lifetime Warranty.
 Every piece is benchmade to order and signed by the craftsman.
 Built using PureBond formaldehyde free technology.
 All drawer systems are from Blum.
 Blum full extension, soft closing drawers and soft closing hinges.
 Finishes are Green Guard Certified for Indoor Air Quality.

Finish Availability

The finishes available for each piece are shown on the same page as pricing for that item.

Installation

Furniture designed for wall mount require blocking in the wall.
 Mount 2 x 6 horizontally in wall for maximum support.
 Wall Mounted cabinets have a solid 3/4" plywood back so they can be attached using lag bolts, screws, etc.
 Wall Mounted linen towers, medicine cabinets, and mirrors come with "Z clip" mounting hardware.

Prices

All prices are subject to change without notice and are exclusive of any shipping, delivery, or handling charges that may apply.

Terms

50% deposit due on all orders with approved credit.
 Balance due before shipping.

Freight

Shipped common carrier unless otherwise specified.
 Email shipping@furnitureguild.com for a freight quote.

Damage or Loss

Please note that our responsibility ends at the time The Furniture Guild delivers merchandise in original condition to the carrier. Delivery to the carrier constitutes delivery to the customer. All claims for damaged or lost shipments must be made promptly by the customer to the carrier.

Returns

All products are made to order and may not be returned.

Contact

info@furnitureguild.com
quotes@furnitureguild.com
shipping@furnitureguild.com
accounting@furnitureguild.com

Options and Upgrades

Decorative Hardware	4
Metal Accents	6
Metal Bases	8
Drawer Dividers	9
Lighting Options	10, 22
Electrical Options	10
Interior Upgrades	11
Finish Options	12

Countertops

Coding	13
Guildstone (solid surface)	14
Fenix (nanotech laminate)	14
Quartz	15
Stone	15
Wood	16
Carrier Arms for Floating Tops/Shelves	16

Shelving

Kinely Shelving	18
Fresco Shelving	20

Mirrors

200 series	23
400 series	23
600 series	24

Furniture Designs by Name

615	Alton	42
621	Avento	44
279	Barrett	24
295	Edwin	30
430	Fresco	34
290	Hayden	26
292	Henley	28
505	Josie	36
526	Lucas	38
406	Riva	32
610	Winston	40

PLEASE EMAIL ALL ORDERS TO:
orders@furnitureguild.com

Finish Samples

Samples are available for purchase
 Price includes shipping
 Samples can be returned for 100% credit for
 120 days if returned in good condition
 Trade discounts not applicable to sample purchases

Single Sample (wood, metal, countertop) \$15.00 ea
 Finish Group Book (ex. B-Exotic) \$50.00 per book
 Top Sample Set (includes all non-wood top finishes) \$50.00 per set
 Metal Sample Set (8 metal samples) \$75.00
 Price for a full finish case \$400.00, includes all finishes

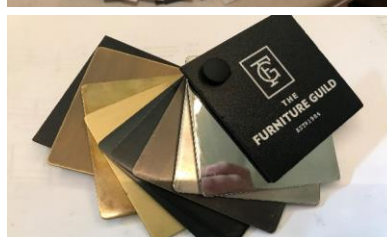

Welcome to Furniture Guild Home



DESIGNS

Based on our popular bathroom furniture line, these designs are both innovative and timeless.



COUNTERTOPS

Available in several different material types, we offer you optional countertop options.



WOOD FINISHES

We've taken the durability of our bathroom furniture and applied the same high quality finishes for home furnishings.

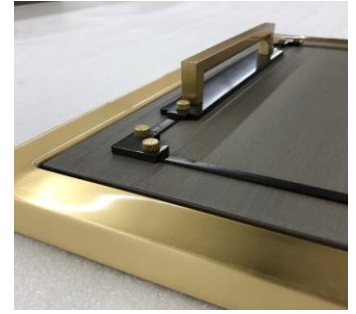

METAL FINISHES

We feature 8 architectural metal finish options including Polished Nickel, Satin Brass, and Matte Black.



DECORATIVE HARDWARE

We offer high quality, authentic, real brass and plated nickel hardware that is handmade to order.



SHELVING SYSTEMS

We offer innovative custom shelving systems that can be designed for any room of the home.



OPTIONS

We offer a multitude of upgradeable options such as walnut drawers, interior and exterior lighting, and power options.



FUNCTIONAL HARDWARE

We only use authentic BLUM hardware for optimal functionality and longevity.



CRAFTSMANSHIP

Each piece is built by hand by one of our skilled artisans ensuring that your furniture is a true work of art.

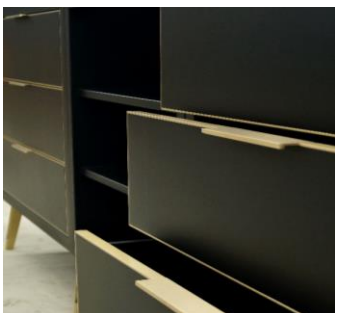

CUSTOM

We can customize existing to designs to the trade.



MADE IN THE USA

All of our furniture is made by hand in our factory located in Canton, GA, USA.



WARRANTY

Our limited lifetime warranty will give you peace of mind to know that you're investing in true heirloom quality furniture that can be enjoyed for generations.



Decorative Hardware

Group 1
 SB Satin Brass (lacquered)
 AB Antique Brass (lacquered)
 MB Matte Black (lacquered)
 OC Oil Can (lacquered)

Group 2
 BB Burnished Brass Waxed
 PN Polished Nickel
 SN Satin Nickel
 PC Polished Chrome



3" Round Ring Pull

Solid Brass, Projection of 3/4"

Item #	Size	Group 1	Group 2
3RDRING-[Finish]	3" diameter	90	90



3" Square Ring Pull

Solid Brass, Projection of 3/4"

Item #	Size	Group 1	Group 2
3SQRING-[Finish]	3" square	90	90



Stephen Pull

Tapered Bar Pull, 1/2" x 3/4" projection, **PC Polished Chrome only**

Item #	Size	Polished Chrome
6STEPULL-PC	5 3/4"	60



Edge Pull

Projection of 3/4", Doors/Drawers have to be mortised on top to fit.

Item #	Size	Group 1	Group 2
8EDGE-[Finish]	8"	90	120
12EDGE-[Finish]	12"	120	150



D-Bar

Solid Brass, Projection of 7/8", Soft rounded shape on the back of the pull

Item #	Size	Group 1	Group 2
6DBAR-[Finish]	6"cc	65	70
8DBAR-[Finish]	8"cc	70	80
12DBAR-[Finish]	12"cc	140	155
18DBAR-[Finish]	18"cc	200	220



3" Recessed Round Knob

Recessed into face of the door/drawer

Requires slab style door/drawer, Projection of 3/4"

Item #	Size	Group 1	Group 2
RRKNOB-[Finish]	2.875"Dia	350	450



3" Recessed Square Knob

Recessed into face of the door/drawer

Requires slab style door/drawer, Projection of 3/4"

Item #	Size	Group 1	Group 2
RSKNOB-[Finish]	2.875"Square	350	450



Decorative Hardware

- Group 1**
 SB Satin Brass (lacquered)
 AB Antique Brass (lacquered)
 MB Matte Black (lacquered)
 OC Oil Can (lacquered)
- Group 2**
 BB Burnished Brass Waxed
 PN Polished Nickel
 SN Satin Nickel
 PC Polished Chrome

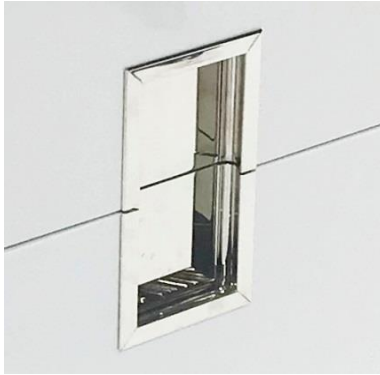

Integrated Square Metal Pull

Recessed into face of the door/drawer, Requires slab style door/drawer, Projection of 1/8"

Picture on left shows qty 2 of INTSQMET-PN

4"W x 3.5" h - stacking 2 together the pulls are total of 7 1/4"H

Item #	Size	Group 1	Group 2
INTSQMET-[Finish]	4"W x 3.5"H ea	450	550

Picture on left shows qty 2 of INTSQMET-PN



Recessed Bar Pull

Recessed into face of the door/drawer, Projection of 3/4"

Item #	Size	Group 1	Group 2
11RBAR-[Finish]	10.75W x 2.75H	600	700

Hardware Alternatives



Integrated Finger Pull

Adds a beveled edge to the top of a door or drawer

Only available on 400 Series products

Item #	Size	List
INTPULL	Full width of door/drawer	350 per door/drawer



Touch To Open

Mechanical touch to open by Blum

With TTO option, drawers over 24" are always synchronized to prevent opening issues

Ships separately with instructions and requires installation onsite

Item #	Description	List
TTO	Touch To Open	200 per door/drawer



Metal Accents

- Group 1**
 SB Satin Brass (lacquered)
 AB Antique Brass (lacquered)
 MB Matte Black (lacquered)
 OC Oil Can (lacquered)
- Group 2**
 BB Burnished Brass Waxed
 PN Polished Nickel
 SN Satin Nickel
 PC Polished Chrome



Metal Framing

Available on 400 series with Full Overlay feature - drawer reveal is on the side

1" wide framing wraps around drawer/door

Corners are mitered but not welded

Projection is 1/8"

Item #	Size	Group 1	Group 2
FRAME1-[finish]	1" Wide x 1" Thick	500 per panel	650 per panel
FRAME2-[finish]	1/2" Wide x 1" Thick	500 per panel	650 per panel



Metal Banding

3/4" x 1/8" Solid Brass trim detail runs around each door/drawer

1/8" visible when drawer is shut on inset designs

3/4" side profile visible on full overlay designs

Corners are mitered but not welded

Does not project from drawer/door face

Not Compatible on 600 Series

Item #	Size	Group 1	Group 2
BAND1-[finish]	Custom	500 per panel	650 per panel



1/4" Metal Inlay

Available on all designs

Changes door design to slab door with 1/4" inlay spaced 1" in from perimeter

Corners are mitered but not welded

Projection is 1/16"

Item #	Description	Group 1	Group 2
INLAY1-[finish]	1/4" inlay	350 per panel	450 per panel

Examples of Metal Accents



406-5130-CC Riva in Custom Blue Paint
 FRAME1-BB x3 1" Framing in Burnished Brass
 8DBAR-BB x3 8" DBAR in Burnished Brass
 QT-BN-2.0-30-F Quartz Top in BN Bianco



430-5136-C44 Fresco in C44 Bromo Gray Fenix
 BAND1-SB x3 Metal Banding in Satin Brass
 12DBAR-SB x3 12" DBAR in Satin Brass
 WT-C44-2.0-36-F Wood Top in C44 Bromo Gray Fenix



406-5130-C22 Riva in C22 Black Acrylic
 INLAY1-SB x3 1/4" Inlay in Satin Brass
 RSKNOB-OC x3 Recessed Square Knob in Oil Can
 MB1-3004-OC Metal Base 1 in Oil Can



Metal Accents

- Group 1**
 SB Satin Brass (lacquered)
 AB Antique Brass (lacquered)
 MB Matte Black (lacquered)
 OC Oil Can (lacquered)
- Group 2**
 BB Burnished Brass Waxed
 PN Polished Nickel
 SN Satin Nickel
 PC Polished Chrome



CBAR1-SB with slotted screw detail



CBAR2-SB with knurled screw detail

Campaign Bar Pull Solid Brass Pull and Backplate, 7 3/4"W, Projection of 1 1/8"
 Includes 6DBAR. Only compatible with 6"CC pulls. Min panel width for CBAR and inlay is 14"

Item #	Description	Group 1	Group 2
CBAR1-[Finish]	Slotted Screw Detail	200	230
CBAR2-[Finish]	Knurled Screw Detail	200	230
Split Finish - Add 15% to higher group price			add 15%

Options for CBAR

Split Finish Coding [Pull Finish] - [Backplate Finish] - [Screw Finish]
 Inline mounting with an Inlay Add [INLINE] to have mounted in line with inlay
 *Minimum Panel Width for CBAR and any Inlay is 14"



Campaign Inlay

Available on all designs
 Includes 1/4" Inlay and decorative corners
 Pulls are not included and must be ordered separately
 Changes door design to slab door with 1/4" inlay spaced 1" from perimeter with decorative corners
 Decorative Corners come in 2 different designs, select 1
 Projection of trim is 1/16", projection of corner with Knurled screw is 3/8"

Item #	Description	Group 1	Group 2
CAMP1-[finish]	Inlay with Slotted Screw Corners	500 per panel	650 per panel
CAMP2-[finish]	Inlay with Knurled Screw Corners	500 per panel	650 per panel
Split Finish - Add 15% to higher group price			add 15%



INLINE MOUNTING OPTION



CAMP1-PN



CAMP2-PN

Options for Campaign Inlay

Split Finish Coding [Inlay Finish] - [Corner Finish] - [Screw Finish]

Examples of Campaign Inlay



295-5130-SB-B42 Edwin in SB and Granite Walnut
 CAMP1-SB Campaign Inlay x3
 CBAR1-SB-INLINE x3
 QT-BN-1.2-30-F Quartz Countertop



430-5230-B61 Fresco in B61 Black Oak
 CAMP2-AB Campaign Inlay in Antique Brass x1
 CBAR2-AB-INLINE Campaign Bar Pull in Antique Brass x1
 WT-B61-2.0-30-F Wood Top in B61 Black Oak



406-5130-B39 Riva in B39 English Walnut
 MB5-3004-PN Metal Base in Polished Nickel
 CAMP2-PN x3 Campaign Inlay in Polished Nickel
 CBAR2-PN-INLINE x3 Campaign Pulls in Polished Nickel
 ST-CR-1.2-30-F Stone Top in Carrara



Metal Bases

Features

Metal Bases designed to fit under wall mounted designs
 Furniture piece ordered separately
 Furniture and Base must be ordered at the same time and must be shipped together

Compatible Vanity Designs

Designs over metal bases must have flush outer walls
 All wall mounted 400 series are compatible
 Consider overall height with top when ordering

Standard Installation

Bases come installed with screws and can be disassembled in the field if necessary

Group 1

SB Satin Brass (lacquered)
 AB Antique Brass (lacquered)
 MB Matte Black (lacquered)
 OC Oil Can (lacquered)

Group 2

BB Burnished Brass Waxed
 PN Polished Nickel
 SN Satin Nickel
 PC Polished Chrome

MB2 NOT AVAILABLE IN POLISHED CHROME

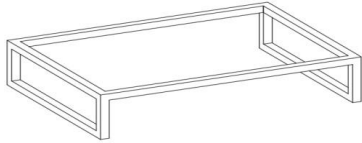

MB1-3004-[finish code]

MB1-4"H 1" x 1" Brass or Steel Tube. Fully Welded and Sculpted Corners				
Item#	Without Top	Group 1	Group 2	
MB1-2404	24W x 4H	1245	1545	
MB1-3004	30W x 4H	1345	1595	
MB1-3604	36W x 4H	1395	1695	
MB1-4204	42W x 4H	1495	1795	
MB1-4804	48W x 4H	1545	1845	
MB1-5404	54W x 4H	1595	1945	
MB1-6004	60W x 4H	1695	2245	
MB1-6604	66W x 4H	1745	2295	
MB1-7204	72W x 4H	1845	2395	
MB1-7804	78W x 4H	1945	2495	
MB1-8404	84W x 4H	2045	2595	



406-5130 with MB1-3004-OC

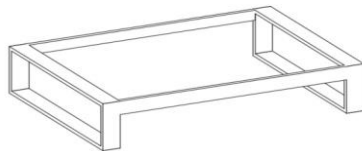

MB2-3004-[finish code]

MB2-4"H 1/2" x 2" Brass Tube or Solid Steel, Fully Welded with Sculpted Corners				
NOT AVAILABLE IN POLISHED CHROME				
Item#	Without Top	Group 1	Group 2	
MB2-2404	24W x 4H	1345	1645	
MB2-3004	30W x 4H	1395	1695	
MB2-3604	36W x 4H	1495	1795	
MB2-4204	42W x 4H	1545	1845	
MB2-4804	48W x 4H	1595	1945	
MB2-5404	54W x 4H	1695	2295	
MB2-6004	60W x 4H	1745	2395	
MB2-6604	66W x 4H	1845	2445	
MB2-7204	72W x 4H	1895	2545	
MB2-7804	78W x 4H	1995	2645	
MB2-8404	84W x 4H	2095	2745	



406-5130 with MB2-3004-BB

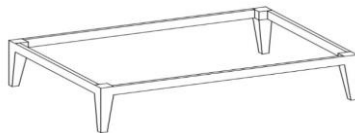

MB5-3004-[finish code]

MB5-4"H 1 1/2" x 1 1/2" Brass or Steel Tube with Tapered Legs				
Item#	Without Top	Group 1	Group 2	
MB5-2404	24W x 4H	1495	1795	
MB5-3004	30W x 4H	1545	1845	
MB5-3604	36W x 4H	1595	1945	
MB5-4204	42W x 4H	1695	1995	
MB5-4804	48W x 4H	1745	2395	
MB5-5404	54W x 4H	1845	2445	
MB5-6004	60W x 4H	1895	2545	
MB5-6604	66W x 4H	1945	2595	
MB5-7204	72W x 4H	2045	2695	
MB5-7804	78W x 4H	2145	2795	
MB5-8404	84W x 4H	2245	2895	



406-0130 with MB5-3004-SB



Glass Drawer Dividers



Pictured here: WALDWR, GLSDIV-FD, DI4JAR, DILEATHR6

Glass Dividers for Full Drawer

2 1/2"H x 1/4" thick glass divider walls running front to back

3 1/4" spaces between each divider

Glass dividers can be removed to create larger spaces

Glass is removable for cleaning

Please specify drawer assignment when ordering

Item #	Description	List
GLSDIV-FD	Dividers for Drawer	250

12" Full Drawer 2 Dividers

15" Full Drawer 3 Dividers

21" Full Drawer 5 Dividers

18" Full Drawer 4 Dividers

24"+ Full Drawer 6 Dividers

*number of dividers could change based on design selected



Pictured here: Standard Gray Drawer, GLSDIV-FD



Inserts for Glass Drawer Dividers

Optional accessories that fit into spaces between glass dividers

Can be moved to different positions

Removable for cleaning

Made and finished to match the drawer

Gray Suede is provided with Gray Legrabox Drawers

Beige Suede is provided with Wood Dovetailed Drawers

Item #	Description	List
DI4JAR	4 Glass Jars	200
DI4PEN	Divider Insert, Pencil Holder	150
DILEATHR3	Beige/Gray Suede Insert 3.25"W	100
DILEATHR6	Beige/Gray Suede Insert 6.75"W	100



Sliding Divider Box for Tall Drawer

Requires purchase of a GLSDIV-FD in a 15" drawer or larger

Box is finished to match drawer

Moves left to right over the glass drawer dividers

Creates a second tier in a deep drawer for additional storage

Requires drawer removal for installation

Item #	Description	List
DIVBOX	7" W x approx 14"D x 3 1/4"H	200

Pictured here: GLSDIV-FD, DIVBOX, DILEATHR6, DI4JAR



Lighting and Electrical Options

Please specify placement when ordering options



Interior Light for Drawer

Lights interior of cabinet when door/drawer is opened
Warm white LED light with door/drawer activated switch
Surface mounted just inside cabinet at the top
Requires non-switched electrical outlet to be placed behind furniture piece
Order one per door cabinet or per drawer

Item #	Size	List
INTLT	Made to fit drawer or door width	400 per light

*Interior dividers shown not included



Exterior Accent Lighting for Furniture

3000K Warm white LED to accent the space below furniture
LED housing has an anodized aluminum finish
Includes switch but can be wired to a wall switch by electrician
Requires non-switched electrical outlet to be placed behind furniture piece
Up to 96" single run of LED lighting

Item #	Size	List
EXTLT	Made to fit furniture width	750 per light



Dimmable Option for Exterior Accent Lighting

Eliminates switch normally included
Upgrade standard transformer to a electronic dimmable transformer
Req switched power outlet behind furniture piece.
Dimmable with any standard MLV/CL (Triac) Forward Phase Dimmer Switch (not included)

Item #	Size	List
EXTDIM		250 per light

*Requires purchase of EXTLT Exterior LED Light



Power Outlet for Door Cabinet

Power outlet mounted on inner wall of cabinet
Includes wire with plug on the end
Default position is behind right door or just above top drawer shown here
Requires non-switched electrical outlet to be placed behind door section of furniture piece.

Item #	Description	List
PWR110	Fixed outlet inside cabinet	200

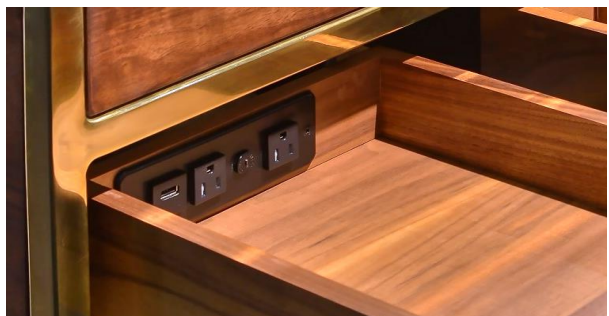

Power Drawer

Please identify drawer assignment when ordering
Shrinks drawer depth to leave approx 4.5" behind drawer
Power outlet mounted in back of drawer
Includes cord hinge for wire management
2 standard receptacles plus 1 USB
Requires non-switched electrical outlet to be placed behind drawer where assigned.

Compatibility Limitations:

Minimum Drawer height = 3 1/4"H Minimum Drawer Width = 12"W

Item #	Size	List
PWRDWR	Custom	500



Interior Upgrades

Please specify placement when ordering options



Walnut Drawer Upgrade

Converts default drawer into walnut drawer
Drawers are made from solid American Black Walnut
Handmade in our factory
Not available on Mirrored Door designs
Max height is 8.25"

Item #	Description	List
WALDWR	Walnut Drawer Upgrade	300 ea

*Glass Dividers and Inserts are sold separately



Pullout Tray

A full extension drawer behind doors which allows easy access to items inside the cabinet
Width of tray is typically 4" smaller than door opening to allow for hinge clearance

Item #	Size	List
PTRAY	Custom width x 15"D x 4 1/2"H	350 ea

Adjustable Shelf

Add an adjustable shelf behind doors

Item #	Size	List
ADSF	Custom	200 ea



Finish Options



Custom Finishes

Paint match to Benjamin Moore, Sherwin Williams or Farrow and Ball

Stain match to customer supplied sample

Item #	Description	List
CUSTPAINT	Custom Paint Color Match	10%
GLOSS	Turn Standard Matte Paint to Gloss	10%
CUSTSTAIN	Custom Stain Color Match	15%

*For custom stain, you must send us a physical sample to match



Combo Finish

Combine two finishes on one vanity

Please specify where each color is to be applied

Item #	List
COMBO	Highest Price Category + 10%



100/200 Series Door Style Change

Change door style from one vanity to another

Grid change or frame change

For completely custom door changes please call the factory for a quote

Item #	Description	List
DOORCHG	Change Door Style to _____	10%



Antique Mirror

Change standard mirror to antique mirror

Item #	Description	List
ANTMIR	Antique Mirror Upgrade	10%



Countertops

NOT AVAILABLE
WITHOUT
FURNITURE



Countertops are NOT included and must be ordered separately

- Choose from our 5 different programs
- Each program has a different selection of colors and edge options.
- Order top as a separate line item using the coding specified below.

Program Code

- GS = Guildstone (solid surface)
- FS = Fenix (nanotech laminate)
- QT = Quartz
- ST = Stone
- WT = Wood

Color/Material

- Please see samples of colors and materials in showroom.
- Not all materials are available in all edge profiles.
- Please see pricing pages for availability.

Flush vs Overhang

- Use F or O to designate Flush or Overhang
- F-Flush will have a near flush appearance.
- We factor in 1/8" overhang to account for our 1/8" standard countertop tolerance.
- O-Overhang is standard 1/2".
- F tops will be furniture size plus 1/4" wide.
- O tops will be furniture size plus 1" wide.

GS/FS/QT/ST/WT

Program Code

CL

Color

2.0

Edge Profile

30

Size

F/O

Flush/Overhang

Edge Profiles and Compatibility

- Various Edge profile heights are available on each program.
- All edges with buildups have a mitered lamination.
- Designs with finished backs get overhangs on the back.

Size

- Size of furniture ordered.
- Actual top size will depend on overhang or flush option. See Flush vs Overhang.
- Max width is 85"
- For custom sizes, call for a quote



Guildstone

solidsurface

NOT AVAILABLE WITHOUT FURNITURE



- 5 year residential warranty
- 1 year commercial warranty

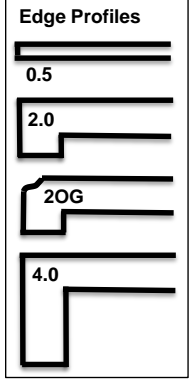

GS - WM - 2.0 - 30 - F/O
Guildstone White Matte Edge Profile Size Flush/Overhang

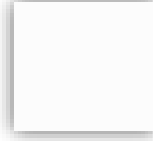

WM White Matte



WG White Gloss

Size	Item #	Color >>> Edge >>>	WM				WG			
			0.5	2.0	2OG	4.0	0.5	2.0	2OG	4.0
24	GS-[color]-[edge]-24-[F/O]		545	1295	1445	1445	745	1745	1945	1945
30	GS-[color]-[edge]-30-[F/O]		645	1495	1645	1645	895	1995	2195	2195
36	GS-[color]-[edge]-36-[F/O]		795	1695	1845	1845	1095	2245	2495	2495
42	GS-[color]-[edge]-42-[F/O]		895	1895	2045	2045	1195	2545	2795	2795
48	GS-[color]-[edge]-48-[F/O]		1045	2045	2245	2245	1445	2745	2995	2995
54	GS-[color]-[edge]-54-[F/O]		1145	2245	2445	2445	1545	3045	3295	3295
60	GS-[color]-[edge]-60-[F/O]		1245	2445	2645	2645	1695	3295	3595	3595
66	GS-[color]-[edge]-66-[F/O]		1395	2645	2845	2845	1895	3595	3845	3845
72	GS-[color]-[edge]-72-[F/O]		1495	2845	3045	3045	1995	3845	4145	4145
78	GS-[color]-[edge]-78-[F/O]		1645	3045	3245	3245	2195	4095	4395	4395
84	GS-[color]-[edge]-84-[F/O]		1745	3195	3445	3445	2345	4295	4645	4645



Fenix

solid nanotech laminate

NOT AVAILABLE WITHOUT FURNITURE



- 5 year residential warranty
- 1 year commercial warranty

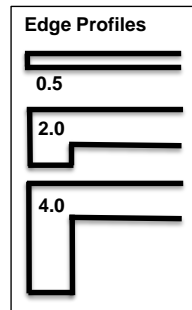

FS - C41 - 0.5 - 30 - F/O
Fenix Black Fenix Edge Profile Size Flush/Overhang

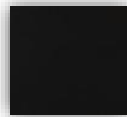

C41 Black Fenix

Size	Item #	0.5	2.0	4.0
24	FS-[color]-[edge]-24-[F/O]	1045	1945	2195
30	FS-[color]-[edge]-30-[F/O]	1295	2295	2545
36	FS-[color]-[edge]-36-[F/O]	1545	2595	2895
42	FS-[color]-[edge]-42-[F/O]	1745	2945	3245
48	FS-[color]-[edge]-48-[F/O]	2045	3245	3595
54	FS-[color]-[edge]-54-[F/O]	2245	3595	3945
60	FS-[color]-[edge]-60-[F/O]	2545	3895	4295
66	FS-[color]-[edge]-66-[F/O]	2795	4245	4645
72	FS-[color]-[edge]-72-[F/O]	3045	4545	4995
78	FS-[color]-[edge]-78-[F/O]	3295	4895	5345
84	FS-[color]-[edge]-84-[F/O]	3495	5195	5695



Quartz

NOT AVAILABLE WITHOUT FURNITURE



- 5 year residential warranty
- 1 year commercial warranty

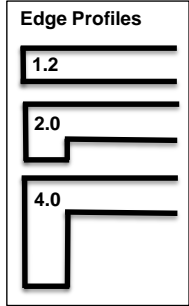

PW Pure White Quartz

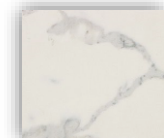

BN Bianco Quartz



CL Calacatta Quartz

QT - BN - 2.0 - 36 - F/O
 Countertop Bianco Edge Profile Size Flush/Overhang

Size	Item #	Color >>>	PW	PW	PW	CL/BN	CL/BN	CL/BN
		Edge >>>	1.2	2.0	4.0	1.2	2.0	4.0
24	QT-[color]-[edge]-24-[F/O]		695	1245	1395	1145	1795	2095
30	QT-[color]-[edge]-30-[F/O]		795	1445	1595	1345	2095	2395
36	QT-[color]-[edge]-36-[F/O]		945	1645	1795	1645	2395	2695
42	QT-[color]-[edge]-42-[F/O]		1145	1845	1995	1895	2695	3045
48	QT-[color]-[edge]-48-[F/O]		1245	1995	2195	2145	3045	3345
54	QT-[color]-[edge]-54-[F/O]		1395	2195	2395	2345	3295	3695
60	QT-[color]-[edge]-60-[F/O]		1545	2395	2595	2595	3645	4045
66	QT-[color]-[edge]-66-[F/O]		1695	2595	2845	2895	3945	4345
72	QT-[color]-[edge]-72-[F/O]		1845	2745	3045	3095	4245	4695
78	QT-[color]-[edge]-78-[F/O]		1945	2945	3245	3345	4595	5045
84	QT-[color]-[edge]-84-[F/O]		2095	3145	3445	3595	4895	5345



Stone

NOT AVAILABLE WITHOUT FURNITURE



- 5 year residential warranty
- 1 year commercial warranty
- Polished and Sealed from the factory
- Requires yearly sealer application

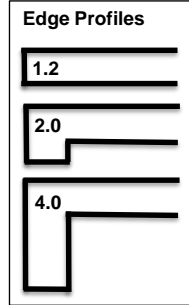

CR Carrara Marble

ST - CR - 2.0 - 72 - F/O
 Stone top Carrara Marble Edge Size Flush/Overhang

Size	Item #	CR	CR	CR
		1.2	2.0	4.0
24	ST-[color]-[edge]-24-[overhang]	795	1395	1545
30	ST-[color]-[edge]-30-[overhang]	945	1545	1745
36	ST-[color]-[edge]-36-[overhang]	1145	1745	1945
42	ST-[color]-[edge]-42-[overhang]	1245	1945	2145
48	ST-[color]-[edge]-48-[overhang]	1445	2195	2395
54	ST-[color]-[edge]-54-[overhang]	1595	2395	2645
60	ST-[color]-[edge]-60-[overhang]	1745	2595	2845
66	ST-[color]-[edge]-66-[overhang]	1895	2795	3045
72	ST-[color]-[edge]-72-[overhang]	2095	3045	3295
78	ST-[color]-[edge]-78-[overhang]	2245	3245	3495
84	ST-[color]-[edge]-84-[overhang]	2395	3445	3745



CR Carrara Marble with 2.0 Edge



Wood

NOT AVAILABLE WITHOUT FURNITURE



- Available in all furniture finishes
- Wood tops are veneered substrate with 2mm solid edgebanding in most cases

- 5 year residential warranty
- 1 year commercial warranty

Edge Profiles

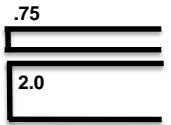

WT - C60 - 2.0 - 36 - F/O
 Countertop Ashlin Edge Profile Size Flush/Overhang

Size	Item #	Finish >>> Edge >>>	A		B		C		D	
			0.75	2.0	0.75	2.0	0.75	2.0	0.75	2.0
24	WT-[color]-[edge]-24-[F/O]		495	745	545	795	445	645	695	995
30	WT-[color]-[edge]-30-[F/O]		595	845	645	895	545	745	845	1145
36	WT-[color]-[edge]-36-[F/O]		695	945	745	995	645	845	945	1295
42	WT-[color]-[edge]-42-[F/O]		795	1045	845	1145	695	945	1045	1445
48	WT-[color]-[edge]-48-[F/O]		895	1145	945	1245	795	1045	1195	1595
54	WT-[color]-[edge]-54-[F/O]		995	1245	1045	1395	895	1145	1345	1745
60	WT-[color]-[edge]-60-[F/O]		1045	1395	1145	1495	945	1245	1445	1895
66	WT-[color]-[edge]-66-[F/O]		1145	1495	1245	1595	1045	1345	1595	2045
72	WT-[color]-[edge]-72-[F/O]		1245	1595	1345	1745	1145	1445	1745	2195
78	WT-[color]-[edge]-78-[F/O]		1345	1695	1445	1845	1195	1545	1795	2345
84	WT-[color]-[edge]-84-[F/O]		1445	1795	1545	1995	1295	1645	1945	2495

Carrier Arms for Countertops and Floating Shelves

Features

- Carrier arms are offered for wall-mount installation applications of countertops with a buildup or full depth floating shelves.
- The countertop/shelf may be secured to the carrier arms using products such as 3M VHB tape or a liquid adhesive such as Liquid Nails. Check local codes.
- Carrier arms are designed so that up to 6 bolts can be used with each arm to secure to the stud for maximum reinforcement.
- Carrier arms must be specified on order to ensure a proper fit.
- We recommend 2 carrier arms for applications under 60" wide.
- 3 arms are necessary for countertops 60" and up.
- Carrier arms only mount to the right side of a stud.

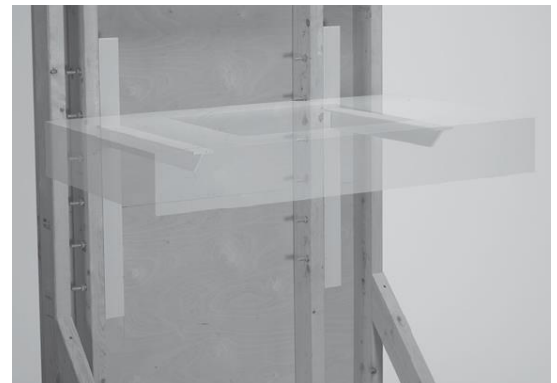

# of Arms	Item #	List
2	CARARM-2	\$350.00
3	CARARM-3	\$450.00



Shelving and Mirrors



We offer custom shelving solutions

- Choose from 2 different styles
 - Kinley - Solid Brass Banded Shelving with 1" x 1" square tube supports
 - Fresco - 2" thick wood shelving with hardware solutions for floating applications



Kinley Shelving



Kinley Shelving Units

Kinley shelving units can be made in any configuration to suit your design needs and fit.

- Any number of Shelves (rows)
- Any number of Bays (columns)
- Front Posts with Shelf Brackets (1" x 1" square tubing)
- Side Posts with Shelf Brackets (1" x 1" square tubing)
- Optional Rear Posts (For free floating partition applications)
- Ceiling Mounts, Wall Mounts, Floor or Counter Mounts

*Shelves will mount to the back wall but must be supported on the front/sides

1. Send us your drawing

Please be sure to include all adjacent walls, window and door casings, lower cabinets, surrounding artwork etc.

- We can provide a quote based on your drawing, finish selections and specified options.

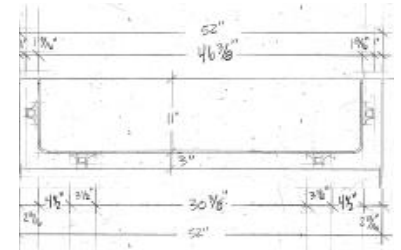
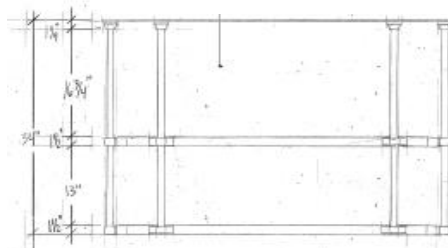

2. Select 2 Shelf Finishes

Kinley shelving comes standard with 1.5"H x 1/4" thick solid brass banding. Shelf banding is available in all 8 metal finishes. Shelf material is available in all wood panel finishes and most countertop finishes

- Choose a metal finish. Metal Finishes are divided into 2 price groups.
- Choose a shelf finish (any category A, B, C, D finish plus most Countertop finishes are available)

Metal Finishes

Group 1

- SB Satin Brass (lacquered)
- AB Antique Brass (lacquered)
- MB Matte Black (lacquered)
- OC Oil Can (lacquered)

Group 2

- BB Burnished Brass
- PN Polished Nickel
- SN Satin Nickel
- PC Polished Chrome

Shelf Finishes

- Category A** Paints and Stains
- Category B** Woods and Exotics
- Category C** Colors and Textures
- Category D** Automotive Finishes
- Stone** Carrara Marble
- Quartz** Pure White, Bianco, Calacatta
- Guildstone** White Matte and Gloss

3. Select Corner Detail

- Shelves are available with mitered corners or round corners
- Each corner of each shelf can be specified.
- Indicate (M) for mitered or (R) for Round on each shelf corner on drawing
- Shelves that butt against back walls are made with butted ends so shelf can be mounted to the wall

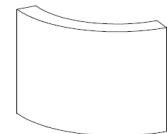
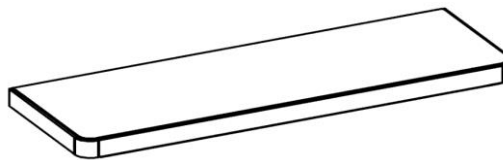

4. Add options

- Storage Cabinets
- Lighting
- Power Options
- Stemware
- Gallery Rails



Kinley Shelving

Kinley Shelving System Pricing

1. Price each shelf based on Size, Metal Finish, Shelf Finish
2. Add Round Corners, Shelf Brackets, Mounts, and Linear Ft of Posts
3. Add Options

Metal Finishes

Group 1

- SB Satin Brass (lacquered)
- AB Antique Brass (lacquered)
- MB Matte Black (lacquered)
- OC Oil Can (lacquered)

Group 2

- BB Burnished Brass Waxed
- PN Polished Nickel
- SN Satin Nickel
- PC Polished Chrome

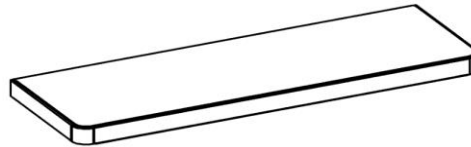

* Shelf shown with (2) Round Corner options

1. Kinley Shelf Pricing

Shelves are priced individually per chart below

Item # - [metal finish] - [shelf finish]

Group 1 Metal Finishes - pricing for shelves in group 1 metal finish combined with panel finish or countertop finish

Code - Add metal finish and shelf finish to item #. ex. KINSHF48-SB-B41

Item #	Description	A	B	C	D	GS-WM	GS-WG	QT-PW	BN/CL	ST-CR
KINSHF24-[METAL FIN]-[SHELF FIN]	up to 24"W x 22"D	770	840	700	1050	790	990	1090	1600	1200
KINSHF48-[METAL FIN]-[SHELF FIN]	up to 48"W x 22"D	1430	1560	1300	1950	1530	1930	1990	3000	2200
KINSHF72-[METAL FIN]-[SHELF FIN]	up to 72"W x 22"D	1980	2160	1800	2700	2140	2640	2490	3750	2800
KINSHF96-[METAL FIN]-[SHELF FIN]	up to 96"W x 22"D	2530	2760	2300	3450	2650	3350	3095	4600	N/A

Group 2 Metal Finishes - pricing for shelves in group 2 metal finish combined with panel finish or countertop finish

Add metal finish and shelf finish to item #. ex. KINSHF48-PN-B41

Item #	Description	A	B	C	D	GS-WM	GS-WG	QT-PW	BN/CL	ST-CR
KINSHF24-[METAL FIN]-[SHELF FIN]	up to 24"W x 22"D	1100	1160	1030	1380	1120	1320	1420	1930	1530
KINSHF48-[METAL FIN]-[SHELF FIN]	up to 48"W x 22"D	2100	2200	1950	2600	2180	2580	2640	3650	2850
KINSHF72-[METAL FIN]-[SHELF FIN]	up to 72"W x 22"D	2850	3030	2670	3570	3000	3500	3360	4600	3680
KINSHF96-[METAL FIN]-[SHELF FIN]	up to 96"W x 22"D	N/A	N/A	N/A	N/A	N/A	N/A	N/A	N/A	N/A

2. Kinley Bracket and Post Pricing

All Brackets, Mounts and Round Corners are priced each

Add total length of posts together and round up to nearest foot to figure total post price

Item # - [metal finish]

Item #	Description	Group 1	Group 2
KINRDCNR	Round Corner ea	130	180
KINSHBKT	Shelf Bracket ea	150	200
KINMTBKT	Mount Bracket ea	300	350
KINPST	1" Square Posts	50/ft	75/ft
KINPST90	90 Degree Post Weld	300	350

90 degree post welds are available to turn posts back into a support wall or to create horizontal bars

please send drawings so we can verify manufacturability

Round Corner

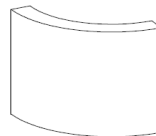

Shelf Bracket

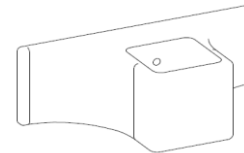

Mount Bracket

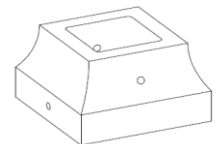

3. Kinley Shelving Options

Add these options to complete your shelving unit

All items must be added individually per shelf/bay

Please identify bay location for each option

Item #	Description	Group 1	Group 2	A	B	C	D
KINSTEM	Stemware holder	Quote	Quote	Quote	Quote	Quote	Quote
KINGRAIL	Gallery Rail	Quote	Quote	Quote	Quote	Quote	Quote
KINSHCAB	Storage Cabinet	Quote	Quote	Quote	Quote	Quote	Quote
Countertop	see countertop section of pricelist						



Fresco Shelving

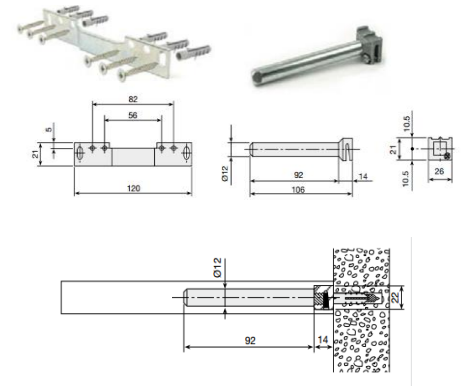

Shallow Floating Shelves up to 10"D

2" thick, solid top and solid bottom

Includes hidden mounting hardware, no blocking required

Item #	Description	A	B	C	D
SFLTSHF24	up to 24"W, 10"max depth	550	600	500	750
SFLTSHF48	up to 48"W, 10"max depth	770	840	700	1050
SFLTSHF72	up to 72"W, 10"max depth	1540	1680	1400	2100



Deep Floating Shelves up to 21.5"D

2" thick, solid top and open bottom

Hardware ordered separately

Requires Hidden Mounting Brackets below or support provided by other

Item #	Description	A	B	C	D
DFLTSHF24	up to 24"W, 21.5"max depth	695	795	645	995
DFLTSHF48	up to 48"W, 21.5"max depth	1145	1245	1045	1595
DFLTSHF72	up to 72"W, 21.5"max depth	1595	1745	1445	2195

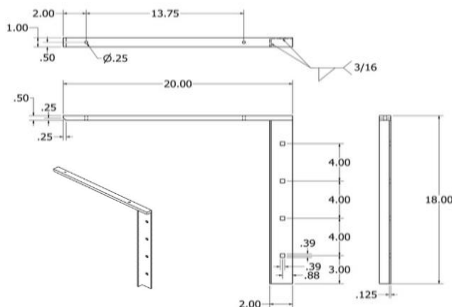

Hidden Mounting Brackets for Deep Floating Shelves

Requires installation behind sheetrock

Only mounts to right side of the stud when facing wall

Weight tested to 1100lb per pair

Item #	Description	List
CARARM-2	2 arms, req install inside wall	350
CARARM-3	3 arms, req install inside wall	450



Mirrors - 200 Series

200 Series Mirror Features

Includes heavy duty Z clip mounting hardware
All mirror is domestically made
Custom Sizing Available

Standard Installation

Mount mirrors using included
Shimming may be necessary on walls out of square/plumb

A-Paint - Matte

A30 White
A31 Black
A32 Nonchalant
A34 Robin Egg
A35 Vanilla
A36 Harbor Gray
A37 Silverstream
A38 Sable
A39 Navy Blue

A-Stain

A2 Normandy
A3 Briar
A4 Brandy
A6 Black Forest
A8 Tombstone
A20 Toffee
A21 Cocoa
A22 Driftwood

B-Wood

B39 English Walnut
B41 French Walnut
B42 Granite Walnut
B54 Cerused Oak
B57 Milk Oak
B58 Manhattan Oak
B59 Chocolate Oak
B60 White Oak
B61 Black Oak

Custom Color +10%
Glossy Top Coat +10%

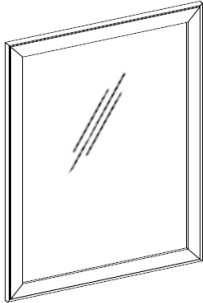

Beaded Face Frame Mirror

Item #	Size	A	B	Beveled
200-M-2032	20W x .75D x 32H	695	795	245
200-M-2632	26W x .75D x 32H	715	825	285
200-M-3232	32W x .75D x 32H	725	835	335

Section Views

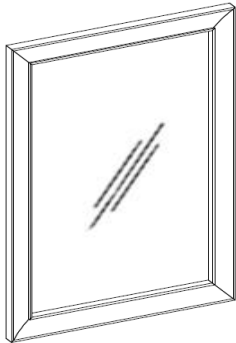
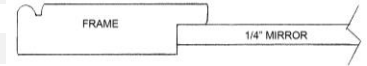

Cove Mirror

Item #	Size	A	B	Beveled
201-M-2036	20W x 1.25D x 36H	875	1025	265
201-M-2636	26W x 1.25D x 36H	925	1075	315
201-M-3236	32W x 1.25D x 36H	985	1125	365

Section Views

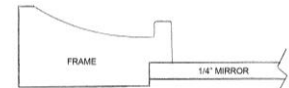

Mirrors - 400 Series

400 Series Mirror Features

Includes heavy duty Z clip mounting hardware
All mirror is domestically made
Custom Sizing Available

Design Specific Features

Grain direction runs long on front
Grain direction runs vertical on sides

Standard Installation

Mount mirrors using included
Shimming may be necessary on walls out of square/plumb

Wood Finishes

C-Color - Matte

C40 White Fenix
C41 Black Fenix
C42 Efeso Gray Fenix
C43 Londra Gray Fenix
C44 Bromo Gray Fenix
C46 Ottawa Beige Fenix

C-Color - High Gloss

C21 White Acrylic
C22 Black Acrylic
C26 Ivory Acrylic
C28 Lunar Gray Acrylic
C29 Graystone Acrylic
C30 Slate Gray Acrylic
C31 Iridium Silver Acrylic
C32 Champagne Acrylic
C33 Carbonite Acrylic

C-Tex -Texture

C60 Ashlin
C61 Barley
C62 Truffle
C63 Nimbus
C64 Russet
C65 Charred

B-Wood

B39 English Walnut
B41 French Walnut
B42 Granite Walnut
B54 Cerused Oak
B57 Milk Oak
B58 Manhattan Oak
B59 Chocolate Oak
B60 White Oak
B61 Black Oak

B-Exotic

B18 Rosewood
B22 Black Limba
B38 Quartered Walnut
B40 Natural Walnut
B47 Gray Reclaimed Oak
B48 Clear Reclaimed Oak
B49 Natural Reclaimed Oak

D-Auto - Automotive

D1 White Lacquer
D2 Black Lacquer
D10 Escalade Pearl
D11 Ocean Metallic
D13 Grey Metallic
D14 White Pearl
D16 Cappuccino
D17 Sea Serpent

Custom Paint Colors

Matte Paint C+10%
Glossy Paint C+20%
Polished Lacquer D+10%

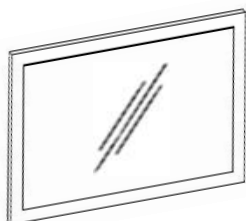

1.5" Frame - Mirror

Item#	Size	B	C	D
400-M15-2424	24W x .75D x 24H	1195	1095	1395
400-M15-3024	30W x .75D x 24H	1295	1195	1545
400-M15-3624	36W x .75D x 24H	1445	1295	1645
400-M15-4224	42W x .75D x 24H	1545	1445	1795
400-M15-4824	48W x .75D x 24H	1695	1595	1945



Metal Mirrors - 600 Series

600 Series Mirror Features

Welded brass and steel mirrors
Includes heavy duty Z clip mounting hardware
All mirror is domestically made
Custom Sizing Available

Standard Installation

Mount mirrors using included
Shimming may be necessary on walls out of square/plumb

Group 1

SB Satin Brass (lacquered)
AB Antique Brass (lacquered)
MB Matte Black (lacquered)
OC Oil Can (lacquered)

Group 2

BB Burnished Brass Waxed
PN Polished Nickel (plated over brass)
SN Satin Nickel
PC Polished Chrome *M1 ONLY

M2 Not Available in Polished Chrome

1" Frame - Mirror



Item#	Size	Group 1	Group 2
600-M1-1630	16W x 1D x 30H	1595	1970
600-M1-2030	20W x 1D x 30H	1645	2020
600-M1-2430	24W x 1D x 30H	1695	2070
600-M1-3030	30W x 1D x 30H	1745	2120
600-M1-3630	36W x 1D x 30H	1795	2170
600-M1-1640	16W x 1D x 40H	1695	2195
600-M1-2040	20W x 1D x 40H	1745	2245
600-M1-2440	24W x 1D x 40H	1795	2295
600-M1-3040	30W x 1D x 40H	1845	2345
600-M1-3640	36W x 1D x 40H	1895	2395

1/2"x 2" Frame - Mirror - NOT AVAILABLE IN POLISHED CHROME



Item#	Size	Group 1	Group 2
600-M2-1630	16W x 2D x 30H	1795	2170
600-M2-2030	20W x 2D x 30H	1845	2220
600-M2-2430	24W x 2D x 30H	1895	2270
600-M2-3030	30W x 2D x 30H	1945	2320
600-M2-3630	36W x 2D x 30H	1995	2370
600-M2-1640	16W x 2D x 40H	1895	2395
600-M2-2040	20W x 2D x 40H	1945	2445
600-M2-2440	24W x 2D x 40H	1995	2495
600-M2-3040	30W x 2D x 40H	2045	2545
600-M2-3640	36W x 2D x 40H	2095	2595

KINLEY MIRROR - Round Corners

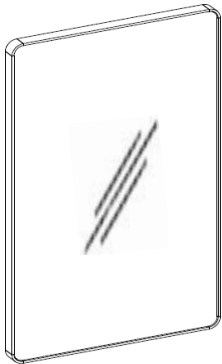

Item#	Size	Group 1	Group 2
600-M3-1630	16W x 1.5D x 30H	2145	2545
600-M3-2030	20W x 1.5D x 30H	2195	2595
600-M3-2430	24W x 1.5D x 30H	2295	2645
600-M3-3030	30W x 1.5D x 30H	2345	2695
600-M3-3630	36W x 1.5D x 30H	2395	2795
600-M3-1640	16W x 1.5D x 40H	2295	2795
600-M3-2040	20W x 1.5D x 40H	2345	2845
600-M3-2440	24W x 1.5D x 40H	2395	2895
600-M3-3040	30W x 1.5D x 40H	2445	2945
600-M3-3640	36W x 1.5D x 40H	2495	2995



Backlight Option for all Mirrors

3000K Warm white LED
LED housing is fully diffused
Requires a recessed, switched power outlet placed center of the mirror

Item #	Description	List
MIRBKLT	LED backlight	795



Furniture Guild Home

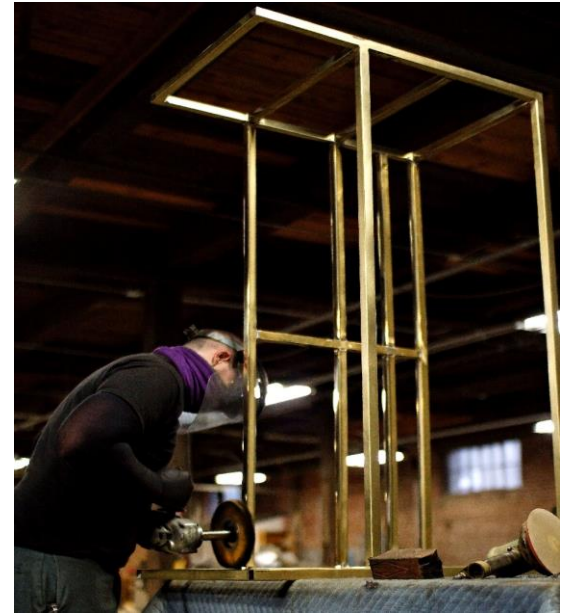

- Made in the USA, one at a time, in our factory
 - 10 Designs
 - Nightstands, Dressers, Armoires, Consoles
 - Several sizes for some configurations
 - Every piece is benchmade and signed by the craftsman
 - Lifetime Warranty
 - 200 Series - solid wood construction with finished interiors to match
 - 400 Series - substructure based construction with gray interior
 - 500 Series - mixed construction techniques with different finish compatibility.
 - 600 Series - designs are metal based designs
-
- Some Designs have a finish matched interior with matching dovetailed drawers utilizing Blum full extension, soft closing runners.
 - Some Designs use our Substructure Construction with Gray interior and Legrabox drawer system from Blum.





279 Barrett



Features

- Drawers and interior finished to match exterior
- Each piece made by hand and signed by craftsman
- Built using 3/4" PUREBOND furniture grade plywood
- BLUM full extension, soft close drawer runners
- Each piece made by hand and signed by the craftsman
- Countertops, decorative hardware and options are sold separately

How to Specify

- Furniture Code is item code plus wood finish code. Ex. 30" Barrett nightstand in A30 White = 279-5130-A30
- Add Countertop code from countertop section as separate line item
- Add Decorative Hardware with placement instructions
- Add Options with assignment instructions

Wood Finishes

A-Stain

- A2 Normandy
- A3 Briar
- A4 Brandy
- A6 Black Forest
- A8 Tombstone
- A20 Toffee
- A21 Cocoa
- A22 Driftwood

A-Paint - Matte

- A30 White
- A31 Black
- A32 Nonchalant
- A34 Robin Egg
- A35 Vanilla
- A36 Harbor Gray
- A37 Silverstream
- A38 Sable
- A39 Navy Blue

B-Wood

- B39 English Walnut
- B41 French Walnut
- B42 Granite Walnut
- B54 Cerused Oak
- B57 Milk Oak
- B58 Manhattan Oak
- B59 Chocolate Oak
- B60 White Oak
- B61 Black Oak

Custom Color A+10%
Glossy Top Coat A+10%

Suggested Hardware for Barrett



D-BAR - Solid Brass, Projection of 7/8"

- 6DBAR-[Finish] 6"cc Gp1 \$65, Gp2 \$70
- 8DBAR-[Finish] 8"cc Gp1 \$70, Gp2 \$80
- 12DBAR-[Finish] 12"cc Gp1 \$140, Gp2 \$155
- 18DBAR-[Finish] 18"cc GP1 \$200, Gp2 \$220



Metal Banding - 3/4" x 1/8" Solid Brass Banding

BAND1-[Finish]

Gp1 \$500 per panel, Gp2 \$650 per panel



Shown with optional WT-2.0

Barrett Closed Nightstand

3 drawers

Item#	Without Top	A	B	Suggested Countertop Pricing pg13			
				WT-A-.75	WT-A-2.0	WT-B-.75	WT-B-2.0
279-5124	24"W x 19"D x 28"H	2295	2795	495	745	545	795
279-5130	30"W x 19"D x 28"H	2395	2895	595	845	645	895
279-5136	36"W x 19"D x 28"H	2495	2995	695	945	745	995



Shown with optional WT-2.0

Barrett Open Nightstand

1 drawer

Item#	Without Top	A	B	Suggested Countertop Pricing pg13			
				WT-A-.75	WT-A-2.0	WT-A-.75	WT-A-2.0
279-5224	24"W x 19"D x 28"H	2045	2495	495	745	545	795
279-5230	30"W x 19"D x 28"H	2145	2595	595	845	645	895
279-5236	36"W x 19"D x 28"H	2245	2695	695	945	745	995

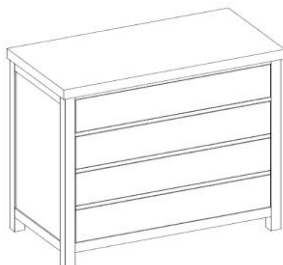

Shown with optional WT-2.0

Barrett 4 Drawer Dresser

4 drawers

Item#	Without Top	A	B	Suggested Countertop Pricing pg13			
				WT-A-.75	WT-A-2.0	WT-B-.75	WT-B-2.0
279-5342	42"W x 21"D x 42"H	4995	5995	795	1045	845	1145

*Countertops, Decorative Hardware and Options are not included and must be added separately

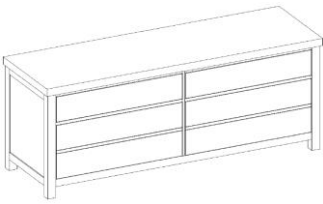

Shown with optional WT-2.0

Barrett 6 Drawer Dresser

6 drawers

Item#	Without Top	A	B	Suggested Countertop Pricing pg13			
				WT-A-.75	WT-A-2.0	WT-B-.75	WT-B-2.0
279-5672	72"W x 21"D x 33"H	6145	7345	1245	1595	1345	1745

Drawer Interior (6): 31¼"W x 17"D x 5¾"H

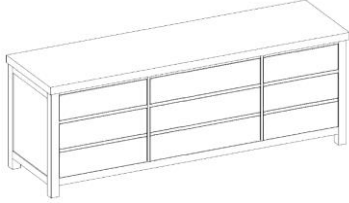

Shown with optional WT-2.0

Barrett 9 Drawer Dresser

9 drawers

Item#	Without Top	A	B	Suggested Countertop Pricing pg13			
				WT-A-.75	WT-A-2.0	WT-B-.75	WT-B-2.0
279-5778	78"W x 21"D x 33"H	6945	8345	1345	1695	1445	1845

Drawer Interior (9): 23"W x 17¼"D x 6"H

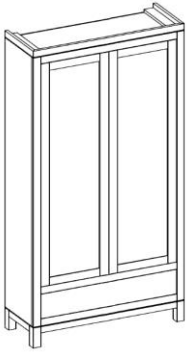

Barrett Armoire

2 doors, 1 drawer, 4 adjustable shelves

Item#	Including Frieze	A	B
279-5945	45"W x 24"D x 84"H	7495	8995

Interior: 41¼"W x 22"D x 65"H
Maximum TV Size: 42", 416 lbs.

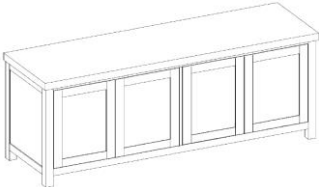

Shown with optional WT-2.0

Barrett 4 Door Media Console

4 doors

Item#	Without Top	A	B	Suggested Countertop Pricing pg13			
				WT-A-.75	WT-A-2.0	WT-B-.75	WT-B-2.0
279-7172	72"W x 18"D x 30"H	5995	7195	1245	1595	1345	1745

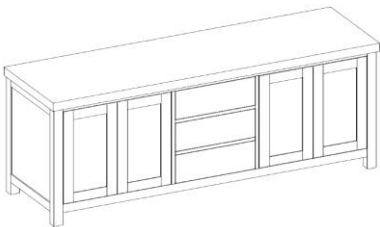

Shown with optional WT-2.0

Barrett 4-Door Media Console with Drawers

4 doors, 3 drawers

Item#	Without Top	A	B	Suggested Countertop Pricing pg13			
				WT-A-.75	WT-A-2.0	WT-B-.75	WT-B-2.0
279-7284	84"W x 18"D x 30"H	6945	8345	1445	1795	1545	1995

*Countertops, Decorative Hardware and Options are not included and must be added separately



290 Hayden



Features

- Drawers and interior finished to match exterior
- Each piece made by hand and signed by craftsman
- Built using 3/4" PUREBOND furniture grade plywood
- BLUM full extension, soft close drawer runners
- Each piece made by hand and signed by the craftsman
- Countertops, decorative hardware and options are sold separately

How to Specify

- Furniture Code is item code plus wood finish code. Ex. 30" Hayden nightstand in A30 White = 290-5130-A30
- Add Countertop code from countertop section as separate line item
- Add Decorative Hardware with placement instructions
- Add Options with assignment instructions

Wood Finishes

A-Stain

- A2 Normandy
- A3 Briar
- A4 Brandy
- A6 Black Forest
- A8 Tombstone
- A20 Toffee
- A21 Cocoa
- A22 Driftwood

A-Paint - Matte

- A30 White
- A31 Black
- A32 Nonchalant
- A34 Robin Egg
- A35 Vanilla
- A36 Harbor Gray
- A37 Silverstream
- A38 Sable
- A39 Navy Blue

B-Wood

- B39 English Walnut
- B41 French Walnut
- B42 Granite Walnut
- B54 Cerused Oak
- B57 Milk Oak
- B58 Manhattan Oak
- B59 Chocolate Oak
- B60 White Oak
- B61 Black Oak

Custom Color A+10%
Glossy Top Coat A+10%

Suggested Hardware for Hayden



Round Cap Feet
RDCAP-[Finish] \$70 ea



3" Square Ring Pull
3SQRING-[Finish] \$90 ea



3" Round Ring Pull
3RDRING-[Finish] \$90 ea



Brass Banding - 3/4" x 1/8"
BAND1-[Finish]
Gp1 \$500 per panel, Gp2 \$650 per panel



3" Recessed Square Knob
RSKNOB-[Finish]
Gp1 \$350, Gp2 \$400



3" Recessed Square Knob
RRKNOB-[Finish]
Gp1 \$350, Gp2 \$400



Shown with optional WT-2.0

Hayden Closed Nightstand

3 drawers

Item#	Without Top	A	B	Suggested Countertop Pricing pg13			
				WT-A-.75	WT-A-2.0	WT-B-.75	WT-B-2.0
290-5124	24"W x 19"D x 28"H	2195	2695	495	745	545	795
290-5130	30"W x 19"D x 28"H	2295	2795	595	845	645	895
290-5136	36"W x 19"D x 28"H	2395	2845	695	945	745	995



Shown with optional WT-2.0

Hayden Open Nightstand

1 drawer

Item#	Without Top	A	B	Suggested Countertop Pricing pg13			
				WT-A-.75	WT-A-2.0	WT-B-.75	WT-B-2.0
290-5224	24"W x 19"D x 28"H	1995	2445	495	745	545	795
290-5230	30"W x 19"D x 28"H	2095	2545	595	845	645	895
290-5236	36"W x 19"D x 28"H	2195	2645	695	945	745	995



Shown with optional WT-2.0

Hayden 4 Drawer Dresser

4 drawers

Item#	Without Top	A	B	Suggested Countertop Pricing pg13			
				WT-A-.75	WT-A-2.0	WT-B-.75	WT-B-2.0
290-5342	42"W x 21"D x 42"H	4795	5695	795	1045	845	1145

*Countertops, Decorative Hardware and Options are not included and must be added separately

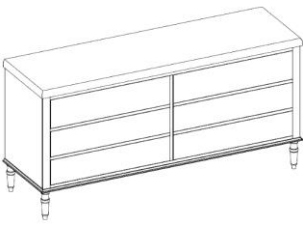

Shown with optional GS-2OG top

Hayden 6 Drawer Dresser

6 drawers

Item#	Without Top	A	B	Suggested Countertop Pricing pg13			
				WT-A-.75	WT-A-2.0	WT-B-.75	WT-B-2.0
290-5672	72"W x 21"D x 33"H	5895	6995	1245	1595	1345	1745

Drawer Interior (6): 31¼"W x 17"D x 5¾"H

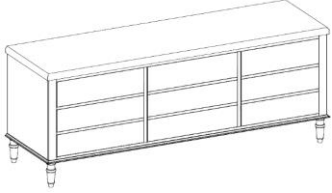

Shown with optional GS-2OG top

Hayden 9 Drawer Dresser

9 drawers

Item#	Without Top	A	B	Suggested Countertop Pricing pg13			
				WT-A-.75	WT-A-2.0	WT-B-.75	WT-B-2.0
290-5778	78"W x 21"D x 33"H	6695	7895	1345	1695	1445	1845

Drawer Interior (9): 23"W x 17¼"D x 6"H

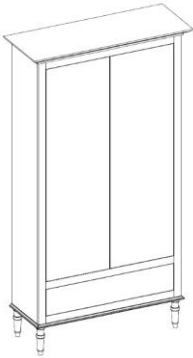

Hayden Armoire

2 doors, 1 drawer, 4 adjustable shelves

Item#	Including Top	A	B

Interior: 41¼"W x 22"D x 65"H

Maximum TV Size: 42", 416 lbs.

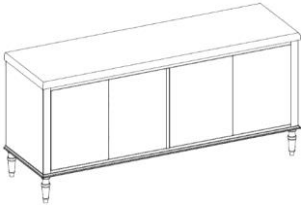

Shown with optional GS-2OG top

Hayden 4 Door Media Console

4 doors

Item#	Without Top	A	B	Suggested Countertop Pricing pg13			
				WT-A-.75	WT-A-2.0	WT-B-.75	WT-B-2.0
290-7172	72"W x 18"D x 30"H	5745	6845	1245	1595	1345	1745

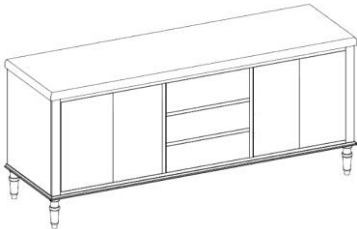

Shown with optional GS-2OG top

Hayden 4-Door Media Console with Drawers

4 doors, 3 drawers

Item#	Without Top	A	B	Suggested Countertop Pricing pg13			
				WT-A-.75	WT-A-2.0	WT-B-.75	WT-B-2.0
290-7284	84"W x 18"D x 30"H	6695	7995	1445	1795	1545	1995

*Countertops, Decorative Hardware and Options are not included and must be added separately



292 Henley



Features

- Includes 1/4" metal inlay on doors and drawers
- Includes 3/4" metal trim around base.
- Hardware and Cap feet sold separately.
- Drawers and interior finished to match exterior
- Built using 3/4" PUREBOND furniture grade plywood
- BLUM full extension, soft close drawer runners
- BLUM 120 degree, soft closing doors
- Each piece made by hand and signed by the craftsman

How to Specify

- Furniture Code is item code plus metal and wood finish code. Ex. 30" Henley nightstand in Burnished Brass and A30 White = 292-5130-BB-A30
- Add Countertop code from countertop section as separate line item
- Add Decorative Hardware with placement instructions
- Add Options with assignment instructions

Metal Finishes

Group 1

- SB Satin Brass (lacquered)
- AB Antique Brass (lacquered)
- MB Matte Black (lacquered)
- OC Oil Can (lacquered)

Group 2

- BB Burnished Brass Waxed
- PN Polished Nickel
- SN Satin Nickel
- PC Polished Chrome

Wood Finishes

A-Stain

- A2 Normandy
- A3 Briar
- A4 Brandy
- A6 Black Forest
- A8 Tombstone
- A20 Toffee
- A21 Cocoa
- A22 Driftwood

A-Paint - Matte

- A30 White
- A31 Black
- A32 Nonchalant
- A34 Robin Egg
- A35 Vanilla
- A36 Harbor Gray
- A37 Silverstream
- A38 Sable
- A39 Navy Blue

B-Wood

- B39 English Walnut
- B41 French Walnut
- B42 Granite Walnut
- B54 Cerused Oak
- B57 Milk Oak
- B58 Manhattan Oak
- B59 Chocolate Oak
- B60 White Oak
- B61 Black Oak

Custom Color A+10%
Glossy Top Coat A+10%

Suggested Hardware for Henley



Square Cap Feet
SQCAP-[Finish] \$70 ea



3" Square Ring Pull
3SQRING-[Finish] \$90 ea



3" Round Ring Pull
3RRRING-[Finish] \$90 ea



Brass Banding - 3/4" x 1/8"
BAND1-[Finish]
Gp1 \$500 per panel, Gp2 \$650 per panel



3" Recessed Square Knob
RSKNOB-[Finish]
Gp1 \$350, Gp2 \$400



3" Recessed Square Knob
RRKNOB-[Finish]
Gp1 \$350, Gp2 \$400



Shown with optional WT-.75

Henley Closed Nightstand

3 drawers

Item#	Without Top	Group 1		Group 2		Countertop Pricing page 13		
		A	B	A	B	WT-A-.75	WT-B-.75	ST-1.2
292-5124	24"W x 19"D x 28"H	2845	3245	3345	3745	495	545	795
292-5130	30"W x 19"D x 28"H	2895	3345	3495	3895	595	645	945
292-5136	36"W x 19"D x 28"H	2995	3445	3695	4145	695	745	1145



Shown with optional WT-.75

Henley Open Nightstand

1 drawer

Item#	Without Top	Group 1		Group 2		Countertop Pricing page 13		
		A	B	A	B	WT-A-.75	WT-B-.75	ST-1.2
292-5224	24"W x 19"D x 28"H	2495	2945	3045	3395	495	545	795
292-5230	30"W x 19"D x 28"H	2595	2995	3145	3495	595	645	945
292-5236	36"W x 19"D x 28"H	2695	3095	3345	3745	695	745	1145



Shown with optional WT-.75

Henley 4 Drawer Dresser

4 drawers

Item#	Without Top	Group 1		Group 2		Countertop Pricing page 13		
		A	B	A	B	WT-A-.75	WT-B-.75	ST-1.2
292-5342	42"W x 21"D x 42"H	5995	6895	7395	8295	795	845	1245

*Countertops, Decorative Hardware and Options are not included and must be added separately

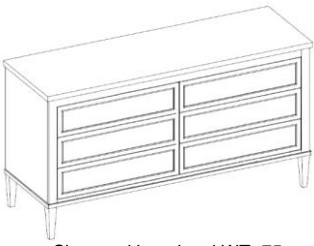

Shown with optional WT-.75

Henley 6 Drawer Dresser

6 drawers

Item#	Without Top	Group 1		Group 2		Countertop Pricing page 13		
		A	B	A	B	WT-A-.75	WT-B-.75	ST-1.2
292-5672	72"W x 21"D x 33"H	7345	8445	9045	10145	1245	1345	2095

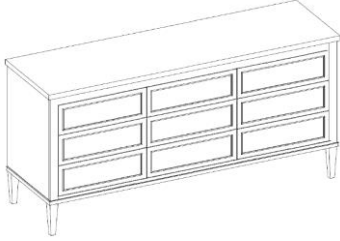

Shown with optional WT-.75

Henley 9 Drawer Dresser

9 drawers

Item#	Without Top	Group 1		Group 2		Countertop Pricing page 13		
		A	B	A	B	WT-A-.75	WT-B-.75	ST-1.2
292-5778	78"W x 21"D x 33"H	8345	9595	10295	11545	1345	1445	2245

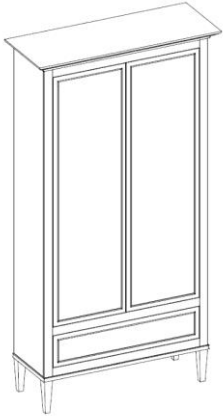

Henley Armoire

2 doors, 1 drawer, 4 adjustable shelves

Item#	Including Top	Group 1		Group 2	
		A	B	A	B
292-5945	45"W x 24"D x 84"H	8995	10345	11095	12445

Interior: 41¼"W x 22"D x 65"H
Maximum TV Size: 42", 416 lbs.

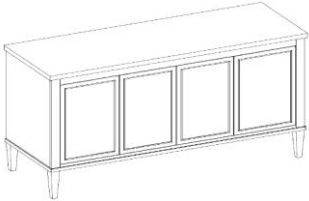

Shown with optional WT-.75

Henley 4 Door Media Console

4 doors

Item#	Without Top	Group 1		Group 2		Countertop Pricing page 13		
		A	B	A	B	WT-A-.75	WT-B-.75	ST-1.2
292-7172	72"W x 18"D x 30"H	7195	8295	8895	9945	1245	1345	2095

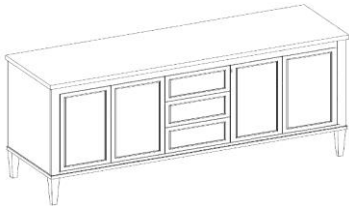

Shown with optional WT-.75

Henley 4-Door Media Console with Drawers

4 doors, 2 drawers

Item#	Without Top	Group 1		Group 2		Countertop Pricing page 13		
		A	B	A	B	WT-A-.75	WT-B-.75	ST-1.2
292-7284	84"W x 18"D x 30"H	8395	9645	10345	11595	1445	1545	2395

*Countertops, Decorative Hardware and Options are not included and must be added separately



295 Edwin



Features

- Includes Metal Base made from 1" x 1" solid brass tubing
- Drawers and interior finished to match exterior
- Built using 3/4" PUREBOND furniture grade plywood
- BLUM full extension, soft close drawer runners
- BLUM 120 degree, soft closing doors
- Each piece made by hand and signed by the craftsman

How to Specify

- Furniture Code is item code plus metal and wood finish code. Ex. 30" Edwin nightstand in Burnished Brass and A30 White = 295-5130-BB-A30
- Add Countertop code from countertop section as separate line item
- Add Decorative Hardware with placement instructions
- Add Options with assignment instructions

Metal Finishes

Group 1

- SB Satin Brass (lacquered)
- AB Antique Brass (lacquered)
- MB Matte Black (lacquered)
- OC Oil Can (lacquered)

Group 2

- BB Burnished Brass Waxed
- PN Polished Nickel
- SN Satin Nickel
- PC Polished Chrome

Wood Finishes

A-Stain

- A2 Normandy
- A3 Briar
- A4 Brandy
- A6 Black Forest
- A8 Tombstone
- A20 Toffee
- A21 Cocoa

A-Paint - Matte

- A30 White
- A31 Black
- A32 Nonchalant
- A34 Robin Egg
- A35 Vanilla
- A36 Harbor Gray
- A37 Silverstream
- A38 Sable
- A39 Navy Blue

B-Wood

- B39 English Walnut
- B41 French Walnut
- B42 Granite Walnut
- B54 Cerused Oak
- B57 Milk Oak
- B58 Manhattan Oak
- B59 Chocolate Oak
- B60 White Oak
- B61 Black Oak

Custom Color A+10%
Glossy Top Coat A+10%

Suggested Hardware for Edwin



11" Recessed Bar Pull

11RBAR-[Finish]

Gp1 \$600 ea, Gp2 \$700 ea



3" Square Ring Pull

3SQRING-[Finish] \$90 ea



3" Round Ring Pull

3RRRING-[Finish] \$90 ea



Brass Banding - 3/4" x 1/8"

BAND1-[Finish]

Gp1 \$500 per panel, Gp2 \$650 per panel



3" Recessed Square Knob

RSKNOB-[Finish]

Gp1 \$350, Gp2 \$400



3" Recessed Round Knob

RRKNOB-[Finish]

Gp1 \$350, Gp2 \$400



Shown with optional ST-1.2

Edwin Closed Nightstand

3 drawers

Item#	Without Top	Group 1		Group 2		Countertop Pricing page 13		
		A	B	A	B	WT-A-.75	WT-B-.75	ST-1.2
295-5124	24"W x 19"D x 28"H	3245	3695	3495	3945	495	545	795
295-5130	30"W x 19"D x 28"H	3345	3845	3595	4045	595	645	945
295-5136	36"W x 19"D x 28"H	3395	3895	3695	4195	695	745	1145



Shown with optional ST-1.2

Edwin Open Nightstand

1 drawer

Item#	Without Top	Group 1		Group 2		Countertop Pricing page 13		
		A	B	A	B	WT-A-.75	WT-B-.75	ST-1.2
295-5224	24"W x 19"D x 28"H	2945	3345	3145	3545	495	545	795
295-5230	30"W x 19"D x 28"H	2995	3445	3245	3645	595	645	945
295-5236	36"W x 19"D x 28"H	3045	3495	3345	3795	695	745	1145

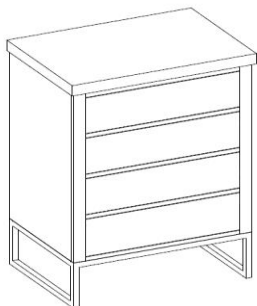

Shown with optional ST-1.2

Edwin 4 Drawer Dresser

4 drawers

Item#	Without Top	Group 1		Group 2		Countertop Pricing page 13		
		A	B	A	B	WT-A-.75	WT-B-.75	ST-1.2
295-5342	42"W x 21"D x 42"H	6795	7795	7395	8395	795	845	1245

*Countertops, Decorative Hardware and Options are not included and must be added separately

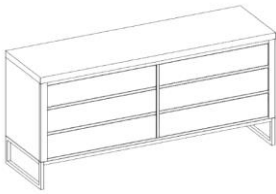

Shown with optional ST-1.2

Edwin 6 Drawer Dresser

6 drawers

Item#	Without Top	Group 1		Group 2		Countertop Pricing page 13		
		A	B	A	B	WT-A-.75	WT-B-.75	ST-1.2
295-5672	72"W x 21"D x 33"H	8345	9545	9045	10295	1245	1345	2095

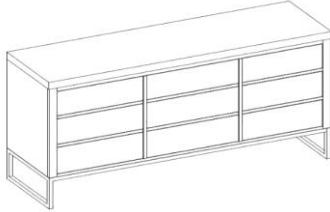

Shown with optional ST-1.2

Edwin 9 Drawer Dresser

9 drawers

Item#	Without Top	Group 1		Group 2		Countertop Pricing page 13		
		A	B	A	B	WT-A-.75	WT-B-.75	ST-1.2
295-5778	78"W x 21"D x 33"H	9445	10845	10295	11695	1345	1445	2245

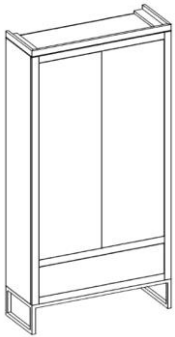

Edwin Armoire

2 doors, 1 drawer, 4 adjustable shelves

Item#	With Frieze	Group 1		Group 2	
		A	B	A	B
295-5945	45"W x 24"D x 84"H	10195	11695	11095	12595

Interior: 41¼"W x 22"D x 65"H

Maximum TV Size: 42", 416 lbs.

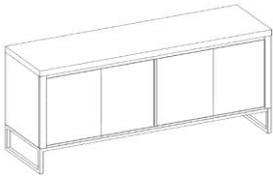

Shown with optional ST-1.2

Edwin 4 Door Media Console

4 doors

Item#	Without Top	Group 1		Group 2		Countertop Pricing page 13		
		A	B	A	B	WT-A-.75	WT-B-.75	ST-1.2
295-7172	72"W x 18"D x 30"H	8145	9345	8895	10095	1245	1345	2095

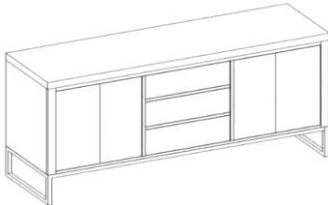

Shown with optional ST-1.2

Edwin 4-Door Media Console with Drawers

4 doors, 3 drawers

Item#	Without Top	Group 1		Group 2		Countertop Pricing page 13		
		A	B	A	B	WT-A-.75	WT-B-.75	ST-1.2
295-7284	84"W x 18"D x 30"H	9495	10895	10345	11745	1445	1545	2395

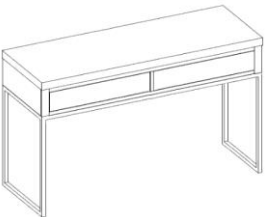

Shown with optional ST-1.2

Edwin Hall Console

2 drawer

Item#	Without Top	Group 1		Group 2		Countertop Pricing page 13		
		A	B	A	B	WT-A-.75	WT-B-.75	ST-1.2
295-7548	48"W x 16"D x 30"H	4145	4695	4395	4995	895	945	1445
295-7560	60"W x 16"D x 30"H	4195	4845	4545	5095	1045	1145	1745
295-7572	72"W x 16"D x 30"H	4295	4895	4695	5345	1245	1345	2095

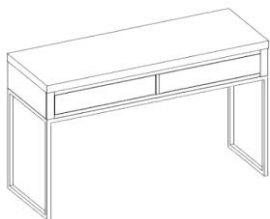

Shown with optional ST-1.2

Edwin Writing Desk

2 drawer

Item#	Without Top	Group 1		Group 2		Countertop Pricing page 13		
		A	B	A	B	WT-A-.75	WT-B-.75	ST-1.2
295-7648	48"W x 30"D x 30"H	4445	5045	4745	5345	895	945	1445
295-7660	60"W x 30"D x 30"H	4495	5195	4895	5495	1045	1145	1745
295-7672	72"W x 30"D x 30"H	4595	5245	5045	5695	1245	1345	2095

*Countertops, Decorative Hardware and Options are not included and must be added separately



406 Riva



Features

- Full Overlay - Door/Drawer reveal is on the side
- Grain Direction is Horizontal on Fronts
- Grain Direction is Vertical on Sides
- Interior Substructure is dark gray 3/4" PureBond plywood
- Blum Legrabox full extension, soft close drawer runners
- Each piece made by hand and signed by the craftsman

How to Specify

- Furniture Code is item code plus wood finish code. Ex. 30" Riva nightstand in C60 Ashlin = 406-5124-C60
- Add Countertop code from countertop section as separate line item
- Add Decorative Hardware with placement instructions
- Add Options with assignment instructions

Wall Mounted Installation

- Blocking between studs with a 2x6 is recommended.
- Once shimmed plumb and level, secure with 2.5" screws/lag bolts across the top and bottom of cabinet

Wood Finishes

C-Color - Matte

- C40 White Fenix
- C41 Black Fenix
- C42 Efeso Gray Fenix
- C43 Londra Gray Fenix
- C44 Bromo Gray Fenix
- C46 Ottawa Beige Fenix

Custom Paint Colors

- Matte Paint C+10%
- Glossy Paint C+20%
- Polished Lacquer D+10%

C-Color - High Gloss

- C21 White Acrylic
- C22 Black Acrylic
- C26 Ivory Acrylic
- C28 Lunar Gray Acrylic
- C29 Graystone Acrylic
- C30 Slate Gray Acrylic
- C31 Iridium Silver Acrylic
- C32 Champagne Acrylic
- C33 Carbonite Acrylic

C-TEX -Texture

- C60 Ashlin
- C61 Barley
- C62 Truffle
- C63 Nimbus
- C64 Russet
- C65 Charred

B-Wood

- B39 English Walnut
- B41 French Walnut
- B42 Granite Walnut
- B54 Cerused Oak
- B57 Milk Oak
- B58 Manhattan Oak
- B59 Chocolate Oak
- B60 White Oak
- B61 Black Oak

B-Exotic

- B18 Rosewood
- B22 Black Limba
- B38 Quartered Walnut
- B40 Natural Walnut
- B47 Gray Reclaimed Oak
- B48 Clear Reclaimed Oak
- B49 Natural Reclaimed Oak

D-Auto - Automotive

- D1 White Lacquer
- D2 Black Lacquer
- D10 Escalade Pearl
- D11 Ocean Metallic
- D13 Grey Metallic
- D14 White Pearl
- D16 Cappuccino
- D17 Sea Serpent

Suggested Hardware for Riva - see page 4 for all available options



3" Recessed Square Knob

RSKNOB-[Finish]
Gp1 \$350, Gp2 \$400



11" Recessed Bar Pull

11RBAR-[Finish]
Gp1 \$600 ea, Gp2 \$700 ea



D-BAR - Solid Brass, Projection of 7/8"

6DBAR-[Finish] 6"cc Gp1 \$65, Gp2 \$70
8DBAR-[Finish] 8"cc Gp1 \$70, Gp2 \$80
12DBAR-[Finish] 12"cc Gp1 \$140, Gp2 \$155
18DBAR-[Finish] 18"cc Gp1 \$200, Gp2 \$220



Metal Banding - 3/4" x 1/8" Brass Banding

BAND1-[Finish]
Gp1 \$500 per panel, Gp2 \$650 per panel

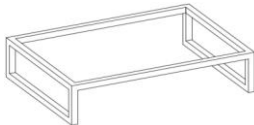

Metal Bases

Turn this design into a freestanding design with a metal base. See available designs and finishes in Options section.



Metal Frame - Drawer and Door Surround

FRAME1-[Finish] 1" Wide Frame
FRAME2-[Finish] 1/2" Wide Frame

Gp1 \$500 per panel, Gp2 \$650 per panel

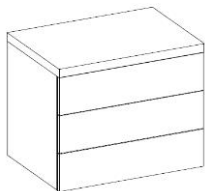

Riva Closed Nightstand

3 drawers

Designed to be Wall Mounted with 4" below

Suggested Countertop Pricing page 13

Item#	Without Top	B	C	D	WT-B-.75	WT-B-2.0	WT-C-.75	WT-C-2.0
406-5124	24"W x 19"D x 24"H	2545	2045	2995	545	795	445	645
406-5130	30"W x 19"D x 24"H	2595	2095	3145	645	895	545	745
406-5136	36"W x 19"D x 24"H	2645	2145	3345	745	995	645	845

Shown with optional WT-2.0

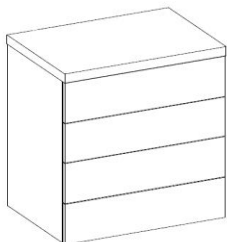

Riva 4 Drawer Dresser

4 drawers

Designed to be Wall Mounted with 4" below

Suggested Countertop Pricing page 13

Item#	Without Top	B	C	D	WT-B-.75	WT-B-2.0	WT-C-.75	WT-C-2.0
406-5342	42"W x 21"D x 38"H	5295	4295	6695	845	1145	695	945

Shown with optional WT-2.0

*Countertops, Decorative Hardware and Options are not included and must be added separately

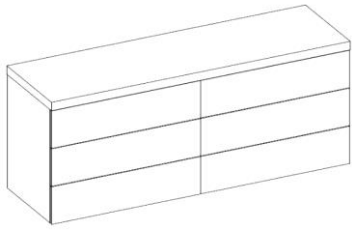

Shown with optional WT-2.0

Riva 6 Drawer Dresser

Designed to be Wall Mounted with 4" below

6 drawers

Suggested Countertop Pricing page 13

Item#	Without Top	B	C	D	WT-B-.75	WT-B-2.0	WT-C-.75	WT-C-2.0
406-5672	72"W x 21"D x 29"H	6495	5245	8195	1345	1745	1145	1445

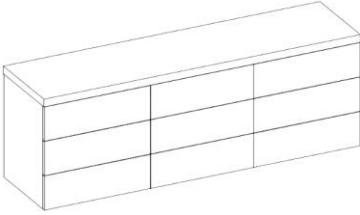

Shown with optional WT-2.0

Riva 9 Drawer Dresser

Designed to be Wall Mounted with 4" below

9 drawers

Suggested Countertop Pricing page 13

Item#	Without Top	B	C	D	WT-B-.75	WT-B-2.0	WT-C-.75	WT-C-2.0
406-5778	78"W x 21"D x 29"H	7345	5995	9295	1445	1845	1195	1545

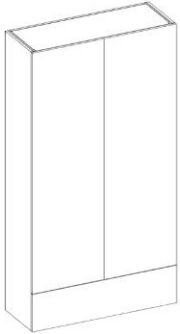

Riva Armoire

2 doors, 1 drawer, 4 adjustable shelves

Designed to be Wall Mounted with 4" below

Item#	Without Top	B	C	D
406-5945	45"W x 24"D x 80"H	7945	6445	9995

Interior: 41 1/4"W x 22"D x 65"H
Maximum TV Size: 42", 416 lbs.

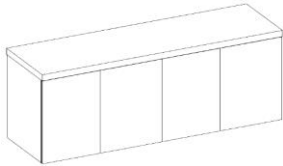

Shown with optional WT-2.0

Riva 4 Door Media Console

Designed to be Wall Mounted with 4" below

4 doors

Suggested Countertop Pricing page 13

Item#	Without Top	B	C	D	WT-B-.75	WT-B-2.0	WT-C-.75	WT-C-2.0
406-7172	72"W x 18"D x 26"H	6345	5145	8045	1345	1745	1145	1445

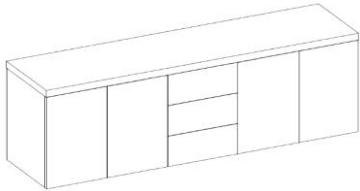

Shown with optional WT-2.0

Riva 4-Door Media Console with Drawers

Designed to be Wall Mounted with 4" below

4 doors, 3 drawers

Suggested Countertop Pricing page 13

Item#	Without Top	B	C	D	WT-B-.75	WT-B-2.0	WT-C-.75	WT-C-2.0
406-7284	84"W x 18"D x 26"H	7395	5995	9345	1545	1995	1295	1645

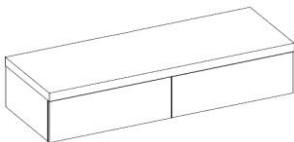

Shown with optional WT-2.0

Riva Floating Console

Designed to be Wall Mounted

2 drawer

Suggested Countertop Pricing page 13

Item#	Without Top	B	C	D	WT-B-.75	WT-B-2.0	WT-C-.75	WT-C-2.0
406-7548	48"W x 16"D x 10"H	3195	2545	3745	945	1245	795	1045
406-7560	60"W x 16"D x 10"H	3245	2645	3945	1145	1495	945	1245
406-7572	72"W x 16"D x 10"H	3295	2695	4195	1345	1745	1145	1445

*Countertops, Decorative Hardware and Options are not included and must be added separately



430 Fresco



Features

- Inset - Door/Drawer reveal is on the front
- Grain Direction is Vertical on Configs with Doors
- Grain Direction is Horizontal on All-Drawer Configs
- Grain Direction is Vertical on 2" Side Panels
- 2" Thick End Panels
- 7"H Toekick
- Interior Substructure is dark gray 3/4" PureBond plywood
- Blum Legrabox full extension, soft close drawer runners
- Each piece made by hand and signed by the craftsman

How to Specify

- Furniture Code is item code plus wood finish code. Ex. 30" Fresco nightstand in C60 Ashlin = 430-5130-C60
- Add Countertop code from countertop section as separate line item
- Add Decorative Hardware with placement instructions
- Add Options with assignment instructions

Wood Finishes

C-Color - Matte

- C40 White Fenix
- C41 Black Fenix
- C42 Efeso Gray Fenix
- C43 Londra Gray Fenix
- C44 Bromo Gray Fenix
- C46 Ottawa Beige Fenix

Custom Paint Colors

- Matte Paint C+10%
- Glossy Paint C+20%
- Polished Lacquer D+10%

C-Color - High Gloss

- C21 White Acrylic
- C22 Black Acrylic
- C26 Ivory Acrylic
- C28 Lunar Gray Acrylic
- C29 Graystone Acrylic
- C30 Slate Gray Acrylic
- C31 Iridium Silver Acrylic
- C32 Champagne Acrylic
- C33 Carbonite Acrylic

C-TEX -Texture

- C60 Ashlin
- C61 Barley
- C62 Truffle
- C63 Nimbus
- C64 Russet
- C65 Charred

B-Wood

- B39 English Walnut
- B41 French Walnut
- B42 Granite Walnut
- B54 Cerused Oak
- B57 Milk Oak
- B58 Manhattan Oak
- B59 Chocolate Oak
- B60 White Oak
- B61 Black Oak

B-Exotic

- B18 Rosewood
- B22 Black Limba
- B38 Quartered Walnut
- B40 Natural Walnut
- B47 Gray Reclaimed Oak
- B48 Clear Reclaimed Oak
- B49 Natural Reclaimed Oak

D-Auto - Automotive

- D1 White Lacquer
- D2 Black Lacquer
- D10 Escalade Pearl
- D11 Ocean Metallic
- D13 Grey Metallic
- D14 White Pearl
- D16 Cappuccino
- D17 Sea Serpent

Suggested Hardware for Fresco



3" Recessed Square Knob

RSKNOB-[Finish]

Gp1 \$350ea, Gp2 \$400ea



11" Recessed Bar Pull

11RBAR-[Finish]

Gp1 \$600 ea, Gp2 \$700 ea



D-BAR - Solid Brass, Projection of 7/8"

- 6DBAR-[Finish] 6"cc Gp1 \$65, Gp2 \$70
- 8DBAR-[Finish] 8"cc Gp1 \$70, Gp2 \$80
- 12DBAR-[Finish] 12"cc Gp1 \$140, Gp2 \$155
- 18DBAR-[Finish] 18"cc Gp1 \$200, Gp2 \$220



Metal Banding - 3/4" x 1/8" Brass Banding

BAND1-[Finish]

Gp1 \$500 per panel, Gp2 \$650 per panel

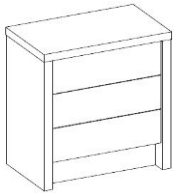

Shown with optional WT-2.0

Fresco Closed Nightstand

3 drawers

Item#	Without Top	B	C	D	Suggested Countertop Pricing page 13			
					WT-B-.75	WT-B-2.0	WT-C-.75	WT-C-2.0
430-5124	24"W x 19"D x 28"H	3145	2595	3795	545	795	445	645
430-5130	30"W x 19"D x 28"H	3195	2645	3945	645	895	545	745
430-5136	36"W x 19"D x 28"H	3295	2745	4045	745	995	645	845

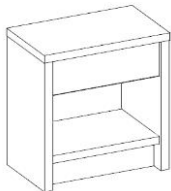

Shown with optional WT-2.0

Fresco Open Nightstand

1 drawer

Item#	Without Top	B	C	D	Suggested Countertop Pricing page 13			
					WT-B-.75	WT-B-2.0	WT-C-.75	WT-C-2.0
430-5224	24"W x 19"D x 28"H	2845	2345	3395	545	795	445	645
430-5230	30"W x 19"D x 28"H	2895	2395	3545	645	895	545	745
430-5236	36"W x 19"D x 28"H	2995	2495	3645	745	995	645	845

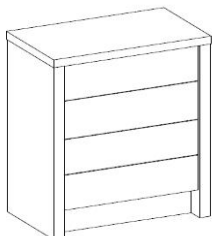

Shown with optional WT-2.0

Fresco 4 Drawer Dresser

4 drawers

Item#	Without Top	B	C	D	Suggested Countertop Pricing page 13			
					WT-B-.75	WT-B-2.0	WT-C-.75	WT-C-2.0
430-5342	42"W x 21"D x 42"H	6595	5495	8095	845	1145	695	945

*Countertops, Decorative Hardware and Options are not included and must be added separately

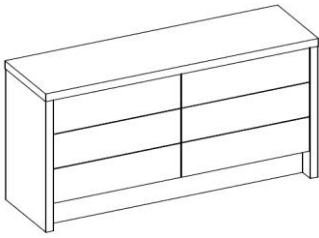

Shown with optional WT-2.0

Fresco 6 Drawer Dresser

6 drawers

Suggested Countertop Pricing page 13

Item#	Without Top	B	C	D	WT-B-.75	WT-B-2.0	WT-C-.75	WT-C-2.0
430-5672	72"W x 21"D x 33"H	8095	6745	9895	1345	1745	1145	1445

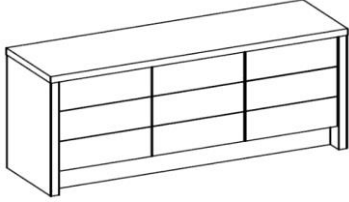

Shown with optional WT-2.0

Fresco 9 Drawer Dresser

9 drawers

Suggested Countertop Pricing page 13

Item#	Without Top	B	C	D	WT-B-.75	WT-B-2.0	WT-C-.75	WT-C-2.0
430-5778	78"W x 21"D x 33"H	9145	7645	11245	1445	1845	1195	1545

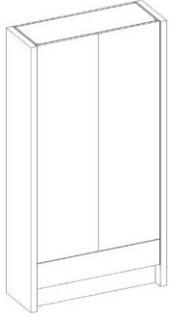

Fresco Armoire

2 doors, 1 drawer, 4 adjustable shelves

Item#	Without Top	B	C	D
430-5945	45"W x 24"D x 84"H	9895	8245	12145

Interior: 41½"W x 22"D x 65"H
Maximum TV Size: 42", 416 lbs.

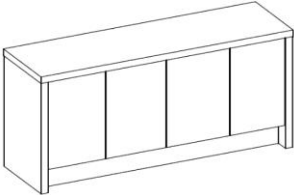

Shown with optional WT-2.0

Fresco 4 Door Media Console

4 doors

Suggested Countertop Pricing page 13

Item#	Without Top	B	C	D	WT-B-.75	WT-B-2.0	WT-C-.75	WT-C-2.0
430-7172	72"W x 18"D x 30"H	7895	6595	9695	1345	1745	1145	1445

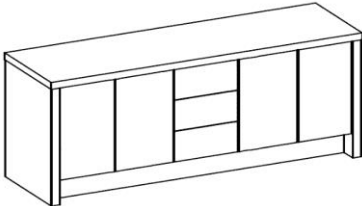

Shown with optional WT-2.0

Fresco 4-Door Media Console with Drawers

4 doors, 3 drawers

Suggested Countertop Pricing page 13

Item#	Without Top	B	C	D	WT-B-.75	WT-B-2.0	WT-C-.75	WT-C-2.0
430-7284	84"W x 18"D x 30"H	9245	7695	11345	1545	1995	1295	1645

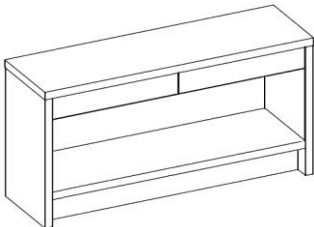

Shown with optional WT-2.0

Fresco Hall Console

2 drawer

Suggested Countertop Pricing page 13

Item#	Without Top	B	C	D	WT-B-.75	WT-B-2.0	WT-C-.75	WT-C-2.0
430-7548	48"W x 16"D x 30"H	4295	3545	5095	945	1245	795	1045
430-7560	60"W x 16"D x 30"H	4345	3595	5345	1145	1495	945	1245
430-7572	72"W x 16"D x 30"H	4495	3745	5495	1345	1745	1145	1445

*Countertops, Decorative Hardware and Options are not included and must be added separately



505 Josie



Features

- Full Inset - Door/Drawer reveal is on the front
- Grain Direction is Horizontal on Fronts
- Grain Direction is Vertical on Sides
- Interior is finished to match exterior
- Includes 1/8" x 3/4" metal banding surrounding each drawer
- Includes (4) Josie legs
- Each piece made by hand and signed by the craftsman

How to Specify

- Furniture Code is item code plus metal and wood finish code. Ex. 30" Josie nightstand in Burnished Brass and A30 White = 505-5130-BB-A30
- Add Countertop code from countertop section as separate line item
- Add Decorative Hardware with placement instructions
- Add Options with assignment instructions

Metal Finishes

Group 1

- SB Satin Brass (lacquered)
- AB Antique Brass (lacquered)
- MB Matte Black (lacquered)
- OC Oil Can (lacquered)

Group 2

- BB Burnished Brass Waxed
- PN Polished Nickel
- SN Satin Nickel
- PC Polished Chrome

Wood Finishes

A-Stain

- A2 Normandy
- A3 Briar
- A4 Brandy
- A6 Black Forest
- A8 Tombstone
- A20 Toffee
- A21 Cocoa
- A22 Driftwood

A-Paint - Matte

- A30 White
- A31 Black
- A32 Nonchalant
- A34 Robin Egg
- A35 Vanilla
- A36 Harbor Gray
- A37 Silverstream
- A38 Sable
- A39 Navy Blue

B-Wood

- B39 English Walnut
- B41 French Walnut
- B42 Granite Walnut
- B54 Cerused Oak
- B57 Milk Oak
- B58 Manhattan Oak
- B59 Chocolate Oak
- B60 White Oak
- B61 Black Oak

Custom Color A+10%
Glossy Top Coat A+10%

Suggested Hardware for Josie



11" Recessed Bar Pull

11RBAR-[Finish]

Gp1 \$600 ea, Gp2 \$700 ea



3" Square Ring Pull

3SQRING-[Finish] \$90 ea



3" Round Ring Pull

3RDRING-[Finish] \$90 ea



8" Edge Pull

8EDGE-[Finish]

Gp1 \$90ea, Gp2 \$120ea



3" Recessed Square Knob

RSKNOB-[Finish]

Gp1 \$350, Gp2 \$400



3" Recessed Square Knob

RRKNOB-[Finish]

Gp1 \$350, Gp2 \$400



Shown with optional WT-2.0

Josie Closed Nightstand

3 drawers

Item#	Without Top	Group 1		Group 2		Countertop Pricing page 13		
		A	B	A	B	WT-A-.75	WT-B-.75	ST-1.2
505-5124	24"W x 19"D x 28"H	4095	4545	4895	5345	495	545	795
505-5130	30"W x 19"D x 28"H	4195	4645	5095	5595	595	645	945
505-5136	36"W x 19"D x 28"H	4245	4745	5245	5745	695	745	1145



Shown with optional WT-2.0

Josie Open Nightstand

1 drawer

Item#	Without Top	Group 1		Group 2		Countertop Pricing page 13		
		A	B	A	B	WT-A-.75	WT-B-.75	ST-1.2
505-5224	24"W x 19"D x 28"H	3695	4095	4395	4795	495	545	795
505-5230	30"W x 19"D x 28"H	3795	4195	4595	5045	595	645	945
505-5236	36"W x 19"D x 28"H	3845	4295	4745	5195	695	745	1145



Shown with optional WT-2.0

Josie 4 Drawer Dresser

4 drawers

Item#	Without Top	Group 1		Group 2		Countertop Pricing page 13		
		A	B	A	B	WT-A-.75	WT-B-.75	ST-1.2
505-5342	42"W x 21"D x 42"H	8495	9495	10495	11495	795	845	1245

*Countertops, Decorative Hardware and Options are not included and must be added separately



Shown with optional WT-2.0

Josie 6 Drawer Dresser

6 drawers

Item#	Without Top	Group 1		Group 2		Countertop Pricing page 13		
		A	B	A	B	WT-A-.75	WT-B-.75	ST-1.2
505-5672	72"W x 21"D x 33"H	10395	11645	12845	13995	1245	1345	2095



Shown with optional WT-2.0

Josie 9 Drawer Dresser

9 drawers

Item#	Without Top	Group 1		Group 2		Countertop Pricing page 13		
		A	B	A	B	WT-A-.75	WT-B-.75	ST-1.2
505-5778	78"W x 21"D x 33"H	11795	13195	14595	15995	1345	1445	2245

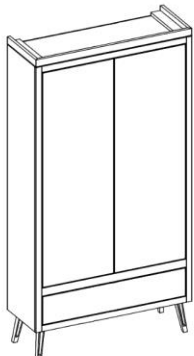

Josie Armoire

2 doors, 1 drawer, 4 adjustable shelves

Item#	With Frieze	Group 1		Group 2	
		A	B	A	B
505-5945	45"W x 24"D x 84"H	12745	14245	15745	17245

Interior: 41¼"W x 22"D x 65"H

Maximum TV Size: 42", 416 lbs.



Shown with optional WT-2.0

Josie 4 Door Media Console

4 doors

Item#	Without Top	Group 1		Group 2		Countertop Pricing page 13		
		A	B	A	B	WT-A-.75	WT-B-.75	ST-1.2
505-7172	72"W x 18"D x 30"H	10195	11395	12595	13795	1245	1345	2095

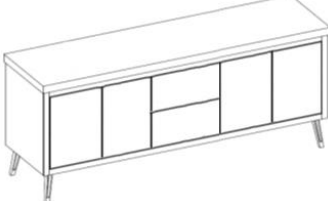

Shown with optional WT-2.0

Josie 4-Door Media Console with Drawers

4 doors, 2 drawers

Item#	Without Top	Group 1		Group 2		Countertop Pricing page 13		
		A	B	A	B	WT-A-.75	WT-B-.75	ST-1.2
505-7284	84"W x 18"D x 30"H	11895	13295	14695	15995	1445	1545	2395

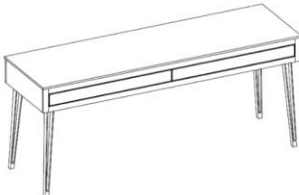

Shown with optional GS-0.5

Josie Hall Console

2 drawer

Item#	Without Top	Group 1		Group 2		Countertop Pricing page 13		
		A	B	A	B	WT-A-.75	WT-B-.75	ST-1.2
505-7548	48"W x 16"D x 30"H	5745	6395	6845	7495	895	945	1445
505-7560	60"W x 16"D x 30"H	5895	6495	7145	7845	1045	1145	1745
505-7572	72"W x 16"D x 30"H	5945	6645	7345	8045	1245	1345	2095

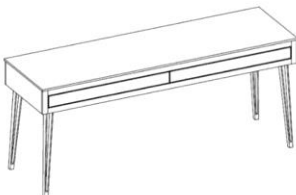

Shown with optional GS-0.5

Josie Writing Desk

2 drawer

Item#	Without Top	Group 1		Group 2		Countertop Pricing page 13		
		A	B	A	B	WT-A-.75	WT-B-.75	ST-1.2
505-7648	48"W x 30"D x 30"H	6145	6845	7345	8045	895	945	1445
505-7660	60"W x 30"D x 30"H	6295	6945	7645	8395	1045	1145	1745
505-7672	72"W x 30"D x 30"H	6395	7095	7895	8595	1245	1345	2095

*Countertops, Decorative Hardware and Options are not included and must be added separately



526 Lucas



Features

- Full Inset - Door/Drawer reveal is on the front
- Grain Direction is Horizontal on Fronts
- Grain Direction is Vertical on Sides
- This design features Substructure construction
- Includes metal leg detail with brackets as shown
- Each piece made by hand and signed by the craftsman

How to Specify

- Furniture Code is item code plus metal and wood finish code. Ex. 30" Lucas nightstand in Burnished Brass and A30 White = 526-5130-BB-A30
- Add Countertop code from countertop section as separate line item
- Add Decorative Hardware with placement instructions
- Add Options with assignment instructions

Metal Finishes

Group 1

- SB Satin Brass (lacquered)
- AB Antique Brass (lacquered)
- MB Matte Black (lacquered)
- OC Oil Can (lacquered)

Group 2

- BB Burnished Brass Waxed
- PN Polished Nickel
- SN Satin Nickel
- PC Polished Chrome

Wood Finishes

A-Stain

- A2 Normandy
- A3 Briar
- A4 Brandy
- A6 Black Forest
- A8 Tombstone
- A20 Toffee
- A21 Cocoa
- A22 Driftwood

A-Paint - Matte

- A30 White
- A31 Black
- A32 Nonchalant
- A34 Robin Egg
- A35 Vanilla
- A36 Harbor Gray
- A37 Silverstream
- A38 Sable
- A39 Navy Blue

B-Wood

- B39 English Walnut
- B41 French Walnut
- B42 Granite Walnut
- B54 Cerused Oak
- B57 Milk Oak
- B58 Manhattan Oak
- B59 Chocolate Oak
- B60 White Oak
- B61 Black Oak

D-Auto - Automotive

- D1 White Lacquer
- D2 Black Lacquer
- D10 Escalade Pearl
- D11 Ocean Metallic
- D13 Grey Metallic
- D14 White Pearl
- D16 Cappuccino
- D17 Sea Serpent

Custom Color A+10%
Glossy Top Coat A+10%

Design Specific Countertop

- This design has curved corners and will require a countertop with rounded corners to match
- Countertops from Furniture Guild are limited to non-built up edges
- Countertops from Furniture Guild are set inside the metal lip detail

Suggested Hardware for Lucas



11" Recessed Bar Pull

11RBAR-[Finish]

Gp1 \$600 ea, Gp2 \$700 ea



3" Square Ring Pull

3SQRING-[Finish] \$90 ea



3" Round Ring Pull

3RDRING-[Finish] \$90 ea



8" Edge Pull

8EDGE-[Finish]

Gp1 \$90ea, Gp2 \$120ea



3" Recessed Square Knob

RSKNOB-[Finish]

Gp1 \$350, Gp2 \$400



3" Recessed Square Knob

RRKNOB-[Finish]

Gp1 \$350, Gp2 \$400

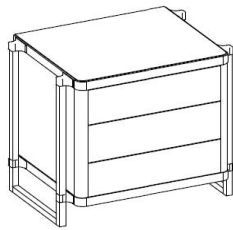

Shown with optional WT-.75

Lucas Closed Nightstand

3 drawers

Item#	Without Top	Group 1			Group 2		
		A	B	D	A	B	D
526-5124	24"W x 19"D x 28"H	4095	4545	5695	4895	5345	6695
526-5130	30"W x 19"D x 28"H	4195	4645	5795	5095	5595	6995
526-5136	36"W x 19"D x 28"H	4245	4745	5945	5245	5745	7195

Suggested Countertop Pricing page 13

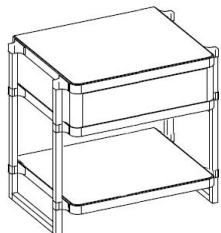

Shown with optional WT-.75

Lucas Open Nightstand

1 drawer

Item#	Without Top	Group 1			Group 2		
		A	B	D	A	B	D
526-5224	24"W x 19"D x 28"H	4095	4545	5695	4895	5345	6695
526-5230	30"W x 19"D x 28"H	4195	4645	5795	5095	5595	6995
526-5236	36"W x 19"D x 28"H	4245	4745	5945	5245	5745	7195

Suggested Countertop Pricing page 13

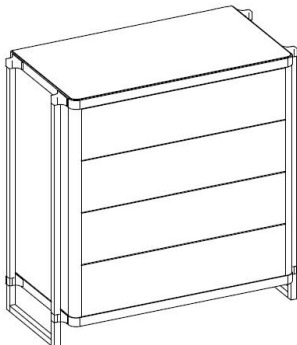

Shown with optional WT-.75

Lucas 4 Drawer Dresser

4 drawers

Item#	Without Top	Group 1			Group 2		
		A	B	D	A	B	D
526-5342	42"W x 21"D x 42"H	8495	9495	11895	10495	11495	14395

Suggested Countertop Pricing page 13

*Countertops, Decorative Hardware and Options are not included and must be added separately

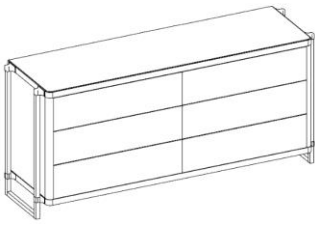

Shown with optional WT-.75

Lucas 6 Drawer Dresser

6 drawers

Suggested Countertop Pricing page 13

Item#	Without Top	Group 1			Group 2		
		A	B	D	A	B	D
526-5672	72"W x 21"D x 33"H	10395	11645	14595	12845	13995	17645

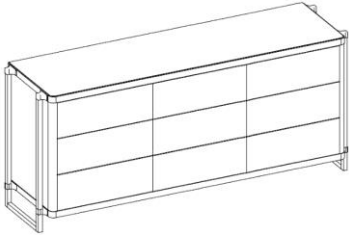

Shown with optional WT-.75

Lucas 9 Drawer Dresser

9 drawers

Suggested Countertop Pricing page 13

Item#	Without Top	Group 1			Group 2		
		A	B	D	A	B	D
526-5778	78"W x 21"D x 33"H	11795	13195	16545	14595	15995	19995

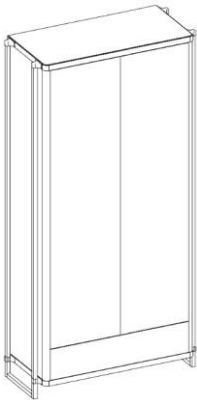

Lucas Armoire

2 doors, 1 drawer, 4 adjustable shelves

Item#	With Frieze	Group 1			Group 2		
		A	B	D	A	B	D
526-5945	45"W x 24"D x 84"H	12745	14245	17845	15745	17245	21595

Interior: 41¼"W x 22"D x 65"H

Maximum TV Size: 42", 416 lbs.

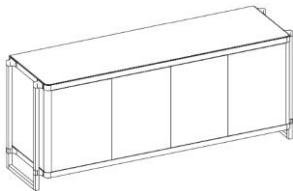

Shown with optional WT-.75

Lucas 4 Door Media Console

4 doors

Suggested Countertop Pricing page 13

Item#	Without Top	Group 1			Group 2		
		A	B	D	A	B	D
526-7172	72"W x 18"D x 30"H	10195	11395	14295	12595	13795	17295

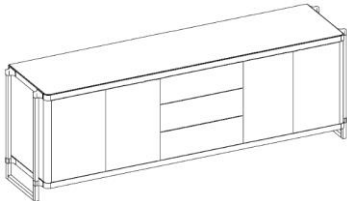

Shown with optional WT-.75

Lucas 4-Door Media Console with Drawers

4 doors, 2 drawers

Suggested Countertop Pricing page 13

Item#	Without Top	Group 1			Group 2		
		A	B	D	A	B	D
526-7284	84"W x 18"D x 30"H	11895	13295	16645	14695	15995	20145

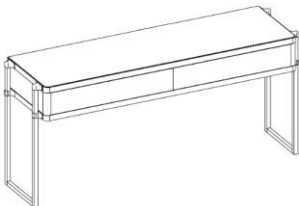

Shown with optional WT-.75

Lucas Hall Console

2 drawer

Suggested Countertop Pricing page 13

Item#	Without Top	Group 1			Group 2		
		A	B	D	A	B	D
526-7548	48"W x 16"D x 30"H	5745	6395	7995	6845	7495	9395
526-7560	60"W x 16"D x 30"H	5895	6495	8145	7145	7845	9795
526-7572	72"W x 16"D x 30"H	5945	6645	8345	7345	8045	10095

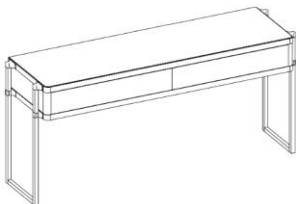

Shown with optional WT-.75

Lucas Writing Desk

2 drawer

Suggested Countertop Pricing page 13

Item#	Without Top	Group 1			Group 2		
		A	B	D	A	B	D
526-7648	48"W x 30"D x 30"H	6145	6845	8545	7345	8045	10045
526-7660	60"W x 30"D x 30"H	6295	6945	8695	7645	8395	10495
526-7672	72"W x 30"D x 30"H	6395	7095	8895	7895	8595	10795

*Countertops, Decorative Hardware and Options are not included and must be added separately



610 Winston



Features

- Frame is Brass or Steel 1" Tubing
- Grain direction is Horizontal on front and sides
- Blum Legrabox full extension, soft close drawer runners
- Each piece made by hand and signed by the craftsman

How to Specify

- Furniture Code is item code plus metal and wood finish code. Ex. 30" Winston nightstand in Burnished Brass and C60 Ashlin = 610-5130-BB-C60
- Add Countertop code from countertop section as separate line item
- Add Decorative Hardware with placement instructions
- Add Options with assignment instructions

Metal Finishes

Group 1

- SB Satin Brass (lacquered)
- AB Antique Brass (lacquered)
- MB Matte Black (lacquered)
- OC Oil Can (lacquered)

Group 2

- BB Burnished Brass Waxed
 - PN Polished Nickel
 - SN Satin Nickel
- NOT AVAILABLE IN POLISHED CHROME**

Wood Finishes

C-Color - Matte

- C40 White Fenix
- C41 Black Fenix
- C42 Efeso Gray Fenix
- C43 Londra Gray Fenix
- C44 Bromo Gray Fenix
- C46 Ottawa Beige Fenix

C-Color - High Gloss

- C21 White Acrylic
- C22 Black Acrylic
- C26 Ivory Acrylic
- C28 Lunar Gray Acrylic
- C29 Graystone Acrylic
- C30 Slate Gray Acrylic
- C31 Iridium Silver Acrylic
- C32 Champagne Acrylic
- C33 Carbonite Acrylic

C-Tex -Texture

- C60 Ashlin
- C61 Barley
- C62 Truffle
- C63 Nimbus
- C64 Russet
- C65 Charred

B-Wood

- B39 English Walnut
- B41 French Walnut
- B42 Granite Walnut
- B54 Cerused Oak
- B57 Milk Oak
- B58 Manhattan Oak
- B59 Chocolate Oak
- B60 White Oak
- B61 Black Oak

B-Exotic

- B18 Rosewood
- B22 Black Limba
- B38 Quartered Walnut
- B40 Natural Walnut
- B47 Gray Reclaimed Oak
- B48 Clear Reclaimed Oak
- B49 Natural Reclaimed Oak

D-Auto - Automotive

- D1 White Lacquer
- D2 Black Lacquer
- D10 Escalade Pearl
- D11 Ocean Metallic
- D13 Grey Metallic
- D14 White Pearl
- D16 Cappuccino
- D17 Sea Serpent

Custom Paint Colors

- Matte Paint C+10%
- Glossy Paint C+20%
- Polished Lacquer D+10%

Suggested Hardware for Winston



11" Recessed Bar Pull

11RBAR-[Finish]

Gp1 \$600 ea, Gp2 \$700 ea



3" Square Ring Pull

3SQRING-[Finish] \$90 ea



3" Round Ring Pull

3RDRING-[Finish] \$90 ea



8" Edge Pull

8EDGE-[Finish]

Gp1 \$90ea, Gp2 \$120ea



3" Recessed Square Knob

RSKNOB-[Finish]

Gp1 \$350, Gp2 \$400



3" Recessed Square Knob

RRKNOB-[Finish]

Gp1 \$350, Gp2 \$400



Winston Closed Nightstand

3 drawers

Suggested Countertop Pricing page 13

Item#	Without Top	Group 1			Group 2		
		B	C	D	B	C	D
610-5124	24"W x 19"D x 28"H	5745	5345	6195	6295	5945	6795
610-5130	30"W x 19"D x 28"H	5795	5445	6295	6495	6145	6995
610-5136	36"W x 19"D x 28"H	5895	5545	6345	6645	6295	7145

Shown with optional ST-1.2



Winston Open Nightstand

1 drawer

Suggested Countertop Pricing page 13

Item#	Without Top	Group 1			Group 2		
		B	C	D	B	C	D
610-5224	24"W x 19"D x 28"H	5195	4795	5595	5645	5345	6145
610-5230	30"W x 19"D x 28"H	5245	4895	5645	5845	5545	6295
610-5236	36"W x 19"D x 28"H	5295	4995	5695	5995	5695	6445

Shown with optional ST-1.2

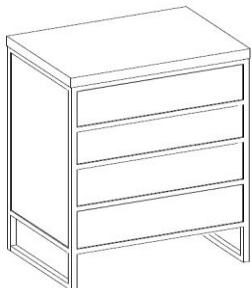

Winston 4 Drawer Dresser

4 drawers

Suggested Countertop Pricing page 13

Item#	Without Top	Group 1			Group 2		
		B	C	D	B	C	D
610-5342	42"W x 21"D x 42"H	11795	11095	12695	13295	12595	14295

Shown with optional ST-1.2

*Countertops, Decorative Hardware and Options are not included and must be added separately

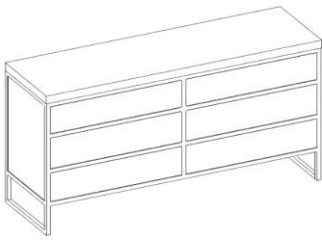

Shown with optional ST-1.2

NEW SUBSTRUCTURE CONSTRUCTION

Winston 6 Drawer Dresser

Suggested Countertop Pricing page 13

6 drawers

Item#	Without Top	Group 1			Group 2		
		B	C	D	B	C	D
610-5672	72"W x 21"D x 33"H	14445	13595	15545	16295	15445	17495

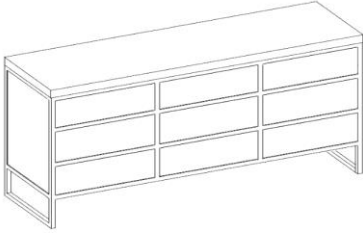

Shown with optional ST-1.2

NEW SUBSTRUCTURE CONSTRUCTION

Winston 9 Drawer Dresser

Suggested Countertop Pricing page 13

9 drawers

Item#	Without Top	Group 1			Group 2		
		B	C	D	B	C	D
610-5778	78"W x 21"D x 33"H	16395	15445	17645	18495	17495	19895

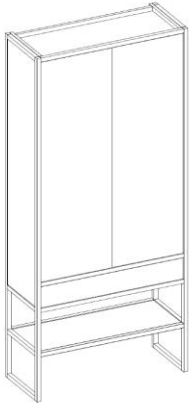

Winston Armoire

2 doors, 1 drawer, 3 adjustable shelves

Item#	Without Top	Group 1			Group 2		
		B	C	D	B	C	D
610-5945	45"W x 24"D x 84"H	17695	16645	18995	19945	18895	21445

Interior: 41¼"W x 22"D x 65"H
Maximum TV Size: 42", 416 lbs.

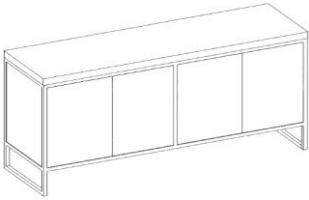

Shown with optional ST-1.2

NEW SUBSTRUCTURE CONSTRUCTION

Winston 4 Door Media Console

Suggested Countertop Pricing page 13

4 doors

Item#	Without Top	Group 1			Group 2		
		B	C	D	B	C	D
610-7172	72"W x 18"D x 30"H	14145	13295	15245	15945	15145	17145

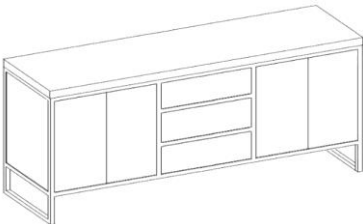

Shown with optional ST-1.2

NEW SUBSTRUCTURE CONSTRUCTION

Winston 4-Door Media Console with Drawers

Suggested Countertop Pricing page 13

1 drawer

Item#	Without Top	Group 1			Group 2		
		B	C	D	B	C	D
610-7284	84"W x 18"D x 30"H	16495	15545	17795	18595	17645	19995

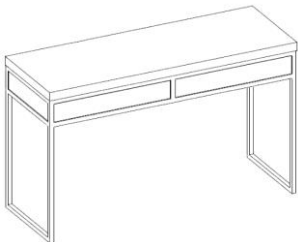

Shown with optional ST-1.2

Winston Hall Console

Suggested Countertop Pricing page 13

2 drawer

Item#	Without Top	Group 1			Group 2		
		B	C	D	B	C	D
610-7548	48"W x 16"D x 30"H	7795	7195	8395	8495	8045	9245
610-7560	60"W x 16"D x 30"H	7895	7345	8495	8795	8345	9445
610-7572	72"W x 16"D x 30"H	7995	7495	8595	8995	8545	9695

*Countertops, Decorative Hardware and Options are not included and must be added separately



615 Alton



Features

- Frame is Solid Brass Tubing or Solid Steel 1/2" x 2"
- This design features Substructure construction
- Grain direction for panels is Horizontal on front and sides
- Blum Legrabox full extension, soft close drawer runners
- Each piece made by hand and signed by the craftsman

How to Specify

- Furniture Code is item code plus metal and wood finish code. Ex. 30" Alton nightstand in Burnished Brass and C60 Ashlin = 615-5130-BB-C60
- Add Countertop code from countertop section as separate line item
- Add Decorative Hardware with placement instructions
- Add Options with assignment instructions

Metal Finishes

Group 1

SB Satin Brass (lacquered)
 AB Antique Brass (lacquered)
 MB Matte Black (lacquered)
 OC Oil Can (lacquered)

Group 2

BB Burnished Brass Waxed
 PN Polished Nickel
 SN Satin Nickel
 PC Polished Chrome

Wood Finishes

C-Color - Matte

C40 White Fenix
 C41 Black Fenix
 C42 Efeso Gray Fenix
 C43 Londra Gray Fenix
 C44 Bromo Gray Fenix
 C46 Ottawa Beige Fenix

Custom Paint Colors

Matte Paint C+10%

C-Color - High Gloss

C21 White Acrylic
 C22 Black Acrylic
 C26 Ivory Acrylic
 C28 Lunar Gray Acrylic
 C29 Graystone Acrylic
 C30 Slate Gray Acrylic
 C31 Iridium Silver Acrylic
 C32 Champagne Acrylic
 C33 Carbonite Acrylic

C-Tex - Texture

C60 Ashlin
 C61 Barley
 C62 Truffle
 C63 Nimbus
 C64 Russet
 C65 Charred

B-Wood

B39 English Walnut
 B41 French Walnut
 B42 Granite Walnut
 B54 Cerused Oak
 B57 Milk Oak
 B58 Manhattan Oak
 B59 Chocolate Oak
 B60 White Oak
 B61 Black Oak

B-Exotic

B18 Rosewood
 B22 Black Limba
 B38 Quartered Walnut
 B40 Natural Walnut
 B47 Gray Reclaimed Oak
 B48 Clear Reclaimed Oak
 B49 Natural Reclaimed Oak

D-Auto - Automotive

D1 White Lacquer
 D2 Black Lacquer
 D10 Escalade Pearl
 D11 Ocean Metallic
 D13 Grey Metallic
 D14 White Pearl
 D16 Cappuccino
 D17 Sea Serpent

Suggested Hardware for Lucas



11" Recessed Bar Pull

11RBAR-[Finish]

Gp1 \$600 ea, Gp2 \$700 ea



3" Square Ring Pull

3SQRING-[Finish] \$90 ea



3" Round Ring Pull

3RDRING-[Finish] \$90 ea



8" Edge Pull

8EDGE-[Finish]

Gp1 \$90ea, Gp2 \$120ea



3" Recessed Square Knob

RSKNOB-[Finish]

Gp1 \$350, Gp2 \$400



3" Recessed Square Knob

RRKNOB-[Finish]

Gp1 \$350, Gp2 \$400

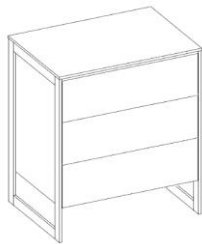

Alton Closed Nightstand

3 drawers

Item#	Without Top	Group 1			Group 2		
		B	C	D	B	C	D
615-5124	24"W x 19"D x 28"H	4695	4395	5095	5445	5145	5845
615-5130	30"W x 19"D x 28"H	4795	4495	5245	5495	5195	5945
615-5136	36"W x 19"D x 28"H	4845	4545	5345	5595	5295	6045

Suggested Countertop Pricing page 13



Alton Open Nightstand

1 drawer

Item#	Without Top	Group 1			Group 2		
		B	C	D	B	C	D
615-5224	24"W x 19"D x 28"H	4245	3945	4595	4895	4645	5295
615-5230	30"W x 19"D x 28"H	4345	4045	4745	4945	4695	5345
615-5236	36"W x 19"D x 28"H	4395	4095	4845	5045	4795	5445

Suggested Countertop Pricing page 13



Alton 4 Drawer Dresser

4 drawers

Item#	Without Top	Group 1			Group 2		
		B	C	D	B	C	D
615-5342	42"W x 21"D x 42"H	9695	9095	10695	11195	10595	12095

Suggested Countertop Pricing page 13

*Countertops, Decorative Hardware and Options are not included and must be added separately

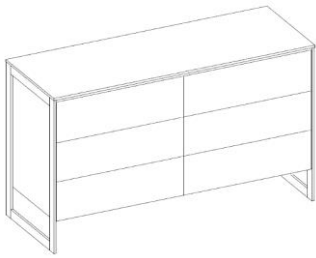

Alton 6 Drawer Dresser

6 drawers

Suggested Countertop Pricing page 13

Item#	Without Top	Group 1			Group 2		
		B	C	D	B	C	D
615-5672	72"W x 21"D x 33"H	11895	11145	13095	13695	12995	14795

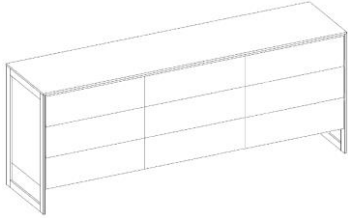

Alton 9 Drawer Dresser

9 drawers

Suggested Countertop Pricing page 13

Item#	Without Top	Group 1			Group 2		
		B	C	D	B	C	D
615-5778	78"W x 21"D x 33"H	13495	12645	14895	15545	14745	16795

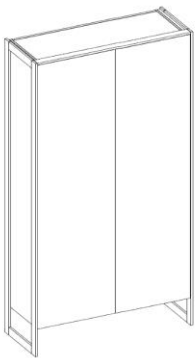

Alton Armoire

2 doors, 1 drawer, 4 adjustable shelves

Item#	Without Top	Group 1			Group 2		
		B	C	D	B	C	D
615-5945	45"W x 24"D x 84"H	14545	13645	15995	16795	15895	18145

Interior: 41 1/4"W x 22"D x 65"H

Maximum TV Size: 42", 416 lbs.

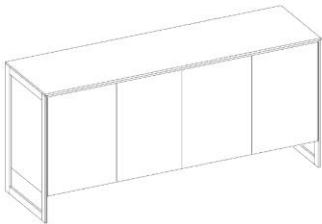

Alton 4 Door Media Console

4 doors

Suggested Countertop Pricing page 13

Item#	Without Top	Group 1			Group 2		
		B	C	D	B	C	D
615-7172	72"W x 18"D x 30"H	11645	10895	12845	13445	12695	14495

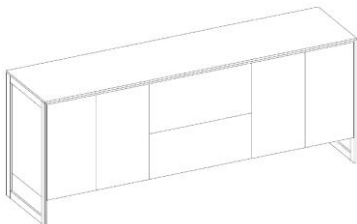

Alton 4-Door Media Console with Drawers

1 drawer

Suggested Countertop Pricing page 13

Item#	Without Top	Group 1			Group 2		
		B	C	D	B	C	D
615-7284	84"W x 18"D x 30"H	13545	12745	14995	15695	14845	16945

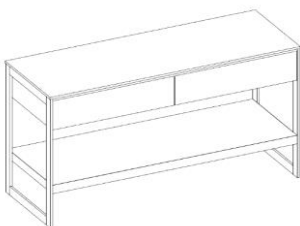

Alton Hall Console

2 drawer

Suggested Countertop Pricing page 13

Item#	Without Top	Group 1			Group 2		
		B	C	D	B	C	D
615-7548	48"W x 16"D x 30"H	6395	5945	6895	7345	6995	7945
615-7560	60"W x 16"D x 30"H	6545	6095	7145	7445	7045	8045
615-7572	72"W x 16"D x 30"H	6595	6145	7295	7595	7195	8195

*Countertops, Decorative Hardware and Options are not included and must be added separately



621 Avento



Features

- Frame is Solid Brass Tubing or Solid Steel 1/2" x 2"
- This design features Substructure construction
- Includes Integrated Finger Pull in matching metal
- Grain direction for panels is Horizontal on front and sides
- Blum Legrabox full extension, soft close drawer runners
- Each piece made by hand and signed by the craftsman

How to Specify

- Furniture Code is item code plus metal and wood finish code. Ex. 30" Avento nightstand in Burnished Brass and C60 Ashlin = 621-5130-BB-C60
- Add Countertop code from countertop section as separate line item
- Add Decorative Hardware with placement instructions

Metal Finishes

Group 1

SB Satin Brass (lacquered)
 AB Antique Brass (lacquered)
 MB Matte Black (lacquered)
 OC Oil Can (lacquered)

Group 2

BB Burnished Brass Waxed
 PN Polished Nickel
 SN Satin Nickel
 PC Polished Chrome

Wood Finishes

C-Color - Matte

C40 White Fenix
 C41 Black Fenix
 C42 Efeso Gray Fenix
 C43 Londra Gray Fenix
 C44 Bromo Gray Fenix
 C46 Ottawa Beige Fenix

Custom Paint Colors

Matte Paint C+10%

C-Color - High Gloss

C21 White Acrylic
 C22 Black Acrylic
 C26 Ivory Acrylic
 C28 Lunar Gray Acrylic
 C29 Graystone Acrylic
 C30 Slate Gray Acrylic
 C31 Iridium Silver Acrylic
 C32 Champagne Acrylic
 C33 Carbonite Acrylic

C-Tex - Texture

C60 Ashlin
 C61 Barley
 C62 Truffle
 C63 Nimbus
 C64 Russet
 C65 Charred

B-Wood

B39 English Walnut
 B41 French Walnut
 B42 Granite Walnut
 B54 Cerused Oak
 B57 Milk Oak
 B58 Manhattan Oak
 B59 Chocolate Oak
 B60 White Oak
 B61 Black Oak

B-Exotic

B18 Rosewood
 B22 Black Limba
 B38 Quartered Walnut
 B40 Natural Walnut
 B47 Gray Reclaimed Oak
 B48 Clear Reclaimed Oak
 B49 Natural Reclaimed Oak

D-Auto - Automotive

D1 White Lacquer
 D2 Black Lacquer
 D10 Escalade Pearl
 D11 Ocean Metallic
 D13 Grey Metallic
 D14 White Pearl
 D16 Cappuccino
 D17 Sea Serpent



Avento Closed Nightstand

3 drawers

Item#	Without Top	Group 1			Group 2		
		B	C	D	B	C	D
621-5124	24"W x 19"D x 28"H	5545	5195	6095	6395	6095	6895
621-5130	30"W x 19"D x 28"H	5645	5295	6195	6495	6195	6995
621-5136	36"W x 19"D x 28"H	5745	5395	6295	6595	6295	7095

Suggested Countertop Pricing page 13



Avento Open Nightstand

1 drawer

Item#	Without Top	Group 1			Group 2		
		B	C	D	B	C	D
621-5224	24"W x 19"D x 28"H	4995	4695	5495	5745	5495	6195
621-5230	30"W x 19"D x 28"H	5095	4795	5595	5845	5595	6295
621-5236	36"W x 19"D x 28"H	5195	4895	5695	5945	5695	6395

Suggested Countertop Pricing page 13



Avento 4 Drawer Dresser

4 drawers

Item#	Without Top	Group 1			Group 2		
		B	C	D	B	C	D
621-5342	42"W x 21"D x 42"H	11495	10795	12595	13195	12595	14195

Suggested Countertop Pricing page 13

*Countertops, Decorative Hardware and Options are not included and must be added separately

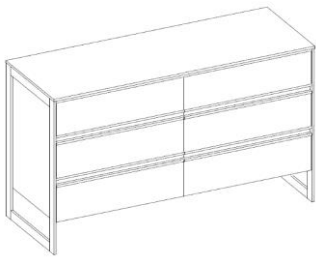

Avento 6 Drawer Dresser

6 drawers

Suggested Countertop Pricing page 13

Item#	Without Top	Group 1			Group 2		
		B	C	D	B	C	D
621-5672	72"W x 21"D x 33"H	14095	13245	15445	16195	15445	17395

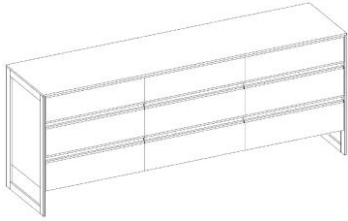

Avento 9 Drawer Dresser

9 drawers

Suggested Countertop Pricing page 13

Item#	Without Top	Group 1			Group 2		
		B	C	D	B	C	D
621-5778	78"W x 21"D x 33"H	15995	14995	17495	18345	17495	19745

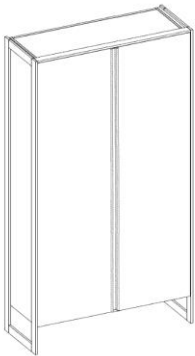

Avento Armoire

2 doors, 1 drawer, 4 adjustable shelves

Item#	Without Top	Group 1			Group 2		
		B	C	D	B	C	D
621-5945	45"W x 24"D x 84"H	17245	16195	18895	19795	18895	21295

Interior: 41½"W x 22"D x 65"H
Maximum TV Size: 42", 416 lbs.

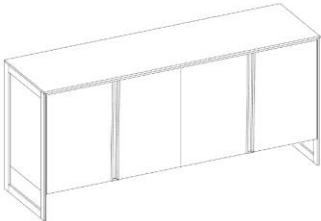

Avento 4 Door Media Console

4 doors

Suggested Countertop Pricing page 13

Item#	Without Top	Group 1			Group 2		
		B	C	D	B	C	D
621-7172	72"W x 18"D x 30"H	13795	12945	15095	15845	15095	17045

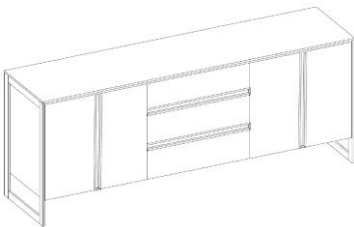

Avento 4-Door Media Console with Drawers

1 drawer

Suggested Countertop Pricing page 13

Item#	Without Top	Group 1			Group 2		
		B	C	D	B	C	D
621-7284	84"W x 18"D x 30"H	16095	15095	17645	18495	17645	19895

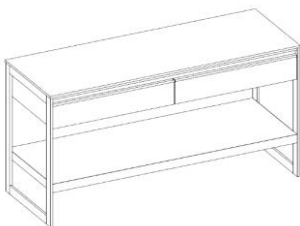

Avento Hall Console

2 drawer

Suggested Countertop Pricing page 13

Item#	Without Top	Group 1			Group 2		
		B	C	D	B	C	D
621-7548	48"W x 16"D x 30"H	7495	7045	8245	8645	8245	9295
621-7560	60"W x 16"D x 30"H	7645	7195	8395	8795	8395	9445
621-7572	72"W x 16"D x 30"H	7795	7345	8545	8895	8545	9595

*Countertops, Decorative Hardware and Options are not included and must be added separately



Limited Lifetime Warranty for Furniture

The Furniture Guild warrants its products to be free from defects in materials and workmanship under normal home use and service for as long as the original customer owns the product. Our obligation under this warranty shall be limited to the repair or exchange of any part or parts which may prove defective under normal home use and service during this period. Replacement of drawer slides and/or hardware are subject to the availability from our suppliers. This limited warranty does not cover defects caused by improper storage, installation, misuse or neglect. Nor does it cover any expense involved in removing, shipping and reinstalling any items or products. This warranty applies only to the original consumer purchaser of these products and at the original site of installation only. The Furniture Guild reserves the option of approving field repair or returning the cabinet or component to the factory for correction.

We exclude and are not responsible for any consequential damages nor for any incidental damages arising out of the breach of any expressed, written, or implied warranty which relates to our products. Some states do not allow the exclusion or limitation of incidental or consequential damages so the above limitation or exclusion may not apply to you.

We will not assume, nor authorize any person to assume for us any liability in connection with the sale of Furniture Guild's products. This warranty is in lieu of all other warranties expressed or implied. To file a warranty claim, the purchaser should contact the local authorized Furniture Guild dealer who will assist in servicing the claim.

Warranty for Countertops

5 years for residential use and 1 year commercial use