

robern®



2019 U.S. PRICE BOOK GUIDE

Promotional pricing effective January 7, 2019 - March 1, 2019.

Subject to change or extension based on section 301 tariff increases which is currently at a 10% increase through March 1, 2019.

Discontinued Product Summary (available until March 31, 2019 unless otherwise noted)

- M Series Mirrors
- Adorn™ Vanities (available until July 31, 2019)
- Adorn II Vanities
- Digital Wood Patterns in Vanities and Side Kits
- BRT™ Vertical Lighting
- Decorative Glass Sconce
- MLLWS Sconce
- Foyer Sconce
- Fairhaven Sconce
- Main Line Sconce in Satin Nickel, Brushed Nickel, Brushed Black and Brushed Bronze
- Eyezon Top Mount Lighting
- MTL Top Mount Lighting

Customer Service – Quick Reference Guide

Call 800-877-2376 for:

- Design Specification Questions
- Installation Questions
- Placing an Order
- Order Status Check
- Warranty
- Replacement Parts
- Returns

You will be asked to choose a prompt based on where you live:

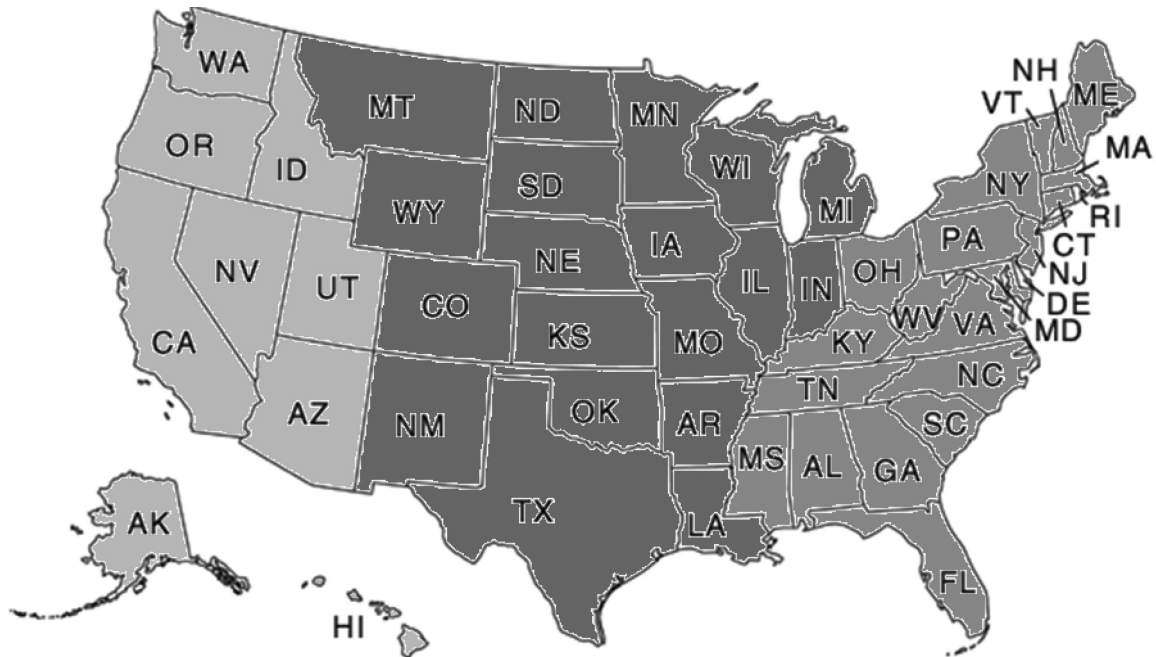

PRESS 3 includes Canada	PRESS 2	PRESS 1
-----------------------------------	----------------	----------------

If you are calling regarding a Commercial Specification project, PRESS 4.

If you prefer email, and are a HOMEOWNER OR CONTRACTOR contact us at: CustomerService@Robern.com.

If you prefer email, and are a SHOWROOM, DISTRIBUTOR OR DESIGNER/SPECIFIER contact us at:

RobernEast@Robern.com = East Region

RobernCentral@Robern.com = Central Region

RobernWest@Robern.com = West Region

RobernCanada@Robern.com = Canada Region

If you prefer email, and are interested in CUSTOM PROJECT SOLUTIONS (for commercial specification projects), contact us at: Custom@Robern.com.

ROBERN® Quick Ship Program

- Robern Quick Ship Program is intended for use by Robern's dealers only.
- ROBERN Quick Ship orders must be placed on a separate P.O. Begin your Quick Ship P.O. with "QR" and/or clearly mark the order "Quick Ship".
- Maximum order value for Quick Ship order \$3000 net.
- Net order must exceed \$1000 to get freight pre-paid by ROBERN. If order does not exceed \$1000, shipping charges outlined on page 283 will apply.

- All ROBERN sales and shipping conditions stated on pages 281 – 283 of the 2019 price guide apply.
- Orders will ship within 72 hours of receipt of order.
- Quick Ship orders are non-cancelable.
- The models listed below are the only models available on the Quick Ship Program. These models are also marked throughout the book with a:



Model No.	Product	Page	Price
Victality™ Lighted Mirrors			
YM0030CIFPD3	30" Diameter, Circle Inset, 2700K	33	\$ 879.
YM0030CIFPD4	30" Diameter, Circle Inset, 4000K	33	\$ 879.
YM0030CFPPD3	30" Diameter, Circle Perimeter, 2700K	33	\$ 829.
YM0040CIFPD3	40" Diameter, Circle Inset, 2700K	33	\$ 1,049.
YM0040CIFPD4	40" Diameter, Circle Inset, 4000K	33	\$ 1,049.
YM0040CFPPD3	40" Diameter, Circle Perimeter, 2700K	33	\$ 999.
YM2430RCFPD3	24"W x 30"H, Rect Column, 2700K	32	\$ 549.
YM2430RCFPD4	24"W x 30"H, Rect Column, 4000K	32	\$ 549.
YM2430RIFPD3	24"W x 30"H, Rect Inset, 2700K	32	\$ 779.
YM2430RIFPD4	24"W x 30"H, Rect Inset, 4000K	32	\$ 779.
YM2430RPFPPD3	24"W x 30"H, Rect Perimeter, 2700K	32	\$ 729.
YM2430RPFPPD3K	24"W x 30"H, Rect P, 2700K/Title 24	32	\$ 899.
YM2440RCFPD3	24"W x 40"H, Rect Column, 2700K	32	\$ 599.
YM2440RCFPD4	24"W x 40"H, Rect Column, 4000K	32	\$ 599.
YM2440RIFPD3	24"W x 40"H, Rect Inset, 2700K	32	\$ 829.
YM2440RIFPD4	24"W x 40"H, Rect Inset, 4000K	32	\$ 829.
YM2440RPFPPD3	24"W x 40"H, Rect Perimeter, 2700K	32	\$ 779.
YM2440RPFPPD3K	24"W x 40"H, Rect P, 2700K/Title 24	32	\$ 949.
YM3030RCFPD3	30"W x 30"H, Rect Column, 2700K	32	\$ 679.
YM3030RCFPD4	30"W x 30"H, Rect Column, 4000K	32	\$ 679.
YM3030RIFPD3	30"W x 30"H, Rect Inset, 2700K	32	\$ 879.
YM3030RIFPD4	30"W x 30"H, Rect Inset, 4000K	32	\$ 879.
YM3030RPFPPD3	30"W x 30"H, Rect Perimeter, 2700K	32	\$ 829.
YM3040RCFPD3	30"W x 40"H, Rect Column, 2700K	32	\$ 729.
YM3040RCFPD4	30"W x 40"H, Rect Column, 4000K	32	\$ 729.
YM3040RIFPD3	30"W x 40"H, Rect Inset, 2700K	32	\$ 949.
YM3040RIFPD4	30"W x 40"H, Rect Inset, 4000K	32	\$ 949.
YM3040RPFPPD3	30"W x 40"H, Rect Perimeter, 2700K	32	\$ 879.
YM3040RPFPPD3K	30"W x 40"H, Rect P, 2700K/Title 24	32	\$ 1,049.
YM3630RCFPD3	36"W x 30"H, Rect Column, 2700K	32	\$ 779.
YM3630RCFPD4	36"W x 30"H, Rect Column, 4000K	32	\$ 779.
YM3630RIFPD3	36"W x 30"H, Rect Inset, 2700K	32	\$ 999.
YM3630RIFPD4	36"W x 30"H, Rect Inset, 4000K	32	\$ 999.
YM3630RPFPPD3	36"W x 30"H, Rect Perimeter, 2700K	32	\$ 949.
YM3640RCFPD3	36"W x 40"H, Rect Column, 2700K	32	\$ 829.
YM3640RCFPD4	36"W x 40"H, Rect Column, 4000K	32	\$ 829.
YM3640RIFPD3	36"W x 40"H, Rect Inset, 2700K	32	\$ 1,049.
YM3640RIFPD4	36"W x 40"H, Rect Inset, 4000K	32	\$ 1,049.
YM3640RPFPPD3	36"W x 40"H, Rect Perimeter, 2700K	32	\$ 999.
YM3640RPFPPD3K	36"W x 40"H, Rect P, 2700K/Title 24	32	\$ 1,149.

Curated Cartesian® Vanities (5 – 7 Day Lead Time)			
24219100NB00001	24" x 15" x 21", White/Gray	54	\$ 3,049.
24219100TB00001	24" x 15" x 21", White/Gray, NL	54	\$ 3,379.
24219100NB00002	24" x 30" x 21", White/Gray	54	\$ 4,579.
24219100TB00002	24" x 30" x 21", White/Gray, NL	54	\$ 4,899.
30219100NB00001	30" x 15" x 21", White/Gray	56	\$ 3,699.
30219100TB00001	30" x 15" x 21", White/Gray, NL	56	\$ 4,079.
30219100NB00002	30" x 30" x 21", White/Gray	56	\$ 5,779.
30219100TB00002	30" x 30" x 21", White/Gray, NL	56	\$ 6,149.
36219100NB00001	36" x 15" x 21", White/Gray	58	\$ 4,349.
36219100TB00001	36" x 15" x 21", White/Gray, NL	58	\$ 4,799.
36219100NB00002	36" x 30" x 21", White/Gray	58	\$ 6,979.
36219100TB00002	36" x 30" x 21", White/Gray, NL	58	\$ 7,399.

Refer to product page for complete description.

Model No.	Product	Page	Price
AiO® Series Mirrors/Cabinets			
AM2430RFP	23-1/8"W x 29-7/8"H Mirror, 4000K	27	\$ 1,429.
AM2430RFPW	23-1/8"W x 29-7/8"H Mirror, 2700K	27	\$ 1,429.
AC2430D4P1L	24"W x 30"H Cabinet, LH, 4000K	157	\$ 1,949.
AC2430D4P1LW	24"W x 30"H Cabinet, LH, 2700K	157	\$ 1,949.
AC2430D4P1R	24"W x 30"H Cabinet, RH, 4000K	157	\$ 1,949.
AC2430D4P1RW	24"W x 30"H Cabinet, RH, 2700K	157	\$ 1,949.

M Series Cabinets/Components			
MC1230D4FPL	12"W x 30"H x 4"D, Polished, LH	182	\$ 829.
MC1230D4FPR	12"W x 30"H x 4"D, Polished, RH	182	\$ 829.
MC1230D4FPLE2	12"W x 30"H x 4"D, Pol, LH, Elec	182	\$ 1,249.
MC1230D4FPRE2	12"W x 30"H x 4"D, Polished, LH, Elec	182	\$ 1,249.
MC1240D4FPL	12"W x 40"H x 4"D, Polished, LH	190	\$ 1,149.
MC1240D4FPR	12"W x 40"H x 4"D, Polished, RH	190	\$ 1,149.
MC1240D4FPLE2	12"W x 40"H x 4"D, Pol, LH, Elec	190	\$ 1,579.
MC1240D4FPRE2	12"W x 40"H x 4"D, Pol, RH, Elec	190	\$ 1,579.
MC1630D4FPL	16"W x 30"H x 4"D, Polished, LH	184	\$ 929.
MC1630D4FPR	16"W x 30"H x 4"D, Polished, RH	184	\$ 929.
MC1630D4FPLE2	16"W x 30"H x 4"D, Pol, LH, Elec	184	\$ 1,379.
MC1630D4FPRE2	16"W x 30"H x 4"D, Pol, RH, Elec	184	\$ 1,379.
MC1630D4FPLE4	16"W x 30"H x 4"D, Pol, LH, Elec+	184	\$ 1,699.
MC1630D4FPRE4	16"W x 30"H x 4"D, Pol, RH, Elec+	184	\$ 1,699.
MC1640D4FPL	16"W x 40"H x 4"D, Polished, LH	192	\$ 1,249.
MC1640D4FPR	16"W x 40"H x 4"D, Polished, RH	192	\$ 1,249.
MC1640D4FPLE2	16"W x 40"H x 4"D, Pol, LH, Elec	192	\$ 1,699.
MC1640D4FPRE2	16"W x 40"H x 4"D, Pol, RH, Elec	192	\$ 1,699.
MC1640D4FPLE4	16"W x 40"H x 4"D, Pol, LH, Elec+	192	\$ 2,029.
MC1640D4FPRE4	16"W x 40"H x 4"D, Pol, RH, Elec+	192	\$ 2,029.
MC2030D4FPL	20"W x 30"H x 4"D, Polished, LH	186	\$ 1,099.
MC2030D4FPR	20"W x 30"H x 4"D, Polished, RH	186	\$ 1,099.
MC2030D4FPLE2	20"W x 30"H x 4"D, Pol, LH, Elec	186	\$ 1,529.
MC2030D4FPRE2	20"W x 30"H x 4"D, Pol, RH, Elec	186	\$ 1,529.
MC2030D4FPLE4	20"W x 30"H x 4"D, Pol, LH, Elec+	186	\$ 1,849.
MC2030D4FPRE4	20"W x 30"H x 4"D, Pol, RH, Elec+	186	\$ 1,849.
MC2040D4FPL	20"W x 40"H x 4"D, Polished, LH	194	\$ 1,379.
MC2040D4FPR	20"W x 40"H x 4"D, Polished, RH	194	\$ 1,379.
MC2040D4FPLE2	20"W x 40"H x 4"D, Pol, LH, Elec	188	\$ 1,799.
MC2040D4FPRE2	20"W x 40"H x 4"D, Pol, RH, Elec	194	\$ 1,799.
MC2040D4FPLE4	20"W x 40"H x 4"D, Pol, LH, Elec+	194	\$ 2,129.
MC2040D4FPRE4	20"W x 40"H x 4"D, Pol, RH, Elec+	194	\$ 2,129.
MC2430D4FPL	24"W x 30"H x 4"D, Polished, LH	188	\$ 1,149.
MC2430D4FPR	24"W x 30"H x 4"D, Polished, RH	188	\$ 1,149.
MC2430D4FPLE2	24"W x 30"H x 4"D, Pol, LH, Elec	188	\$ 1,579.
MC2430D4FPRE2	24"W x 30"H x 4"D, Pol, RH, Elec	188	\$ 1,579.
MC2430D4FPLE4	24"W x 30"H x 4"D, Pol, LH, Elec+	188	\$ 1,929.
MC2430D4FPRE4	24"W x 30"H x 4"D, Pol, RH, Elec+	188	\$ 1,929.
MC2440D4FPL	24"W x 40"H x 4"D, Polished, LH	196	\$ 1,429.
MC2440D4FPR	24"W x 40"H x 4"D, Polished, RH	196	\$ 1,429.
MC2440D4FPLE2	24"W x 40"H x 4"D, Pol, LH, Elec	196	\$ 1,849.
MC2440D4FPRE2	24"W x 40"H x 4"D, Pol, RH, Elec	196	\$ 1,849.
MC2440D4FPLE4	24"W x 40"H x 4"D, Pol, LH, Elec+	196	\$ 2,199.
MC2440D4FPRE4	24"W x 40"H x 4"D, Pol, RH, Elec+	196	\$ 2,199.
MSMK30D4P	Surface-Mount Kit for 30"H x 4"D	274	\$ 149.
MSMK40D4P	Surface-Mount Kit for 40"H x 4"D	274	\$ 249.
MGKIT	M Cabinets 30"/40"H Ganging Kit	273	\$ 49.

Continued on following page.

Fax: 1-267-540-2053

Terms and conditions of Quick Ship Program subject to change.

ROBERN® Quick Ship Program

- Robern Quick Ship Program is intended for use by Robern's dealers only.
- ROBERN Quick Ship orders must be placed on a separate P.O. Begin your Quick Ship P.O. with "QR" and/or clearly mark the order "Quick Ship".
- Maximum order value for Quick Ship order \$3000 net.
- Net order must exceed \$1000 to get freight pre-paid by ROBERN. If order does not exceed \$1000, shipping charges outlined on page 283 will apply.

- All ROBERN sales and shipping conditions stated on pages 281 – 283 of the 2019 price guide apply.
- Orders will ship within 72 hours of receipt of order.
- Quick Ship orders are non-cancelable.
- The models listed below are the only models available on the Quick Ship Program. These models are also marked throughout the book with a:



Model No.	Product	Page	Price
PL Series Cabinets/Components			
PLM1630G	15-1/4"W x 30"H, Polished, Gray	232	\$ 529.
PLM1630GLE	15-1/4"W x 30"H, Pol, LH, Elec, Gray	232	\$ 829.
PLM1630GRE	15-1/4"W x 30"H, Pol, RH, Elec, Gray	232	\$ 829.
PLM1630GB	15-1/4"W x 30"H, Bevel, Gray	232	\$ 529.
PLM1630GBLE	15-1/4"W x 30"H, Bev, LH, Elec, Gray	232	\$ 829.
PLM1630GBRE	15-1/4"W x 30"H, Bev, RH, Elec, Gray	232	\$ 829.
PLM1630W	15-1/4"W x 30"H, Polished, White	232	\$ 529.
PLM1630WLE	15-1/4"W x 30"H, Pol, LH, Elec, Wht	232	\$ 829.
PLM1630WRE	15-1/4"W x 30"H, Pol, RH, Elec, Wht	232	\$ 829.
PLM1630WB	15-1/4"W x 30"H, Bevel, White	232	\$ 529.
PLM1630WBLE	15-1/4"W x 30"H, Bev, LH, Elec, Wht	232	\$ 829.
PLM1630WBRE	15-1/4"W x 30"H, Bev, RH, Elec, Wht	232	\$ 829.
PLM1640G	15-1/4"W x 40"H, Polished, Gray	232	\$ 649.
PLM1640GLE	15-1/4"W x 40"H, Pol, LH, Elec, Gray	232	\$ 929.
PLM1640GRE	15-1/4"W x 40"H, Pol, RH, Elec, Gray	232	\$ 929.
PLM1640GB	15-1/4"W x 40"H, Bevel, Gray	232	\$ 649.
PLM1640GBLE	15-1/4"W x 40"H, Bev, LH, Elec, Gray	232	\$ 929.
PLM1640GBRE	15-1/4"W x 40"H, Bev, RH, Elec, Gray	232	\$ 929.
PLM1640W	15-1/4"W x 40"H, Polished, White	232	\$ 649.
PLM1640WLE	15-1/4"W x 40"H, Pol, LH, Elec, Wht	232	\$ 929.
PLM1640WRE	15-1/4"W x 40"H, Pol, RH, Elec, Wht	232	\$ 929.
PLM1640WB	15-1/4"W x 40"H, Bevel, White	232	\$ 649.
PLM1640WBLE	15-1/4"W x 40"H, Bev, LH, Elec, Wht	232	\$ 929.
PLM1640WBRE	15-1/4"W x 40"H, Bev, RH, Elec, Wht	232	\$ 929.
PLM2030G	19-1/4"W x 30"H, Polished, Gray	233	\$ 579.
PLM2030GLE	19-1/4"W x 30"H, Pol, LH, Elec, Gray	233	\$ 879.
PLM2030GRE	19-1/4"W x 30"H, Pol, RH, Elec, Gray	233	\$ 879.
PLM2030GB	19-1/4"W x 30"H, Bevel, Gray	233	\$ 579.
PLM2030GBLE	19-1/4"W x 30"H, Bev, LH, Elec, Gray	233	\$ 879.
PLM2030GBRE	19-1/4"W x 30"H, Bev, RH, Elec, Gray	233	\$ 879.
PLM2030W	19-1/4"W x 30"H, Polished, White	233	\$ 579.
PLM2030WLE	19-1/4"W x 30"H, Pol, LH, Elec, Wht	233	\$ 879.
PLM2030WRE	19-1/4"W x 30"H, Pol, RH, Elec, Wht	233	\$ 879.
PLM2030WB	19-1/4"W x 30"H, Bevel, White	233	\$ 579.
PLM2030WBLE	19-1/4"W x 30"H, Bev, LH, Elec, Wht	233	\$ 879.
PLM2030WBRE	19-1/4"W x 30"H, Bev, RH, Elec, Wht	233	\$ 879.
PLM2040G	19-1/4"W x 40"H, Polished, Gray	233	\$ 699.
PLM2040GLE	19-1/4"W x 40"H, Pol, LH, Elec, Gray	233	\$ 979.
PLM2040GRE	19-1/4"W x 40"H, Pol, RH, Elec, Gray	233	\$ 979.
PLM2040GB	19-1/4"W x 40"H, Bevel, Gray	233	\$ 699.
PLM2040GBLE	19-1/4"W x 40"H, Bev, LH, Elec, Gray	233	\$ 979.
PLM2040GBRE	19-1/4"W x 40"H, Bev, RH, Elec, Gray	233	\$ 979.
PLM2040W	19-1/4"W x 40"H, Polished, White	233	\$ 699.
PLM2040WLE	19-1/4"W x 40"H, Pol, LH, Elec, Wht	233	\$ 979.
PLM2040WRE	19-1/4"W x 40"H, Pol, RH, Elec, Wht	233	\$ 979.
PLM2040WB	19-1/4"W x 40"H, Bevel, White	233	\$ 699.
PLM2040WBLE	19-1/4"W x 40"H, Bev, LH, Elec, Wht	233	\$ 979.
PLM2040WBRE	19-1/4"W x 40"H, Bev, RH, Elec, Wht	233	\$ 979.

Model No.	Product	Page	Price
PL Series Cabinets/Components (continued)			
PLM2430G	23-1/4"W x 30"H, Polished, Gray	234	\$ 649.
PLM2430GLE	23-1/4"W x 30"H, Pol, LH, Elec, Gray	234	\$ 929.
PLM2430GRE	23-1/4"W x 30"H, Pol, RH, Elec, Gray	234	\$ 929.
PLM2430GB	23-1/4"W x 30"H, Bevel, Gray	234	\$ 649.
PLM2430GBLE	23-1/4"W x 30"H, Bev, LH, Elec, Gray	234	\$ 929.
PLM2430GBRE	23-1/4"W x 30"H, Bev, RH, Elec, Gray	234	\$ 929.
PLM2430W	23-1/4"W x 30"H, Polished, White	234	\$ 649.
PLM2430WLE	23-1/4"W x 30"H, Pol, LH, Elec, Wht	234	\$ 929.
PLM2430WRE	23-1/4"W x 30"H, Pol, RH, Elec, Wht	234	\$ 929.
PLM2430WB	23-1/4"W x 30"H, Bevel, White	234	\$ 649.
PLM2430WBLE	23-1/4"W x 30"H, Bev, LH, Elec, Wht	234	\$ 929.
PLM2430WBRE	23-1/4"W x 30"H, Bev, RH, Elec, Wht	234	\$ 929.
PLM2440G	23-1/4"W x 30"H, Polished, Gray	234	\$ 749.
PLM2440GLE	23-1/4"W x 30"H, Pol, LH, Elec, Gray	234	\$ 1,029.
PLM2440GRE	23-1/4"W x 30"H, Pol, RH, Elec, Gray	234	\$ 1,029.
PLM2440GB	23-1/4"W x 30"H, Bevel, Gray	234	\$ 749.
PLM2440GBLE	23-1/4"W x 30"H, Bev, LH, Elec, Gray	234	\$ 1,029.
PLM2440GBRE	23-1/4"W x 30"H, Bev, RH, Elec, Gray	234	\$ 1,029.
PLM2440W	23-1/4"W x 30"H, Polished, White	234	\$ 749.
PLM2440WLE	23-1/4"W x 30"H, Pol, LH, Elec, Wht	234	\$ 1,029.
PLM2440WRE	23-1/4"W x 30"H, Pol, RH, Elec, Wht	234	\$ 1,029.
PLM2440WB	23-1/4"W x 30"H, Bevel, White	234	\$ 749.
PLM2440WBLE	23-1/4"W x 30"H, Bev, LH, Elec, Wht	234	\$ 1,029.
PLM2440WBRE	23-1/4"W x 30"H, Bev, RH, Elec, Wht	234	\$ 1,029.
PLSMK30D4P	PL Surface-Mount Kit for 30"H x 4"D	275	\$ 149.
PLSMK40D4P	PL Surface-Mount Kit for 40"H x 4"D	275	\$ 249.
PLGKIT	PL Series Ganging Kit	273	\$ 49.

R³ Series Cabinets/Components

RC1620D4FB1	16"W x 20"H, Bevel	238	\$ 279.
RC1620D4FP1	16"W x 20"H, Polished	238	\$ 279.
RC1626D4FB1	16"W x 26"H, Bevel	238	\$ 429.
RC1626D4FP1	16"W x 26"H, Polished	238	\$ 429.
RC1636D4FB1	16"W x 36"H, Bevel	238	\$ 529.
RC1636D4FP1	16"W x 36"H, Polished	238	\$ 529.
RC2026D4FB1	20"W x 26"H, Bevel	239	\$ 479.
RC2026D4FP1	20"W x 26"H, Polished	239	\$ 479.
RC2036D4FB1	20"W x 36"H, Bevel	239	\$ 649.
RC2036D4FP1	20"W x 36"H, Polished	239	\$ 649.
RC2426D4FB1	24"W x 26"H, Bevel	240	\$ 529.
RC2426D4FP1	24"W x 26"H, Polished	240	\$ 529.
RC2436D4FB1	24"W x 36"H, Bevel	240	\$ 749.
RC2436D4FP1	24"W x 36"H, Polished	240	\$ 749.
RSMK20D4P	R ³ Surface-Mount Kit for 20"H	275	\$ 149.
RSMK26D4P	R ³ Surface-Mount Kit for 26"H	275	\$ 149.
RSMK36D4P	R ³ Surface-Mounting for 36"H	275	\$ 149.

Continued on following page.

Refer to product page for complete description.

Fax: 1-267-540-2053

Terms and conditions of Quick Ship Program subject to change.

ROBERN® Quick Ship Program

- Robern Quick Ship Program is intended for use by Robern's dealers only.
- ROBERN Quick Ship orders must be placed on a separate P.O. Begin your Quick Ship P.O. with "QR" and/or clearly mark the order "Quick Ship".
- Maximum order value for Quick Ship order \$3000 net.
- Net order must exceed \$1000 to get freight pre-paid by ROBERN. If order does not exceed \$1000, shipping charges outlined on page 283 will apply.

- All ROBERN sales and shipping conditions stated on pages 281 – 283 of the 2019 price guide apply.
- Orders will ship within 72 hours of receipt of order.
- Quick Ship orders are non-cancelable.
- The models listed below are the only models available on the Quick Ship Program. These models are also marked throughout the book with a:



Model No.	Product	Page	Price
Lighting/Components			
DLFML76	Main Line Sconce, Chrome	259	\$ 699.
DLFML77	Main Line Sconce, Polished Nickel	259	\$ 699.
UFLPAL	Uplift® Pendant, Anodized Aluminum	258	\$ 699.
UFLPCRL	Uplift Pendant, Polished Chrome	258	\$ 829.
UFLPBNL	Uplift Pendant, Brushed Nickel	258	\$ 829.
UFLPPNL	Uplift Pendant, Polished Nickel	258	\$ 829.
UFLWAL	Uplift Sconce, Anodized Aluminum	258	\$ 699.
UFLWCRL	Uplift Sconce, Polished Chrome	258	\$ 829.
UFLWBNL	Uplift Sconce, Brushed Nickel	258	\$ 829.
UFLWPNL	Uplift Sconce, Polished Nickel	258	\$ 829.
X219-1145	Uplift Bulb: 24W, 3000K, 2G11	258	\$ 99.
ML1.530VFSGCRDN	30"H ML1.5 Lights, Chrome	255	\$ 1,299.
ML1.530VFSGBNDN	30"H ML1.5 Lights, Brushed Nickel	255	\$ 1,299.
ML1.540VFSGCRDN	40"H ML1.5 Lights, Chrome	255	\$ 1,429.
ML1.540VFSGBNDN	40"H ML1.5 Lights, Brushed Nickel	255	\$ 1,429.
PL30GCH	30"H PL 1.5 Lights, Glass, Chrome	255	\$ 1,299.
PL30GWH	30"H PL 1.5 Lights, Glass, White	255	\$ 1,299.
PL30PCH	30"H PL 1.5 Lights, Acrylic, Chrome	255	\$ 1,029.
PL30PWH	30"H PL 1.5 Lights, Acrylic, White	255	\$ 1,029.
PL40GCH	40"H PL 1.5 Lights, Glass, Chrome	255	\$ 1,429.
PL40GWH	40"H PL 1.5 Lights, Glass, White	255	\$ 1,429.
PL40PCH	40"H PL 1.5 Lights, Acrylic, Chrome	255	\$ 1,149.
PL40PWH	40"H PL 1.5 Lights, Acrylic, White	255	\$ 1,149.
ML3.530ILSFMRD3	30"H 3.5 InLine Lights, 3000K	253	\$ 829.
ML3.530ILSFMRD4	30"H 3.5 InLine Lights, 4000K	253	\$ 829.
ML3.530ILSFMRDV	30"H 3.5 InLine Lights, Variable	253	\$ 979.
ML3.540ILSFMRD3	40"H 3.5 InLine Lights, 3000K	253	\$ 929.
ML3.540ILSFMRD4	40"H 3.5 InLine Lights, 4000K	253	\$ 929.
ML3.540ILSFMRDV	40"H 3.5 InLine Lights, Variable	253	\$ 1,099.
ML3.530RFSBCRNN	30"H Reflexion®, Chrome, Bevel	256	\$ 1,349.
ML3.530RFSBBNNN	30"H Reflexion, Brush Nickel, Bevel	256	\$ 1,349.
ML3.530RFSPCRNN	30"H Reflexion, Chrome, Pencil	256	\$ 1,349.
ML3.530RFSPBNNN	30"H Reflexion, Brush Nickel, Pencil	256	\$ 1,349.
ML3.540RFSBCRNN	40"H Reflexion, Chrome, Bevel	256	\$ 1,479.
ML3.540RFSBBNNN	40"H Reflexion, Brush Nickel, Bevel	256	\$ 1,479.
ML3.540RFSPCRNN	40"H Reflexion, Chrome, Pencil	256	\$ 1,479.
ML3.540RFSPBNNN	40"H Reflexion, Brush Nickel, Pencil	256	\$ 1,479.
RGKIT	Reflexion Light Ganging Kit	273	\$ 49.
1.5GKIT	1.5 Series Light Ganging Kit	273	\$ 49.

Model No.	Product	Page	Price
Cabinet/Vanity Accessories			
CAMM	Compact Adj. Magnification Mirror	272	\$ 49.
ENTICE	Entice® Magnification Mirror	272	\$ 449.
ENTICEDOCK	Entice Magnification Mirror w/Dock	272	\$ 499.
POMM	Pull-Out Magnifying Mirror	272	\$ 229.
SOMM	Silver Swing-Out Magnifying Mirror	272	\$ 99.
SLB-*	Safety Lock Box	272	\$ 279.
GLASSBIN3.25	Glass Bin, Small	268	\$ 49.
GLASSBIN5.25	Glass Bin, Medium	268	\$ 49.
GLASSBIN8.5	Glass Bin, Large	268	\$ 49.
GLASSBIN6.38	Glass Bin, Divided Storage	268	\$ 49.
MA-TRAY2.5	Razor/Phone Holder Accessory Tray	272	\$ 29.
MA-TRAY3	3" Accessory Tray	272	\$ 29.
MA-TRAY5	5" Accessory Tray	272	\$ 29.
MHANDLEKIT	Chrome Handle	272	\$ 179.
MPUSHKIT	Push-to-Open Mechanism	272	\$ 99.
VAELECTRIC21	Vanity Electric Accessory, 21"	266	\$ 449.
VAHAIRORG	Vanity Hair Styling Organizer	266	\$ 229.
VMGKITH1	Vanity Ganging Kit, 7-1/2"H	269	\$ 99.
VMGKITH2	Vanity Ganging Kit, 15"H	269	\$ 99.
VMGKITH3	Vanity Ganging Kit, 22-1/2"H	269	\$ 229.
VMGKITH4	Vanity Ganging Kit, 30"H	269	\$ 229.

Refer to product page for complete description.

Fax: 1-267-540-2053

Terms and conditions of Quick Ship Program subject to change.

AiO® Lighted Mirrors – Table of Contents, Tips & Features

Table of Contents

AiO Lighted Mirrors 27

Tips & Features

Dimensions & Weight

- Width:
23-1/8" (587 mm)
29-1/8" (740 mm)
35-1/8" (892 mm)
- Height:
29-7/8" (759 mm)
39-1/4" (997 mm)
69-7/8" (1775 mm)
- Depth: 1-1/2" (38 mm)
- Net Weight: 45 – 75 lbs

Features & Benefits

- OM_® Audio: built-in speakers with a range up to 30 feet with a 2 channel stereo at 20 watts/channel. Bluetooth connectivity supports most Android and iOS devices. Volume controlled by device
- LUM_™ Lighting: Integrated dimmable LED lights and one-touch lighting control with capacitive-touch switch built into the mirror
- Choose between warm, relaxing tones (2700K) that replicate indoor lighting or cool, invigorating tones (4000K), which simulate bright daylight
- Light direction and output eliminates dark shadows, provides bright even task lighting and rich, saturated tone in your reflection
- Remarkably accurate color rendering with a CRI value of 90+ and R9 of 50+, so you can see your truest reflection
- Dimmable lighting lets you select the ideal brightness for any task, using a standard dimmer that works with existing wiring
- Energy efficient LEDs with an estimated life of 53,000 hours
- Includes two USB charging ports
- Hang in portrait orientation only
- Constructed to operate in high humidity or damp spaces. ETL certified to UL 1598, CSA Standard C22.2, No. 250.0

Configurable Options

- Audio: OM audio or non-audio version
- Color Temperature: 2700K or 4000K

Construction

- Durable rust-free anodized aluminum and glass construction – glass resists intense moisture, ensures long-lasting beauty
- Powder coated steel back frame
- Quality polished edge mirror
- Constructed for surface mounting

Installation

- Installation may require more than one person
- Single field wire installation; hardwire to a wall or a switch (120 VAC 60 Hz 1.2A)
- 1/2" conduit (7/8" actual) electrical knockout
- Includes installation hardware with easy installation via Pinch Cleat Mounting System and back pan design for easy wiring

Lighting Specs

Kelvin	2700K 4000K
CRI	90+
Lumens ¹	1250
Lux ^{1, 2}	710
R9 Value ¹	50+
Foot-candles ^{1, 2}	66

¹ Measured on a 24" W x 30" H model

² Measured at 18" from center of the mirror

Efficacy (LED Source)

Watts per Foot	8.8
Lumens per Foot	610
Lumens per Watt	69



AiO[®] Lighted Mirrors



For a mirror with a minimalist aesthetic that provides the perfect task lighting and is easy to use, our AiO Lighted Mirror combines a mirror, fine tuned audio capability, warm or cool task lighting, and an integrated USB port for a connected experience in your styling space.

- **OM[®] Audio:** built-in speakers with Bluetooth connectivity supports most Android and iOS devices. Volume controlled by device
- **LUM[™] Lighting:** integrated dimmable LED lights and one-touch lighting control with capacitive-touch switch built into the mirror
- Choose between warm, relaxing tones (2700K) that replicate indoor lighting or cool, invigorating tones (4000K), which simulate bright daylight
- Includes two USB charging ports



Two Week Lead Time



Audio/Bluetooth[®]



USB Charging



Dimmable LED

AiO Lighted Mirrors

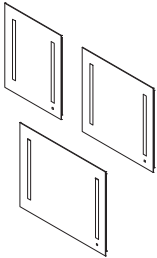
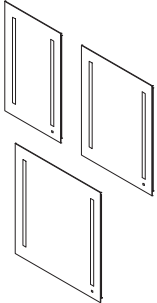
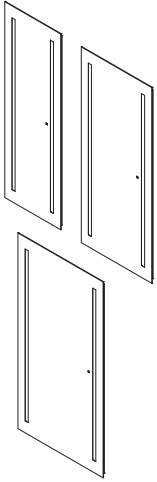
Description	2700K	4000K	Price	2700K With Audio	4000K With Audio	Price
AiO 30" H Mirrors						
 23-1/8" W x 29-7/8" H x 1-1/2" D	AM2430RFPW	AM2430RFP	\$ 1,429.	AM2430RFPW	AM2430RFP	\$ 1,849.
29-1/8" W x 29-7/8" H x 1-1/2" D	AM3030RFPW	AM3030RFP	\$ 1,599.	AM3030RFPW	AM3030RFP	\$ 2,049.
35-1/8" W x 29-7/8" H x 1-1/2" D	AM3630RFPW	AM3630RFP	\$ 1,779.	AM3630RFPW	AM3630RFP	\$ 2,229.
AiO 40" H Mirrors						
 23-1/8" W x 39-1/4" H x 1-1/2" D	AM2440RFPW	AM2440RFP	\$ 1,699.	AM2440RFPW	AM2440RFP	\$ 2,149.
29-1/8" W x 39-1/4" H x 1-1/2" D	AM3040RFPW	AM3040RFP	\$ 1,849.	AM3040RFPW	AM3040RFP	\$ 2,299.
35-1/8" W x 39-1/4" H x 1-1/2" D	AM3640RFPW	AM3640RFP	\$ 2,049.	AM3640RFPW	AM3640RFP	\$ 2,499.
AiO Full Length Mirrors						
 23-1/8" W x 69-7/8" H x 1-1/2" D	N/A	AM2470RFP	\$ 3,099.	N/A	N/A	N/A
29-1/8" W x 69-7/8" H x 1-1/2" D	N/A	AM3070RFP	\$ 3,329.	N/A	N/A	N/A
35-1/8" W x 69-7/8" H x 1-1/2" D	N/A	AM3670RFP	\$ 3,549.	N/A	N/A	N/A

 **Note:** Models in **bold** indicate Quick Ship product.

SEE PAGE 26 FOR TIPS AND FEATURES.

Profiles™ Framed Mirrors – Table of Contents, Tips & Features

Table of Contents

Profiles Framed Mirrors 29

Profiles Framed Cabinets 159 – 177

Profiles Lighting Options 249 – 251

Tips & Features

Dimensions & Weight

- Width:
23-1/8" (587 mm)
29-7/8" (759 mm)
35-7/8" (911 mm)
- Height:
29-7/8" (759 mm)
39-1/4" (997 mm)
- Depth: 3/4" (19 mm);
15/16" (24 mm) when ganged with
vertical lighting or medicine cabinets
- Net Weight: 12 – 21 lbs

Features & Benefits

- Match all fixtures in your styling space with Profiles metal frame finishes for a coordinated look: Chrome, Polished Nickel, Matte Gold, Matte Black
- Modular mirrors can be ganged with Profiles Lighting and Profiles Medicine Cabinets with optional ganging kit
- Hang in portrait orientation only
- Pair with Profiles Medicine Cabinets when storage is needed and Profiles Lighting to create task lighting in your styling space
- Create a coordinated ensemble by pairing with Profiles Medicine Cabinets, Profiles Lighting and Profiles Vanities

Configurable Options

- Metal Frame Finishes:
Chrome, Polished Nickel, Matte Gold, Matte Black

Construction

- Durable rust-free anodized aluminum and glass construction – glass resists intense moisture, ensures long-lasting beauty
- Constructed for surface mounting

Installation

- This installation may require more than one person
- Includes installation hardware with easy installation via Pinch Cleat Mounting System
- For ganging with Profiles Medicine Cabinets or Profiles Lighting, a mirror ganging kit is needed to ensure flush alignment
- If ganging with Profiles Lighting, the existing ganging feature found on one side will need to be removed and the mirror ganging kit (PMGKIT – sold separately) will need to be installed

Accessories

- Ganging Kit (PMGKIT___)



Profiles™ Framed Mirrors



Put the finishing touches on your ensemble with a Profiles Mirror in coordinating metal finishes, and add Profiles lighting to create a stylish and functional getting-ready space. Profiles mirrors are available in portrait orientation but can easily be ganged together, or connected to a Profiles medicine cabinet, to extend their visual impact.

- Match all fixtures in your styling space with Profiles metal frame finishes for a coordinated look: Chrome, Polished Nickel, Matte Gold, Matte Black
- Create a coordinated ensemble by pairing with Profiles medicine cabinets, Profiles lighting and Profiles vanities
- Modular mirrors can be ganged with Profiles lighting and Profiles medicine cabinets with optional ganging kit
- Pair with Profiles medicine cabinets when storage is needed and Profiles lighting to create task lighting in your styling space



Two Week
Lead Time



Modular

Profiles Wall Mirrors

	Description	Model	FRAME FINISHES	
			76, 77 Price	82, 83 Price
Profiles 30" H Mirrors				
	23-1/8" W x 29-7/8" H x 3/4" D	PM2430T __	\$ 1,049.	\$ 1,149.
	29-7/8" W x 29-7/8" H x 3/4" D	PM3030T __	\$ 1,079.	\$ 1,199.
	36" W x 29-7/8" H x 3/4" D	PM3630T __	\$ 1,199.	\$ 1,299.
Profiles 40" H Mirrors				
	23-1/8" W x 39-1/4" H x 3/4" D	PM2440T __	\$ 1,149.	\$ 1,279.
	29-7/8" W x 39-1/4" H x 3/4" D	PM3040T __	\$ 1,249.	\$ 1,349.
	36" W x 39-1/4" H x 3/4" D	PM3640T __	\$ 1,349.	\$ 1,479.

Frame Finish Options

Fill in __ designator to Model listed above with desired finish. Example: **PM2430T77**.

76 Chrome

77 Polished Nickel

82 Matte Gold

83 Matte Black

Accessories & Options

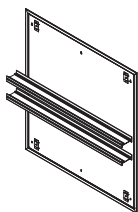

Description	Model	Price
Profiles Mirror/Lighting Ganging Kit		
Hardware required for ganging Profiles Mirrors with Profiles Lighting and Cabinets		
24x30	PMGKIT2430	\$ 379.
30x30	PMGKIT3030	\$ 429.
36x30	PMGKIT3630	\$ 479.
24x40	PMGKIT2440	\$ 379.
30x40	PMGKIT3040	\$ 429.
36x40	PMGKIT3640	\$ 479.

SEE PAGE 28 FOR TIPS AND FEATURES.

Vitality™ Lighted Mirrors – Table of Contents, Tips & Features

Table of Contents

Vitality Lighted Mirrors **32 – 33**

 Rectangle 32

 Circle 33

Tips & Features

Dimensions & Weight

- Width:
24" (610 mm)
30" (762 mm)
36" (914 mm)
- Height/Diameter:
30" (762 mm)
40" (1016 mm)
- Title 24 Dimensions (W x H):
24" x 30" (610 mm x 762 mm)
24" x 40" (610 mm x 1016 mm)
30" x 40" (762 mm x 1016 mm)
36" x 40" (914 mm x 1016 mm)
- Depth: 1-3/4" (44 mm)
- Net Weight: 23 – 39 lbs

Features & Benefits

- Choose between warm, relaxing tones (2700K) that replicate indoor lighting or cool, invigorating tones (4000K), which simulate bright daylight
- Light direction and output eliminates dark shadows, provides bright, even task lighting and rich, saturated tone in your reflection
- Dimmable LED task lighting lets you select the ideal brightness for any task, using a standard dimmer that works with existing wiring. The mirror's LED task lighting provides continuously dimmable brightness to 1%
- Defogging technology ensures a clear reflection using a standard wall switch
- Energy efficient LEDs with an estimated life of 53,000 hours
- Compatible with most Triac/Phase-cut dimmers; 0-10V for custom projects
- Constructed to operate in high humidity or damp spaces. ETL/UL Certified for damp locations to UL 962, CSA Standard C22.2, No. 12-82

Title 24 Compliant Models

NEW!

- LED mirror models (K) tested and certified to California Title 24 standards and meet JA8 2016 requirements
- The Title 24 certified LED mirror has up to 60% more lumen output than the standard model. This increases the overall brightness of warm white light that illuminates your space and reflection
- The mirror's LED task lighting exceeds Title 24 requirements (< 10% minimum dimming level) with continuously dimmable brightness to 1%
- Vacancy and dimmer recommendation: Maestro C•L Dimmer and Motion Sensor

Configurable Options

- Mirror Styles: Inset Rectangle, Perimeter Rectangle, Column Rectangle, Inset Circle, Perimeter Circle, Title 24 Compliant Perimeter Rectangle
- Color Temperature: 2700K or 4000K

Construction

- Durable rust-free anodized aluminum and glass construction – glass resists intense moisture, ensures long-lasting beauty
- Quality polished edge mirror
- Constructed for surface mounting

For a Framed solution, see pages 23 – 25.



Tips & Features (Continued)

Installation

- Installation may require more than one person
- Includes installation hardware with easy installation via Plug and Hang System:
 - Install mirror by plugging into an outlet behind the mirror, eliminating the need to bring back an electrician to install or remove – making it a cinch for both new construction and renovations. Works in all North American outlets
 - Hang the mirror using a pinch cleat mounting system, which provides strength and simplicity to the installation process
- Requires 120 VAC 20 amp GFCI circuit protected wall outlet (configured as detailed in installation instructions)
- Mirror functions (lighting, defogger) operated using standard residential dimmers and switches, available separately through electrical supply and home improvements centers
- Dimmer recommendation:
 - C•L® Dimmers or Caseta Wireless from LUTRON®
- For on/off (no dimmer) operation, a standard wall switch may be substituted in place of the dimmer

Lighting Specs: Standard Vitality

Kelvin	2700K 4000K
CRI	90+
Lumens ¹	746 – 1488
Lux ^{1, 2}	275 – 690
R9 Value ¹	50+
Foot-candles ^{1, 2}	26 – 64

¹ Based on a measurement of a subset of sizes, shapes and lighting styles

² Measured at 18" from center of the mirror

Efficacy (LED Source)

Watts per Foot	3 – 6
Lumens per Foot	170 – 400
Lumens per Watt	68

Lighting Specs: Title 24 Vitality

Kelvin	2700K
CRI	90+
Lumens	3071
Lux ²	345
R9 Value	50+
Foot-candles ²	32

² Measured at 18" from center of the mirror

³ Based on 36" x 40" Perimeter Vitality Mirror that supports Title 24 Compliance

For a Framed solution, see pages 23 – 25.



Vitality™ Lighted Mirrors

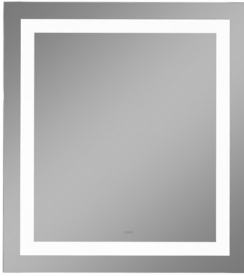

Perfect light is now within reach. The Vitality Lighted Mirror Collection enhances your everyday routine with the highest quality of lighting in its class.

- Choose between two Kelvin ratings to create warm mood lighting or cool, energizing task lighting
- Dimmable lighting lets you select the ideal brightness for any task
- Defogging technology ensures a clear reflection
- Select models tested and certified to California Title 24 standards and meets JA8 2016 requirements



Two Week Lead Time



Defogger



Dimmable LED



Title 24 Compliant

Vitality Lighted Mirrors – Rectangle

	Description	2700K	4000K	Price	
Rectangle – Column					
	24" W x 30" H x 1-3/4" D	YM2430RCFPD3	YM2430RCFPD4	\$ 549.	
	30" W x 30" H x 1-3/4" D	YM3030RCFPD3	YM3030RCFPD4	\$ 679.	
	36" W x 30" H x 1-3/4" D	YM3630RCFPD3	YM3630RCFPD4	\$ 779.	
	24" W x 40" H x 1-3/4" D	YM2440RCFPD3	YM2440RCFPD4	\$ 599.	
	30" W x 40" H x 1-3/4" D	YM3040RCFPD3	YM3040RCFPD4	\$ 729.	
	36" W x 40" H x 1-3/4" D	YM3640RCFPD3	YM3640RCFPD4	\$ 829.	
Rectangle – Perimeter					
	24" W x 30" H x 1-3/4" D	YM2430RPPD3	N/A	\$ 729.	
	Title 24 – 24" W x 30" H x 1-3/4" D NEW!	YM2430RPPD3K	N/A	\$ 899.	
	30" W x 30" H x 1-3/4" D	YM3030RPPD3	N/A	\$ 829.	
	36" W x 30" H x 1-3/4" D	YM3630RPPD3	N/A	\$ 949.	
	24" W x 40" H x 1-3/4" D	YM2440RPPD3	N/A	\$ 779.	
	Title 24 – 24" W x 40" H x 1-3/4" D NEW!	YM2440RPPD3K	N/A	\$ 949.	
	30" W x 40" H x 1-3/4" D	YM3040RPPD3	N/A	\$ 879.	
	Title 24 – 30" W x 40" H x 1-3/4" D NEW!	YM3040RPPD3K	N/A	\$ 1,049.	
	36" W x 40" H x 1-3/4" D	YM3640RPPD3	N/A	\$ 999.	
	Title 24 – 36" W x 40" H x 1-3/4" D NEW!	YM3640RPPD3K	N/A	\$ 1,149.	
	Rectangle – Inset				
		24" W x 30" H x 1-3/4" D	YM2430RIFPD3	YM2430RIFPD4	\$ 779.
30" W x 30" H x 1-3/4" D		YM3030RIFPD3	YM3030RIFPD4	\$ 879.	
36" W x 30" H x 1-3/4" D		YM3630RIFPD3	YM3630RIFPD4	\$ 999.	
	24" W x 40" H x 1-3/4" D	YM2440RIFPD3	YM2440RIFPD4	\$ 829.	
	30" W x 40" H x 1-3/4" D	YM3040RIFPD3	YM3040RIFPD4	\$ 949.	
	36" W x 40" H x 1-3/4" D	YM3640RIFPD3	YM3640RIFPD4	\$ 1,049.	

Note: Models in **bold** indicate Quick Ship product.

SEE PAGES 30 – 31 FOR TIPS AND FEATURES.

Vitality™ Lighted Mirrors

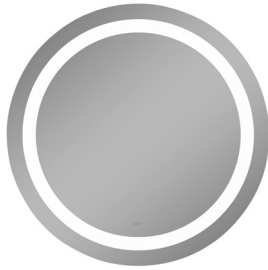

Perfect light is now within reach. The Vitality Lighted Mirror Collection enhances your everyday routine with the highest quality of lighting in its class.

- Choose between two Kelvin ratings to create warm mood lighting or cool, energizing task lighting
- Dimmable lighting lets you select the ideal brightness for any task
- Defogging technology ensures a clear reflection



Two Week Lead Time



Defogger



Dimmable LED

Vitality Lighted Mirrors – Circle

	Description	2700K	4000K	Price
Circle – Perimeter				
	30" Diameter x 1-3/4" D	YM0030CPFPD3	N/A	\$ 829.
	40" Diameter x 1-3/4" D	YM0040CPFPD3	N/A	\$ 999.
Circle – Inset				
	30" Diameter x 1-3/4" D	YM0030CIFPD3	YM0030CIFPD4	\$ 879.
	40" Diameter x 1-3/4" D	YM0040CIFPD3	YM0040CIFPD4	\$ 1,049.

Note: Models in **bold** indicate Quick Ship product.

SEE PAGES 30 – 31 FOR TIPS AND FEATURES.

Main Line Framed Mirrors – Table of Contents, Tips & Features

Table of Contents

Main Line Framed Mirrors 35

Tips & Features

Dimensions & Weight

- Width:
15-3/8" (391 mm)
19-3/8" (492 mm)
23-3/8" (594 mm)
- Height:
30-1/16" (764 mm)
39-1/2" (1003 mm)
- Depth: 1-5/8" (44 mm)
- Net Weight: 19 – 37 lbs

Features & Benefits

- Available in four uniquely designed frame options: Bryn Mawr®, Merion®, Penn Valley®, Rosemont®
- Frame options available in 7 metal finish options
- Pair with Main Line Sconces for a coordinated look
- Hang in portrait orientation only

Configurable Options

- Mirror Styles:
Bryn Mawr, Merion, Penn Valley, Rosemont
- Frame Finishes:
Chrome, Polished Nickel, Satin Nickel,
Brushed Bronze, Brushed Black, White

Construction

- Durable rust-free anodized aluminum and glass construction – glass resists intense moisture, ensures long-lasting beauty
- Satin anodized aluminum back frame
- Frame width:
1-3/4" for Bryn Mawr, 2-9/16" for Merion,
1-1/16" for Penn Valley and 13/16" for Rosemont

Installation

- This installation may require more than one person
- Supplied with concealed mounting hardware

Frame Details & Dimensions

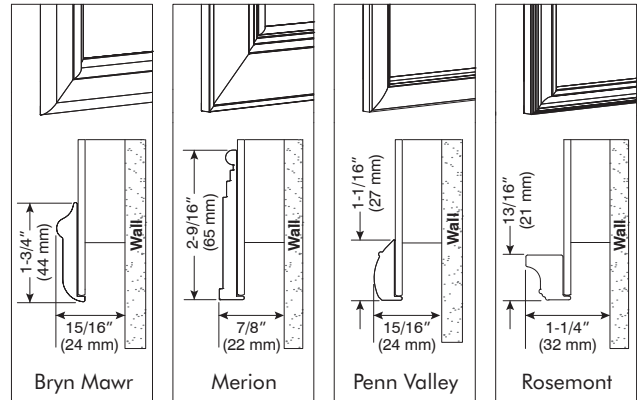

Main Line Framed Mirrors



Available in four distinct frame styles and seven metal finishes, Main Line framed mirrors ensure that you're looking your best from all angles.

- Available in four uniquely designed frame options: Bryn Mawr®, Merion®, Penn Valley®, Rosemont®
- Pair with Main Line Sconces for a coordinated look
- Wall mirrors can only be hung in portrait orientation



Two Week
Lead Time

Main Line Framed Wall Mirrors

Description	Model	FINISHES			
		70, 71 Price	74, 75, 79 Price	76, 77 Price	
Bryn Mawr Framed Wall Mirrors					
	15-1/8" W x 29-7/8" H	DM1630BM __	\$ 549.	\$ 679.	\$ 879.
	19-1/8" W x 29-7/8" H	DM2030BM __	\$ 679.	\$ 779.	\$ 999.
	23-1/8" W x 29-7/8" H	DM2430BM __	\$ 779.	\$ 879.	\$ 1,099.
	15-1/8" W x 39-7/8" H	DM1640BM __	\$ 779.	\$ 879.	\$ 1,099.
	19-1/8" W x 39-7/8" H	DM2040BM __	\$ 879.	\$ 999.	\$ 1,229.
	23-1/8" W x 39-7/8" H	DM2440BM __	\$ 999.	\$ 1,099.	\$ 1,329.
Merion Framed Wall Mirrors					
	15-1/8" W x 29-7/8" H	DM1630ME __	\$ 549.	\$ 679.	\$ 879.
	19-1/8" W x 29-7/8" H	DM2030ME __	\$ 679.	\$ 779.	\$ 999.
	23-1/8" W x 29-7/8" H	DM2430ME __	\$ 779.	\$ 879.	\$ 1,099.
	15-1/8" W x 39-7/8" H	DM1640ME __	\$ 779.	\$ 879.	\$ 1,099.
	19-1/8" W x 39-7/8" H	DM2040ME __	\$ 879.	\$ 999.	\$ 1,229.
	23-1/8" W x 39-7/8" H	DM2440ME __	\$ 999.	\$ 1,099.	\$ 1,329.
Penn Valley Framed Wall Mirrors					
	15-1/8" W x 29-7/8" H	DM1630PV __	\$ 549.	\$ 679.	\$ 879.
	19-1/8" W x 29-7/8" H	DM2030PV __	\$ 679.	\$ 779.	\$ 999.
	23-1/8" W x 29-7/8" H	DM2430PV __	\$ 779.	\$ 879.	\$ 1,099.
	15-1/8" W x 39-7/8" H	DM1640PV __	\$ 779.	\$ 879.	\$ 1,099.
	19-1/8" W x 39-7/8" H	DM2040PV __	\$ 879.	\$ 999.	\$ 1,229.
	23-1/8" W x 39-7/8" H	DM2440PV __	\$ 999.	\$ 1,099.	\$ 1,329.
Rosemont Framed Wall Mirrors					
	15-1/8" W x 29-7/8" H	DM1630RM __	\$ 549.	\$ 679.	\$ 879.
	19-1/8" W x 29-7/8" H	DM2030RM __	\$ 679.	\$ 779.	\$ 999.
	23-1/8" W x 29-7/8" H	DM2430RM __	\$ 779.	\$ 879.	\$ 1,099.
	15-1/8" W x 39-7/8" H	DM1640RM __	\$ 779.	\$ 879.	\$ 1,099.
	19-1/8" W x 39-7/8" H	DM2040RM __	\$ 879.	\$ 999.	\$ 1,229.
	23-1/8" W x 39-7/8" H	DM2440RM __	\$ 999.	\$ 1,099.	\$ 1,329.

Finish Options

Fill in __ designator to Model listed above with desired finish. Example: **DC1640BM74**.

70	Satin Nickel	76	Chrome
71	Brushed Nickel	77	Polished Nickel
74	Brushed Black	79	White
75	Brushed Bronze		

SEE PAGE 34 FOR TIPS AND FEATURES.

NEW!

Table of Contents

Profiles Vanity with Antique Mirror Glass Tips & Features	45 – 46
Profiles Vanities with Antique Mirror Glass	48 – 48
Vanity Tops	128 – 135
Profiles Vanity Undermount Bowl Space Availability	136
Vanity Accessories	265 – 270

Tips & Features

Dimensions & Weight

- Dimensions (W x H):
30" x 22-1/2" (762 mm x 572 mm)
60" x 22-1/2" (1524 mm x 572 mm)
- Depth: 21-3/4" (552 mm)
- Net Weight: 72 – 127 lbs

Features & Benefits

- Exclusive offering available:
Antique Mirror options in Arcobaleno with a Matte Gold frame finish and Luna with a Matte Black frame finish
- Arcobaleno and Luna patterns are unique and unrepeatable which means no two pieces are alike due to the handcrafted quality of this product
- Match fixtures in your styling space with Matte Gold and Matte Black metal frame finishes for a coordinated look
- Create a coordinated ensemble by pairing with Profiles Medicine Cabinets, Profiles Lighting and Profiles Mirrors
- Tip out drawer (H1) gives storage back by providing a drawer for smaller items and full slow-close drawer (H2) allows for maximum storage
- Uniquely designed handleless ergonomic drawer, allows for a comfortable feel and effortless operation
- Organization kit for H2 (15" H): two fully adjustable glass drawer dividers provide storage right where you need it and prevent items from moving and sliding in the drawer
- Night light – integrated LED night light with light bar built into top frame of each drawer, provides soft light to illuminate drawer interior and for wayfinding light in selectable 2700 Kelvin/4000 Kelvin. Night light is ETL certified to UL 2108, CSA Standard C22.2 No. 12
- Electric accessory option: three plugs and a switch that turns off power to the unit to keep appliances safely plugged in

Configurable Options

- Vanity Styles:
Powder Room (30" W)
Master Bath (60" W)
- Decorative Options:
Arcobaleno with a Matte Gold frame finish
Luna with a Matte Black frame finish

Construction

- Durable rust-free anodized aluminum and glass construction – glass resists intense moisture, ensuring long-lasting beauty
- Slow-close full-extension slides combined with the durability of aluminum construction ensure smooth operation of the vanity drawers that will last a lifetime
- Constructed for wall hanging loads with stone tops
- Glass fronts and side kits are replaceable
- Industrial grade installation hardware
- White shatter-protected glass drawer bottoms will not degrade or show wear. Glass dissipates heat to ensure confidence that hot items will not leave heat marks on the bottom of the drawers

Available at select locations. Visit robern.com/antiquemirror for where to buy.



Profiles™ Vanities with Antique Mirror Glass – Tips & Features

Tips & Features (Continued)

Installation

- This installation may require more than one person
- Includes installation hardware and structural bolts
- Special site preparation is required. Wall bracing and Robern supplied hardware are recommended
- The plumbing must be roughed into the plumbing cutout area of the vanity. Refer to the sink rough-in and the vanity rough-in for proper placement. The water supply and drain lines must be installed before installing the vanity.
- Components needed for stacking are included with each vanity; ganging kit sold separately for the 60" configuration
- Side kits are sold separately to allow for customization and are available as pairs
- Each design offers the necessary 15" plumbing clearance needed to clear the pipes
- Night light (S) – 12VDC plug-in transformer. Option of two color temperatures for one night light: 2700 or 4000 Kelvin. The vanity is preconfigured at 2700K. Night light can be reconfigured to 4000K at time of installation, see installation instructions for more information
- Electric Accessory option: 120VAC 20A tamper resistant outlet. Installed within 15" H (H2) vanity drawer; not recommended to be used in combination with Slim Drawer Insert; recommended in combination with Hair Styling Organizer
- Slim plumbing drawer insert must be used with a sink installation – includes four glass bins and only available for 15" H (H2) vanities
- Hair Styling Organizer fits all 15" H (H2) full vanity drawers; cannot be used in combination with slim plumbing drawer insert; recommended in combination with Electric Accessory

Accessories

- In-drawer Electric Accessory (VAELECTRIC21): ETL certified to UL 1363, CSA Standard C22.2 No. 21; to be used in 15" H (H2) vanity drawers only
- Hair Styling Organizer (VAHAIRORG): fits most hair dryers and curling irons – to be used in 15" H (H2) vanity drawers only
- Slim Plumbing Drawer insert with four glass bins (VADRAWER30P) – to be used in 15" H (H2) vanity drawers only
- Glass Bins: divided storage (GLASSBIN6.38), small (GLASSBIN3.25), medium (GLASSBIN5.25), large (GLASSBIN8.5)
- Glass (30" W only) and engineered stone tops with porcelain sink
- Glass side kits sold separately as a pair. Available in 22-1/2" (H3) height and 21" depth
- Ganging kits are required for the 60" W configuration. One 22-1/2" (H3) ganging kit is needed to gang the vanity drawers together
- Alcove finishing kits are required for corner or alcove installations and is available in 22-1/2" (H3) height

Available at select locations. Visit robern.com/antiquemirror for where to buy.



Profiles™ Vanity with Antique Mirror Glass

NEW!



The stunning and versatile Profiles Collection welcomes two new dramatic Italian glass options to the lineup: antique mirror in Arcobaleno and Luna.

- Antique Mirror options in Arcobaleno with a Matte Gold frame finish and Luna with a Matte Black frame finish
- Arcobaleno and Luna patterns are unique and unrepeatable which means no two pieces are alike due to the handcrafted quality of this product



Four Week Lead Time



Modular



Electrical Outlet



Night Light

Vanities & Tops

Powder Room – 30" W x 22-1/2" H x 22-3/4" D

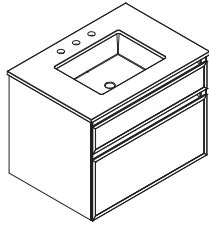

Description	Model	Qty.	Price Each
Arcobaleno Antique Mirror – Consists of:			
Profiles Framed Vanity, 30" W x 7-1/2" H x 21" D, Matte Gold Frame, Tip Out Drawer, Selectable Night Light: 2700K/4000K Temperature	VP30H1D21T58S82	1	\$ 3,399.
Profiles Framed Vanity, 30" W x 15" H x 21" D, Matte Gold Frame, Full Drawer, Selectable Night Light: 2700K/4000K Temperature	VP30H2D21F58S82	1	\$ 3,599.
Profiles Pair of Side Kits, 7/8" W x 22-1/2" H x 21" D	VM2SKH3D21-58	1	\$ 1,199.
Luna Antique Mirror – Consists of:			
Profiles Framed Vanity, 30" W x 7-1/2" H x 21" D, Matte Black Frame, Tip Out Drawer, Selectable Night Light: 2700K/4000K Temperature	VP30H1D21T59S83	1	\$ 3,399.
Profiles Framed Vanity, 30" W x 15" H x 21" D, Matte Black Frame, Full Drawer, Selectable Night Light: 2700K/4000K Temperature	VP30H2D21F59S83	1	\$ 3,599.
Profiles Pair of Side Kits, 7/8" W x 22-1/2" H x 21" D	VM2SKH3D21-59	1	\$ 1,199.

Master Bath – 60" W x 22-1/2" H x 22-3/4" D

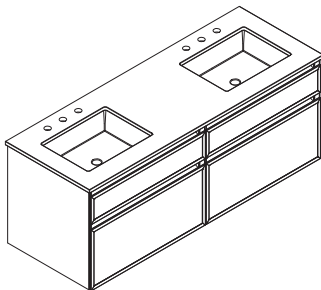

Description	Model	Qty.	Price Each
Arcobaleno Antique Mirror – Consists of:			
Profiles Framed Vanity, 30" W x 7-1/2" H x 21" D, Matte Gold Frame, Tip Out Drawer, Selectable Night Light: 2700K/4000K Temperature	VP30H1D21T58S82	2	\$ 3,399.
Profiles Framed Vanity, 30" W x 15" H x 21" D, Matte Gold Frame, Full Drawer, Selectable Night Light: 2700K/4000K Temperature	VP30H2D21F58S82	2	\$ 3,599.
Profiles Pair of Side Kits, 7/8" W x 22-1/2" H x 21" D	VM2SKH3D21-58	1	\$ 1,199.
Profiles 22-1/2" H Ganging Kit	VMGKITH3	1	\$ 229.
Luna Antique Mirror – Consists of:			
Profiles Framed Vanity, 30" W x 7-1/2" H x 21" D, Matte Black Frame, Tip Out Drawer, Selectable Night Light: 2700K/4000K Temperature	VP30H1D21T59S83	2	\$ 3,399.
Profiles Framed Vanity, 30" W x 15" H x 21" D, Matte Black Frame, Full Drawer, Selectable Night Light: 2700K/4000K Temperature	VP30H2D21F59S83	2	\$ 3,599.
Profiles Pair of Side Kits, 7/8" W x 22-1/2" H x 21" D	VM2SKH3D21-59	1	\$ 1,199.
Profiles 22-1/2" H Ganging Kit	VMGKITH3	1	\$ 229.

See Vanity Tops, Accessories & Options on the following page.

Profiles™ Vanity with Antique Mirror Glass

31" W x 22" D Vanity Tops – For 21" D Vanities

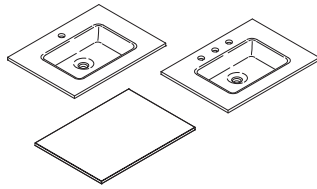

Description	For Use With Vanity	See Page
TS31UCN __ Glass Vanity Top	Plumbing & Tip Out Drawer	129
TF31UCO __ Engineered Stone Vanity Top	Plumbing & Tip Out Drawer	129
TF31G __ Engineered Stone Vanity Top (No Sink)	30" W Vanities	129
TF61G __ Engineered Stone Vanity Top (No Sink)	60" W Vanities	133

Undercounter Sink available for Custom Countertop – see page 135.

Accessories & Options

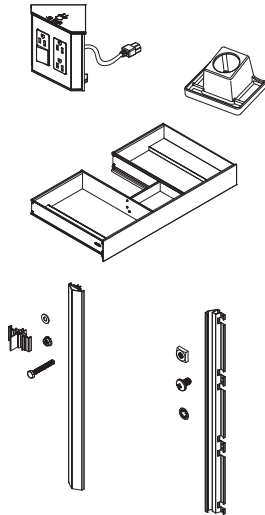

Description	Model	Price
Electric Accessory For use in 15" H full drawer (H2)	VAELECTRIC21	\$ 449.
Hair Styling Organizer For use in 15" H full drawer (H2)	VAHAIRORG	\$ 229.
Slim Drawer Insert For use in 15" H vanity full drawer	VADRAWER30X	\$ 729.
Vanity Ganging Kit – Hardware required when combining two or more vanities 22-1/2" H	VMGKITH3	\$ 229.
Vanity Alcove Finishing Kit – Hardware required for corner or alcove installations 22-1/2" H	VMAKITH3	\$ 229.

See additional Accessories on pages 266 – 268.

Vanity Side Kits

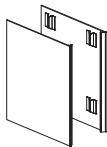

Description	Model	Stock Colors	Classic Colors	Special Order Colors	Antique Mirror Colors
Vanity Side Kits – Includes glass panel(s) & hardware (see Color Options below)					
Pair, 22-1/2" H, 21" D	VM2SKH3D21- __	\$ 549.	\$ 679.		\$ 799.

Profiles Side Kit Color Options

Fill in __ designator to Model listed above with desired color. Example: VM2SKH3D21-20.

Stock Colors	Classic Colors	Special Order Colors	Antique Mirror Colors
10 Mirror	22 Beach	12 Satin Bronze	58 Arcobaleno
11 Tinted Gray Mirror	26 Matte White	19 Satin White	59 Luna
20 Black	27 Matte Gray	23 Ocean	
21 White	28 Matte Black		

SEE PAGES 45 – 46 FOR TIPS AND FEATURES.

Curated Cartesian® Vanities – Table of Contents, Tips & Features

Curated Cartesian Vanity Tips & Features 51

Curated Cartesian Vanity Model Number Worksheet 52

Curated Cartesian Vanities 54 – 59

 24" Wide Curated Cartesian Vanity 54 – 55

 30" Wide Curated Cartesian Vanity 56 – 57

 36" Wide Curated Cartesian Vanity 58 – 59

Vanity Accessories 265 – 270

Tips & Features

Dimensions & Weight

- Width (with side kits installed):
24" (610 mm)
30" (762 mm)
36" (914 mm)
- Height:
15-3/4" (400 mm)
30-3/4" (781 mm)
- Depth: 22" (559 mm)
- Net Weight: 100 – 205 lbs

Features & Benefits

- Fully pre-configured vanity
- Glass finishes and engineered stone create a visually stunning product that's durable enough to stand the test of time
- Includes Robern ceramic lavatory and proprietary Robern mounting brackets
- Vanity top with 8" widespread faucet holes
- Plumbing slow-close drawer allows clearance for drain; tip out drawer (H1) gives storage back by providing a drawer for smaller items and full slow-close drawer allows for maximum storage when plumbing does not interfere
- Uniquely designed handleless ergonomic drawer, allows for a comfortable feel and effortless operation
- H1 (7-1/2") vanities include five glass bins for plumbing drawers and four glass bins for full drawers; H2 (15") vanities include one glass bin with plumbing drawers

Features & Benefits (Continued)

- Organization kit for H2 (15" H): two fully adjustable glass drawer dividers provide storage right where you need it and prevent items from moving and sliding in the drawer
- Night Light Option – integrated LED night light with light bar built into top frame (top drawer only), provides soft light to illuminate drawer interior and for wayfinding light in either selectable 2700 Kelvin/4000 Kelvin or 5000 Kelvin. Night light is ETL certified to UL 2108, CSA Standard C22.2 No. 12
- Electric accessory option: three plugs and a switch that turns off power to the unit to keep appliances safely plugged in

Configurable Options

- Vanity Styles:
Single Drawer (Plumbing Drawer),
Two Drawer (Plumbing Drawer, Full Drawer),
Three Drawer (Tip Out Drawer, Plumbing Drawer, Full Drawer)
- Decorative Options:
1) White Glass, Stone Gray Top,
2) Tinted Gray Mirror Glass, Lyra Top,
3) Matte Gray Glass, Quartz White Top
- Night Light:
No Night Light or Integrated LED Night Light in selectable 2700 Kelvin/4000 Kelvin or 5000 Kelvin



Tips & Features (Continued)

Construction

- Durable rust-free anodized aluminum and glass construction – glass resists intense moisture, ensuring long-lasting beauty
- Slow-close full-extension slides combined with the durability of aluminum construction ensure smooth operation of the vanity drawers that will last a lifetime
- Constructed for wall hanging loads with stone tops
- Glass fronts and side kits are replaceable
- Industrial grade installation hardware
- White shatter-protected glass drawer bottoms will not degrade or show wear. Glass dissipates heat to ensure confidence that hot items will not leave heat marks on the bottom of the drawers

Installation

- This installation may require more than one person
- Includes installation hardware, structural bolts and silicone
- Special site preparation is required. Wall bracing and Robern supplied hardware are recommended.
- The plumbing must be roughed into the plumbing cutout area of the vanity. Refer to the sink rough-in and the vanity rough-in for proper placement. The water supply and drain lines must be installed before installing the vanity.
- Components needed for stacking are included with each vanity
- Each design offers the necessary 15" plumbing clearance needed to clear the pipes
- Night Light Option (S) – 12VDC plug-in transformer. Option of two color temperatures for one night light: 2700 or 4000 Kelvin. The vanity is preconfigured at 2700K. Night light can be reconfigured to 4000K at time of installation. See installation instructions for more information.
- Night Light Option (T) – 12VDC plug-in transformer in 5000 Kelvin color temperature. Locate wall outlet as per installation instructions.

Installation (Continued)

- Electric Accessory option: 120VAC 20A tamper resistant outlet. Installed within 15" H (H2) vanity drawer; not recommended to be used in combination with Slim Drawer Insert; recommended in combination with Hair Styling Organizer
- Slim full drawer insert can be used in a full drawer – includes four glass bins and only available for 15" H (H2) vanities
- Hair Styling Organizer fits all 15" H (H2) full vanity drawers; cannot be used in combination with slim plumbing drawer insert; recommended in combination with Electric Accessory

Accessories

- In-drawer Electric Accessory (VAELECTRIC21): ETL certified to UL 1363, CSA Standard C22.2 No. 21 – to be used in 15" H (H2) vanity drawers only
- Accessory Night Light in selectable 2700 Kelvin/4000 Kelvin (SLEDS24, SLEDS30, SLEDS36) and 5000 Kelvin (CLEDS24, CLEDS30, CLEDS36): Night light is ETL certified to UL 2108, CSA Standard C22.2 No. 12
- Slim Full Drawer Insert with four glass bins (VADRAWER24X, VADRAWER30X, VADRAWER36X) – 15" H only
- Glass Bins: divided storage (GLASSBIN6.38), small (GLASSBIN3.25), medium (GLASSBIN5.25), large (GLASSBIN8.5)
- Hair Styling Organizer (VAHAIRORG): fits most hair dryers and curling irons – to be used in 15" H (H2) vanity drawers only



Curated Cartesian® Vanity Model Number Worksheet

FEATURES

Select Width:

- 24"
- 30"
- 36"

Select Color:

- White Glass Vanity, Stone Gray Top
- Tinted Gray Mirror Glass Vanity, Lyra Top
- Matte Gray Glass Vanity, Quartz White Top

Select Option:

- Base Unit (No Night Light)
- Selectable Night Light, 2700K/4000K
- Night Light, 5000K

Select Drawer Style:

- Single
- Two
- Three

MODEL

- 24
- 30
- 36

- 2191
- 1194
- 2792

- N
- S
- T

- 00001
- 00002
- 00003

00

B

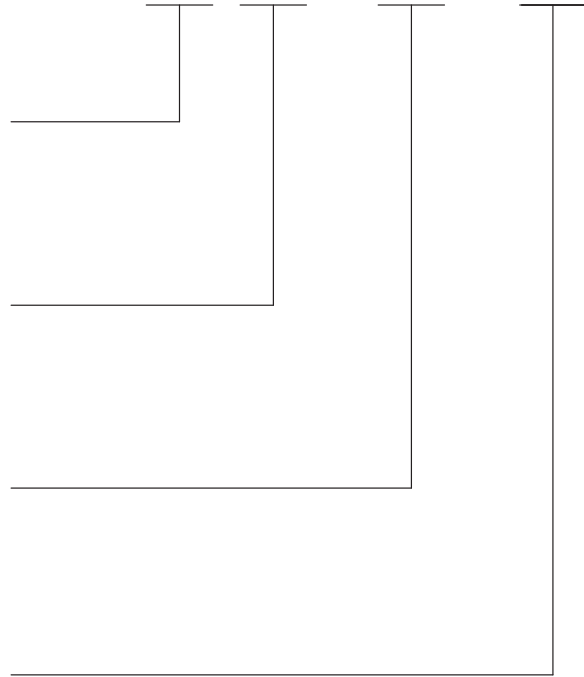

CUSTOMER INFORMATION

Name _____

Address _____

City/State/Zip _____

Telephone _____

Date Ordered _____

Curated Cartesian® Vanity – 24" W x 21" D



Take the guesswork out of vanity design. Robern's Curated Cartesian vanity collection streamlines the decision-making process with a handpicked selection of vanities to ensure a flawless fit that complements any design.

- Glass finishes and engineered stone create a visually stunning product that's durable enough to stand the test of time
- Spacious drawers and tip out storage options eliminate clutter and make the daily routine effortless
- Finishing touches such as in-drawer electric, hot storage, and an LED night light elevate the contemporary design



Four Week
Lead Time



Electrical
Outlet



Night
Light

24" W x 21" D Vanity (25" W x 22" D with Vanity Top)

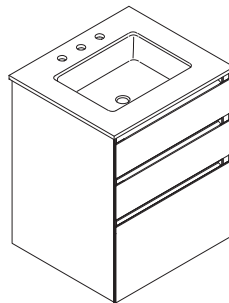
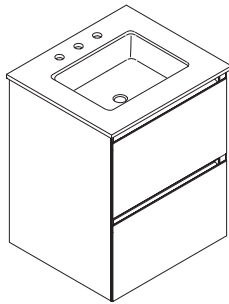
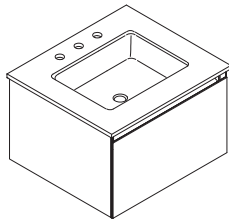

Description

Model

Price

15" H (15-3/4" H with Vanity Top) – Single Drawer, Base Unit

White Glass Vanity, Stone Gray Top	24219100NB00001	\$ 3,049.
Tinted Gray Mirror Glass Vanity, Lyra Top	24119400NB00001	\$ 3,479.
Matte Gray Glass Vanity, Quartz White Top	24279200NB00001	\$ 3,699.

15" H (15-3/4" H with Vanity Top) – Single Drawer, 2700K/4000K Night Light

White Glass Vanity, Stone Gray Top	24219100SB00001	\$ 3,379.
Tinted Gray Mirror Glass Vanity, Lyra Top	24119400SB00001	\$ 3,799.
Matte Gray Glass Vanity, Quartz White Top	24279200SB00001	\$ 4,029.

15" H (15-3/4" H with Vanity Top) – Single Drawer, 5000K Night Light

White Glass Vanity, Stone Gray Top	24219100TB00001	\$ 3,379.
Tinted Gray Mirror Glass Vanity, Lyra Top	24119400TB00001	\$ 3,799.
Matte Gray Glass Vanity, Quartz White Top	24279200TB00001	\$ 4,029.

30" H (30-3/4" H with Vanity Top) – Two Drawer, Base Unit

White Glass Vanity, Stone Gray Top	24219100NB00002	\$ 4,579.
Tinted Gray Mirror Glass Vanity, Lyra Top	24119400NB00002	\$ 4,999.
Matte Gray Glass Vanity, Quartz White Top	24279200NB00002	\$ 5,649.

30" H (30-3/4" H with Vanity Top) – Two Drawer, 2700K/4000K Night Light

White Glass Vanity, Stone Gray Top	24219100SB00002	\$ 4,899.
Tinted Gray Mirror Glass Vanity, Lyra Top	24119400SB00002	\$ 5,329.
Matte Gray Glass Vanity, Quartz White Top	24279200SB00002	\$ 5,999.

30" H (30-3/4" H with Vanity Top) – Two Drawer, 5000K Night Light

White Glass Vanity, Stone Gray Top	24219100TB00002	\$ 4,899.
Tinted Gray Mirror Glass Vanity, Lyra Top	24119400TB00002	\$ 5,329.
Matte Gray Glass Vanity, Quartz White Top	24279200TB00002	\$ 5,999.

30" H (30-3/4" H with Vanity Top) – Three Drawer, Base Unit

White Glass Vanity, Stone Gray Top	24219100NB00003	\$ 5,399.
Tinted Gray Mirror Glass Vanity, Lyra Top	24119400NB00003	\$ 5,829.
Matte Gray Glass Vanity, Quartz White Top	24279200NB00003	\$ 6,929.

30" H (30-3/4" H with Vanity Top) – Three Drawer, 2700K/4000K Night Light

White Glass Vanity, Stone Gray Top	24219100SB00003	\$ 5,729.
Tinted Gray Mirror Glass Vanity, Lyra Top	24119400SB00003	\$ 6,149.
Matte Gray Glass Vanity, Quartz White Top	24279200SB00003	\$ 7,249.

30" H (30-3/4" H with Vanity Top) – Three Drawer, 5000K Night Light

White Glass Vanity, Stone Gray Top	24219100TB00003	\$ 5,729.
Tinted Gray Mirror Glass Vanity, Lyra Top	24119400TB00003	\$ 6,149.
Matte Gray Glass Vanity, Quartz White Top	24279200TB00003	\$ 7,249.





Note: Models in **bold** indicate Quick Ship product.

See Accessories and Options on the following page.

Curated Cartesian® Vanity – 24" W x 21" D

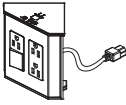
Accessories & Options

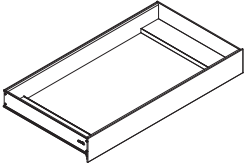
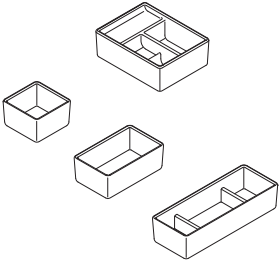
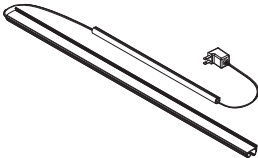
	Description	Model	Price
	Electric Accessory For use in 15" H plumbing or full drawer	VAELECTRIC21	\$ 449.
	Hair Styling Organizer For use in 15" H full drawer	VAHAIRORG	\$ 229.
	Slim Drawer Insert For use in 15" H full drawer (two drawer or three drawer vanity)	VADRAWER24X	\$ 629.
	Accessory Glass Bins Divided Storage, 4-7/8" W x 6-3/8" L x 2-1/8" D	GLASSBIN6.38	\$ 49.
	Small, 3-1/4" W x 3-1/4" L	GLASSBIN3.25	\$ 49.
	Medium, 3-1/4" W x 5-1/4" L	GLASSBIN5.25	\$ 49.
	Large, 3-1/4" W x 8-1/2" L	GLASSBIN8.5	\$ 49.
	Accessory Night Lights 24" W, 5000K	CLEDS24	\$ 329.
	24" W, 2700K/4000K	SLEDS24	\$ 329.

 **Note:** Models in **bold** indicate Quick Ship product.

SEE PAGES 50 – 51 FOR TIPS AND FEATURES.

Curated Cartesian® Vanity – 30" W x 21" D



Take the guesswork out of vanity design. Robern's Curated Cartesian vanity collection streamlines the decision-making process with a handpicked selection of vanities to ensure a flawless fit that complements any design.

- Glass finishes and engineered stone create a visually stunning product that's durable enough to stand the test of time
- Spacious drawers and tip out storage options eliminate clutter and make the daily routine effortless
- Finishing touches such as in-drawer electric, hot storage, and an LED night light elevate the contemporary design



Four Week
Lead Time



Electrical
Outlet



Night
Light

30" W x 21" D Vanity (31" W x 22" D with Vanity Top)

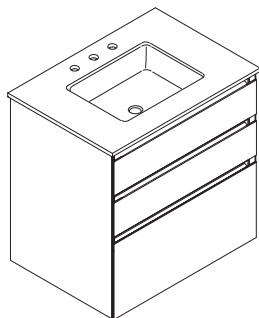
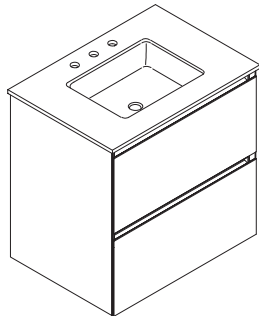
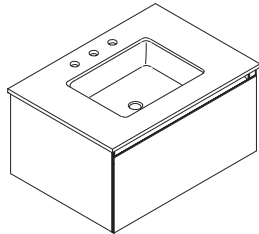



Description	Model	Price
15" H (15-3/4" H with Vanity Top) – Single Drawer, Base Unit		
White Glass Vanity, Stone Gray Top	30219100NB00001	\$ 3,699.
Tinted Gray Mirror Glass Vanity, Lyra Top	30119400NB00001	\$ 4,149.
Matte Gray Glass Vanity, Quartz White Top	30279200NB00001	\$ 4,349.
15" H (15-3/4" H with Vanity Top) – Single Drawer, 2700K/4000K Night Light		
White Glass Vanity, Stone Gray Top	30219100SB00001	\$ 4,079.
Tinted Gray Mirror Glass Vanity, Lyra Top	30119400SB00001	\$ 4,529.
Matte Gray Glass Vanity, Quartz White Top	30279200SB00001	\$ 4,729.
15" H (15-3/4" H with Vanity Top) – Single Drawer, 5000K Night Light		
White Glass Vanity, Stone Gray Top	30219100TB00001	\$ 4,079.
Tinted Gray Mirror Glass Vanity, Lyra Top	30119400TB00001	\$ 4,529.
Matte Gray Glass Vanity, Quartz White Top	30279200TB00001	\$ 4,729.
30" H (30-3/4" H with Vanity Top) – Two Drawer, Base Unit		
White Glass Vanity, Stone Gray Top	30219100NB00002	\$ 5,779.
Tinted Gray Mirror Glass Vanity, Lyra Top	30119400NB00002	\$ 6,199.
Matte Gray Glass Vanity, Quartz White Top	30279200NB00002	\$ 6,849.
30" H (30-3/4" H with Vanity Top) – Two Drawer, 2700K/4000K Night Light		
White Glass Vanity, Stone Gray Top	30219100SB00002	\$ 6,149.
Tinted Gray Mirror Glass Vanity, Lyra Top	30119400SB00002	\$ 6,599.
Matte Gray Glass Vanity, Quartz White Top	30279200SB00002	\$ 7,249.
30" H (30-3/4" H with Vanity Top) – Two Drawer, 5000K Night Light		
White Glass Vanity, Stone Gray Top	30219100TB00002	\$ 6,149.
Tinted Gray Mirror Glass Vanity, Lyra Top	30119400TB00002	\$ 6,599.
Matte Gray Glass Vanity, Quartz White Top	30279200TB00002	\$ 7,249.
30" H (30-3/4" H with Vanity Top) – Three Drawer, Base Unit		
White Glass Vanity, Stone Gray Top	30219100NB00003	\$ 7,129.
Tinted Gray Mirror Glass Vanity, Lyra Top	30119400NB00003	\$ 7,579.
Matte Gray Glass Vanity, Quartz White Top	30279200NB00003	\$ 8,649.
30" H (30-3/4" H with Vanity Top) – Three Drawer, 2700K/4000K Night Light		
White Glass Vanity, Stone Gray Top	30219100SB00003	\$ 7,529.
Tinted Gray Mirror Glass Vanity, Lyra Top	30119400SB00003	\$ 7,949.
Matte Gray Glass Vanity, Quartz White Top	30279200SB00003	\$ 9,049.
30" H (30-3/4" H with Vanity Top) – Three Drawer, 5000K Night Light		
White Glass Vanity, Stone Gray Top	30219100TB00003	\$ 7,529.
Tinted Gray Mirror Glass Vanity, Lyra Top	30119400TB00003	\$ 7,949.
Matte Gray Glass Vanity, Quartz White Top	30279200TB00003	\$ 9,049.

Note: Models in **bold** indicate Quick Ship product.

See Accessories and Options on the following page.

Curated Cartesian® Vanity – 30" W x 21" D

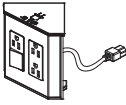
Accessories & Options

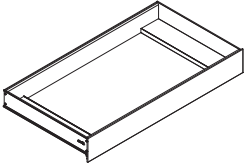
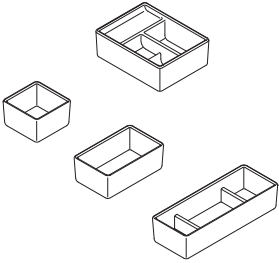
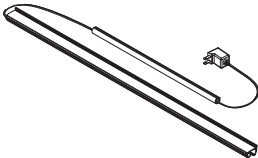
	Description	Model	Price
	Electric Accessory For use in 15" H plumbing or full drawer	VAELECTRIC21	\$ 449.
	Hair Styling Organizer For use in 15" H full drawer	VAHAIRORG	\$ 229.
	Slim Drawer Insert For use in 15" H full drawer (two drawer or three drawer vanity)	VADRAWER30X	\$ 729.
	Accessory Glass Bins Divided Storage, 4-7/8" W x 6-3/8" L x 2-1/8" D	GLASSBIN6.38	\$ 49.
	Small, 3-1/4" W x 3-1/4" L	GLASSBIN3.25	\$ 49.
	Medium, 3-1/4" W x 5-1/4" L	GLASSBIN5.25	\$ 49.
	Large, 3-1/4" W x 8-1/2" L	GLASSBIN8.5	\$ 49.
	Accessory Night Lights 30" W, 5000K	CLEDS30	\$ 379.
	30" W, 2700K/4000K	SLEDS30	\$ 379.

 **Note:** Models in **bold** indicate Quick Ship product.

SEE PAGES 50 – 51 FOR TIPS AND FEATURES.

Curated Cartesian® Vanity – 36" W x 21" D



Take the guesswork out of vanity design. Robern's Curated Cartesian vanity collection streamlines the decision-making process with a handpicked selection of vanities to ensure a flawless fit that complements any design.

- Glass finishes and engineered stone create a visually stunning product that's durable enough to stand the test of time
- Spacious drawers and tip out storage options eliminate clutter and make the daily routine effortless
- Finishing touches such as in-drawer electric, hot storage, and an LED night light elevate the contemporary design



Four Week
Lead Time



Electrical
Outlet



Night
Light

36" W x 21" D Vanity (37" W x 22" D with Vanity Top)

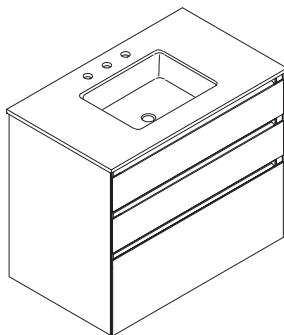
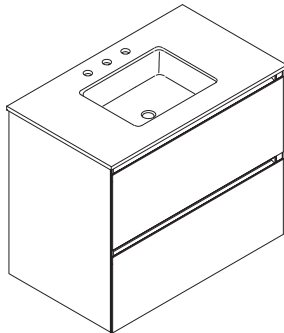
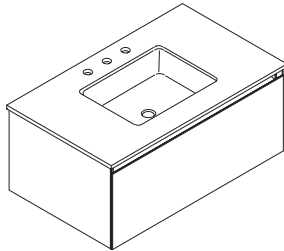



Description	Model	Price
15" H (15-3/4" H with Vanity Top) – Single Drawer, Base Unit		
White Glass Vanity, Stone Gray Top	36219100NB00001	\$ 4,349.
Tinted Gray Mirror Glass Vanity, Lyra Top	36119400NB00001	\$ 4,799.
Matte Gray Glass Vanity, Quartz White Top	36279200NB00001	\$ 4,999.
15" H (15-3/4" H with Vanity Top) – Single Drawer, 2700K/4000K Night Light		
White Glass Vanity, Stone Gray Top	36219100SB00001	\$ 4,799.
Tinted Gray Mirror Glass Vanity, Lyra Top	36119400SB00001	\$ 5,229.
Matte Gray Glass Vanity, Quartz White Top	36279200SB00001	\$ 5,449.
15" H (15-3/4" H with Vanity Top) – Single Drawer, 5000K Night Light		
White Glass Vanity, Stone Gray Top	36219100TB00001	\$ 4,799.
Tinted Gray Mirror Glass Vanity, Lyra Top	36119400TB00001	\$ 5,229.
Matte Gray Glass Vanity, Quartz White Top	36279200TB00001	\$ 5,449.
30" H (30-3/4" H with Vanity Top) – Two Drawer, Base Unit		
White Glass Vanity, Stone Gray Top	36219100NB00002	\$ 6,979.
Tinted Gray Mirror Glass Vanity, Lyra Top	36119400NB00002	\$ 7,399.
Matte Gray Glass Vanity, Quartz White Top	36279200NB00002	\$ 8,049.
30" H (30-3/4" H with Vanity Top) – Two Drawer, 2700K/4000K Night Light		
White Glass Vanity, Stone Gray Top	36219100SB00002	\$ 7,399.
Tinted Gray Mirror Glass Vanity, Lyra Top	36119400SB00002	\$ 7,849.
Matte Gray Glass Vanity, Quartz White Top	36279200SB00002	\$ 8,499.
30" H (30-3/4" H with Vanity Top) – Two Drawer, 5000K Night Light		
White Glass Vanity, Stone Gray Top	36219100TB00002	\$ 7,399.
Tinted Gray Mirror Glass Vanity, Lyra Top	36119400TB00002	\$ 7,849.
Matte Gray Glass Vanity, Quartz White Top	36279200TB00002	\$ 8,499.
30" H (30-3/4" H with Vanity Top) – Three Drawer, Base Unit		
White Glass Vanity, Stone Gray Top	36219100NB00003	\$ 8,879.
Tinted Gray Mirror Glass Vanity, Lyra Top	36119400NB00003	\$ 9,299.
Matte Gray Glass Vanity, Quartz White Top	36279200NB00003	\$ 10,399.
30" H (30-3/4" H with Vanity Top) – Three Drawer, 2700K/4000K Night Light		
White Glass Vanity, Stone Gray Top	36219100SB00003	\$ 9,299.
Tinted Gray Mirror Glass Vanity, Lyra Top	36119400SB00003	\$ 9,749.
Matte Gray Glass Vanity, Quartz White Top	36279200SB00003	\$ 10,849.
30" H (30-3/4" H with Vanity Top) – Three Drawer, 5000K Night Light		
White Glass Vanity, Stone Gray Top	36219100TB00003	\$ 9,299.
Tinted Gray Mirror Glass Vanity, Lyra Top	36119400TB00003	\$ 9,749.
Matte Gray Glass Vanity, Quartz White Top	36279200TB00003	\$ 10,849.

 **Note:** Models in **bold** indicate Quick Ship product.

See Accessories and Options on the following page.

Curated Cartesian® Vanity – 36" W x 21" D

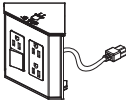
Accessories & Options

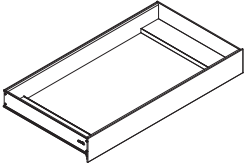
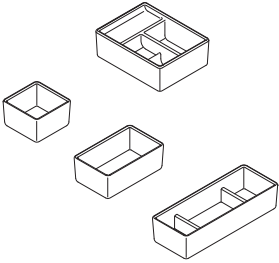
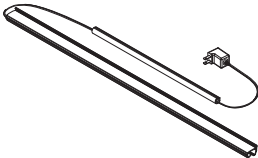
	Description	Model	Price
	Electric Accessory For use in 15" H plumbing or full drawer	VAELECTRIC21	\$ 449.
	Hair Styling Organizer For use in 15" H full drawer	VAHAIRORG	\$ 229.
	Slim Drawer Insert For use in 15" H full drawer (two drawer or three drawer vanity)	VADRAWER36X	\$ 799.
	Accessory Glass Bins Divided Storage, 4-7/8" W x 6-3/8" L x 2-1/8" D	GLASSBIN6.38	\$ 49.
	Small, 3-1/4" W x 3-1/4" L	GLASSBIN3.25	\$ 49.
	Medium, 3-1/4" W x 5-1/4" L	GLASSBIN5.25	\$ 49.
	Large, 3-1/4" W x 8-1/2" L	GLASSBIN8.5	\$ 49.
	Accessory Night Lights 36" W, 5000K	CLEDS36	\$ 449.
	36" W, 2700K/4000K	SLEDS36	\$ 449.

 **Note:** Models in **bold** indicate Quick Ship product.

SEE PAGES 50 – 51 FOR TIPS AND FEATURES.

Balletto® Vanities – Table of Contents, Tips & Features

Table of Contents

Balletto Vanity Tips & Features 60 – 61

Balletto Vanity Model Number Worksheet 62

Balletto Vanities 64 – 69

 30" Wide Balletto Vanity 64 – 65

 36" Wide Balletto Vanity 66 – 67

 42" Wide Balletto Vanity 68 – 69

Vanity Tops 128 – 135

Vanity Accessories 265 – 270

Tips & Features

Dimensions & Weight

- Width:
30-1/2" (876 mm)
36-1/2" (927 mm)
42-1/2" (1080 mm)
- Height:
7-1/2" (191 mm) and 15" (381 mm) vanity heights;
34-1/2" (876 mm) installed height
- Depth: 21-3/4" (552 mm)
- Net Weight: 52 – 117 lbs

Features & Benefits

- Console Vanity
- Glass finish options:
Mirror, 12 decorative gloss and matte finishes and 3 leg finish options
- Left and right hidden side tip outs for additional storage: house hand towels, tissues, waste, magazines and small items to provide a level of convenience while minimizing space
- Plumbing slow-close drawer allows clearance for drain; tip out drawer (H1) gives storage back by providing a drawer for smaller items
- Uniquely designed handleless ergonomic drawer, allows for a comfortable feel and effortless operation
- H1 (7-1/2") vanities include five glass bins for plumbing drawers; H2 (15") vanities include one glass bin with plumbing drawers

Features & Benefits (Continued)

- Organization kit for H2 (15" H): two fully adjustable glass drawer dividers provide storage right where you need it and prevent items from moving and sliding in the drawer
- Night Light Option – integrated LED night light with light bar built into top frame of each drawer, provides soft light to illuminate drawer interior and for wayfinding light in either selectable 2700 Kelvin/4000 Kelvin or 5000 Kelvin. Night light is ETL certified to UL 2108, CSA Standard C22.2 No. 12
- Electric accessory option: three plugs and a switch that turns off power to the unit to keep appliances safely plugged in

Configurable Options

- Decorative Glass Options:
Mirror, 12 decorative gloss and matte finishes
- Drawer Application:
Plumbing Drawer (P) or Front Tip Out – H1 only (T)
- Leg Finish Options:
Chrome, Brushed Nickel, and Brushed Black
- Night Light:
No Night Light or Integrated LED Night Light in selectable 2700 Kelvin/4000 Kelvin or 5000 Kelvin
- Side Storage Options:
Empty, Articulating, Waste, Literature, Cotton



Stock Colors



Classic and Special Order Colors

Ballemo® Vanities – Tips & Features

Tips & Features (Continued)

Construction

- Durable rust-free anodized aluminum and glass construction – glass resists intense moisture, ensuring long-lasting beauty
- Slow-close full-extension slides combined with the durability of aluminum construction ensure smooth operation of the vanity drawers that will last a lifetime
- One piece extruded & CNC machined aluminum legs
- Structural front legs and wall hanging rear supports
- Constructed for wall hanging loads with stone tops
- Glass fronts and side tip outs are replaceable
- White shatter-protected glass drawer bottoms will not degrade or show wear. Glass dissipates heat to ensure confidence that hot items will not leave heat marks on the bottom of the drawers

Installation

- This installation may require more than one person
- Includes installation hardware and structural bolts
- Special site preparation is required. Wall bracing and Roborn supplied hardware are recommended
- The plumbing must be roughed into the plumbing cutout area of the vanity. Refer to the sink rough-in and the vanity rough-in for proper placement. The water supply and drain lines must be installed before installing the vanity.
- With a 7-1/2" H (H1) vanity, a tip out drawer must be used with an undercounter sink
- Side Stop: for use with 15" H vanity, reduces the distance the side storage drawer can open from 8-3/4" to 5-1/8"
- Night light option (S) – 12VDC plug-in transformer. Option of two color temperatures for one night light: 2700 or 4000 Kelvin. The vanity is preconfigured at 2700K. Night light can be reconfigured to 4000K at time of installation. See installation instructions for more information.
- Night light option (L) – 12VDC plug-in transformer in 5000 Kelvin color temperature. Locate wall outlet as per installation instructions.

Installation (Continued)

- Electric Accessory option: 120VAC 20A tamper resistant outlet. Installed within 15" H (H2) vanity drawer; not recommended to be used in combination with Slim Drawer Insert; recommended in combination with Hair Styling Organizer
- Slim plumbing drawer insert must be used with an above-counter sink installation – includes four glass bins and only available for 15" H (H2) vanities
- Hair Styling Organizer fits all 15" H (H2) vanity drawers except 24" plumbing drawer; cannot be used in combination with slim drawer insert; recommended in combination with Electric Accessory

Accessories

- In-drawer Electric Accessory (VAELECTRIC21): ETL certified to UL 1363, CSA Standard C22.2 No. 21 – 15" H only
- Accessory Night Light in selectable 2700 Kelvin/4000 Kelvin (SLEDS24, SLEDS30, SLEDS36) and 5000 Kelvin (CLEDS24, CLEDS30, CLEDS36): Night light is ETL certified to UL 2108, CSA Standard C22.2 No. 12
- Slim Plumbing Drawer Insert with five glass bins (VADRAWER24P, VADRAWER30P, VADRAWER36P) – 15" H only
- Glass Bins: divided storage (GLASSBIN6.38), small (GLASSBIN3.25), medium (GLASSBIN5.25), large (GLASSBIN8.5)
- Hair Styling Organizer (VAHAIRORG): fits most hair dryers and curling irons – to be used in 15" H (H2) vanity drawers only, will not fit in 30" W and 36" W plumbing drawer with an undercounter sink due to plumbing clearance
- Assorted side storage solutions:
 - Articulating Shelves (VALEVELH1 OR VALEVELH2)
 - Cotton/Tissue (VACOTTON1 OR VACOTTON3)
 - Literature (VALITERATURE)
 - Side storage stop (VASIDESTOP)
 - Waste (VAWASTE)
- Glass and engineered stone tops with porcelain sink



Stock Colors



Classic and Special Order Colors

Balletto® Vanity Model Number Worksheet

FEATURES

Select Width:

- 30"
- 36"
- 42"

Select Height:

- 7-1/2"
- 15"

Depth = 21"

Drawer Style:

- Plumbing
- Tip Out*

Select Color:

Stock Colors**

- Mirror 10
- Tinted Gray Mirror 11
- Black 20
- White 21

Classic Colors**

- Beach 22
- Matte White 26
- Matte Gray 27
- Matte Black 28

Special Order Colors**

- Satin Bronze 12
- Satin White 19
- Ocean 23
- Smoke Screen 24
- Silver Screen 25

Select Option:

- Base Unit (No Night Light) N
- Selectable Night Light, 2700K/4000K S
- Night Light, 5000K L

Leg Finish:

- Brushed Nickel 71
- Brushed Black 74
- Chrome 76

MODEL

VB

D21

30"	30								
36"	36								
42"	42								
7-1/2"	H1								
15"	H2								
Depth = 21"	D21								
Plumbing	P								
Tip Out*	T								
Mirror	10								
Tinted Gray Mirror	11								
Black	20								
White	21								
Beach	22								
Matte White	26								
Matte Gray	27								
Matte Black	28								
Satin Bronze	12								
Satin White	19								
Ocean	23								
Smoke Screen	24								
Silver Screen	25								
Base Unit (No Night Light)	N								
Selectable Night Light, 2700K/4000K	S								
Night Light, 5000K	L								
Brushed Nickel	71								
Brushed Black	74								
Chrome	76								

Notes:

- * Tip Out Drawer only available for 7-1/2" height.
- ** Stock Colors have a 2 week lead time; all other Colors have a 4 week lead time.

CUSTOMER INFORMATION

Name _____

Address _____

City/State/Zip _____

Telephone _____

Date Ordered _____

Balletto® Vanity – VB30 – 30" W



For a modern statement piece, the Balletto Vanity provides a unique design solution and hidden side storage suited perfectly to your needs.

- Hidden side storage options house hand towels, tissues, waste, magazines and small items to provide a level of convenience while minimizing space
- Withstands wet and damp environments with aluminum and glass construction
- Provides task and way-finding light by using the night light option



Two Week Lead Time
(Stock Colors)



Four Week Lead Time
(Classic/Special Order Colors)



Electrical
Outlet



Night
Light

30-1/2" W x 34-1/2" H x 21-3/4" D Vanity

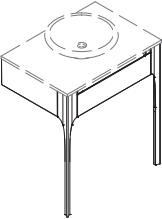
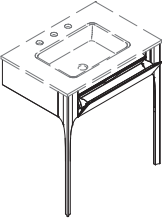
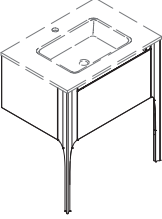
Description	Leg Finish	Model	Stock Colors 10, 11, 20, 21 Price	Classic Colors 22, 26, 27, 28 Price	Special Order Colors 12, 19, 23, 24, 25 Price
7-1/2" H Vanity – Plumbing Drawer, No Undercounter Sink					
 Base Unit With 2700K/4000K Night Light With 5000K Night Light	Brushed Nickel	VB30H1D21P__N71	\$ 2,679.	\$ 3,199.	\$ 3,749.
		VB30H1D21P__S71	\$ 3,049.	\$ 3,599.	\$ 4,149.
		VB30H1D21P__L71	\$ 3,049.	\$ 3,599.	\$ 4,149.
Base Unit With 2700K/4000K Night Light With 5000K Night Light	Brushed Black	VB30H1D21P__N74	\$ 2,679.	\$ 3,199.	\$ 3,749.
		VB30H1D21P__S74	\$ 3,049.	\$ 3,599.	\$ 4,149.
		VB30H1D21P__L74	\$ 3,049.	\$ 3,599.	\$ 4,149.
Base Unit With 2700K/4000K Night Light With 5000K Night Light	Chrome	VB30H1D21P__N76	\$ 2,679.	\$ 3,199.	\$ 3,749.
		VB30H1D21P__S76	\$ 3,049.	\$ 3,599.	\$ 4,149.
		VB30H1D21P__L76	\$ 3,049.	\$ 3,599.	\$ 4,149.
7-1/2" H Vanity – Tip Out Drawer					
 Base Unit With 2700K/4000K Night Light With 5000K Night Light	Brushed Nickel	VB30H1D21T__N71	\$ 2,679.	\$ 3,199.	\$ 3,749.
		VB30H1D21T__S71	\$ 3,049.	\$ 3,599.	\$ 4,149.
		VB30H1D21T__L71	\$ 3,049.	\$ 3,599.	\$ 4,149.
Base Unit With 2700K/4000K Night Light With 5000K Night Light	Brushed Black	VB30H1D21T__N74	\$ 2,679.	\$ 3,199.	\$ 3,749.
		VB30H1D21T__S74	\$ 3,049.	\$ 3,599.	\$ 4,149.
		VB30H1D21T__L74	\$ 3,049.	\$ 3,599.	\$ 4,149.
Base Unit With 2700K/4000K Night Light With 5000K Night Light	Chrome	VB30H1D21T__N76	\$ 2,679.	\$ 3,199.	\$ 3,749.
		VB30H1D21T__S76	\$ 3,049.	\$ 3,599.	\$ 4,149.
		VB30H1D21T__L76	\$ 3,049.	\$ 3,599.	\$ 4,149.
15" H Vanity – Plumbing Drawer					
 Base Unit With 2700K/4000K Night Light With 5000K Night Light	Brushed Nickel	VB30H2D21P__N71	\$ 2,949.	\$ 3,479.	\$ 4,029.
		VB30H2D21P__S71	\$ 3,329.	\$ 3,879.	\$ 4,399.
		VB30H2D21P__L71	\$ 3,329.	\$ 3,879.	\$ 4,399.
Base Unit With 2700K/4000K Night Light With 5000K Night Light	Brushed Black	VB30H2D21P__N74	\$ 2,949.	\$ 3,479.	\$ 4,029.
		VB30H2D21P__S74	\$ 3,329.	\$ 3,879.	\$ 4,399.
		VB30H2D21P__L74	\$ 3,329.	\$ 3,879.	\$ 4,399.
Base Unit With 2700K/4000K Night Light With 5000K Night Light	Chrome	VB30H2D21P__N76	\$ 2,949.	\$ 3,479.	\$ 4,029.
		VB30H2D21P__S76	\$ 3,329.	\$ 3,879.	\$ 4,399.
		VB30H2D21P__L76	\$ 3,329.	\$ 3,879.	\$ 4,399.

*Note: Additional vanity width with Side Storage Inserts tipped out: +9-1/8" for 7-1/2" H vanity; +17-1/2" for 15" H vanity.

Fill in __ designator to Model listed above with desired color listed on the following page.
Example: VB30H1D21T20L76.

See Vanity Color Options, Vanity Tops, Accessories & Options on the following page.

Balletto® Vanity – VB30 – 30" W

Vanity Color Options

Fill in __ designator to Model listed at left with desired color. Example: VB30H1D21T20L76.

Stock Colors

- 10 Mirror
- 11 Tinted Gray Mirror
- 20 Black
- 21 White

Classic Colors

- 22 Beach
- 26 Matte White
- 27 Matte Gray
- 28 Matte Black

Special Order Colors

- 12 Satin Bronze
- 19 Satin White
- 23 Ocean
- 24 Smoke Screen
- 25 Silver Screen

31" W x 22" D Vanity Tops – For 21" D Vanities

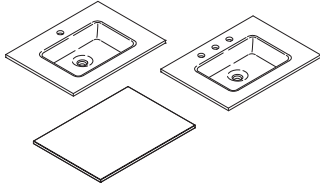

Description	For Use With Vanity	See Page
TS31UCN __ Glass Vanity Top	Plumbing & Tip Out Drawer	129
TF31UCO __ Engineered Stone Vanity Top	Plumbing & Tip Out Drawer	129
TF31G __ Engineered Stone Vanity Top (No Sink)	30" W Vanities	129

Undercounter Sink available for Custom Countertop – see page 135.

Accessories & Options

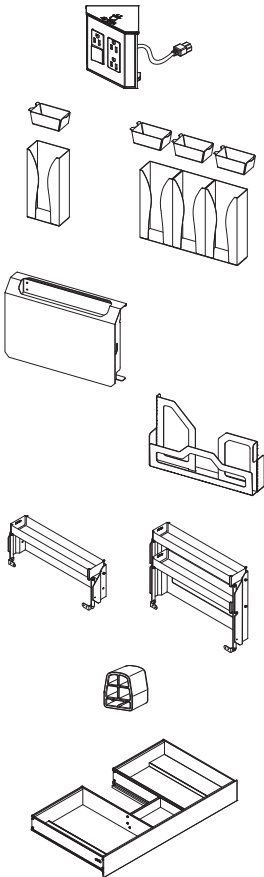

Description	Model	Price
Electric Accessory For use in 15" H vanity plumbing drawer	VAELECTRIC21	\$ 449.
Hidden Side Storage Insert – Cotton For use with 15" H vanity	VACOTTON1	\$ 229.
For use with 15" H vanity	VACOTTON3	\$ 449.
Hidden Side Storage Insert – Waste For use with 15" H vanity	VAWASTE	\$ 279.
Hidden Side Storage Insert – Literature For use with 15" H vanity	VALITERATURE	\$ 279.
Hidden Side Storage Insert – Articulating For use with 7-1/2" H vanity	VALEVELH1	\$ 279.
For use with 15" H vanity	VALEVELH2	\$ 399.
Side Stop For use with 15" H vanity, limits the distance the side storage drawer can open from 8-3/4" to 5-1/8"	VASIDESTOP	\$ 49.
Slim Drawer Insert For use in 15" H vanity plumbing drawer	VADRAWER24P	\$ 629.

Note: Not for use with plumbing drawer undercounter sink installations or with Robern's stone vanity tops. Can be used in above-counter vessel installations.

See additional Accessories on pages 266 – 268.

SEE PAGES 60 – 61 FOR TIPS AND FEATURES.

Balletto® Vanity – VB36 – 36" W



For a modern statement piece, the Balletto Vanity provides a unique design solution and hidden side storage suited perfectly to your needs.

- Hidden side storage options house hand towels, tissues, waste, magazines and small items to provide a level of convenience while minimizing space
- Withstands wet and damp environments with aluminum and glass construction
- Provides task and way-finding light by using the night light option



Two Week Lead Time
(Stock Colors)



Four Week Lead Time
(Classic/Special Order Colors)



Electrical
Outlet



Night
Light

36-1/2" W x 34-1/2" H x 21-3/4" D Vanity

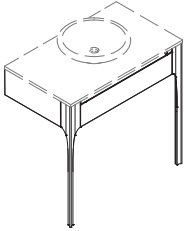
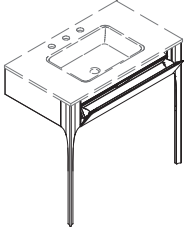
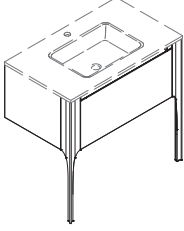
Description	Leg Finish	Model	Stock Colors 10, 11, 20, 21 Price	Classic Colors 22, 26, 27, 28 Price	Special Order Colors 12, 19, 23, 24, 25 Price
7-1/2" H Vanity – Plumbing Drawer, No Undercounter Sink					
 Base Unit With 2700K/4000K Night Light With 5000K Night Light	Brushed Nickel	VB36H1D21P__N71	\$ 3,199.	\$ 3,749.	\$ 4,299.
		VB36H1D21P__S71	\$ 3,649.	\$ 4,199.	\$ 4,749.
		VB36H1D21P__L71	\$ 3,649.	\$ 4,199.	\$ 4,749.
Base Unit With 2700K/4000K Night Light With 5000K Night Light	Brushed Black	VB36H1D21P__N74	\$ 3,199.	\$ 3,749.	\$ 4,299.
		VB36H1D21P__S74	\$ 3,649.	\$ 4,199.	\$ 4,749.
		VB36H1D21P__L74	\$ 3,649.	\$ 4,199.	\$ 4,749.
Base Unit With 2700K/4000K Night Light With 5000K Night Light	Chrome	VB36H1D21P__N76	\$ 3,199.	\$ 3,749.	\$ 4,299.
		VB36H1D21P__S76	\$ 3,649.	\$ 4,199.	\$ 4,749.
		VB36H1D21P__L76	\$ 3,649.	\$ 4,199.	\$ 4,749.
7-1/2" H Vanity – Tip Out Drawer					
 Base Unit With 2700K/4000K Night Light With 5000K Night Light	Brushed Nickel	VB36H1D21T__N71	\$ 3,199.	\$ 3,749.	\$ 4,299.
		VB36H1D21T__S71	\$ 3,649.	\$ 4,199.	\$ 4,749.
		VB36H1D21T__L71	\$ 3,649.	\$ 4,199.	\$ 4,749.
Base Unit With 2700K/4000K Night Light With 5000K Night Light	Brushed Black	VB36H1D21T__N74	\$ 3,199.	\$ 3,749.	\$ 4,299.
		VB36H1D21T__S74	\$ 3,649.	\$ 4,199.	\$ 4,749.
		VB36H1D21T__L74	\$ 3,649.	\$ 4,199.	\$ 4,749.
Base Unit With 2700K/4000K Night Light With 5000K Night Light	Chrome	VB36H1D21T__N76	\$ 3,199.	\$ 3,749.	\$ 4,299.
		VB36H1D21T__S76	\$ 3,649.	\$ 4,199.	\$ 4,749.
		VB36H1D21T__L76	\$ 3,649.	\$ 4,199.	\$ 4,749.
15" H Vanity – Plumbing Drawer					
 Base Unit With 2700K/4000K Night Light With 5000K Night Light	Brushed Nickel	VB36H2D21P__N71	\$ 3,479.	\$ 4,029.	\$ 4,579.
		VB36H2D21P__S71	\$ 3,929.	\$ 4,479.	\$ 4,999.
		VB36H2D21P__L71	\$ 3,929.	\$ 4,479.	\$ 4,999.
Base Unit With 2700K/4000K Night Light With 5000K Night Light	Brushed Black	VB36H2D21P__N74	\$ 3,479.	\$ 4,029.	\$ 4,579.
		VB36H2D21P__S74	\$ 3,929.	\$ 4,479.	\$ 4,999.
		VB36H2D21P__L74	\$ 3,929.	\$ 4,479.	\$ 4,999.
Base Unit With 2700K/4000K Night Light With 5000K Night Light	Chrome	VB36H2D21P__N76	\$ 3,479.	\$ 4,029.	\$ 4,579.
		VB36H2D21P__S76	\$ 3,929.	\$ 4,479.	\$ 4,999.
		VB36H2D21P__L76	\$ 3,929.	\$ 4,479.	\$ 4,999.

*Note: Additional vanity width with Side Storage Inserts tipped out: +9-1/8" for 7-1/2" H vanity; +17-1/2" for 15" H vanity.

Fill in __ designator to Model listed above with desired color listed on the following page.
Example: Example: VB36H2D21P28L71.

See Vanity Color Options, Vanity Tops, Accessories & Options on the following page.

Balletto® Vanity – VB36 – 36" W

Vanity Color Options

Fill in __ designator to Model listed at left with desired color. Example: VB36H2D21P28L71.

Stock Colors

- 10 Mirror
- 11 Tinted Gray Mirror
- 20 Black
- 21 White

Classic Colors

- 22 Beach
- 26 Matte White
- 27 Matte Gray
- 28 Matte Black

Special Order Colors

- 12 Satin Bronze
- 19 Satin White
- 23 Ocean
- 24 Smoke Screen
- 25 Silver Screen

37" W x 22" D Vanity Tops – For 21" D Vanities

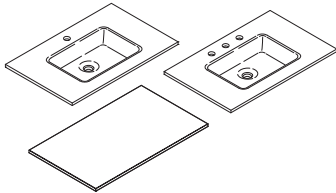

Description	For Use With Vanity	See Page
TF37UCO __ Engineered Stone Vanity Top	Plumbing & Tip Out Drawer	130
TF37G __ Engineered Stone Vanity Top (No Sink)	36" W Vanities	130

Undercounter Sink available for Custom Countertop – see page 135.

Accessories & Options

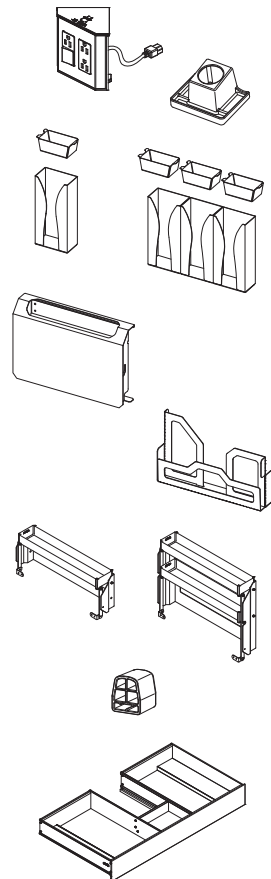

Description	Model	Price
Electric Accessory For use in 15" H vanity plumbing drawer	VAELECTRIC21	\$ 449.
Hair Styling Organizer For use in 15" H vanity plumbing drawer (vessel only)	VAHAIRORG	\$ 229.
Hidden Side Storage Insert – Cotton For use with 15" H vanity	VACOTTON1	\$ 229.
For use with 15" H vanity	VACOTTON3	\$ 449.
Hidden Side Storage Insert – Waste For use with 15" H vanity	VAWASTE	\$ 279.
Hidden Side Storage Insert – Literature For use with 15" H vanity	VALITERATURE	\$ 279.
Hidden Side Storage Insert – Articulating For use with 7-1/2" H vanity	VALEVELH1	\$ 279.
For use with 15" H vanity	VALEVELH2	\$ 399.
Side Stop For use with 15" H vanity, limits the distance the side storage drawer can open from 8-3/4" to 5-1/8"	VASIDESTOP	\$ 49.
Slim Drawer Insert For use in 15" H vanity plumbing drawer	VADRAWER30P	\$ 729.

Note: Not for use with plumbing drawer undercounter sink installations or with Robern's stone vanity tops. Can be used in above-counter vessel installations.

See additional Accessories on pages 266 – 268.

SEE PAGES 60 – 61 FOR TIPS AND FEATURES.

Balletto® Vanity – VB42 – 42" W



For a modern statement piece, the Balletto Vanity provides a unique design solution and hidden side storage suited perfectly to your needs.

- Hidden side storage options house hand towels, tissues, waste, magazines and small items to provide a level of convenience while minimizing space
- Withstands wet and damp environments with aluminum and glass construction
- Provides task and way-finding light by using the night light option



Two Week Lead Time
(Stock Colors)



Four Week Lead Time
(Classic/Special Order Colors)



Electrical
Outlet



Night
Light

42-1/2" W x 34-1/2" H x 21-3/4" D Vanity

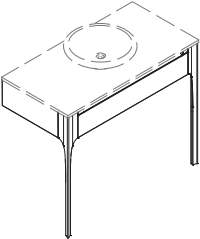
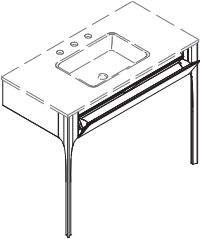
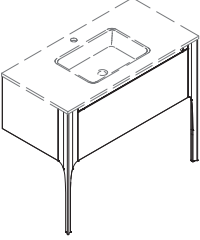
Description	Leg Finish	Model	Stock Colors 10, 11, 20, 21 Price	Classic Colors 22, 26, 27, 28 Price	Special Order Colors 12, 19, 23, 24, 25 Price
7-1/2" H Vanity – Plumbing Drawer, No Undercounter Sink					
 Base Unit With 2700K/4000K Night Light With 5000K Night Light	Brushed Nickel	VB42H1D21P __ N71	\$ 3,749.	\$ 4,299.	\$ 4,849.
		VB42H1D21P __ S71	\$ 4,249.	\$ 4,799.	\$ 5,349.
		VB42H1D21P __ L71	\$ 4,249.	\$ 4,799.	\$ 5,349.
Base Unit With 2700K/4000K Night Light With 5000K Night Light	Brushed Black	VB42H1D21P __ N74	\$ 3,749.	\$ 4,299.	\$ 4,849.
		VB42H1D21P __ S74	\$ 4,249.	\$ 4,799.	\$ 5,349.
		VB42H1D21P __ L74	\$ 4,249.	\$ 4,799.	\$ 5,349.
Base Unit With 2700K/4000K Night Light With 5000K Night Light	Chrome	VB42H1D21P __ N76	\$ 3,749.	\$ 4,299.	\$ 4,849.
		VB42H1D21P __ S76	\$ 4,249.	\$ 4,799.	\$ 5,349.
		VB42H1D21P __ L76	\$ 4,249.	\$ 4,799.	\$ 5,349.
7-1/2" H Vanity – Tip Out Drawer					
 Base Unit With 2700K/4000K Night Light With 5000K Night Light	Brushed Nickel	VB42H1D21T __ N71	\$ 3,749.	\$ 4,299.	\$ 4,849.
		VB42H1D21T __ S71	\$ 4,249.	\$ 4,799.	\$ 5,349.
		VB42H1D21T __ L71	\$ 4,249.	\$ 4,799.	\$ 5,349.
Base Unit With 2700K/4000K Night Light With 5000K Night Light	Brushed Black	VB42H1D21T __ N74	\$ 3,749.	\$ 4,299.	\$ 4,849.
		VB42H1D21T __ S74	\$ 4,249.	\$ 4,799.	\$ 5,349.
		VB42H1D21T __ L74	\$ 4,249.	\$ 4,799.	\$ 5,349.
Base Unit With 2700K/4000K Night Light With 5000K Night Light	Chrome	VB42H1D21T __ N76	\$ 3,749.	\$ 4,299.	\$ 4,849.
		VB42H1D21T __ S76	\$ 4,249.	\$ 4,799.	\$ 5,349.
		VB42H1D21T __ L76	\$ 4,249.	\$ 4,799.	\$ 5,349.
15" H Vanity – Plumbing Drawer					
 Base Unit With 2700K/4000K Night Light With 5000K Night Light	Brushed Nickel	VB42H2D21P __ N71	\$ 4,029.	\$ 4,579.	\$ 5,129.
		VB42H2D21P __ S71	\$ 4,529.	\$ 5,079.	\$ 5,599.
		VB42H2D21P __ L71	\$ 4,529.	\$ 5,079.	\$ 5,599.
Base Unit With 2700K/4000K Night Light With 5000K Night Light	Brushed Black	VB42H2D21P __ N74	\$ 4,029.	\$ 4,579.	\$ 5,129.
		VB42H2D21P __ S74	\$ 4,529.	\$ 5,079.	\$ 5,599.
		VB42H2D21P __ L74	\$ 4,529.	\$ 5,079.	\$ 5,599.
Base Unit With 2700K/4000K Night Light With 5000K Night Light	Chrome	VB42H2D21P __ N76	\$ 4,029.	\$ 4,579.	\$ 5,129.
		VB42H2D21P __ S76	\$ 4,529.	\$ 5,079.	\$ 5,599.
		VB42H2D21P __ L76	\$ 4,529.	\$ 5,079.	\$ 5,599.

*Note: Additional vanity width with Side Storage Inserts tipped out: +9-1/8" for 7-1/2" H vanity; +17-1/2" for 15" H vanity.

Fill in __ designator to Model listed above with desired color listed on the following page.
Example: VB42H1D21T19N76.

See Vanity Color Options, Vanity Tops, Accessories & Options on the following page.

Balletto® Vanity – VB42 – 42" W

Vanity Color Options

Fill in __ designator to Model listed at left with desired color. Example: VB42H1D21T19N76.

Stock Colors

- 10 Mirror
- 11 Tinted Gray Mirror
- 20 Black
- 21 White

Classic Colors

- 22 Beach
- 26 Matte White
- 27 Matte Gray
- 28 Matte Black

Special Order Colors

- 12 Satin Bronze
- 19 Satin White
- 23 Ocean
- 24 Smoke Screen
- 25 Silver Screen

43" W x 22" D Vanity Tops – For 21" D Vanities

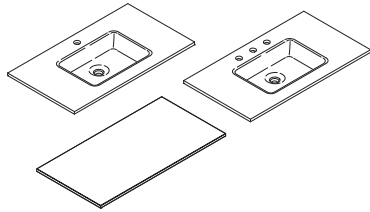

Description	For Use With Vanity	See Page
TF43UCO __ Engineered Stone Vanity Top	Plumbing & Tip Out Drawer	131
TF43G __ Engineered Stone Vanity Top (No Sink)	42" W Vanities	131

Undercounter Sink available for Custom Countertop – see page 135.

Accessories & Options

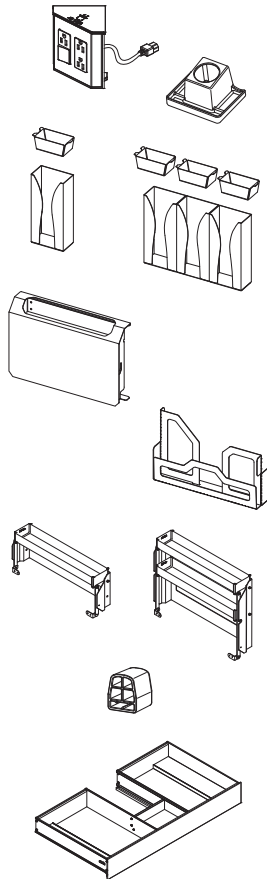

Description	Model	Price
Electric Accessory For use in 15" H vanity plumbing drawer	VAELECTRIC21	\$ 449.
Hair Styling Organizer For use in 15" H vanity plumbing drawer (vessel only)	VAHAIRORG	\$ 229.
Hidden Side Storage Insert – Cotton For use with 15" H vanity	VACOTTON1	\$ 229.
For use with 15" H vanity	VACOTTON3	\$ 449.
Hidden Side Storage Insert – Waste For use with 15" H vanity	VAWASTE	\$ 279.
Hidden Side Storage Insert – Literature For use with 15" H vanity	VALITERATURE	\$ 279.
Hidden Side Storage Insert – Articulating For use with 7-1/2" H vanity	VALEVELH1	\$ 279.
For use with 15" H vanity	VALEVELH2	\$ 399.
Side Stop For use with 15" H vanity, limits the distance the side storage drawer can open from 8-3/4" to 5-1/8"	VASIDESTOP	\$ 49.
Slim Drawer Insert For use in 15" H vanity plumbing drawer	VADRAWER36P	\$ 799.

Note: Not for use with plumbing drawer undercounter sink installations or with Robern's stone vanity tops. Can be used in above-counter vessel installations.

See additional Accessories on pages 266 – 268.

SEE PAGES 60 – 61 FOR TIPS AND FEATURES.

Profiles™ Vanities – Table of Contents, Tips & Features

Table of Contents

Profiles Vanity Tips & Features	70 – 71
Profiles Ganging Reference	72
Profiles Vanity Model Number Worksheet	73
Profiles Vanities	74 – 87
12" Wide Profiles Vanity	74 – 75
24" Wide Profiles Vanity	76 – 79
30" Wide Profiles Vanity	80 – 83
36" Wide Profiles Vanity	84 – 87
Vanity Tops	128 – 135
Profiles Vanity Undermount Bowl Space Availability	136
Vanity Accessories	265 – 270

Tips & Features

Dimensions & Weight

- Width (with side kits installed):
 - 12-1/8" (308 mm)
 - 24-1/8" (613 mm)
 - 30-1/8" (765 mm)
 - 36-1/8" (918 mm)
- Height:
 - 7-1/2" (191 mm)
 - 15" (381 mm)
- Depth:
 - 18-3/4" (476 mm)
 - 21-3/4" (552 mm)
- Net Weight: 17 – 55 lbs

Features & Benefits

- Match or coordinate fixtures in your styling space with four popular metal frame finishes: Chrome, Polished Nickel, Matte Gold, Matte Black
- Glass finish options: Mirror, 10 decorative gloss and matte finishes
- Modular vanities can be ganged or stacked to fit a variety of desired heights and widths (ganging kit required)
- Create a coordinated ensemble by pairing with Profiles Medicine Cabinets, Profiles Lighting and Profiles Mirrors
- Plumbing slow-close drawer allows clearance for drain; tip out drawer (H1) gives storage back by providing a drawer for smaller items and full slow-close drawer allows for maximum storage when plumbing does not interfere
- Uniquely designed handleless ergonomic drawer, allows for a comfortable feel and effortless operation

Features & Benefits (Continued)

- H1 (7-1/2") vanities include five glass bins for plumbing drawers and four glass bins for full drawers; H2 (15") vanities include one glass bin with plumbing drawers
- Organization kit for H2 (15" H): two fully adjustable glass drawer dividers provide storage right where you need it and prevent items from moving and sliding in the drawer
- Night Light Option – integrated LED night light with light bar built into top frame of each drawer, provides soft light to illuminate drawer interior and for wayfinding light in selectable 2700 Kelvin/4000 Kelvin. Night light is ETL certified to UL 2108, CSA Standard C22.2 No. 12
- Electric accessory option: three plugs and a switch that turns off power to the unit to keep appliances safely plugged in

Configurable Options

- Metal Frame Finishes: Chrome, Polished Nickel, Matte Gold, Matte Black
- Glass Finish Options: Mirror, 10 Decorative Gloss and Matte Colors
- Night Light: No Night Light or Integrated LED Night Light in selectable 2700 Kelvin/4000 Kelvin
- Drawer Application: Choice of split plumbing (not available for 12" W drawer), full drawer or tip out drawer (7-1/2" H only, not available for 12" W drawer)



Tips & Features (Continued)

Construction

- Durable rust-free anodized aluminum and glass construction – glass resists intense moisture, ensuring long-lasting beauty
- Slow-close full-extension slides combined with the durability of aluminum construction ensure smooth operation of the vanity drawers that will last a lifetime
- Constructed for wall hanging loads with stone tops
- Glass fronts and side kits are replaceable
- Industrial grade installation hardware
- White shatter-protected glass drawer bottoms will not degrade or show wear. Glass dissipates heat to ensure confidence that hot items will not leave heat marks on the bottom of the drawers

Installation

- This installation may require more than one person
- Includes installation hardware and structural bolts
- Special site preparation is required. Wall bracing and Robern supplied hardware are recommended
- The plumbing must be roughed into the plumbing cutout area of the vanity. Refer to the sink rough-in and the vanity rough-in for proper placement. The water supply and drain lines must be installed before installing the vanity.
- Components needed for stacking are included with each vanity
- Within a column, all vanities must stay the same width. Ganging kit required for each column connection point and is selected based on the connection height of the cabinets. Each ganging kit is by 7-1/2" increments (H1 = 7-1/2", H2 = 15", H3 = 22-1/2", H4 = 30").
- Side kits are sold separately to allow for customization and are available individually or as pairs. You must choose one side kit or alcove kit for every exposed side.
- With a 7-1/2" H vanity, a tip out drawer must be used with an undercounter sink
- If stacking with a 7-1/2" tip out drawer, the second vanity must be a 7-1/2" plumbing drawer, a 15" plumbing drawer or a 15" full drawer as the first 15" needs plumbing clearance. If using 7-1/2" tip out for undercounter sink installation, slim plumbing drawer insert can be used with a 15" H plumbing drawer and still clear pipes.
- Full drawer units are intended for ganging and stacking and are not designed to accept a sink or plumbing.
- Night light option (S) – 12VDC plug-in transformer. Option of two color temperatures for one night light: 2700 or 4000 Kelvin. The vanity is preconfigured at 2700K. Night light can be reconfigured to 4000K at time of installation. See installation instructions for more information.

Installation (Continued)

- Electric Accessory option: 120VAC 20A tamper resistant outlet. Installed within 15" H (H2) vanity drawer; not recommended to be used in combination with Slim Drawer Insert; recommended in combination with Hair Styling Organizer
- Slim plumbing drawer insert must be used with an above-counter sink installation; full drawer version can be used in a full drawer) – includes four glass bins and only available for 15" H (H2) vanities
- Hair Styling Organizer fits all 15" H (H2) vanity drawers except 24" plumbing drawer; cannot be used in combination with slim drawer insert; recommended in combination with Electric Accessory

Accessories

- In-drawer Electric Accessory (VAELECTRIC18, VAELECTRIC21): ETL certified to UL 1363, CSA Standard C22.2 No. 21 – 15" H only
- Accessory Night Light in selectable 2700 Kelvin/4000 Kelvin (SLEDS12, SLEDS24, SLEDS30, SLEDS36): Night light is ETL certified to UL 2108, CSA Standard C22.2 No. 12
- Slim Plumbing Drawer Insert with four glass bins (VADRAWER24P, VADRAWER30P, VADRAWER36P) – 15" H only
- Slim Full Drawer Insert with four glass bins (VADRAWER12X, VADRAWER24X, VADRAWER30X, VADRAWER36X) – 15" H only
- Glass Bins: divided storage (GLASSBIN6.38), small (GLASSBIN3.25), medium (GLASSBIN5.25), large (GLASSBIN8.5)
- Hair Styling Organizer (VAHAIRORG): fits most hair dryers and curling irons – to be used in 15" H (H2) vanity drawers only
- Glass and engineered stone tops with porcelain sink
- Glass side kits sold separately as single units or as a pair. Available in 4 heights and 2 depths, and based on the final configuration of the vanity (7-1/2", 15", 22-1/2", 30")
- Ganging kits are required when combining two or more vanities and are available in 4 heights and based on the final configuration of the vanity (7-1/2", 15", 22-1/2", 30")
- Alcove finishing kits are required for corner or alcove installations and are available in 4 heights and based on the final configuration of the vanity (7-1/2", 15", 22-1/2", 30")



Profiles™ Ganging Reference

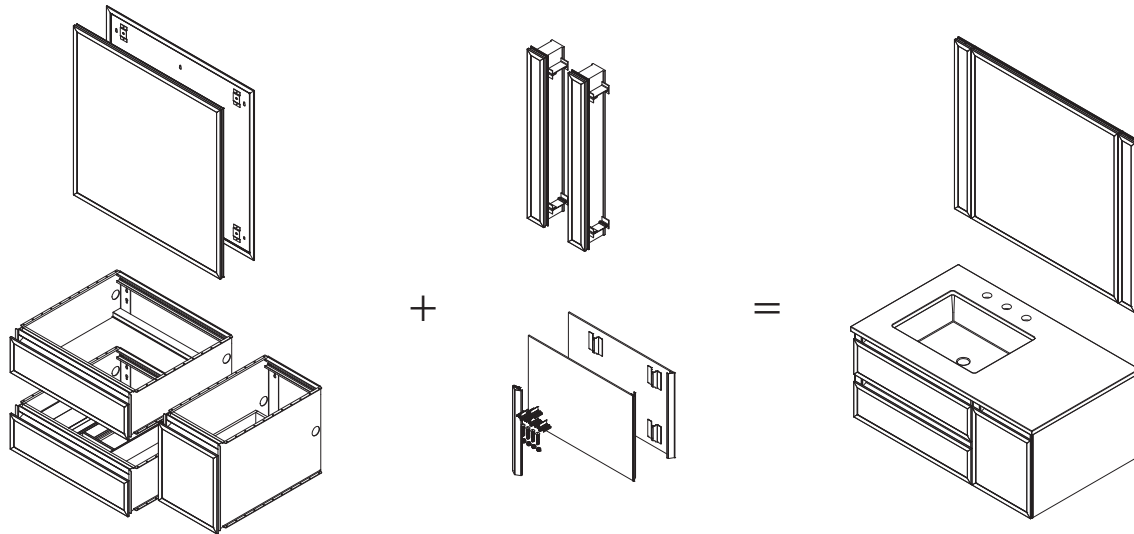

- (1) PM3030T _ _ _
- (1) PMGKIT3030 _ _
- (1) VP24H1D21T _ _ S _ _
- (1) VP24H1D21P _ _ S _ _
- (1) VP12H2D21F _ _ S _ _

- (2) PL3.530TLSC _ _ _ DV
- (1) VM2SKH2D21- _ _ _
- (1) VMGKITH2

- (1) TF37ULO _ _ -8

Configuration 1

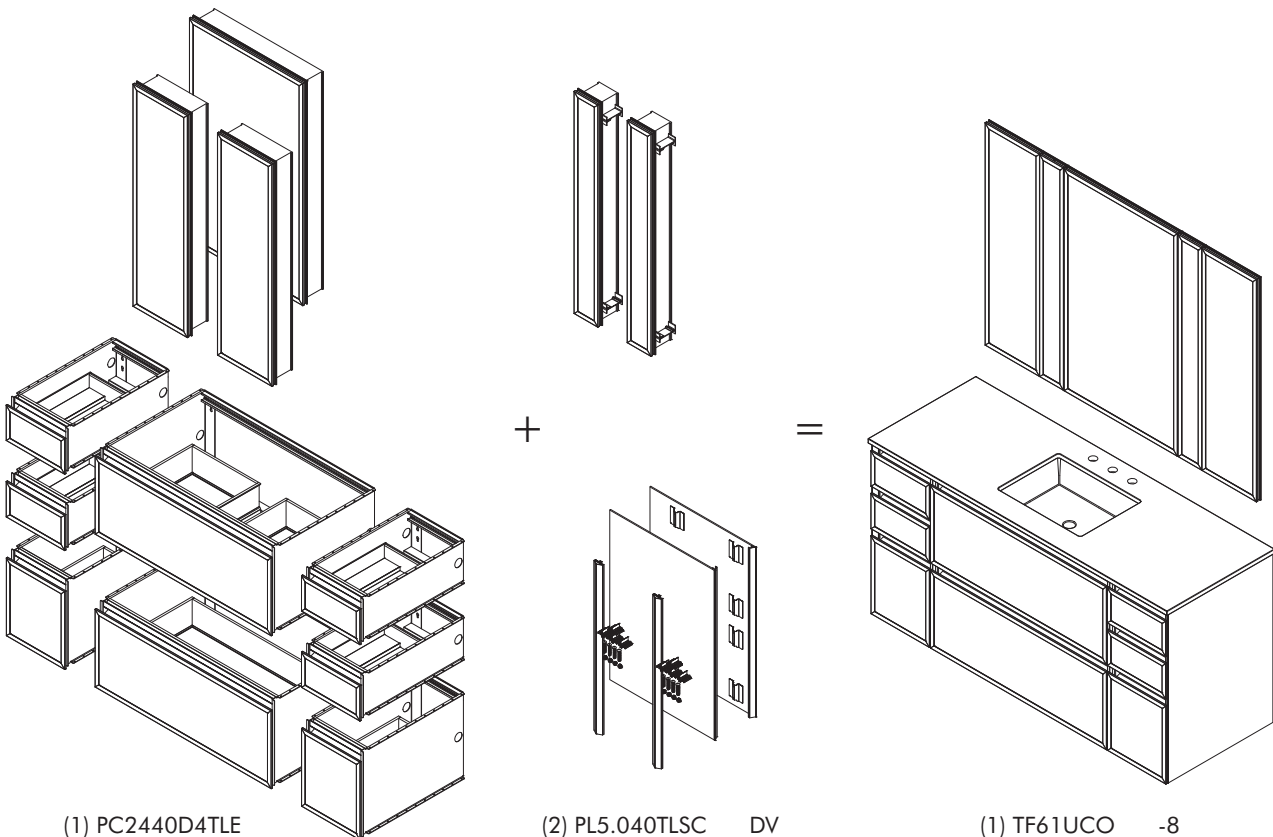

- (1) PC2440D4TLE _ _ _
- (2) PC1240D4TNN _ _ _
- (1) VP36H2D21P _ _ S _ _
- (1) VP36H2D21F _ _ S _ _
- (4) VP12H1D21F _ _ S _ _
- (2) VP12H2D21F _ _ S _ _

- (2) PL5.040TLSC _ _ _ DV
- (1) VM2SKH4D21- _ _ _
- (2) VMGKITH4
- (1) MGKIT

- (1) TF61UCO _ _ -8

Configuration 2

Profiles™ Vanity Model Number Worksheet

FEATURES

Select Width:

- 12"
- 24"
- 30"
- 36"

MODEL

VP

- 12
- 24
- 30
- 36

Select Height:

- 7-1/2"
- 15"

- H1
- H2

Select Depth:

- 18"
- 21"

- D18
- D21

Select Drawer Style:

- Plumbing
- Full
- Tip Out*

- P
- F
- T

Select Glass Finish Color:

Stock Colors

- Mirror
- Tinted Gray Mirror
- Black
- White

- 10
- 11
- 20
- 21

Classic Colors

- Beach
- Matte White
- Matte Gray
- Matte Black

- 22
- 26
- 27
- 28

Special Order Colors

- Satin Bronze
- Satin White
- Ocean

- 12
- 19
- 23

Select Option:

- Base Unit (No Night Light)
- Selectable Night Light, 2700K/4000K

- N
- S

Select Metal Frame Finish:

- Chrome
- Polished Nickel
- Matte Gold
- Matte Black

- 76
- 77
- 82
- 83

Notes:

Profiles Vanities have a 4 week lead time.

* Tip Out Drawer only available for 7-1/2" height.

CUSTOMER INFORMATION

Name _____

Address _____

City/State/Zip _____

Telephone _____

Date Ordered _____

Profiles™ Vanity – VP12 – 12" W x 18" or 21" D



For those who want a high-functioning styling space, that pays homage to an age gone by, the Profiles Collection offers mirrored cabinets, mirrors, vanities, and task lighting in a wide assortment of sizes and finishes to meet the unique needs of any space.

- Match all fixtures in your styling space with Profiles metal frame finishes for a coordinated look: Chrome, Polished Nickel, Matte Gold, Matte Black
- Glass vanity fronts and side kits available in 11 colors
- Limitless design solutions with ability to mix and match
- Spacious drawers and tip out storage options eliminate clutter and make the daily routine effortless



Vanities & Tops

12-1/8" W x 18-3/4" D Vanity		Frame Finish	Models	Stock Colors	Classic Colors	Special Order Colors
Description	76, 77, 82, 83			10, 11, 20, 21 Price	22, 26, 27, 28 Price	12, 19, 23 Price

7-1/2" H x 18-3/4" D Vanity – Full Drawer, No Sink							
	Base Unit	76, 77	VP12H1D18F __ N76	VP12H1D18F __ N77	\$ 699.	\$ 1,149.	\$ 1,579.
	With 2700K/4000K Night Light		VP12H1D18F __ S76	VP12H1D18F __ S77	\$ 979.	\$ 1,429.	\$ 1,849.
	Base Unit	82, 83	VP12H1D18F __ N82	VP12H1D18F __ N83	\$ 829.	\$ 1,249.	\$ 1,679.
	With 2700K/4000K Night Light		VP12H1D18F __ S82	VP12H1D18F __ S83	\$ 1,099.	\$ 1,529.	\$ 1,949.

15" H x 18-3/4" D Vanity – Full Drawer, No Sink							
	Base Unit	76, 77	VP12H2D18F __ N76	VP12H2D18F __ N77	\$ 929.	\$ 1,349.	\$ 1,799.
	With 2700K/4000K Night Light		VP12H2D18F __ S76	VP12H2D18F __ S77	\$ 1,199.	\$ 1,629.	\$ 2,079.
	Base Unit	82, 83	VP12H2D18F __ N82	VP12H2D18F __ N83	\$ 1,029.	\$ 1,479.	\$ 1,899.
	With 2700K/4000K Night Light		VP12H2D18F __ S82	VP12H2D18F __ S83	\$ 1,299.	\$ 1,749.	\$ 2,179.

12-1/8" W x 21-3/4" D Vanity		Frame Finish	Models	Stock Colors	Classic Colors	Special Order Colors
Description	76, 77, 82, 83			10, 11, 20, 21 Price	22, 26, 27, 28 Price	12, 19, 23 Price

7-1/2" H x 21-3/4" D Vanity – Full Drawer, No Sink							
	Base Unit	76, 77	VP12H1D21F __ N76	VP12H1D21F __ N77	\$ 699.	\$ 1,149.	\$ 1,579.
	With 2700K/4000K Night Light		VP12H1D21F __ S76	VP12H1D21F __ S77	\$ 979.	\$ 1,429.	\$ 1,849.
	Base Unit	82, 83	VP12H1D21F __ N82	VP12H1D21F __ N83	\$ 829.	\$ 1,249.	\$ 1,679.
	With 2700K/4000K Night Light		VP12H1D21F __ S82	VP12H1D21F __ S83	\$ 1,099.	\$ 1,529.	\$ 1,949.

15" H x 21-3/4" D Vanity – Full Drawer, No Sink							
	Base Unit	76, 77	VP12H2D21F __ N76	VP12H2D21F __ N77	\$ 929.	\$ 1,349.	\$ 1,799.
	With 2700K/4000K Night Light		VP12H2D21F __ S76	VP12H2D21F __ S77	\$ 1,199.	\$ 1,629.	\$ 2,079.
	Base Unit	82, 83	VP12H2D21F __ N82	VP12H2D21F __ N83	\$ 1,029.	\$ 1,479.	\$ 1,899.
	With 2700K/4000K Night Light		VP12H2D21F __ S82	VP12H2D21F __ S83	\$ 1,299.	\$ 1,749.	\$ 2,179.

Fill in __ designator to Model listed above with desired color listed on the following page.
Example: VP12H2D18F26S76.

See Vanity Color/Finish Options, Vanity Tops, Accessories & Options on the following page.

Profiles™ Vanity – VP12 – 12" W x 18" or 21" D

Vanity Glass Colors and Frame Finishes

Fill in __ designator to Model listed at left with desired color. Example: VP12H2D18F26S76.

Stock Colors	Classic Colors	Special Order Colors	Frame Finishes
10 Mirror	22 Beach	12 Satin Bronze	76 Chrome
11 Tinted Gray Mirror	26 Matte White	19 Satin White	77 Polished Nickel
20 Black	27 Matte Gray	23 Ocean	82 Matte Gold
21 White	28 Matte Black		83 Matte Black

13" W x 19" D & 13" W x 22" D Vanity Tops

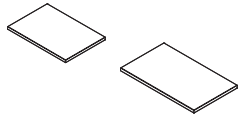

Description	For Use With Vanity	See Page
TE13G __ Engineered Stone Vanity Top (No Sink)	18" D, 12" W Vanities	128
TF13G __ Engineered Stone Vanity Top (No Sink)	21" D, 12" W Vanities	128

See Profiles Ganging Reference on page 72.

Accessories & Options

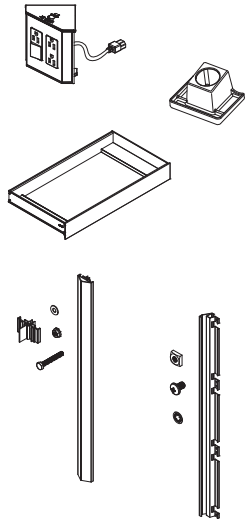

Description	Model	Price
Electric Accessory		
For use in 18" D drawer	VAELECTRIC18	\$ 449.
For use in 21" D drawer	VAELECTRIC21	\$ 449.
Hair Styling Organizer		
For use in 15" H drawer (H2)	VAHAIRORG	\$ 229.
Slim Drawer Insert		
For use in 15" H drawer (H2)	VADRAWER12X	\$ 499.
Vanity Ganging Kit – Hardware required when combining two or more vanities		
7-1/2" H	VMGKITH1	\$ 99.
15" H	VMGKITH2	\$ 99.
22-1/2" H	VMGKITH3	\$ 229.
30" H	VMGKITH4	\$ 229.
Vanity Alcove Finishing Kit – Hardware required for corner or alcove installations		
7-1/2" H	VMAKITH1	\$ 99.
15" H	VMAKITH2	\$ 99.
22-1/2" H	VMAKITH3	\$ 229.
30" H	VMAKITH4	\$ 229.

See additional Accessories on pages 266 – 268.

Vanity Side Kits

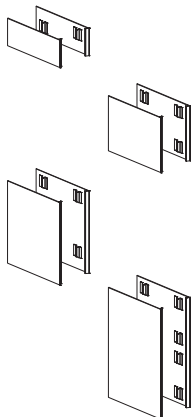

Description	Model	Stock Colors	Classic Colors	Special Order Colors
Vanity Side Kits – Includes glass panel(s) & hardware (see Color Options above)				
Single, 7-1/2" H, 18" D	VM1SKH1D18- __	\$ 229.	\$ 279.	\$ 329.
Single, 7-1/2" H, 21" D	VM1SKH1D21- __	\$ 229.	\$ 279.	\$ 329.
Pair, 7-1/2" H, 18" D	VM2SKH1D18- __	\$ 329.	\$ 449.	\$ 549.
Pair, 7-1/2" H, 21" D	VM2SKH1D21- __	\$ 329.	\$ 449.	\$ 549.
Single, 15" H, 18" D	VM1SKH2D18- __	\$ 279.	\$ 329.	\$ 399.
Single, 15" H, 21" D	VM1SKH2D21- __	\$ 279.	\$ 329.	\$ 399.
Pair, 15" H, 18" D	VM2SKH2D18- __	\$ 399.	\$ 499.	\$ 629.
Pair, 15" H, 21" D	VM2SKH2D21- __	\$ 399.	\$ 499.	\$ 629.
Single, 22-1/2" H, 18" D	VM1SKH3D18- __	\$ 329.	\$ 399.	\$ 449.
Single, 22-1/2" H, 21" D	VM1SKH3D21- __	\$ 329.	\$ 399.	\$ 449.
Pair, 22-1/2" H, 18" D	VM2SKH3D18- __	\$ 549.	\$ 679.	\$ 799.
Pair, 22-1/2" H, 21" D	VM2SKH3D21- __	\$ 549.	\$ 679.	\$ 799.
Single, 30" H, 18" D	VM1SKH4D18- __	\$ 399.	\$ 449.	\$ 499.
Single, 30" H, 21" D	VM1SKH4D21- __	\$ 399.	\$ 449.	\$ 499.
Pair, 30" H, 18" D	VM2SKH4D18- __	\$ 679.	\$ 799.	\$ 899.
Pair, 30" H, 21" D	VM2SKH4D21- __	\$ 679.	\$ 799.	\$ 899.

Note: You must choose one side kit or alcove kit for every exposed side.

SEE PAGES 70 – 71 FOR TIPS AND FEATURES.

Profiles™ Vanity – VP24 – 24" W x 18" D



For those who want a high-functioning styling space, that pays homage to an age gone by, the Profiles Collection offers mirrored cabinets, mirrors, vanities, and task lighting in a wide assortment of sizes and finishes to meet the unique needs of any space.

- Match all fixtures in your styling space with Profiles metal frame finishes for a coordinated look: Chrome, Polished Nickel, Matte Gold, Matte Black
- Glass vanity fronts and side kits available in 11 colors
- Limitless design solutions with ability to mix and match
- Spacious drawers and tip out storage options eliminate clutter and make the daily routine effortless



Four Week Lead Time



Modular



Electrical Outlet

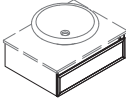
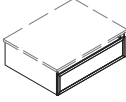
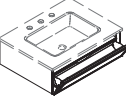
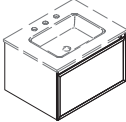
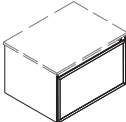

Night Light

24-1/8" W x 18-3/4" D Vanity		Frame Finish	Models	Stock Colors Price	Classic Colors Price	Special Order Colors Price	
Description		76, 77, 82, 83		10, 11, 20, 21	22, 26, 27, 28	12, 19, 23	
7-1/2" H Vanity – Plumbing Drawer, No Undercounter Sink							
	Base Unit	76, 77	VP24H1D18P __ N76	VP24H1D18P __ N77	\$ 1,249.	\$ 1,679.	\$ 2,129.
	With 2700K/4000K Night Light		VP24H1D18P __ S76	VP24H1D18P __ S77	\$ 1,579.	\$ 2,029.	\$ 2,449.
	Base Unit	82, 83	VP24H1D18P __ N82	VP24H1D18P __ N83	\$ 1,349.	\$ 1,799.	\$ 2,229.
	With 2700K/4000K Night Light		VP24H1D18P __ S82	VP24H1D18P __ S83	\$ 1,679.	\$ 2,129.	\$ 2,549.
7-1/2" H Vanity – Full Drawer, No Sink							
	Base Unit	76, 77	VP24H1D18F __ N76	VP24H1D18F __ N77	\$ 1,249.	\$ 1,679.	\$ 2,129.
	With 2700K/4000K Night Light		VP24H1D18F __ S76	VP24H1D18F __ S77	\$ 1,579.	\$ 2,029.	\$ 2,449.
	Base Unit	82, 83	VP24H1D18F __ N82	VP24H1D18F __ N83	\$ 1,349.	\$ 1,799.	\$ 2,229.
	With 2700K/4000K Night Light		VP24H1D18F __ S82	VP24H1D18F __ S83	\$ 1,679.	\$ 2,129.	\$ 2,549.
7-1/2" H Vanity – Tip Out Drawer							
	Base Unit	76, 77	VP24H1D18T __ N76	VP24H1D18T __ N77	\$ 1,249.	\$ 1,679.	\$ 2,129.
	With 2700K/4000K Night Light		VP24H1D18T __ S76	VP24H1D18T __ S77	\$ 1,579.	\$ 2,029.	\$ 2,449.
	Base Unit	82, 83	VP24H1D18T __ N82	VP24H1D18T __ N83	\$ 1,349.	\$ 1,799.	\$ 2,229.
	With 2700K/4000K Night Light		VP24H1D18T __ S82	VP24H1D18T __ S83	\$ 1,679.	\$ 2,129.	\$ 2,549.
15" H Vanity – Plumbing Drawer							
	Base Unit	76, 77	VP24H2D18P __ N76	VP24H2D18P __ N77	\$ 1,479.	\$ 1,899.	\$ 2,349.
	With 2700K/4000K Night Light		VP24H2D18P __ S76	VP24H2D18P __ S77	\$ 1,799.	\$ 2,229.	\$ 2,679.
	Base Unit	82, 83	VP24H2D18P __ N82	VP24H2D18P __ N83	\$ 1,579.	\$ 2,029.	\$ 2,449.
	With 2700K/4000K Night Light		VP24H2D18P __ S82	VP24H2D18P __ S83	\$ 1,899.	\$ 2,349.	\$ 2,779.
15" H Vanity – Full Drawer, No Sink							
	Base Unit	76, 77	VP24H2D18F __ N76	VP24H2D18F __ N77	\$ 1,479.	\$ 1,899.	\$ 2,349.
	With 2700K/4000K Night Light		VP24H2D18F __ S76	VP24H2D18F __ S77	\$ 1,799.	\$ 2,229.	\$ 2,679.
	Base Unit	82, 83	VP24H2D18F __ N82	VP24H2D18F __ N83	\$ 1,579.	\$ 2,029.	\$ 2,449.
	With 2700K/4000K Night Light		VP24H2D18F __ S82	VP24H2D18F __ S83	\$ 1,899.	\$ 2,349.	\$ 2,779.

Fill in __ designator to Model listed above with desired color listed on the following page.
Example: VP24H2D18F26S76.

See Vanity Color/Finish Options, Vanity Tops, Accessories & Options on the following page.

Profiles™ Vanity – VP24 – 24" W x 18" D

Vanity Glass Colors and Frame Finishes

Fill in __ designator to Model listed at left with desired color. Example: VP24H2D18F26S76.

Stock Colors	Classic Colors	Special Order Colors	Frame Finishes
10 Mirror	22 Beach	12 Satin Bronze	76 Chrome
11 Tinted Gray Mirror	26 Matte White	19 Satin White	77 Polished Nickel
20 Black	27 Matte Gray	23 Ocean	82 Matte Gold
21 White	28 Matte Black		83 Matte Black

25" W x 19" D Vanity Tops – For 18" D Vanities

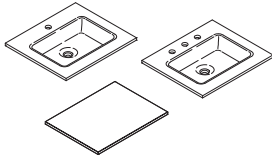

Description	For Use With Vanity	See Page
TC25UCN __ Glass Vanity Top	Plumbing & Tip Out Drawer	128
TE25G __ Engineered Stone Vanity Top (No Sink)	24" W Vanities	128

**Undercounter Sink available for Custom Countertop – see page 135.
See Profiles Ganging Reference on page 72.**

Accessories & Options

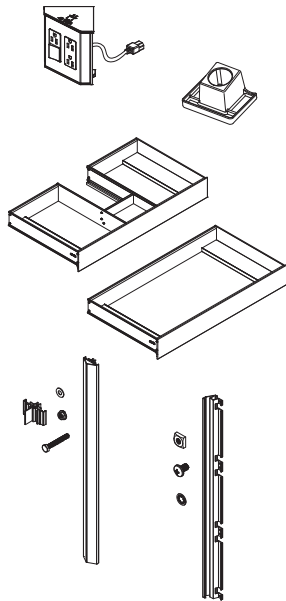

Description	Model	Price
Electric Accessory For use in 15" H plumbing or full drawer (H2)	VAELECTRIC18	\$ 449.
Hair Styling Organizer For use in 15" H full drawer (H2)	VAHAIRORG	\$ 229.
Slim Drawer Insert For use in 15" H plumbing drawer (H2)	VADRAWER24P	\$ 629.
For use in 15" H full drawer (H2)	VADRAWER24X	\$ 629.
Note: Not for use with plumbing drawer undercounter sink installations or with Robern's stone vanity tops. Can be used in above-counter vessel installations.		
Vanity Ganging Kit – Hardware required when combining two or more vanities		
7-1/2" H	VMGKITH1	\$ 99.
15" H	VMGKITH2	\$ 99.
22-1/2" H	VMGKITH3	\$ 229.
30" H	VMGKITH4	\$ 229.
Vanity Alcove Finishing Kit – Hardware required for corner or alcove installations		
7-1/2" H	VMAKITH1	\$ 99.
15" H	VMAKITH2	\$ 99.
22-1/2" H	VMAKITH3	\$ 229.
30" H	VMAKITH4	\$ 229.

See additional Accessories on pages 266 – 268.

Vanity Side Kits

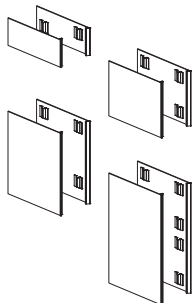

Description	Model	Stock Colors	Classic Colors	Special Order Colors
Vanity Side Kits – Includes glass panel(s) & hardware (see Color Options above)				
Single, 7-1/2" H, 18" D	VM1SKH1D18-__	\$ 229.	\$ 279.	\$ 329.
Pair, 7-1/2" H, 18" D	VM2SKH1D18-__	\$ 329.	\$ 449.	\$ 549.
Single, 15" H, 18" D	VM1SKH2D18-__	\$ 279.	\$ 329.	\$ 399.
Pair, 15" H, 18" D	VM2SKH2D18-__	\$ 399.	\$ 499.	\$ 629.
Single, 22-1/2" H, 18" D	VM1SKH3D18-__	\$ 329.	\$ 399.	\$ 449.
Pair, 22-1/2" H, 18" D	VM2SKH3D18-__	\$ 549.	\$ 679.	\$ 799.
Single, 30" H, 18" D	VM1SKH4D18-__	\$ 399.	\$ 449.	\$ 499.
Pair, 30" H, 18" D	VM2SKH4D18-__	\$ 679.	\$ 799.	\$ 899.

Note: You must choose one side kit or alcove kit for every exposed side.

SEE PAGES 70 – 71 FOR TIPS AND FEATURES.

Profiles™ Vanity – VP24 – 24" W x 21" D



For those who want a high-functioning styling space, that pays homage to an age gone by, the Profiles Collection offers mirrored cabinets, mirrors, vanities, and task lighting in a wide assortment of sizes and finishes to meet the unique needs of any space.

- Match all fixtures in your styling space with Profiles metal frame finishes for a coordinated look: Chrome, Polished Nickel, Matte Gold, Matte Black
- Glass vanity fronts and side kits available in 11 colors
- Limitless design solutions with ability to mix and match
- Spacious drawers and tip out storage options eliminate clutter and make the daily routine effortless



Four Week Lead Time



Modular



Electrical Outlet



Night Light

24-1/8" W x 21-3/4" D Vanity		Frame Finish	Models	Stock Colors Price	Classic Colors Price	Special Order Colors Price	
Description		76, 77, 82, 83		10, 11, 20, 21	22, 26, 27, 28	12, 19, 23	
7-1/2" H Vanity – Plumbing Drawer, No Undercounter Sink							
	Base Unit	76, 77	VP24H1D21P __ N76	VP24H1D21P __ N77	\$ 1,249.	\$ 1,679.	\$ 2,129.
	With 2700K/4000K Night Light		VP24H1D21P __ S76	VP24H1D21P __ S77	\$ 1,579.	\$ 2,029.	\$ 2,449.
	Base Unit	82, 83	VP24H1D21P __ N82	VP24H1D21P __ N83	\$ 1,349.	\$ 1,799.	\$ 2,229.
	With 2700K/4000K Night Light		VP24H1D21P __ S82	VP24H1D21P __ S83	\$ 1,679.	\$ 2,129.	\$ 2,549.
7-1/2" H Vanity – Full Drawer, No Sink							
	Base Unit	76, 77	VP24H1D21F __ N76	VP24H1D21F __ N77	\$ 1,249.	\$ 1,679.	\$ 2,129.
	With 2700K/4000K Night Light		VP24H1D21F __ S76	VP24H1D21F __ S77	\$ 1,579.	\$ 2,029.	\$ 2,449.
	Base Unit	82, 83	VP24H1D21F __ N82	VP24H1D21F __ N83	\$ 1,349.	\$ 1,799.	\$ 2,229.
	With 2700K/4000K Night Light		VP24H1D21F __ S82	VP24H1D21F __ S83	\$ 1,679.	\$ 2,129.	\$ 2,549.
7-1/2" H Vanity – Tip Out Drawer							
	Base Unit	76, 77	VP24H1D21T __ N76	VP24H1D21T __ N77	\$ 1,249.	\$ 1,679.	\$ 2,129.
	With 2700K/4000K Night Light		VP24H1D21T __ S76	VP24H1D21T __ S77	\$ 1,579.	\$ 2,029.	\$ 2,449.
	Base Unit	82, 83	VP24H1D21T __ N82	VP24H1D21T __ N83	\$ 1,349.	\$ 1,799.	\$ 2,229.
	With 2700K/4000K Night Light		VP24H1D21T __ S82	VP24H1D21T __ S83	\$ 1,679.	\$ 2,129.	\$ 2,549.
15" H Vanity – Plumbing Drawer							
	Base Unit	76, 77	VP24H2D21P __ N76	VP24H2D21P __ N77	\$ 1,479.	\$ 1,899.	\$ 2,349.
	With 2700K/4000K Night Light		VP24H2D21P __ S76	VP24H2D21P __ S77	\$ 1,799.	\$ 2,229.	\$ 2,679.
	Base Unit	82, 83	VP24H2D21P __ N82	VP24H2D21P __ N83	\$ 1,579.	\$ 2,029.	\$ 2,449.
	With 2700K/4000K Night Light		VP24H2D21P __ S82	VP24H2D21P __ S83	\$ 1,899.	\$ 2,349.	\$ 2,779.
15" H Vanity – Full Drawer, No Sink							
	Base Unit	76, 77	VP24H2D21F __ N76	VP24H2D21F __ N77	\$ 1,479.	\$ 1,899.	\$ 2,349.
	With 2700K/4000K Night Light		VP24H2D21F __ S76	VP24H2D21F __ S77	\$ 1,799.	\$ 2,229.	\$ 2,679.
	Base Unit	82, 83	VP24H2D21F __ N82	VP24H2D21F __ N83	\$ 1,579.	\$ 2,029.	\$ 2,449.
	With 2700K/4000K Night Light		VP24H2D21F __ S82	VP24H2D21F __ S83	\$ 1,899.	\$ 2,349.	\$ 2,779.

Fill in __ designator to Model listed above with desired color listed on the following page.
Example: VP24H2D21F26S76.

See Vanity Color/Finish Options, Vanity Tops, Accessories & Options on the following page.

Profiles™ Vanity – VP24 – 24" W x 21" D

Vanity Glass Colors and Frame Finishes

Fill in __ designator to Model listed at left with desired color. Example: VP24H2D21F26S76.

Stock Colors	Classic Colors	Special Order Colors	Frame Finishes
10 Mirror	22 Beach	12 Satin Bronze	76 Chrome
11 Tinted Gray Mirror	26 Matte White	19 Satin White	77 Polished Nickel
20 Black	27 Matte Gray	23 Ocean	82 Matte Gold
21 White	28 Matte Black		83 Matte Black

25" W x 22" D Vanity Tops – For 21" D Vanities

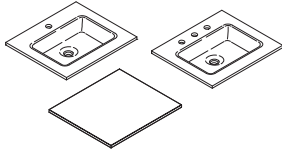

Description	For Use With Vanity	See Page
TS25UCN __ Glass Vanity Top	Plumbing & Tip Out Drawer	128
TF25UCO __ Engineered Stone Vanity Top	Plumbing & Tip Out Drawer	128
TF25G __ Engineered Stone Vanity Top (No Sink)	24" W Vanities	128

Undercounter Sink available for Custom Countertop – see page 135.
See Profiles Ganging Reference on page 72.

Accessories & Options

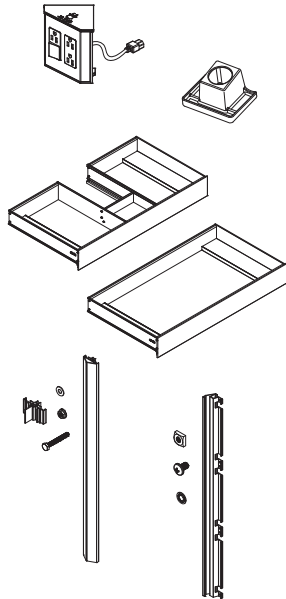

Description	Model	Price
Electric Accessory For use in 15" H plumbing or full drawer (H2)	VAELECTRIC21	\$ 449.
Hair Styling Organizer For use in 15" H full drawer (H2)	VAHAIRORG	\$ 229.
Slim Drawer Insert For use in 15" H plumbing drawer (H2)	VADRAWER24P	\$ 629.
For use in 15" H full drawer (H2)	VADRAWER24X	\$ 629.
Note: Not for use with plumbing drawer undercounter sink installations or with Robern's stone vanity tops. Can be used in above-counter vessel installations.		
Vanity Ganging Kit – Hardware required when combining two or more vanities		
7-1/2" H	VMGKITH1	\$ 99.
15" H	VMGKITH2	\$ 99.
22-1/2" H	VMGKITH3	\$ 229.
30" H	VMGKITH4	\$ 229.
Vanity Alcove Finishing Kit – Hardware required for corner or alcove installations		
7-1/2" H	VMAKITH1	\$ 99.
15" H	VMAKITH2	\$ 99.
22-1/2" H	VMAKITH3	\$ 229.
30" H	VMAKITH4	\$ 229.

See additional Accessories on pages 266 – 268.

Vanity Side Kits

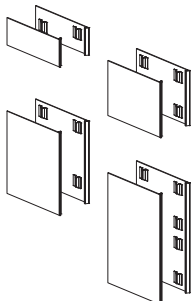

Description	Model	Stock Colors	Classic Colors	Special Order Colors
Vanity Side Kits – Includes glass panel(s) & hardware (see Color Options above)				
Single, 7-1/2" H, 21" D	VM1SKH1D21- __	\$ 229.	\$ 279.	\$ 329.
Pair, 7-1/2" H, 21" D	VM2SKH1D21- __	\$ 329.	\$ 449.	\$ 549.
Single, 15" H, 21" D	VM1SKH2D21- __	\$ 279.	\$ 329.	\$ 399.
Pair, 15" H, 21" D	VM2SKH2D21- __	\$ 399.	\$ 499.	\$ 629.
Single, 22-1/2" H, 21" D	VM1SKH3D21- __	\$ 329.	\$ 399.	\$ 449.
Pair, 22-1/2" H, 21" D	VM2SKH3D21- __	\$ 549.	\$ 679.	\$ 799.
Single, 30" H, 21" D	VM1SKH4D21- __	\$ 399.	\$ 449.	\$ 499.
Pair, 30" H, 21" D	VM2SKH4D21- __	\$ 679.	\$ 799.	\$ 899.

Note: You must choose one side kit or alcove kit for every exposed side.

SEE PAGES 70 – 71 FOR TIPS AND FEATURES.

Profiles™ Vanity – VP30 – 30" W x 18" D



For those who want a high-functioning styling space, that pays homage to an age gone by, the Profiles Collection offers mirrored cabinets, mirrors, vanities, and task lighting in a wide assortment of sizes and finishes to meet the unique needs of any space.

- Match all fixtures in your styling space with Profiles metal frame finishes for a coordinated look: Chrome, Polished Nickel, Matte Gold, Matte Black
- Glass vanity fronts and side kits available in 11 colors
- Limitless design solutions with ability to mix and match
- Spacious drawers and tip out storage options eliminate clutter and make the daily routine effortless



Four Week Lead Time



Modular



Electrical Outlet



Night Light

30-1/8" W x 18-3/4" D Vanity		Frame Finish	Models	Stock Colors	Classic Colors	Special Order Colors	
Description		76, 77, 82, 83		10, 11, 20, 21	22, 26, 27, 28	12, 19, 23	
				Price	Price	Price	
7-1/2" H Vanity – Plumbing Drawer, No Undercounter Sink							
	Base Unit	76, 77	VP30H1D18P __ N76	VP30H1D18P __ N77	\$ 1,799.	\$ 2,229.	\$ 2,679.
	With 2700K/4000K Night Light		VP30H1D18P __ S76	VP30H1D18P __ S77	\$ 2,179.	\$ 2,629.	\$ 3,049.
	Base Unit	82, 83	VP30H1D18P __ N82	VP30H1D18P __ N83	\$ 1,899.	\$ 2,349.	\$ 2,779.
	With 2700K/4000K Night Light		VP30H1D18P __ S82	VP30H1D18P __ S83	\$ 2,279.	\$ 2,729.	\$ 3,149.
7-1/2" H Vanity – Full Drawer, No Sink							
	Base Unit	76, 77	VP30H1D18F __ N76	VP30H1D18F __ N77	\$ 1,799.	\$ 2,229.	\$ 2,679.
	With 2700K/4000K Night Light		VP30H1D18F __ S76	VP30H1D18F __ S77	\$ 2,179.	\$ 2,629.	\$ 3,049.
	Base Unit	82, 83	VP30H1D18F __ N82	VP30H1D18F __ N83	\$ 1,899.	\$ 2,349.	\$ 2,779.
	With 2700K/4000K Night Light		VP30H1D18F __ S82	VP30H1D18F __ S83	\$ 2,279.	\$ 2,729.	\$ 3,149.
7-1/2" H Vanity – Tip Out Drawer							
	Base Unit	76, 77	VP30H1D18T __ N76	VP30H1D18T __ N77	\$ 1,799.	\$ 2,229.	\$ 2,679.
	With 2700K/4000K Night Light		VP30H1D18T __ S76	VP30H1D18T __ S77	\$ 2,179.	\$ 2,629.	\$ 3,049.
	Base Unit	82, 83	VP30H1D18T __ N82	VP30H1D18T __ N83	\$ 1,899.	\$ 2,349.	\$ 2,779.
	With 2700K/4000K Night Light		VP30H1D18T __ S82	VP30H1D18T __ S83	\$ 2,279.	\$ 2,729.	\$ 3,149.
15" H Vanity – Plumbing Drawer							
	Base Unit	76, 77	VP30H2D18P __ N76	VP30H2D18P __ N77	\$ 2,029.	\$ 2,449.	\$ 2,879.
	With 2700K/4000K Night Light		VP30H2D18P __ S76	VP30H2D18P __ S77	\$ 2,399.	\$ 2,829.	\$ 3,279.
	Base Unit	82, 83	VP30H2D18P __ N82	VP30H2D18P __ N83	\$ 2,129.	\$ 2,549.	\$ 2,999.
	With 2700K/4000K Night Light		VP30H2D18P __ S82	VP30H2D18P __ S83	\$ 2,499.	\$ 2,949.	\$ 3,379.
15" H Vanity – Full Drawer, No Sink							
	Base Unit	76, 77	VP30H2D18F __ N76	VP30H2D18F __ N77	\$ 2,029.	\$ 2,449.	\$ 2,879.
	With 2700K/4000K Night Light		VP30H2D18F __ S76	VP30H2D18F __ S77	\$ 2,399.	\$ 2,829.	\$ 3,279.
	Base Unit	82, 83	VP30H2D18F __ N82	VP30H2D18F __ N83	\$ 2,129.	\$ 2,549.	\$ 2,999.
	With 2700K/4000K Night Light		VP30H2D18F __ S82	VP30H2D18F __ S83	\$ 2,499.	\$ 2,949.	\$ 3,379.

Fill in __ designator to Model listed above with desired color listed on the following page.
Example: VP30H2D18F26S76.

See Vanity Color/Finish Options, Vanity Tops, Accessories & Options on the following page.

Profiles™ Vanity – VP30 – 30" W x 18" D

Vanity Glass Colors and Frame Finishes

Fill in __ designator to Model listed at left with desired color. Example: VP30H2D18F26S76.

Stock Colors	Classic Colors	Special Order Colors	Frame Finishes
10 Mirror	22 Beach	12 Satin Bronze	76 Chrome
11 Tinted Gray Mirror	26 Matte White	19 Satin White	77 Polished Nickel
20 Black	27 Matte Gray	23 Ocean	82 Matte Gold
21 White	28 Matte Black		83 Matte Black

31" W x 19" D Vanity Tops – For 18" D Vanities

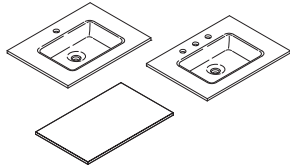

Description	For Use With Vanity	See Page
TC31UCN __ Glass Vanity Top	Plumbing & Tip Out Drawer	129
TE31G __ Engineered Stone Vanity Top (No Sink)	30" W Vanities	129

Undercounter Sink available for Custom Countertop – see page 135.
See Profiles Ganging Reference on page 72.

Accessories & Options

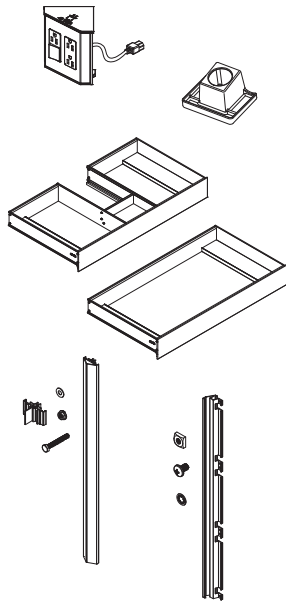

Description	Model	Price
Electric Accessory For use in 15" H plumbing or full drawer (H2)	VAELECTRIC18	\$ 449.
Hair Styling Organizer For use in 15" H plumbing (vessel only) or full drawer (H2)	VAHAIRORG	\$ 229.
Slim Drawer Insert For use in 15" H plumbing drawer (H2)	VADRAWER30P	\$ 729.
For use in 15" H full drawer (H2)	VADRAWER30X	\$ 729.
Note: Not for use with plumbing drawer undercounter sink installations or with Robern's stone vanity tops. Can be used in above-counter vessel installations.		
Vanity Ganging Kit – Hardware required when combining two or more vanities		
7-1/2" H	VMGKITH1	\$ 99.
15" H	VMGKITH2	\$ 99.
22-1/2" H	VMGKITH3	\$ 229.
30" H	VMGKITH4	\$ 229.
Vanity Alcove Finishing Kit – Hardware required for corner or alcove installations		
7-1/2" H	VMAKITH1	\$ 99.
15" H	VMAKITH2	\$ 99.
22-1/2" H	VMAKITH3	\$ 229.
30" H	VMAKITH4	\$ 229.

See additional Accessories on pages 266 – 268.

Vanity Side Kits

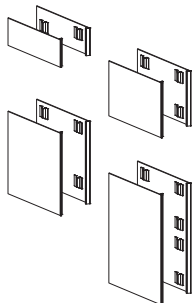

Description	Model	Stock Colors	Classic Colors	Special Order Colors
Vanity Side Kits – Includes glass panel(s) & hardware (see Color Options above)				
Single, 7-1/2" H, 18" D	VM1SKH1D18-__	\$ 229.	\$ 279.	\$ 329.
Pair, 7-1/2" H, 18" D	VM2SKH1D18-__	\$ 329.	\$ 449.	\$ 549.
Single, 15" H, 18" D	VM1SKH2D18-__	\$ 279.	\$ 329.	\$ 399.
Pair, 15" H, 18" D	VM2SKH2D18-__	\$ 399.	\$ 499.	\$ 629.
Single, 22-1/2" H, 18" D	VM1SKH3D18-__	\$ 329.	\$ 399.	\$ 449.
Pair, 22-1/2" H, 18" D	VM2SKH3D18-__	\$ 549.	\$ 679.	\$ 799.
Single, 30" H, 18" D	VM1SKH4D18-__	\$ 399.	\$ 449.	\$ 499.
Pair, 30" H, 18" D	VM2SKH4D18-__	\$ 679.	\$ 799.	\$ 899.

Note: You must choose one side kit or alcove kit for every exposed side.

SEE PAGES 70 – 71 FOR TIPS AND FEATURES.

Profiles™ Vanity – VP30 – 30" W x 21" D



For those who want a high-functioning styling space, that pays homage to an age gone by, the Profiles Collection offers mirrored cabinets, mirrors, vanities, and task lighting in a wide assortment of sizes and finishes to meet the unique needs of any space.

- Match all fixtures in your styling space with Profiles metal frame finishes for a coordinated look: Chrome, Polished Nickel, Matte Gold, Matte Black
- Glass vanity fronts and side kits available in 11 colors
- Limitless design solutions with ability to mix and match
- Spacious drawers and tip out storage options eliminate clutter and make the daily routine effortless



Four Week Lead Time



Modular



Electrical Outlet

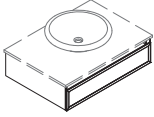
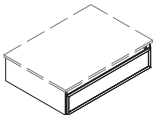
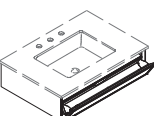
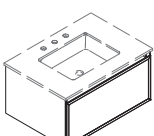
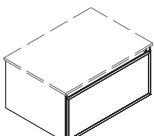

Night Light

30-1/8" W x 21-3/4" D Vanity		Frame Finish	Models	Stock Colors	Classic Colors	Special Order Colors	
Description		76, 77, 82, 83		10, 11, 20, 21	22, 26, 27, 28	12, 19, 23	
				Price	Price	Price	
7-1/2" H Vanity – Plumbing Drawer, No Undercounter Sink							
	Base Unit	76, 77	VP30H1D21P __ N76	VP30H1D21P __ N77	\$ 1,799.	\$ 2,229.	\$ 2,679.
	With 2700K/4000K Night Light		VP30H1D21P __ S76	VP30H1D21P __ S77	\$ 2,179.	\$ 2,629.	\$ 3,049.
	Base Unit	82, 83	VP30H1D21P __ N82	VP30H1D21P __ N83	\$ 1,899.	\$ 2,349.	\$ 2,779.
	With 2700K/4000K Night Light		VP30H1D21P __ S82	VP30H1D21P __ S83	\$ 2,279.	\$ 2,729.	\$ 3,149.
7-1/2" H Vanity – Full Drawer, No Sink							
	Base Unit	76, 77	VP30H1D21F __ N76	VP30H1D21F __ N77	\$ 1,799.	\$ 2,229.	\$ 2,679.
	With 2700K/4000K Night Light		VP30H1D21F __ S76	VP30H1D21F __ S77	\$ 2,179.	\$ 2,629.	\$ 3,049.
	Base Unit	82, 83	VP30H1D21F __ N82	VP30H1D21F __ N83	\$ 1,899.	\$ 2,349.	\$ 2,779.
	With 2700K/4000K Night Light		VP30H1D21F __ S82	VP30H1D21F __ S83	\$ 2,279.	\$ 2,729.	\$ 3,149.
7-1/2" H Vanity – Tip Out Drawer							
	Base Unit	76, 77	VP30H1D21T __ N76	VP30H1D21T __ N77	\$ 1,799.	\$ 2,229.	\$ 2,679.
	With 2700K/4000K Night Light		VP30H1D21T __ S76	VP30H1D21T __ S77	\$ 2,179.	\$ 2,629.	\$ 3,049.
	Base Unit	82, 83	VP30H1D21T __ N82	VP30H1D21T __ N83	\$ 1,899.	\$ 2,349.	\$ 2,779.
	With 2700K/4000K Night Light		VP30H1D21T __ S82	VP30H1D21T __ S83	\$ 2,279.	\$ 2,729.	\$ 3,149.
15" H Vanity – Plumbing Drawer							
	Base Unit	76, 77	VP30H2D21P __ N76	VP30H2D21P __ N77	\$ 2,029.	\$ 2,449.	\$ 2,879.
	With 2700K/4000K Night Light		VP30H2D21P __ S76	VP30H2D21P __ S77	\$ 2,399.	\$ 2,829.	\$ 3,279.
	Base Unit	82, 83	VP30H2D21P __ N82	VP30H2D21P __ N83	\$ 2,129.	\$ 2,549.	\$ 2,999.
	With 2700K/4000K Night Light		VP30H2D21P __ S82	VP30H2D21P __ S83	\$ 2,499.	\$ 2,949.	\$ 3,379.
15" H Vanity – Full Drawer, No Sink							
	Base Unit	76, 77	VP30H2D21F __ N76	VP30H2D21F __ N77	\$ 2,029.	\$ 2,449.	\$ 2,879.
	With 2700K/4000K Night Light		VP30H2D21F __ S76	VP30H2D21F __ S77	\$ 2,399.	\$ 2,829.	\$ 3,279.
	Base Unit	82, 83	VP30H2D21F __ N82	VP30H2D21F __ N83	\$ 2,129.	\$ 2,549.	\$ 2,999.
	With 2700K/4000K Night Light		VP30H2D21F __ S82	VP30H2D21F __ S83	\$ 2,499.	\$ 2,949.	\$ 3,379.

Fill in __ designator to Model listed above with desired color listed on the following page.
Example: VP30H2D21F26S76.

See Vanity Color/Finish Options, Vanity Tops, Accessories & Options on the following page.

Profiles™ Vanity – VP30 – 30" W x 21" D

Vanity Glass Colors and Frame Finishes

Fill in __ designator to Model listed at left with desired color. Example: VP30H2D21F26S76.

Stock Colors	Classic Colors	Special Order Colors	Frame Finishes
10 Mirror	22 Beach	12 Satin Bronze	76 Chrome
11 Tinted Gray Mirror	26 Matte White	19 Satin White	77 Polished Nickel
20 Black	27 Matte Gray	23 Ocean	82 Matte Gold
21 White	28 Matte Black		83 Matte Black

31" W x 22" D Vanity Tops – For 21" D Vanities

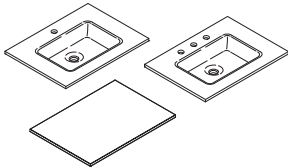

Description	For Use With Vanity	See Page
TS31UCN __ Glass Vanity Top	Plumbing & Tip Out Drawer	129
TF31UCO __ Engineered Stone Vanity Top	Plumbing & Tip Out Drawer	129
TF31G __ Engineered Stone Vanity Top (No Sink)	30" W Vanities	129

**Undercounter Sink available for Custom Countertop – see page 135.
See Profiles Ganging Reference on page 72.**

Accessories & Options

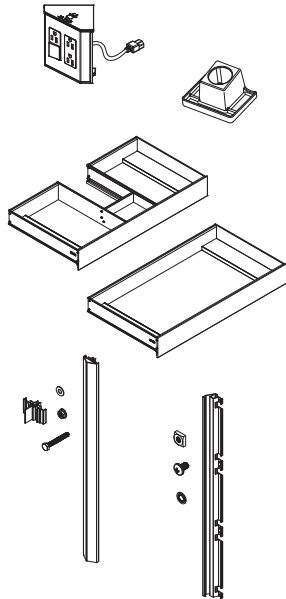

Description	Model	Price
Electric Accessory For use in 15" H plumbing or full drawer (H2)	VAELECTRIC21	\$ 449.
Hair Styling Organizer For use in 15" H plumbing (vessel only) or full drawer (H2)	VAHAIRORG	\$ 229.
Slim Drawer Insert For use in 15" H plumbing drawer (H2)	VADRAWER30P	\$ 729.
For use in 15" H full drawer (H2)	VADRAWER30X	\$ 729.
Note: Not for use with plumbing drawer undercounter sink installations or with Robern's stone vanity tops. Can be used in above-counter vessel installations.		
Vanity Ganging Kit – Hardware required when combining two or more vanities		
7-1/2" H	VMGKITH1	\$ 99.
15" H	VMGKITH2	\$ 99.
22-1/2" H	VMGKITH3	\$ 229.
30" H	VMGKITH4	\$ 229.
Vanity Alcove Finishing Kit – Hardware required for corner or alcove installations		
7-1/2" H	VMAKITH1	\$ 99.
15" H	VMAKITH2	\$ 99.
22-1/2" H	VMAKITH3	\$ 229.
30" H	VMAKITH4	\$ 229.

See additional Accessories on pages 266 – 268.

Vanity Side Kits

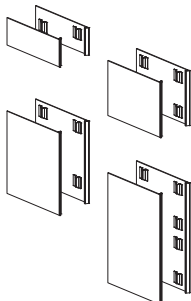

Description	Model	Stock Colors	Classic Colors	Special Order Colors
Vanity Side Kits – Includes glass panel(s) & hardware (see Color Options above)				
Single, 7-1/2" H, 21" D	VM1SKH1D21- __	\$ 229.	\$ 279.	\$ 329.
Pair, 7-1/2" H, 21" D	VM2SKH1D21- __	\$ 329.	\$ 449.	\$ 549.
Single, 15" H, 21" D	VM1SKH2D21- __	\$ 279.	\$ 329.	\$ 399.
Pair, 15" H, 21" D	VM2SKH2D21- __	\$ 399.	\$ 499.	\$ 629.
Single, 22-1/2" H, 21" D	VM1SKH3D21- __	\$ 329.	\$ 399.	\$ 449.
Pair, 22-1/2" H, 21" D	VM2SKH3D21- __	\$ 549.	\$ 679.	\$ 799.
Single, 30" H, 21" D	VM1SKH4D21- __	\$ 399.	\$ 449.	\$ 499.
Pair, 30" H, 21" D	VM2SKH4D21- __	\$ 679.	\$ 799.	\$ 899.

Note: You must choose one side kit or alcove kit for every exposed side.

SEE PAGES 70 – 71 FOR TIPS AND FEATURES.

Profiles™ Vanity – VP36 – 36" W x 18" D



For those who want a high-functioning styling space, that pays homage to an age gone by, the Profiles Collection offers mirrored cabinets, mirrors, vanities, and task lighting in a wide assortment of sizes and finishes to meet the unique needs of any space.

- Match all fixtures in your styling space with Profiles metal frame finishes for a coordinated look: Chrome, Polished Nickel, Matte Gold, Matte Black
- Glass vanity fronts and side kits available in 11 colors
- Limitless design solutions with ability to mix and match
- Spacious drawers and tip out storage options eliminate clutter and make the daily routine effortless



Four Week Lead Time



Modular



Electrical Outlet



Night Light

36-1/8" W x 18-3/4" D Vanity		Frame Finish	Models	Stock Colors	Classic Colors	Special Order Colors	
Description		76, 77, 82, 83		10, 11, 20, 21	22, 26, 27, 28	12, 19, 23	
				Price	Price	Price	
7-1/2" H Vanity – Plumbing Drawer, No Undercounter Sink							
	Base Unit	76, 77	VP36H1D18P __ N76	VP36H1D18P __ N77	\$ 2,349.	\$ 2,779.	\$ 3,199.
	With 2700K/4000K Night Light		VP36H1D18P __ S76	VP36H1D18P __ S77	\$ 2,779.	\$ 3,199.	\$ 3,649.
	Base Unit	82, 83	VP36H1D18P __ N82	VP36H1D18P __ N83	\$ 2,449.	\$ 2,879.	\$ 3,329.
	With 2700K/4000K Night Light		VP36H1D18P __ S82	VP36H1D18P __ S83	\$ 2,879.	\$ 3,329.	\$ 3,749.
7-1/2" H Vanity – Full Drawer, No Sink							
	Base Unit	76, 77	VP36H1D18F __ N76	VP36H1D18F __ N77	\$ 2,349.	\$ 2,779.	\$ 3,199.
	With 2700K/4000K Night Light		VP36H1D18F __ S76	VP36H1D18F __ S77	\$ 2,779.	\$ 3,199.	\$ 3,649.
	Base Unit	82, 83	VP36H1D18F __ N82	VP36H1D18F __ N83	\$ 2,449.	\$ 2,879.	\$ 3,329.
	With 2700K/4000K Night Light		VP36H1D18F __ S82	VP36H1D18F __ S83	\$ 2,879.	\$ 3,329.	\$ 3,749.
7-1/2" H Vanity – Tip Out Drawer							
	Base Unit	76, 77	VP36H1D18T __ N76	VP36H1D18T __ N77	\$ 2,349.	\$ 2,779.	\$ 3,199.
	With 2700K/4000K Night Light		VP36H1D18T __ S76	VP36H1D18T __ S77	\$ 2,779.	\$ 3,199.	\$ 3,649.
	Base Unit	82, 83	VP36H1D18T __ N82	VP36H1D18T __ N83	\$ 2,449.	\$ 2,879.	\$ 3,329.
	With 2700K/4000K Night Light		VP36H1D18T __ S82	VP36H1D18T __ S83	\$ 2,879.	\$ 3,329.	\$ 3,749.
15" H Vanity – Plumbing Drawer							
	Base Unit	76, 77	VP36H2D18P __ N76	VP36H2D18P __ N77	\$ 2,549.	\$ 2,999.	\$ 3,429.
	With 2700K/4000K Night Light		VP36H2D18P __ S76	VP36H2D18P __ S77	\$ 2,999.	\$ 3,429.	\$ 3,879.
	Base Unit	82, 83	VP36H2D18P __ N82	VP36H2D18P __ N83	\$ 2,679.	\$ 3,099.	\$ 3,549.
	With 2700K/4000K Night Light		VP36H2D18P __ S82	VP36H2D18P __ S83	\$ 3,099.	\$ 3,549.	\$ 3,979.
15" H Vanity – Full Drawer, No Sink							
	Base Unit	76, 77	VP36H2D18F __ N76	VP36H2D18F __ N77	\$ 2,549.	\$ 2,999.	\$ 3,429.
	With 2700K/4000K Night Light		VP36H2D18F __ S76	VP36H2D18F __ S77	\$ 2,999.	\$ 3,429.	\$ 3,879.
	Base Unit	82, 83	VP36H2D18F __ N82	VP36H2D18F __ N83	\$ 2,679.	\$ 3,099.	\$ 3,549.
	With 2700K/4000K Night Light		VP36H2D18F __ S82	VP36H2D18F __ S83	\$ 3,099.	\$ 3,549.	\$ 3,979.

Fill in __ designator to Model listed above with desired color listed on the following page.
Example: VP36H2D18F26S76.

See Vanity Color/Finish Options, Vanity Tops, Accessories & Options on the following page.

Profiles™ Vanity – VP36 – 36" W x 18" D

Vanity Glass Colors and Frame Finishes

Fill in __ designator to Model listed at left with desired color. Example: VP36H2D18F26S76.

Stock Colors	Classic Colors	Special Order Colors	Frame Finishes
10 Mirror	22 Beach	12 Satin Bronze	76 Chrome
11 Tinted Gray Mirror	26 Matte White	19 Satin White	77 Polished Nickel
20 Black	27 Matte Gray	23 Ocean	82 Matte Gold
21 White	28 Matte Black		83 Matte Black

37" W x 19" D Vanity Tops – For 18" D Vanities

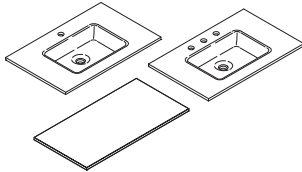

Description	For Use With Vanity	See Page
TC37UCN __ Glass Vanity Top	Plumbing & Tip Out Drawer	130
TE37G __ Engineered Stone Vanity Top (No Sink)	36" W Vanities	130

**Undercounter Sink available for Custom Countertop – see page 135.
See Profiles Ganging Reference on page 72.**

Accessories & Options

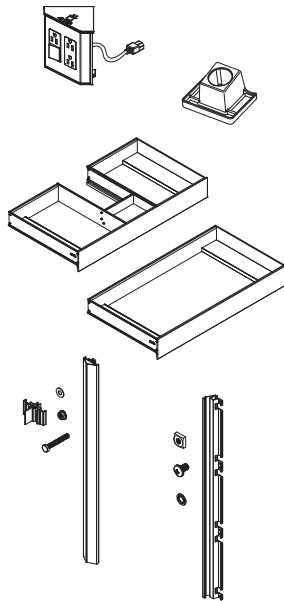

Description	Model	Price
Electric Accessory For use in 15" H plumbing or full drawer (H2)	VAELECTRIC18	\$ 449.
Hair Styling Organizer For use in 15" H plumbing (vessel only) or full drawer (H2)	VAHAIRORG	\$ 229.
Slim Drawer Insert For use in 15" H plumbing drawer (H2)	VADRAWER36P	\$ 799.
For use in 15" H full drawer (H2)	VADRAWER36X	\$ 799.
Note: Not for use with plumbing drawer undercounter sink installations or with Robern's stone vanity tops. Can be used in above-counter vessel installations.		
Vanity Ganging Kit – Hardware required when combining two or more vanities		
7-1/2" H	VMGKITH1	\$ 99.
15" H	VMGKITH2	\$ 99.
22-1/2" H	VMGKITH3	\$ 229.
30" H	VMGKITH4	\$ 229.
Vanity Alcove Finishing Kit – Hardware required for corner or alcove installations		
7-1/2" H	VMAKITH1	\$ 99.
15" H	VMAKITH2	\$ 99.
22-1/2" H	VMAKITH3	\$ 229.
30" H	VMAKITH4	\$ 229.

See additional Accessories on pages 266 – 268.

Vanity Side Kits

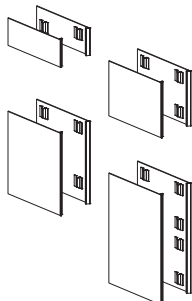

Description	Model	Stock Colors	Classic Colors	Special Order Colors
Vanity Side Kits – Includes glass panel(s) & hardware (see Color Options above)				
Single, 7-1/2" H, 18" D	VM1SKH1D18-__	\$ 229.	\$ 279.	\$ 329.
Pair, 7-1/2" H, 18" D	VM2SKH1D18-__	\$ 329.	\$ 449.	\$ 549.
Single, 15" H, 18" D	VM1SKH2D18-__	\$ 279.	\$ 329.	\$ 399.
Pair, 15" H, 18" D	VM2SKH2D18-__	\$ 399.	\$ 499.	\$ 629.
Single, 22-1/2" H, 18" D	VM1SKH3D18-__	\$ 329.	\$ 399.	\$ 449.
Pair, 22-1/2" H, 18" D	VM2SKH3D18-__	\$ 549.	\$ 679.	\$ 799.
Single, 30" H, 18" D	VM1SKH4D18-__	\$ 399.	\$ 449.	\$ 499.
Pair, 30" H, 18" D	VM2SKH4D18-__	\$ 679.	\$ 799.	\$ 899.

Note: You must choose one side kit or alcove kit for every exposed side.

SEE PAGES 70 – 71 FOR TIPS AND FEATURES.

Profiles™ Vanity – VP36 – 36" W x 21" D



For those who want a high-functioning styling space, that pays homage to an age gone by, the Profiles Collection offers mirrored cabinets, mirrors, vanities, and task lighting in a wide assortment of sizes and finishes to meet the unique needs of any space.

- Match all fixtures in your styling space with Profiles metal frame finishes for a coordinated look: Chrome, Polished Nickel, Matte Gold, Matte Black
- Glass vanity fronts and side kits available in 11 colors
- Limitless design solutions with ability to mix and match
- Spacious drawers and tip out storage options eliminate clutter and make the daily routine effortless



Four Week Lead Time



Modular



Electrical Outlet

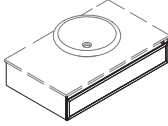
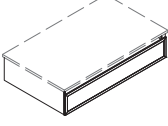
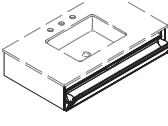
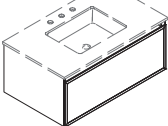
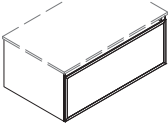

Night Light

36-1/8" W x 21-3/4" D Vanity		Frame Finish	Models	Stock Colors	Classic Colors	Special Order Colors	
Description		76, 77, 82, 83		10, 11, 20, 21	22, 26, 27, 28	12, 19, 23	
				Price	Price	Price	
7-1/2" H Vanity – Plumbing Drawer, No Undercounter Sink							
	Base Unit	76, 77	VP36H1D21P __ N76	VP36H1D21P __ N77	\$ 2,349.	\$ 2,779.	\$ 3,199.
	With 2700K/4000K Night Light		VP36H1D21P __ S76	VP36H1D21P __ S77	\$ 2,779.	\$ 3,199.	\$ 3,649.
	Base Unit	82, 83	VP36H1D21P __ N82	VP36H1D21P __ N83	\$ 2,449.	\$ 2,879.	\$ 3,329.
	With 2700K/4000K Night Light		VP36H1D21P __ S82	VP36H1D21P __ S83	\$ 2,879.	\$ 3,329.	\$ 3,749.
7-1/2" H Vanity – Full Drawer, No Sink							
	Base Unit	76, 77	VP36H1D21F __ N76	VP36H1D21F __ N77	\$ 2,349.	\$ 2,779.	\$ 3,199.
	With 2700K/4000K Night Light		VP36H1D21F __ S76	VP36H1D21F __ S77	\$ 2,779.	\$ 3,199.	\$ 3,649.
	Base Unit	82, 83	VP36H1D21F __ N82	VP36H1D21F __ N83	\$ 2,449.	\$ 2,879.	\$ 3,329.
	With 2700K/4000K Night Light		VP36H1D21F __ S82	VP36H1D21F __ S83	\$ 2,879.	\$ 3,329.	\$ 3,749.
7-1/2" H Vanity – Tip Out Drawer							
	Base Unit	76, 77	VP36H1D21T __ N76	VP36H1D21T __ N77	\$ 2,349.	\$ 2,779.	\$ 3,199.
	With 2700K/4000K Night Light		VP36H1D21T __ S76	VP36H1D21T __ S77	\$ 2,779.	\$ 3,199.	\$ 3,649.
	Base Unit	82, 83	VP36H1D21T __ N82	VP36H1D21T __ N83	\$ 2,449.	\$ 2,879.	\$ 3,329.
	With 2700K/4000K Night Light		VP36H1D21T __ S82	VP36H1D21T __ S83	\$ 2,879.	\$ 3,329.	\$ 3,749.
15" H Vanity – Plumbing Drawer							
	Base Unit	76, 77	VP36H2D21P __ N76	VP36H2D21P __ N77	\$ 2,549.	\$ 2,999.	\$ 3,429.
	With 2700K/4000K Night Light		VP36H2D21P __ S76	VP36H2D21P __ S77	\$ 2,999.	\$ 3,429.	\$ 3,879.
	Base Unit	82, 83	VP36H2D21P __ N82	VP36H2D21P __ N83	\$ 2,679.	\$ 3,099.	\$ 3,549.
	With 2700K/4000K Night Light		VP36H2D21P __ S82	VP36H2D21P __ S83	\$ 3,099.	\$ 3,549.	\$ 3,979.
15" H Vanity – Full Drawer, No Sink							
	Base Unit	76, 77	VP36H2D21F __ N76	VP36H2D21F __ N77	\$ 2,549.	\$ 2,999.	\$ 3,429.
	With 2700K/4000K Night Light		VP36H2D21F __ S76	VP36H2D21F __ S77	\$ 2,999.	\$ 3,429.	\$ 3,879.
	Base Unit	82, 83	VP36H2D21F __ N82	VP36H2D21F __ N83	\$ 2,679.	\$ 3,099.	\$ 3,549.
	With 2700K/4000K Night Light		VP36H2D21F __ S82	VP36H2D21F __ S83	\$ 3,099.	\$ 3,549.	\$ 3,979.

Fill in __ designator to Model listed above with desired color listed on the following page.
Example: VP36H2D21F26S76.

See Vanity Color/Finish Options, Vanity Tops, Accessories & Options on the following page.

Profiles™ Vanity – VP36 – 36" W x 21" D

Vanity Glass Colors and Frame Finishes

Fill in __ designator to Model listed at left with desired color. Example: VP36H2D21F26S76.

Stock Colors	Classic Colors	Special Order Colors	Frame Finishes
10 Mirror	22 Beach	12 Satin Bronze	76 Chrome
11 Tinted Gray Mirror	26 Matte White	19 Satin White	77 Polished Nickel
20 Black	27 Matte Gray	23 Ocean	82 Matte Gold
21 White	28 Matte Black		83 Matte Black

37" W x 22" D Vanity Tops – For 21" D Vanities

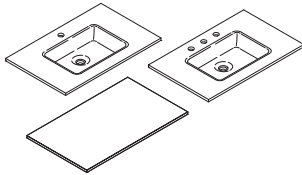

Description	For Use With Vanity	See Page
TF37UCO __ Engineered Stone Vanity Top	Plumbing & Tip Out Drawer	130
TF37G __ Engineered Stone Vanity Top (No Sink)	36" W Vanities	130

**Undercounter Sink available for Custom Countertop – see page 135.
See Profiles Ganging Reference on page 72.**

Accessories & Options

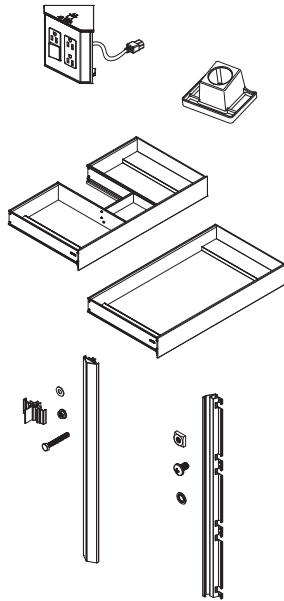

Description	Model	Price
Electric Accessory For use in 15" H plumbing or full drawer (H2)	VAELECTRIC21	\$ 449.
Hair Styling Organizer For use in 15" H plumbing (vessel only) or full drawer (H2)	VAHAIRORG	\$ 229.
Slim Drawer Insert For use in 15" H plumbing drawer (H2)	VADRAWER36P	\$ 799.
For use in 15" H full drawer (H2)	VADRAWER36X	\$ 799.
Note: Not for use with plumbing drawer undercounter sink installations or with Robern's stone vanity tops. Can be used in above-counter vessel installations.		
Vanity Ganging Kit – Hardware required when combining two or more vanities		
7-1/2" H	VMGKITH1	\$ 99.
15" H	VMGKITH2	\$ 99.
22-1/2" H	VMGKITH3	\$ 229.
30" H	VMGKITH4	\$ 229.
Vanity Alcove Finishing Kit – Hardware required for corner or alcove installations		
7-1/2" H	VMAKITH1	\$ 99.
15" H	VMAKITH2	\$ 99.
22-1/2" H	VMAKITH3	\$ 229.
30" H	VMAKITH4	\$ 229.

See additional Accessories on pages 266 – 268.

Vanity Side Kits

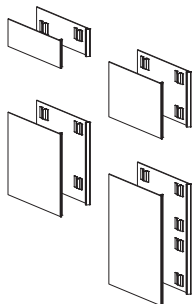

Description	Model	Stock Colors	Classic Colors	Special Order Colors
Vanity Side Kits – Includes glass panel(s) & hardware (see Color Options above)				
Single, 7-1/2" H, 21" D	VM1SKH1D21- __	\$ 229.	\$ 279.	\$ 329.
Pair, 7-1/2" H, 21" D	VM2SKH1D21- __	\$ 329.	\$ 449.	\$ 549.
Single, 15" H, 21" D	VM1SKH2D21- __	\$ 279.	\$ 329.	\$ 399.
Pair, 15" H, 21" D	VM2SKH2D21- __	\$ 399.	\$ 499.	\$ 629.
Single, 22-1/2" H, 21" D	VM1SKH3D21- __	\$ 329.	\$ 399.	\$ 449.
Pair, 22-1/2" H, 21" D	VM2SKH3D21- __	\$ 549.	\$ 679.	\$ 799.
Single, 30" H, 21" D	VM1SKH4D21- __	\$ 399.	\$ 449.	\$ 499.
Pair, 30" H, 21" D	VM2SKH4D21- __	\$ 679.	\$ 799.	\$ 899.

Note: You must choose one side kit or alcove kit for every exposed side.

SEE PAGES 70 – 71 FOR TIPS AND FEATURES.

V14® Vanities – Table of Contents, Tips & Features

Table of Contents

V14 Vanity Tips & Features	88 – 89
V14 Vanity Model Number Worksheet	90
V14 Vanities	92 – 93
12" Wide V14 Vanity – Side Drawer	92 – 93
24" Wide V14 Vanity	94 – 95
30" Wide V14 Vanity	96 – 97
36" Wide V14 Vanity	98 – 99
48" Wide V14 Vanity	100 – 101
60" Wide V14 Vanity	102 – 103
V14 Vanity Ganging Reference	104 – 105
Vanity Tops	128 – 135
Vanity Accessories	265 – 270

Tips & Features

Dimensions & Weight

- Width: 12-1/4" (311 mm), 24-1/4" (616 mm), 30-1/4" (769 mm), 36-1/4" (921 mm), 48-1/4" (1226 mm), 60-1/4" (1530 mm)
- Height: 14" (356 mm)
- Depth: 21" (533 mm)
- Net Weight: 30 – 157 lbs

Features & Benefits

- Glass finish options: Mirror, 12 decorative gloss and matte finishes
- Choose between a contemporary look with hand-free operation drawers that open with a gentle push (push-to-open) or a more traditional design featuring a stylish ergonomically designed handle in brushed aluminum trim and slow-close drawers
- Plumbing drawer allows clearance for drain and full drawer allows for maximum storage when plumbing does not exist
- Vanities are modular and can be ganged with other V14 vanities to fit a variety of desired widths
- Vanities include five glass bins for plumbing drawers and four glass bins for full drawers

Features & Benefits (Continued)

- Organization kit: two fully adjustable glass drawer dividers provide storage right where you need it and prevent items from moving and sliding in the drawer
- Night Light Option – integrated LED night light with light bar built into top frame of each drawer, provides soft light to illuminate drawer interior and for wayfinding light in 5000 Kelvin. Night light is ETL certified to UL 2108, CSA Standard C22.2 No. 12
- Electric accessory option: three plugs and a switch that turns off power to the unit to keep appliances safely plugged in

Configurable Options

- Decorative Glass Options: Mirror, 12 decorative gloss and matte finishes
- Drawer Application: full drawer or plumbing drawer
- Drawer Type: push-to-open or slow-close
- Night Light: No Night Light or Integrated LED Night Light in 5000 Kelvin



Stock Colors



Classic and Special Order Colors

V14® Vanities – Tips & Features

Tips & Features (Continued)

Construction

- Durable rust-free anodized aluminum and glass construction – glass resists intense moisture, ensuring long-lasting beauty
- 14" high vanity designed for convenient, customized bathroom storage
- Slow-close drawer features an ergonomically designed, integrated handle in brushed aluminum to coordinate with brushed aluminum trim; handle adds 1" depth to the depth of the vanity
- Uniquely designed push-to-open drawer mechanism provides hand-free operation
- Constructed for wall hanging loads with stone tops
- Glass fronts and side kits are replaceable
- White shatter-protected glass drawer bottoms will not degrade or show wear. Glass dissipates heat to ensure confidence that hot items will not leave heat marks on the bottom of the drawers

Installation

- This installation may require more than one person
- Includes installation hardware and structural bolts
- Special site preparation is required. Wall bracing and Robern supplied hardware are recommended
- The plumbing must be roughed into the plumbing cutout area of the vanity. Refer to the sink rough-in and the vanity rough-in for proper placement. The water supply and drain lines must be installed before installing the vanity.
- Modular units require a ganging kit to ensure proper space and drawer functionality; hardware required when stacking two or more wall hung vanities
- Full drawer units are intended for ganging and stacking and are not designed to accept a sink
- Included side kit adds 1/8" to each side, 1/4" to overall width of vanity (does not apply to 12" W vanities)
- 12" W Unit: single-drawer, no sink (12" W drawers are intended for ganging with other V14 units and do not ship with a side kit)
- 24" W, 30" W and 36" W Units: single plumbing clearance drawer, center sink installation and single full storage drawer, no sink
- 36" W Unit: 24" W unit with left or right plumbing clearance drawer for left or right mount sink installation, and 12" W unit (no sink)

Installation (Continued)

- 48" W Unit: three drawer unit consists of 24" W unit with center plumbing clearance drawer for center mount sink, flanked by two 12" W units (no sink) to left and right
- 60" W Unit: three drawer unit consists 36" W unit with center plumbing clearance drawer for center mount sink, flanked by two 12" W units (no sink) to left and right
- Night light option (L) – 12VDC plug-in transformer in 5000 Kelvin color temperature. Locate wall outlet as per installation instructions.
- Electric Accessory option: 120VAC 20A tamper resistant outlet. Installed within vanity drawer; not recommended to be used in combination with Slim Drawer Insert; recommended in combination with Hair Styling Organizer
- Hair Styling Organizer fits all vanity drawers except 24" plumbing drawer; cannot be used in combination with slim drawer insert; recommended in combination with Electric Accessory
- Slim plumbing drawer insert must be used with an above-counter sink installation; full drawer version can be used in a full drawer - includes four glass bins
- Toilet paper holder is installed directly to the vanity and can be installed on either side of the vanity

Accessories

- In-drawer Electric Accessory (VFELECTRIC): ETL certified to UL 1363, CSA Standard C22.2 No. 21
- Accessory Night Light in 5000 Kelvin (CLEDS12, CLEDS24, CLEDS30, CLEDS36): Night light is ETL certified to UL 2108, CSA Standard C22.2 No. 12
- Slim Plumbing Drawer Insert with four glass bins (VFDRAWER24P, VFDRAWER30P, VFDRAWER36P)
- Slim Full Drawer Insert with four glass bins (VFDRAWER24X, VFDRAWER30X, VFDRAWER36X)
- Glass Bins: divided storage (GLASSBIN6.38), small (GLASSBIN3.25), medium (GLASSBIN5.25), large (GLASSBIN8.5)
- Vanity Accessory Toilet Paper Holder (VATP)
- Hair Styling Organizer (VAHAIRORG): fits most hair dryers and curling irons
- Ganging kits are required when combining two or more V14 vanities (VFGKIT)
- Vanity Stacking Kit required for stacking vanities (VFSTACK)
- Leg kits are optional for stacking vanities (VFSTACKA, VFSTACKL)
- Glass and engineered stone tops with porcelain sink



Stock Colors



Classic and Special Order Colors

V14® Vanity Model Number Worksheet

FEATURES

MODEL

VF

WM

Select Width:

24" 24
 30" 30
 36" 36
 48" 48
 60" 60

Drawer Application:

Plumbing Drawer PD
 Full Drawer FD

Sink Installation:

No Sink (FD models only) X
 Center Mount Sink C
 Right Mount Sink R
 Left Mount Sink L

Select Option:

Base Unit (No Night Light) N
 Night Light, 5000K L

Select Drawer:

Push-to-Open P
 Slow-Close with Handle S

Select Color:

Stock Colors*

Mirror 10
 Tinted Gray Mirror 11
 Black 20
 White 21

Classic Colors*

Beach 22
 Matte White 26
 Matte Gray 27
 Matte Black 28

Special Order Colors*

Satin Bronze 12
 Satin White 19
 Ocean 23
 Smoke Screen 24
 Silver Screen 25

12" W Drawer Installation:

Universal Installation —
 Left Drawer L
 Right Drawer R

CUSTOMER INFORMATION

Name _____
 Address _____
 City/State/Zip _____
 Telephone _____
 Date Ordered _____

Notes:

* Stock Colors have a 2 week lead time;
 all other Colors have a 4 week lead time.

V14® Vanity – VF12 – 12" W – Side Drawer



For those who want a simple floating vanity, the V14 Collection can be stacked vertically or ganged horizontally to create a unique layout with smartly designed storage space.

- Choice between slow-close and push-to-open drawers, both providing long-lasting effortless operation
- Provides task and way-finding light by using the night light option



Two Week Lead Time
(Stock Colors)



Four Week Lead Time
(Classic/Special Order Colors)



Modular



Electrical
Outlet



Night
Light

12-1/4" W x 14" H x 21" D Vanity

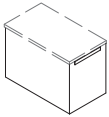
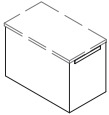
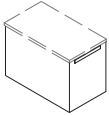
Description		Model	Stock Colors 10, 11, 20, 21 Price	Classic Colors 22, 26, 27, 28 Price	Special Order Colors 12, 19, 23, 24, 25 Price
Side Drawer, No Sink – Universal Installation					
	Base Unit, Slow-Close Drawer	VF12FDXNSWM __	\$ 1,199.	\$ 1,749.	\$ 2,279.
	With 5000K Night Light, Slow-Close Drawer	VF12FDXLSWM __	\$ 1,479.	\$ 2,029.	\$ 2,549.
	Base Unit, Push-to-Open Drawer	VF12FDXNPWM __	\$ 1,199.	\$ 1,749.	\$ 2,279.
	With 5000K Night Light, Push-to-Open Drawer	VF12FDXLPWM __	\$ 1,479.	\$ 2,029.	\$ 2,549.
Side Drawer, No Sink – Left Installation					
	Base Unit, Slow-Close Drawer	VF12FDXNSWM __ L	N/A	N/A	N/A
	With 5000K Night Light, Slow-Close Drawer	VF12FDXLSWM __ L	N/A	N/A	N/A
	Base Unit, Push-to-Open Drawer	VF12FDXNPWM __ L	N/A	N/A	N/A
	With 5000K Night Light, Push-to-Open Drawer	VF12FDXLPWM __ L	N/A	N/A	N/A
Side Drawer, No Sink – Right Installation					
	Base Unit, Slow-Close Drawer	VF12FDXNSWM __ R	N/A	N/A	N/A
	With 5000K Night Light, Slow-Close Drawer	VF12FDXLSWM __ R	N/A	N/A	N/A
	Base Unit, Push-to-Open Drawer	VF12FDXNPWM __ R	N/A	N/A	N/A
	With 5000K Night Light, Push-to-Open Drawer	VF12FDXLPWM __ R	N/A	N/A	N/A

Vanity Color Options

Fill in __ designator to Model listed above with desired color. Example: VF12FDXLSWM21R.

Stock Colors

- 10 Mirror
- 11 Tinted Gray Mirror
- 20 Black
- 21 White

Classic Colors

- 22 Beach
- 26 Matte White
- 27 Matte Gray
- 28 Matte Black

Special Order Colors

- 12 Satin Bronze
- 19 Satin White
- 23 Ocean
- 24 Smoke Screen
- 25 Silver Screen

See Vanity Tops, Accessories & Options on the following page.

V14® Vanity – VF12 – 12" W – Side Drawer

13" W x 22" D Vanity Tops – For 21" D Vanities

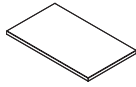

Description	For Use With Vanity	See Page
TF13G __ Engineered Stone Vanity Top (No Sink)	12" W Vanities	128

See V14 Ganging Reference on pages 104 – 105.

Accessories & Options

Description	Model	Price
 Electric Accessory For use in drawer	VFELECTRIC	\$ 449.
 Hair Styling Organizer For use in drawer	VAHAIRORG	\$ 229.
 Slim Drawer Insert For use in drawer	VFDRAWER12X	\$ 499.

See additional Accessories on pages 266 – 268.

Vanity Side Kits

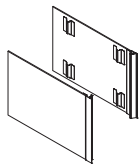

Description	Model	Stock Colors	Classic Colors	Special Order Colors
		Price	Price	Price
Includes 2 glass assemblies and hardware	VFSK- __	10, 11, 20, 21 \$ 549.	22, 26, 27, 28 \$ 679.	12, 19, 23, 24, 25 \$ 799.

Note: Side Kits are only required as an additional item when the 12" V14 units are being used independently (i.e. not being ganged with other V14 vanities).

Vanity Side Kit Color Options

Fill in __ designator to Model listed above with desired color. Example: VFSK-11.

Stock Colors

- 10 Mirror
- 11 Tinted Gray Mirror
- 20 Black
- 21 White

Classic Colors

- 22 Beach
- 26 Matte White
- 27 Matte Gray
- 28 Matte Black

Special Order Colors

- 12 Satin Bronze
- 19 Satin White
- 23 Ocean
- 24 Smoke Screen
- 25 Silver Screen

SEE PAGES 88 – 89 FOR TIPS AND FEATURES.

V14® Vanity – VF24 – 24" W



For those who want a simple floating vanity, the V14 Collection can be stacked vertically or ganged horizontally to create a unique layout with smartly designed storage space.

- Choice between slow-close and push-to-open drawers, both providing long-lasting effortless operation
- Provides task and way-finding light by using the night light option

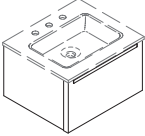
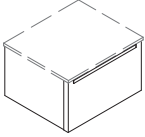

24-1/4" W x 14" H x 21" D Vanity		Stock Colors	Classic Colors	Special Order Colors	
Description	Model	10, 11, 20, 21 Price	22, 26, 27, 28 Price	12, 19, 23, 24, 25 Price	
Single-Drawer – 24" W Plumbing Drawer, Center Mount Sink					
	Base Unit, Slow-Close Drawer	VF24PDCNSWM __	\$ 1,749.	\$ 2,279.	\$ 2,829.
	With 5000K Night Light, Slow-Close Drawer	VF24PDCLSWM __	\$ 2,079.	\$ 2,629.	\$ 3,149.
	Base Unit, Push-to-Open Drawer	VF24PDCNPWM __	\$ 1,749.	\$ 2,279.	\$ 2,829.
	With 5000K Night Light, Push-to-Open Drawer	VF24PDCLPWM __	\$ 2,079.	\$ 2,629.	\$ 3,149.
Single-Drawer – 24" W Full Storage Drawer, No Sink					
	Base Unit, Slow-Close Drawer	VF24FDXNSWM __	\$ 1,749.	\$ 2,279.	\$ 2,829.
	With 5000K Night Light, Slow-Close Drawer	VF24FDXLSWM __	\$ 2,079.	\$ 2,629.	\$ 3,149.
	Base Unit, Push-to-Open Drawer	VF24FDXNPWM __	\$ 1,749.	\$ 2,279.	\$ 2,829.
	With 5000K Night Light, Push-to-Open Drawer	VF24FDXLPWM __	\$ 2,079.	\$ 2,629.	\$ 3,149.

Vanity Color Options		
Fill in __ designator to Model listed above with desired color. Example: VF24FDXLPWM20.		
Stock Colors	Classic Colors	Special Order Colors
10 Mirror	22 Beach	12 Satin Bronze
11 Tinted Gray Mirror	26 Matte White	19 Satin White
20 Black	27 Matte Gray	23 Ocean
21 White	28 Matte Black	24 Smoke Screen
		25 Silver Screen

See Vanity Tops, Accessories & Options on the following page.

V14® Vanity – VF24 – 24" W

25" W x 22" D Vanity Tops – For 21" D Vanities

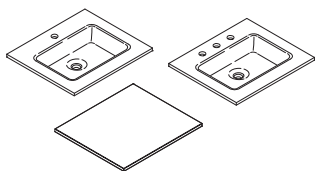

Description	For Use With Vanity	See Page
TS25UCN __ Glass Vanity Top	Plumbing Drawer	128
TF25UCO __ Engineered Stone Vanity Top	Plumbing Drawer	128
TF25G __ Engineered Stone Vanity Top (No Sink)	24" W Vanities	128

**Undercounter Sink available for Custom Countertop – see page 135.
See V14 Ganging Reference on pages 104 – 105.**

Accessories & Options

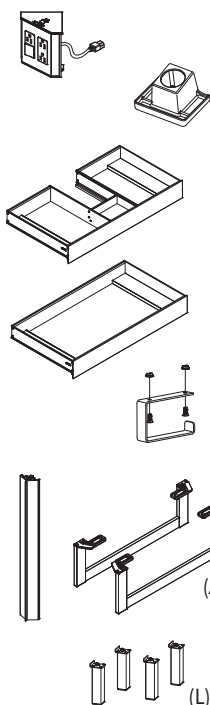

Description	Model	Price
Electric Accessory For use in plumbing or full storage drawer	VFELECTRIC	\$ 449.
Hair Styling Organizer For use in full storage drawer	VAHAIRORG	\$ 229.
Slim Drawer Insert For use in plumbing drawer	VFDRAWER24P	\$ 629.
For use in full storage drawer	VFDRAWER24X	\$ 629.
Note: Not for use with plumbing drawer undercounter sink installations or with Robern's stone vanity tops. Can be used in above-counter vessel installations.		
Vanity Accessory Toilet Paper Holder Can be installed on either side of vanity	VATP	\$ 99.
Vanity Ganging Kit Hardware required when combining two or more V14 vanities	VFGKIT	\$ 99.
Vanity Stacking Kits Hardware required for stacking two or more wall-hung vanities	VFSTACK	\$ 99.
Legs (2) & hardware for stacking two or more wall-hung vanities	VFSTACKA	\$ 279.
Legs (4) & hardware for stacking two or more wall-hung vanities	VFSTACKL	\$ 179.

See additional Accessories on pages 266 – 268.

SEE PAGES 88 – 89 FOR TIPS AND FEATURES.

V14® Vanity – VF30 – 30" W



For those who want a simple floating vanity, the V14 Collection can be stacked vertically or ganged horizontally to create a unique layout with smartly designed storage space.

- Choice between slow-close and push-to-open drawers, both providing long-lasting effortless operation
- Provides task and way-finding light by using the night light option

2 Two Week Lead Time (Stock Colors)

4 Four Week Lead Time (Classic/Special Order Colors)

Modular

Electrical Outlet

Night Light

Vanities & Tops

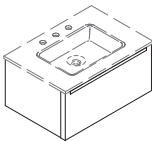
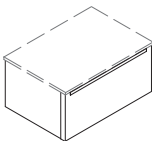
30-1/4" W x 14" H x 21" D Vanity		Stock Colors	Classic Colors	Special Order Colors
Description	Model	Price	Price	Price
Single-Drawer – 30" W Plumbing Drawer, Center Mount Sink				
 Base Unit, Slow-Close Drawer	VF30PDCNSWM __	\$ 2,279.	\$ 2,829.	\$ 3,379.
With 5000K Night Light, Slow-Close Drawer	VF30PDCLSWM __	\$ 2,679.	\$ 3,199.	\$ 3,749.
Base Unit, Push-to-Open Drawer	VF30PDCNPWM __	\$ 2,279.	\$ 2,829.	\$ 3,379.
With 5000K Night Light, Push-to-Open Drawer	VF30PDCLPWM __	\$ 2,679.	\$ 3,199.	\$ 3,749.
Single-Drawer – 30" W Full Storage Drawer, No Sink				
 Base Unit, Slow-Close Drawer	VF30FDXNSWM __	\$ 2,279.	\$ 2,829.	\$ 3,379.
With 5000K Night Light, Slow-Close Drawer	VF30FDXLSWM __	\$ 2,679.	\$ 3,199.	\$ 3,749.
Base Unit, Push-to-Open Drawer	VF30FDXNPWM __	\$ 2,279.	\$ 2,829.	\$ 3,379.
With 5000K Night Light, Push-to-Open Drawer	VF30FDXLPWM __	\$ 2,679.	\$ 3,199.	\$ 3,749.

Vanity Color Options

Fill in __ designator to Model listed above with desired color. Example: VF30PDCNSWM27.

Stock Colors

- 10 Mirror
- 11 Tinted Gray Mirror
- 20 Black
- 21 White

Classic Colors

- 22 Beach
- 26 Matte White
- 27 Matte Gray
- 28 Matte Black

Special Order Colors

- 12 Satin Bronze
- 19 Satin White
- 23 Ocean
- 24 Smoke Screen
- 25 Silver Screen

See Vanity Tops, Accessories & Options on the following page.

V14[®] Vanity – VF30 – 30" W



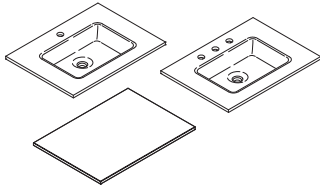

31" W x 22" D Vanity Tops – For 21" D Vanities



Description	For Use With Vanity	See Page
TS31UCN __ Glass Vanity Top	Plumbing Drawer	129
TF31UCO __ Engineered Stone Vanity Top	Plumbing Drawer	129
TF31G __ Engineered Stone Vanity Top (No Sink)	30" W Vanities	129

**Undercounter Sink available for Custom Countertop – see page 135.
See V14 Ganging Reference on pages 104 – 105.**

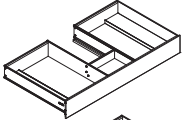
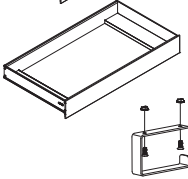
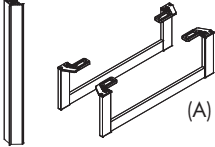
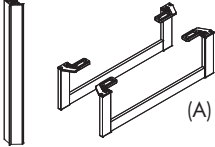
Accessories & Options

Description	Model	Price
 Electric Accessory For use in plumbing or full storage drawer	VFELECTRIC	\$ 449.
 Hair Styling Organizer For use in plumbing (vessel only) or full storage drawer	VAHAIRORG	\$ 229.
 Slim Drawer Insert For use in plumbing drawer For use in full storage drawer	VFDRAWER30P VFDRAWER30X	\$ 729. \$ 729.
 Vanity Accessory Toilet Paper Holder Can be installed on either side of vanity	VATP	\$ 99.
 Vanity Ganging Kit Hardware required when combining two or more V14 vanities	VFGKIT	\$ 99.
 Vanity Stacking Kits Hardware required for stacking two or more wall-hung vanities	VFSTACK	\$ 99.
 Legs (2) & hardware for stacking two or more wall-hung vanities	VFSTACKA	\$ 279.
 Legs (4) & hardware for stacking two or more wall-hung vanities	VFSTACKL	\$ 179.

See additional Accessories on pages 266 – 268.

SEE PAGES 88 – 89 FOR TIPS AND FEATURES.

V14[®] Vanity – VF36 – 36" W



For those who want a simple floating vanity, the V14 Collection can be stacked vertically or ganged horizontally to create a unique layout with smartly designed storage space.

- Choice between slow-close and push-to-open drawers, both providing long-lasting effortless operation
- Provides task and way-finding light by using the night light option

2 Two Week Lead Time (Stock Colors)

4 Four Week Lead Time (Classic/Special Order Colors)

Modular

Electrical Outlet

Night Light

Vanities & Tops

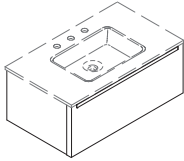
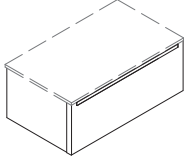
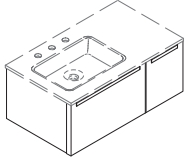
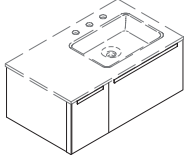
36-1/4" W x 14" H x 21" D Vanity		Stock Colors 10, 11, 20, 21 Price	Classic Colors 22, 26, 27, 28 Price	Special Order Colors 12, 19, 23, 24, 25 Price
Description	Model			
Single-Drawer – 36" W Plumbing Drawer, Center Mount Sink				
 Base Unit, Slow-Close Drawer	VF36PDCNSWM __	\$ 2,829.	\$ 3,379.	\$ 3,929.
With 5000K Night Light, Slow-Close Drawer	VF36PDCLSWM __	\$ 3,279.	\$ 3,799.	\$ 4,349.
Base Unit, Push-to-Open Drawer	VF36PDCNPWM __	\$ 2,829.	\$ 3,379.	\$ 3,929.
With 5000K Night Light, Push-to-Open Drawer	VF36PDCLPWM __	\$ 3,279.	\$ 3,799.	\$ 4,349.
Single-Drawer – 36" W Full Storage Drawer, No Sink				
 Base Unit, Slow-Close Drawer	VF36FDXNSWM __	\$ 2,829.	\$ 3,379.	\$ 3,929.
With 5000K Night Light, Slow-Close Drawer	VF36FDXLSWM __	\$ 3,279.	\$ 3,799.	\$ 4,349.
Base Unit, Push-to-Open Drawer	VF36FDXNPWM __	\$ 2,829.	\$ 3,379.	\$ 3,929.
With 5000K Night Light, Push-to-Open Drawer	VF36FDXLPWM __	\$ 3,279.	\$ 3,799.	\$ 4,349.
Two-Drawer – 24" W Left Plumbing Drawer for Left Mount Sink & 12" W Side Drawer				
 Base Unit, Slow-Close Drawer	VF36PDLNSWM __	\$ 2,949.	\$ 4,029.	\$ 5,129.
With 5000K Night Light, Slow-Close Drawer	VF36PDLLSWM __	\$ 3,379.	\$ 4,479.	\$ 5,549.
Base Unit, Push-to-Open Drawer	VF36PDLNPWM __	\$ 2,949.	\$ 4,029.	\$ 5,129.
With 5000K Night Light, Push-to-Open Drawer	VF36PDLLPWM __	\$ 3,379.	\$ 4,479.	\$ 5,549.
Two-Drawer – 24" W Right Plumbing Drawer for Right Mount Sink & 12" W Side Drawer				
 Base Unit, Slow-Close Drawer	VF36PDRNSWM __	\$ 2,949.	\$ 4,029.	\$ 5,129.
With 5000K Night Light, Slow-Close Drawer	VF36PDRLSWM __	\$ 3,379.	\$ 4,479.	\$ 5,549.
Base Unit, Push-to-Open Drawer	VF36PDRNPWM __	\$ 2,949.	\$ 4,029.	\$ 5,129.
With 5000K Night Light, Push-to-Open Drawer	VF36PDRLPWM __	\$ 3,379.	\$ 4,479.	\$ 5,549.

Fill in __ designator to Model listed above with desired color listed on the following page.
Example: VF36PDCLSWM24.

See Vanity Color Options, Vanity Tops, Accessories & Options on the following page.

V14® Vanity – VF36 – 36" W

Vanity Color Options

Fill in __ designator to Model listed at left with desired color. Example: VF36PDCLSWM24.

Stock Colors

- 10 Mirror
- 11 Tinted Gray Mirror
- 20 Black
- 21 White

Classic Colors

- 22 Beach
- 26 Matte White
- 27 Matte Gray
- 28 Matte Black

Special Order Colors

- 12 Satin Bronze
- 19 Satin White
- 23 Ocean
- 24 Smoke Screen
- 25 Silver Screen

37" W x 22" D Vanity Tops – For 21" D Vanities

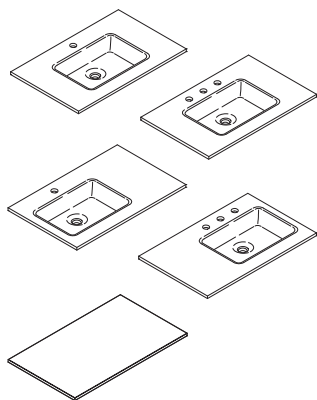

Description	For Use With Vanity	See Page
TF37UCO __ Engineered Stone Vanity Top	Plumbing Drawer, Center Sink	130
TF37ULO __ Engineered Stone Vanity Top	Plumbing Drawer, Left Sink	130
TF37URO __ Engineered Stone Vanity Top	Plumbing Drawer, Right Sink	130
TF37G __ Engineered Stone Vanity Top (No Sink)	36" W Vanities	130

**Undercounter Sink available for Custom Countertop – see page 135.
See V14 Ganging Reference on pages 104 – 105.**

Accessories & Options

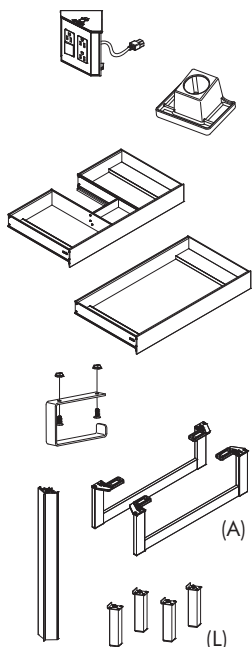

Description	Model	Price
Electric Accessory For use in plumbing or full storage drawer	VFELECTRIC	\$ 449.
Hair Styling Organizer For use in plumbing (vessel only) or full storage drawer	VAHAIRORG	\$ 229.
Slim Drawer Insert For use in 36" W plumbing drawer	VFDRAWER36P	\$ 799.
For use in 36" W full storage drawer	VFDRAWER36X	\$ 799.
For use in 24" W plumbing drawer	VFDRAWER24P	\$ 629.
Note: Not for use with plumbing drawer undercounter sink installations or with Robern's stone vanity tops. Can be used in above-counter vessel installations.		
For use in 12" W accessory side drawer	VFDRAWER12X	\$ 499.
Vanity Accessory Toilet Paper Holder Can be installed on either side of vanity	VATP	\$ 99.
Vanity Ganging Kit Hardware required when combining two or more V14 vanities	VFGKIT	\$ 99.
Vanity Stacking Kits Hardware required for stacking two or more wall-hung vanities	VFSTACK	\$ 99.
Legs (2) & hardware for stacking two or more wall-hung vanities	VFSTACKA	\$ 279.
Legs (4) & hardware for stacking two or more wall-hung vanities	VFSTACKL	\$ 179.

See additional Accessories on pages 266 – 268.

SEE PAGES 88 – 89 FOR TIPS AND FEATURES.

V14® Vanity – VF48 – 48" W



For those who want a simple floating vanity, the V14 Collection can be stacked vertically or ganged horizontally to create a unique layout with smartly designed storage space.

- Choice between slow-close and push-to-open drawers, both providing long-lasting effortless operation
- Provides task and way-finding light by using the night light option



Two Week Lead Time
(Stock Colors)



Four Week Lead Time
(Classic/Special Order Colors)



Electrical
Outlet



Night
Light

48-1/4" W x 14" H x 21" D Vanity

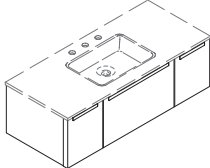
		Stock Colors 10, 11, 20, 21 Price	Classic Colors 22, 26, 27, 28 Price	Special Order Colors 12, 19, 23, 24, 25 Price	
Description	Model				
Three-Drawer – 24" W Plumbing Drawer for Center Mount Sink & two 12" W Side Drawers					
	Base Unit, Slow-Close Drawer	VF48PDCNSWM __	\$ 4,149.	\$ 5,779.	\$ 7,399.
	With 5000K Night Light, Slow-Close Drawer	VF48PDCLSWM __	\$ 4,749.	\$ 6,379.	\$ 7,999.
	Base Unit, Push-to-Open Drawer	VF48PDCNPWM __	\$ 4,149.	\$ 5,779.	\$ 7,399.
	With 5000K Night Light, Push-to-Open Drawer	VF48PDCLPWM __	\$ 4,749.	\$ 6,379.	\$ 7,999.

Vanity Color Options

Fill in __ designator to Model listed above with desired color. Example: VF48PDCLSWM24.

Stock Colors

- 10 Mirror
- 11 Tinted Gray Mirror
- 20 Black
- 21 White

Classic Colors

- 22 Beach
- 26 Matte White
- 27 Matte Gray
- 28 Matte Black

Special Order Colors

- 12 Satin Bronze
- 19 Satin White
- 23 Ocean
- 24 Smoke Screen
- 25 Silver Screen

See Vanity Tops, Accessories & Options on the following page.

V14[®] Vanity – VF48 – 48" W

49" W x 22" D Vanity Tops – For 21" D Vanities

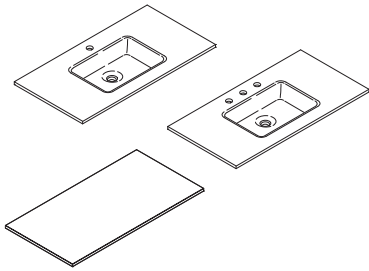

Description	For Use With Vanity	See Page
TF49UCO __ Engineered Stone Vanity Top	Plumbing Drawer	132
TF49G __ Engineered Stone Vanity Top (No Sink)	48" W Vanities	132

**Undercounter Sink available for Custom Countertop – see page 135.
See V14 Ganging Reference on pages 104 – 105.**

Accessories & Options

Description	Model	Price
 Electric Accessory For use in any drawer	VFELECTRIC	\$ 449.
 Hair Styling Organizer For use in plumbing (vessel only) or full storage drawer	VAHAIRORG	\$ 229.
 Slim Drawer Insert For use in 24" W plumbing drawer Note: Not for use with plumbing drawer undercounter sink installations or with Robern's stone vanity tops. Can be used in above-counter vessel installations.	VFDRAWER24P	\$ 629.
 For use in 12" W accessory side drawer	VFDRAWER12X	\$ 499.
 Vanity Accessory Toilet Paper Holder Can be installed on either side of vanity	VATP	\$ 99.
 Vanity Ganging Kit Hardware required when combining two or more V14 vanities	VFGKIT	\$ 99.
 Vanity Stacking Kits Hardware required for stacking two or more wall-hung vanities	VFSTACK	\$ 99.
 Legs (2) & hardware for stacking two or more wall-hung vanities	VFSTACKA	\$ 279.
 Legs (4) & hardware for stacking two or more wall-hung vanities	VFSTACKL	\$ 179.

See additional Accessories on pages 266 – 268.

SEE PAGES 88 – 89 FOR TIPS AND FEATURES.

V14® Vanity – VF60 – 60" W

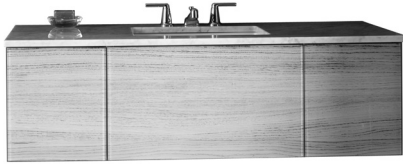

For those who want a simple floating vanity, the V14 Collection can be stacked vertically or ganged horizontally to create a unique layout with smartly designed storage space.

- Choice between slow-close and push-to-open drawers, both providing long-lasting effortless operation
- Provides task and way-finding light by using the night light option

2 Two Week Lead Time (Stock Colors)

4 Four Week Lead Time (Classic/Special Order Colors)

Modular

Electrical Outlet

Night Light

Vainities & Tops

60-1/4" W x 14" H x 21" D Vanity

		Stock Colors	Classic Colors	Special Order Colors	
		10, 11, 20, 21	22, 26, 27, 28	12, 19, 23, 24, 25	
		Price	Price	Price	
Three-Drawer – 36" W Plumbing Drawer for Center Mount Sink & two 12" W Side Drawers					
	Base Unit, Slow-Close Drawer	VF60PDCNSWM __	\$ 5,229.	\$ 6,879.	\$ 8,499.
	With 5000K Night Light, Slow-Close Drawer	VF60PDCLSWM __	\$ 5,829.	\$ 7,479.	\$ 9,099.
	Base Unit, Push-to-Open Drawer	VF60PDCNPWM __	\$ 5,229.	\$ 6,879.	\$ 8,499.
	With 5000K Night Light, Push-to-Open Drawer	VF60PDCLPWM __	\$ 5,829.	\$ 7,479.	\$ 9,099.

Vanity Color Options

Fill in __ designator to Model listed above with desired color. Example: VF60PDCNPWM20.

Stock Colors	Classic Colors	Special Order Colors
10 Mirror	22 Beach	12 Satin Bronze
11 Tinted Gray Mirror	26 Matte White	19 Satin White
20 Black	27 Matte Gray	23 Ocean
21 White	28 Matte Black	24 Smoke Screen
		25 Silver Screen

See Vanity Tops, Accessories & Options on the following page.

V14[®] Vanity – VF60 – 60" W

61" W x 22" D Vanity Tops – For 21" D Vanities

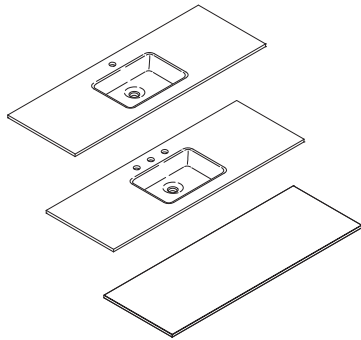

Description	For Use With Vanity	See Page
TF61UCO __ Engineered Stone Vanity Top	Plumbing Drawer	133
TF61G __ Engineered Stone Vanity Top (No Sink)	60" W Vanities	133

**Undercounter Sink available for Custom Countertop – see page 135.
See V14 Ganging Reference on pages 104 – 105.**

Accessories & Options



Description

Model

Price

Electric Accessory

For use in any drawer

VFELECTRIC

\$ 449.



Hair Styling Organizer

For use in plumbing (vessel only) or full storage drawer

VAHAIRORG

\$ 229.

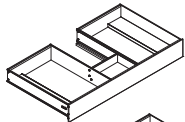

Slim Drawer Insert

For use in 36" W plumbing drawer

VFDRAWER36P

\$ 799.

Note: Not for use with plumbing drawer undercounter sink installations or with Robern's stone vanity tops.
Can be used in above-counter vessel installations.

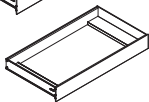

For use in 12" W accessory side drawer

VFDRAWER12X

\$ 499.



Vanity Accessory Toilet Paper Holder

Can be installed on either side of vanity

VATP

\$ 99.

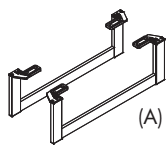

Vanity Ganging Kit

Hardware required when combining two or more V14 vanities

VFGKIT

\$ 99.

Vanity Stacking Kits

Hardware required for stacking two or more wall-hung vanities

VFSTACK

\$ 99.



Legs (2) & hardware for stacking two or more wall-hung vanities

VFSTACKA

\$ 279.



Legs (4) & hardware for stacking two or more wall-hung vanities

VFSTACKL

\$ 179.

See additional Accessories on pages 266 – 268.

SEE PAGES 88 – 89 FOR TIPS AND FEATURES.

V14® Ganging Reference

Refer to the following for V14 ganging/stacking examples:

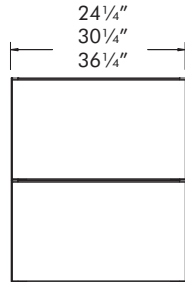

Stacking Wall-Hung
Required Hardware:
VFSTACK

Recommended installation height is 34½"; however, wall-hung vanities can be installed at varying heights. Please refer to instruction sheets for specific requirements.

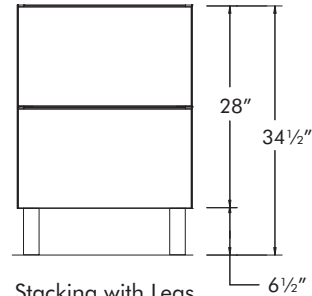

Stacking with Legs
Required Hardware:
VFSTACKA or VFSTACKL

The V14 Stacking Kits with Legs (VSTACKA/L) includes brushed aluminum legs which are 6½" H. The V14 Vanities are 14" H. The installed vanity height will be 34½" H. The specified counter and sink will impact the total height of the installation.

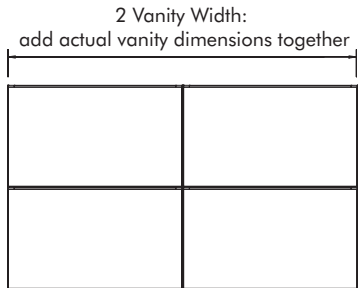

Stacking & Ganged
Wall-Hung
Required Hardware:
2 VFGKIT
2 VFSTACK

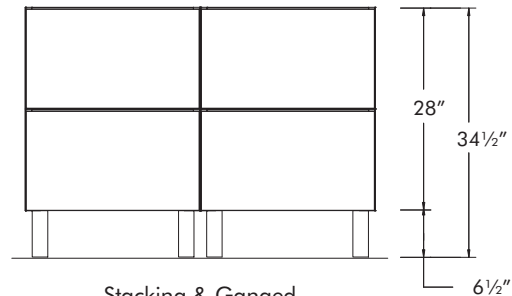

Stacking & Ganged
with Legs
Required Hardware:
2 VFGKIT
2 VFSTACKA or 2 VFSTACKL

It is recommended to use a Full Storage Drawer for the bottom of a 2-drawer stacked unit. The Full Drawers come with glass dividers to partition the drawer in a variety of ways and does not include plumbing clearance cutouts.

Total Width of vanity area should be a minimum of 48" W.

Example 1: Two 12" Wall-Hung Vanities

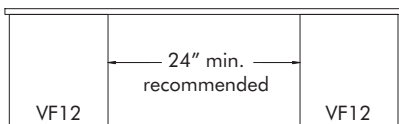

Example 1: Two 12" wide V14 vanities for a 48" wide Vanity Space:

- 12" wide V14 + 24" wide open space + 12" wide V14 vanity = 48" wide Vanity

Example 2: Two 24" Wall-Hung Vanities

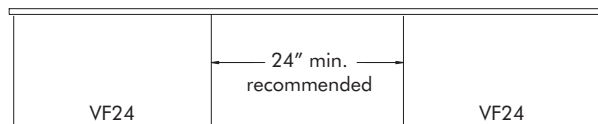

Example 2: Two 24" wide V14 vanities for a 72" wide Vanity Space:

- 24" wide V14 + 24" wide open space + 24" wide V14 vanity = 72" wide Vanity

Note: For 12" wide Vanities, side kits will need to be purchased for this installation. See page 93 for side kit information.

V14® Ganging Reference

V14 can be ganged together to form endless combinations and installations to meet a variety of needs:

To acquire the total width of the vanity, add actual vanity dimensions together.

Example 3: Dual Sink Installation
with Two Wall-Hung Vanities

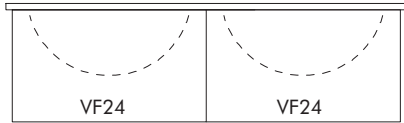

Example 4: Dual Sink Installation
with Three Wall-Hung Vanities



Example 3: To create a 48" Dual Sink installation:

- Two 24" wide V14: $24\frac{1}{4}" + 24\frac{1}{4}" = 48\frac{1}{2}"$

Example 4: To create a 60" wide Dual Sink Installation, three Vanities recommended:

- 24" wide V14 (left) + 12" wide V14 (center) + 24" wide V14 (right) = $24\frac{1}{4}" + 12\frac{1}{4}" + 24\frac{1}{4}" = 60\frac{3}{4}"$

It is recommended to use a Full Storage Drawer for the center drawer of a 3-drawer ganged vanity installation.

The Full Drawers come with glass dividers to partition the drawer in a variety of ways and does not include plumbing clearance cutouts.

Please refer to page 93 for 12" W accessory drawer options.

Cartesian® Vanities – Table of Contents, Tips & Features

Table of Contents

Cartesian Vanity Tips & Features	106 – 107
Cartesian Vanity Ganging Reference	108 – 110
Cartesian Vanity Model Number Worksheet	111
Cartesian Vanities	112 – 125
12" Wide Cartesian Vanity	112 – 113
24" Wide Cartesian Vanity	114 – 117
30" Wide Cartesian Vanity	118 – 121
36" Wide Cartesian Vanity	122 – 125
Vanity Tops	128 – 135
Cartesian Vanity Undermount Bowl Space Availability	136
Vanity Accessories	265 – 270

Tips & Features

Dimensions & Weight

- Width (with side kits installed):
12-1/8" (308 mm), 24-1/8" (613 mm),
30-1/8" (765 mm), 36-1/8" (918 mm)
- Height:
7-1/2" (191 mm), 15" (381 mm)
- Depth:
18-3/4" (476 mm), 21-3/4" (552 mm)
- Net Weight: 25 – 97 lbs

Features & Benefits

- Offered in limitless designs, these vanities are built to fit your preference and storage needs
- Modular vanities can be ganged or stacked to fit a variety of desired heights and widths (ganging kit required)
- Glass finish options: mirror, 12 decorative gloss and matte finishes
- Plumbing slow-close drawer allows clearance for drain; tip out drawer (H1) gives storage back by providing a drawer for smaller items and full slow-close drawer allows optimal storage solutions
- Uniquely designed handleless ergonomic drawer, allows for a comfortable feel and effortless operation
- H1 (7-1/2") vanities include five glass bins for plumbing drawers and four glass bins for full drawers; H2 (15") vanities include one glass bin with plumbing drawers

Features & Benefits (Continued)

- Organization kit for H2 (15" H): two fully adjustable glass drawer dividers provide storage right where you need it and prevent items from moving and sliding in the drawer
- Night Light Option – integrated LED night light with light bar built into top frame of each drawer, provides soft light to illuminate drawer interior and for wayfinding light in either selectable 2700 Kelvin/4000 Kelvin or 5000 Kelvin. Night light is ETL certified to UL 2108, CSA Standard C22.2 No. 12
- Electric accessory option: three plugs and a switch that turns off power to the unit to keep appliances safely plugged in

Configurable Options

- Decorative Glass Options:
mirror, 12 decorative gloss and matte colors
- Night Light:
No Night Light or Integrated LED Night Light in selectable 2700 Kelvin/4000 Kelvin or 5000 Kelvin
- Drawer Application:
Choice of split plumbing (not available for 12" W drawer), full drawer or tip out drawer (7-1/2" H only, not available for 12" W drawer)



Stock Colors



Classic and Special Order Colors

Cartesian® Vanities – Tips & Features

Tips & Features (Continued)

Construction

- Durable rust-free anodized aluminum and glass construction – glass resists intense moisture, ensuring long-lasting beauty
- Slow-close full-extension slides combined with the durability of aluminum construction ensure smooth operation of the vanity drawers that will last a lifetime
- Constructed for wall hanging loads with stone tops
- Glass fronts and side kits are replaceable
- White shatter-protected glass drawer bottoms will not degrade or show wear. Glass dissipates heat to ensure confidence that hot items will not leave heat marks on the bottom of the drawers

Installation

- This installation may require more than one person
- Includes installation hardware and structural bolts
- Special site preparation is required. Wall bracing and Robern supplied hardware are recommended
- The plumbing must be roughed into the plumbing cutout area of the vanity. Refer to the sink rough-in and the vanity rough-in for proper placement. The water supply and drain lines must be installed before installing the vanity
- Components needed for stacking are included with each vanity
- Within a column, all vanities must stay the same width. Ganging kit required for each column connection point and is selected based on the connection height of the cabinets. Each ganging kit is by 7-1/2" increments (H1 = 7-1/2", H2 = 15", H3 = 22-1/2", H4 = 30").
- Side kits are sold separately to allow for customization and are available individually or as pairs. You must choose one side kit or alcove kit for every exposed side.
- With a 7-1/2" H vanity, a tip out drawer must be used with an undercounter sink
- If stacking with a 7-1/2" tip out drawer, the second vanity must be a 7-1/2" plumbing drawer, a 15" plumbing drawer or a 15" full drawer as the first 15" needs plumbing clearance. If using 7-1/2" tip out for undercounter sink installation, slim plumbing drawer insert can be used with a 15" H plumbing drawer and still clear pipes.
- Full drawer units are intended for ganging and stacking and are not designed to accept a sink or plumbing.
- Night light option (S) – 12VDC plug-in transformer. Option of two color temperatures for one night light: 2700 or 4000 Kelvin. The vanity is preconfigured at 2700K. Night light can be reconfigured to 4000K at time of installation. See installation instructions for more information.

Installation (Continued)

- Night light option (L) – 12VDC plug-in transformer in 5000 Kelvin color temperature. Locate wall outlet as per installation instructions.
- Electric Accessory option: 120VAC 20A tamper resistant outlet. Installed within 15" H (H2) vanity drawer; not recommended to be used in combination with Slim Drawer Insert; recommended in combination with Hair Styling Organizer
- Slim plumbing drawer insert must be used with an above-counter sink installation; full drawer version can be used in a full drawer - includes four glass bins and only available for 15" H (H2) vanities
- Hair Styling Organizer fits all 15" H (H2) vanity drawers except 24" plumbing drawer; cannot be used in combination with slim drawer insert; recommended in combination with Electric Accessory

Accessories

- In-drawer Electric Accessory (VAELECTRIC18, VAELECTRIC21): ETL certified to UL 1363, CSA Standard C22.2 No. 21 – 15" H only
- Accessory Night Light in selectable 2700 Kelvin/4000 Kelvin (SLEDS12, SLEDS24, SLEDS30, SLEDS36) and 5000 Kelvin (CLEDS12, CLEDS24, CLEDS30, CLEDS36): Night light is ETL certified to UL 2108, CSA Standard C22.2 No. 12
- Slim Plumbing Drawer Insert with five glass bins (VADRAWER24P, VADRAWER30P, VADRAWER36P) – 15" H only
- Slim Full Drawer Insert with four glass bins (VADRAWER12X, VADRAWER24X, VADRAWER30X, VADRAWER36X) – 15" H only
- Glass Bins: divided storage (GLASSBIN6.38), small (GLASSBIN3.25), medium (GLASSBIN5.25), large (GLASSBIN8.5)
- Hair Styling Organizer (VAHAIRORG): fits most hair dryers and curling irons – to be used in 15" H (H2) vanity drawers only
- Glass and engineered stone tops with porcelain sink
- Glass side kits sold separately as single units or as a pair. Available in 4 heights and 2 depths, and based on the final configuration of the vanity (7-1/2", 15", 22-1/2", 30").
- Ganging kits are required when combining two or more vanities and are available in 4 heights and based on the final configuration of the vanity (7-1/2", 15", 22-1/2", 30")
- Alcove finishing kits are required for corner or alcove installations and are available in 4 heights and based on the final configuration of the vanity (7-1/2", 15", 22-1/2", 30")



Stock Colors



Classic and Special Order Colors

Cartesian® Ganging Reference

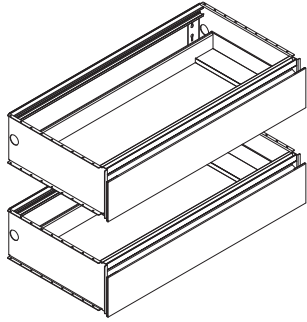

(2) VM36H1D18P ---

+

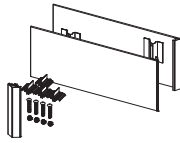

(1) VMGKITH1
(1) VM2SKH1D18- ---

=

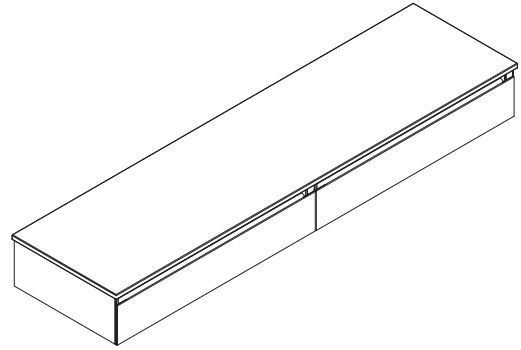

(1) TE73G --

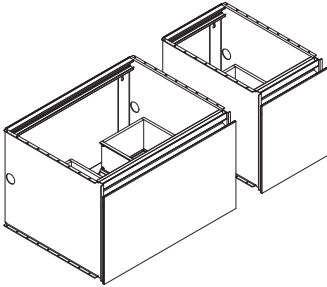

(1) VM24H2D18P ---
(1) VM12H2D18F ---

+

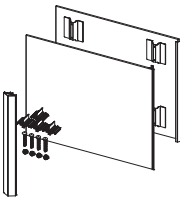

(1) VMGKITH2
(1) VM2SKH2D18- ---

=

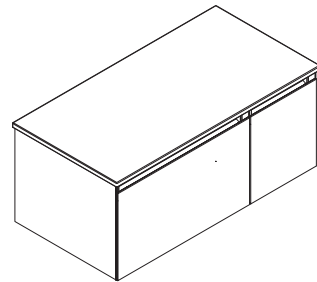

(1) TE37G --

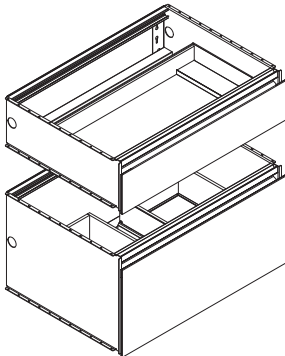

(1) VM30H1D21F ---
(1) VM30H2D21F ---

+

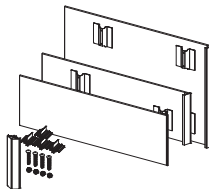

(1) VMGKITH1
(1) VM2SKH1D21- ---
(1) VM1SKH2D21- ---

=

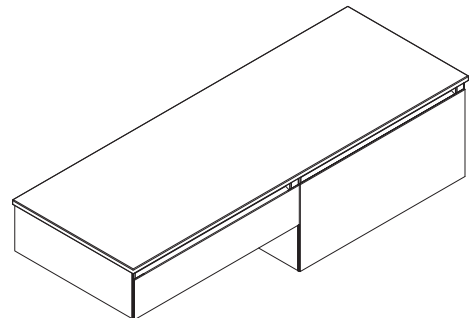

(1) TF61G --

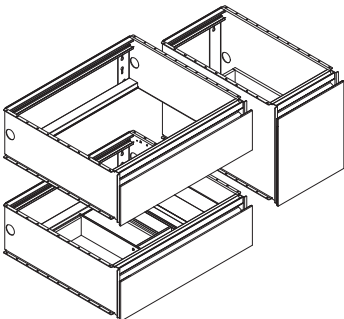

(1) VM24H1D21T ---
(1) VM24H1D21P ---
(1) VM12H2D21F ---

+

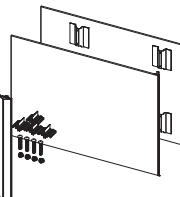

(1) VMGKITH2
(1) VM2SKH2D21- ---

=

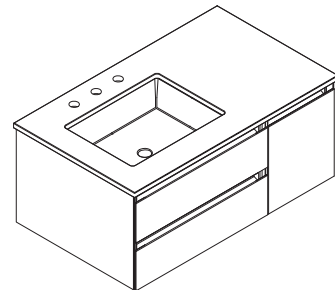

(1) TF37ULO __ -8

Cartesian® Ganging Reference

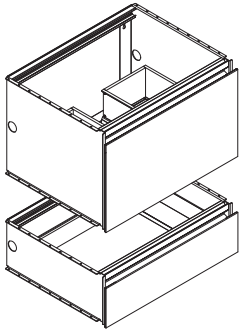

(1) VM24H2D21P ---
 (1) VM24H1D21F ---

+

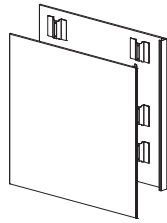

(1) VM2SKH3D21- ---

=

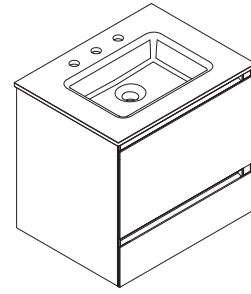

(1) TS25UCN21-8

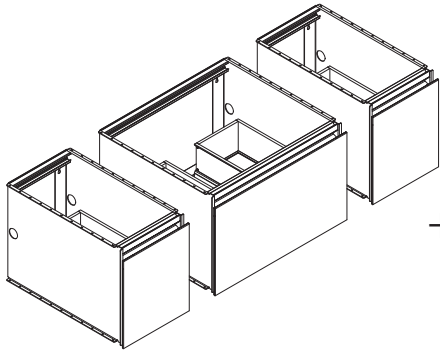

(1) VM24H2D21P ---
 (2) VM12H2D21F ---

+

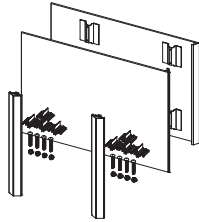

(1) VM2SKH2D21- ---
 (2) VMGKITH2

=

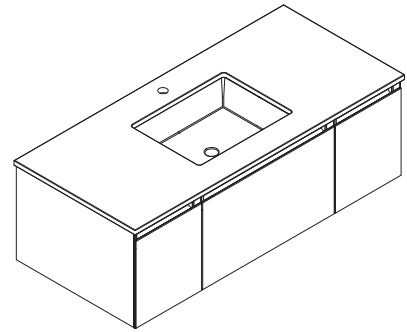

(1) TS49UCO ___ -1

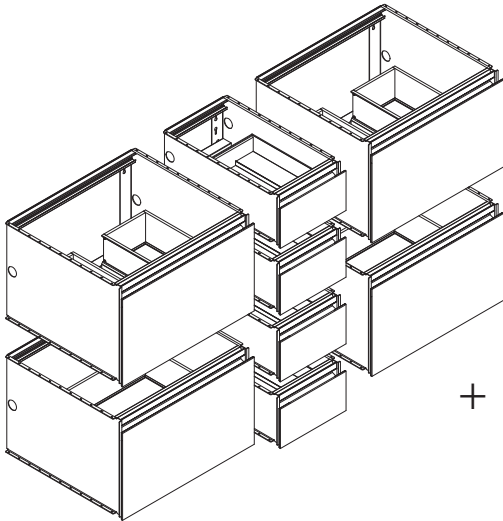

(2) VM24H2D21P ---
 (2) VM24H2D21F ---
 (4) VM12H1D21F ---

+

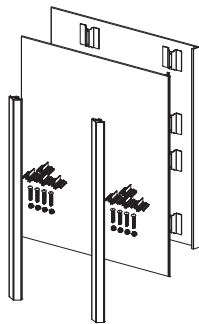

(1) VM2SKH4D21- ---
 (2) VMGKITH4

=

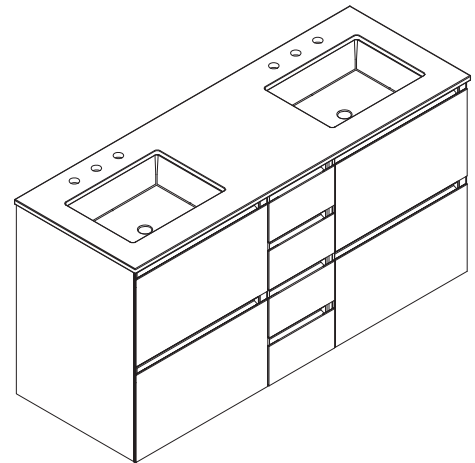

(1) TF61UDO ___ - 8D4

Example 1: Two 12" Wall-Hung Vanities

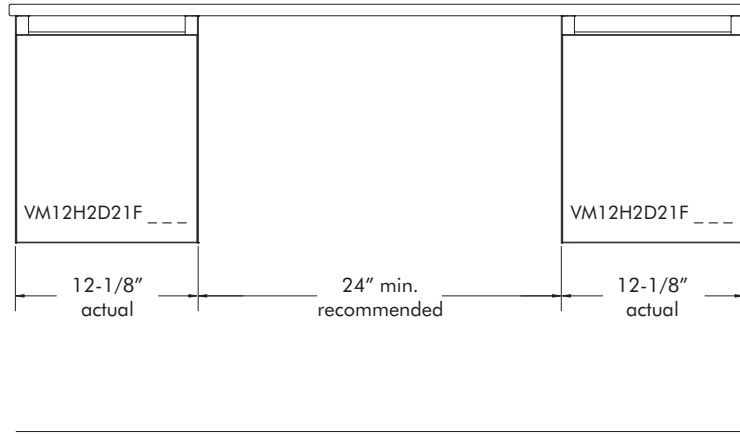

Example 1: Two 12" wide Cartesian vanities for a 48" wide vanity space:

- 12" wide VM + 24" wide space + 12" wide VM = 48" wide vanity space (48-1/4" actual width)

Example 2: Three 24" Wall-Hung Vanities

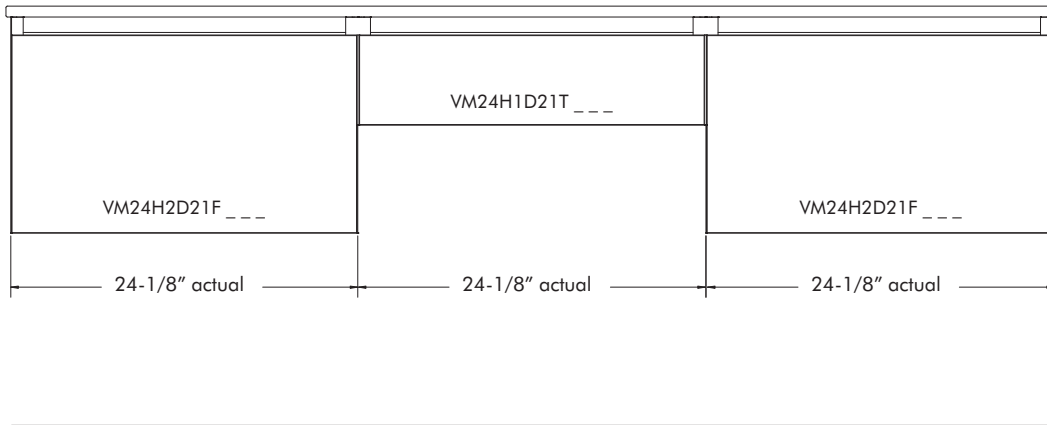

Example 2: Three 24" wide Cartesian vanities for a 72" wide vanity space:

- 24" wide VM + 24" wide VM + 24" wide VM = 72" wide vanity space (72-3/8" actual width)

Cartesian® Vanity Model Number Worksheet

FEATURES

MODEL

VM

Select Width:

12"

12

24"

24

30"

30

36"

36

Select Height:

7-1/2"

H1

15"

H2

Select Depth:

18"

D18

21"

D21

Select Drawer Style:

Plumbing

P

Full

F

Tip Out*

T

Select Color:

Stock Colors**

Mirror

10

Tinted Gray Mirror

11

Black

20

White

21

Classic Colors**

Beach

22

Matte White

26

Matte Gray

27

Matte Black

28

Special Order Colors**

Satin Bronze

12

Satin White

19

Ocean

23

Smoke Screen

24

Silver Screen

25

Select Option:

Base Unit (No Night Light)

N

Selectable Night Light, 2700K/4000K

S

Night Light, 5000K

L

Notes:

* Tip Out Drawer only available for 7-1/2" height.

** Stock Colors have a 2 week lead time;
all other Colors have a 4 week lead time.

CUSTOMER INFORMATION

Name

Address

City/State/Zip

Telephone

Date Ordered

Cartesian® Vanity – VM12 – 12" W x 18" or 21" D



For those who want to create a personalized configuration, the Cartesian Vanity offers limitless solutions and unique designs to fit your preferences, storage needs and the demands of your space.

- Customize around your own needs. Modular design allows you to add or upgrade your existing vanity or night stand and add new features to infinitely expand the functionality
- Withstands wet and damp environments with aluminum and glass construction
- Provides task and way-finding light by using the night light option

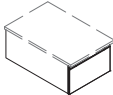

Vanities & Tops

12-1/8" W x 18-3/4" D Vanity		Stock Colors	Classic Colors	Special Order Colors
Description	Model	10, 11, 20, 21 Price	22, 26, 27, 28 Price	12, 19, 23, 24, 25 Price
7-1/2" H x 18-3/4" D Vanity – Full Drawer, No Sink				
 Base Unit	VM12H1D18F__N	\$ 499.	\$ 929.	\$ 1,349.
With 2700K/4000K Night Light	VM12H1D18F__S	\$ 749.	\$ 1,199.	\$ 1,629.
With 5000K Night Light	VM12H1D18F__L	\$ 749.	\$ 1,199.	\$ 1,629.

15" H x 18-3/4" D Vanity – Full Drawer, No Sink				
 Base Unit	VM12H2D18F__N	\$ 699.	\$ 1,149.	\$ 1,579.
With 2700K/4000K Night Light	VM12H2D18F__S	\$ 979.	\$ 1,429.	\$ 1,849.
With 5000K Night Light	VM12H2D18F__L	\$ 979.	\$ 1,429.	\$ 1,849.

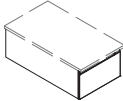
12-1/8" W x 21-3/4" D Vanity		Stock Colors	Classic Colors	Special Order Colors
Description	Model	10, 11, 20, 21 Price	22, 26, 27, 28 Price	12, 19, 23, 24, 25 Price
7-1/2" H x 21-3/4" D Vanity – Full Drawer, No Sink				
 Base Unit	VM12H1D21F__N	\$ 499.	\$ 929.	\$ 1,349.
With 2700K/4000K Night Light	VM12H1D21F__S	\$ 749.	\$ 1,199.	\$ 1,629.
With 5000K Night Light	VM12H1D21F__L	\$ 749.	\$ 1,199.	\$ 1,629.

15" H x 21-3/4" D Vanity – Full Drawer, No Sink				
 Base Unit	VM12H2D21F__N	\$ 699.	\$ 1,149.	\$ 1,579.
With 2700K/4000K Night Light	VM12H2D21F__S	\$ 979.	\$ 1,429.	\$ 1,849.
With 5000K Night Light	VM12H2D21F__L	\$ 979.	\$ 1,429.	\$ 1,849.

Vanity Color Options

Fill in __ designator to Model listed above with desired color. Example: VM12H1D21F19N.

Stock Colors

- 10 Mirror
- 11 Tinted Gray Mirror
- 20 Black
- 21 White

Classic Colors

- 22 Beach
- 26 Matte White
- 27 Matte Gray
- 28 Matte Black

Special Order Colors

- 12 Satin Bronze
- 19 Satin White
- 23 Ocean
- 24 Smoke Screen
- 25 Silver Screen

See Vanity Tops, Accessories & Options on the following page.

Cartesian® Vanity – VM12 – 12" W x 18" or 21" D

13" W x 19" D & 13" W x 22" D Vanity Tops

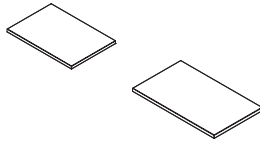

Description	For Use With Vanity	See Page
TE13G _ _ Engineered Stone Vanity Top (No Sink)	18" D, 12" W Vanities	128
TF13G _ _ Engineered Stone Vanity Top (No Sink)	21" D, 12" W Vanities	128

See Cartesian Ganging Reference on pages 108 – 110.

Accessories & Options

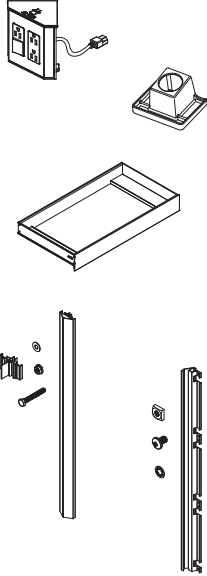

Description	Model	Price
Electric Accessory		
For use in 18" D drawer	VAELECTRIC18	\$ 449.
For use in 21" D drawer	VAELECTRIC21	\$ 449.
Hair Styling Organizer		
For use in 15" H drawer (H2)	VAHAIRORG	\$ 229.
Slim Drawer Insert		
For use in 15" H drawer (H2)	VADRAWER12X	\$ 499.
Vanity Ganging Kit – Hardware required when combining two or more vanities		
7-1/2" H	VMGKITH1	\$ 99.
15" H	VMGKITH2	\$ 99.
22-1/2" H	VMGKITH3	\$ 229.
30" H	VMGKITH4	\$ 229.
Vanity Alcove Finishing Kit – Hardware required for corner or alcove installations		
7-1/2" H	VMAKITH1	\$ 99.
15" H	VMAKITH2	\$ 99.
22-1/2" H	VMAKITH3	\$ 229.
30" H	VMAKITH4	\$ 229.

See additional Accessories on pages 266 – 268.

Vanity Side Kits

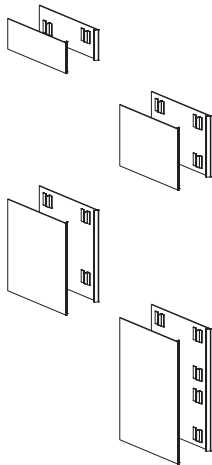

Description	Model	Stock Colors	Classic Colors	Special Order Colors
Vanity Side Kits – Includes glass panel(s) & hardware (see Color Options on previous page)				
Single, 7-1/2" H, 18" D	VM1SKH1D18- _ _	\$ 229.	\$ 279.	\$ 329.
Single, 7-1/2" H, 21" D	VM1SKH1D21- _ _	\$ 229.	\$ 279.	\$ 329.
Pair, 7-1/2" H, 18" D	VM2SKH1D18- _ _	\$ 329.	\$ 449.	\$ 549.
Pair, 7-1/2" H, 21" D	VM2SKH1D21- _ _	\$ 329.	\$ 449.	\$ 549.
Single, 15" H, 18" D	VM1SKH2D18- _ _	\$ 279.	\$ 329.	\$ 399.
Single, 15" H, 21" D	VM1SKH2D21- _ _	\$ 279.	\$ 329.	\$ 399.
Pair, 15" H, 18" D	VM2SKH2D18- _ _	\$ 399.	\$ 499.	\$ 629.
Pair, 15" H, 21" D	VM2SKH2D21- _ _	\$ 399.	\$ 499.	\$ 629.
Single, 22-1/2" H, 18" D	VM1SKH3D18- _ _	\$ 329.	\$ 399.	\$ 449.
Single, 22-1/2" H, 21" D	VM1SKH3D21- _ _	\$ 329.	\$ 399.	\$ 449.
Pair, 22-1/2" H, 18" D	VM2SKH3D18- _ _	\$ 549.	\$ 679.	\$ 799.
Pair, 22-1/2" H, 21" D	VM2SKH3D21- _ _	\$ 549.	\$ 679.	\$ 799.
Single, 30" H, 18" D	VM1SKH4D18- _ _	\$ 399.	\$ 449.	\$ 499.
Single, 30" H, 21" D	VM1SKH4D21- _ _	\$ 399.	\$ 449.	\$ 499.
Pair, 30" H, 18" D	VM2SKH4D18- _ _	\$ 679.	\$ 799.	\$ 899.
Pair, 30" H, 21" D	VM2SKH4D21- _ _	\$ 679.	\$ 799.	\$ 899.

Note: You must choose one side kit or alcove kit for every exposed side.

SEE PAGES 106 – 107 FOR TIPS AND FEATURES.

Cartesian® Vanity – VM24 – 24" W x 18" D



For those who want to create a personalized configuration, the Cartesian Vanity offers limitless solutions and unique designs to fit your preferences, storage needs and the demands of your space.

- Customize around your own needs. Modular design allows you to add or upgrade your existing vanity or night stand and add new features to infinitely expand the functionality
- Withstands wet and damp environments with aluminum and glass construction
- Provides task and way-finding light by using the night light option



Two Week Lead Time
(Stock Colors)



Four Week Lead Time
(Classic/Special Order Colors)



Modular



Electrical
Outlet



Night
Light

24-1/8" W x 18-3/4" D Vanity

Description		Model	Stock Colors 10, 11, 20, 21 Price	Classic Colors 22, 26, 27, 28 Price	Special Order Colors 12, 19, 23, 24, 25 Price
7-1/2" H Vanity – Plumbing Drawer, No Undercounter Sink					
	Base Unit	VM24H1D18P__N	\$ 1,029.	\$ 1,479.	\$ 1,899.
	With 2700K/4000K Night Light	VM24H1D18P__S	\$ 1,349.	\$ 1,799.	\$ 2,229.
	With 5000K Night Light	VM24H1D18P__L	\$ 1,349.	\$ 1,799.	\$ 2,229.
7-1/2" H Vanity – Full Drawer, No Sink					
	Base Unit	VM24H1D18F__N	\$ 1,029.	\$ 1,479.	\$ 1,899.
	With 2700K/4000K Night Light	VM24H1D18F__S	\$ 1,349.	\$ 1,799.	\$ 2,229.
	With 5000K Night Light	VM24H1D18F__L	\$ 1,349.	\$ 1,799.	\$ 2,229.
7-1/2" H Vanity – Tip Out Drawer					
	Base Unit	VM24H1D18T__N	\$ 1,029.	\$ 1,479.	\$ 1,899.
	With 2700K/4000K Night Light	VM24H1D18T__S	\$ 1,349.	\$ 1,799.	\$ 2,229.
	With 5000K Night Light	VM24H1D18T__L	\$ 1,349.	\$ 1,799.	\$ 2,229.
15" H Vanity – Plumbing Drawer					
	Base Unit	VM24H2D18P__N	\$ 1,249.	\$ 1,679.	\$ 2,129.
	With 2700K/4000K Night Light	VM24H2D18P__S	\$ 1,579.	\$ 2,029.	\$ 2,449.
	With 5000K Night Light	VM24H2D18P__L	\$ 1,579.	\$ 2,029.	\$ 2,449.
15" H Vanity – Full Drawer, No Sink					
	Base Unit	VM24H2D18F__N	\$ 1,249.	\$ 1,679.	\$ 2,129.
	With 2700K/4000K Night Light	VM24H2D18F__S	\$ 1,579.	\$ 2,029.	\$ 2,449.
	With 5000K Night Light	VM24H2D18F__L	\$ 1,579.	\$ 2,029.	\$ 2,449.

Vanity Color Options

Fill in __ designator to Model listed above with desired color. Example: VM24H2D18P28N.

Stock Colors

- 10 Mirror
- 11 Tinted Gray Mirror
- 20 Black
- 21 White

Classic Colors

- 22 Beach
- 26 Matte White
- 27 Matte Gray
- 28 Matte Black

Special Order Colors

- 12 Satin Bronze
- 19 Satin White
- 23 Ocean
- 24 Smoke Screen
- 25 Silver Screen

See Vanity Tops, Accessories & Options on the following page.

Cartesian® Vanity – VM24 – 24" W x 18" D

25" W x 19" D Vanity Tops – For 18" D Vanities

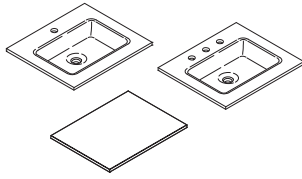

Description	For Use With Vanity	See Page
TC25UCN __ Glass Vanity Top	Plumbing & Tip Out Drawer	128
TE25G __ Engineered Stone Vanity Top (No Sink)	24" W Vanities	128

**Undercounter Sink available for Custom Countertop – see page 135.
See Cartesian Ganging Reference on pages 108 – 110.**

Accessories & Options

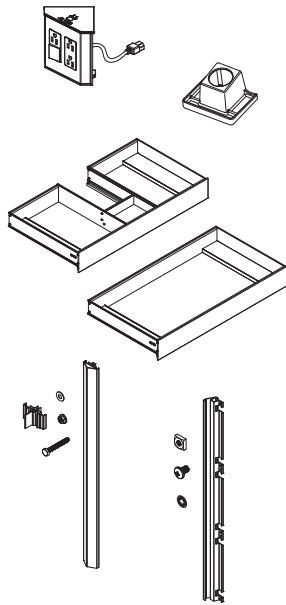

Description	Model	Price
Electric Accessory		
For use in 15" H plumbing or full drawer (H2)	VAELECTRIC18	\$ 449.
Hair Styling Organizer		
For use in 15" H full drawer (H2)	VAHAIRORG	\$ 229.
Slim Drawer Insert		
For use in 15" H plumbing drawer (H2)	VADRAWER24P	\$ 629.
For use in 15" H full drawer (H2)	VADRAWER24X	\$ 629.
Note: Not for use with plumbing drawer undercounter sink installations or with Robern's stone vanity tops. Can be used in above-counter vessel installations.		
Vanity Ganging Kit – Hardware required when combining two or more vanities		
7-1/2" H	VMGKITH1	\$ 99.
15" H	VMGKITH2	\$ 99.
22-1/2" H	VMGKITH3	\$ 229.
30" H	VMGKITH4	\$ 229.
Vanity Alcove Finishing Kit – Hardware required for corner or alcove installations		
7-1/2" H	VMAKITH1	\$ 99.
15" H	VMAKITH2	\$ 99.
22-1/2" H	VMAKITH3	\$ 229.
30" H	VMAKITH4	\$ 229.

See additional Accessories on pages 266 – 268.

Vanity Side Kits

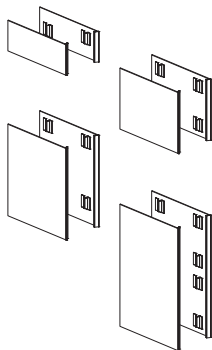

Description	Model	Stock Colors	Classic Colors	Special Order Colors
Vanity Side Kits – Includes glass panel(s) & hardware (see Color Options on previous page)				
Single, 7-1/2" H, 18" D	VM1SKH1D18-__	\$ 229.	\$ 279.	\$ 329.
Pair, 7-1/2" H, 18" D	VM2SKH1D18-__	\$ 329.	\$ 449.	\$ 549.
Single, 15" H, 18" D	VM1SKH2D18-__	\$ 279.	\$ 329.	\$ 399.
Pair, 15" H, 18" D	VM2SKH2D18-__	\$ 399.	\$ 499.	\$ 629.
Single, 22-1/2" H, 18" D	VM1SKH3D18-__	\$ 329.	\$ 399.	\$ 449.
Pair, 22-1/2" H, 18" D	VM2SKH3D18-__	\$ 549.	\$ 679.	\$ 799.
Single, 30" H, 18" D	VM1SKH4D18-__	\$ 399.	\$ 449.	\$ 499.
Pair, 30" H, 18" D	VM2SKH4D18-__	\$ 679.	\$ 799.	\$ 899.

Note: You must choose one side kit or alcove kit for every exposed side.

SEE PAGES 106 – 107 FOR TIPS AND FEATURES.

Cartesian® Vanity – VM24 – 24" W x 21" D



For those who want to create a personalized configuration, the Cartesian Vanity offers limitless solutions and unique designs to fit your preferences, storage needs and the demands of your space.

- Customize around your own needs. Modular design allows you to add or upgrade your existing vanity or night stand and add new features to infinitely expand the functionality
- Withstands wet and damp environments with aluminum and glass construction
- Provides task and way-finding light by using the night light option



Two Week Lead Time
(Stock Colors)



Four Week Lead Time
(Classic/Special Order Colors)



Modular



Electrical
Outlet



Night
Light

24-1/8" W x 21-3/4" D Vanity

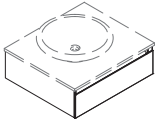
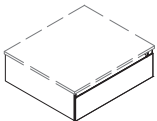
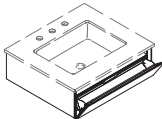
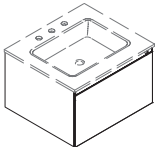
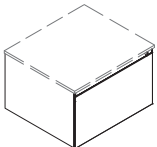
Description		Model	Stock Colors 10, 11, 20, 21 Price	Classic Colors 22, 26, 27, 28 Price	Special Order Colors 12, 19, 23, 24, 25 Price
7-1/2" H Vanity – Plumbing Drawer, No Undercounter Sink					
	Base Unit	VM24H1D21P__N	\$ 1,029.	\$ 1,479.	\$ 1,899.
	With 2700K/4000K Night Light	VM24H1D21P__S	\$ 1,349.	\$ 1,799.	\$ 2,229.
	With 5000K Night Light	VM24H1D21P__L	\$ 1,349.	\$ 1,799.	\$ 2,229.
7-1/2" H Vanity – Full Drawer, No Sink					
	Base Unit	VM24H1D21F__N	\$ 1,029.	\$ 1,479.	\$ 1,899.
	With 2700K/4000K Night Light	VM24H1D21F__S	\$ 1,349.	\$ 1,799.	\$ 2,229.
	With 5000K Night Light	VM24H1D21F__L	\$ 1,349.	\$ 1,799.	\$ 2,229.
7-1/2" H Vanity – Tip Out Drawer					
	Base Unit	VM24H1D21T__N	\$ 1,029.	\$ 1,479.	\$ 1,899.
	With 2700K/4000K Night Light	VM24H1D21T__S	\$ 1,349.	\$ 1,799.	\$ 2,229.
	With 5000K Night Light	VM24H1D21T__L	\$ 1,349.	\$ 1,799.	\$ 2,229.
15" H Vanity – Plumbing Drawer					
	Base Unit	VM24H2D21P__N	\$ 1,249.	\$ 1,679.	\$ 2,129.
	With 2700K/4000K Night Light	VM24H2D21P__S	\$ 1,579.	\$ 2,029.	\$ 2,449.
	With 5000K Night Light	VM24H2D21P__L	\$ 1,579.	\$ 2,029.	\$ 2,449.
15" H Vanity – Full Drawer, No Sink					
	Base Unit	VM24H2D21F__N	\$ 1,249.	\$ 1,679.	\$ 2,129.
	With 2700K/4000K Night Light	VM24H2D21F__S	\$ 1,579.	\$ 2,029.	\$ 2,449.
	With 5000K Night Light	VM24H2D21F__L	\$ 1,579.	\$ 2,029.	\$ 2,449.

Vanity Color Options

Fill in __ designator to Model listed above with desired color. Example: VM24H2D21P28N.

Stock Colors

- 10 Mirror
- 11 Tinted Gray Mirror
- 20 Black
- 21 White

Classic Colors

- 22 Beach
- 26 Matte White
- 27 Matte Gray
- 28 Matte Black

Special Order Colors

- 12 Satin Bronze
- 19 Satin White
- 23 Ocean
- 24 Smoke Screen
- 25 Silver Screen

See Vanity Tops, Accessories & Options on the following page.

Cartesian® Vanity – VM24 – 24" W x 21" D

25" W x 22" D Vanity Tops – For 21" D Vanities

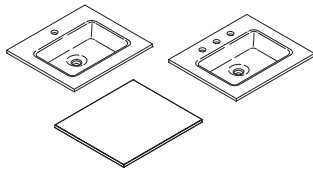

Description	For Use With Vanity	See Page
TS25UCN __ Glass Vanity Top	Plumbing & Tip Out Drawer	128
TF25UCO __ Engineered Stone Vanity Top	Plumbing & Tip Out Drawer	128
TF25G __ Engineered Stone Vanity Top (No Sink)	24" W Vanities	128

**Undercounter Sink available for Custom Countertop – see page 135.
See Cartesian Ganging Reference on pages 108 – 110.**

Accessories & Options

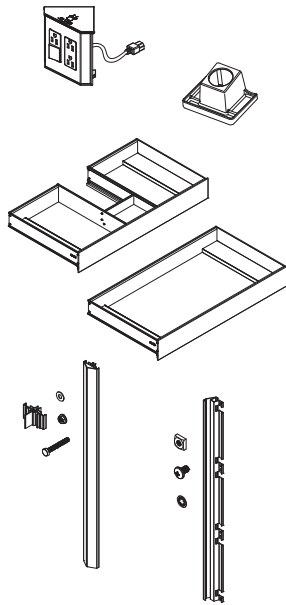

Description	Model	Price
Electric Accessory		
For use in 15" H plumbing or full drawer (H2)	VAELECTRIC21	\$ 449.
Hair Styling Organizer		
For use in 15" H full drawer (H2)	VAHAIRORG	\$ 229.
Slim Drawer Insert		
For use in 15" H plumbing drawer (H2)	VADRAWER24P	\$ 629.
For use in 15" H full drawer (H2)	VADRAWER24X	\$ 629.
Note: Not for use with plumbing drawer undercounter sink installations or with Robern's stone vanity tops. Can be used in above-counter vessel installations.		
Vanity Ganging Kit – Hardware required when combining two or more vanities		
7-1/2" H	VMGKITH1	\$ 99.
15" H	VMGKITH2	\$ 99.
22-1/2" H	VMGKITH3	\$ 229.
30" H	VMGKITH4	\$ 229.
Vanity Alcove Finishing Kit – Hardware required for corner or alcove installations		
7-1/2" H	VMAKITH1	\$ 99.
15" H	VMAKITH2	\$ 99.
22-1/2" H	VMAKITH3	\$ 229.
30" H	VMAKITH4	\$ 229.

See additional Accessories on pages 266 – 268.

Vanity Side Kits

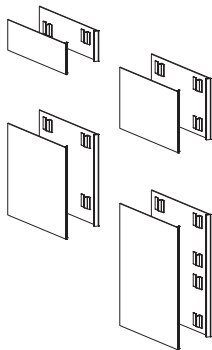

Description	Model	Stock Colors	Classic Colors	Special Order Colors
Vanity Side Kits – Includes glass panel(s) & hardware (see Color Options on previous page)				
Single, 7-1/2" H, 21" D	VM1SKH1D21- __	\$ 229.	\$ 279.	\$ 329.
Pair, 7-1/2" H, 21" D	VM2SKH1D21- __	\$ 329.	\$ 449.	\$ 549.
Single, 15" H, 21" D	VM1SKH2D21- __	\$ 279.	\$ 329.	\$ 399.
Pair, 15" H, 21" D	VM2SKH2D21- __	\$ 399.	\$ 499.	\$ 629.
Single, 22-1/2" H, 21" D	VM1SKH3D21- __	\$ 329.	\$ 399.	\$ 449.
Pair, 22-1/2" H, 21" D	VM2SKH3D21- __	\$ 549.	\$ 679.	\$ 799.
Single, 30" H, 21" D	VM1SKH4D21- __	\$ 399.	\$ 449.	\$ 499.
Pair, 30" H, 21" D	VM2SKH4D21- __	\$ 679.	\$ 799.	\$ 899.

Note: You must choose one side kit or alcove kit for every exposed side.

SEE PAGES 106 – 107 FOR TIPS AND FEATURES.

Cartesian® Vanity – VM30 – 30" W x 18" D



For those who want to create a personalized configuration, the Cartesian Vanity offers limitless solutions and unique designs to fit your preferences, storage needs and the demands of your space.

- Customize around your own needs. Modular design allows you to add or upgrade your existing vanity or night stand and add new features to infinitely expand the functionality
- Withstands wet and damp environments with aluminum and glass construction
- Provides task and way-finding light by using the night light option



Two Week Lead Time
(Stock Colors)



Four Week Lead Time
(Classic/Special Order Colors)



Modular



Electrical
Outlet



Night
Light

30-1/8" W x 18-3/4" D Vanity

Description		Model	Stock Colors 10, 11, 20, 21 Price	Classic Colors 22, 26, 27, 28 Price	Special Order Colors 12, 19, 23, 24, 25 Price
7-1/2" H Vanity – Plumbing Drawer, No Undercounter Sink					
	Base Unit	VM30H1D18P__N	\$ 1,579.	\$ 2,029.	\$ 2,449.
	With 2700K/4000K Night Light	VM30H1D18P__S	\$ 1,949.	\$ 2,399.	\$ 2,829.
	With 5000K Night Light	VM30H1D18P__L	\$ 1,949.	\$ 2,399.	\$ 2,829.
7-1/2" H Vanity – Full Drawer, No Sink					
	Base Unit	VM30H1D18F__N	\$ 1,579.	\$ 2,029.	\$ 2,449.
	With 2700K/4000K Night Light	VM30H1D18F__S	\$ 1,949.	\$ 2,399.	\$ 2,829.
	With 5000K Night Light	VM30H1D18F__L	\$ 1,949.	\$ 2,399.	\$ 2,829.
7-1/2" H Vanity – Tip Out Drawer					
	Base Unit	VM30H1D18T__N	\$ 1,579.	\$ 2,029.	\$ 2,449.
	With 2700K/4000K Night Light	VM30H1D18T__S	\$ 1,949.	\$ 2,399.	\$ 2,829.
	With 5000K Night Light	VM30H1D18T__L	\$ 1,949.	\$ 2,399.	\$ 2,829.
15" H Vanity – Plumbing Drawer					
	Base Unit	VM30H2D18P__N	\$ 1,799.	\$ 2,229.	\$ 2,679.
	With 2700K/4000K Night Light	VM30H2D18P__S	\$ 2,179.	\$ 2,629.	\$ 3,049.
	With 5000K Night Light	VM30H2D18P__L	\$ 2,179.	\$ 2,629.	\$ 3,049.
15" H Vanity – Full Drawer, No Sink					
	Base Unit	VM30H2D18F__N	\$ 1,799.	\$ 2,229.	\$ 2,679.
	With 2700K/4000K Night Light	VM30H2D18F__S	\$ 2,179.	\$ 2,629.	\$ 3,049.
	With 5000K Night Light	VM30H2D18F__L	\$ 2,179.	\$ 2,629.	\$ 3,049.

Vanity Color Options

Fill in __ designator to Model listed above with desired color. Example: VM30H1D18T20L.

Stock Colors

- 10 Mirror
- 11 Tinted Gray Mirror
- 20 Black
- 21 White

Classic Colors

- 22 Beach
- 26 Matte White
- 27 Matte Gray
- 28 Matte Black

Special Order Colors

- 12 Satin Bronze
- 19 Satin White
- 23 Ocean
- 24 Smoke Screen
- 25 Silver Screen

See Vanity Tops, Accessories & Options on the following page.

Cartesian® Vanity – VM30 – 30" W x 18" D

31" W x 19" D Vanity Tops – For 18" D Vanities

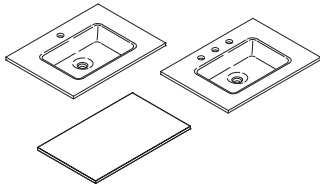

Description	For Use With Vanity	See Page
TC31UCN __ Glass Vanity Top	Plumbing & Tip Out Drawer	129
TE31G __ Engineered Stone Vanity Top (No Sink)	30" W Vanities	129

**Undercounter Sink available for Custom Countertop – see page 135.
See Cartesian Ganging Reference on pages 108 – 110.**

Accessories & Options

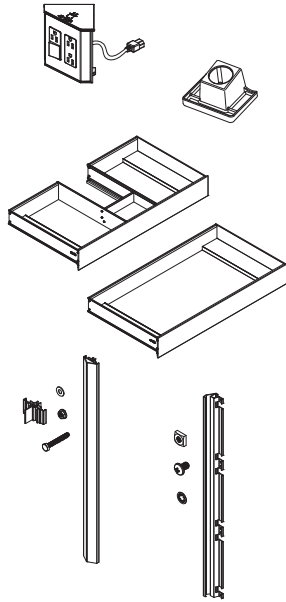

Description	Model	Price
Electric Accessory		
For use in 15" H plumbing or full drawer (H2)	VAELECTRIC18	\$ 449.
Hair Styling Organizer		
For use in 15" H plumbing (vessel only) or full drawer (H2)	VAHAIRORG	\$ 229.
Slim Drawer Insert		
For use in 15" H plumbing drawer (H2)	VADRAWER30P	\$ 729.
For use in 15" H full drawer (H2)	VADRAWER30X	\$ 729.
Note: Not for use with plumbing drawer undercounter sink installations or with Robern's stone vanity tops. Can be used in above-counter vessel installations.		
Vanity Ganging Kit – Hardware required when combining two or more vanities		
7-1/2" H	VMGKITH1	\$ 99.
15" H	VMGKITH2	\$ 99.
22-1/2" H	VMGKITH3	\$ 229.
30" H	VMGKITH4	\$ 229.
Vanity Alcove Finishing Kit – Hardware required for corner or alcove installations		
7-1/2" H	VMAKITH1	\$ 99.
15" H	VMAKITH2	\$ 99.
22-1/2" H	VMAKITH3	\$ 229.
30" H	VMAKITH4	\$ 229.

See additional Accessories on pages 266 – 268.

Vanity Side Kits

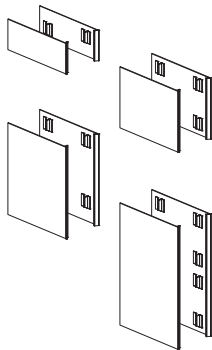

Description	Model	Stock Colors	Classic Colors	Special Order Colors
Vanity Side Kits – Includes glass panel(s) & hardware (see Color Options on previous page)				
Single, 7-1/2" H, 18" D	VM1SKH1D18-__	\$ 229.	\$ 279.	\$ 329.
Pair, 7-1/2" H, 18" D	VM2SKH1D18-__	\$ 329.	\$ 449.	\$ 549.
Single, 15" H, 18" D	VM1SKH2D18-__	\$ 279.	\$ 329.	\$ 399.
Pair, 15" H, 18" D	VM2SKH2D18-__	\$ 399.	\$ 499.	\$ 629.
Single, 22-1/2" H, 18" D	VM1SKH3D18-__	\$ 329.	\$ 399.	\$ 449.
Pair, 22-1/2" H, 18" D	VM2SKH3D18-__	\$ 549.	\$ 679.	\$ 799.
Single, 30" H, 18" D	VM1SKH4D18-__	\$ 399.	\$ 449.	\$ 499.
Pair, 30" H, 18" D	VM2SKH4D18-__	\$ 679.	\$ 799.	\$ 899.

Note: You must choose one side kit or alcove kit for every exposed side.

SEE PAGES 106 – 107 FOR TIPS AND FEATURES.

Cartesian® Vanity – VM30 – 30" W x 21" D



For those who want to create a personalized configuration, the Cartesian Vanity offers limitless solutions and unique designs to fit your preferences, storage needs and the demands of your space.

- Customize around your own needs. Modular design allows you to add or upgrade your existing vanity or night stand and add new features to infinitely expand the functionality
- Withstands wet and damp environments with aluminum and glass construction
- Provides task and way-finding light by using the night light option



Two Week Lead Time
(Stock Colors)



Four Week Lead Time
(Classic/Special Order Colors)



Modular



Electrical
Outlet



Night
Light

30-1/8" W x 21-3/4" D Vanity

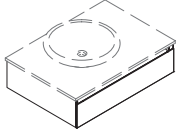
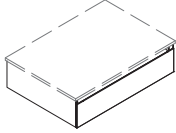
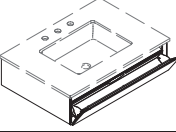
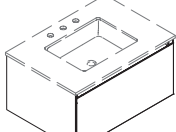
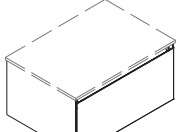
Description		Model	Stock Colors 10, 11, 20, 21 Price	Classic Colors 22, 26, 27, 28 Price	Special Order Colors 12, 19, 23, 24, 25 Price
7-1/2" H Vanity – Plumbing Drawer, No Undercounter Sink					
	Base Unit	VM30H1D21P__N	\$ 1,579.	\$ 2,029.	\$ 2,449.
	With 2700K/4000K Night Light	VM30H1D21P__S	\$ 1,949.	\$ 2,399.	\$ 2,829.
	With 5000K Night Light	VM30H1D21P__L	\$ 1,949.	\$ 2,399.	\$ 2,829.
7-1/2" H Vanity – Full Drawer, No Sink					
	Base Unit	VM30H1D21F__N	\$ 1,579.	\$ 2,029.	\$ 2,449.
	With 2700K/4000K Night Light	VM30H1D21F__S	\$ 1,949.	\$ 2,399.	\$ 2,829.
	With 5000K Night Light	VM30H1D21F__L	\$ 1,949.	\$ 2,399.	\$ 2,829.
7-1/2" H Vanity – Tip Out Drawer					
	Base Unit	VM30H1D21T__N	\$ 1,579.	\$ 2,029.	\$ 2,449.
	With 2700K/4000K Night Light	VM30H1D21T__S	\$ 1,949.	\$ 2,399.	\$ 2,829.
	With 5000K Night Light	VM30H1D21T__L	\$ 1,949.	\$ 2,399.	\$ 2,829.
15" H Vanity – Plumbing Drawer					
	Base Unit	VM30H2D21P__N	\$ 1,799.	\$ 2,229.	\$ 2,679.
	With 2700K/4000K Night Light	VM30H2D21P__S	\$ 2,179.	\$ 2,629.	\$ 3,049.
	With 5000K Night Light	VM30H2D21P__L	\$ 2,179.	\$ 2,629.	\$ 3,049.
15" H Vanity – Full Drawer, No Sink					
	Base Unit	VM30H2D21F__N	\$ 1,799.	\$ 2,229.	\$ 2,679.
	With 2700K/4000K Night Light	VM30H2D21F__S	\$ 2,179.	\$ 2,629.	\$ 3,049.
	With 5000K Night Light	VM30H2D21F__L	\$ 2,179.	\$ 2,629.	\$ 3,049.

Vanity Color Options

Fill in __ designator to Model listed above with desired color. Example: VM30H1D21T20L.

Stock Colors

- 10 Mirror
- 11 Tinted Gray Mirror
- 20 Black
- 21 White

Classic Colors

- 22 Beach
- 26 Matte White
- 27 Matte Gray
- 28 Matte Black

Special Order Colors

- 12 Satin Bronze
- 19 Satin White
- 23 Ocean
- 24 Smoke Screen
- 25 Silver Screen

See Vanity Tops, Accessories & Options on the following page.

Cartesian® Vanity – VM30 – 30" W x 21" D

31" W x 22" D Vanity Tops – For 21" D Vanities

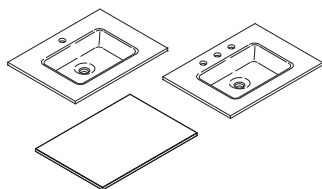

Description	For Use With Vanity	See Page
TS31UCN __ Glass Vanity Top	Plumbing & Tip Out Drawer	129
TF31UCO __ Engineered Stone Vanity Top	Plumbing & Tip Out Drawer	129
TF31G __ Engineered Stone Vanity Top (No Sink)	30" W Vanities	129

**Undercounter Sink available for Custom Countertop – see page 135.
See Cartesian Ganging Reference on pages 108 – 110.**

Accessories & Options

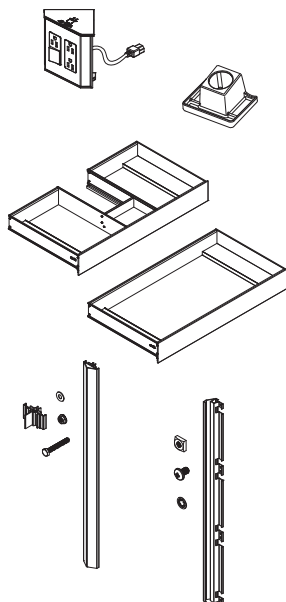

Description	Model	Price
Electric Accessory		
For use in 15" H plumbing or full drawer (H2)	VAELECTRIC21	\$ 449.
Hair Styling Organizer		
For use in 15" H plumbing (vessel only) or full drawer (H2)	VAHAIRORG	\$ 229.
Slim Drawer Insert		
For use in 15" H plumbing drawer (H2)	VADRAWER30P	\$ 729.
For use in 15" H full drawer (H2)	VADRAWER30X	\$ 729.
Note: Not for use with plumbing drawer undercounter sink installations or with Robern's stone vanity tops. Can be used in above-counter vessel installations.		
Vanity Ganging Kit – Hardware required when combining two or more vanities		
7-1/2" H	VMGKITH1	\$ 99.
15" H	VMGKITH2	\$ 99.
22-1/2" H	VMGKITH3	\$ 229.
30" H	VMGKITH4	\$ 229.
Vanity Alcove Finishing Kit – Hardware required for corner or alcove installations		
7-1/2" H	VMAKITH1	\$ 99.
15" H	VMAKITH2	\$ 99.
22-1/2" H	VMAKITH3	\$ 229.
30" H	VMAKITH4	\$ 229.

See additional Accessories on pages 266 – 268.

Vanity Side Kits

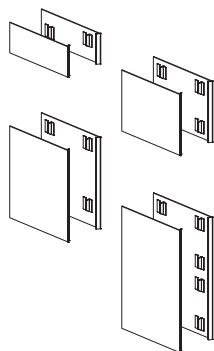

Description	Model	Stock Colors	Classic Colors	Special Order Colors
Vanity Side Kits – Includes glass panel(s) & hardware (see Color Options on previous page)				
Single, 7-1/2" H, 21" D	VM1SKH1D21- __	\$ 229.	\$ 279.	\$ 329.
Pair, 7-1/2" H, 21" D	VM2SKH1D21- __	\$ 329.	\$ 449.	\$ 549.
Single, 15" H, 21" D	VM1SKH2D21- __	\$ 279.	\$ 329.	\$ 399.
Pair, 15" H, 21" D	VM2SKH2D21- __	\$ 399.	\$ 499.	\$ 629.
Single, 22-1/2" H, 21" D	VM1SKH3D21- __	\$ 329.	\$ 399.	\$ 449.
Pair, 22-1/2" H, 21" D	VM2SKH3D21- __	\$ 549.	\$ 679.	\$ 799.
Single, 30" H, 21" D	VM1SKH4D21- __	\$ 399.	\$ 449.	\$ 499.
Pair, 30" H, 21" D	VM2SKH4D21- __	\$ 679.	\$ 799.	\$ 899.

Note: You must choose one side kit or alcove kit for every exposed side.

SEE PAGES 106 – 107 FOR TIPS AND FEATURES.

Cartesian® Vanity – VM36 – 36" W x 18" D



For those who want to create a personalized configuration, the Cartesian Vanity offers limitless solutions and unique designs to fit your preferences, storage needs and the demands of your space.

- Customize around your own needs. Modular design allows you to add or upgrade your existing vanity or night stand and add new features to infinitely expand the functionality
- Withstands wet and damp environments with aluminum and glass construction
- Provides task and way-finding light by using the night light option



Two Week Lead Time
(Stock Colors)



Four Week Lead Time
(Classic/Special Order Colors)



Modular



Electrical
Outlet



Night
Light

36-1/8" W x 18-3/4" D Vanity

Description		Model	Stock Colors 10, 11, 20, 21 Price	Classic Colors 22, 26, 27, 28 Price	Special Order Colors 12, 19, 23, 24, 25 Price
7-1/2" H Vanity – Plumbing Drawer, No Undercounter Sink					
	Base Unit	VM36H1D18P__N	\$ 2,129.	\$ 2,549.	\$ 2,999.
	With 2700K/4000K Night Light	VM36H1D18P__S	\$ 2,549.	\$ 2,999.	\$ 3,429.
	With 5000K Night Light	VM36H1D18P__L	\$ 2,549.	\$ 2,999.	\$ 3,429.
7-1/2" H Vanity – Full Drawer, No Sink					
	Base Unit	VM36H1D18F__N	\$ 2,129.	\$ 2,549.	\$ 2,999.
	With 2700K/4000K Night Light	VM36H1D18F__S	\$ 2,549.	\$ 2,999.	\$ 3,429.
	With 5000K Night Light	VM36H1D18F__L	\$ 2,549.	\$ 2,999.	\$ 3,429.
7-1/2" H Vanity – Tip Out Drawer					
	Base Unit	VM36H1D18T__N	\$ 2,129.	\$ 2,549.	\$ 2,999.
	With 2700K/4000K Night Light	VM36H1D18T__S	\$ 2,549.	\$ 2,999.	\$ 3,429.
	With 5000K Night Light	VM36H1D18T__L	\$ 2,549.	\$ 2,999.	\$ 3,429.
15" H Vanity – Plumbing Drawer					
	Base Unit	VM36H2D18P__N	\$ 2,349.	\$ 2,779.	\$ 3,199.
	With 2700K/4000K Night Light	VM36H2D18P__S	\$ 2,779.	\$ 3,199.	\$ 3,649.
	With 5000K Night Light	VM36H2D18P__L	\$ 2,779.	\$ 3,199.	\$ 3,649.
15" H Vanity – Full Drawer, No Sink					
	Base Unit	VM36H2D18F__N	\$ 2,349.	\$ 2,779.	\$ 3,199.
	With 2700K/4000K Night Light	VM36H2D18F__S	\$ 2,779.	\$ 3,199.	\$ 3,649.
	With 5000K Night Light	VM36H2D18F__L	\$ 2,779.	\$ 3,199.	\$ 3,649.

Vanity Color Options

Fill in __ designator to Model listed above with desired color. Example: VM36H2D18F26N.

Stock Colors

- 10 Mirror
- 11 Tinted Gray Mirror
- 20 Black
- 21 White

Classic Colors

- 22 Beach
- 26 Matte White
- 27 Matte Gray
- 28 Matte Black

Special Order Colors

- 12 Satin Bronze
- 19 Satin White
- 23 Ocean
- 24 Smoke Screen
- 25 Silver Screen

See Vanity Tops, Accessories & Options on the following page.

Cartesian® Vanity – VM36 – 36" W x 18" D

37" W x 19" D Vanity Tops – For 18" D Vanities

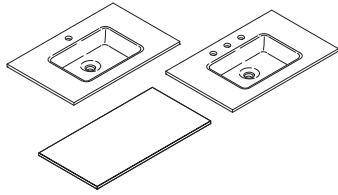

Description	For Use With Vanity	See Page
TC37UCN __ Glass Vanity Top	Plumbing & Tip Out Drawer	130
TE37G __ Engineered Stone Vanity Top (No Sink)	36" W Vanities	130

**Undercounter Sink available for Custom Countertop – see page 135.
See Cartesian Ganging Reference on pages 108 – 110.**

Accessories & Options

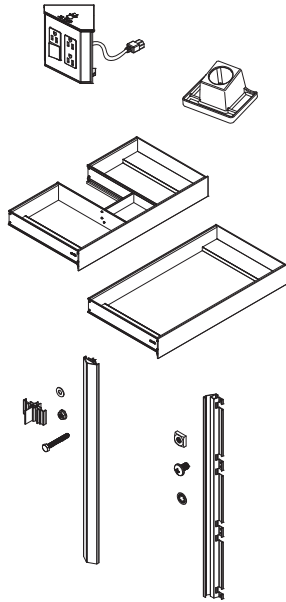

Description	Model	Price
Electric Accessory For use in 15" H plumbing or full drawer (H2)	VAELECTRIC18	\$ 449.
Hair Styling Organizer For use in 15" H plumbing (vessel only) or full drawer (H2)	VAHAIRORG	\$ 229.
Slim Drawer Insert For use in 15" H plumbing drawer (H2)	VADRAWER36P	\$ 799.
For use in 15" H full drawer (H2)	VADRAWER36X	\$ 799.
Note: Not for use with plumbing drawer undercounter sink installations or with Robern's stone vanity tops. Can be used in above-counter vessel installations.		
Vanity Ganging Kit – Hardware required when combining two or more vanities		
7-1/2" H	VMGKITH1	\$ 99.
15" H	VMGKITH2	\$ 99.
22-1/2" H	VMGKITH3	\$ 229.
30" H	VMGKITH4	\$ 229.
Vanity Alcove Finishing Kit – Hardware required for corner or alcove installations		
7-1/2" H	VMAKITH1	\$ 99.
15" H	VMAKITH2	\$ 99.
22-1/2" H	VMAKITH3	\$ 229.
30" H	VMAKITH4	\$ 229.

See additional Accessories on pages 266 – 268.

Vanity Side Kits

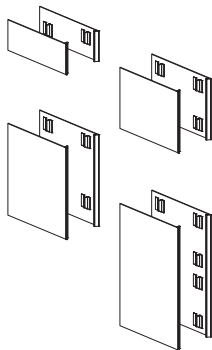

Description	Model	Stock Colors	Classic Colors	Special Order Colors
Vanity Side Kits – Includes glass panel(s) & hardware (see Color Options on previous page)				
Single, 7-1/2" H, 18" D	VM1SKH1D18-__	\$ 229.	\$ 279.	\$ 329.
Pair, 7-1/2" H, 18" D	VM2SKH1D18-__	\$ 329.	\$ 449.	\$ 549.
Single, 15" H, 18" D	VM1SKH2D18-__	\$ 279.	\$ 329.	\$ 399.
Pair, 15" H, 18" D	VM2SKH2D18-__	\$ 399.	\$ 499.	\$ 629.
Single, 22-1/2" H, 18" D	VM1SKH3D18-__	\$ 329.	\$ 399.	\$ 449.
Pair, 22-1/2" H, 18" D	VM2SKH3D18-__	\$ 549.	\$ 679.	\$ 799.
Single, 30" H, 18" D	VM1SKH4D18-__	\$ 399.	\$ 449.	\$ 499.
Pair, 30" H, 18" D	VM2SKH4D18-__	\$ 679.	\$ 799.	\$ 899.

Note: You must choose one side kit or alcove kit for every exposed side.

SEE PAGES 106 – 107 FOR TIPS AND FEATURES.

Cartesian® Vanity – VM36 – 36" W x 21" D



For those who want to create a personalized configuration, the Cartesian Vanity offers limitless solutions and unique designs to fit your preferences, storage needs and the demands of your space.

- Customize around your own needs. Modular design allows you to add or upgrade your existing vanity or night stand and add new features to infinitely expand the functionality
- Withstands wet and damp environments with aluminum and glass construction
- Provides task and way-finding light by using the night light option



Two Week Lead Time
(Stock Colors)



Four Week Lead Time
(Classic/Special Order Colors)



Modular



Electrical
Outlet



Night
Light

36-1/8" W x 21-3/4" D Vanity

Description		Model	Stock Colors 10, 11, 20, 21 Price	Classic Colors 22, 26, 27, 28 Price	Special Order Colors 12, 19, 23, 24, 25 Price
7-1/2" H Vanity – Plumbing Drawer, No Undercounter Sink					
	Base Unit	VM36H1D21P__N	\$ 2,129.	\$ 2,549.	\$ 2,999.
	With 2700K/4000K Night Light	VM36H1D21P__S	\$ 2,549.	\$ 2,999.	\$ 3,429.
	With 5000K Night Light	VM36H1D21P__L	\$ 2,549.	\$ 2,999.	\$ 3,429.
7-1/2" H Vanity – Full Drawer, No Sink					
	Base Unit	VM36H1D21F__N	\$ 2,129.	\$ 2,549.	\$ 2,999.
	With 2700K/4000K Night Light	VM36H1D21F__S	\$ 2,549.	\$ 2,999.	\$ 3,429.
	With 5000K Night Light	VM36H1D21F__L	\$ 2,549.	\$ 2,999.	\$ 3,429.
7-1/2" H Vanity – Tip Out Drawer					
	Base Unit	VM36H1D21T__N	\$ 2,129.	\$ 2,549.	\$ 2,999.
	With 2700K/4000K Night Light	VM36H1D21T__S	\$ 2,549.	\$ 2,999.	\$ 3,429.
	With 5000K Night Light	VM36H1D21T__L	\$ 2,549.	\$ 2,999.	\$ 3,429.
15" H Vanity – Plumbing Drawer					
	Base Unit	VM36H2D21P__N	\$ 2,349.	\$ 2,779.	\$ 3,199.
	With 2700K/4000K Night Light	VM36H2D21P__S	\$ 2,779.	\$ 3,199.	\$ 3,649.
	With 5000K Night Light	VM36H2D21P__L	\$ 2,779.	\$ 3,199.	\$ 3,649.
15" H Vanity – Full Drawer, No Sink					
	Base Unit	VM36H2D21F__N	\$ 2,349.	\$ 2,779.	\$ 3,199.
	With 2700K/4000K Night Light	VM36H2D21F__S	\$ 2,779.	\$ 3,199.	\$ 3,649.
	With 5000K Night Light	VM36H2D21F__L	\$ 2,779.	\$ 3,199.	\$ 3,649.

Vanity Color Options

Fill in __ designator to Model listed above with desired color. Example: VM36H2D21F26N.

Stock Colors

- 10 Mirror
- 11 Tinted Gray Mirror
- 20 Black
- 21 White

Classic Colors

- 22 Beach
- 26 Matte White
- 27 Matte Gray
- 28 Matte Black

Special Order Colors

- 12 Satin Bronze
- 19 Satin White
- 23 Ocean
- 24 Smoke Screen
- 25 Silver Screen

See Vanity Tops, Accessories & Options on the following page.

Cartesian® Vanity – VM36 – 36" W x 21" D

37" W x 22" D Vanity Tops – For 21" D Vanities

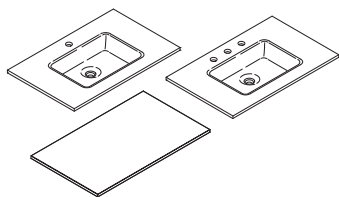

Description	For Use With Vanity	See Page
TF37UCO __ Engineered Stone Vanity Top	Plumbing & Tip Out Drawer	130
TF37G __ Engineered Stone Vanity Top (No Sink)	36" W Vanities	130

**Undercounter Sink available for Custom Countertop – see page 135.
See Cartesian Ganging Reference on pages 108 – 110.**

Accessories & Options

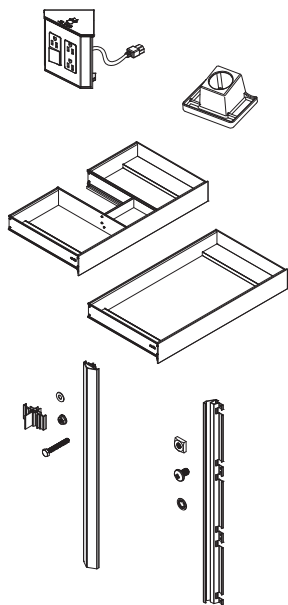

Description	Model	Price
Electric Accessory		
For use in 15" H plumbing or full drawer (H2)	VAELECTRIC21	\$ 449.
Hair Styling Organizer		
For use in 15" H plumbing (vessel only) or full drawer (H2)	VAHAIRORG	\$ 229.
Slim Drawer Insert		
For use in 15" H plumbing drawer (H2)	VADRAWER36P	\$ 799.
For use in 15" H full drawer (H2)	VADRAWER36X	\$ 799.
Note: Not for use with plumbing drawer undercounter sink installations or with Robern's stone vanity tops. Can be used in above-counter vessel installations.		
Vanity Ganging Kit – Hardware required when combining two or more vanities		
7-1/2" H	VMGKITH1	\$ 99.
15" H	VMGKITH2	\$ 99.
22-1/2" H	VMGKITH3	\$ 229.
30" H	VMGKITH4	\$ 229.
Vanity Alcove Finishing Kit – Hardware required for corner or alcove installations		
7-1/2" H	VMAKITH1	\$ 99.
15" H	VMAKITH2	\$ 99.
22-1/2" H	VMAKITH3	\$ 229.
30" H	VMAKITH4	\$ 229.

See additional Accessories on pages 266 – 268.

Vanity Side Kits

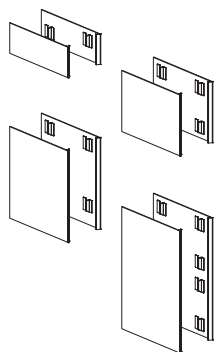

Description	Model	Stock Colors	Classic Colors	Special Order Colors
Vanity Side Kits – Includes glass panel(s) & hardware (see Color Options on previous page)				
Single, 7-1/2" H, 21" D	VM1SKH1D21- __	\$ 229.	\$ 279.	\$ 329.
Pair, 7-1/2" H, 21" D	VM2SKH1D21- __	\$ 329.	\$ 449.	\$ 549.
Single, 15" H, 21" D	VM1SKH2D21- __	\$ 279.	\$ 329.	\$ 399.
Pair, 15" H, 21" D	VM2SKH2D21- __	\$ 399.	\$ 499.	\$ 629.
Single, 22-1/2" H, 21" D	VM1SKH3D21- __	\$ 329.	\$ 399.	\$ 449.
Pair, 22-1/2" H, 21" D	VM2SKH3D21- __	\$ 549.	\$ 679.	\$ 799.
Single, 30" H, 21" D	VM1SKH4D21- __	\$ 399.	\$ 449.	\$ 499.
Pair, 30" H, 21" D	VM2SKH4D21- __	\$ 679.	\$ 799.	\$ 899.

Note: You must choose one side kit or alcove kit for every exposed side.

SEE PAGES 106 – 107 FOR TIPS AND FEATURES.

Vanity Tops – Table of Contents, Tips & Features

Table of Contents

13" Wide Vanity Tops	128
25" Wide Vanity Tops	128
31" Wide Vanity Tops	129
37" Wide Vanity Tops	130
43" Wide Vanity Tops	131
49" Wide Vanity Tops	132
61" Wide Vanity Tops	133
73" Wide Vanity Tops	134 – 135
Undercounter Sink	135
Cartesian® & Profiles™ Vainities Undermount Bowl Space Availability	136

Tips & Features



Eliminate the guesswork when it comes to pairing your vanity and top. Robern's expanded vanity top program offers a full range of pre-cut sizes, materials, and colors (280, from 13" to 73" wide) to meet the needs of any space with a pre-curated solution.

Dimensions & Weight

- Width:
 - 13" (330 mm)
 - 25" (635 mm)
 - 31" (787 mm)
 - 37" (940 mm)
 - 43" (1092 mm)
 - 49" (1245 mm)
 - 61" (1549 mm)
 - 73" (1854 mm)
- Depth:
 - 19" (483 mm)
 - 22" (559 mm)
- Thickness:
 - 19/32" (15 mm) – glass
 - 3/4" (19 mm) – engineered stone



Engineered Stone Tops are exclusively provided by Silestone.

Features & Benefits

- Offers 280 options, 16 cut patterns, 6 colors and 2 materials, for a one-stop shop experience that streamlines your selection process
- Stunning glass top features rectangular integrated sink, without overflow, available in White
- Striking engineered stone tops feature a white rectangular sink, with overflow, available in White Zeus Extreme, Quartz White (White Storm), Lyra, Stone Gray (Expo Grey) and Lava Black (Tebas Black)

Configurable Options

- Vanity Styles: dry top, center sink, left offset sink, right offset sink, double sink, triple sink
- Color Options: quartz white, white zeus extreme, lyra, stone gray, lava black, white glass
- Faucet Drillings: single or three hole 8" widespread

Installation

- Includes installation hardware, silicone and a sink



Glass Tops



Engineered Stone Tops

Vanity Tops

13" W Vanity Tops

	Color	Model	For Use With Vanities	Price
Engineered Stone Vanity Top – 13" W x 19" D x 3/4" thick – No Sink				
	Lava Black (Tebas Black)	TE13G90	12" W Cartesian [®] & Profiles [™] (18" D)	\$ 879.
	Stone Gray (Expo Grey)	TE13G91		\$ 879.
	Quartz White (White Storm)	TE13G92		\$ 979.
	White Zeus Extreme	TE13G93		\$ 1,299.
	Lyra	TE13G94		\$ 1,299.

Engineered Stone Vanity Top – 13" W x 22" D x 3/4" thick – No Sink

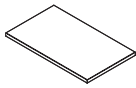

Lava Black (Tebas Black)	TF13G90	12" W Cartesian & Profiles (21" D) & V14 [®]	\$ 879.
Stone Gray (Expo Grey)	TF13G91		\$ 879.
Quartz White (White Storm)	TF13G92		\$ 979.
White Zeus Extreme	TF13G93		\$ 1,299.
Lyra	TF13G94		\$ 1,299.

25" W Vanity Tops

	Color	Model*	For Use With Vanities	Price
Glass Vanity Top – 25" W x 19" D x 19/32" thick – Center Sink (Sink Dimensions = 15-1/2" W x 10" L x 5" D)				
	White	TC25UCN21-1	24" W Cartesian & Profiles (18" D)	\$ 1,029.
		TC25UCN21-8		\$ 1,029.

Glass Vanity Top – 25" W x 22" D x 19/32" thick – Center Sink (Sink Dimensions = 17-1/2" W x 12-1/2" L x 5" D)

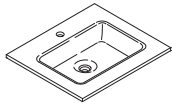

White	TS25UCN21-1	24" W Cartesian & Profiles (21" D) & V14	\$ 1,029.
	TS25UCN21-8		\$ 1,029.

Engineered Stone Vanity Top – 25" W x 22" D x 3/4" thick – Center Sink (Sink Dimensions = 17-1/4" W x 13" L x 5" D)

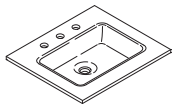

Lava Black (Tebas Black)	TF25UCO90-1	24" W Cartesian & Profiles (21" D) & V14	\$ 1,429.
	TF25UCO90-8		\$ 1,429.
Stone Gray (Expo Grey)	TF25UCO91-1		\$ 1,429.
	TF25UCO91-8		\$ 1,429.
Quartz White (White Storm)	TF25UCO92-1		\$ 1,529.
	TF25UCO92-8		\$ 1,529.
White Zeus Extreme	TF25UCO93-1		\$ 1,849.
	TF25UCO93-8		\$ 1,849.
Lyra	TF25UCO94-1		\$ 1,849.
	TF25UCO94-8		\$ 1,849.

Engineered Stone Vanity Top – 25" W x 19" D x 3/4" thick – No Sink

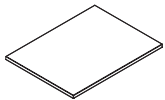

Lava Black (Tebas Black)	TE25G90	24" W Cartesian & Profiles (18" D)	\$ 1,099.
Stone Gray (Expo Grey)	TE25G91		\$ 1,099.
Quartz White (White Storm)	TE25G92		\$ 1,199.
White Zeus Extreme	TE25G93		\$ 1,529.
Lyra	TE25G94		\$ 1,529.

Engineered Stone Vanity Top – 25" W x 22" D x 3/4" thick – No Sink

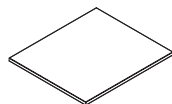

Lava Black (Tebas Black)	TF25G90	24" W Cartesian & Profiles (21" D) & V14	\$ 1,099.
Stone Gray (Expo Grey)	TF25G91		\$ 1,099.
Quartz White (White Storm)	TF25G92		\$ 1,199.
White Zeus Extreme	TF25G93		\$ 1,529.
Lyra	TF25G94		\$ 1,529.

* -1 = Single-Hole Drilling
 -8 = 8" Widespread (3-Hole Centered on Sink Location)

Vanity Tops

31" W Vanity Tops

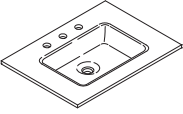
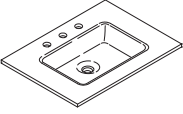
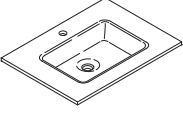
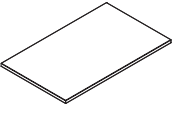
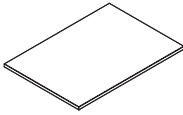
	Color	Model*	For Use With Vanities	Price
Glass Vanity Top – 31" W x 19" D x 19/32" thick – Center Sink (Sink Dimensions = 15-1/2" W x 10" L x 5" D)				
	White	TC31UCN21-1	30" W Cartesian® & Profiles™ (18" D)	\$ 1,129.
		TC31UCN21-8		\$ 1,129.
Glass Vanity Top – 31" W x 22" D x 19/32" thick – Center Sink (Sink Dimensions = 17-1/2" W x 12-1/2" L x 5" D)				
	White	TS31UCN21-1	30" W Cartesian & Profiles (21" D), Balletto® & V14®	\$ 1,129.
		TS31UCN21-8		\$ 1,129.
Engineered Stone Vanity Top – 31" W x 22" D x 3/4" thick – Center Sink (Sink Dimensions = 17-1/4" W x 13" L x 5" D)				
	Lava Black (Tebas Black)	TF31UCO90-1	30" W Cartesian & Profiles (21" D), Balletto & V14	\$ 1,529.
		TF31UCO90-8		\$ 1,529.
	Stone Gray (Expo Grey)	TF31UCO91-1		\$ 1,529.
		TF31UCO91-8		\$ 1,529.
	Quartz White (White Storm)	TF31UCO92-1		\$ 1,629.
		TF31UCO92-8		\$ 1,629.
	White Zeus Extreme	TF31UCO93-1		\$ 1,949.
		TF31UCO93-8		\$ 1,949.
Lyra	TF31UCO94-1		\$ 1,949.	
	TF31UCO94-8		\$ 1,949.	
Engineered Stone Vanity Top – 31" W x 19" D x 3/4" thick – No Sink				
	Lava Black (Tebas Black)	TE31G90	30" W Cartesian & Profiles (18" D)	\$ 1,199.
	Stone Gray (Expo Grey)	TE31G91		\$ 1,199.
	Quartz White (White Storm)	TE31G92		\$ 1,299.
	White Zeus Extreme	TE31G93		\$ 1,629.
	Lyra	TE31G94		\$ 1,629.
Engineered Stone Vanity Top – 31" W x 22" D x 3/4" thick – No Sink				
	Lava Black (Tebas Black)	TF31G90	30" W Cartesian & Profiles (21" D), Balletto & V14	\$ 1,199.
	Stone Gray (Expo Grey)	TF31G91		\$ 1,199.
	Quartz White (White Storm)	TF31G92		\$ 1,299.
	White Zeus Extreme	TF31G93		\$ 1,629.
	Lyra	TF31G94		\$ 1,629.

* -1 = Single-Hole Drilling
 -8 = 8" Widespread (3-Hole Centered on Sink Location)

Vanity Tops

37" W Vanity Tops

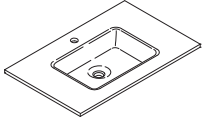
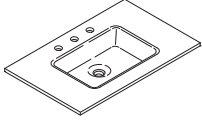
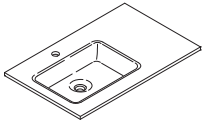
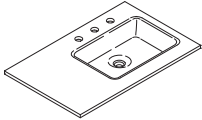
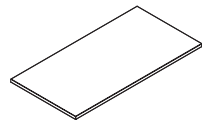
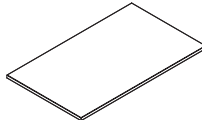
	Color	Model*	For Use With Vanities	Price
Glass Vanity Top – 37" W x 19" D x 19/32" thick – Center Sink (Sink Dimensions = 15-1/2" W x 10" L x 5" D)				
	White	TC37UCN21-1	36" W Cartesian® & Profiles™ (18" D)	\$ 1,349.
		TC37UCN21-8		\$ 1,349.
Engineered Stone Vanity Top – 37" W x 22" D x 3/4" thick – Center Sink (Sink Dimensions = 17-1/4" W x 13" L x 5" D)				
	Lava Black (Tebas Black)	TF37UCO90-1	36" W Cartesian & Profiles (21" D), Balletto® & V14® (single-drawer)	\$ 1,629.
		TF37UCO90-8		\$ 1,629.
	Stone Gray (Expo Grey)	TF37UCO91-1		\$ 1,629.
		TF37UCO91-8		\$ 1,629.
	Quartz White (White Storm)	TF37UCO92-1		\$ 1,749.
		TF37UCO92-8		\$ 1,749.
	White Zeus Extreme	TF37UCO93-1		\$ 2,079.
		TF37UCO93-8		\$ 2,079.
Lyra	TF37UCO94-1		\$ 2,079.	
	TF37UCO94-8		\$ 2,079.	
Engineered Stone Vanity Top – 37" W x 22" D x 3/4" thick – Left Sink (Sink Dimensions = 17-1/4" W x 13" L x 5" D)				
	Lava Black (Tebas Black)	TF37ULO90-1	36" W V14 (two-drawer) or 21" D Cartesian & Profiles vanity arrangement (24-12)	\$ 1,629.
		TF37ULO90-8		\$ 1,629.
	Stone Gray (Expo Grey)	TF37ULO91-1		\$ 1,629.
		TF37ULO91-8		\$ 1,629.
	Quartz White (White Storm)	TF37ULO92-1		\$ 1,749.
		TF37ULO92-8		\$ 1,749.
	White Zeus Extreme	TF37ULO93-1		\$ 2,079.
		TF37ULO93-8		\$ 2,079.
Lyra	TF37ULO94-1		\$ 2,079.	
	TF37ULO94-8		\$ 2,079.	
Engineered Stone Vanity Top – 37" W x 22" D x 3/4" thick – Right Sink (Sink Dimensions = 17-1/4" W x 13" L x 5" D)				
	Lava Black (Tebas Black)	TF37URO90-1	36" W V14 (two-drawer) or 21" D Cartesian & Profiles vanity arrangement (12-24)	\$ 1,629.
		TF37URO90-8		\$ 1,629.
	Stone Gray (Expo Grey)	TF37URO91-1		\$ 1,629.
		TF37URO91-8		\$ 1,629.
	Quartz White (White Storm)	TF37URO92-1		\$ 1,749.
		TF37URO92-8		\$ 1,749.
	White Zeus Extreme	TF37URO93-1		\$ 2,079.
		TF37URO93-8		\$ 2,079.
Lyra	TF37URO94-1		\$ 2,079.	
	TF37URO94-8		\$ 2,079.	
Engineered Stone Vanity Top – 37" W x 19" D x 3/4" thick – No Sink				
	Lava Black (Tebas Black)	TE37G90	36" W Cartesian & Profiles (18" D)	\$ 1,299.
	Stone Gray (Expo Grey)	TE37G91		\$ 1,299.
	Quartz White (White Storm)	TE37G92		\$ 1,429.
	White Zeus Extreme	TE37G93		\$ 1,749.
	Lyra	TE37G94		\$ 1,749.
Engineered Stone Vanity Top – 37" W x 22" D x 3/4" thick – No Sink				
	Lava Black (Tebas Black)	TF37G90	36" W Cartesian & Profiles (21" D), Balletto & V14	\$ 1,299.
	Stone Gray (Expo Grey)	TF37G91		\$ 1,299.
	Quartz White (White Storm)	TF37G92		\$ 1,429.
	White Zeus Extreme	TF37G93		\$ 1,749.
	Lyra	TF37G94		\$ 1,749.

* -1 = Single-Hole Drilling
-8 = 8" Widespread (3-Hole Centered on Sink Location)

Vanity Tops

43" W Vanity Tops

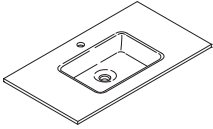
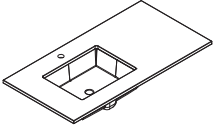
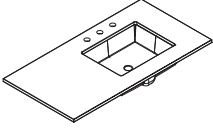
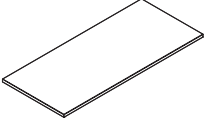
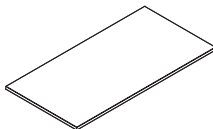
	Color	Model*	For Use With Vainities	Price
Engineered Stone Vanity Top – 43" W x 22" D x 3/4" thick – Center Sink (Sink Dimensions = 17-1/4" W x 13" L x 5" D)				
	Lava Black (Tebas Black)	TF43UCO90-1	42" W Balletto.	\$ 1,849.
		TF43UCO90-8		\$ 1,849.
	Stone Gray (Expo Grey)	TF43UCO91-1		\$ 1,849.
		TF43UCO91-8		\$ 1,849.
	Quartz White (White Storm)	TF43UCO92-1		\$ 1,949.
		TF43UCO92-8		\$ 1,949.
	White Zeus Extreme	TF43UCO93-1		\$ 2,279.
		TF43UCO93-8		\$ 2,279.
	Lyra	TF43UCO94-1		\$ 2,279.
		TF43UCO94-8		\$ 2,279.
Engineered Stone Vanity Top – 43" W x 22" D x 3/4" thick – Left Sink (Sink Dimensions = 17-1/4" W x 13" L x 5" D)				
	Lava Black (Tebas Black)	TF43ULO90-1	21" D Cartesian® & Profiles™ vanity arrangement (30-12)	\$ 1,849.
		TF43ULO90-8		\$ 1,849.
	Stone Gray (Expo Grey)	TF43ULO91-1		\$ 1,849.
		TF43ULO91-8		\$ 1,849.
	Quartz White (White Storm)	TF43ULO92-1		\$ 1,949.
		TF43ULO92-8		\$ 1,949.
	White Zeus Extreme	TF43ULO93-1		\$ 2,279.
		TF43ULO93-8		\$ 2,279.
	Lyra	TF43ULO94-1		\$ 2,279.
		TF43ULO94-8		\$ 2,279.
Engineered Stone Vanity Top – 43" W x 22" D x 3/4" thick – Right Sink (Sink Dimensions = 17-1/4" W x 13" L x 5" D)				
	Lava Black (Tebas Black)	TF43URO90-1	21" D Cartesian & Profiles vanity arrangement (12-30)	\$ 1,849.
		TF43URO90-8		\$ 1,849.
	Stone Gray (Expo Grey)	TF43URO91-1		\$ 1,849.
		TF43URO91-8		\$ 1,849.
	Quartz White (White Storm)	TF43URO92-1		\$ 1,949.
		TF43URO92-8		\$ 1,949.
	White Zeus Extreme	TF43URO93-1		\$ 2,279.
		TF43URO93-8		\$ 2,279.
	Lyra	TF43URO94-1		\$ 2,279.
		TF43URO94-8		\$ 2,279.
Engineered Stone Vanity Top – 43" W x 19" D x 3/4" thick – No Sink				
	Lava Black (Tebas Black)	TE43G90	18" D Cartesian & Profiles vanity arrangement (30-12) or (12-30)	\$ 1,529.
	Stone Gray (Expo Grey)	TE43G91		\$ 1,529.
	Quartz White (White Storm)	TE43G92		\$ 1,629.
	White Zeus Extreme	TE43G93		\$ 1,949.
	Lyra	TE43G94		\$ 1,949.
Engineered Stone Vanity Top – 43" W x 22" D x 3/4" thick – No Sink				
	Lava Black (Tebas Black)	TF43G90	42" W Balletto or 21" D Cartesian & Profiles vanity arrangement (30-12) or (12-30)	\$ 1,529.
	Stone Gray (Expo Grey)	TF43G91		\$ 1,529.
	Quartz White (White Storm)	TF43G92		\$ 1,629.
	White Zeus Extreme	TF43G93		\$ 1,949.
	Lyra	TF43G94		\$ 1,949.

* -1 = Single-Hole Drilling
 -8 = 8" Widespread (3-Hole Centered on Sink Location)

Vanity Tops

49" W Vanity Tops

Vanities & Tops

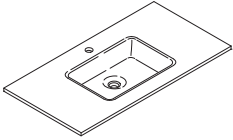
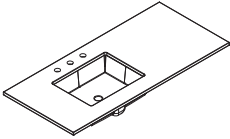
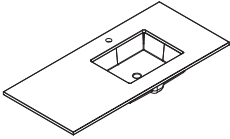
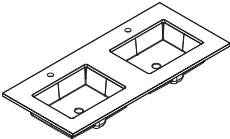
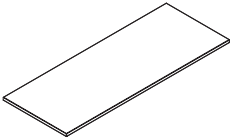
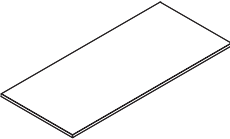
	Color	Model*	For Use With Vanities	Price
Engineered Stone Vanity Top – 49" W x 22" D x 3/4" thick – Center Sink (Sink Dimensions = 17-1/4" W x 13" L x 5" D)				
	Lava Black (Tebas Black)	TF49UCO90-1	48" W V14 [®] (three-drawer) or 21" D Cartesian [®] & Profiles [™] vanity arrangement (12-24-12)	\$ 1,949.
	Stone Gray (Expo Grey)	TF49UCO90-8		\$ 1,949.
		TF49UCO91-1		\$ 1,949.
		TF49UCO91-8		\$ 1,949.
	Quartz White (White Storm)	TF49UCO92-1		\$ 2,079.
		TF49UCO92-8		\$ 2,079.
	White Zeus Extreme	TF49UCO93-1		\$ 2,499.
	TF49UCO93-8	\$ 2,499.		
Lyra	TF49UCO94-1	\$ 2,499.		
	TF49UCO94-8	\$ 2,499.		
Engineered Stone Vanity Top – 49" W x 22" D x 3/4" thick – Left Sink (Sink Dimensions = 17-1/4" W x 13" L x 5" D)				
	Lava Black (Tebas Black)	TF49ULO90-1	21" D Cartesian & Profiles vanity arrangement (36-12)	\$ 1,949.
	Stone Gray (Expo Grey)	TF49ULO90-8		\$ 1,949.
		TF49ULO91-1		\$ 1,949.
		TF49ULO91-8		\$ 1,949.
	Quartz White (White Storm)	TF49ULO92-1		\$ 2,079.
		TF49ULO92-8		\$ 2,079.
	White Zeus Extreme	TF49ULO93-1		\$ 2,499.
	TF49ULO93-8	\$ 2,499.		
Lyra	TF49ULO94-1	\$ 2,499.		
	TF49ULO94-8	\$ 2,499.		
Engineered Stone Vanity Top – 49" W x 22" D x 3/4" thick – Right Sink (Sink Dimensions = 17-1/4" W x 13" L x 5" D)				
	Lava Black (Tebas Black)	TF49URO90-1	21" D Cartesian & Profiles vanity arrangement (12-36)	\$ 1,949.
	Stone Gray (Expo Grey)	TF49URO90-8		\$ 1,949.
		TF49URO91-1		\$ 1,949.
		TF49URO91-8		\$ 1,949.
	Quartz White (White Storm)	TF49URO92-1		\$ 2,079.
		TF49URO92-8		\$ 2,079.
	White Zeus Extreme	TF49URO93-1		\$ 2,499.
	TF49URO93-8	\$ 2,499.		
Lyra	TF49URO94-1	\$ 2,499.		
	TF49URO94-8	\$ 2,499.		
Engineered Stone Vanity Top – 49" W x 22" D x 3/4" thick – Double Sink (Sink Dimensions = 17-1/4" W x 13" L x 5" D)				
	Lava Black (Tebas Black)	TF49UDO90-1D1	21" D Cartesian & Profiles vanity arrangement (24-24)	\$ 2,499.
		TF49UDO90-8D1		\$ 2,499.
	Stone Gray (Expo Grey)	TF49UDO91-1D1		\$ 2,499.
		TF49UDO91-8D1		\$ 2,499.
	Quartz White (White Storm)	TF49UDO92-1D1		\$ 2,629.
		TF49UDO92-8D1		\$ 2,629.
	White Zeus Extreme	TF49UDO93-1D1		\$ 3,049.
	TF49UDO93-8D1	\$ 3,049.		
Lyra	TF49UDO94-1D1	\$ 3,049.		
	TF49UDO94-8D1	\$ 3,049.		
Engineered Stone Vanity Top – 49" W x 19" D x 3/4" thick – No Sink				
	Lava Black (Tebas Black)	TE49G90	18" D Cartesian & Profiles vanity arrangement (24-24) or (12-36) or (36-12) or (12-24-12)	\$ 1,629.
	Stone Gray (Expo Grey)	TE49G91		\$ 1,629.
	Quartz White (White Storm)	TE49G92		\$ 1,749.
	White Zeus Extreme	TE49G93		\$ 2,179.
	Lyra	TE49G94		\$ 2,179.
Engineered Stone Vanity Top – 49" W x 22" D x 3/4" thick – No Sink				
	Lava Black (Tebas Black)	TF49G90	48" W V14 or 21" D Cartesian & Profiles vanity arrangement (24-24) or (12-36) or (36-12) or (12-24-12)	\$ 1,629.
	Stone Gray (Expo Grey)	TF49G91		\$ 1,629.
	Quartz White (White Storm)	TF49G92		\$ 1,749.
	White Zeus Extreme	TF49G93		\$ 2,179.
	Lyra	TF49G94		\$ 2,179.

* -1 & -1D1 = Single-Hole Drilling
 -8 & -8D1 = 8" Widespread (3-Hole Centered on Sink Location)

Vanity Tops

61" W Vanity Tops

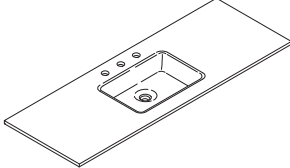
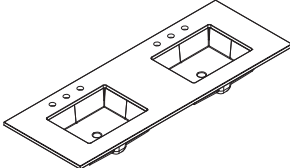
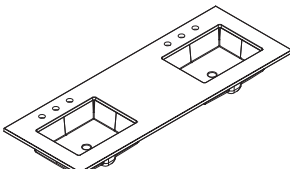
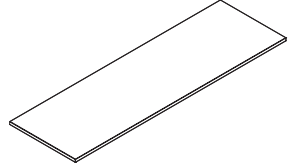
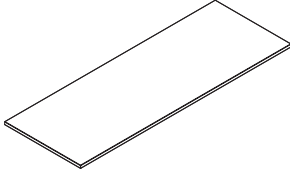
	Color	Model*	For Use With Vainities	Price
Engineered Stone Vanity Top – 61" W x 22" D x 3/4" thick – Center Sink (Sink Dimensions = 17-1/4" W x 13" L x 5" D)				
	Lava Black (Tebas Black)	TF61UCO90-1	60" W V14 [®] (three-drawer) or 21" D Cartesian [®] & Profiles [™] vanity arrangement (12-36-12)	\$ 2,179.
		TF61UCO90-8		\$ 2,179.
	Stone Gray (Expo Grey)	TF61UCO91-1		\$ 2,179.
		TF61UCO91-8		\$ 2,179.
	Quartz White (White Storm)	TF61UCO92-1		\$ 2,279.
		TF61UCO92-8		\$ 2,279.
	White Zeus Extreme	TF61UCO93-1		\$ 2,729.
	TF61UCO93-8	\$ 2,729.		
	Lyra	TF61UCO94-1	\$ 2,729.	
		TF61UCO94-8	\$ 2,729.	
Engineered Stone Vanity Top – 61" W x 22" D x 3/4" thick – Double Sink (Sink Dimensions = 17-1/4" W x 13" L x 5" D)				
	Lava Black (Tebas Black)	TF61UDO90-1D2	21" D Cartesian & Profiles vanity arrangement (30-30)	\$ 2,729.
		TF61UDO90-8D2		\$ 2,729.
	Stone Gray (Expo Grey)	TF61UDO91-1D2		\$ 2,729.
		TF61UDO91-8D2		\$ 2,729.
	Quartz White (White Storm)	TF61UDO92-1D2		\$ 2,829.
		TF61UDO92-8D2		\$ 2,829.
	White Zeus Extreme	TF61UDO93-1D2		\$ 3,279.
	TF61UDO93-8D2	\$ 3,279.		
	Lyra	TF61UDO94-1D2	\$ 3,279.	
		TF61UDO94-8D2	\$ 3,279.	
Engineered Stone Vanity Top – 61" W x 22" D x 3/4" thick – Double Sink (Sink Dimensions = 17-1/4" W x 13" L x 5" D)				
	Lava Black (Tebas Black)	TF61UDO90-1D4	21" D Cartesian & Profiles vanity arrangement (24-12-24)	\$ 2,729.
		TF61UDO90-8D4		\$ 2,729.
	Stone Gray (Expo Grey)	TF61UDO91-1D4		\$ 2,729.
		TF61UDO91-8D4		\$ 2,729.
	Quartz White (White Storm)	TF61UDO92-1D4		\$ 2,829.
		TF61UDO92-8D4		\$ 2,829.
	White Zeus Extreme	TF61UDO93-1D4		\$ 3,279.
	TF61UDO93-8D4	\$ 3,279.		
	Lyra	TF61UDO94-1D4	\$ 3,279.	
		TF61UDO94-8D4	\$ 3,279.	
Engineered Stone Vanity Top – 61" W x 19" D x 3/4" thick – No Sink				
	Lava Black (Tebas Black)	TE61G90	18" D Cartesian & Profiles vanity arrangement (30-30) or (12-36-12) or (24-12-24)	\$ 1,849.
	Stone Gray (Expo Grey)	TE61G91		\$ 1,849.
	Quartz White (White Storm)	TE61G92		\$ 1,949.
	White Zeus Extreme	TE61G93		\$ 2,399.
	Lyra	TE61G94		\$ 2,399.
Engineered Stone Vanity Top – 61" W x 22" D x 3/4" thick – No Sink				
	Lava Black (Tebas Black)	TF61G90	60" W V14 or 21" D Cartesian & Profiles vanity arrangement (30-30) or (12-36-12) or (24-12-24)	\$ 1,849.
	Stone Gray (Expo Grey)	TF61G91		\$ 1,849.
	Quartz White (White Storm)	TF61G92		\$ 1,949.
	White Zeus Extreme	TF61G93		\$ 2,399.
	Lyra	TF61G94		\$ 2,399.

* -1, -1D2 & -1D4 = Single-Hole Drilling
 -8, -8D2 & -8D4 = 8" Widespread (3-Hole Centered on Sink Location)

Vanity Tops

73" W Vanity Tops

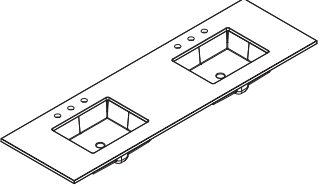
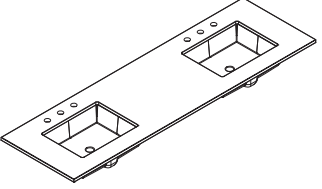
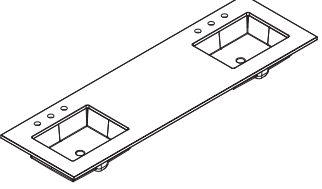
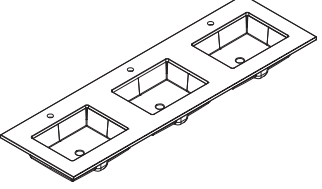
	Color	Model*	For Use With Vanities	Price
Engineered Stone Vanity Top – 73" W x 22" D x 3/4" thick – Double Sink (Sink Dimensions = 17-1/4" W x 13" L x 5" D)				
	Lava Black (Tebas Black)	TF73UDO90-1D3	21" D Cartesian® & Profiles™ vanity arrangement (36-36)	\$ 3,049.
		TF73UDO90-8D3		\$ 3,049.
	Stone Gray (Expo Grey)	TF73UDO91-1D3		\$ 3,049.
		TF73UDO91-8D3		\$ 3,049.
	Quartz White (White Storm)	TF73UDO92-1D3		\$ 3,149.
		TF73UDO92-8D3		\$ 3,149.
	White Zeus Extreme	TF73UDO93-1D3		\$ 3,599.
		TF73UDO93-8D3		\$ 3,599.
	Lyra	TF73UDO94-1D3		\$ 3,599.
		TF73UDO94-8D3		\$ 3,599.
Engineered Stone Vanity Top – 73" W x 22" D x 3/4" thick – Double Sink (Sink Dimensions = 17-1/4" W x 13" L x 5" D)				
	Lava Black (Tebas Black)	TF73UDO90-1D5	21" D Cartesian & Profiles vanity arrangement (30-12-30)	\$ 3,049.
		TF73UDO90-8D5		\$ 3,049.
	Stone Gray (Expo Grey)	TF73UDO91-1D5		\$ 3,049.
		TF73UDO91-8D5		\$ 3,049.
	Quartz White (White Storm)	TF73UDO92-1D5		\$ 3,149.
		TF73UDO92-8D5		\$ 3,149.
	White Zeus Extreme	TF73UDO93-1D5		\$ 3,599.
		TF73UDO93-8D5		\$ 3,599.
	Lyra	TF73UDO94-1D5		\$ 3,599.
		TF73UDO94-8D5		\$ 3,599.
Engineered Stone Vanity Top – 73" W x 22" D x 3/4" thick – Double Sink (Sink Dimensions = 17-1/4" W x 13" L x 5" D)				
	Lava Black (Tebas Black)	TF73UDO90-1D6	21" D Cartesian & Profiles vanity arrangement (24-24-24)	\$ 3,049.
		TF73UDO90-8D6		\$ 3,049.
	Stone Gray (Expo Grey)	TF73UDO91-1D6		\$ 3,049.
		TF73UDO91-8D6		\$ 3,049.
	Quartz White (White Storm)	TF73UDO92-1D6		\$ 3,149.
		TF73UDO92-8D6		\$ 3,149.
	White Zeus Extreme	TF73UDO93-1D6		\$ 3,599.
		TF73UDO93-8D6		\$ 3,599.
	Lyra	TF73UDO94-1D6		\$ 3,599.
		TF73UDO94-8D6		\$ 3,599.
Engineered Stone Vanity Top – 73" W x 22" D x 3/4" thick – Triple Sink (Sink Dimensions = 17-1/4" W x 13" L x 5" D)				
	Lava Black (Tebas Black)	TF73UTO90-1T1	21" D Cartesian & Profiles vanity arrangement (24-24-24)	\$ 3,599.
		TF73UTO90-8T1		\$ 3,599.
	Stone Gray (Expo Grey)	TF73UTO91-1T1		\$ 3,599.
		TF73UTO91-8T1		\$ 3,599.
	Quartz White (White Storm)	TF73UTO92-1T1		\$ 3,699.
		TF73UTO92-8T1		\$ 3,699.
	White Zeus Extreme	TF73UTO93-1T1		\$ 4,149.
		TF73UTO93-8T1		\$ 4,149.
	Lyra	TF73UTO94-1T1		\$ 4,149.
		TF73UTO94-8T1		\$ 4,149.

* -1D3, -1D5, -1D6 & -1T1 = Single-Hole Drilling
 -8D3, -8D5, -8D6 & -8T1 = 8" Widespread (3-Hole Centered on Sink Location)

73" W Vanity Tops continued on next page.

Vanity Tops

73" W Vanity Tops (Continued)

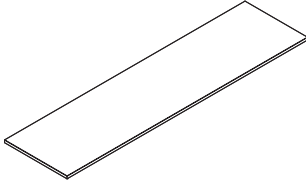
	Color	Model	For Use With Vanities	Price
Engineered Stone Vanity Top – 73" W x 19" D x 3/4" thick – No Sink				
	Lava Black (Tebas Black)	TE73G90	18" D Cartesian® & Profiles™ vanity arrangement (36-36) or (24-24-24) or (30-12-30)	\$ 2,179.
	Stone Gray (Expo Grey)	TE73G91		\$ 2,179.
	Quartz White (White Storm)	TE73G92		\$ 2,279.
	White Zeus Extreme	TE73G93		\$ 2,729.
	Lyra	TE73G94		\$ 2,729.

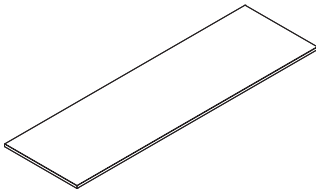
Engineered Stone Vanity Top – 73" W x 22" D x 3/4" thick – No Sink				
	Lava Black (Tebas Black)	TF73G90	21" D Cartesian & Profiles vanity arrangement (36-36) or (24-24-24) or (30-12-30)	\$ 2,179.
	Stone Gray (Expo Grey)	TF73G91		\$ 2,179.
	Quartz White (White Storm)	TF73G92		\$ 2,279.
	White Zeus Extreme	TF73G93		\$ 2,729.
	Lyra	TF73G94		\$ 2,729.

Undercounter Sink

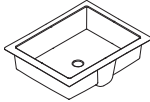
	Color	Model	For Use With Vanities	Price
17-1/4" W x 13" L x 5" D Undercounter Sink (Only)				
	White	LAV1UM-101	For custom countertop	\$ 429.

Note: Sink included with vanity top order (not applicable for tops with no sink). Sink sold separately for those who want a custom top with a sink that will fit.

Cartesian® & Profiles™ Vanities Undermount Bowl Space Availability

7-1/2" (H1) TIP OUT - MAXIMUM DIMENSIONS			
	Width (W)	Depth (D)	Height (H)
VM or VP24H1D18T	22-1/2"	13-1/2"	7-1/2"
VM or VP30H1D18T	28-1/2"	13-1/2"	7-1/2"
VM or VP36H1D18T	34-1/2"	13-1/2"	7-1/2"
VM or VP24H1D21T	22-1/2"	16-1/2"	7-1/2"
VM or VP30H1D21T	28-1/2"	16-1/2"	7-1/2"
VM or VP36H1D21T	34-1/2"	16-1/2"	7-1/2"

15" (H2) PLUMBING - MAXIMUM DIMENSIONS			
	Width (W)	Depth (D)	Height (H)
VM or VP24H2D18P	22-1/2"	15-1/2"	7-1/2"
VM or VP30H2D18P	28-1/2"	15-1/2"	7-1/2"
VM or VP36H2D18P	34-1/2"	15-1/2"	7-1/2"
VM or VP24H2D21P	22-1/2"	18-1/2"	7-1/2"
VM or VP30H2D21P	28-1/2"	18-1/2"	7-1/2"
VM or VP36H2D21P	34-1/2"	18-1/2"	7-1/2"

Top Down View of Vanity Top

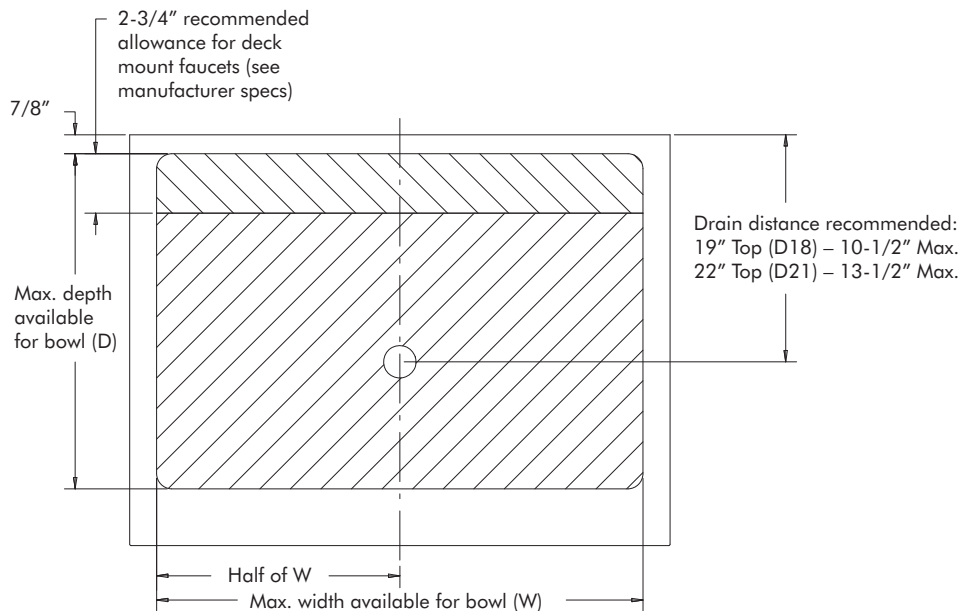

Front View of 15" (H2) Plumbing Vanity

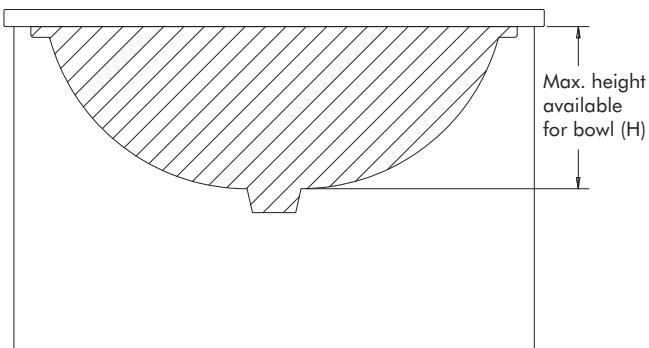

Front View of 7-1/2" (H1) Tip Out Vanity

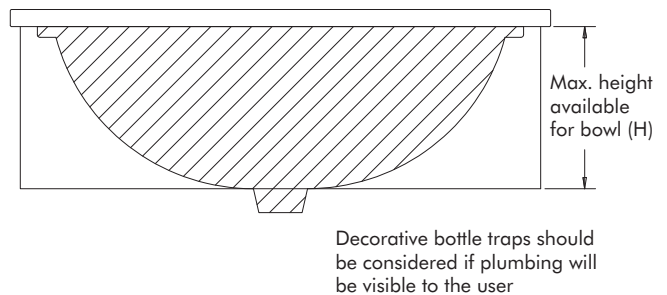

Cabinet Ganging Reference

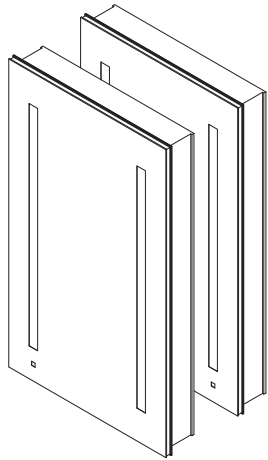

(1) AC2440D4P1L
(1) AC2440D4P1R

+

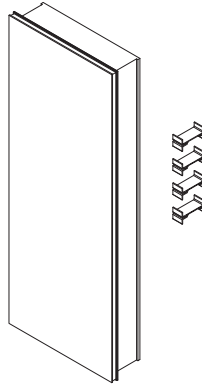

(1) MC1640D4FPLE4
(1) MGKIT

=

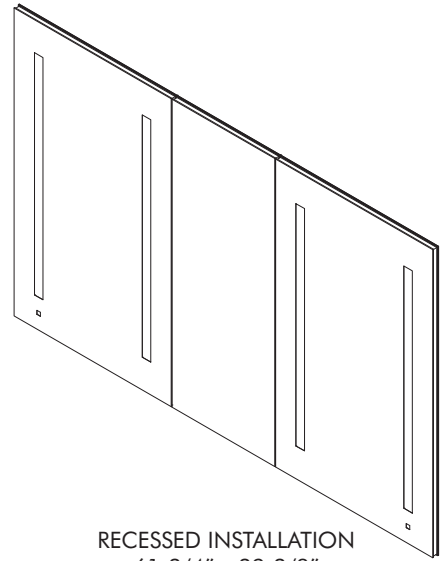

RECESSED INSTALLATION
61-3/4" x 39-3/8"

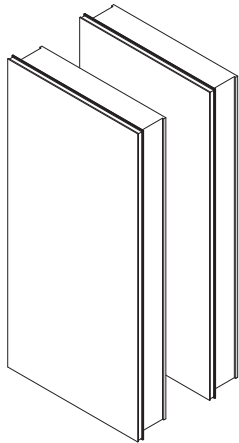

(1) PLM2040GLE
(1) PLM2040GRE

+

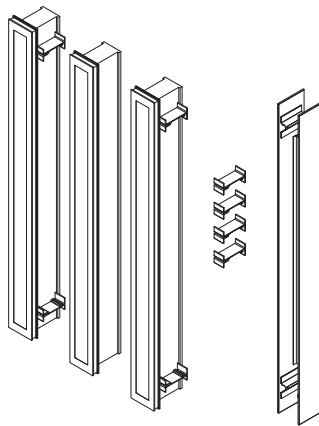

(3) ML3.540ILSFMRDV
(1) MGKIT
(1) PLSMK40D4P

=

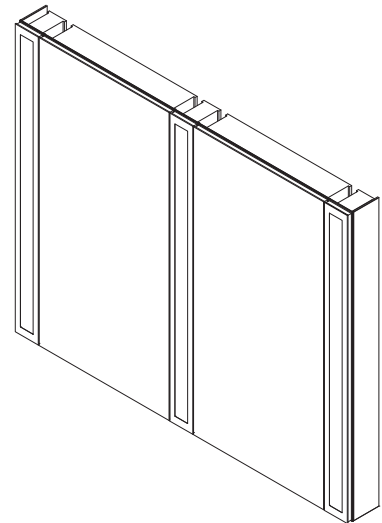

SURFACE-MOUNT INSTALLATION
49" x 39-3/8"

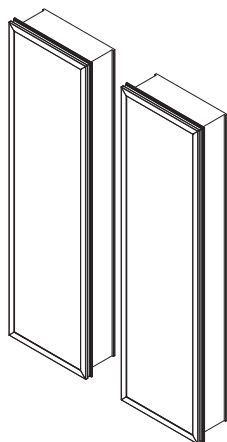

(1) PC1240D4TLE76
(1) PC1240D4TRE76

+

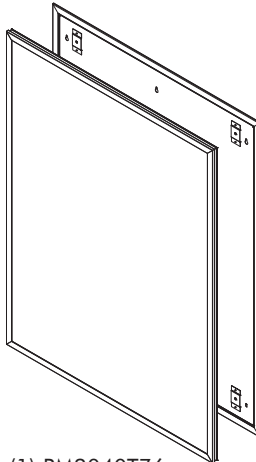

(1) PM3040T76
(1) PMGKIT3040

=

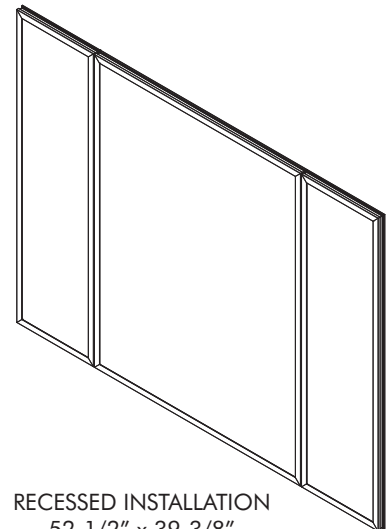

RECESSED INSTALLATION
52-1/2" x 39-3/8"

Uplift® Cabinets – Table of Contents, Tips & Features

Table of Contents

Uplift Cabinets ▼	153
Uplift Lighting	258
Uplift Accessories and Options ▼	154

Tips & Features

Dimensions & Weight

- Width:
30" (762 mm)
36" (914 mm)
48" (1219 mm)
- Height: 27" (686 mm)
- Depth: 6" (152 mm)
- Net Weight: 80 – 100 lbs

Features & Benefits

- Unique vertically opening, no-swing door allows for unobstructed installations
- Position-hold door-opening mechanism lets you open the door as low or as high as you need
- Aluminum handle for effortless two-finger lifting
- Meets ADA requirements for door opening force for sliding doors
- Installed as a single unit or ganged together for a multiple cabinet installation

Configurable Options

- Electrical Packages: Electric or Electric, Night Light and Defogger

Construction

- Durable rust-free anodized aluminum and glass construction – glass resists intense moisture, ensuring long-lasting beauty
- Satin anodized aluminum body
- Interior mirror
- Electric column with six 1500 watt, 120VAC, 15A power outlets

Construction (Continued)

- Auto-on high power, low wattage LED interior lighting
- 2401 cubic inches (39,343 cc) storage capacity for a 30" cabinet with split compartment for maximum flexibility
- 1/4" (6 mm) thick adjustable clear glass shelves
- Discreet wiring enclosure for clutter-free cable management

Installation

- Recessed, semi-recessed or surface-mount installation
- Cabinets include hardware for recessed installation. Surface-mount and semi-recess installations require the purchase of a kit which includes the side kit as well as mounting hardware.
- Recessed (frame and handle project 1-7/8" [48 mm]), semi-recessed 4" (102 mm) in wall (cabinet, frame and handle project 3-7/8" [98 mm]), or surface mount (cabinet, frame and handle project 7-5/8" [194 mm])
- Aluminum top and bottom kit for surface mount installations is required when top or bottom is visible

Accessories

- Uplift Organizer Shelf (UORGshelf__)
- TV Mount: accommodates up to 19" [48.3 cm] diagonal LCD television, width not to exceed 19-1/2" [49.5 cm] (TVMOUNT__)
- Pull-out 3X Magnifying Mirror (POMM)
- Surface-Mount Kit (USK27D6P)
- Semi-Recessed Kit (USK27D6SR)
- Top and Bottom Kit (UBK__D6A__)
- Ganging Kit (UFKIT)

▼ While supplies last.



Uplift® Cabinets ▼



An unexpected solution that adds a wow factor to your bathroom, our Uplift medicine cabinets open vertically to reveal a wealth of features and technologies.

- Unique vertically opening, no-swing door allows for unobstructed installations
- Position-hold door-opening mechanism lets you open the door as low or as high as you need
- Aluminum handle for effortless two-finger lifting
- Meets ADA requirements for door opening force for sliding doors



Two Week Lead Time



Modular



Defogger



Electrical Outlet



Night Light



Interior Lighting



Magnifying Mirror

Uplift Cabinets

	Description	Model	Price
	UC3027 – 30" W x 27" H (RO: 28-3/4" W x 26-1/4" H x 6" D) With Electric	UC3027FPE ▼	\$ 2,949.
	With Electric, Night Light and Defogger	UC3027FPL ▼	\$ 3,379.
	UC3627 – 36" W x 27" H (RO: 34-3/4" W x 26-1/4" H x 6" D) With Electric	UC3627FPE ▼	\$ 3,479.
	With Electric, Night Light and Defogger	UC3627FPL ▼	\$ 3,929.
	UC4827 – 48" W x 27" H (RO: 46-3/4" W x 26-1/4" H x 6" D) With Electric	UC4827FPE ▼	\$ 4,199.
	With Electric, Night Light and Defogger	UC4827FPL ▼	\$ 4,629.

Cabinets

▼ While supplies last.

See Uplift Accessories and Options on the following page.

Uplift® Cabinet Accessories & Options

Accessories & Options



Description

Model

Price

Side Kits for Uplift Cabinets (Quantity 1 = Pair)

Required for surface-mount or semi-recessed application

Surface-Mount – Polished Edge Mirror

USK27D6P ▼

\$ 179.

Semi-Recessed – Polished Edge Mirror

USK27D6SR ▼

\$ 179.

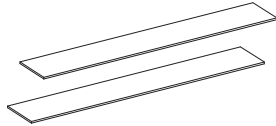

Top and Bottom Kits for Uplift Cabinets Required when top or bottom is visible

Surface-Mount 30" W – Aluminum

UBK30D6A ▼

\$ 229.

Semi-Recessed 30" W – Aluminum

UBK30D6ASR ▼

\$ 229.

Surface-Mount 36" W – Aluminum

UBK36D6A ▼

\$ 229.

Semi-Recessed 36" W – Aluminum

UBK36D6ASR ▼

\$ 229.

Surface-Mount 48" W – Aluminum

UBK48D6A ▼

\$ 229.

Semi-Recessed 48" W – Aluminum

UBK48D6ASR ▼

\$ 229.

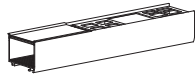

Uplift Organizer Shelves

For 12" Section (36" W)

UORGshelf12 ▼

\$ 279.

For 20" Section (30" & 36" W)

UORGshelf20 ▼

\$ 329.

For 22" Section (48" W)

UORGshelf22 ▼

\$ 329.

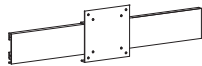

Uplift TV Mount Kits

For 20" Section (30" & 36" W)

TVMOUNT20 ▼

\$ 179.

For 22" Section (48" W)

TVMOUNT22 ▼

\$ 179.

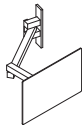

Pull-Out Magnifying Mirror

POMM

\$ 229.

Magnifies at 3X and retracts neatly into cabinet

Uplift Finishing Kit

UFKIT ▼

\$ 179.

Required when pairing Uplift cabinets

Uplift Lighting with Night Light

Uplift Pendant – Anodized Aluminum

UFLPAL

\$ 699.

Uplift Pendant – Polished Chrome

UFLPCRL

\$ 829.

Uplift Pendant – Brushed Nickel

UFLPBNL

\$ 829.

Uplift Pendant – Polished Nickel

UFLPPNL

\$ 829.

Uplift Sconce – Anodized Aluminum

UFLWAL

\$ 699.

Uplift Sconce – Polished Chrome

UFLWCRL

\$ 829.

Uplift Sconce – Brushed Nickel

UFLWBNL

\$ 829.

Uplift Sconce – Polished Nickel

UFLWPNL

\$ 829.

Bulb: 24W, 3000K, 2G11 base

X219-1145

\$ 99.

Recommended Bulbs – available online and in most lighting supply stores:
Philips PL-L24W/830/4D or Sylvania FT24DL/830/ECO

Meets California Title 24 energy codes.

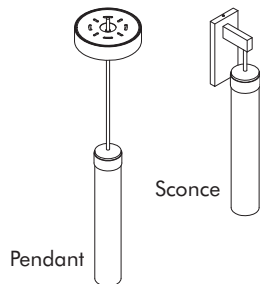

SEE PAGE 152 FOR TIPS AND FEATURES.

▼ While supplies last.

AiO[®] Cabinets – Table of Contents, Tips & Features

Table of Contents

AiO Cabinets Tips & Features	156
30" High Cabinets	157
24" Wide Single Door	157
30" Wide Two Door	157
36" Wide Two Door	157
40" High Cabinets	157
24" Wide Single Door	157
30" Wide Two Door	157
36" Wide Two Door	157
AiO Lighted Mirrors	26 – 27
Cabinet Accessories	271 – 275
Cabinet Ganging Reference	145

Tips & Features

Dimensions & Weight

- Width:
23-1/4" (591 mm)
29-1/4" (743 mm)
35-1/4" (895 mm)
- Height:
30" (762 mm)
39-3/8" (1000 mm)
- Depth: 4-5/8" (117 mm)
- Net Weight: 41 – 70 lbs

Features & Benefits

- OM[®] Audio: built-in speakers with a range up to 30 feet with a 2 channel stereo at 20 watts/channel. Bluetooth connectivity supports most Android and iOS devices. Volume controlled by device.
- LUM[™] Lighting: Integrated dimmable LED lights and one-touch lighting control with capacitive-touch switch built into the mirror
- Choose between warm, relaxing tones (2700K) that replicate indoor lighting or cool, invigorating tones (4000K), which simulate bright daylight
- Remarkably accurate color rendering at 90+ CRI, so you can see your truest reflection
- Light direction and output eliminates dark shadows, provides bright even task lighting and rich, saturated tone in your reflection

Features & Benefits (Continued)

- Dimmable LED task lighting lets you select the ideal brightness for any task
- Can be paired with all M Series mirrored and decorative glass side kits
- Interior illumination with LED lighting built into the cabinet door
- Includes magnetic tool holder for small tools like tweezers and scissors
- Includes two USB charging ports and two 15A, 120VAC outlets (2 plugs) for single door and four 120VAC outlets (4 plugs) for two door
- Includes Compact Adjustable Magnifying Mirror (CAMM) with 5x magnification that sits on the magnetic strip in your cabinet or along the inside of the door so you can see yourself close up
- ETL certified to UL 962, CSA Standard C22.2 No. 68

Configurable Options

- Door Style: single door or two door
- Audio: OM audio or non-audio version
- Color Temperature: 2700K or 4000K
- Hinge Side: left or right



Tips & Features (Continued)

Construction

- Durable rust-free anodized aluminum and glass construction – glass resists intense moisture, ensuring long-lasting beauty
- Satin anodized aluminum body
- Quiet close Safeseal® Gasket with sealed corners on cabinet body
- 3 mirror design – rear of cabinet and both sides of door
- Concealed finger pull-door edge
- Door opening angle 170 degrees (110 with provided stop): Blum self-closing hinges
- Adjustable shelving at 2" (51 mm) increments: 3 shelves for 30" H, 4 shelves for 40" H
- 1/4" (6 mm) thick adjustable clear glass shelves
- Magnetic area in the rail with cabinet to house magnetic tool holder

Installation

- This installation may require more than one person
- Install as a single unit or gang together for a multiple cabinet installation
- Recessed or surface-mount installation
- Cabinets include hardware for recessed installation. Surface-mount installations require the purchase of a surface-mount kit which includes the side kit as well as mounting hardware.
- Recessed cabinets project 7/8" from wall and must be recessed no less than 3-3/4" deep
- Single field wire into electrical shelf – front access serviceability
- MGKIT includes hardware to gang both sides of a cabinet. As a result, three cabinets can be ganged together from one MGKIT.

Accessories

- Safety Lock Box (SLB24D4), 24" W cabinet only
- Entice® Magnification Mirror (ENTICE, ENTICEDOCK)
- Compact Adjustable Magnification Mirror (CAMM)
- Swing-Out Magnifying Mirror (SOMM)
- Pull-Out Magnifying Mirror (POMM) – 24" W only
- Handle Kits (MHANDLEKIT, MPUSHKIT)
- Glass Bins (GLASSBIN3.25, GLASSBIN5.25, GLASSBIN8.5)
- Razor/Phone Holder (MA-TRAY2.5)
- 3" and 5" Accessory Tray (MA-TRAY3, MA-TRAY5)
- Surface-Mount Kit (MSMK30D__, MSMK40D__)
- Ganging Kit (MGKIT)

Lighting Specs

Kelvin	2700K 4000K
CRI	90+
Lumens ¹	750
Lux ^{1, 2}	410
R9 Value ¹	50+
Foot-candles ^{1, 2}	38

¹ Measured on a 24" W x 30" H model

² Measured at 18" from center of the mirror

Efficacy (LED Source)

Watts per Foot	8.8
Lumens per Foot	610
Lumens per Watt	69



AiO® Cabinets



Meet the cabinet with everything. A combination of innovation and convenience, AiO cabinets provide a solution for all your styling needs. Use OM[®] Audio with Bluetooth[®] connectivity to listen to your favorite music, control LUM[™] dimmable task lighting with a capacitive-touch switch, charge your mobile devices and more.

- LUM Lighting Technology includes an integrated LED light, engine and dimmer, and capacitive-touch dimming switch
- OM Audio Technology transforms your mirror into an audio system, generating sound into the entire space with high fidelity Bluetooth[®] connectivity
- ETL certified to UL 1598, CSA Standard C22.2 No. 250.0

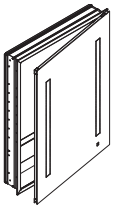
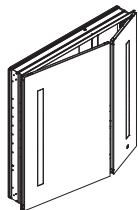
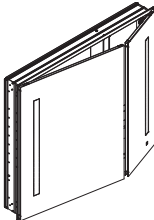

AiO 30" H and 40" H Cabinets

Description	2700K	4000K	Price	2700K With Audio	4000K With Audio	Price
Single Door, Polished Edge – 24" W: 23-1/4" W x 30" H x 4" D (RO: 22-1/2" W x 29-1/4" H x 4" D)						
 Left Hinge	AC2430D4P1LW	AC2430D4P1L	\$ 1,949.	AC2430D4P1LAW	AC2430D4P1LA	\$ 2,499.
Right Hinge	AC2430D4P1RW	AC2430D4P1R	\$ 1,949.	AC2430D4P1RAW	AC2430D4P1RA	\$ 2,499.
Single Door, Polished Edge – 24" W: 23-1/4" W x 39-3/8" H x 4" D (RO: 22-1/2" W x 38-5/8" H x 4" D)						
Left Hinge	AC2440D4P1LW	AC2440D4P1L	\$ 2,449.	AC2440D4P1LAW	AC2440D4P1LA	\$ 2,999.
Right Hinge	AC2440D4P1RW	AC2440D4P1R	\$ 2,449.	AC2440D4P1RAW	AC2440D4P1RA	\$ 2,999.
Two Door, Polished Edge – 30" W: 29-1/4" W x 30" H x 4" D (RO: 28-1/2" W x 29-1/4" H x 4" D)						
 Large Door at Left	AC3030D4P2LW	AC3030D4P2L	\$ 2,349.	AC3030D4P2LAW	AC3030D4P2LA	\$ 2,879.
Two Door, Polished Edge – 30" W: 29-1/4" W x 39-3/8" H x 4" D (RO: 28-1/2" W x 38-5/8" H x 4" D)						
Large Door at Left	AC3040D4P2LW	AC3040D4P2L	\$ 2,779.	AC3040D4P2LAW	AC3040D4P2LA	\$ 3,329.
Two Door, Polished Edge – 36" W: 35-1/4" W x 30" H x 4" D (RO: 34-1/2" W x 29-1/4" H x 4" D)						
 Large Door at Left	AC3630D4P2LW	AC3630D4P2L	\$ 2,679.	AC3630D4P2LAW	AC3630D4P2LA	\$ 3,199.
Two Door, Polished Edge – 36" W: 35-1/4" W x 39-3/8" H x 4" D (RO: 34-1/2" W x 38-5/8" H x 4" D)						
Large Door at Left	AC3640D4P2LW	AC3640D4P2L	\$ 3,099.	AC3640D4P2LAW	AC3640D4P2LA	\$ 3,649.

 **Note:** Models in **bold** indicate Quick Ship product.

See AiO Accessories and Options on the following page.

AiO® Cabinet Accessories & Options

Surface-Mount Kits



Description	Model	Mirror	Stock Colors	Classic Colors	Special Order Colors
For 30" H Cabinets – Quantity 1 = Pair of Side Kits and Mounting Hardware					
D4 Surface-Mount, Polished Edge	MSMK30D4P	\$ 149.	N/A	N/A	N/A
D4 Surface-Mount, Decorative*	MSMK30D4__	N/A	\$ 199.	\$ 249.	\$ 329.
For 40" H Cabinets – Quantity 1 = Pair of Side Kits and Mounting Hardware					
D4 Surface-Mount, Polished Edge	MSMK40D4P	\$ 249.	N/A	N/A	N/A
D4 Surface-Mount, Decorative*	MSMK40D4__	N/A	\$ 329.	\$ 379.	\$ 429.

See Bottom Kits on page 275.

Color Options

*Fill in __ designator to Model listed above with desired color. Example: **MSMK40D420**.

Stock Colors

11	Tinted Gray Mirror
20	Black
21	White

Classic Colors

22	Beach
26	Matte White
27	Matte Gray
28	Matte Black

Special Order Colors

12	Satin Bronze	24	Smoke Screen
19	Satin White	25	Silver Screen
23	Ocean		

Accessories & Options

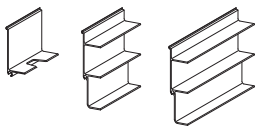
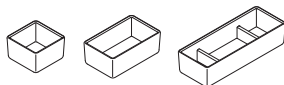
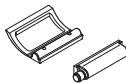
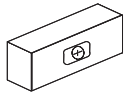
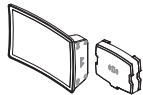

Description

Magnifying Mirrors

Entice® magnification mirror

Entice magnification mirror with inductive charging dock

Compact adjustable magnification mirror

Refer to page 272 for SOMM Magnifying Mirror.

Safety Lock Box

Full compartment keyed lock box in an anodized aluminum finish, for use with 24" W cabinet only

Handle Kits

Chrome Handle
or

Push-to-Open Mechanism

Accessory Glass Bins

Small, 3-1/4" W x 3-1/4" L

Medium, 3-1/4" W x 5-1/4" L

Large, 3-1/4" W x 8-1/2" L

Accessory Trays

Razor/Phone Holder

3" Accessory Tray

5" Accessory Tray

Ganging Kit (30"/40" H)

Hardware required for installing 2 or 3 cabinets side-by-side

Model

ENTICE

ENTICEDOCK

CAMM

SLB24D4

MHANDLEKIT

MPUSHKIT

GLASSBIN3.25

GLASSBIN5.25

GLASSBIN8.5

MA-TRAY2.5

MA-TRAY3

MA-TRAY5

MGKIT

Price

\$ 449.

\$ 499.

\$ 49.

\$ 279.

\$ 179.

\$ 99.

\$ 49.

\$ 49.

\$ 49.

\$ 29.

\$ 29.

\$ 29.

\$ 49.

See AiO Wall Mirrors on pages 26 – 27.

Note: Models in **bold** indicate Quick Ship product.

SEE PAGES 155 – 156 FOR TIPS AND FEATURES.

Profiles™ Framed Cabinets – Table of Contents

Profiles Ganging Reference	72
Profiles Framed Cabinet Tips & Features	160
Profiles Framed Cabinet Worksheet	161
30" High Cabinets	162 – 169
12" Wide	162 – 163
16" Wide	164 – 165
20" Wide	166 – 167
24" Wide	168 – 169
40" High Cabinets	170 – 177
12" Wide	170 – 171
16" Wide	172 – 173
20" Wide	174 – 175
24" Wide	176 – 177
Profiles Framed Mirrors	28 – 29
Profiles Lighting Options	249 – 251
Cabinet Accessories	271 – 275



Profiles™ Framed Cabinets – Tips & Features

Dimensions & Weight

- Width:
11-1/4" (286 mm)
15-1/4" (387 mm)
19-1/4" (489 mm)
23-1/4" (591 mm)
- Height:
30" (762 mm)
39-3/8" (1000 mm)
- Depth:
4" (102 mm)
6" (152 mm); 4-11/16" (119 mm) surface-mount;
15/16" (24 mm) when recessed
- Net Weight: 18 – 43 lbs

Features & Benefits

- Match all fixtures in your styling space with Profiles metal frame finishes for a coordinated look: Chrome, Polished Nickel, Matte Gold, Matte Black
- Modular cabinets can be ganged with Profiles Lighting and Profiles Mirrors with optional ganging kit
- Electric option includes two USB charging ports and one 15A, 120VAC outlets (2 plugs)
- Includes magnetic tool holder (except 12" W electric options)
- Pair with Profiles Mirror when storage is not needed and Profiles Lighting to create task lighting in your styling space
- ETL certified to UL 962, CSA Standard C22.2 No. 68
- Create a coordinated ensemble by pairing with Profiles Lighting, Profiles Mirrors and Profiles Vanities

Configurable Options

- Metal Frame Finishes:
Chrome, Polished Nickel, Matte Gold, Matte Black
- Electrical Packages: none, electric
- Hinge Options: non-handed, left or right hinge

Construction

- Durable rust-free anodized aluminum and glass construction – glass resists intense moisture, ensuring long-lasting beauty
- Satin anodized aluminum body
- Quiet close Safeseal® Gasket with sealed corners on cabinet body
- 3 mirror design – on back of door and inside of cabinet

Construction (Continued)

- Concealed finger pull-door edge
- Door opening angle 170 degrees (110 with provided stop): Blum self-closing hinges
- Adjustable shelving at 2" (51 mm) increments: 3 shelves for 30" H, 4 shelves for 40" H
- 1/4" (6 mm) thick adjustable clear glass shelves
- Magnetic area in the rail with cabinet to house magnetic tool holder

Installation

- This installation may require more than one person
- Install as a single unit or gang together for a multiple cabinet installation
- Recessed, semi-recessed or surface-mount installation (6" deep cabinets can be semi-recessed by 4")
- Cabinets include hardware for recessed installation. Surface-mount and semi-recess installations require the purchase of a kit which includes the side kit as well as mounting hardware.
- Recessed cabinets project 15/16" from wall and must be recessed no less than 3-3/4" deep
- For ganging with Profiles Lighting or Profiles Mirrors, a ganging kit is needed to ensure flush alignment.
- Optional MGKIT includes hardware to gang both sides of a cabinet. As a result, three cabinets or two cabinets and three lights can be ganged together from one MGKIT.

Accessories

- Safety Lock Box (SLB-*) – not for use with 12" W cabinets
- Pull-Out Magnifying Mirror (POMM)
- Swing-Out Magnifying Mirror (SOMM)
- Push-to-Open Kit (MPUSHKIT)
- Glass Bins (GLASSBIN3.25, GLASSBIN5.25, GLASSBIN8.5)
- Razor/Phone Holder (MA-TRAY2.5)
- 3" and 5" Accessory Tray (MA-TRAY3, MA-TRAY5)
- Surface-Mount Kits (MSMK30D__, MSMK40D__)
- Ganging Kit (MGKIT) – for ganging with lighting and other cabinets
- Ganging Kit (PMGKIT ____) – for ganging with Profiles Mirrors
- Stacking Filler System (MSF-*)



Profiles™ Framed Cabinet Worksheet

FEATURES

Select Width:

12"

16"

20"

24"

Select Height:

30"

40"

Select Depth:

4"

6"

Frame Width = 3/4"

Hinge Side:

Left

Right

Non-Handed (Left or Right Hinge)

Electric Option:

Electric

Non-Electric

Select Metal Frame Finish:

Chrome

Polished Nickel

Matte Gold

Matte Black

MODEL

PC

T

12

16

20

24

30

40

D4

D6

T

L

R

N

E

N

76

77

82

83

Cabinets

Note:

Profiles Cabinets have a 2 week lead time.

CUSTOMER INFORMATION

Name

Address

City/State/Zip

Telephone

Date Ordered

Light Selection

Surface-Mount Side Kit Model (if applicable)

Frame Choice

Notes

Profiles™ Framed Cabinets – 12" W x 30" H



For those who want a high-functioning styling space, that pays homage to an age gone by, the Profiles Collection offers mirrored cabinets, mirrors, vanities, and task lighting in a wide assortment of sizes and finishes to meet the unique needs of any space.

- Limitless design solutions with ability to coordinate styling space above and below the sink
- Non-Electric and Electric options
- Includes two USB charging outlets and two 120VAC outlets



Two Week Lead Time



Electrical Outlet





USB Charging



Magnetic

12" W x 30" H Cabinets

Description	Model	FRAME FINISHES	
		76, 77 Price	82, 83 Price
4" Deep (D4): 11-1/4" W x 30" H (RO: 10-1/2" W x 29-1/4" H x 4" D)			
 Non-Handed	PC1230D4TNN __	\$ 1,099.	\$ 1,199.
Left – Electric	PC1230D4TLE __	\$ 1,479.	\$ 1,579.
Right – Electric	PC1230D4TRE __	\$ 1,479.	\$ 1,579.
6" Deep (D6): 11-1/4" W x 30" H (RO: 10-1/2" W x 29-1/4" H x 6" D)			
 Non-Handed	PC1230D6TNN __	\$ 1,349.	\$ 1,479.
Left – Electric	PC1230D6TLE __	\$ 1,749.	\$ 1,849.
Right – Electric	PC1230D6TRE __	\$ 1,749.	\$ 1,849.

Cabinets

Frame Finish Options

Fill in __ designator to Model listed above with desired finish. Example: PC1230D4TLE77.

- 76 Chrome
- 77 Polished Nickel
- 82 Matte Gold
- 83 Matte Black

See Surface-Mount Kits, Accessories & Options on the following page.

Profiles™ Framed Cabinets – 12" W x 30" H

Surface-Mount Kits for 30" H Cabinets

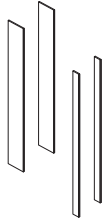

Description	Model	MIRRORED	DECORATIVE		
		Polished Edge	Stock Colors	Classic Colors	Special Order Colors
		Price	11, 20, 21 Price	22, 26, 27, 28 Price	12, 19, 23 Price
Quantity 1 = Pair of Side Kits and Mounting Hardware					
D4 Surface-Mount, Polished Edge	MSMK30D4P	\$ 149.	N/A	N/A	N/A
D4 Surface-Mount, Decorative*	MSMK30D4 __	N/A	\$ 199.	\$ 249.	\$ 329.
D6 Surface-Mount, Polished Edge	MSMK30D6P	\$ 199.	N/A	N/A	N/A
D6 Surface-Mount, Decorative*	MSMK30D6 __	N/A	\$ 249.	\$ 329.	\$ 379.
D6 Semi-Recessed, Polished Edge	MSMK30D6SRP	\$ 149.	N/A	N/A	N/A
D6 Semi-Recessed, Decorative*	MSMK30D6SR __	N/A	\$ 199.	\$ 249.	\$ 329.

Surface-Mount Kit Color Options

*Fill in __ designator to Decorative Model listed above with desired color. Example: **MSMK30D620**.

Stock Colors

- 11 Tinted Gray Mirror
- 20 Black
- 21 White

Classic Colors

- 22 Beach
- 26 Matte White
- 27 Matte Gray
- 28 Matte Black

Special Order Colors

- 12 Satin Bronze
- 19 Satin White
- 23 Ocean

Accessories & Options

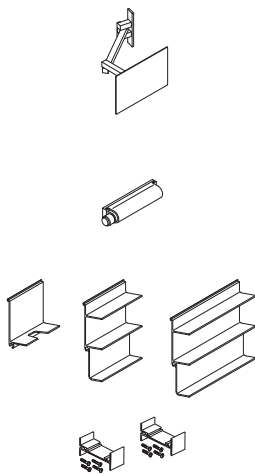

Description	Model	Price
POMM Magnifying Mirror		
Pull-Out Magnifying Mirror	POMM	\$ 229.
Magnifies at 3X and retracts neatly into cabinet		
Refer to page 272 for SOMM Magnifying Mirror.		
Handle Kit		
Push-to-Open Mechanism	MPUSHKIT	\$ 99.
Accessory Trays		
Razor/Phone Holder	MA-TRAY2.5	\$ 29.
3" Accessory Tray	MA-TRAY3	\$ 29.
5" Accessory Tray	MA-TRAY5	\$ 29.
Ganging Kit (30"/40" H)	MGKIT	\$ 49.
Hardware required for installing 2 or 3 cabinets side-by-side		
See Bottom Kits on page 275.		

Coordinating Options:

Profiles Vertical Lights
Refer to pages 249 – 251.

Profiles Wall Mirrors
See pages 28 – 29.

Profiles Vanities
See pages 70 – 87.

Other Options:

Glass Bins
See page 272.

SEE PAGE 160 FOR TIPS AND FEATURES.

Profiles™ Framed Cabinets – 16" W x 30" H



For those who want a high-functioning styling space, that pays homage to an age gone by, the Profiles Collection offers mirrored cabinets, mirrors, vanities, and task lighting in a wide assortment of sizes and finishes to meet the unique needs of any space.

- Limitless design solutions with ability to coordinate styling space above and below the sink
- Non-Electric and Electric options
- Includes two USB charging outlets and two 120VAC outlets

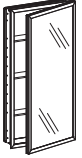
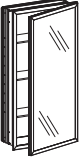

16" W x 30" H Cabinets

Description	Model	FRAME FINISHES	
		76, 77 Price	82, 83 Price
4" Deep (D4): 15-1/4" W x 30" H (RO: 14-1/2" W x 29-1/4" H x 4" D)			
 Non-Handed	PC1630D4TNN __	\$ 1,199.	\$ 1,299.
Left – Electric	PC1630D4TLE __	\$ 1,579.	\$ 1,679.
Right – Electric	PC1630D4TRE __	\$ 1,579.	\$ 1,679.
6" Deep (D6): 15-1/4" W x 30" H (RO: 14-1/2" W x 29-1/4" H x 6" D)			
 Non-Handed	PC1630D6TNN __	\$ 1,479.	\$ 1,579.
Left – Electric	PC1630D6TLE __	\$ 1,849.	\$ 1,949.
Right – Electric	PC1630D6TRE __	\$ 1,849.	\$ 1,949.

Cabinets

Frame Finish Options

Fill in __ designator to Model listed above with desired finish. Example: PC1630D4TRE82.

- 76 Chrome
- 77 Polished Nickel
- 82 Matte Gold
- 83 Matte Black

See Surface-Mount Kits, Accessories & Options on the following page.

Profiles™ Framed Cabinets – 16" W x 30" H

Surface-Mount Kits for 30" H Cabinets

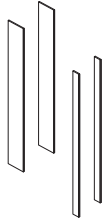

Description	Model	MIRRORED	DECORATIVE		
		Polished Edge	Stock Colors	Classic Colors	Special Order Colors
		Price	11, 20, 21 Price	22, 26, 27, 28 Price	12, 19, 23 Price
Quantity 1 = Pair of Side Kits and Mounting Hardware					
D4 Surface-Mount, Polished Edge	MSMK30D4P	\$ 149.	N/A	N/A	N/A
D4 Surface-Mount, Decorative*	MSMK30D4 __	N/A	\$ 199.	\$ 249.	\$ 329.
D6 Surface-Mount, Polished Edge	MSMK30D6P	\$ 199.	N/A	N/A	N/A
D6 Surface-Mount, Decorative*	MSMK30D6 __	N/A	\$ 249.	\$ 329.	\$ 379.
D6 Semi-Recessed, Polished Edge	MSMK30D6SRP	\$ 149.	N/A	N/A	N/A
D6 Semi-Recessed, Decorative*	MSMK30D6SR __	N/A	\$ 199.	\$ 249.	\$ 329.

Surface-Mount Kit Color Options

*Fill in __ designator to Decorative Model listed above with desired color. Example: **MSMK30D620**.

Stock Colors

- 11 Tinted Gray Mirror
- 20 Black
- 21 White

Classic Colors

- 22 Beach
- 26 Matte White
- 27 Matte Gray
- 28 Matte Black

Special Order Colors

- 12 Satin Bronze
- 19 Satin White
- 23 Ocean

Accessories & Options

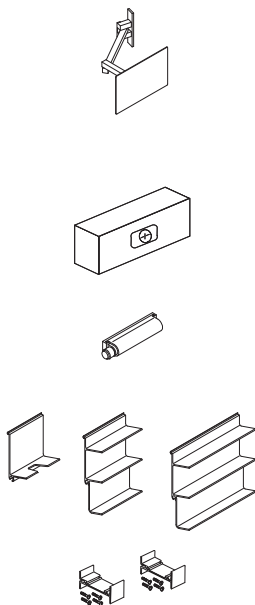

Description	Model	Price
POMM Magnifying Mirror		
Pull-Out Magnifying Mirror	POMM	\$ 229.
Magnifies at 3X and retracts neatly into cabinet		
Refer to page 272 for SOMM Magnifying Mirror.		
Safety Lock Box	SLB-*	\$ 279.
Full compartment keyed lock box in an anodized aluminum finish		
* Follow SLB with first 2 numbers (width) of cabinet model, then depth of cabinet model. Example: SLB16D4.		
Handle Kit		
Push-to-Open Mechanism	MPUSHKIT	\$ 99.
Accessory Trays		
Razor/Phone Holder	MA-TRAY2.5	\$ 29.
3" Accessory Tray	MA-TRAY3	\$ 29.
5" Accessory Tray	MA-TRAY5	\$ 29.
Ganging Kit (30"/40" H)	MGKIT	\$ 49.
Hardware required for installing 2 or 3 cabinets side-by-side		
See Bottom Kits on page 275.		

Coordinating Options:

Profiles Vertical Lights
Refer to pages 249 – 251.

Profiles Wall Mirrors
See pages 28 – 29.

Profiles Vanities
See pages 70 – 87.

Other Options:

Glass Bins
See page 272.

SEE PAGE 160 FOR TIPS AND FEATURES.

Profiles™ Framed Cabinets – 20" W x 30" H



For those who want a high-functioning styling space, that pays homage to an age gone by, the Profiles Collection offers mirrored cabinets, mirrors, vanities, and task lighting in a wide assortment of sizes and finishes to meet the unique needs of any space.

- Limitless design solutions with ability to coordinate styling space above and below the sink
- Non-Electric and Electric options
- Includes two USB charging outlets and two 120VAC outlets



Two Week
Lead Time



Modular



Electrical
Outlet



USB
Charging



Magnetic

20" W x 30" H Cabinets

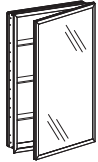
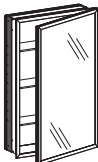
Description	Model	FRAME FINISHES	
		76, 77 Price	82, 83 Price
4" Deep (D4): 19-1/4" W x 30" H (RO: 18-1/2" W x 29-1/4" H x 4" D)			
 Non-Handed	PC2030D4TNN __	\$ 1,299.	\$ 1,429.
Left – Electric	PC2030D4TLE __	\$ 1,679.	\$ 1,799.
Right – Electric	PC2030D4TRE __	\$ 1,679.	\$ 1,799.
6" Deep (D6): 19-1/4" W x 30" H (RO: 18-1/2" W x 29-1/4" H x 6" D)			
 Non-Handed	PC2030D6TNN __	\$ 1,579.	\$ 1,679.
Left – Electric	PC2030D6TLE __	\$ 1,949.	\$ 2,079.
Right – Electric	PC2030D6TRE __	\$ 1,949.	\$ 2,079.

Frame Finish Options

Fill in __ designator to Model listed above with desired finish. Example: PC2030D6TNN76.

- 76 Chrome
- 77 Polished Nickel
- 82 Matte Gold
- 83 Matte Black

See Surface-Mount Kits, Accessories & Options on the following page.

Profiles™ Framed Cabinets – 20" W x 30" H

Surface-Mount Kits for 30" H Cabinets

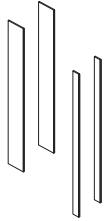

Description	Model	MIRRORED	DECORATIVE		
		Polished Edge	Stock Colors	Classic Colors	Special Order Colors
		Price	11, 20, 21 Price	22, 26, 27, 28 Price	12, 19, 23 Price
Quantity 1 = Pair of Side Kits and Mounting Hardware					
D4 Surface-Mount, Polished Edge	MSMK30D4P	\$ 149.	N/A	N/A	N/A
D4 Surface-Mount, Decorative*	MSMK30D4 __	N/A	\$ 199.	\$ 249.	\$ 329.
D6 Surface-Mount, Polished Edge	MSMK30D6P	\$ 199.	N/A	N/A	N/A
D6 Surface-Mount, Decorative*	MSMK30D6 __	N/A	\$ 249.	\$ 329.	\$ 379.
D6 Semi-Recessed, Polished Edge	MSMK30D6SRP	\$ 149.	N/A	N/A	N/A
D6 Semi-Recessed, Decorative*	MSMK30D6SR __	N/A	\$ 199.	\$ 249.	\$ 329.

Surface-Mount Kit Color Options

*Fill in __ designator to Decorative Model listed above with desired color. Example: **MSMK30D620**.

Stock Colors

- 11 Tinted Gray Mirror
- 20 Black
- 21 White

Classic Colors

- 22 Beach
- 26 Matte White
- 27 Matte Gray
- 28 Matte Black

Special Order Colors

- 12 Satin Bronze
- 19 Satin White
- 23 Ocean

Accessories & Options

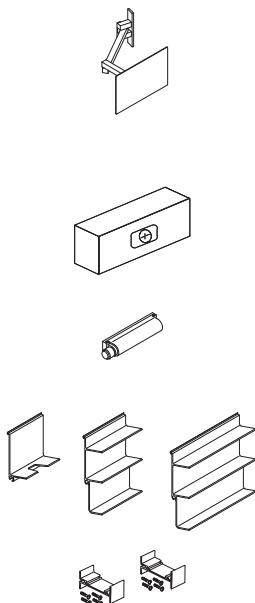

Description	Model	Price
POMM Magnifying Mirror		
Pull-Out Magnifying Mirror	POMM	\$ 229.
Magnifies at 3X and retracts neatly into cabinet		
Refer to page 272 for SOMM Magnifying Mirror.		
Safety Lock Box	SLB-*	\$ 279.
Full compartment keyed lock box in an anodized aluminum finish		
* Follow SLB with first 2 numbers (width) of cabinet model, then depth of cabinet model. Example: SLB20D4.		
Handle Kit		
Push-to-Open Mechanism	MPUSHKIT	\$ 99.
Accessory Trays		
Razor/Phone Holder	MA-TRAY2.5	\$ 29.
3" Accessory Tray	MA-TRAY3	\$ 29.
5" Accessory Tray	MA-TRAY5	\$ 29.
Ganging Kit (30"/40" H)	MGKIT	\$ 49.
Hardware required for installing 2 or 3 cabinets side-by-side		
See Bottom Kits on page 275.		

Coordinating Options:

Profiles Vertical Lights
Refer to pages 249 – 251.

Profiles Wall Mirrors
See pages 28 – 29.

Profiles Vanities
See pages 70 – 87.

Other Options:

Glass Bins
See page 272.

SEE PAGE 160 FOR TIPS AND FEATURES.

Profiles™ Framed Cabinets – 24" W x 30" H



For those who want a high-functioning styling space, that pays homage to an age gone by, the Profiles Collection offers mirrored cabinets, mirrors, vanities, and task lighting in a wide assortment of sizes and finishes to meet the unique needs of any space.

- Limitless design solutions with ability to coordinate styling space above and below the sink
- Non-Electric and Electric options
- Includes two USB charging outlets and two 120VAC outlets



Two Week Lead Time

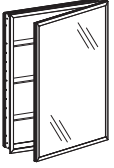
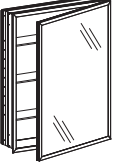

24" W x 30" H Cabinets

Description	Model	FRAME FINISHES	
		76, 77 Price	82, 83 Price
4" Deep (D4): 23-1/4" W x 30" H (RO: 22-1/2" W x 29-1/4" H x 4" D)			
 Non-Handed	PC2430D4TNN __	\$ 1,429.	\$ 1,529.
Left – Electric	PC2430D4TLE __	\$ 1,799.	\$ 1,899.
Right – Electric	PC2430D4TRE __	\$ 1,799.	\$ 1,899.
6" Deep (D6): 23-1/4" W x 30" H (RO: 22-1/2" W x 29-1/4" H x 6" D)			
 Non-Handed	PC2430D6TNN __	\$ 1,679.	\$ 1,799.
Left – Electric	PC2430D6TLE __	\$ 2,079.	\$ 2,179.
Right – Electric	PC2430D6TRE __	\$ 2,079.	\$ 2,179.

Frame Finish Options

Fill in __ designator to Model listed above with desired finish. Example: PC2430D6TLE83.

- 76 Chrome
- 77 Polished Nickel
- 82 Matte Gold
- 83 Matte Black

See Surface-Mount Kits, Accessories & Options on the following page.

Profiles™ Framed Cabinets – 24" W x 30" H

Surface-Mount Kits for 30" H Cabinets

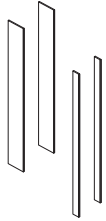

Description	Model	MIRRORED	DECORATIVE		
		Polished Edge	Stock Colors	Classic Colors	Special Order Colors
		Price	11, 20, 21 Price	22, 26, 27, 28 Price	12, 19, 23 Price
Quantity 1 = Pair of Side Kits and Mounting Hardware					
D4 Surface-Mount, Polished Edge	MSMK30D4P	\$ 149.	N/A	N/A	N/A
D4 Surface-Mount, Decorative*	MSMK30D4 __	N/A	\$ 199.	\$ 249.	\$ 329.
D6 Surface-Mount, Polished Edge	MSMK30D6P	\$ 199.	N/A	N/A	N/A
D6 Surface-Mount, Decorative*	MSMK30D6 __	N/A	\$ 249.	\$ 329.	\$ 379.
D6 Semi-Recessed, Polished Edge	MSMK30D6SRP	\$ 149.	N/A	N/A	N/A
D6 Semi-Recessed, Decorative*	MSMK30D6SR __	N/A	\$ 199.	\$ 249.	\$ 329.

Surface-Mount Kit Color Options

*Fill in __ designator to Decorative Model listed above with desired color. Example: **MSMK30D620**.

Stock Colors

- 11 Tinted Gray Mirror
- 20 Black
- 21 White

Classic Colors

- 22 Beach
- 26 Matte White
- 27 Matte Gray
- 28 Matte Black

Special Order Colors

- 12 Satin Bronze
- 19 Satin White
- 23 Ocean

Accessories & Options

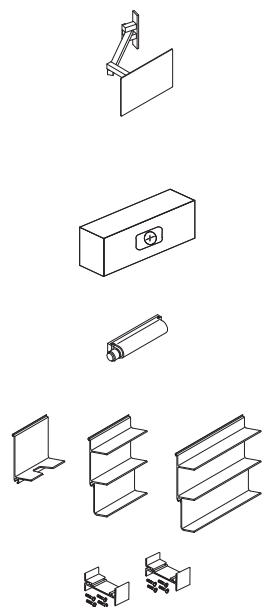

Description	Model	Price
POMM Magnifying Mirror		
Pull-Out Magnifying Mirror	POMM	\$ 229.
Magnifies at 3X and retracts neatly into cabinet		
Refer to page 272 for SOMM Magnifying Mirror.		
Safety Lock Box	SLB-*	\$ 279.
Full compartment keyed lock box in an anodized aluminum finish		
* Follow SLB with first 2 numbers (width) of cabinet model, then depth of cabinet model. Example: SLB24D4.		
Handle Kit		
Push-to-Open Mechanism	MPUSHKIT	\$ 99.
Accessory Trays		
Razor/Phone Holder	MA-TRAY2.5	\$ 29.
3" Accessory Tray	MA-TRAY3	\$ 29.
5" Accessory Tray	MA-TRAY5	\$ 29.
Ganging Kit (30"/40" H)	MGKIT	\$ 49.
Hardware required for installing 2 or 3 cabinets side-by-side		
See Bottom Kits on page 275.		

Coordinating Options:

Profiles Vertical Lights
Refer to pages 249 – 251.

Profiles Wall Mirrors
See pages 28 – 29.

Profiles Vanities
See pages 70 – 87.

Other Options:

Glass Bins
See page 272.

SEE PAGE 160 FOR TIPS AND FEATURES.

Profiles™ Framed Cabinets – 12" W x 40" H



For those who want a high-functioning styling space, that pays homage to an age gone by, the Profiles Collection offers mirrored cabinets, mirrors, vanities, and task lighting in a wide assortment of sizes and finishes to meet the unique needs of any space.

- Limitless design solutions with ability to coordinate styling space above and below the sink
- Non-Electric and Electric options
- Includes two USB charging outlets and two 120VAC outlets



Two Week Lead Time



Electrical Outlet





USB Charging



Magnetic

12" W x 40" H Cabinets

Description	Model	FRAME FINISHES	
		76, 77 Price	82, 83 Price
4" Deep (D4): 11-1/4" W x 39-3/8" H (RO: 10-1/2" W x 38-5/8" H x 4" D)			
 Non-Handed	PC1240D4TNN __	\$ 1,299.	\$ 1,429.
Left – Electric	PC1240D4TLE __	\$ 1,679.	\$ 1,799.
Right – Electric	PC1240D4TRE __	\$ 1,679.	\$ 1,799.
6" Deep (D6): 11-1/4" W x 39-3/8" H (RO: 10-1/2" W x 38-5/8" H x 6" D)			
 Non-Handed	PC1240D6TNN __	\$ 1,579.	\$ 1,679.
Left – Electric	PC1240D6TLE __	\$ 1,949.	\$ 2,079.
Right – Electric	PC1240D6TRE __	\$ 1,949.	\$ 2,079.

Cabinets

Frame Finish Options

Fill in __ designator to Model listed above with desired finish. Example: PC1240D4TLE77.

- 76 Chrome
- 77 Polished Nickel
- 82 Matte Gold
- 83 Matte Black

See Surface-Mount Kits, Accessories & Options on the following page.

Profiles™ Framed Cabinets – 12" W x 40" H

Surface-Mount Kits for 40" H Cabinets

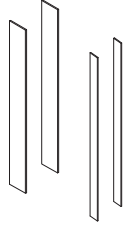

Description	Model	MIRRORED	DECORATIVE		
		Polished Edge	Stock Colors	Classic Colors	Special Order Colors
		Price	11, 20, 21 Price	22, 26, 27, 28 Price	12, 19, 23 Price
Quantity 1 = Pair of Side Kits and Mounting Hardware					
D4 Surface-Mount, Polished Edge	MSMK40D4P	\$ 249.	N/A	N/A	N/A
D4 Surface-Mount, Decorative *	MSMK40D4 __	N/A	\$ 329.	\$ 379.	\$ 429.
D6 Surface-Mount, Polished Edge	MSMK40D6P	\$ 329.	N/A	N/A	N/A
D6 Surface-Mount, Decorative *	MSMK40D6 __	N/A	\$ 379.	\$ 429.	\$ 479.
D6 Semi-Recessed, Polished Edge	MSMK40D6SRP	\$ 249.	N/A	N/A	N/A
D6 Semi-Recessed, Decorative *	MSMK40D6SR __	N/A	\$ 329.	\$ 379.	\$ 429.

Surface-Mount Kit Color Options

* Fill in __ designator to Decorative Model listed above with desired color. Example: **MSMK40D620**.

Stock Colors

- 11 Tinted Gray Mirror
- 20 Black
- 21 White

Classic Colors

- 22 Beach
- 26 Matte White
- 27 Matte Gray
- 28 Matte Black

Special Order Colors

- 12 Satin Bronze
- 19 Satin White
- 23 Ocean

Accessories & Options

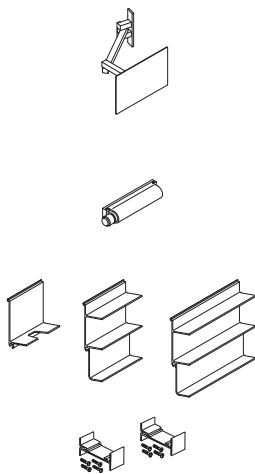

Description

POMM Magnifying Mirror

Pull-Out Magnifying Mirror POMM
Magnifies at 3X and retracts neatly into cabinet

Refer to page 272 for SOMM Magnifying Mirror.

Handle Kit

Push-to-Open Mechanism MPUSHKIT

Accessory Trays

Razor/Phone Holder MA-TRAY2.5

3" Accessory Tray MA-TRAY3

5" Accessory Tray MA-TRAY5

Ganging Kit (30"/40" H) MGKIT

Hardware required for installing 2 or 3 cabinets side-by-side

See Bottom Kits on page 275.

Price

\$ 229.

\$ 99.

\$ 29.

\$ 29.

\$ 29.

\$ 49.

Coordinating Options:

Profiles Vertical Lights
Refer to pages 249 – 251.

Profiles Wall Mirrors
See pages 28 – 29.

Profiles Vanities
See pages 70 – 87.

Other Options:

Glass Bins
See page 272.

SEE PAGE 160 FOR TIPS AND FEATURES.

Profiles™ Framed Cabinets – 16" W x 40" H



For those who want a high-functioning styling space, that pays homage to an age gone by, the Profiles Collection offers mirrored cabinets, mirrors, vanities, and task lighting in a wide assortment of sizes and finishes to meet the unique needs of any space.

- Limitless design solutions with ability to coordinate styling space above and below the sink
- Non-Electric and Electric options
- Includes two USB charging outlets and two 120VAC outlets



Two Week Lead Time

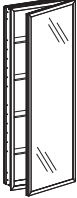
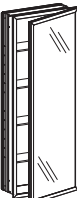

Cabinets

16" W x 40" H Cabinets		FRAME FINISHES		
		76, 77 Price	82, 83 Price	
Description	Model			
4" Deep (D4): 15-1/4" W x 39-3/8" H (RO: 14-1/2" W x 38-5/8" H x 4" D)				
	Non-Handed	PC1640D4TNN __	\$ 1,429.	\$ 1,529.
	Left – Electric	PC1640D4TLE __	\$ 1,799.	\$ 1,899.
	Right – Electric	PC1640D4TRE __	\$ 1,799.	\$ 1,899.
6" Deep (D6): 15-1/4" W x 39-3/8" H (RO: 14-1/2" W x 38-5/8" H x 6" D)				
	Non-Handed	PC1640D6TNN __	\$ 1,679.	\$ 1,799.
	Left – Electric	PC1640D6TLE __	\$ 2,079.	\$ 2,179.
	Right – Electric	PC1640D6TRE __	\$ 2,079.	\$ 2,179.

Frame Finish Options

Fill in __ designator to Model listed above with desired finish. Example: PC1640D4TRE82.

- 76 Chrome
- 77 Polished Nickel
- 82 Matte Gold
- 83 Matte Black

See Surface-Mount Kits, Accessories & Options on the following page.

Profiles™ Framed Cabinets – 16" W x 40" H

Surface-Mount Kits for 40" H Cabinets

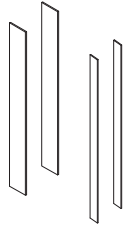

Description	Model	MIRRORED	DECORATIVE		
		Polished Edge	Stock Colors	Classic Colors	Special Order Colors
		Price	11, 20, 21 Price	22, 26, 27, 28 Price	12, 19, 23 Price
Quantity 1 = Pair of Side Kits and Mounting Hardware					
D4 Surface-Mount, Polished Edge	MSMK40D4P	\$ 249.	N/A	N/A	N/A
D4 Surface-Mount, Decorative *	MSMK40D4 __	N/A	\$ 329.	\$ 379.	\$ 429.
D6 Surface-Mount, Polished Edge	MSMK40D6P	\$ 329.	N/A	N/A	N/A
D6 Surface-Mount, Decorative *	MSMK40D6 __	N/A	\$ 379.	\$ 429.	\$ 479.
D6 Semi-Recessed, Polished Edge	MSMK40D6SRP	\$ 249.	N/A	N/A	N/A
D6 Semi-Recessed, Decorative *	MSMK40D6SR __	N/A	\$ 329.	\$ 379.	\$ 429.

Surface-Mount Kit Color Options

* Fill in __ designator to Decorative Model listed above with desired color. Example: **MSMK40D620**.

Stock Colors

- 11 Tinted Gray Mirror
- 20 Black
- 21 White

Classic Colors

- 22 Beach
- 26 Matte White
- 27 Matte Gray
- 28 Matte Black

Special Order Colors

- 12 Satin Bronze
- 19 Satin White
- 23 Ocean

Accessories & Options

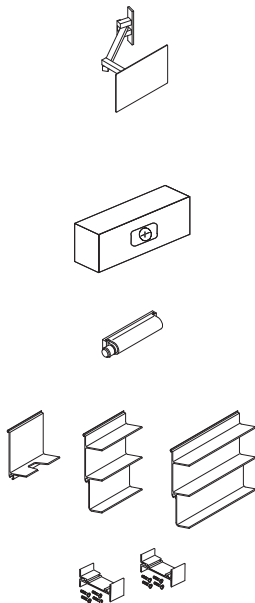

Description	Model	Price
POMM Magnifying Mirror		
Pull-Out Magnifying Mirror	POMM	\$ 229.
Magnifies at 3X and retracts neatly into cabinet		
Refer to page 272 for SOMM Magnifying Mirror.		
Safety Lock Box	SLB-*	\$ 279.
Full compartment keyed lock box in an anodized aluminum finish		
* Follow SLB with first 2 numbers (width) of cabinet model, then depth of cabinet model. Example: SLB16D4.		
Handle Kit		
Push-to-Open Mechanism	MPUSHKIT	\$ 99.
Accessory Trays		
Razor/Phone Holder	MA-TRAY2.5	\$ 29.
3" Accessory Tray	MA-TRAY3	\$ 29.
5" Accessory Tray	MA-TRAY5	\$ 29.
Ganging Kit (30"/40" H)	MGKIT	\$ 49.
Hardware required for installing 2 or 3 cabinets side-by-side		
See Bottom Kits on page 275.		

Coordinating Options:

Profiles Vertical Lights
Refer to pages 249 – 251.

Profiles Wall Mirrors
See pages 28 – 29.

Profiles Vanities
See pages 70 – 87.

Other Options:

Glass Bins
See page 272.

SEE PAGE 160 FOR TIPS AND FEATURES.

Profiles™ Framed Cabinets – 20" W x 40" H



For those who want a high-functioning styling space, that pays homage to an age gone by, the Profiles Collection offers mirrored cabinets, mirrors, vanities, and task lighting in a wide assortment of sizes and finishes to meet the unique needs of any space.

- Limitless design solutions with ability to coordinate styling space above and below the sink
- Non-Electric and Electric options
- Includes two USB charging outlets and two 120VAC outlets



Two Week Lead Time



Modular



Electrical Outlet





USB Charging

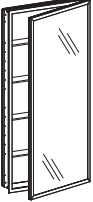

Magnetic

20" W x 40" H Cabinets

Description	Model	FRAME FINISHES	
		76, 77 Price	82, 83 Price
4" Deep (D4): 19-1/4" W x 39-3/8" H (RO: 18-1/2" W x 38-5/8" H x 4" D)			
 Non-Handed	PC2040D4TNN __	\$ 1,529.	\$ 1,629.
Left – Electric	PC2040D4TLE __	\$ 1,899.	\$ 2,029.
Right – Electric	PC2040D4TRE __	\$ 1,899.	\$ 2,029.
6" Deep (D6): 19-1/4" W x 39-3/8" H (RO: 18-1/2" W x 38-5/8" H x 6" D)			
 Non-Handed	PC2040D6TNN __	\$ 1,799.	\$ 1,899.
Left – Electric	PC2040D6TLE __	\$ 2,179.	\$ 2,279.
Right – Electric	PC2040D6TRE __	\$ 2,179.	\$ 2,279.

Frame Finish Options

Fill in __ designator to Model listed above with desired finish. Example: PC2040D6TNN76.

- 76 Chrome
- 77 Polished Nickel
- 82 Matte Gold
- 83 Matte Black

See Surface-Mount Kits, Accessories & Options on the following page.

Profiles™ Framed Cabinets – 20" W x 40" H

Surface-Mount Kits for 40" H Cabinets

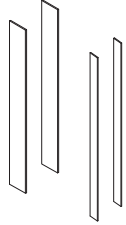

Description	Model	MIRRORED	DECORATIVE		
		Polished Edge	Stock Colors	Classic Colors	Special Order Colors
		Price	11, 20, 21 Price	22, 26, 27, 28 Price	12, 19, 23 Price
Quantity 1 = Pair of Side Kits and Mounting Hardware					
D4 Surface-Mount, Polished Edge	MSMK40D4P	\$ 249.	N/A	N/A	N/A
D4 Surface-Mount, Decorative *	MSMK40D4 __	N/A	\$ 329.	\$ 379.	\$ 429.
D6 Surface-Mount, Polished Edge	MSMK40D6P	\$ 329.	N/A	N/A	N/A
D6 Surface-Mount, Decorative *	MSMK40D6 __	N/A	\$ 379.	\$ 429.	\$ 479.
D6 Semi-Recessed, Polished Edge	MSMK40D6SRP	\$ 249.	N/A	N/A	N/A
D6 Semi-Recessed, Decorative *	MSMK40D6SR __	N/A	\$ 329.	\$ 379.	\$ 429.

Surface-Mount Kit Color Options

* Fill in __ designator to Decorative Model listed above with desired color. Example: **MSMK40D620**.

Stock Colors

- 11 Tinted Gray Mirror
- 20 Black
- 21 White

Classic Colors

- 22 Beach
- 26 Matte White
- 27 Matte Gray
- 28 Matte Black

Special Order Colors

- 12 Satin Bronze
- 19 Satin White
- 23 Ocean

Accessories & Options

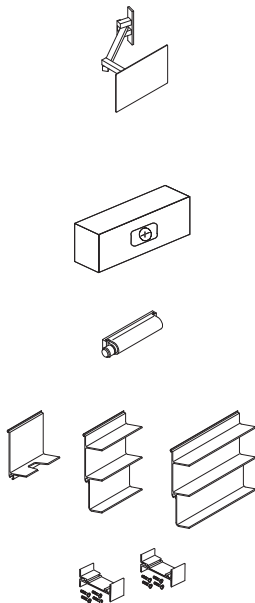

Description

Model

Price

Coordinating Options:

POMM Magnifying Mirror

Pull-Out Magnifying Mirror POMM \$ 229.
Magnifies at 3X and retracts neatly into cabinet

Refer to page 272 for SOMM Magnifying Mirror.

Safety Lock Box

SLB-* \$ 279.
Full compartment keyed lock box in an anodized aluminum finish

* Follow SLB with first 2 numbers (width) of cabinet model, then depth of cabinet model. Example: SLB20D4.

Handle Kit

MPUSHKIT \$ 99.
Push-to-Open Mechanism

Accessory Trays

MA-TRAY2.5 \$ 29.
Razor/Phone Holder

MA-TRAY3 \$ 29.
3" Accessory Tray

MA-TRAY5 \$ 29.
5" Accessory Tray

MGKIT \$ 49.
Ganging Kit (30"/40" H)

Hardware required for installing 2 or 3 cabinets side-by-side

See Bottom Kits on page 275.

Profiles Vertical Lights
Refer to pages 249 – 251.

Profiles Wall Mirrors
See pages 28 – 29.

Profiles Vanities
See pages 70 – 87.

Other Options:

Glass Bins
See page 272.

SEE PAGE 160 FOR TIPS AND FEATURES.

Profiles™ Framed Cabinets – 24" W x 40" H



For those who want a high-functioning styling space, that pays homage to an age gone by, the Profiles Collection offers mirrored cabinets, mirrors, vanities, and task lighting in a wide assortment of sizes and finishes to meet the unique needs of any space.

- Limitless design solutions with ability to coordinate styling space above and below the sink
- Non-Electric and Electric options
- Includes two USB charging outlets and two 120VAC outlets



Two Week Lead Time

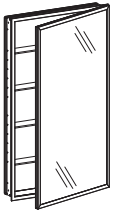
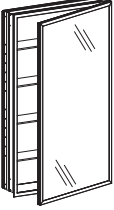

24" W x 40" H Cabinets

Description	Model	FRAME FINISHES	
		76, 77 Price	82, 83 Price
4" Deep (D4): 23-1/4" W x 39-3/8" H (RO: 22-1/2" W x 38-5/8" H x 4" D)			
 Non-Handed	PC2440D4TNN __	\$ 1,629.	\$ 1,749.
Left – Electric	PC2440D4TLE __	\$ 2,029.	\$ 2,129.
Right – Electric	PC2440D4TRE __	\$ 2,029.	\$ 2,129.
6" Deep (D6): 23-1/4" W x 39-3/8" H (RO: 22-1/2" W x 38-5/8" H x 6" D)			
 Non-Handed	PC2440D6TNN __	\$ 1,899.	\$ 2,029.
Left – Electric	PC2440D6TLE __	\$ 2,279.	\$ 2,399.
Right – Electric	PC2440D6TRE __	\$ 2,279.	\$ 2,399.

Cabinets

Frame Finish Options

Fill in __ designator to Model listed above with desired finish. Example: PC2440D6TLE83.

- 76 Chrome
- 77 Polished Nickel
- 82 Matte Gold
- 83 Matte Black

See Surface-Mount Kits, Accessories & Options on the following page.

Profiles™ Framed Cabinets – 24" W x 40" H

Surface-Mount Kits for 40" H Cabinets

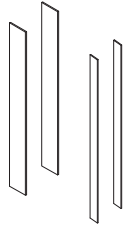

Description	Model	MIRRORED	DECORATIVE		
		Polished Edge	Stock Colors	Classic Colors	Special Order Colors
		Price	11, 20, 21 Price	22, 26, 27, 28 Price	12, 19, 23 Price
Quantity 1 = Pair of Side Kits and Mounting Hardware					
D4 Surface-Mount, Polished Edge	MSMK40D4P	\$ 249.	N/A	N/A	N/A
D4 Surface-Mount, Decorative *	MSMK40D4 __	N/A	\$ 329.	\$ 379.	\$ 429.
D6 Surface-Mount, Polished Edge	MSMK40D6P	\$ 329.	N/A	N/A	N/A
D6 Surface-Mount, Decorative *	MSMK40D6 __	N/A	\$ 379.	\$ 429.	\$ 479.
D6 Semi-Recessed, Polished Edge	MSMK40D6SRP	\$ 249.	N/A	N/A	N/A
D6 Semi-Recessed, Decorative *	MSMK40D6SR __	N/A	\$ 329.	\$ 379.	\$ 429.

Surface-Mount Kit Color Options

* Fill in __ designator to Decorative Model listed above with desired color. Example: **MSMK40D620**.

Stock Colors

- 11 Tinted Gray Mirror
- 20 Black
- 21 White

Classic Colors

- 22 Beach
- 26 Matte White
- 27 Matte Gray
- 28 Matte Black

Special Order Colors

- 12 Satin Bronze
- 19 Satin White
- 23 Ocean

Accessories & Options

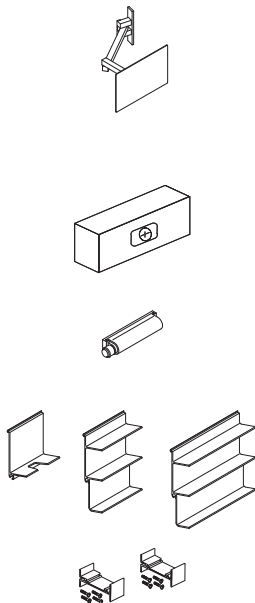

Description	Model	Price
POMM Magnifying Mirror		
Pull-Out Magnifying Mirror	POMM	\$ 229.
Magnifies at 3X and retracts neatly into cabinet		
Refer to page 272 for SOMM Magnifying Mirror.		
Safety Lock Box		
Full compartment keyed lock box in an anodized aluminum finish	SLB-*	\$ 279.
* Follow SLB with first 2 numbers (width) of cabinet model, then depth of cabinet model. Example: SLB24D4.		
Handle Kit		
Push-to-Open Mechanism	MPUSHKIT	\$ 99.
Accessory Trays		
Razor/Phone Holder	MA-TRAY2.5	\$ 29.
3" Accessory Tray	MA-TRAY3	\$ 29.
5" Accessory Tray	MA-TRAY5	\$ 29.
Ganging Kit (30"/40" H)		
Hardware required for installing 2 or 3 cabinets side-by-side	MGKIT	\$ 49.
See Bottom Kits on page 275.		

Coordinating Options:

Profiles Vertical Lights
Refer to pages 249 – 251.

Profiles Wall Mirrors
See pages 28 – 29.

Profiles Vanities
See pages 70 – 87.

Other Options:

Glass Bins
See page 272.

SEE PAGE 160 FOR TIPS AND FEATURES.

M Series Cabinets – Table of Contents

M Series Tips & Features	179
M Series Cabinet Worksheet	180
30" High Cabinets	182 – 189
12" Wide	182 – 183
16" Wide	184 – 185
20" Wide	186 – 187
24" Wide	188 – 189
40" High Cabinets	190 – 197
12" Wide	190 – 191
16" Wide	192 – 193
20" Wide	194 – 195
24" Wide	196 – 197
70" High Cabinets	198 – 201
16" Wide	198 – 199
20" Wide	200 – 201
Lighting Options	252 – 259
Cabinet Accessories	271 – 275
Cabinet Ganging Reference	145



Stock Colors



Classic and Special Order Colors

M Series Cabinets – Tips & Features

Dimensions & Weight

- Width: 11-1/4" (286 mm), 15-1/4" (387 mm), 19-1/4" (489 mm), 23-1/4" (591 mm) – 70" H cabinets available only in 15-1/4" & 19-1/4" widths
- Height: 30" flat (762 mm), 34" arch (864 mm), 39-3/8" flat (1000 mm), 43-3/8" arch (1102 mm), 70" flat (1778 mm)
- Depth: 4" (102 mm), 6" (152 mm), 8" (203 mm) (12" W cabinets available only in 4" & 6" depths)
- Net Weight (Lbs): 26 – 165 lbs

Features & Benefits

- Flat Top available in 3/4" bevel or polished edge mirror door
- Arch Top in 3/4" bevel edge mirror door
- Available in 12 decorative color options (excluding Arch Top)
- Sensor controlled interior LED light (E2, E4)
- Programmable night light (E4)
- Built-in mirror defogger prevents steaming. Turn on with a push of a button and built with a 45 minute timer (E4)
- Electric option includes one USB charging port and one 15A, 120VAC outlet (2 plugs)
- 8" deep, 70" H cabinets include chrome wire basket
- Includes magnetic tool holder (except 12" W electric options), razor/phone holder and 3 tier tray
- ETL certified to UL 962, CSA Standard C22.2 No. 68

Configurable Options

- Cabinet Styles: Flat Top, Arch Top, Full Length
- Edge Type: Polished edge or bevel edge for flat top. Arch top is bevel edge only.
- Hinge Options: left or right hinge
- Electrical Packages: non-electric, electric (E2) or electric, night light and defogger (E4)
- Decorative Glass Options: mirror, 12 decorative gloss and matte finishes

Construction

- Durable rust-free anodized aluminum and glass construction – glass resists intense moisture, ensuring long-lasting beauty
- Satin anodized aluminum body
- Quiet close Safeseal® Gasket with sealed corners on cabinet body
- 3 mirror design – rear of cabinet and both sides of door

Construction (Continued)

- Concealed finger pull-door edge
- Door opening angle 170 degrees (110 with provided stop): Blum self-closing hinges
- Adjustable shelving at 2" (51 mm) increments: 3 shelves for 30" H, 4 shelves for 40" H
- 1/4" (6 mm) thick adjustable clear glass shelves
- Magnetic area provided in the rail of the cabinet
- Arch doors extend 4" above cabinet

Installation

- Recessed, semi-recessed or surface-mount installation (6" and 8" deep cabinets can be semi-recessed by 4")
- Cabinets include hardware for recessed installation. Surface-mount and semi-recess installations require the purchase of a kit which includes the side kit as well as mounting hardware.
- Recessed cabinets project 7/8" from wall and must be recessed no less than 3-3/4" deep
- When ganging two or more 70" H full length cabinets, the use of a MHANDLEKIT or MPUSHKIT on one cabinet is required.
- MGKIT includes hardware to gang both sides of a cabinet. As a result, three cabinets can be ganged together from one MGKIT.
- All cabinets require the customer to select the hinge side for their cabinet: Left or Right = hinge side when facing cabinet.

Accessories

- Safety Lock Box (SLB-*) – not for use with 12" W cabinets
- Entice® Magnification Mirror (ENTICE, ENTICEDOCK)
- Pull-Out Magnifying Mirror (POMM)
- Swing-Out Magnifying Mirror (SOMM)
- Compact Adjustable Magnification Mirror (CAMM)
- Chrome Handle Kit (MHANDLEKIT)
- Push-to-Open Kit (MPUSHKIT)
- Glass Bins (GLASSBIN3.25, GLASSBIN5.25, GLASSBIN8.5)
- Razor/Phone Holder (MA-TRAY2.5)
- 3" and 5" Accessory Tray (MA-TRAY3, MA-TRAY5)
- Stacking Filler System (MSF-*)
- Bottom Kit (MBK__D_A, MBK__D_ASR)
- Surface-Mount Kit (MSMK30D__, MSMK40D__, MSMK70D__)
- Ganging Kit (MGKIT, MGKIT70)



Stock Colors



Classic and Special Order Colors

M Series Cabinet Worksheet

FEATURES

Select Width:

- 12"*
- 16"
- 20"
- 24"

Select Height:

- 30"
- 40"
- 70"*

Select Depth:

- 4"
- 6"
- 8"

Select Door Style:

- Flat, Bevel Edge
- Flat, Polished Edge
- Arch, Bevel Edge
- Decorative Glass Color (see selection below)

Decorative Glass Selection:

Stock Colors**

- Tinted Gray Mirror
- Black
- White

Classic Colors**

- Beach
- Matte White
- Matte Gray
- Matte Black

Special Order Colors**

- Satin Bronze
- Satin White
- Ocean
- Smoke Screen
- Silver Screen

Hinge Side:

- Left
- Right

Electric Option:

- Non-Electric (blank)
- Electric & Interior Light
- Electric, Interior Light, Night Light & Defogger

MODEL

MC

- 12
- 16
- 20
- 24

- 30
- 40
- 70

- D4
- D6
- D8

- FB
- FP
- AB
- ##

- 11
- 20
- 21

- 22
- 26
- 27
- 28

- 12
- 19
- 23
- 24
- 25

- L
- R

-
- E2
- E4

Cabinets

Notes:

- * 70" H cabinet available in 16" or 20" width only.
12" W cabinet available in 30" or 40" height,
4" or 6" depth.
- ** Stock Colors have a 2 week lead time;
all other Colors have a 4 week lead time.

CUSTOMER INFORMATION

Name

Address

City/State/Zip

Telephone

Date Ordered

M Series Cabinets – 12" W x 30" H



For the most luxurious medicine cabinet and enhanced experiences, the M Series Collection is rich with possibilities for technology, style and storage and is the most diverse line in the market. M Series cabinets can be easily grouped together or with vertical lighting to increase storage, task lighting or to create a dramatic visual effect.

- E2 – Available for all M Series cabinets. Option includes:
Sensor controlled interior LED light
Outlet shelf with USB port and 2 electrical plugs



Two Week Lead Time
(Stock Colors)



Four Week Lead Time
(Classic/Special Order Colors)



Modular



Electrical
Outlet



USB
Charging



Interior
Lighting



Magnetic



Magnifying
Mirror

12" W x 30" H Cabinets

Description	Model	MIRRORED	DECORATIVE			
		Flat Door FB, FP Price	Stock Colors 11, 20, 21 Price	Classic Colors 22, 26, 27, 28 Price	Special Order Colors 12, 19, 23, 24, 25 Price	
4" Deep (D4): 11-1/4" W x 30" H (RO: 10-1/2" W x 29-1/4" H x 4" D)						
	Left – Non-Electric	MC1230D4 __ L	\$ 829.	\$ 979.	\$ 1,149.	\$ 1,299.
	Right – Non-Electric	MC1230D4 __ R	\$ 829.	\$ 979.	\$ 1,149.	\$ 1,299.
	Left – Electric	MC1230D4 __ LE2	\$ 1,249.	\$ 1,429.	\$ 1,579.	\$ 1,749.
	Right – Electric	MC1230D4 __ RE2	\$ 1,249.	\$ 1,429.	\$ 1,579.	\$ 1,749.
6" Deep (D6): 11-1/4" W x 30" H (RO: 10-1/2" W x 29-1/4" H x 6" D)						
	Left – Non-Electric	MC1230D6 __ L	\$ 1,099.	\$ 1,249.	\$ 1,429.	\$ 1,579.
	Right – Non-Electric	MC1230D6 __ R	\$ 1,099.	\$ 1,249.	\$ 1,429.	\$ 1,579.
	Left – Electric	MC1230D6 __ LE2	\$ 1,529.	\$ 1,699.	\$ 1,849.	\$ 2,029.
	Right – Electric	MC1230D6 __ RE2	\$ 1,529.	\$ 1,699.	\$ 1,849.	\$ 2,029.



Note: Prices in **bold** indicate Quick Ship product. Applies to Polished Edge (FP) Flat Door models only.

Door Style & Color Options

Fill in __ designator to Model listed above with desired door style & color. Examples: MC1230D4FPL, MC1230D624LE2.

Cabinet Top and Door Mirrored Edge

FB Flat, Bevel Edge
FP Flat, Polished Edge

Decorative Stock Colors (Flat)

11 Tinted Gray Mirror
20 Black
21 White

Decorative Classic Colors (Flat)

22 Beach
26 Matte White
27 Matte Gray
28 Matte Black

Decorative Special Order Colors (Flat)

12 Satin Bronze
19 Satin White
23 Ocean
24 Smoke Screen
25 Silver Screen

See Surface-Mount Kits, Accessories & Options on the following page.

M Series Cabinets – 12" W x 30" H

Surface-Mount Kits for 30" H Cabinets

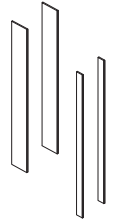

Description	Model	MIRRORED	DECORATIVE		
		Polished Edge	Stock Colors	Classic Colors	Special Order Colors
		Price	Price	Price	Price
Quantity 1 = Pair of Side Kits and Mounting Hardware					
D4 Surface-Mount, Polished Edge	MSMK30D4P	\$ 149.	N/A	N/A	N/A
D4 Surface-Mount, Decorative*	MSMK30D4 __	N/A	\$ 199.	\$ 249.	\$ 329.
D6 Surface-Mount, Polished Edge	MSMK30D6P	\$ 199.	N/A	N/A	N/A
D6 Surface-Mount, Decorative*	MSMK30D6 __	N/A	\$ 249.	\$ 329.	\$ 379.
D6 Semi-Recessed, Polished Edge	MSMK30D6SRP	\$ 149.	N/A	N/A	N/A
D6 Semi-Recessed, Decorative*	MSMK30D6SR __	N/A	\$ 199.	\$ 249.	\$ 329.

*Fill in __ designator to Decorative Model listed above with desired color. Example: **MSMK30D620**. See previous page for Decorative Color Options.

Accessories & Options

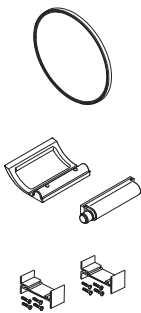

Description	Model	Price
Magnifying Mirror Compact adjustable magnification mirror	CAMM	\$ 49.
Handle Kits Chrome Handle or Push-to-Open Mechanism	MHANDLEKIT MPUSHKIT	\$ 179. \$ 99.
Ganging Kit (30"/40" H) Hardware required for installing 2 or 3 cabinets side-by-side See Bottom Kits on page 275.	MGKIT	\$ 49.

Light Options include:
Vertical Lights
Sconces
Refer to pages 252 – 259 for more information.

Other Options:
Accessory Trays & Glass Bins
See page 272.

Note: Models in **bold** indicate Quick Ship product.

SEE PAGE 179 FOR TIPS AND FEATURES.

M Series Cabinets – 16" W x 30" H



For the most luxurious medicine cabinet and enhanced experiences, the M Series Collection is rich with possibilities for technology, style and storage and is the most diverse line in the market. M Series cabinets can be easily grouped together or with vertical lighting to increase storage, task lighting or to create a dramatic visual effect.

- E2 – Available for all M Series cabinets. Option includes:
Sensor controlled interior LED light; Outlet shelf with USB port and 2 electrical plugs
- E4 – Available for 16" W, 20" W and 24" W medicine cabinets. Option includes:
Sensor controlled interior LED light; Outlet shelf with USB port and 2 electrical plugs;
Programmable night light; Defogger with 45 minute timer



Two Week Lead Time
(Stock Colors)



Four Week Lead Time
(Classic/Special Order Colors)



Modular



Defogger



Electrical
Outlet



Night
Light



USB
Charging



Interior
Lighting



Magnetic



Magnifying
Mirror

16" W x 30" H Cabinets

Description	Model	MIRRORED		DECORATIVE (Flat Door only)			
		Flat Door FB, FP Price	Arch Door AB Price	Stock Colors 11, 20, 21 Price	Classic Colors 22, 26, 27, 28 Price	Special Colors 12, 19, 23, 24, 25 Price	
4" Deep (D4): 15-1/4" W x 30" H Flat, 34" H Arch (RO: 14-1/2" W x 29-1/4" H x 4" D)							
	Left – Non-Electric	MC1630D4 __ L	\$ 929.	\$ 1,199.	\$ 1,149.	\$ 1,379.	\$ 1,579.
	Right – Non-Electric	MC1630D4 __ R	\$ 929.	\$ 1,199.	\$ 1,149.	\$ 1,379.	\$ 1,579.
	Left – Electric	MC1630D4 __ LE2	\$ 1,379.	\$ 1,649.	\$ 1,579.	\$ 1,799.	\$ 2,029.
	Right – Electric	MC1630D4 __ RE2	\$ 1,379.	\$ 1,649.	\$ 1,579.	\$ 1,799.	\$ 2,029.
	Left – Electric + Night Light, Defogger	MC1630D4 __ LE4	\$ 1,699.	\$ 1,979.	N/A	N/A	N/A
	Right – Electric + Night Light, Defogger	MC1630D4 __ RE4	\$ 1,699.	\$ 1,979.	N/A	N/A	N/A
6" Deep (D6): 15-1/4" W x 30" H Flat, 34" H Arch (RO: 14-1/2" W x 29-1/4" H x 6" D)							
	Left – Non-Electric	MC1630D6 __ L	\$ 1,199.	\$ 1,479.	\$ 1,429.	\$ 1,649.	\$ 1,849.
	Right – Non-Electric	MC1630D6 __ R	\$ 1,199.	\$ 1,479.	\$ 1,429.	\$ 1,649.	\$ 1,849.
	Left – Electric	MC1630D6 __ LE2	\$ 1,649.	\$ 1,929.	\$ 1,849.	\$ 2,079.	\$ 2,299.
	Right – Electric	MC1630D6 __ RE2	\$ 1,649.	\$ 1,929.	\$ 1,849.	\$ 2,079.	\$ 2,299.
	Left – Electric + Night Light, Defogger	MC1630D6 __ LE4	\$ 1,979.	\$ 2,249.	N/A	N/A	N/A
	Right – Electric + Night Light, Defogger	MC1630D6 __ RE4	\$ 1,979.	\$ 2,249.	N/A	N/A	N/A
8" Deep (D8): 15-1/4" W x 30" H Flat, 34" H Arch (RO: 14-1/2" W x 29-1/4" H x 8" D)							
	Left – Non-Electric	MC1630D8 __ L	\$ 1,299.	\$ 1,579.	\$ 1,529.	\$ 1,749.	\$ 1,979.
	Right – Non-Electric	MC1630D8 __ R	\$ 1,299.	\$ 1,579.	\$ 1,529.	\$ 1,749.	\$ 1,979.
	Left – Electric	MC1630D8 __ LE2	\$ 1,749.	\$ 2,029.	\$ 1,979.	\$ 2,199.	\$ 2,399.
	Right – Electric	MC1630D8 __ RE2	\$ 1,749.	\$ 2,029.	\$ 1,979.	\$ 2,199.	\$ 2,399.
	Left – Electric + Night Light, Defogger	MC1630D8 __ LE4	\$ 2,079.	\$ 2,349.	N/A	N/A	N/A
	Right – Electric + Night Light, Defogger	MC1630D8 __ RE4	\$ 2,079.	\$ 2,349.	N/A	N/A	N/A



Note: Prices in **bold** indicate Quick Ship product. Applies to Polished Edge (FP) Flat Door models only.

Fill in __ designator to Model listed above with desired door style & color listed on the following page.
Examples: MC1630D4**FPL**, MC1630D8**24LE2**.

See Cabinet Door Style & Color Options, Surface-Mount Kits, Accessories & Options on the following page.

M Series Cabinets – 16" W x 30" H

Door Style & Color Options

Fill in __ designator to Model listed at left with desired door style & color. Examples: **MC1630D4FPL**, **MC1630D824LE2**.

Cabinet Top and Door Mirrored Edge

FB	Flat, Bevel Edge
FP	 Flat, Polished Edge
AB	Arch, Bevel Edge

Decorative Stock Colors (Flat)

11	Tinted Gray Mirror
20	Black
21	White

Decorative Classic Colors (Flat)

22	Beach
26	Matte White
27	Matte Gray
28	Matte Black

Decorative Special Order Colors (Flat)

12	Satin Bronze
19	Satin White
23	Ocean
24	Smoke Screen
25	Silver Screen

Surface-Mount Kits for 30" H Cabinets

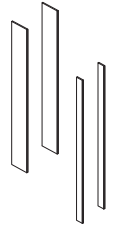

Description	Model	MIRRORED			
		Polished Edge	Stock Colors	Classic Colors	Special Order Colors
		Price	Price	Price	Price
Quantity 1 = Pair of Side Kits and Mounting Hardware					
D4 Surface-Mount, Polished Edge	MSMK30D4P	\$ 149.	N/A	N/A	N/A
D4 Surface-Mount, Decorative*	MSMK30D4 __	N/A	\$ 199.	\$ 249.	\$ 329.
D6 Surface-Mount, Polished Edge	MSMK30D6P	\$ 199.	N/A	N/A	N/A
D6 Surface-Mount, Decorative*	MSMK30D6 __	N/A	\$ 249.	\$ 329.	\$ 379.
D6 Semi-Recessed, Polished Edge	MSMK30D6SRP	\$ 149.	N/A	N/A	N/A
D6 Semi-Recessed, Decorative*	MSMK30D6SR __	N/A	\$ 199.	\$ 249.	\$ 329.
D8 Surface-Mount, Polished Edge	MSMK30D8P	\$ 249.	N/A	N/A	N/A
D8 Surface-Mount, Decorative*	MSMK30D8 __	N/A	\$ 329.	\$ 379.	\$ 429.
D8 Semi-Recessed, Polished Edge	MSMK30D8SRP	\$ 149.	N/A	N/A	N/A
D8 Semi-Recessed, Decorative*	MSMK30D8SR __	N/A	\$ 199.	\$ 249.	\$ 329.

* Fill in __ designator to Decorative Model listed above with desired color listed above. Example: **MSMK30D620**.

Accessories & Options

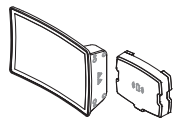

Description	Model	Price
Entice. Entice magnification mirror	ENTICE	\$ 449.
Entice magnification mirror with inductive charging dock	ENTICEDOCK	\$ 499.

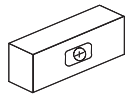

Safety Lock Box Full compartment keyed lock box in an anodized aluminum finish	SLB-*	\$ 279.
* Follow SLB with first 2 numbers (width) of cabinet model, then depth of cabinet model. Example: SLB16D4.		

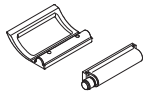

Handle Kits Chrome Handle	MHANDLEKIT	\$ 179.
or Push-to-Open Mechanism	MPUSHKIT	\$ 99.



Ganging Kit (30"/40" H) Hardware required for installing 2 or 3 cabinets side-by-side	MGKIT	\$ 49.
See Bottom Kits on page 275.		

Light Options include:
Vertical Lights
Sconces
Refer to pages 252 – 259 for more information.

Other Options:
Magnifying Mirror: POMM, SOMM, CAMM
See page 272.
Accessory Trays & Glass Bins
See page 272.

 **Note:** Models in **bold** indicate Quick Ship product.

SEE PAGE 179 FOR TIPS AND FEATURES.

M Series Cabinets – 20" W x 30" H



For the most luxurious medicine cabinet and enhanced experiences, the M Series Collection is rich with possibilities for technology, style and storage and is the most diverse line in the market. M Series cabinets can be easily grouped together or with vertical lighting to increase storage, task lighting or to create a dramatic visual effect.

- E2 – Available for all M Series cabinets. Option includes:
Sensor controlled interior LED light; Outlet shelf with USB port and 2 electrical plugs
- E4 – Available for 16" W, 20" W and 24" W medicine cabinets. Option includes:
Sensor controlled interior LED light; Outlet shelf with USB port and 2 electrical plugs;
Programmable night light; Defogger with 45 minute timer



20" W x 30" H Cabinets

Description	Model	MIRRORED		DECORATIVE (Flat Door only)			
		Flat Door FB, FP Price	Arch Door AB Price	Stock Colors 11, 20, 21 Price	Classic Colors 22, 26, 27, 28 Price	Special Colors 12, 19, 23, 24, 25 Price	
4" Deep (D4): 19-1/4" W x 30" H Flat, 34" H Arch (RO: 18-1/2" W x 29-1/4" H x 4" D)							
	Left – Non-Electric	MC2030D4 __ L	\$ 1,099.	\$ 1,379.	\$ 1,379.	\$ 1,649.	\$ 1,929.
	Right – Non-Electric	MC2030D4 __ R	\$ 1,099.	\$ 1,379.	\$ 1,379.	\$ 1,649.	\$ 1,929.
	Left – Electric	MC2030D4 __ LE2	\$ 1,529.	\$ 1,799.	\$ 1,799.	\$ 2,079.	\$ 2,349.
	Right – Electric	MC2030D4 __ RE2	\$ 1,529.	\$ 1,799.	\$ 1,799.	\$ 2,079.	\$ 2,349.
	Left – Electric + Night Light, Defogger	MC2030D4 __ LE4	\$ 1,849.	\$ 2,129.	N/A	N/A	N/A
	Right – Electric + Night Light, Defogger	MC2030D4 __ RE4	\$ 1,849.	\$ 2,129.	N/A	N/A	N/A
6" Deep (D6): 19-1/4" W x 30" H Flat, 34" H Arch (RO: 18-1/2" W x 29-1/4" H x 6" D)							
	Left – Non-Electric	MC2030D6 __ L	\$ 1,379.	\$ 1,649.	\$ 1,649.	\$ 1,929.	\$ 2,199.
	Right – Non-Electric	MC2030D6 __ R	\$ 1,379.	\$ 1,649.	\$ 1,649.	\$ 1,929.	\$ 2,199.
	Left – Electric	MC2030D6 __ LE2	\$ 1,799.	\$ 2,079.	\$ 2,079.	\$ 2,349.	\$ 2,629.
	Right – Electric	MC2030D6 __ RE2	\$ 1,799.	\$ 2,079.	\$ 2,079.	\$ 2,349.	\$ 2,629.
	Left – Electric + Night Light, Defogger	MC2030D6 __ LE4	\$ 2,129.	\$ 2,399.	N/A	N/A	N/A
	Right – Electric + Night Light, Defogger	MC2030D6 __ RE4	\$ 2,129.	\$ 2,399.	N/A	N/A	N/A
8" Deep (D8): 19-1/4" W x 30" H Flat, 34" H Arch (RO: 18-1/2" W x 29-1/4" H x 8" D)							
	Left – Non-Electric	MC2030D8 __ L	\$ 1,479.	\$ 1,749.	\$ 1,749.	\$ 2,029.	\$ 2,299.
	Right – Non-Electric	MC2030D8 __ R	\$ 1,479.	\$ 1,749.	\$ 1,749.	\$ 2,029.	\$ 2,299.
	Left – Electric	MC2030D8 __ LE2	\$ 1,929.	\$ 2,199.	\$ 2,199.	\$ 2,449.	\$ 2,729.
	Right – Electric	MC2030D8 __ RE2	\$ 1,929.	\$ 2,199.	\$ 2,199.	\$ 2,449.	\$ 2,729.
	Left – Electric + Night Light, Defogger	MC2030D8 __ LE4	\$ 2,249.	\$ 2,529.	N/A	N/A	N/A
	Right – Electric + Night Light, Defogger	MC2030D8 __ RE4	\$ 2,249.	\$ 2,529.	N/A	N/A	N/A

Note: Prices in **bold** indicate Quick Ship product. Applies to Polished Edge (FP) Flat Door models only.

**Fill in __ designator to Model listed above with desired door style & color listed on the following page.
Examples: MC2030D4**FP**L, MC2030D8**24**LE2.**

See Cabinet Door Style & Color Options, Surface-Mount Kits, Accessories & Options on the following page.

M Series Cabinets – 20" W x 30" H

Door Style & Color Options

Fill in __ designator to Model listed at left with desired door style & color. Examples: **MC2030D4FPL**, **MC2030D824LE2**.

Cabinet Top and Door Mirrored Edge

FB	Flat, Bevel Edge
FP	 Flat, Polished Edge
AB	Arch, Bevel Edge

Decorative Stock Colors (Flat)

11	Tinted Gray Mirror
20	Black
21	White

Decorative Classic Colors (Flat)

22	Beach
26	Matte White
27	Matte Gray
28	Matte Black

Decorative Special Order Colors (Flat)

12	Satin Bronze
19	Satin White
23	Ocean
24	Smoke Screen
25	Silver Screen

Surface-Mount Kits for 30" H Cabinets

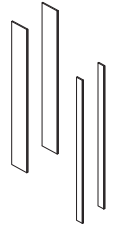

Description	Model	MIRRORED			
		Polished Edge	Stock Colors	Classic Colors	Special Order Colors
		Price	11, 20, 21 Price	22, 26, 27, 28 Price	12, 19, 23, 24, 25 Price
Quantity 1 = Pair of Side Kits and Mounting Hardware					
D4 Surface-Mount, Polished Edge	MSMK30D4P	\$ 149.	N/A	N/A	N/A
D4 Surface-Mount, Decorative*	MSMK30D4 __	N/A	\$ 199.	\$ 249.	\$ 329.
D6 Surface-Mount, Polished Edge	MSMK30D6P	\$ 199.	N/A	N/A	N/A
D6 Surface-Mount, Decorative*	MSMK30D6 __	N/A	\$ 249.	\$ 329.	\$ 379.
D6 Semi-Recessed, Polished Edge	MSMK30D6SRP	\$ 149.	N/A	N/A	N/A
D6 Semi-Recessed, Decorative*	MSMK30D6SR __	N/A	\$ 199.	\$ 249.	\$ 329.
D8 Surface-Mount, Polished Edge	MSMK30D8P	\$ 249.	N/A	N/A	N/A
D8 Surface-Mount, Decorative*	MSMK30D8 __	N/A	\$ 329.	\$ 379.	\$ 429.
D8 Semi-Recessed, Polished Edge	MSMK30D8SRP	\$ 149.	N/A	N/A	N/A
D8 Semi-Recessed, Decorative*	MSMK30D8SR __	N/A	\$ 199.	\$ 249.	\$ 329.

* Fill in __ designator to Decorative Model listed above with desired color listed above. Example: **MSMK30D620**.

Accessories & Options

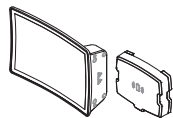

Description	Model	Price
Entice. Entice magnification mirror	ENTICE	\$ 449.
Entice magnification mirror with inductive charging dock	ENTICEDOCK	\$ 499.

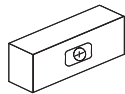

Safety Lock Box Full compartment keyed lock box in an anodized aluminum finish	SLB-*	\$ 279.
--	--------------	---------

* Follow SLB with first 2 numbers (width) of cabinet model, then depth of cabinet model. Example: SLB20D6.

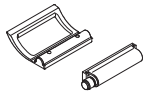

Handle Kits Chrome Handle or Push-to-Open Mechanism	MHANDLEKIT MPUSHKIT	\$ 179. \$ 99.
---	--	-----------------------



Ganging Kit (30"/40" H) Hardware required for installing 2 or 3 cabinets side-by-side	MGKIT	\$ 49.
---	--------------	--------

See Bottom Kits on page 275.

Light Options include:
Vertical Lights
Sconces
Refer to pages 252 – 259 for more information.

Other Options:
Magnifying Mirror:
POMM, SOMM, CAMM
See page 272.
Accessory Trays & Glass Bins
See page 272.

 **Note:** Models in **bold** indicate Quick Ship product.

SEE PAGE 179 FOR TIPS AND FEATURES.

M Series Cabinets – 24" W x 30" H



For the most luxurious medicine cabinet and enhanced experiences, the M Series Collection is rich with possibilities for technology, style and storage and is the most diverse line in the market. M Series cabinets can be easily grouped together or with vertical lighting to increase storage, task lighting or to create a dramatic visual effect.

- E2 – Available for all M Series cabinets. Option includes:
Sensor controlled interior LED light; Outlet shelf with USB port and 2 electrical plugs
- E4 – Available for 16" W, 20" W and 24" W medicine cabinets. Option includes:
Sensor controlled interior LED light; Outlet shelf with USB port and 2 electrical plugs;
Programmable night light; Defogger with 45 minute timer



Two Week Lead Time
(Stock Colors)



Four Week Lead Time
(Classic/Special Order Colors)



Modular



Defogger



Electrical
Outlet



Night
Light



USB
Charging



Interior
Lighting



Magnetic



Magnifying
Mirror

24" W x 30" H Cabinets

Description	Model	MIRRORED		DECORATIVE (Flat Door only)			
		Flat Door FB, FP Price	Arch Door AB Price	Stock Colors 11, 20, 21 Price	Classic Colors 22, 26, 27, 28 Price	Special Colors 12, 19, 23, 24, 25 Price	
4" Deep (D4): 23-1/4" W x 30" H Flat, 34" H Arch (RO: 22-1/2" W x 29-1/4" H x 4" D)							
	Left – Non-Electric	MC2430D4 __ L	\$ 1,149.	\$ 1,429.	\$ 1,429.	\$ 1,699.	\$ 1,979.
	Right – Non-Electric	MC2430D4 __ R	\$ 1,149.	\$ 1,429.	\$ 1,429.	\$ 1,699.	\$ 1,979.
	Left – Electric	MC2430D4 __ LE2	\$ 1,579.	\$ 1,849.	\$ 1,849.	\$ 2,129.	\$ 2,399.
	Right – Electric	MC2430D4 __ RE2	\$ 1,579.	\$ 1,849.	\$ 1,849.	\$ 2,129.	\$ 2,399.
	Left – Electric + Night Light, Defogger	MC2430D4 __ LE4	\$ 1,929.	\$ 2,199.	N/A	N/A	N/A
	Right – Electric + Night Light, Defogger	MC2430D4 __ RE4	\$ 1,929.	\$ 2,199.	N/A	N/A	N/A
6" Deep (D6): 23-1/4" W x 30" H Flat, 34" H Arch (RO: 22-1/2" W x 29-1/4" H x 6" D)							
	Left – Non-Electric	MC2430D6 __ L	\$ 1,429.	\$ 1,699.	\$ 1,699.	\$ 1,979.	\$ 2,249.
	Right – Non-Electric	MC2430D6 __ R	\$ 1,429.	\$ 1,699.	\$ 1,699.	\$ 1,979.	\$ 2,249.
	Left – Electric	MC2430D6 __ LE2	\$ 1,849.	\$ 2,129.	\$ 2,129.	\$ 2,399.	\$ 2,679.
	Right – Electric	MC2430D6 __ RE2	\$ 1,849.	\$ 2,129.	\$ 2,129.	\$ 2,399.	\$ 2,679.
	Left – Electric + Night Light, Defogger	MC2430D6 __ LE4	\$ 2,199.	\$ 2,449.	N/A	N/A	N/A
	Right – Electric + Night Light, Defogger	MC2430D6 __ RE4	\$ 2,199.	\$ 2,449.	N/A	N/A	N/A
8" Deep (D8): 23-1/4" W x 30" H Flat, 34" H Arch (RO: 22-1/2" W x 29-1/4" H x 8" D)							
	Left – Non-Electric	MC2430D8 __ L	\$ 1,529.	\$ 1,799.	\$ 1,799.	\$ 2,079.	\$ 2,349.
	Right – Non-Electric	MC2430D8 __ R	\$ 1,529.	\$ 1,799.	\$ 1,799.	\$ 2,079.	\$ 2,349.
	Left – Electric	MC2430D8 __ LE2	\$ 1,979.	\$ 2,249.	\$ 2,249.	\$ 2,529.	\$ 2,799.
	Right – Electric	MC2430D8 __ RE2	\$ 1,979.	\$ 2,249.	\$ 2,249.	\$ 2,529.	\$ 2,799.
	Left – Electric + Night Light, Defogger	MC2430D8 __ LE4	\$ 2,299.	\$ 2,579.	N/A	N/A	N/A
	Right – Electric + Night Light, Defogger	MC2430D8 __ RE4	\$ 2,299.	\$ 2,579.	N/A	N/A	N/A



Note: Prices in **bold** indicate Quick Ship product. Applies to Polished Edge (FP) Flat Door models only.

Fill in __ designator to Model listed above with desired door style & color listed on the following page.
Examples: MC2430D4**FPL**, MC2430D8**24LE2**.

See Cabinet Door Style & Color Options, Surface-Mount Kits, Accessories & Options on the following page.

M Series Cabinets – 24" W x 30" H

Door Style & Color Options

Fill in __ designator to Model listed at left with desired door style & color. Examples: MC2430D4FPL, MC2430D824LE2.

Cabinet Top and Door Mirrored Edge

FB	Flat, Bevel Edge
FP	 Flat, Polished Edge
AB	Arch, Bevel Edge

Decorative Stock Colors (Flat)

11	Tinted Gray Mirror
20	Black
21	White

Decorative Classic Colors (Flat)

22	Beach
26	Matte White
27	Matte Gray
28	Matte Black

Decorative Special Order Colors (Flat)

12	Satin Bronze
19	Satin White
23	Ocean
24	Smoke Screen
25	Silver Screen

Surface-Mount Kits for 30" H Cabinets

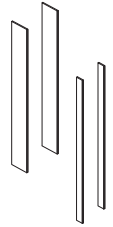

Description	Model	DECORATIVE			
		MIRRORED Polished Edge Price	Stock Colors Price	Classic Colors Price	Special Order Colors Price
Quantity 1 = Pair of Side Kits and Mounting Hardware					
D4 Surface-Mount, Polished Edge	MSMK30D4P	\$ 149.	N/A	N/A	N/A
D4 Surface-Mount, Decorative*	MSMK30D4 __	N/A	\$ 199.	\$ 249.	\$ 329.
D6 Surface-Mount, Polished Edge	MSMK30D6P	\$ 199.	N/A	N/A	N/A
D6 Surface-Mount, Decorative*	MSMK30D6 __	N/A	\$ 249.	\$ 329.	\$ 379.
D6 Semi-Recessed, Polished Edge	MSMK30D6SRP	\$ 149.	N/A	N/A	N/A
D6 Semi-Recessed, Decorative*	MSMK30D6SR __	N/A	\$ 199.	\$ 249.	\$ 329.
D8 Surface-Mount, Polished Edge	MSMK30D8P	\$ 249.	N/A	N/A	N/A
D8 Surface-Mount, Decorative*	MSMK30D8 __	N/A	\$ 329.	\$ 379.	\$ 429.
D8 Semi-Recessed, Polished Edge	MSMK30D8SRP	\$ 149.	N/A	N/A	N/A
D8 Semi-Recessed, Decorative*	MSMK30D8SR __	N/A	\$ 199.	\$ 249.	\$ 329.

*Fill in __ designator to Decorative Model listed above with desired color listed above. Example: MSMK30D620.

Accessories & Options

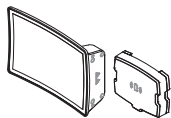

Description	Model	Price
Entice. Entice magnification mirror	ENTICE	\$ 449.
Entice magnification mirror with inductive charging dock	ENTICEDOCK	\$ 499.

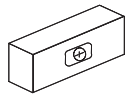

Safety Lock Box Full compartment keyed lock box in an anodized aluminum finish	SLB-*	\$ 279.
--	--------------	---------

* Follow SLB with first 2 numbers (width) of cabinet model, then depth of cabinet model. Example: SLB24D8.

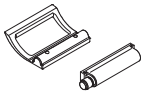

Handle Kits Chrome Handle or Push-to-Open Mechanism	MHANDLEKIT MPUSHKIT	\$ 179. \$ 99.
---	--	-----------------------



Ganging Kit (30"/40" H) Hardware required for installing 2 or 3 cabinets side-by-side	MGKIT	\$ 49.
---	--------------	--------

See Bottom Kits on page 275.

Light Options include:
Vertical Lights
Sconces
Refer to pages 252 – 259 for more information.

Other Options:
Magnifying Mirror:
POMM, SOMM, CAMM
See page 272.
Accessory Trays & Glass Bins
See page 272.

 **Note:** Models in **bold** indicate Quick Ship product.

SEE PAGE 179 FOR TIPS AND FEATURES.

M Series Cabinets – 12" W x 40" H



For the most luxurious medicine cabinet and enhanced experiences, the M Series Collection is rich with possibilities for technology, style and storage and is the most diverse line in the market. M Series cabinets can be easily grouped together or with vertical lighting to increase storage, task lighting or to create a dramatic visual effect.

- E2 – Available for all M Series cabinets. Option includes:
Sensor controlled interior LED light
Outlet shelf with USB port and 2 electrical plugs

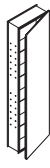
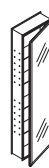
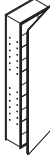
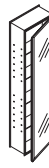

12" W x 40" H Cabinets

Description	Model	MIRRORED	DECORATIVE		
		Flat Door FB, FP Price	Stock Colors 11, 20, 21 Price	Classic Colors 22, 26, 27, 28 Price	Special Order Colors 12, 19, 23, 24, 25 Price
4" Deep (D4): 11-1/4" W x 39-3/8" H (RO: 10-1/2" W x 38-5/8" H x 4" D)					
 Left – Non-Electric	MC1240D4 __ L	\$ 1,149.	\$ 1,379.	\$ 1,579.	\$ 1,799.
 Right – Non-Electric	MC1240D4 __ R	\$ 1,149.	\$ 1,379.	\$ 1,579.	\$ 1,799.
Left – Electric	MC1240D4 __ LE2	\$ 1,579.	\$ 1,799.	\$ 2,029.	\$ 2,249.
Right – Electric	MC1240D4 __ RE2	\$ 1,579.	\$ 1,799.	\$ 2,029.	\$ 2,249.
6" Deep (D6): 11-1/4" W x 39-3/8" H (RO: 10-1/2" W x 38-5/8" H x 6" D)					
 Left – Non-Electric	MC1240D6 __ L	\$ 1,429.	\$ 1,649.	\$ 1,849.	\$ 2,079.
 Right – Non-Electric	MC1240D6 __ R	\$ 1,429.	\$ 1,649.	\$ 1,849.	\$ 2,079.
Left – Electric	MC1240D6 __ LE2	\$ 1,849.	\$ 2,079.	\$ 2,299.	\$ 2,529.
Right – Electric	MC1240D6 __ RE2	\$ 1,849.	\$ 2,079.	\$ 2,299.	\$ 2,529.

 **Note:** Prices in **bold** indicate Quick Ship product. Applies to Polished Edge (FP) Flat Door models only.

Door Style & Color Options

Fill in __ designator to Model listed above with desired door style & color. Examples: MC1240D4FPL, MC1240D624LE2.

Cabinet Top and Door Mirrored Edge

- FB Flat, Bevel Edge
FP  Flat, Polished Edge

Decorative Stock Colors (Flat)

- 11 Tinted Gray Mirror
20 Black
21 White

Decorative Classic Colors (Flat)

- 22 Beach
26 Matte White
27 Matte Gray
28 Matte Black

Decorative Special Order Colors (Flat)

- 12 Satin Bronze
19 Satin White
23 Ocean
24 Smoke Screen
25 Silver Screen

See Surface-Mount Kits, Accessories & Options on the following page.

M Series Cabinets – 12" W x 40" H



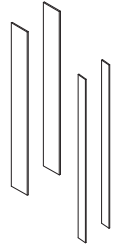

Surface-Mount Kits for 40" H Cabinets

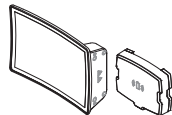

Description	Model	MIRRORED	DECORATIVE		
		Polished Edge	Stock Colors	Classic Colors	Special Order Colors
		Price	Price	Price	Price
Quantity 1 = Pair of Side Kits and Mounting Hardware					
D4 Surface-Mount, Polished Edge	MSMK40D4P	\$ 249.	N/A	N/A	N/A
D4 Surface-Mount, Decorative*	MSMK40D4 __	N/A	\$ 329.	\$ 379.	\$ 429.
D6 Surface-Mount, Polished Edge	MSMK40D6P	\$ 329.	N/A	N/A	N/A
D6 Surface-Mount, Decorative*	MSMK40D6 __	N/A	\$ 379.	\$ 429.	\$ 479.
D6 Semi-Recessed, Polished Edge	MSMK40D6SRP	\$ 249.	N/A	N/A	N/A
D6 Semi-Recessed, Decorative*	MSMK40D6SR __	N/A	\$ 329.	\$ 379.	\$ 429.

*Fill in __ designator to Decorative Model listed above with desired color. Example: **MSMK40D620**. See previous page for Decorative Color Options.

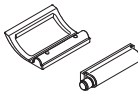
Accessories & Options

Description	Model	Price
 Entice magnification mirror	ENTICE	\$ 449.
 Entice magnification mirror with inductive charging dock	ENTICEDOCK	\$ 499.
 Magnifying Mirror Compact adjustable magnification mirror	CAMM	\$ 49.
 Handle Kits Chrome Handle or Push-to-Open Mechanism	MHANDLEKIT MPUSHKIT	\$ 179. \$ 99.
 Ganging Kit (30"/40" H) Hardware required for installing 2 or 3 cabinets side-by-side See Bottom Kits on page 275.	MGKIT	\$ 49.

Light Options include:
Vertical Lights
Sconces
Refer to pages 252 – 259 for more information.

Other Options:
Accessory Trays & Glass Bins
See page 272.

 **Note:** Models in **bold** indicate Quick Ship product.

SEE PAGE 179 FOR TIPS AND FEATURES.

M Series Cabinets – 16" W x 40" H



For the most luxurious medicine cabinet and enhanced experiences, the M Series Collection is rich with possibilities for technology, style and storage and is the most diverse line in the market. M Series cabinets can be easily grouped together or with vertical lighting to increase storage, task lighting or to create a dramatic visual effect.

- E2 – Available for all M Series cabinets. Option includes: Sensor controlled interior LED light; Outlet shelf with USB port and 2 electrical plugs
- E4 – Available for 16" W, 20" W and 24" W medicine cabinets. Option includes: Sensor controlled interior LED light; Outlet shelf with USB port and 2 electrical plugs; Programmable night light; Defogger with 45 minute timer



Two Week Lead Time (Stock Colors)



Four Week Lead Time (Classic/Special Order Colors)



Modular



Defogger



Electrical Outlet



Night Light



USB Charging



Interior Lighting



Magnetic



Magnifying Mirror

16" W x 40" H Cabinets

Description	Model	MIRRORED		DECORATIVE (Flat Door only)			
		Flat Door FB, FP Price	Arch Door AB Price	Stock Colors 11, 20, 21 Price	Classic Colors 22, 26, 27, 28 Price	Special Order Colors 12, 19, 23, 24, 25 Price	
4" Deep (D4): 15-1/4" W x 39-3/8" H Flat, 43-3/8" H Arch (RO: 14-1/2" W x 38-5/8" H x 4" D)							
	Left – Non-Electric	MC1640D4 __ L	\$ 1,249.	\$ 1,529.	\$ 1,529.	\$ 1,799.	\$ 2,079.
	Right – Non-Electric	MC1640D4 __ R	\$ 1,249.	\$ 1,529.	\$ 1,529.	\$ 1,799.	\$ 2,079.
	Left – Electric	MC1640D4 __ LE2	\$ 1,699.	\$ 1,979.	\$ 1,979.	\$ 2,249.	\$ 2,529.
	Right – Electric	MC1640D4 __ RE2	\$ 1,699.	\$ 1,979.	\$ 1,979.	\$ 2,249.	\$ 2,529.
	Left – Electric + Night Light, Defogger	MC1640D4 __ LE4	\$ 2,029.	\$ 2,299.	N/A	N/A	N/A
	Right – Electric + Night Light, Defogger	MC1640D4 __ RE4	\$ 2,029.	\$ 2,299.	N/A	N/A	N/A
6" Deep (D6): 15-1/4" W x 39-3/8" H Flat, 43-3/8" H Arch (RO: 14-1/2" W x 38-5/8" H x 6" D)							
	Left – Non-Electric	MC1640D6 __ L	\$ 1,529.	\$ 1,799.	\$ 1,799.	\$ 2,079.	\$ 2,349.
	Right – Non-Electric	MC1640D6 __ R	\$ 1,529.	\$ 1,799.	\$ 1,799.	\$ 2,079.	\$ 2,349.
	Left – Electric	MC1640D6 __ LE2	\$ 1,979.	\$ 2,249.	\$ 2,249.	\$ 2,529.	\$ 2,799.
	Right – Electric	MC1640D6 __ RE2	\$ 1,979.	\$ 2,249.	\$ 2,249.	\$ 2,529.	\$ 2,799.
	Left – Electric + Night Light, Defogger	MC1640D6 __ LE4	\$ 2,299.	\$ 2,579.	N/A	N/A	N/A
	Right – Electric + Night Light, Defogger	MC1640D6 __ RE4	\$ 2,299.	\$ 2,579.	N/A	N/A	N/A
8" Deep (D8): 15-1/4" W x 39-3/8" H Flat, 43-3/8" H Arch (RO: 14-1/2" W x 38-5/8" H x 8" D)							
	Left – Non-Electric	MC1640D8 __ L	\$ 1,649.	\$ 1,929.	\$ 1,929.	\$ 2,199.	\$ 2,449.
	Right – Non-Electric	MC1640D8 __ R	\$ 1,649.	\$ 1,929.	\$ 1,929.	\$ 2,199.	\$ 2,449.
	Left – Electric	MC1640D8 __ LE2	\$ 2,079.	\$ 2,349.	\$ 2,349.	\$ 2,629.	\$ 2,899.
	Right – Electric	MC1640D8 __ RE2	\$ 2,079.	\$ 2,349.	\$ 2,349.	\$ 2,629.	\$ 2,899.
	Left – Electric + Night Light, Defogger	MC1640D8 __ LE4	\$ 2,399.	\$ 2,679.	N/A	N/A	N/A
	Right – Electric + Night Light, Defogger	MC1640D8 __ RE4	\$ 2,399.	\$ 2,679.	N/A	N/A	N/A



Note: Prices in **bold** indicate Quick Ship product. Applies to Polished Edge (FP) Flat Door models only.

Fill in __ designator to Model listed above with desired door style & color listed on the following page.
Examples: MC1640D4**FPL**, MC1640D8**24LE2**.

See Cabinet Door Style & Color Options, Surface-Mount Kits, Accessories & Options on the following page.

M Series Cabinets – 16" W x 40" H

Door Style & Color Options

Fill in __ designator to Model listed at left with desired door style & color. Examples: **MC1640D4FPL**, **MC1640D824LE2**.

Cabinet Top and Door Mirrored Edge

FB	Flat, Bevel Edge
FP	 Flat, Polished Edge
AB	Arch, Bevel Edge

Decorative Stock Colors (Flat)

11	Tinted Gray Mirror
20	Black
21	White

Decorative Classic Colors (Flat)

22	Beach
26	Matte White
27	Matte Gray
28	Matte Black

Decorative Special Order Colors (Flat)

12	Satin Bronze
19	Satin White
23	Ocean
24	Smoke Screen
25	Silver Screen

Surface-Mount Kits for 40" H Cabinets

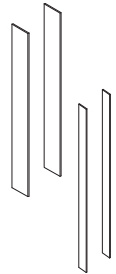

Description	Model	MIRRORED	DECORATIVE		
		Polished Edge	Stock Colors	Classic Colors	Special Order Colors
		Price	Price	Price	Price
Quantity 1 = Pair of Side Kits and Mounting Hardware					
D4 Surface-Mount, Polished Edge	MSMK40D4P	\$ 249.	N/A	N/A	N/A
D4 Surface-Mount, Decorative*	MSMK40D4 __	N/A	\$ 329.	\$ 379.	\$ 429.
D6 Surface-Mount, Polished Edge	MSMK40D6P	\$ 329.	N/A	N/A	N/A
D6 Surface-Mount, Decorative*	MSMK40D6 __	N/A	\$ 379.	\$ 429.	\$ 479.
D6 Semi-Recessed, Polished Edge	MSMK40D6SRP	\$ 249.	N/A	N/A	N/A
D6 Semi-Recessed, Decorative*	MSMK40D6SR __	N/A	\$ 329.	\$ 379.	\$ 429.
D8 Surface-Mount, Polished Edge	MSMK40D8P	\$ 379.	N/A	N/A	N/A
D8 Surface-Mount, Decorative*	MSMK40D8 __	N/A	\$ 429.	\$ 479.	\$ 549.
D8 Semi-Recessed, Polished Edge	MSMK40D8SRP	\$ 249.	N/A	N/A	N/A
D8 Semi-Recessed, Decorative*	MSMK40D8SR __	N/A	\$ 329.	\$ 379.	\$ 429.

*Fill in __ designator to Decorative Model listed above with desired color listed above. Example: **MSMK40D620**.

Accessories & Options

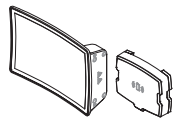

Description	Model	Price
Entice® Entice magnification mirror	ENTICE	\$ 449.
Entice magnification mirror with inductive charging dock	ENTICEDOCK	\$ 499.

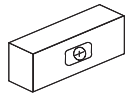

Safety Lock Box Full compartment keyed lock box in an anodized aluminum finish	SLB-*	\$ 279.
* Follow SLB with first 2 numbers (width) of cabinet model, then depth of cabinet model. Example: SLB16D4.		

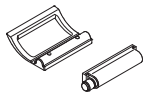

Handle Kits Chrome Handle	MHANDLEKIT	\$ 179.
or Push-to-Open Mechanism	MPUSHKIT	\$ 99.



Ganging Kit (30"/40" H) Hardware required for installing 2 or 3 cabinets side-by-side	MGKIT	\$ 49.
---	--------------	--------

See Bottom Kits on page 275.

Light Options include:

Vertical Lights
Sconces
Refer to pages 252 – 259 for more information.

Other Options:

Magnifying Mirror:
POMM, SOMM, CAMM
See page 272.
Accessory Trays & Glass Bins
See page 272.

 **Note:** Models in **bold** indicate Quick Ship product.

SEE PAGE 179 FOR TIPS AND FEATURES.

M Series Cabinets – 20" W x 40" H



For the most luxurious medicine cabinet and enhanced experiences, the M Series Collection is rich with possibilities for technology, style and storage and is the most diverse line in the market. M Series cabinets can be easily grouped together or with vertical lighting to increase storage, task lighting or to create a dramatic visual effect.

- E2 – Available for all M Series cabinets. Option includes: Sensor controlled interior LED light; Outlet shelf with USB port and 2 electrical plugs
- E4 – Available for 16" W, 20" W and 24" W medicine cabinets. Option includes: Sensor controlled interior LED light; Outlet shelf with USB port and 2 electrical plugs; Programmable night light; Defogger with 45 minute timer



20" W x 40" H Cabinets

Description	Model	MIRRORED		DECORATIVE (Flat Door only)			
		Flat Door FB, FP Price	Arch Door AB Price	Stock Colors 11, 20, 21 Price	Classic Colors 22, 26, 27, 28 Price	Special Colors 12, 19, 23, 24, 25 Price	
4" Deep (D4): 19-1/4" W x 39-3/8" H Flat, 43-3/8" H Arch (RO: 18-1/2" W x 38-5/8" H x 4" D)							
	Left – Non-Electric	MC2040D4 __ L	\$ 1,379.	\$ 1,649.	\$ 1,699.	\$ 2,029.	\$ 2,349.
	Right – Non-Electric	MC2040D4 __ R	\$ 1,379.	\$ 1,649.	\$ 1,699.	\$ 2,029.	\$ 2,349.
	Left – Electric	MC2040D4 __ LE2	\$ 1,799.	\$ 2,079.	\$ 2,129.	\$ 2,449.	\$ 2,799.
	Right – Electric	MC2040D4 __ RE2	\$ 1,799.	\$ 2,079.	\$ 2,129.	\$ 2,449.	\$ 2,799.
	Left – Electric + Night Light, Defogger	MC2040D4 __ LE4	\$ 2,129.	\$ 2,399.	N/A	N/A	N/A
	Right – Electric + Night Light, Defogger	MC2040D4 __ RE4	\$ 2,129.	\$ 2,399.	N/A	N/A	N/A
6" Deep (D6): 19-1/4" W x 39-3/8" H Flat, 43-3/8" H Arch (RO: 18-1/2" W x 38-5/8" H x 6" D)							
	Left – Non-Electric	MC2040D6 __ L	\$ 1,649.	\$ 1,929.	\$ 1,979.	\$ 2,299.	\$ 2,629.
	Right – Non-Electric	MC2040D6 __ R	\$ 1,649.	\$ 1,929.	\$ 1,979.	\$ 2,299.	\$ 2,629.
	Left – Electric	MC2040D6 __ LE2	\$ 2,079.	\$ 2,349.	\$ 2,399.	\$ 2,729.	\$ 3,079.
	Right – Electric	MC2040D6 __ RE2	\$ 2,079.	\$ 2,349.	\$ 2,399.	\$ 2,729.	\$ 3,079.
	Left – Electric + Night Light, Defogger	MC2040D6 __ LE4	\$ 2,399.	\$ 2,679.	N/A	N/A	N/A
	Right – Electric + Night Light, Defogger	MC2040D6 __ RE4	\$ 2,399.	\$ 2,679.	N/A	N/A	N/A
8" Deep (D8): 19-1/4" W x 39-3/8" H Flat, 43-3/8" H Arch (RO: 18-1/2" W x 38-5/8" H x 8" D)							
	Left – Non-Electric	MC2040D8 __ L	\$ 1,749.	\$ 2,029.	\$ 2,079.	\$ 2,399.	\$ 2,729.
	Right – Non-Electric	MC2040D8 __ R	\$ 1,749.	\$ 2,029.	\$ 2,079.	\$ 2,399.	\$ 2,729.
	Left – Electric	MC2040D8 __ LE2	\$ 2,199.	\$ 2,449.	\$ 2,529.	\$ 2,849.	\$ 3,179.
	Right – Electric	MC2040D8 __ RE2	\$ 2,199.	\$ 2,449.	\$ 2,529.	\$ 2,849.	\$ 3,179.
	Left – Electric + Night Light, Defogger	MC2040D8 __ LE4	\$ 2,529.	\$ 2,799.	N/A	N/A	N/A
	Right – Electric + Night Light, Defogger	MC2040D8 __ RE4	\$ 2,529.	\$ 2,799.	N/A	N/A	N/A

Note: Prices in **bold** indicate Quick Ship product. Applies to Polished Edge (FP) Flat Door models only.

Fill in __ designator to Model listed above with desired door style & color listed on the following page.
Examples: MC2040D4FP**L, MC2040D8**24**LE2.**

See Cabinet Door Style & Color Options, Surface-Mount Kits, Accessories & Options on the following page.

M Series Cabinets – 20" W x 40" H

Door Style & Color Options

Fill in __ designator to Model listed at left with desired door style & color. Examples: **MC2040D4FPL**, **MC2040D824LE2**.

Cabinet Top and Door Mirrored Edge

FB	Flat, Bevel Edge
FP	 Flat, Polished Edge
AB	Arch, Bevel Edge

Decorative Stock Colors (Flat)

11	Tinted Gray Mirror
20	Black
21	White

Decorative Classic Colors (Flat)

22	Beach
26	Matte White
27	Matte Gray
28	Matte Black

Decorative Special Order Colors (Flat)

12	Satin Bronze
19	Satin White
23	Ocean
24	Smoke Screen
25	Silver Screen

Surface-Mount Kits for 40" H Cabinets

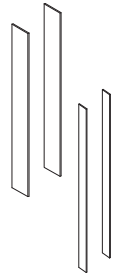

Description	Model	MIRRORED	DECORATIVE		
		Polished Edge	Stock Colors	Classic Colors	Special Order Colors
		Price	Price	Price	Price
Quantity 1 = Pair of Side Kits and Mounting Hardware					
D4 Surface-Mount, Polished Edge	MSMK40D4P	\$ 249.	N/A	N/A	N/A
D4 Surface-Mount, Decorative*	MSMK40D4 __	N/A	\$ 329.	\$ 379.	\$ 429.
D6 Surface-Mount, Polished Edge	MSMK40D6P	\$ 329.	N/A	N/A	N/A
D6 Surface-Mount, Decorative*	MSMK40D6 __	N/A	\$ 379.	\$ 429.	\$ 479.
D6 Semi-Recessed, Polished Edge	MSMK40D6SRP	\$ 249.	N/A	N/A	N/A
D6 Semi-Recessed, Decorative*	MSMK40D6SR __	N/A	\$ 329.	\$ 379.	\$ 429.
D8 Surface-Mount, Polished Edge	MSMK40D8P	\$ 379.	N/A	N/A	N/A
D8 Surface-Mount, Decorative*	MSMK40D8 __	N/A	\$ 429.	\$ 479.	\$ 549.
D8 Semi-Recessed, Polished Edge	MSMK40D8SRP	\$ 249.	N/A	N/A	N/A
D8 Semi-Recessed, Decorative*	MSMK40D8SR __	N/A	\$ 329.	\$ 379.	\$ 429.

*Fill in __ designator to Decorative Model listed above with desired color listed above. Example: **MSMK40D620**.

Accessories & Options

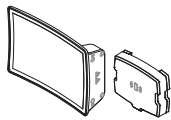

Description	Model	Price
Entice. Entice magnification mirror	ENTICE	\$ 449.
Entice magnification mirror with inductive charging dock	ENTICEDOCK	\$ 499.

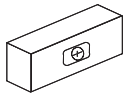

Safety Lock Box Full compartment keyed lock box in an anodized aluminum finish	SLB-*	\$ 279.
* Follow SLB with first 2 numbers (width) of cabinet model, then depth of cabinet model. Example: SLB20D6.		

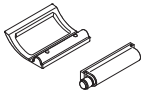

Handle Kits Chrome Handle	MHANDLEKIT	\$ 179.
or Push-to-Open Mechanism	MPUSHKIT	\$ 99.

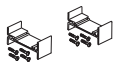

Ganging Kit (30"/40" H) Hardware required for installing 2 or 3 cabinets side-by-side	MGKIT	\$ 49.
---	--------------	--------

See Bottom Kits on page 275.

Light Options include:
Vertical Lights
Sconces
Refer to pages 252 – 259 for more information.

Other Options:
Magnifying Mirror:
POMM, SOMM, CAMM
See page 272.
Accessory Trays & Glass Bins
See page 272.

 **Note:** Models in **bold** indicate Quick Ship product.

SEE PAGE 179 FOR TIPS AND FEATURES.

M Series Cabinets – 24" W x 40" H



For the most luxurious medicine cabinet and enhanced experiences, the M Series Collection is rich with possibilities for technology, style and storage and is the most diverse line in the market. M Series cabinets can be easily grouped together or with vertical lighting to increase storage, task lighting or to create a dramatic visual effect.

- E2 – Available for all M Series cabinets. Option includes: Sensor controlled interior LED light; Outlet shelf with USB port and 2 electrical plugs
- E4 – Available for 16" W, 20" W and 24" W medicine cabinets. Option includes: Sensor controlled interior LED light; Outlet shelf with USB port and 2 electrical plugs; Programmable night light; Defogger with 45 minute timer



Two Week Lead Time (Stock Colors)



Four Week Lead Time (Classic/Special Order Colors)



Modular



Defogger



Electrical Outlet



Night Light



USB Charging



Interior Lighting



Magnetic



Magnifying Mirror

24" W x 40" H Cabinets

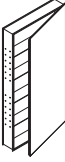
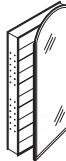
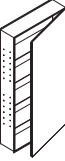
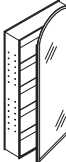
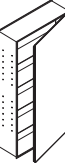
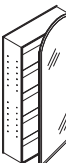
Description	Model	MIRRORED		DECORATIVE (Flat Door only)		
		Flat Door FB, FP Price	Arch Door AB Price	Stock Colors 11, 20, 21 Price	Classic Colors 22, 26, 27, 28 Price	Special Order Colors 12, 19, 23, 24, 25 Price
4" Deep (D4): 23-1/4" W x 39-3/8" H Flat, 43-3/8" H Arch (RO: 22-1/2" W x 38-5/8" H x 4" D)						
 Left – Non-Electric	MC2440D4 __ L	\$ 1,429.	\$ 1,699.	\$ 1,749.	\$ 2,079.	\$ 2,399.
 Right – Non-Electric	MC2440D4 __ R	\$ 1,429.	\$ 1,699.	\$ 1,749.	\$ 2,079.	\$ 2,399.
Left – Electric	MC2440D4 __ LE2	\$ 1,849.	\$ 2,129.	\$ 2,199.	\$ 2,529.	\$ 2,849.
Right – Electric	MC2440D4 __ RE2	\$ 1,849.	\$ 2,129.	\$ 2,199.	\$ 2,529.	\$ 2,849.
Left – Electric + Night Light, Defogger	MC2440D4 __ LE4	\$ 2,199.	\$ 2,449.	N/A	N/A	N/A
Right – Electric + Night Light, Defogger	MC2440D4 __ RE4	\$ 2,199.	\$ 2,449.	N/A	N/A	N/A
6" Deep (D6): 23-1/4" W x 39-3/8" H Flat, 43-3/8" H Arch (RO: 22-1/2" W x 38-5/8" H x 6" D)						
 Left – Non-Electric	MC2440D6 __ L	\$ 1,699.	\$ 1,979.	\$ 2,029.	\$ 2,349.	\$ 2,679.
 Right – Non-Electric	MC2440D6 __ R	\$ 1,699.	\$ 1,979.	\$ 2,029.	\$ 2,349.	\$ 2,679.
Left – Electric	MC2440D6 __ LE2	\$ 2,129.	\$ 2,399.	\$ 2,449.	\$ 2,799.	\$ 3,129.
Right – Electric	MC2440D6 __ RE2	\$ 2,129.	\$ 2,399.	\$ 2,449.	\$ 2,799.	\$ 3,129.
Left – Electric + Night Light, Defogger	MC2440D6 __ LE4	\$ 2,449.	\$ 2,729.	N/A	N/A	N/A
Right – Electric + Night Light, Defogger	MC2440D6 __ RE4	\$ 2,449.	\$ 2,729.	N/A	N/A	N/A
8" Deep (D8): 23-1/4" W x 39-3/8" H Flat, 43-3/8" H Arch (RO: 22-1/2" W x 38-5/8" H x 8" D)						
 Left – Non-Electric	MC2440D8 __ L	\$ 1,799.	\$ 2,079.	\$ 2,129.	\$ 2,449.	\$ 2,799.
 Right – Non-Electric	MC2440D8 __ R	\$ 1,799.	\$ 2,079.	\$ 2,129.	\$ 2,449.	\$ 2,799.
Left – Electric	MC2440D8 __ LE2	\$ 2,249.	\$ 2,529.	\$ 2,579.	\$ 2,899.	\$ 3,229.
Right – Electric	MC2440D8 __ RE2	\$ 2,249.	\$ 2,529.	\$ 2,579.	\$ 2,899.	\$ 3,229.
Left – Electric + Night Light, Defogger	MC2440D8 __ LE4	\$ 2,579.	\$ 2,849.	N/A	N/A	N/A
Right – Electric + Night Light, Defogger	MC2440D8 __ RE4	\$ 2,579.	\$ 2,849.	N/A	N/A	N/A



Note: Prices in **bold** indicate Quick Ship product. Applies to Polished Edge (FP) Flat Door models only.

Fill in __ designator to Model listed above with desired door style & color listed on the following page.
Examples: MC2440D4**FPL**, MC2440D8**24LE2**.

See Cabinet Door Style & Color Options, Surface-Mount Kits, Accessories & Options on the following page.

M Series Cabinets – 24" W x 40" H

Door Style & Color Options

Fill in __ designator to Model listed at left with desired door style & color. Examples: **MC2440D4FPL**, **MC2440D824LE2**.

Cabinet Top and Door Mirrored Edge

FB	Flat, Bevel Edge
FP	 Flat, Polished Edge
AB	Arch, Bevel Edge

Decorative Stock Colors (Flat)

11	Tinted Gray Mirror
20	Black
21	White

Decorative Classic Colors (Flat)

22	Beach
26	Matte White
27	Matte Gray
28	Matte Black

Decorative Special Order Colors (Flat)

12	Satin Bronze
19	Satin White
23	Ocean
24	Smoke Screen
25	Silver Screen

Surface-Mount Kits for 40" H Cabinets

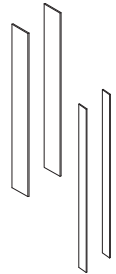

Description	Model	MIRRORED	DECORATIVE		
		Polished Edge	Stock Colors	Classic Colors	Special Order Colors
		Price	Price	Price	Price
Quantity 1 = Pair of Side Kits and Mounting Hardware					
D4 Surface-Mount, Polished Edge	MSMK40D4P	\$ 249.	N/A	N/A	N/A
D4 Surface-Mount, Decorative*	MSMK40D4 __	N/A	\$ 329.	\$ 379.	\$ 429.
D6 Surface-Mount, Polished Edge	MSMK40D6P	\$ 329.	N/A	N/A	N/A
D6 Surface-Mount, Decorative*	MSMK40D6 __	N/A	\$ 379.	\$ 429.	\$ 479.
D6 Semi-Recessed, Polished Edge	MSMK40D6SRP	\$ 249.	N/A	N/A	N/A
D6 Semi-Recessed, Decorative*	MSMK40D6SR __	N/A	\$ 329.	\$ 379.	\$ 429.
D8 Surface-Mount, Polished Edge	MSMK40D8P	\$ 379.	N/A	N/A	N/A
D8 Surface-Mount, Decorative*	MSMK40D8 __	N/A	\$ 429.	\$ 479.	\$ 549.
D8 Semi-Recessed, Polished Edge	MSMK40D8SRP	\$ 249.	N/A	N/A	N/A
D8 Semi-Recessed, Decorative*	MSMK40D8SR __	N/A	\$ 329.	\$ 379.	\$ 429.

*Fill in __ designator to Decorative Model listed above with desired color listed above. Example: **MSMK40D620**.

Accessories & Options

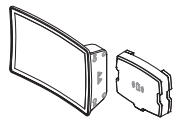

Description	Model	Price
Entice® Entice magnification mirror	ENTICE	\$ 449.
Entice magnification mirror with inductive charging dock	ENTICEDOCK	\$ 499.

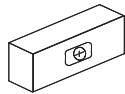

Safety Lock Box Full compartment keyed lock box in an anodized aluminum finish	SLB-*	\$ 279.
* Follow SLB with first 2 numbers (width) of cabinet model, then depth of cabinet model. Example: SLB24D8.		

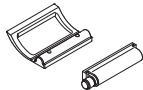

Handle Kits Chrome Handle	MHANDLEKIT	\$ 179.
or Push-to-Open Mechanism	MPUSHKIT	\$ 99.



Ganging Kit (30"/40" H) Hardware required for installing 2 or 3 cabinets side-by-side	MGKIT	\$ 49.
---	--------------	--------

See Bottom Kits on page 275.

Light Options include:

Vertical Lights
Sconces
Refer to pages 252 – 259 for more information.

Other Options:

Magnifying Mirror:
POMM, SOMM, CAMM
See page 272.
Accessory Trays & Glass Bins
See page 272.

 **Note:** Models in **bold** indicate Quick Ship product.

SEE PAGE 179 FOR TIPS AND FEATURES.

M Series Cabinets – 16" W x 70" H



For the most luxurious medicine cabinet and enhanced experiences, the M Series Collection is rich with possibilities for technology, style and storage and is the most diverse line in the market. M Series cabinets can be easily grouped together to increase storage or to create a dramatic visual effect.

- E2 – Available for all M Series cabinets. Option includes:
Sensor controlled interior LED light
Outlet shelf with USB port and 2 electrical plugs



Two Week Lead Time
(Stock Colors)



Four Week Lead Time
(Classic/Special Order Colors)



Modular



Electrical
Outlet



USB
Charging



Interior
Lighting



Magnetic



Magnifying
Mirror

16" W x 70" H Cabinets

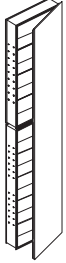
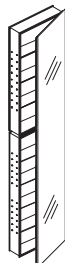
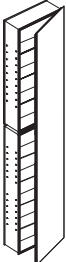
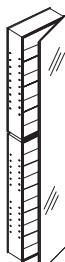
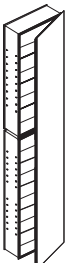
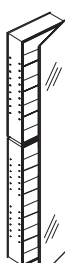
Description	Model	MIRRORED	DECORATIVE		
		Flat Door FB, FP Price	Stock Colors 11, 20, 21 Price	Classic Colors 22, 26, 27, 28 Price	Special Order Colors 12, 19, 23, 24, 25 Price
4" Deep (D4): 15-1/4" W x 70" H (RO: 14-1/2" W x 69-1/4" H x 4" D)					
 Left – Non-Electric	MC1670D4 __ L	\$ 2,449.	\$ 2,949.	\$ 3,449.	\$ 3,949.
 Right – Non-Electric	MC1670D4 __ R	\$ 2,449.	\$ 2,949.	\$ 3,449.	\$ 3,949.
Left – Electric	MC1670D4 __ LE2	\$ 2,899.	\$ 3,399.	\$ 3,879.	\$ 4,379.
Right – Electric	MC1670D4 __ RE2	\$ 2,899.	\$ 3,399.	\$ 3,879.	\$ 4,379.
6" Deep (D6): 15-1/4" W x 70" H (RO: 14-1/2" W x 69-1/4" H x 6" D)					
 Left – Non-Electric	MC1670D6 __ L	\$ 2,729.	\$ 3,229.	\$ 3,729.	\$ 4,229.
 Right – Non-Electric	MC1670D6 __ R	\$ 2,729.	\$ 3,229.	\$ 3,729.	\$ 4,229.
Left – Electric	MC1670D6 __ LE2	\$ 3,179.	\$ 3,679.	\$ 4,149.	\$ 4,649.
Right – Electric	MC1670D6 __ RE2	\$ 3,179.	\$ 3,679.	\$ 4,149.	\$ 4,649.
8" Deep (D8): 15-1/4" W x 70" H (RO: 14-1/2" W x 69-1/4" H x 8" D)					
 Left – Non-Electric	MC1670D8 __ L	\$ 2,849.	\$ 3,349.	\$ 3,829.	\$ 4,329.
 Right – Non-Electric	MC1670D8 __ R	\$ 2,849.	\$ 3,349.	\$ 3,829.	\$ 4,329.
Left – Electric	MC1670D8 __ LE2	\$ 3,279.	\$ 3,779.	\$ 4,279.	\$ 4,749.
Right – Electric	MC1670D8 __ RE2	\$ 3,279.	\$ 3,779.	\$ 4,279.	\$ 4,749.

Fill in __ designator to Model listed above with desired door style & color listed on the following page.
Examples: MC1670D4FPL, MC1670D824LE2.

See Cabinet Door Style & Color Options, Surface-Mount Kits, Accessories & Options on the following page.

M Series Cabinets – 16" W x 70" H

Door Style & Color Options

Fill in __ designator to Model listed at left with desired door style & color. Examples: MC1670D4FPL, MC1670D824LE2.

Cabinet Top and Door Mirrored Edge	Decorative Stock Colors (Flat)	Decorative Classic Colors (Flat)	Decorative Special Order Colors (Flat)
FB Flat, Bevel Edge	11 Tinted Gray Mirror	22 Beach	12 Satin Bronze
FP Flat, Polished Edge	20 Black	26 Matte White	19 Satin White
	21 White	27 Matte Gray	23 Ocean
		28 Matte Black	24 Smoke Screen
			25 Silver Screen

Surface-Mount Kits for 70" H Cabinets

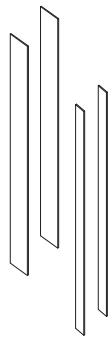

Description	Model	MIRRORED	DECORATIVE		
		Polished Edge	Stock Colors	Classic Colors	Special Order Colors
		Price	11, 20, 21 Price	22, 26, 27, 28 Price	12, 19, 23, 24, 25 Price
Quantity 1 = Pair of Side Kits and Mounting Hardware					
D4 Surface-Mount, Polished Edge	MSMK70D4P	\$ 429.	N/A	N/A	N/A
D4 Surface-Mount, Decorative*	MSMK70D4 __	N/A	\$ 479.	\$ 599.	\$ 699.
D6 Surface-Mount, Polished Edge	MSMK70D6P	\$ 549.	N/A	N/A	N/A
D6 Surface-Mount, Decorative*	MSMK70D6 __	N/A	\$ 599.	\$ 699.	\$ 829.
D6 Semi-Recessed, Polished Edge	MSMK70D6SRP	\$ 429.	N/A	N/A	N/A
D6 Semi-Recessed, Decorative*	MSMK70D6SR __	N/A	\$ 479.	\$ 599.	\$ 699.
D8 Surface-Mount, Polished Edge	MSMK70D8P	\$ 649.	N/A	N/A	N/A
D8 Surface-Mount, Decorative*	MSMK70D8 __	N/A	\$ 699.	\$ 829.	\$ 929.
D8 Semi-Recessed, Polished Edge	MSMK70D8SRP	\$ 429.	N/A	N/A	N/A
D8 Semi-Recessed, Decorative*	MSMK70D8SR __	N/A	\$ 479.	\$ 599.	\$ 699.

*Fill in __ designator to Decorative Model listed above with desired color listed above. Example: MSMK70D620.

Accessories & Options

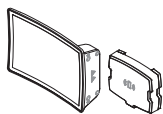

Description	Model	Price
Entice® Entice magnification mirror	ENTICE	\$ 449.
Entice magnification mirror with inductive charging dock	ENTICEDOCK	\$ 499.



Magnifying Mirror Compact adjustable magnification mirror	CAMM	\$ 49.
---	------	--------

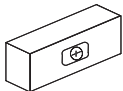

Safety Lock Box Full compartment keyed lock box in an anodized aluminum finish	SLB-*	\$ 279.
--	-------	---------

* Follow SLB with first 2 numbers (width) of cabinet model, then depth of cabinet model. Example: SLB16D4.

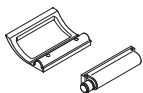

Handle Kits Chrome Handle or Push-to-Open Mechanism	MHANDLEKIT MPUSHKIT	\$ 179. \$ 99.
---	------------------------	-------------------



Ganging Kit (70" H) Hardware required for installing 2 or 3 cabinets side-by-side	MGKIT70	\$ 99.
---	---------	--------

See Bottom Kits on page 275.

Light Options include:

Sconces
Refer to pages 257 – 259 for more information.

Other Options:

Accessory Trays & Glass Bins
See page 272.

SEE PAGE 179 FOR TIPS AND FEATURES.

M Series Cabinets – 20" W x 70" H



For the most luxurious medicine cabinet and enhanced experiences, the M Series Collection is rich with possibilities for technology, style and storage and is the most diverse line in the market. M Series cabinets can be easily grouped together to increase storage or to create a dramatic visual effect.

- E2 – Available for all M Series cabinets. Option includes:
Sensor controlled interior LED light
Outlet shelf with USB port and 2 electrical plugs



Two Week Lead Time
(Stock Colors)



Four Week Lead Time
(Classic/Special Order Colors)



Modular



Electrical
Outlet



USB
Charging



Interior
Lighting



Magnetic



Magnifying
Mirror

20" W x 70" H Cabinets

Description	Model	MIRRORED	DECORATIVE			
		Flat Door FB, FP Price	Stock Colors 11, 20, 21 Price	Classic Colors 22, 26, 27, 28 Price	Special Order Colors 12, 19, 23, 24, 25 Price	
4" Deep (D4): 19-1/4" W x 70" H (RO: 18-1/2" W x 69-1/4" H x 4" D)						
	Left – Non-Electric	MC2070D4 __ L	\$ 2,729.	\$ 3,279.	\$ 3,829.	\$ 4,379.
	Right – Non-Electric	MC2070D4 __ R	\$ 2,729.	\$ 3,279.	\$ 3,829.	\$ 4,379.
	Left – Electric	MC2070D4 __ LE2	\$ 3,179.	\$ 3,729.	\$ 4,279.	\$ 4,829.
	Right – Electric	MC2070D4 __ RE2	\$ 3,179.	\$ 3,729.	\$ 4,279.	\$ 4,829.
6" Deep (D6): 19-1/4" W x 70" H (RO: 18-1/2" W x 69-1/4" H x 6" D)						
	Left – Non-Electric	MC2070D6 __ L	\$ 2,999.	\$ 3,549.	\$ 4,099.	\$ 4,649.
	Right – Non-Electric	MC2070D6 __ R	\$ 2,999.	\$ 3,549.	\$ 4,099.	\$ 4,649.
	Left – Electric	MC2070D6 __ LE2	\$ 3,449.	\$ 3,999.	\$ 4,549.	\$ 5,099.
	Right – Electric	MC2070D6 __ RE2	\$ 3,449.	\$ 3,999.	\$ 4,549.	\$ 5,099.
8" Deep (D8): 19-1/4" W x 70" H (RO: 18-1/2" W x 69-1/4" H x 8" D)						
	Left – Non-Electric	MC2070D8 __ L	\$ 3,129.	\$ 3,679.	\$ 4,229.	\$ 4,749.
	Right – Non-Electric	MC2070D8 __ R	\$ 3,129.	\$ 3,679.	\$ 4,229.	\$ 4,749.
	Left – Electric	MC2070D8 __ LE2	\$ 3,549.	\$ 4,099.	\$ 4,649.	\$ 5,199.
	Right – Electric	MC2070D8 __ RE2	\$ 3,549.	\$ 4,099.	\$ 4,649.	\$ 5,199.

Fill in __ designator to Model listed above with desired door style & color listed on the following page.
Examples: MC2070D4FPL, MC2070D82LE2.

See Cabinet Door Style & Color Options, Surface-Mount Kits, Accessories & Options on the following page.

M Series Cabinets – 20" W x 70" H

Door Style & Color Options

Fill in __ designator to Model listed at left with desired door style & color. Examples: MC2070D4FPL, MC2070D824LE2.

Cabinet Top and Door Mirrored Edge	Decorative Stock Colors (Flat)	Decorative Classic Colors (Flat)	Decorative Special Order Colors (Flat)
FB Flat, Bevel Edge	11 Tinted Gray Mirror	22 Beach	12 Satin Bronze
FP Flat, Polished Edge	20 Black	26 Matte White	19 Satin White
	21 White	27 Matte Gray	23 Ocean
		28 Matte Black	24 Smoke Screen
			25 Silver Screen

Surface-Mount Kits for 70" H Cabinets

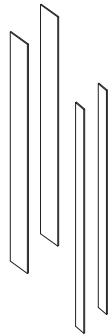

Description	Model	MIRRORED	DECORATIVE		
		Polished Edge	Stock Colors	Classic Colors	Special Order Colors
		Price	11, 20, 21 Price	22, 26, 27, 28 Price	12, 19, 23, 24, 25 Price
Quantity 1 = Pair of Side Kits and Mounting Hardware					
D4 Surface-Mount, Polished Edge	MSMK70D4P	\$ 429.	N/A	N/A	N/A
D4 Surface-Mount, Decorative*	MSMK70D4 __	N/A	\$ 479.	\$ 599.	\$ 699.
D6 Surface-Mount, Polished Edge	MSMK70D6P	\$ 549.	N/A	N/A	N/A
D6 Surface-Mount, Decorative*	MSMK70D6 __	N/A	\$ 599.	\$ 699.	\$ 829.
D6 Semi-Recessed, Polished Edge	MSMK70D6SRP	\$ 429.	N/A	N/A	N/A
D6 Semi-Recessed, Decorative*	MSMK70D6SR __	N/A	\$ 479.	\$ 599.	\$ 699.
D8 Surface-Mount, Polished Edge	MSMK70D8P	\$ 649.	N/A	N/A	N/A
D8 Surface-Mount, Decorative*	MSMK70D8 __	N/A	\$ 699.	\$ 829.	\$ 929.
D8 Semi-Recessed, Polished Edge	MSMK70D8SRP	\$ 429.	N/A	N/A	N/A
D8 Semi-Recessed, Decorative*	MSMK70D8SR __	N/A	\$ 479.	\$ 599.	\$ 699.

*Fill in __ designator to Decorative Model listed above with desired color listed above. Example: MSMK70D620.

Accessories & Options

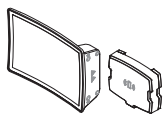

Description	Model	Price
Entice® Entice magnification mirror	ENTICE	\$ 449.
Entice magnification mirror with inductive charging dock	ENTICEDOCK	\$ 499.



Magnifying Mirror Compact adjustable magnification mirror	CAMM	\$ 49.
---	------	--------

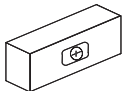

Safety Lock Box Full compartment keyed lock box in an anodized aluminum finish	SLB-*	\$ 279.
* Follow SLB with first 2 numbers (width) of cabinet model, then depth of cabinet model. Example: SLB20D6.		

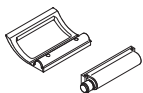

Handle Kits Chrome Handle	MHANDLEKIT	\$ 179.
or Push-to-Open Mechanism	MPUSHKIT	\$ 99.



Ganging Kit (70" H) Hardware required for installing 2 or 3 cabinets side-by-side	MGKIT70	\$ 99.
---	---------	--------

See Bottom Kits on page 275.

Light Options include:

Sconces
Refer to pages 257 – 259 for more information.

Other Options:

Accessory Trays & Glass Bins
See page 272.

SEE PAGE 179 FOR TIPS AND FEATURES.

Main Line Framed Cabinets – Table of Contents

Main Line Framed Cabinet Tips & Features	203
Main Line Framed Cabinet Worksheet	204
Bryn Mawr® Framed Cabinets	205 – 210
16" Wide, 30" High	205
20" Wide, 30" High	206
24" Wide, 30" High	207
16" Wide, 40" High	208
20" Wide, 40" High	209
24" Wide, 40" High	210
Merion® Framed Cabinets	211 – 216
16" Wide, 30" High	211
20" Wide, 30" High	212
24" Wide, 30" High	213
16" Wide, 40" High	214
20" Wide, 40" High	215
24" Wide, 40" High	216
Penn Valley® Framed Cabinets	217 – 222
16" Wide, 30" High	217
20" Wide, 30" High	218
24" Wide, 30" High	219
16" Wide, 40" High	220
20" Wide, 40" High	221
24" Wide, 40" High	222
Rosemont® Framed Cabinets	223 – 228
16" Wide, 30" High	223
20" Wide, 30" High	224
24" Wide, 30" High	225
16" Wide, 40" High	226
20" Wide, 40" High	227
24" Wide, 40" High	228
Main Line Framed Mirrors	34 – 35
Main Line Sconces	259
Cabinet Accessories	271 – 275



Main Line Framed Cabinets – Tips & Features

Dimensions & Weight

- Width:
15-3/8" (391 mm)
19-3/8" (492 mm)
23-3/4" (594 mm)
- Height:
30-1/16" (764 mm)
39-3/8" (1000 mm)
- Depth:
4" (102 mm)
6" (152 mm)
- Net Weight (Lbs): 36 – 60.8 lbs

Features & Benefits

- Available in four uniquely designed frame profiles: Bryn Mawr®, Merion®, Penn Valley®, Rosemont®
- Frame profiles available in 7 metal finish options
- Electric option includes one 15A, 120VAC outlet (2 plugs)
- Pair with Main Line Sconces for a coordinated look
- ETL certified to UL 962, CSA Standard C22.2 No. 68

Configurable Options

- Cabinet Style:
Bryn Mawr, Merion, Penn Valley, Rosemont
- Finish Options: 7 metal finishes
- Hinge Options: non-handed, left or right hinge
- Electrical Packages: non-electric or electric

Construction

- Durable rust-free anodized aluminum and glass construction – glass resists intense moisture, ensuring long-lasting beauty
- Satin anodized aluminum body
- Quiet close Safeseal® Gasket with sealed corners on cabinet body
- 3 mirror design – rear of cabinet and both sides of door
- Concealed finger pull-door edge
- 3-way adjustable concealed hinge system: door opening angle 130 degrees
- Adjustable shelving at 2" (51 mm) increments: 3 shelves for 30" H, 4 shelves for 40" H
- 1/4" (6 mm) thick adjustable clear glass shelves
- Frame width:
1-3/4" for Bryn Mawr, 2-9/16" for Merion, 1-1/16" for Penn Valley and 13/16" for Rosemont

Installation

- Recessed, semi-recessed or surface-mount installation (6" deep cabinets can be semi-recessed by 4")
- Cabinets include hardware for recessed installation. Surface-mount and semi-recess installations require the purchase of a kit which includes the side kit as well as mounting hardware.
- Non-handed single door cabinets can be installed with left or right opening. Left or Right = hinge side when facing cabinet.
- Recessed cabinets project 1-1/8" for Bryn Mawr, 1-1/16" for Merion, 1-1/8" for Penn Valley, 1-3/8" for Rosemont and must be recessed no less than 3-3/4" deep for 4" D cabinets
- Electric option cabinet: standard knock out for 1/2" (13mm) cable connector, wired internally – front access serviceability

Accessories

- Safety Lock Box (SLB-*)
- Pull-Out Magnifying Mirror (POMM)
- Swing-Out Magnifying Mirror (SOMM)
- Glass Bins (GLASSBIN3.25, GLASSBIN5.25, GLASSBIN8.5)
- Push-to-Open Kit (MPUSHKIT)
- Surface-Mount Kit (MSMK30D__, MSMK40D__)
- Semi-Recessed Kit (MSMK30D__SRP, MSMK40D__SRP)
- Bottom Kit (MBK__D_A, MBK__D_ASR)

Frame Details & Dimensions

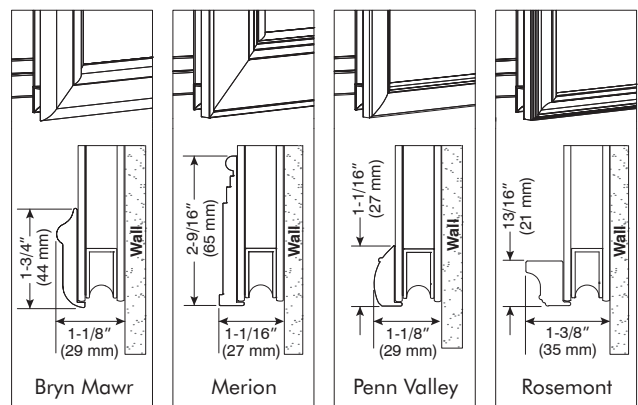

Main Line Framed Cabinet Worksheet

FEATURES

Select Width:

16"

20"

24"

Select Height:

30"

40"

Select Depth:

4"

6"

Style Name:

Bryn Mawr®

Merion®

Penn Valley®

Rosemont®

Classic Gray Interior

Select Hinge and Electric Option:

Left or Right Hinge, No Electric

Left with Electric Option

Right with Electric Option

Select Decorative Finish:

Satin Nickel

Brushed Nickel

Brushed Black

Brushed Bronze

Chrome

Polished Nickel

White

MODEL

DC

G

16

20

24

30

40

D4

D6

BM

ME

PV

RM

G

—

LE

RE

70

71

74

75

76

77

79

Cabinets

CUSTOMER INFORMATION

Name

Address

City/State/Zip

Telephone

Date Ordered

Light Selection

Surface-Mount Side Kit Model (if applicable)

Frame Choice

Notes

Bryn Mawr® Framed Cabinets – 16" W x 30" H



A framed medicine cabinet that is versatile enough to enhance any design approach, the Main Line Collection offers 4 framed profiles with 7 metal finishes and a variety of size options.

- Available in four uniquely designed frame profiles: Bryn Mawr, Merion®, Penn Valley®, Rosemont®
- Frame profiles available in 7 metal finish options
- Pair with Main Line Sconces for a coordinated look
- ETL certified to UL 962, CSA Standard C22.2 No. 68



Two Week Lead Time



Electrical Outlet



Magnifying Mirror

Bryn Mawr 16" W x 30" H Cabinets

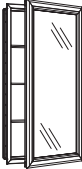
Description	Model	FINISHES		
		70, 71 Price	74, 75, 79 Price	76, 77 Price
4" Deep (D4): 15-1/4" W x 30" H (RO: 14-1/2" W x 29-1/4" H x 4" D)				
 Non-Handed	DC1630D4BMG __	\$ 749.	\$ 849.	\$ 1,079.
Left – Electric	DC1630D4BMGLE __	\$ 1,029.	\$ 1,149.	\$ 1,349.
Right – Electric	DC1630D4BMGRE __	\$ 1,029.	\$ 1,149.	\$ 1,349.
6" Deep (D6): 15-1/4" W x 30" H (RO: 14-1/2" W x 29-1/4" H x 6" D)				
 Non-Handed	DC1630D6BMG __	\$ 1,029.	\$ 1,129.	\$ 1,329.
Left – Electric	DC1630D6BMGLE __	\$ 1,299.	\$ 1,429.	\$ 1,629.
Right – Electric	DC1630D6BMGRE __	\$ 1,299.	\$ 1,429.	\$ 1,629.

Finish Options

Fill in __ designator to Model listed above with desired finish. Example: DC1630D4BMG74.

70 Satin Nickel	76 Chrome
71 Brushed Nickel	77 Polished Nickel
74 Brushed Black	79 White
75 Brushed Bronze	

Accessories & Options

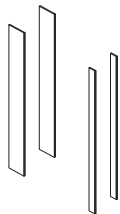

Description	Model	Price
Surface-Mount Kit for 30" H Mirrored Cabinets Quantity 1 = Pair of Side Kits and Mounting Hardware		
D4 Surface-Mount, Polished Edge Mirror	MSMK30D4P	\$ 149.
D6 Surface-Mount, Polished Edge Mirror	MSMK30D6P	\$ 199.
D6 Semi-Recessed, Polished Edge Mirror	MSMK30D6SRP	\$ 149.

See page 274 for Decorative surface-mount kit options.

See **Bottom Kits on page 275.**

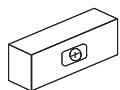

Safety Lock Box	SLB-*	\$ 279.
Full compartment keyed lock box in an anodized aluminum finish		

* Follow SLB with first 2 numbers (width) of cabinet model, then depth of cabinet model. Example: SLB16D4

Light Options include:

Main Line Sconces
Refer to page 259 for more information.

Other Options:

Main Line Framed Wall Mirrors
See pages 34 – 35.

Magnifying Mirror: POMM, SOMM
See page 272.

Glass Bins
See page 272.

SEE PAGE 203 FOR TIPS AND FEATURES.

Bryn Mawr® Framed Cabinets – 20" W x 30" H



A framed medicine cabinet that is versatile enough to enhance any design approach, the Main Line Collection offers 4 framed profiles with 7 metal finishes and a variety of size options.

- Available in four uniquely designed frame profiles: Bryn Mawr, Merion®, Penn Valley®, Rosemont®
- Frame profiles available in 7 metal finish options
- Pair with Main Line Sconces for a coordinated look
- ETL certified to UL 962, CSA Standard C22.2 No. 68



Two Week Lead Time



Electrical Outlet



Magnifying Mirror

Bryn Mawr 20" W x 30" H Cabinets

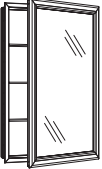
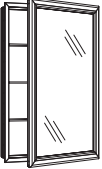
Description	Model	FINISHES		
		70, 71 Price	74, 75, 79 Price	76, 77 Price
4" Deep (D4): 19-1/4" W x 30" H (RO: 18-1/2" W x 29-1/4" H x 4" D)				
 Non-Handed	DC2030D4BMG __	\$ 849.	\$ 949.	\$ 1,179.
Left – Electric	DC2030D4BMGLE __	\$ 1,149.	\$ 1,249.	\$ 1,479.
Right – Electric	DC2030D4BMGRE __	\$ 1,149.	\$ 1,249.	\$ 1,479.
6" Deep (D6): 19-1/4" W x 30" H (RO: 18-1/2" W x 29-1/4" H x 6" D)				
 Non-Handed	DC2030D6BMG __	\$ 1,129.	\$ 1,229.	\$ 1,449.
Left – Electric	DC2030D6BMGLE __	\$ 1,429.	\$ 1,529.	\$ 1,749.
Right – Electric	DC2030D6BMGRE __	\$ 1,429.	\$ 1,529.	\$ 1,749.

Finish Options

Fill in __ designator to Model listed above with desired finish. Example: DC2030D6BMGLE70.

70	Satin Nickel	76	Chrome
71	Brushed Nickel	77	Polished Nickel
74	Brushed Black	79	White
75	Brushed Bronze		

Accessories & Options

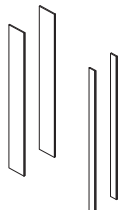

Description	Model	Price
Surface-Mount Kit for 30" H Mirrored Cabinets Quantity 1 = Pair of Side Kits and Mounting Hardware		
D4 Surface-Mount, Polished Edge Mirror	MSMK30D4P	\$ 149.
D6 Surface-Mount, Polished Edge Mirror	MSMK30D6P	\$ 199.
D6 Semi-Recessed, Polished Edge Mirror	MSMK30D6SRP	\$ 149.

See page 274 for Decorative surface-mount kit options.

See Bottom Kits on page 275.

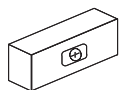

Safety Lock Box	SLB-*	\$ 279.
Full compartment keyed lock box in an anodized aluminum finish		

* Follow SLB with first 2 numbers (width) of cabinet model, then depth of cabinet model. Example: SLB20D4

Light Options include:

Main Line Sconces
Refer to page 259 for more information.

Other Options:

Main Line Framed Wall Mirrors
See pages 34 – 35.

Magnifying Mirror: POMM, SOMM
See page 272.

Glass Bins
See page 272.

SEE PAGE 203 FOR TIPS AND FEATURES.

Bryn Mawr® Framed Cabinets – 24" W x 30" H



A framed medicine cabinet that is versatile enough to enhance any design approach, the Main Line Collection offers 4 framed profiles with 7 metal finishes and a variety of size options.

- Available in four uniquely designed frame profiles: Bryn Mawr, Merion®, Penn Valley®, Rosemont®
- Frame profiles available in 7 metal finish options
- Pair with Main Line Sconces for a coordinated look
- ETL certified to UL 962, CSA Standard C22.2 No. 68

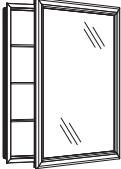
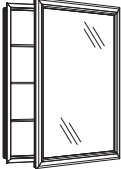

Bryn Mawr 24" W x 30" H Cabinets

Description	Model	FINISHES		
		70, 71 Price	74, 75, 79 Price	76, 77 Price
4" Deep (D4): 23-1/4" W x 30" H (RO: 22-1/2" W x 29-1/4" H x 4" D)				
 Non-Handed	DC2430D4BMG __	\$ 949.	\$ 1,079.	\$ 1,279.
Left – Electric	DC2430D4BMGLE __	\$ 1,249.	\$ 1,349.	\$ 1,579.
Right – Electric	DC2430D4BMGRE __	\$ 1,249.	\$ 1,349.	\$ 1,579.
6" Deep (D6): 23-1/4" W x 30" H (RO: 22-1/2" W x 29-1/4" H x 6" D)				
 Non-Handed	DC2430D6BMG __	\$ 1,229.	\$ 1,329.	\$ 1,549.
Left – Electric	DC2430D6BMGLE __	\$ 1,529.	\$ 1,629.	\$ 1,849.
Right – Electric	DC2430D6BMGRE __	\$ 1,529.	\$ 1,629.	\$ 1,849.

Finish Options

Fill in __ designator to Model listed above with desired finish. Example: DC2430D4BMGRE76.

70 Satin Nickel	76 Chrome
71 Brushed Nickel	77 Polished Nickel
74 Brushed Black	79 White
75 Brushed Bronze	

Accessories & Options

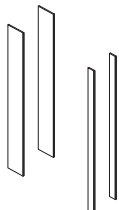

Description	Model	Price
Surface-Mount Kit for 30" H Mirrored Cabinets Quantity 1 = Pair of Side Kits and Mounting Hardware		
D4 Surface-Mount, Polished Edge Mirror	MSMK30D4P	\$ 149.
D6 Surface-Mount, Polished Edge Mirror	MSMK30D6P	\$ 199.
D6 Semi-Recessed, Polished Edge Mirror	MSMK30D6SRP	\$ 149.

See page 274 for Decorative surface-mount kit options.

See **Bottom Kits on page 275.**

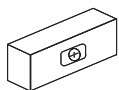

Safety Lock Box	SLB-*	\$ 279.
Full compartment keyed lock box in an anodized aluminum finish		

* Follow SLB with first 2 numbers (width) of cabinet model, then depth of cabinet model. Example: SLB24D6

Light Options include:

Main Line Sconces
Refer to page 259 for more information.

Other Options:

Main Line Framed Wall Mirrors
See pages 34 – 35.

Magnifying Mirror: POMM, SOMM
See page 272.

Glass Bins
See page 272.

SEE PAGE 203 FOR TIPS AND FEATURES.

Bryn Mawr® Framed Cabinets – 16" W x 40" H



A framed medicine cabinet that is versatile enough to enhance any design approach, the Main Line Collection offers 4 framed profiles with 7 metal finishes and a variety of size options.

- Available in four uniquely designed frame profiles: Bryn Mawr, Merion®, Penn Valley®, Rosemont®
- Frame profiles available in 7 metal finish options
- Pair with Main Line Sconces for a coordinated look
- ETL certified to UL 962, CSA Standard C22.2 No. 68



Two Week Lead Time





Electrical Outlet

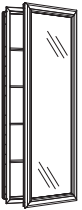

Magnifying Mirror

Bryn Mawr 16" W x 40" H Cabinets

Description	Model	FINISHES		
		70, 71 Price	74, 75, 79 Price	76, 77 Price
4" Deep (D4): 15-1/4" W x 39-3/8" H (RO: 14-1/2" W x 38-5/8" H x 4" D)				
 Non-Handed	DC1640D4BMG __	\$ 949.	\$ 1,079.	\$ 1,279.
Left – Electric	DC1640D4BMGLE __	\$ 1,249.	\$ 1,349.	\$ 1,579.
Right – Electric	DC1640D4BMGRE __	\$ 1,249.	\$ 1,349.	\$ 1,579.
6" Deep (D6): 15-1/4" W x 39-3/8" H (RO: 14-1/2" W x 38-5/8" H x 6" D)				
 Non-Handed	DC1640D6BMG __	\$ 1,229.	\$ 1,329.	\$ 1,549.
Left – Electric	DC1640D6BMGLE __	\$ 1,529.	\$ 1,629.	\$ 1,849.
Right – Electric	DC1640D6BMGRE __	\$ 1,529.	\$ 1,629.	\$ 1,849.

Finish Options

Fill in __ designator to Model listed above with desired finish. Example: DC1640D4BMG74.

70 Satin Nickel	76 Chrome
71 Brushed Nickel	77 Polished Nickel
74 Brushed Black	79 White
75 Brushed Bronze	

Accessories & Options

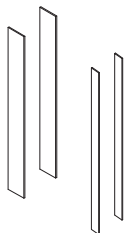

Description	Model	Price
Surface-Mount Kit for 40" H Mirrored Cabinets Quantity 1 = Pair of Side Kits and Mounting Hardware		
D4 Surface-Mount, Polished Edge Mirror	MSMK40D4P	\$ 249.
D6 Surface-Mount, Polished Edge Mirror	MSMK40D6P	\$ 329.
D6 Semi-Recessed, Polished Edge Mirror	MSMK40D6SRP	\$ 249.

See page 274 for Decorative surface-mount kit options.

See Bottom Kits on page 275.

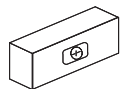

Safety Lock Box	SLB-*	\$ 279.
------------------------	-------	---------

Full compartment keyed lock box in an anodized aluminum finish

* Follow SLB with first 2 numbers (width) of cabinet model, then depth of cabinet model. Example: SLB16D4

Light Options include:

Main Line Sconces
Refer to page 259 for more information.

Other Options:

Main Line Framed Wall Mirrors
See pages 34 – 35.

Magnifying Mirror: POMM, SOMM
See page 272.

Glass Bins
See page 272.

SEE PAGE 203 FOR TIPS AND FEATURES.

Bryn Mawr® Framed Cabinets – 20" W x 40" H



A framed medicine cabinet that is versatile enough to enhance any design approach, the Main Line Collection offers 4 framed profiles with 7 metal finishes and a variety of size options.

- Available in four uniquely designed frame profiles: Bryn Mawr, Merion®, Penn Valley®, Rosemont®
- Frame profiles available in 7 metal finish options
- Pair with Main Line Sconces for a coordinated look
- ETL certified to UL 962, CSA Standard C22.2 No. 68



Two Week Lead Time



Electrical Outlet



Magnifying Mirror

Bryn Mawr 20" W x 40" H Cabinets

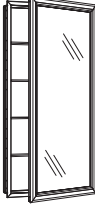
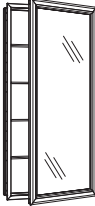
Description	Model	FINISHES		
		70, 71 Price	74, 75, 79 Price	76, 77 Price
4" Deep (D4): 19-1/4" W x 39-3/8" H (RO: 18-1/2" W x 38-5/8" H x 4" D)				
 Non-Handed	DC2040D4BMG __	\$ 1,079.	\$ 1,179.	\$ 1,399.
Left – Electric	DC2040D4BMGLE __	\$ 1,349.	\$ 1,479.	\$ 1,679.
Right – Electric	DC2040D4BMGRE __	\$ 1,349.	\$ 1,479.	\$ 1,679.
6" Deep (D6): 19-1/4" W x 39-3/8" H (RO: 18-1/2" W x 38-5/8" H x 6" D)				
 Non-Handed	DC2040D6BMG __	\$ 1,329.	\$ 1,449.	\$ 1,649.
Left – Electric	DC2040D6BMGLE __	\$ 1,629.	\$ 1,749.	\$ 1,949.
Right – Electric	DC2040D6BMGRE __	\$ 1,629.	\$ 1,749.	\$ 1,949.

Finish Options

Fill in __ designator to Model listed above with desired finish. Example: DC2040D6BMGLE70.

70 Satin Nickel	76 Chrome
71 Brushed Nickel	77 Polished Nickel
74 Brushed Black	79 White
75 Brushed Bronze	

Accessories & Options

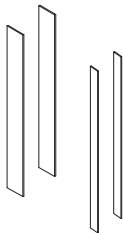

Description	Model	Price
Surface-Mount Kit for 40" H Mirrored Cabinets Quantity 1 = Pair of Side Kits and Mounting Hardware		
D4 Surface-Mount, Polished Edge Mirror	MSMK40D4P	\$ 249.
D6 Surface-Mount, Polished Edge Mirror	MSMK40D6P	\$ 329.
D6 Semi-Recessed, Polished Edge Mirror	MSMK40D6SRP	\$ 249.

See page 274 for Decorative surface-mount kit options.

See Bottom Kits on page 275.

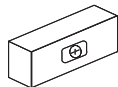

Safety Lock Box	SLB.*	\$ 279.
Full compartment keyed lock box in an anodized aluminum finish		

* Follow SLB with first 2 numbers (width) of cabinet model, then depth of cabinet model. Example: SLB20D4

Light Options include:

Main Line Sconces
Refer to page 259 for more information.

Other Options:

Main Line Framed Wall Mirrors
See pages 34 – 35.

Magnifying Mirror: POMM, SOMM
See page 272.

Glass Bins
See page 272.

SEE PAGE 203 FOR TIPS AND FEATURES.

Bryn Mawr® Framed Cabinets – 24" W x 40" H



A framed medicine cabinet that is versatile enough to enhance any design approach, the Main Line Collection offers 4 framed profiles with 7 metal finishes and a variety of size options.

- Available in four uniquely designed frame profiles: Bryn Mawr, Merion®, Penn Valley®, Rosemont®
- Frame profiles available in 7 metal finish options
- Pair with Main Line Sconces for a coordinated look
- ETL certified to UL 962, CSA Standard C22.2 No. 68



Two Week Lead Time



Electrical Outlet



Magnifying Mirror

Bryn Mawr 24" W x 40" H Cabinets

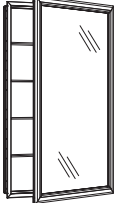
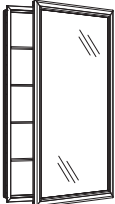
Description	Model	FINISHES		
		70, 71 Price	74, 75, 79 Price	76, 77 Price
4" Deep (D4): 23-1/4" W x 39-3/8" H (RO: 22-1/2" W x 38-5/8" H x 4" D)				
 Non-Handed	DC2440D4BMG __	\$ 1,179.	\$ 1,279.	\$ 1,499.
Left – Electric	DC2440D4BMGLE __	\$ 1,479.	\$ 1,579.	\$ 1,799.
Right – Electric	DC2440D4BMGRE __	\$ 1,479.	\$ 1,579.	\$ 1,799.
6" Deep (D6): 23-1/4" W x 39-3/8" H (RO: 22-1/2" W x 38-5/8" H x 6" D)				
 Non-Handed	DC2440D6BMG __	\$ 1,449.	\$ 1,549.	\$ 1,749.
Left – Electric	DC2440D6BMGLE __	\$ 1,749.	\$ 1,849.	\$ 2,079.
Right – Electric	DC2440D6BMGRE __	\$ 1,749.	\$ 1,849.	\$ 2,079.

Finish Options

Fill in __ designator to Model listed above with desired finish. Example: DC2440D4BMGRE76.

70 Satin Nickel	76 Chrome
71 Brushed Nickel	77 Polished Nickel
74 Brushed Black	79 White
75 Brushed Bronze	

Accessories & Options

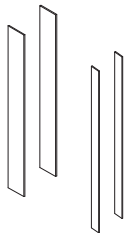

Description

Surface-Mount Kit for 40" H Mirrored Cabinets Quantity 1 = Pair of Side Kits and Mounting Hardware

D4 Surface-Mount, Polished Edge Mirror	MSMK40D4P	\$ 249.
D6 Surface-Mount, Polished Edge Mirror	MSMK40D6P	\$ 329.
D6 Semi-Recessed, Polished Edge Mirror	MSMK40D6SRP	\$ 249.

See page 274 for Decorative surface-mount kit options.

See Bottom Kits on page 275.

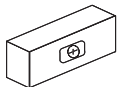

Safety Lock Box

Full compartment keyed lock box in an anodized aluminum finish

* Follow SLB with first 2 numbers (width) of cabinet model, then depth of cabinet model. Example: SLB24D6

Model SLB-* Price \$ 279.

Light Options include:

Main Line Sconces
Refer to page 259 for more information.

Other Options:

Main Line Framed Wall Mirrors
See pages 34 – 35.

Magnifying Mirror: POMM, SOMM
See page 272.

Glass Bins
See page 272.

SEE PAGE 203 FOR TIPS AND FEATURES.

Merion® Framed Cabinets – 16" W x 30" H



A framed medicine cabinet that is versatile enough to enhance any design approach, the Main Line Collection offers 4 framed profiles with 7 metal finishes and a variety of size options.

- Available in four uniquely designed frame profiles: Bryn Mawr®, Merion, Penn Valley®, Rosemont®
- Frame profiles available in 7 metal finish options
- Pair with Main Line Sconces for a coordinated look
- ETL certified to UL 962, CSA Standard C22.2 No. 68



Two Week Lead Time





Electrical Outlet



Magnifying Mirror

Merion 16" W x 30" H Cabinets

Description	Model	FINISHES		
		70, 71 Price	74, 75, 79 Price	76, 77 Price
4" Deep (D4): 15-1/4" W x 30" H (RO: 14-1/2" W x 29-1/4" H x 4" D)				
 Non-Handed	DC1630D4MEG __	\$ 749.	\$ 849.	\$ 1,079.
Left – Electric	DC1630D4MEGLE __	\$ 1,029.	\$ 1,149.	\$ 1,349.
Right – Electric	DC1630D4MEGRE __	\$ 1,029.	\$ 1,149.	\$ 1,349.
6" Deep (D6): 15-1/4" W x 30" H (RO: 14-1/2" W x 29-1/4" H x 6" D)				
 Non-Handed	DC1630D6MEG __	\$ 1,029.	\$ 1,129.	\$ 1,329.
Left – Electric	DC1630D6MEGLE __	\$ 1,299.	\$ 1,429.	\$ 1,629.
Right – Electric	DC1630D6MEGRE __	\$ 1,299.	\$ 1,429.	\$ 1,629.

Finish Options

Fill in __ designator to Model listed above with desired finish. Example: DC1630D4MEG74.

70 Satin Nickel	76 Chrome
71 Brushed Nickel	77 Polished Nickel
74 Brushed Black	79 White
75 Brushed Bronze	

Accessories & Options

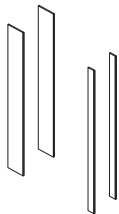

Description	Model	Price
Surface-Mount Kit for 30" H Mirrored Cabinets Quantity 1 = Pair of Side Kits and Mounting Hardware		
D4 Surface-Mount, Polished Edge Mirror	MSMK30D4P	\$ 149.
D6 Surface-Mount, Polished Edge Mirror	MSMK30D6P	\$ 199.
D6 Semi-Recessed, Polished Edge Mirror	MSMK30D6SRP	\$ 149.

See page 274 for Decorative surface-mount kit options.

See Bottom Kits on page 275.

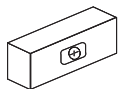

Safety Lock Box	SLB-*	\$ 279.
------------------------	-------	---------

Full compartment keyed lock box in an anodized aluminum finish
* Follow SLB with first 2 numbers (width) of cabinet model, then depth of cabinet model. Example: SLB16D4

Light Options include:

Main Line Sconces
Refer to page 259 for more information.

Other Options:

Main Line Framed Wall Mirrors
See pages 34 – 35.

Magnifying Mirror: POMM, SOMM
See page 272.

Glass Bins
See page 272.

SEE PAGE 203 FOR TIPS AND FEATURES.

Merion® Framed Cabinets – 20" W x 30" H



A framed medicine cabinet that is versatile enough to enhance any design approach, the Main Line Collection offers 4 framed profiles with 7 metal finishes and a variety of size options.

- Available in four uniquely designed frame profiles: Bryn Mawr®, Merion, Penn Valley®, Rosemont®
- Frame profiles available in 7 metal finish options
- Pair with Main Line Sconces for a coordinated look
- ETL certified to UL 962, CSA Standard C22.2 No. 68



Two Week Lead Time



Electrical Outlet



Magnifying Mirror

Merion 20" W x 30" H Cabinets

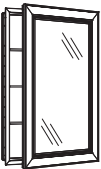
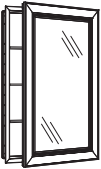
Description	Model	FINISHES		
		70, 71 Price	74, 75, 79 Price	76, 77 Price
4" Deep (D4): 19-1/4" W x 30" H (RO: 18-1/2" W x 29-1/4" H x 4" D)				
 Non-Handed	DC2030D4MEG __	\$ 849.	\$ 949.	\$ 1,179.
Left – Electric	DC2030D4MEGLE __	\$ 1,149.	\$ 1,249.	\$ 1,479.
Right – Electric	DC2030D4MEGRE __	\$ 1,149.	\$ 1,249.	\$ 1,479.
6" Deep (D6): 19-1/4" W x 30" H (RO: 18-1/2" W x 29-1/4" H x 6" D)				
 Non-Handed	DC2030D6MEG __	\$ 1,129.	\$ 1,229.	\$ 1,449.
Left – Electric	DC2030D6MEGLE __	\$ 1,429.	\$ 1,529.	\$ 1,749.
Right – Electric	DC2030D6MEGRE __	\$ 1,429.	\$ 1,529.	\$ 1,749.

Finish Options

Fill in __ designator to Model listed above with desired finish. Example: DC2030D6MEGLE70.

70	Satin Nickel	76	Chrome
71	Brushed Nickel	77	Polished Nickel
74	Brushed Black	79	White
75	Brushed Bronze		

Accessories & Options

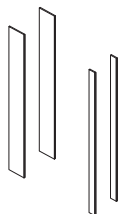

Description	Model	Price
Surface-Mount Kit for 30" H Mirrored Cabinets Quantity 1 = Pair of Side Kits and Mounting Hardware		
D4 Surface-Mount, Polished Edge Mirror	MSMK30D4P	\$ 149.
D6 Surface-Mount, Polished Edge Mirror	MSMK30D6P	\$ 199.
D6 Semi-Recessed, Polished Edge Mirror	MSMK30D6SRP	\$ 149.

See page 274 for Decorative surface-mount kit options.

See Bottom Kits on page 275.

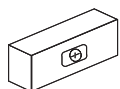

Safety Lock Box	SLB-*	\$ 279.
Full compartment keyed lock box in an anodized aluminum finish		

* Follow SLB with first 2 numbers (width) of cabinet model, then depth of cabinet model. Example: SLB20D4

Light Options include:

Main Line Sconces
Refer to page 259 for more information.

Other Options:

Main Line Framed Wall Mirrors
See pages 34 – 35.

Magnifying Mirror: POMM, SOMM
See page 272.

Glass Bins
See page 272.

SEE PAGE 203 FOR TIPS AND FEATURES.

Merion® Framed Cabinets – 24" W x 30" H



A framed medicine cabinet that is versatile enough to enhance any design approach, the Main Line Collection offers 4 framed profiles with 7 metal finishes and a variety of size options.

- Available in four uniquely designed frame profiles: Bryn Mawr®, Merion, Penn Valley®, Rosemont®
- Frame profiles available in 7 metal finish options
- Pair with Main Line Sconces for a coordinated look
- ETL certified to UL 962, CSA Standard C22.2 No. 68

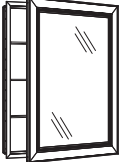
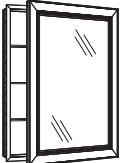

Merion 24" W x 30" H Cabinets

Description	Model	FINISHES		
		70, 71 Price	74, 75, 79 Price	76, 77 Price
4" Deep (D4): 23-1/4" W x 30" H (RO: 22-1/2" W x 29-1/4" H x 4" D)				
 Non-Handed	DC2430D4MEG __	\$ 949.	\$ 1,079.	\$ 1,279.
Left – Electric	DC2430D4MEGLE __	\$ 1,249.	\$ 1,349.	\$ 1,579.
Right – Electric	DC2430D4MEGRE __	\$ 1,249.	\$ 1,349.	\$ 1,579.
6" Deep (D6): 23-1/4" W x 30" H (RO: 22-1/2" W x 29-1/4" H x 6" D)				
 Non-Handed	DC2430D6MEG __	\$ 1,229.	\$ 1,329.	\$ 1,549.
Left – Electric	DC2430D6MEGLE __	\$ 1,529.	\$ 1,629.	\$ 1,849.
Right – Electric	DC2430D6MEGRE __	\$ 1,529.	\$ 1,629.	\$ 1,849.

Cabinets

Finish Options

Fill in __ designator to Model listed above with desired finish. Example: DC2430D4MEGRE75.

70 Satin Nickel	76 Chrome
71 Brushed Nickel	77 Polished Nickel
74 Brushed Black	79 White
75 Brushed Bronze	

Accessories & Options

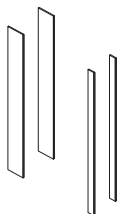

Description	Model	Price
Surface-Mount Kit for 30" H Mirrored Cabinets Quantity 1 = Pair of Side Kits and Mounting Hardware		
D4 Surface-Mount, Polished Edge Mirror	MSMK30D4P	\$ 149.
D6 Surface-Mount, Polished Edge Mirror	MSMK30D6P	\$ 199.
D6 Semi-Recessed, Polished Edge Mirror	MSMK30D6SRP	\$ 149.

See page 274 for Decorative surface-mount kit options.

See Bottom Kits on page 275.

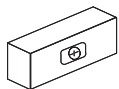

Safety Lock Box	SLB-*	\$ 279.
Full compartment keyed lock box in an anodized aluminum finish		

* Follow SLB with first 2 numbers (width) of cabinet model, then depth of cabinet model. Example: SLB24D6

Light Options include:

Main Line Sconces
Refer to page 259 for more information.

Other Options:

Main Line Framed Wall Mirrors
See pages 34 – 35.

Magnifying Mirror: POMM, SOMM
See page 272.

Glass Bins
See page 272.

SEE PAGE 203 FOR TIPS AND FEATURES.

Merion® Framed Cabinets – 16" W x 40" H



A framed medicine cabinet that is versatile enough to enhance any design approach, the Main Line Collection offers 4 framed profiles with 7 metal finishes and a variety of size options.

- Available in four uniquely designed frame profiles: Bryn Mawr®, Merion, Penn Valley®, Rosemont®
- Frame profiles available in 7 metal finish options
- Pair with Main Line Sconces for a coordinated look
- ETL certified to UL 962, CSA Standard C22.2 No. 68



Two Week Lead Time



Electrical Outlet



Magnifying Mirror

Merion 16" W x 40" H Cabinets

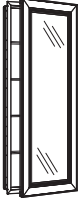
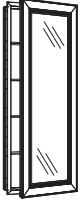
Description	Model	FINISHES		
		70, 71 Price	74, 75, 79 Price	76, 77 Price
4" Deep (D4): 15-1/4" W x 39-3/8" H (RO: 14-1/2" W x 38-5/8" H x 4" D)				
 Non-Handed	DC1640D4MEG __	\$ 949.	\$ 1,079.	\$ 1,279.
Left – Electric	DC1640D4MEGLE __	\$ 1,249.	\$ 1,349.	\$ 1,579.
Right – Electric	DC1640D4MEGRE __	\$ 1,249.	\$ 1,349.	\$ 1,579.
6" Deep (D6): 15-1/4" W x 39-3/8" H (RO: 14-1/2" W x 38-5/8" H x 6" D)				
 Non-Handed	DC1640D6MEG __	\$ 1,229.	\$ 1,329.	\$ 1,549.
Left – Electric	DC1640D6MEGLE __	\$ 1,529.	\$ 1,629.	\$ 1,849.
Right – Electric	DC1640D6MEGRE __	\$ 1,529.	\$ 1,629.	\$ 1,849.

Finish Options

Fill in __ designator to Model listed above with desired finish. Example: DC1640D4MEG74.

70 Satin Nickel	76 Chrome
71 Brushed Nickel	77 Polished Nickel
74 Brushed Black	79 White
75 Brushed Bronze	

Accessories & Options

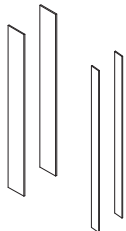

Description	Model	Price
Surface-Mount Kit for 40" H Mirrored Cabinets Quantity 1 = Pair of Side Kits and Mounting Hardware		
D4 Surface-Mount, Polished Edge Mirror	MSMK40D4P	\$ 249.
D6 Surface-Mount, Polished Edge Mirror	MSMK40D6P	\$ 329.
D6 Semi-Recessed, Polished Edge Mirror	MSMK40D6SRP	\$ 249.

See page 274 for Decorative surface-mount kit options.

See Bottom Kits on page 275.

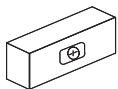

Safety Lock Box	SLB-*	\$ 279.
------------------------	-------	---------

Full compartment keyed lock box in an anodized aluminum finish

* Follow SLB with first 2 numbers (width) of cabinet model, then depth of cabinet model. Example: SLB16D4

Light Options include:

Main Line Sconces
Refer to page 259 for more information.

Other Options:

Main Line Framed Wall Mirrors
See pages 34 – 35.

Magnifying Mirror: POMM, SOMM
See page 272.

Glass Bins
See page 272.

SEE PAGE 203 FOR TIPS AND FEATURES.

Merion® Framed Cabinets – 20" W x 40" H



A framed medicine cabinet that is versatile enough to enhance any design approach, the Main Line Collection offers 4 framed profiles with 7 metal finishes and a variety of size options.

- Available in four uniquely designed frame profiles: Bryn Mawr®, Merion, Penn Valley®, Rosemont®
- Frame profiles available in 7 metal finish options
- Pair with Main Line Sconces for a coordinated look
- ETL certified to UL 962, CSA Standard C22.2 No. 68



Two Week Lead Time



Electrical Outlet



Magnifying Mirror

Merion 20" W x 40" H Cabinets

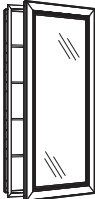
Description	Model	FINISHES		
		70, 71 Price	74, 75, 79 Price	76, 77 Price
4" Deep (D4): 19-1/4" W x 39-3/8" H (RO: 18-1/2" W x 38-5/8" H x 4" D)				
 Non-Handed	DC2040D4MEG __	\$ 1,079.	\$ 1,179.	\$ 1,399.
Left – Electric	DC2040D4MEGLE __	\$ 1,349.	\$ 1,479.	\$ 1,679.
Right – Electric	DC2040D4MEGRE __	\$ 1,349.	\$ 1,479.	\$ 1,679.
6" Deep (D6): 19-1/4" W x 39-3/8" H (RO: 18-1/2" W x 38-5/8" H x 6" D)				
 Non-Handed	DC2040D6MEG __	\$ 1,329.	\$ 1,449.	\$ 1,649.
Left – Electric	DC2040D6MEGLE __	\$ 1,629.	\$ 1,749.	\$ 1,949.
Right – Electric	DC2040D6MEGRE __	\$ 1,629.	\$ 1,749.	\$ 1,949.

Cabinets

Finish Options

Fill in __ designator to Model listed above with desired finish. Example: DC2040D6MEGLE70.

70 Satin Nickel	76 Chrome
71 Brushed Nickel	77 Polished Nickel
74 Brushed Black	79 White
75 Brushed Bronze	

Accessories & Options

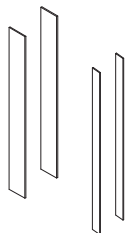

Description

Surface-Mount Kit for 40" H Mirrored Cabinets Quantity 1 = Pair of Side Kits and Mounting Hardware

Description	Model	Price
D4 Surface-Mount, Polished Edge Mirror	MSMK40D4P	\$ 249.
D6 Surface-Mount, Polished Edge Mirror	MSMK40D6P	\$ 329.
D6 Semi-Recessed, Polished Edge Mirror	MSMK40D6SRP	\$ 249.

See page 274 for Decorative surface-mount kit options.

See Bottom Kits on page 275.

Safety Lock Box

SLB.*

\$ 279.

Full compartment keyed lock box in an anodized aluminum finish

* Follow SLB with first 2 numbers (width) of cabinet model, then depth of cabinet model. Example: SLB20D4

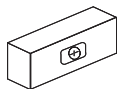

Light Options include:

Main Line Sconces
Refer to page 259 for more information.

Other Options:

Main Line Framed Wall Mirrors
See pages 34 – 35.

Magnifying Mirror: POMM, SOMM
See page 272.

Glass Bins
See page 272.

SEE PAGE 203 FOR TIPS AND FEATURES.

Merion® Framed Cabinets – 24" W x 40" H



A framed medicine cabinet that is versatile enough to enhance any design approach, the Main Line Collection offers 4 framed profiles with 7 metal finishes and a variety of size options.

- Available in four uniquely designed frame profiles: Bryn Mawr®, Merion, Penn Valley®, Rosemont®
- Frame profiles available in 7 metal finish options
- Pair with Main Line Sconces for a coordinated look
- ETL certified to UL 962, CSA Standard C22.2 No. 68



Two Week Lead Time



Electrical Outlet



Magnifying Mirror

Merion 24" W x 40" H Cabinets

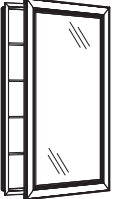
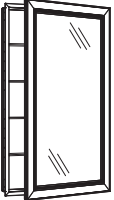
Description	Model	FINISHES		
		70, 71 Price	74, 75, 79 Price	76, 77 Price
4" Deep (D4): 23-1/4" W x 39-3/8" H (RO: 22-1/2" W x 38-5/8" H x 4" D)				
 Non-Handed	DC2440D4MEG __	\$ 1,179.	\$ 1,279.	\$ 1,499.
Left – Electric	DC2440D4MEGLE __	\$ 1,479.	\$ 1,579.	\$ 1,799.
Right – Electric	DC2440D4MEGRE __	\$ 1,479.	\$ 1,579.	\$ 1,799.
6" Deep (D6): 23-1/4" W x 39-3/8" H (RO: 22-1/2" W x 38-5/8" H x 6" D)				
 Non-Handed	DC2440D6MEG __	\$ 1,449.	\$ 1,549.	\$ 1,749.
Left – Electric	DC2440D6MEGLE __	\$ 1,749.	\$ 1,849.	\$ 2,079.
Right – Electric	DC2440D6MEGRE __	\$ 1,749.	\$ 1,849.	\$ 2,079.

Finish Options

Fill in __ designator to Model listed above with desired finish. Example: DC2440D4MEGRE75.

70 Satin Nickel	76 Chrome
71 Brushed Nickel	77 Polished Nickel
74 Brushed Black	79 White
75 Brushed Bronze	

Accessories & Options

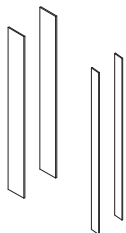

Description	Model	Price
Surface-Mount Kit for 40" H Mirrored Cabinets Quantity 1 = Pair of Side Kits and Mounting Hardware		
D4 Surface-Mount, Polished Edge Mirror	MSMK40D4P	\$ 249.
D6 Surface-Mount, Polished Edge Mirror	MSMK40D6P	\$ 329.
D6 Semi-Recessed, Polished Edge Mirror	MSMK40D6SRP	\$ 249.

See page 274 for Decorative surface-mount kit options.

See Bottom Kits on page 275.

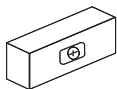

Safety Lock Box	SLB-*	\$ 279.
------------------------	-------	---------

Full compartment keyed lock box in an anodized aluminum finish

* Follow SLB with first 2 numbers (width) of cabinet model, then depth of cabinet model. Example: SLB24D6

Light Options include:

Main Line Sconces
Refer to page 259 for more information.

Other Options:

Main Line Framed Wall Mirrors
See pages 34 – 35.

Magnifying Mirror: POMM, SOMM
See page 272.

Glass Bins
See page 272.

SEE PAGE 203 FOR TIPS AND FEATURES.

Penn Valley® Framed Cabinets – 16" W x 30" H



A framed medicine cabinet that is versatile enough to enhance any design approach, the Main Line Collection offers 4 framed profiles with 7 metal finishes and a variety of size options.

- Available in four uniquely designed frame profiles: Bryn Mawr®, Merion®, Penn Valley, Rosemont®
- Frame profiles available in 7 metal finish options
- Pair with Main Line Sconces for a coordinated look
- ETL certified to UL 962, CSA Standard C22.2 No. 68



Two Week Lead Time



Electrical Outlet



Magnifying Mirror

Penn Valley 16" W x 30" H Cabinets

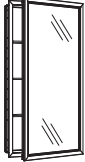
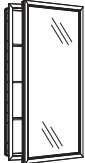
Description	Model	FINISHES		
		70, 71 Price	74, 75, 79 Price	76, 77 Price
4" Deep (D4): 15-1/4" W x 30" H (RO: 14-1/2" W x 29-1/4" H x 4" D)				
 Non-Handed	DC1630D4PVG __	\$ 749.	\$ 849.	\$ 1,079.
Left – Electric	DC1630D4PVGLE __	\$ 1,029.	\$ 1,149.	\$ 1,349.
Right – Electric	DC1630D4PVGRE __	\$ 1,029.	\$ 1,149.	\$ 1,349.
6" Deep (D6): 15-1/4" W x 30" H (RO: 14-1/2" W x 29-1/4" H x 6" D)				
 Non-Handed	DC1630D6PVG __	\$ 1,029.	\$ 1,129.	\$ 1,329.
Left – Electric	DC1630D6PVGLE __	\$ 1,299.	\$ 1,429.	\$ 1,629.
Right – Electric	DC1630D6PVGRE __	\$ 1,299.	\$ 1,429.	\$ 1,629.

Finish Options

Fill in __ designator to Model listed above with desired finish. Example: DC1630D4PVG74.

70 Satin Nickel	76 Chrome
71 Brushed Nickel	77 Polished Nickel
74 Brushed Black	79 White
75 Brushed Bronze	

Accessories & Options

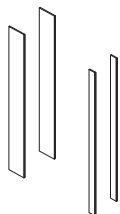

Description	Model	Price
Surface-Mount Kit for 30" H Mirrored Cabinets Quantity 1 = Pair of Side Kits and Mounting Hardware		
D4 Surface-Mount, Polished Edge Mirror	MSMK30D4P	\$ 149.
D6 Surface-Mount, Polished Edge Mirror	MSMK30D6P	\$ 199.
D6 Semi-Recessed, Polished Edge Mirror	MSMK30D6SRP	\$ 149.

See page 274 for Decorative surface-mount kit options.

See Bottom Kits on page 275.

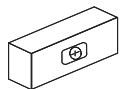

Safety Lock Box	SLB-*	\$ 279.
------------------------	-------	---------

Full compartment keyed lock box in an anodized aluminum finish

* Follow SLB with first 2 numbers (width) of cabinet model, then depth of cabinet model. Example: SLB16D4

Light Options include:

Main Line Sconces
Refer to page 259 for more information.

Other Options:

Main Line Framed Wall Mirrors
See pages 34 – 35.

Magnifying Mirror: POMM, SOMM
See page 272.

Glass Bins
See page 272.

SEE PAGE 203 FOR TIPS AND FEATURES.

Penn Valley® Framed Cabinets – 20" W x 30" H



A framed medicine cabinet that is versatile enough to enhance any design approach, the Main Line Collection offers 4 framed profiles with 7 metal finishes and a variety of size options.

- Available in four uniquely designed frame profiles: Bryn Mawr®, Merion®, Penn Valley, Rosemont®
- Frame profiles available in 7 metal finish options
- Pair with Main Line Sconces for a coordinated look
- ETL certified to UL 962, CSA Standard C22.2 No. 68



Two Week
Lead Time



Electrical
Outlet



Magnifying
Mirror

Penn Valley 20" W x 30" H Cabinets

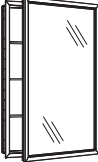
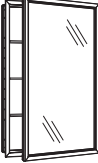
Description	Model	FINISHES		
		70, 71 Price	74, 75, 79 Price	76, 77 Price
4" Deep (D4): 19-1/4" W x 30" H (RO: 18-1/2" W x 29-1/4" H x 4" D)				
 Non-Handed	DC2030D4PVG __	\$ 849.	\$ 949.	\$ 1,179.
Left – Electric	DC2030D4PVGLE __	\$ 1,149.	\$ 1,249.	\$ 1,479.
Right – Electric	DC2030D4PVGRE __	\$ 1,149.	\$ 1,249.	\$ 1,479.
6" Deep (D6): 19-1/4" W x 30" H (RO: 18-1/2" W x 29-1/4" H x 6" D)				
 Non-Handed	DC2030D6PVG __	\$ 1,129.	\$ 1,229.	\$ 1,449.
Left – Electric	DC2030D6PVGLE __	\$ 1,429.	\$ 1,529.	\$ 1,749.
Right – Electric	DC2030D6PVGRE __	\$ 1,429.	\$ 1,529.	\$ 1,749.

Finish Options

Fill in __ designator to Model listed above with desired finish. Example: DC2030D6PVGLE70.

70 Satin Nickel	76 Chrome
71 Brushed Nickel	77 Polished Nickel
74 Brushed Black	79 White
75 Brushed Bronze	

Accessories & Options

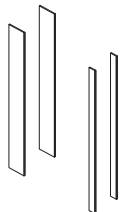

Description	Model	Price
Surface-Mount Kit for 30" H Mirrored Cabinets Quantity 1 = Pair of Side Kits and Mounting Hardware		
D4 Surface-Mount, Polished Edge Mirror	MSMK30D4P	\$ 149.
D6 Surface-Mount, Polished Edge Mirror	MSMK30D6P	\$ 199.
D6 Semi-Recessed, Polished Edge Mirror	MSMK30D6SRP	\$ 149.

See page 274 for Decorative surface-mount kit options.

See Bottom Kits on page 275.

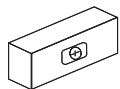

Safety Lock Box	SLB-*	\$ 279.
------------------------	-------	---------

Full compartment keyed lock box in an anodized aluminum finish
* Follow SLB with first 2 numbers (width) of cabinet model, then depth of cabinet model. Example: SLB20D4

Light Options include:

Main Line Sconces
Refer to page 259 for more information.

Other Options:

Main Line Framed Wall Mirrors
See pages 34 – 35.

Magnifying Mirror: POMM, SOMM
See page 272.

Glass Bins
See page 272.

SEE PAGE 203 FOR TIPS AND FEATURES.

Penn Valley® Framed Cabinets – 24" W x 30" H



A framed medicine cabinet that is versatile enough to enhance any design approach, the Main Line Collection offers 4 framed profiles with 7 metal finishes and a variety of size options.

- Available in four uniquely designed frame profiles: Bryn Mawr®, Merion®, Penn Valley, Rosemont®
- Frame profiles available in 7 metal finish options
- Pair with Main Line Sconces for a coordinated look
- ETL certified to UL 962, CSA Standard C22.2 No. 68

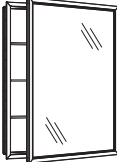
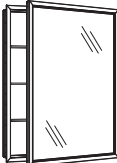

Penn Valley 24" W x 30" H Cabinets

Description	Model	FINISHES		
		70, 71 Price	74, 75, 79 Price	76, 77 Price
4" Deep (D4): 23-1/4" W x 30" H (RO: 22-1/2" W x 29-1/4" H x 4" D)				
 Non-Handed	DC2430D4PVG __	\$ 949.	\$ 1,079.	\$ 1,279.
Left – Electric	DC2430D4PVGLE __	\$ 1,249.	\$ 1,349.	\$ 1,579.
Right – Electric	DC2430D4PVGRE __	\$ 1,249.	\$ 1,349.	\$ 1,579.
6" Deep (D6): 23-1/4" W x 30" H (RO: 22-1/2" W x 29-1/4" H x 6" D)				
 Non-Handed	DC2430D6PVG __	\$ 1,229.	\$ 1,329.	\$ 1,549.
Left – Electric	DC2430D6PVGLE __	\$ 1,529.	\$ 1,629.	\$ 1,849.
Right – Electric	DC2430D6PVGRE __	\$ 1,529.	\$ 1,629.	\$ 1,849.

Cabinets

Finish Options

Fill in __ designator to Model listed above with desired finish. Example: DC2430D4PVGRE75.

70 Satin Nickel	76 Chrome
71 Brushed Nickel	77 Polished Nickel
74 Brushed Black	79 White
75 Brushed Bronze	

Accessories & Options

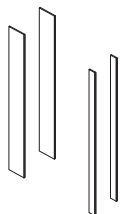

Description	Model	Price
Surface-Mount Kit for 30" H Mirrored Cabinets Quantity 1 = Pair of Side Kits and Mounting Hardware		
D4 Surface-Mount, Polished Edge Mirror	MSMK30D4P	\$ 149.
D6 Surface-Mount, Polished Edge Mirror	MSMK30D6P	\$ 199.
D6 Semi-Recessed, Polished Edge Mirror	MSMK30D6SRP	\$ 149.

See page 274 for Decorative surface-mount kit options.

See Bottom Kits on page 275.

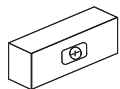

Safety Lock Box	SLB-*	\$ 279.
Full compartment keyed lock box in an anodized aluminum finish		

* Follow SLB with first 2 numbers (width) of cabinet model, then depth of cabinet model. Example: SLB24D6

Light Options include:

Main Line Sconces
Refer to page 259 for more information.

Other Options:

Main Line Framed Wall Mirrors
See pages 34 – 35.

Magnifying Mirror: POMM, SOMM
See page 272.

Glass Bins
See page 272.

SEE PAGE 203 FOR TIPS AND FEATURES.

Penn Valley® Framed Cabinets – 16" W x 40" H



A framed medicine cabinet that is versatile enough to enhance any design approach, the Main Line Collection offers 4 framed profiles with 7 metal finishes and a variety of size options.

- Available in four uniquely designed frame profiles: Bryn Mawr®, Merion®, Penn Valley, Rosemont®
- Frame profiles available in 7 metal finish options
- Pair with Main Line Sconces for a coordinated look
- ETL certified to UL 962, CSA Standard C22.2 No. 68



Two Week Lead Time





Electrical Outlet

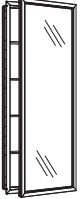

Magnifying Mirror

Penn Valley 16" W x 40" H Cabinets

Description	Model	FINISHES		
		70, 71 Price	74, 75, 79 Price	76, 77 Price
4" Deep (D4): 15-1/4" W x 39-3/8" H (RO: 14-1/2" W x 38-5/8" H x 4" D)				
 Non-Handed	DC1640D4PVG __	\$ 949.	\$ 1,079.	\$ 1,279.
Left – Electric	DC1640D4PVGLE __	\$ 1,249.	\$ 1,349.	\$ 1,579.
Right – Electric	DC1640D4PVGRE __	\$ 1,249.	\$ 1,349.	\$ 1,579.
6" Deep (D6): 15-1/4" W x 39-3/8" H (RO: 14-1/2" W x 38-5/8" H x 6" D)				
 Non-Handed	DC1640D6PVG __	\$ 1,229.	\$ 1,329.	\$ 1,549.
Left – Electric	DC1640D6PVGLE __	\$ 1,529.	\$ 1,629.	\$ 1,849.
Right – Electric	DC1640D6PVGRE __	\$ 1,529.	\$ 1,629.	\$ 1,849.

Finish Options

Fill in __ designator to Model listed above with desired finish. Example: DC1640D4PVG74.

70 Satin Nickel	76 Chrome
71 Brushed Nickel	77 Polished Nickel
74 Brushed Black	79 White
75 Brushed Bronze	

Accessories & Options

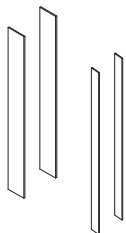

Description	Model	Price
Surface-Mount Kit for 40" H Mirrored Cabinets Quantity 1 = Pair of Side Kits and Mounting Hardware		
D4 Surface-Mount, Polished Edge Mirror	MSMK40D4P	\$ 249.
D6 Surface-Mount, Polished Edge Mirror	MSMK40D6P	\$ 329.
D6 Semi-Recessed, Polished Edge Mirror	MSMK40D6SRP	\$ 249.

See page 274 for Decorative surface-mount kit options.

See Bottom Kits on page 275.

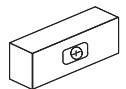

Safety Lock Box	SLB-*	\$ 279.
Full compartment keyed lock box in an anodized aluminum finish		

* Follow SLB with first 2 numbers (width) of cabinet model, then depth of cabinet model. Example: SLB16D4

Light Options include:

Main Line Sconces
Refer to page 259 for more information.

Other Options:

Main Line Framed Wall Mirrors
See pages 34 – 35.

Magnifying Mirror: POMM, SOMM
See page 272.

Glass Bins
See page 272.

SEE PAGE 203 FOR TIPS AND FEATURES.

Penn Valley® Framed Cabinets – 20" W x 40" H



A framed medicine cabinet that is versatile enough to enhance any design approach, the Main Line Collection offers 4 framed profiles with 7 metal finishes and a variety of size options.

- Available in four uniquely designed frame profiles: Bryn Mawr®, Merion®, Penn Valley, Rosemont®
- Frame profiles available in 7 metal finish options
- Pair with Main Line Sconces for a coordinated look
- ETL certified to UL 962, CSA Standard C22.2 No. 68



Two Week Lead Time



Electrical Outlet



Magnifying Mirror

Penn Valley 20" W x 40" H Cabinets

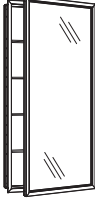
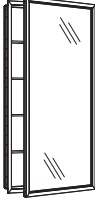
Description	Model	FINISHES		
		70, 71 Price	74, 75, 79 Price	76, 77 Price
4" Deep (D4): 19-1/4" W x 39-3/8" H (RO: 18-1/2" W x 38-5/8" H x 4" D)				
 Non-Handed	DC2040D4PVG __	\$ 1,079.	\$ 1,179.	\$ 1,399.
Left – Electric	DC2040D4PVGLE __	\$ 1,349.	\$ 1,479.	\$ 1,679.
Right – Electric	DC2040D4PVGRE __	\$ 1,349.	\$ 1,479.	\$ 1,679.
6" Deep (D6): 19-1/4" W x 39-3/8" H (RO: 18-1/2" W x 38-5/8" H x 6" D)				
 Non-Handed	DC2040D6PVG __	\$ 1,329.	\$ 1,449.	\$ 1,649.
Left – Electric	DC2040D6PVGLE __	\$ 1,629.	\$ 1,749.	\$ 1,949.
Right – Electric	DC2040D6PVGRE __	\$ 1,629.	\$ 1,749.	\$ 1,949.

Cabinets

Finish Options

Fill in __ designator to Model listed above with desired finish. Example: DC2040D6PVGLE70.

70 Satin Nickel	76 Chrome
71 Brushed Nickel	77 Polished Nickel
74 Brushed Black	79 White
75 Brushed Bronze	

Accessories & Options



Description

Surface-Mount Kit for 40" H Mirrored Cabinets Quantity 1 = Pair of Side Kits and Mounting Hardware

Description	Model	Price
D4 Surface-Mount, Polished Edge Mirror	MSMK40D4P	\$ 249.
D6 Surface-Mount, Polished Edge Mirror	MSMK40D6P	\$ 329.
D6 Semi-Recessed, Polished Edge Mirror	MSMK40D6SRP	\$ 249.

See page 274 for Decorative surface-mount kit options.

See Bottom Kits on page 275.

Safety Lock Box

SLB.*

\$ 279.

Full compartment keyed lock box in an anodized aluminum finish

* Follow SLB with first 2 numbers (width) of cabinet model, then depth of cabinet model. Example: SLB20D4

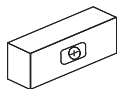

Light Options include:

Main Line Sconces
Refer to page 259 for more information.

Other Options:

Main Line Framed Wall Mirrors
See pages 34 – 35.

Magnifying Mirror: POMM, SOMM
See page 272.

Glass Bins
See page 272.

SEE PAGE 203 FOR TIPS AND FEATURES.

Penn Valley® Framed Cabinets – 24" W x 40" H



A framed medicine cabinet that is versatile enough to enhance any design approach, the Main Line Collection offers 4 framed profiles with 7 metal finishes and a variety of size options.

- Available in four uniquely designed frame profiles: Bryn Mawr®, Merion®, Penn Valley, Rosemont®
- Frame profiles available in 7 metal finish options
- Pair with Main Line Sconces for a coordinated look
- ETL certified to UL 962, CSA Standard C22.2 No. 68



Two Week Lead Time



Electrical Outlet



Magnifying Mirror

Penn Valley 24" W x 40" H Cabinets

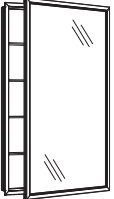
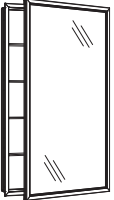
Description	Model	FINISHES		
		70, 71 Price	74, 75, 79 Price	76, 77 Price
4" Deep (D4): 23-1/4" W x 39-3/8" H (RO: 22-1/2" W x 38-5/8" H x 4" D)				
 Non-Handed	DC2440D4PVG __	\$ 1,179.	\$ 1,279.	\$ 1,499.
Left – Electric	DC2440D4PVGLE __	\$ 1,479.	\$ 1,579.	\$ 1,799.
Right – Electric	DC2440D4PVGRE __	\$ 1,479.	\$ 1,579.	\$ 1,799.
6" Deep (D6): 23-1/4" W x 39-3/8" H (RO: 22-1/2" W x 38-5/8" H x 6" D)				
 Non-Handed	DC2440D6PVG __	\$ 1,449.	\$ 1,549.	\$ 1,749.
Left – Electric	DC2440D6PVGLE __	\$ 1,749.	\$ 1,849.	\$ 2,079.
Right – Electric	DC2440D6PVGRE __	\$ 1,749.	\$ 1,849.	\$ 2,079.

Finish Options

Fill in __ designator to Model listed above with desired finish. Example: DC2440D4PVGRE75.

70 Satin Nickel	76 Chrome
71 Brushed Nickel	77 Polished Nickel
74 Brushed Black	79 White
75 Brushed Bronze	

Accessories & Options

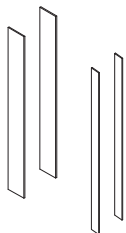

Description	Model	Price
Surface-Mount Kit for 40" H Mirrored Cabinets Quantity 1 = Pair of Side Kits and Mounting Hardware		
D4 Surface-Mount, Polished Edge Mirror	MSMK40D4P	\$ 249.
D6 Surface-Mount, Polished Edge Mirror	MSMK40D6P	\$ 329.
D6 Semi-Recessed, Polished Edge Mirror	MSMK40D6SRP	\$ 249.

See page 274 for Decorative surface-mount kit options.

See Bottom Kits on page 275.

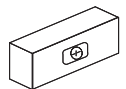

Safety Lock Box	SLB-*	\$ 279.
------------------------	-------	---------

Full compartment keyed lock box in an anodized aluminum finish

* Follow SLB with first 2 numbers (width) of cabinet model, then depth of cabinet model. Example: SLB24D6

Light Options include:

Main Line Sconces
Refer to page 259 for more information.

Other Options:

Main Line Framed Wall Mirrors
See pages 34 – 35.

Magnifying Mirror: POMM, SOMM
See page 272.

Glass Bins
See page 272.

SEE PAGE 203 FOR TIPS AND FEATURES.

Rosemont® Framed Cabinets – 16" W x 30" H



A framed medicine cabinet that is versatile enough to enhance any design approach, the Main Line Collection offers 4 framed profiles with 7 metal finishes and a variety of size options.

- Available in four uniquely designed frame profiles: Bryn Mawr®, Merion®, Penn Valley®, Rosemont
- Frame profiles available in 7 metal finish options
- Pair with Main Line Sconces for a coordinated look
- ETL certified to UL 962, CSA Standard C22.2 No. 68



Two Week Lead Time



Electrical Outlet



Magnifying Mirror

Rosemont 16" W x 30" H Cabinets

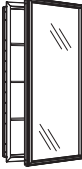
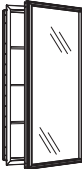
Description	Model	FINISHES		
		70, 71 Price	74, 75, 79 Price	76, 77 Price
4" Deep (D4): 15-1/4" W x 30" H (RO: 14-1/2" W x 29-1/4" H x 4" D)				
 Non-Handed	DC1630D4RMG __	\$ 749.	\$ 849.	\$ 1,079.
Left – Electric	DC1630D4RMGLE __	\$ 1,029.	\$ 1,149.	\$ 1,349.
Right – Electric	DC1630D4RMGRE __	\$ 1,029.	\$ 1,149.	\$ 1,349.
6" Deep (D6): 15-1/4" W x 30" H (RO: 14-1/2" W x 29-1/4" H x 6" D)				
 Non-Handed	DC1630D6RMG __	\$ 1,029.	\$ 1,129.	\$ 1,329.
Left – Electric	DC1630D6RMGLE __	\$ 1,299.	\$ 1,429.	\$ 1,629.
Right – Electric	DC1630D6RMGRE __	\$ 1,299.	\$ 1,429.	\$ 1,629.

Finish Options

Fill in __ designator to Model listed above with desired finish. Example: DC1630D4RMG74.

70 Satin Nickel	76 Chrome
71 Brushed Nickel	77 Polished Nickel
74 Brushed Black	79 White
75 Brushed Bronze	

Accessories & Options

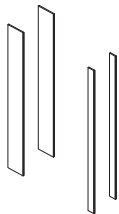

Description	Model	Price
Surface-Mount Kit for 30" H Mirrored Cabinets Quantity 1 = Pair of Side Kits and Mounting Hardware		
D4 Surface-Mount, Polished Edge Mirror	MSMK30D4P	\$ 149.
D6 Surface-Mount, Polished Edge Mirror	MSMK30D6P	\$ 199.
D6 Semi-Recessed, Polished Edge Mirror	MSMK30D6SRP	\$ 149.

See page 274 for Decorative surface-mount kit options.

See Bottom Kits on page 275.

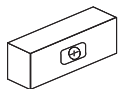

Safety Lock Box	SLB-*	\$ 279.
------------------------	-------	---------

Full compartment keyed lock box in an anodized aluminum finish

* Follow SLB with first 2 numbers (width) of cabinet model, then depth of cabinet model. Example: SLB16D4

Light Options include:

Main Line Sconces
Refer to page 259 for more information.

Other Options:

Main Line Framed Wall Mirrors
See pages 34 – 35.

Magnifying Mirror: POMM, SOMM
See page 272.

Glass Bins
See page 272.

SEE PAGE 203 FOR TIPS AND FEATURES.

Rosemont® Framed Cabinets – 20" W x 30" H



A framed medicine cabinet that is versatile enough to enhance any design approach, the Main Line Collection offers 4 framed profiles with 7 metal finishes and a variety of size options.

- Available in four uniquely designed frame profiles: Bryn Mawr®, Merion®, Penn Valley®, Rosemont
- Frame profiles available in 7 metal finish options
- Pair with Main Line Sconces for a coordinated look
- ETL certified to UL 962, CSA Standard C22.2 No. 68



Two Week Lead Time



Electrical Outlet



Magnifying Mirror

Rosemont 20" W x 30" H Cabinets

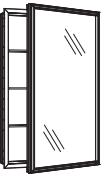
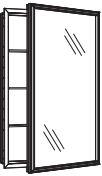
Description	Model	FINISHES		
		70, 71 Price	74, 75, 79 Price	76, 77 Price
4" Deep (D4): 19-1/4" W x 30" H (RO: 18-1/2" W x 29-1/4" H x 4" D)				
 Non-Handed	DC2030D4RMG __	\$ 849.	\$ 949.	\$ 1,179.
Left – Electric	DC2030D4RMGLE __	\$ 1,149.	\$ 1,249.	\$ 1,479.
Right – Electric	DC2030D4RMGRE __	\$ 1,149.	\$ 1,249.	\$ 1,479.
6" Deep (D6): 19-1/4" W x 30" H (RO: 18-1/2" W x 29-1/4" H x 6" D)				
 Non-Handed	DC2030D6RMG __	\$ 1,129.	\$ 1,229.	\$ 1,449.
Left – Electric	DC2030D6RMGLE __	\$ 1,429.	\$ 1,529.	\$ 1,749.
Right – Electric	DC2030D6RMGRE __	\$ 1,429.	\$ 1,529.	\$ 1,749.

Finish Options

Fill in __ designator to Model listed above with desired finish. Example: DC2030D6RMGLE70.

70	Satin Nickel	76	Chrome
71	Brushed Nickel	77	Polished Nickel
74	Brushed Black	79	White
75	Brushed Bronze		

Accessories & Options

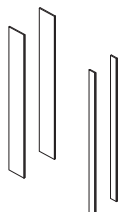

Description	Model	Price
Surface-Mount Kit for 30" H Mirrored Cabinets Quantity 1 = Pair of Side Kits and Mounting Hardware		
D4 Surface-Mount, Polished Edge Mirror	MSMK30D4P	\$ 149.
D6 Surface-Mount, Polished Edge Mirror	MSMK30D6P	\$ 199.
D6 Semi-Recessed, Polished Edge Mirror	MSMK30D6SRP	\$ 149.

See page 274 for Decorative surface-mount kit options.

See Bottom Kits on page 275.

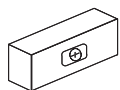

Safety Lock Box	SLB.*	\$ 279.
Full compartment keyed lock box in an anodized aluminum finish		

* Follow SLB with first 2 numbers (width) of cabinet model, then depth of cabinet model. Example: SLB20D4

Light Options include:

Main Line Sconces
Refer to page 259 for more information.

Other Options:

Main Line Framed Wall Mirrors
See pages 34 – 35.

Magnifying Mirror: POMM, SOMM
See page 272.

Glass Bins
See page 272.

SEE PAGE 203 FOR TIPS AND FEATURES.

Rosemont® Framed Cabinets – 24" W x 30" H



A framed medicine cabinet that is versatile enough to enhance any design approach, the Main Line Collection offers 4 framed profiles with 7 metal finishes and a variety of size options.

- Available in four uniquely designed frame profiles: Bryn Mawr®, Merion®, Penn Valley®, Rosemont
- Frame profiles available in 7 metal finish options
- Pair with Main Line Sconces for a coordinated look
- ETL certified to UL 962, CSA Standard C22.2 No. 68

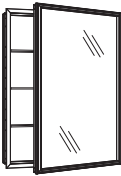
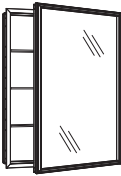

Rosemont 24" W x 30" H Cabinets

Description	Model	FINISHES		
		70, 71 Price	74, 75, 79 Price	76, 77 Price
4" Deep (D4): 23-1/4" W x 30" H (RO: 22-1/2" W x 29-1/4" H x 4" D)				
 Non-Handed	DC2430D4RMG __	\$ 949.	\$ 1,079.	\$ 1,279.
Left – Electric	DC2430D4RMGLE __	\$ 1,249.	\$ 1,349.	\$ 1,579.
Right – Electric	DC2430D4RMGRE __	\$ 1,249.	\$ 1,349.	\$ 1,579.
6" Deep (D6): 23-1/4" W x 30" H (RO: 22-1/2" W x 29-1/4" H x 6" D)				
 Non-Handed	DC2430D6RMG __	\$ 1,229.	\$ 1,329.	\$ 1,549.
Left – Electric	DC2430D6RMGLE __	\$ 1,529.	\$ 1,629.	\$ 1,849.
Right – Electric	DC2430D6RMGRE __	\$ 1,529.	\$ 1,629.	\$ 1,849.

Cabinets

Finish Options

Fill in __ designator to Model listed above with desired finish. Example: DC2430D4RMGRE76.

70 Satin Nickel	76 Chrome
71 Brushed Nickel	77 Polished Nickel
74 Brushed Black	79 White
75 Brushed Bronze	

Accessories & Options

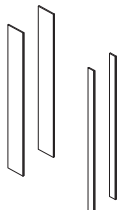

Description	Model	Price
Surface-Mount Kit for 30" H Mirrored Cabinets Quantity 1 = Pair of Side Kits and Mounting Hardware		
D4 Surface-Mount, Polished Edge Mirror	MSMK30D4P	\$ 149.
D6 Surface-Mount, Polished Edge Mirror	MSMK30D6P	\$ 199.
D6 Semi-Recessed, Polished Edge Mirror	MSMK30D6SRP	\$ 149.

See page 274 for Decorative surface-mount kit options.

See **Bottom Kits on page 275.**

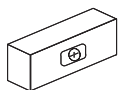

Safety Lock Box	SLB-*	\$ 279.
Full compartment keyed lock box in an anodized aluminum finish		

* Follow SLB with first 2 numbers (width) of cabinet model, then depth of cabinet model. Example: SLB24D6

Light Options include:

Main Line Sconces
Refer to page 259 for more information.

Other Options:

Main Line Framed Wall Mirrors
See pages 34 – 35.

Magnifying Mirror: POMM, SOMM
See page 272.

Glass Bins
See page 272.

SEE PAGE 203 FOR TIPS AND FEATURES.

Rosemont® Framed Cabinets – 16" W x 40" H



A framed medicine cabinet that is versatile enough to enhance any design approach, the Main Line Collection offers 4 framed profiles with 7 metal finishes and a variety of size options.

- Available in four uniquely designed frame profiles: Bryn Mawr®, Merion®, Penn Valley®, Rosemont
- Frame profiles available in 7 metal finish options
- Pair with Main Line Sconces for a coordinated look
- ETL certified to UL 962, CSA Standard C22.2 No. 68



Two Week Lead Time



Electrical Outlet



Magnifying Mirror

Rosemont 16" W x 40" H Cabinets

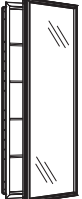
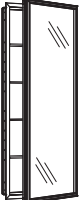
Description	Model	FINISHES		
		70, 71 Price	74, 75, 79 Price	76, 77 Price
4" Deep (D4): 15-1/4" W x 39-3/8" H (RO: 14-1/2" W x 38-5/8" H x 4" D)				
 Non-Handed	DC1640D4RMG __	\$ 949.	\$ 1,079.	\$ 1,279.
Left – Electric	DC1640D4RMGLE __	\$ 1,249.	\$ 1,349.	\$ 1,579.
Right – Electric	DC1640D4RMGRE __	\$ 1,249.	\$ 1,349.	\$ 1,579.
6" Deep (D6): 15-1/4" W x 39-3/8" H (RO: 14-1/2" W x 38-5/8" H x 6" D)				
 Non-Handed	DC1640D6RMG __	\$ 1,229.	\$ 1,329.	\$ 1,549.
Left – Electric	DC1640D6RMGLE __	\$ 1,529.	\$ 1,629.	\$ 1,849.
Right – Electric	DC1640D6RMGRE __	\$ 1,529.	\$ 1,629.	\$ 1,849.

Finish Options

Fill in __ designator to Model listed above with desired finish. Example: DC1640D4RMG74.

70 Satin Nickel	76 Chrome
71 Brushed Nickel	77 Polished Nickel
74 Brushed Black	79 White
75 Brushed Bronze	

Accessories & Options

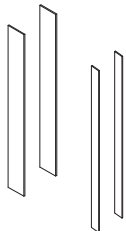

Description	Model	Price
Surface-Mount Kit for 40" H Mirrored Cabinets Quantity 1 = Pair of Side Kits and Mounting Hardware		
D4 Surface-Mount, Polished Edge Mirror	MSMK40D4P	\$ 249.
D6 Surface-Mount, Polished Edge Mirror	MSMK40D6P	\$ 329.
D6 Semi-Recessed, Polished Edge Mirror	MSMK40D6SRP	\$ 249.

See page 274 for Decorative surface-mount kit options.

See Bottom Kits on page 275.

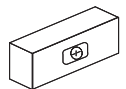

Safety Lock Box	SLB-*	\$ 279.
Full compartment keyed lock box in an anodized aluminum finish		

* Follow SLB with first 2 numbers (width) of cabinet model, then depth of cabinet model. Example: SLB16D4

Light Options include:

Main Line Sconces
Refer to page 259 for more information.

Other Options:

Main Line Framed Wall Mirrors
See pages 34 – 35.

Magnifying Mirror: POMM, SOMM
See page 272.

Glass Bins
See page 272.

SEE PAGE 203 FOR TIPS AND FEATURES.

Rosemont® Framed Cabinets – 20" W x 40" H



A framed medicine cabinet that is versatile enough to enhance any design approach, the Main Line Collection offers 4 framed profiles with 7 metal finishes and a variety of size options.

- Available in four uniquely designed frame profiles: Bryn Mawr®, Merion®, Penn Valley®, Rosemont
- Frame profiles available in 7 metal finish options
- Pair with Main Line Sconces for a coordinated look
- ETL certified to UL 962, CSA Standard C22.2 No. 68



Two Week Lead Time



Electrical Outlet



Magnifying Mirror

Rosemont 20" W x 40" H Cabinets

Description	Model	FINISHES			
		70, 71 Price	74, 75, 79 Price	76, 77 Price	
4" Deep (D4): 19-1/4" W x 39-3/8" H (RO: 18-1/2" W x 38-5/8" H x 4" D)					
	Non-Handed	DC2040D4RMG __	\$ 1,079.	\$ 1,179.	\$ 1,399.
	Left – Electric	DC2040D4RMGLE __	\$ 1,349.	\$ 1,479.	\$ 1,679.
	Right – Electric	DC2040D4RMGRE __	\$ 1,349.	\$ 1,479.	\$ 1,679.
6" Deep (D6): 19-1/4" W x 39-3/8" H (RO: 18-1/2" W x 38-5/8" H x 6" D)					
	Non-Handed	DC2040D6RMG __	\$ 1,329.	\$ 1,449.	\$ 1,649.
	Left – Electric	DC2040D6RMGLE __	\$ 1,629.	\$ 1,749.	\$ 1,949.
	Right – Electric	DC2040D6RMGRE __	\$ 1,629.	\$ 1,749.	\$ 1,949.

Finish Options

Fill in __ designator to Model listed above with desired finish. Example: DC2040D6RMGLE70.

70	Satin Nickel	76	Chrome
71	Brushed Nickel	77	Polished Nickel
74	Brushed Black	79	White
75	Brushed Bronze		

Accessories & Options

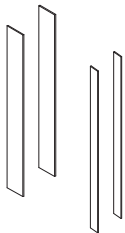

Description	Model	Price
Surface-Mount Kit for 40" H Mirrored Cabinets Quantity 1 = Pair of Side Kits and Mounting Hardware		
D4 Surface-Mount, Polished Edge Mirror	MSMK40D4P	\$ 249.
D6 Surface-Mount, Polished Edge Mirror	MSMK40D6P	\$ 329.
D6 Semi-Recessed, Polished Edge Mirror	MSMK40D6SRP	\$ 249.

See page 274 for Decorative surface-mount kit options.

See Bottom Kits on page 275.

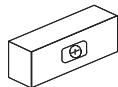

Safety Lock Box	SLB.*	\$ 279.
Full compartment keyed lock box in an anodized aluminum finish		

* Follow SLB with first 2 numbers (width) of cabinet model, then depth of cabinet model. Example: SLB20D4

Light Options include:

Main Line Sconces
Refer to page 259 for more information.

Other Options:

Main Line Framed Wall Mirrors
See pages 34 – 35.

Magnifying Mirror: POMM, SOMM
See page 272.

Glass Bins
See page 272.

SEE PAGE 203 FOR TIPS AND FEATURES.

Rosemont® Framed Cabinets – 24" W x 40" H



A framed medicine cabinet that is versatile enough to enhance any design approach, the Main Line Collection offers 4 framed profiles with 7 metal finishes and a variety of size options.

- Available in four uniquely designed frame profiles: Bryn Mawr®, Merion®, Penn Valley®, Rosemont
- Frame profiles available in 7 metal finish options
- Pair with Main Line Sconces for a coordinated look
- ETL certified to UL 962, CSA Standard C22.2 No. 68



Two Week Lead Time



Electrical Outlet



Magnifying Mirror

Rosemont 24" W x 40" H Cabinets

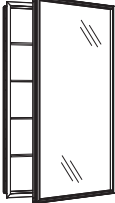
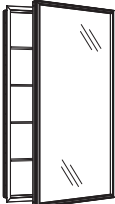
Description	Model	FINISHES		
		70, 71 Price	74, 75, 79 Price	76, 77 Price
4" Deep (D4): 23-1/4" W x 39-3/8" H (RO: 22-1/2" W x 38-5/8" H x 4" D)				
 Non-Handed	DC2440D4RMG __	\$ 1,179.	\$ 1,279.	\$ 1,499.
Left – Electric	DC2440D4RMGLE __	\$ 1,479.	\$ 1,579.	\$ 1,799.
Right – Electric	DC2440D4RMGRE __	\$ 1,479.	\$ 1,579.	\$ 1,799.
6" Deep (D6): 23-1/4" W x 39-3/8" H (RO: 22-1/2" W x 38-5/8" H x 6" D)				
 Non-Handed	DC2440D6RMG __	\$ 1,449.	\$ 1,549.	\$ 1,749.
Left – Electric	DC2440D6RMGLE __	\$ 1,749.	\$ 1,849.	\$ 2,079.
Right – Electric	DC2440D6RMGRE __	\$ 1,749.	\$ 1,849.	\$ 2,079.

Finish Options

Fill in __ designator to Model listed above with desired finish. Example: DC2440D4RMGRE76.

70 Satin Nickel	76 Chrome
71 Brushed Nickel	77 Polished Nickel
74 Brushed Black	79 White
75 Brushed Bronze	

Accessories & Options

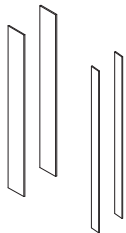

Description

Surface-Mount Kit for 40" H Mirrored Cabinets
Quantity 1 = Pair of Side Kits and Mounting Hardware

D4 Surface-Mount, Polished Edge Mirror MSMK40D4P \$ 249.

D6 Surface-Mount, Polished Edge Mirror MSMK40D6P \$ 329.

D6 Semi-Recessed, Polished Edge Mirror MSMK40D6SRP \$ 249.

See page 274 for Decorative surface-mount kit options.

See Bottom Kits on page 275.

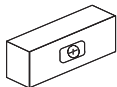

Safety Lock Box

SLB-*

\$ 279.

Full compartment keyed lock box in an anodized aluminum finish

* Follow SLB with first 2 numbers (width) of cabinet model, then depth of cabinet model. Example: SLB24D6

Light Options include:

Main Line Sconces
Refer to page 259 for more information.

Other Options:

Main Line Framed Wall Mirrors
See pages 34 – 35.

Magnifying Mirror: POMM, SOMM
See page 272.

Glass Bins
See page 272.

SEE PAGE 203 FOR TIPS AND FEATURES.

PL Series Cabinets – Table of Contents

PL Series Tips & Features	230
PL Series Cabinet Worksheet	231
PL Series Cabinets	232 – 235
16" Wide Cabinets	232
20" Wide Cabinets	233
24" Wide Cabinets	234
30" Wide, 3 Door Cabinets	235
36" Wide, 3 Door Cabinets	235
Lighting Options	252 – 259
Cabinet Accessories	271 – 275
Cabinet Ganging Reference	145



PL Series Cabinets – Tips & Features

Dimensions & Weight

- Width:
15-1/4" (387 mm)
19-1/4" (489 mm)
23-1/4" (591 mm)
30" (762 mm)
36" (914 mm)
- Height:
30" flat (762 mm)
34" arch (864 mm)
39-3/8" flat (1000 mm)
- Depth: 4" (102 mm)
- Net Weight: 29.5 – 66.5 lbs

Features & Benefits

- 3/4" bevel or polished edge mirror door
- Interior options: White, Black or Classic Gray
- Electric option includes one 15A, 120VAC outlet (2 plugs); three door cabinet outlet located in the left compartment
- Cabinets can be ganged horizontally or vertically, offering semi-custom configurations
- Pair with vertical lighting for a coordinated look
- ETL certified to UL 962, CSA Standard C22.2 No. 68

Configurable Options

- Cabinet Style: Flat or Arch Top
- Edge Type: Polished edge or bevel edge for flat top. Arch top is bevel edge only.
- Hinge Options: non-handed, left or right hinge
- Electrical Packages: non-electric, electric (LE2)
- Interior Color Options: White, Black or Classic Gray

Construction

- Durable rust-free anodized aluminum and glass construction – glass resists intense moisture, ensuring long-lasting beauty
- Satin anodized aluminum body
- Quiet close Safeseal® Gasket with sealed corners on cabinet body
- 3 mirror design – rear of cabinet and both sides of door

Construction (Continued)

- Concealed finger pull-door edge
- Door opening angle 170 degrees (110 with provided stop): Blum self-closing hinges (3 door cabinets open 100 degrees)
- 3-way adjustable concealed hinge system
- Adjustable shelving at 2" (51 mm) increments: 3 shelves for 30" H, 4 shelves for 40" H
- 1/4" (6 mm) thick adjustable clear glass shelves
- Arch doors extend 4" above cabinet. Arch door cabinets available as right hinge only.
- All 30" and 36" W cabinets have three bevel edge doors

Installation

- Recessed or surface-mount installation
- Cabinets include hardware for recessed installation. Surface-mount installations require the purchase of a surface-mount kit which includes the side kit as well as mounting hardware.
- Recessed cabinets project 7/8" from wall and must be recessed no less than 3-3/4" deep
- Non-handed flat door cabinets can be installed with left or right opening. Left or Right = hinge side when facing cabinet.
- Safety Lock Box cannot be used with Three Door Cabinets

Accessories

- Safety Lock Box (SLB-*)
- Swing-Out Magnifying Mirror (SOMM)
- Pull-Out Magnifying Mirror (POMM)
- Chrome Handle Kit (MHANDLEKIT)
- Push-to-Open Kit (MPUSHKIT)
- Glass Bins (GLASSBIN3.25, GLASSBIN5.25, GLASSBIN8.5)
- Surface-Mount Kit (PLSMK30D4P, MSMK30D4W, PLSMK40D4P)
- Ganging Kit (PLGKIT)
- Stacking Filler System (MSF-*)
- Bottom Kit (MBK__D_A, MBK__D_ASR)



PL Series Cabinet Worksheet

FEATURES

Select Width:

16"

20"

24"

Select Cabinet Top (height):

Flat

Flat

Arch

Select Interior Color:

Black

White

Classic Gray

Select Mirror Edge:

Polished Edge (blank)

Bevel Edge

Select Door Style:

Flat (blank)

Arch

Select Hinge and Electric Option:

Non-Electric (blank)

Right with Electric Option

Left with Electric Option

MODEL

PLM

16

20

24

30

40

34

B

W

G

—

B

—

A

—

RE

LE

THREE DOOR CABINET FEATURES

Select Width:

30" three door

36" three door

Select Interior Color:

Black

White

Classic Gray

Select Electric Option:

Non-Electric (blank)

Electric

MODEL

PLM

30

30

36

B

W

G

—

E

CUSTOMER INFORMATION

Name

Address

City/State/Zip

Telephone

Date Ordered

Light Selection

Surface-Mount Side Kit Model (if applicable)

Notes

PL Series Cabinets – PLM16 – 15-1/4" Wide Door



A luxurious yet affordable medicine cabinet, the PL Series offers a wide range of technology, style and storage options.

- Door styles: Flat and Arch
- Interior options: White, Black or Classic Gray
- Electrical components are ETL listed



Two Week Lead Time



Modular



Electrical Outlet



Magnifying Mirror

15-1/4" W PLM16 Cabinets

	Description	Black Interior	Classic Gray Interior	White Interior	Price
Flat Door – 15-1/4" W x 30" H (RO: 14-1/2" W x 29-1/4" H x 4" D)					
	Polished Edge – Non-Handed	PLM1630B	PLM1630G	PLM1630W	\$ 529.
	Bevel Edge – Non-Handed	PLM1630BB	PLM1630GB	PLM1630WB	\$ 529.
	Polished Edge – Left – Electric	PLM1630BLE	PLM1630GLE	PLM1630WLE	\$ 829.
	Bevel Edge – Left – Electric	PLM1630BBLE	PLM1630GBLE	PLM1630WBLE	\$ 829.
	Polished Edge – Right – Electric	PLM1630BRE	PLM1630GRE	PLM1630WRE	\$ 829.
	Bevel Edge – Right – Electric	PLM1630BBRE	PLM1630GBRE	PLM1630WBRE	\$ 829.
Flat Door – 15-1/4" W x 39-3/8" H (RO: 14-1/2" W x 38-5/8" H x 4" D)					
	Polished Edge – Non-Handed	PLM1640B	PLM1640G	PLM1640W	\$ 649.
	Bevel Edge – Non-Handed	PLM1640BB	PLM1640GB	PLM1640WB	\$ 649.
	Polished Edge – Left – Electric	PLM1640BLE	PLM1640GLE	PLM1640WLE	\$ 929.
	Bevel Edge – Left – Electric	PLM1640BBLE	PLM1640GBLE	PLM1640WBLE	\$ 929.
	Polished Edge – Right – Electric	PLM1640BRE	PLM1640GRE	PLM1640WRE	\$ 929.
	Bevel Edge – Right – Electric	PLM1640BBRE	PLM1640GBRE	PLM1640WBRE	\$ 929.
Arch Door – 15-1/4" W x 34" H (RO: 14-1/2" W x 29-1/4" H x 4" D)					
	Bevel Edge – Right	PLM1634BBA	PLM1634GBA	PLM1634WBA	\$ 799.
	Bevel Edge – Right – Electric	PLM1634BBARE	PLM1634GBARE	PLM1634WBARE	\$ 1,099.

Accessories & Options

	Description	Model	Price
	Surface-Mount Kit for Cabinets Quantity 1 = Pair of Side Kits and Mounting Hardware		
	30" H Polished Edge Mirror	PLSMK30D4P	\$ 149.
	30" H White Glass	MSMK30D4W	\$ 199.
	40" H Polished Edge Mirror	PLSMK40D4P	\$ 249.
	Safety Lock Box Full compartment keyed lock box in an anodized aluminum finish	SLB-*	\$ 279.
	* Follow SLB with first 2 numbers (width) of cabinet model, then depth of cabinet model. Example: SLB16D4		
	PL Ganging Kit Hardware required for installing 2 or 3 cabinets side-by-side	PLGKIT	\$ 49.
	See Bottom Kits on page 275.		

Light Options include:

Vertical Lights
Sconces
Refer to pages 252 – 259 for more information.

Other Options:

Magnifying Mirror: POMM, SOMM
See page 272.

Glass Bins
See page 272.

Note: Models in **bold** indicate Quick Ship product.

SEE PAGE 230 FOR TIPS AND FEATURES.

PL Series Cabinets – PLM20 – 19-1/4" Wide Door



A luxurious yet affordable medicine cabinet, the PL Series offers a wide range of technology, style and storage options.

- Door styles: Flat and Arch
- Interior options: White, Black or Classic Gray
- Electrical components are ETL listed



Two Week
Lead Time



Modular



Electrical
Outlet



Magnifying
Mirror

19-1/4" W PLM20 Cabinets

	Description	Black Interior	Classic Gray Interior	White Interior	Price
Flat Door – 19-1/4" W x 30" H (RO: 18-1/2" W x 29-1/4" H x 4" D)					
	Polished Edge – Non-Handed	PLM2030B	PLM2030G	PLM2030W	\$ 579.
	Bevel Edge – Non-Handed	PLM2030BB	PLM2030GB	PLM2030WB	\$ 579.
	Polished Edge – Left – Electric	PLM2030BLE	PLM2030GLE	PLM2030WLE	\$ 879.
	Bevel Edge – Left – Electric	PLM2030BBLE	PLM2030GBLE	PLM2030WBLE	\$ 879.
	Polished Edge – Right – Electric	PLM2030BRE	PLM2030GRE	PLM2030WRE	\$ 879.
	Bevel Edge – Right – Electric	PLM2030BBRE	PLM2030GBRE	PLM2030WBRE	\$ 879.
Flat Door – 19-1/4" W x 39-3/8" H (RO: 18-1/2" W x 38-5/8" H x 4" D)					
	Polished Edge – Non-Handed	PLM2040B	PLM2040G	PLM2040W	\$ 699.
	Bevel Edge – Non-Handed	PLM2040BB	PLM2040GB	PLM2040WB	\$ 699.
	Polished Edge – Left – Electric	PLM2040BLE	PLM2040GLE	PLM2040WLE	\$ 979.
	Bevel Edge – Left – Electric	PLM2040BBLE	PLM2040GBLE	PLM2040WBLE	\$ 979.
	Polished Edge – Right – Electric	PLM2040BRE	PLM2040GRE	PLM2040WRE	\$ 979.
	Bevel Edge – Right – Electric	PLM2040BBRE	PLM2040GBRE	PLM2040WBRE	\$ 979.
Arch Door – 19-1/4" W x 34" H (RO: 18-1/2" W x 29-1/4" H x 4" D)					
	Bevel Edge – Right	PLM2034BBA	PLM2034GBA	PLM2034WBA	\$ 849.
	Bevel Edge – Right – Electric	PLM2034BBARE	PLM2034GBARE	PLM2034WBARE	\$ 1,149.

Cabinets

Accessories & Options

	Description	Model	Price
	Surface-Mount Kit for Cabinets Quantity 1 = Pair of Side Kits and Mounting Hardware		
	30" H Polished Edge Mirror	PLSMK30D4P	\$ 149.
	30" H White Glass	MSMK30D4W	\$ 199.
	40" H Polished Edge Mirror	PLSMK40D4P	\$ 249.
	Safety Lock Box	SLB-*	\$ 279.
	Full compartment keyed lock box in an anodized aluminum finish		
	* Follow SLB with first 2 numbers (width) of cabinet model, then depth of cabinet model. Example: SLB20D4		
	PL Ganging Kit	PLGKIT	\$ 49.
	Hardware required for installing 2 or 3 cabinets side-by-side See Bottom Kits on page 275.		

Light Options include:

Vertical Lights
Sconces
Refer to pages 252 – 259 for more information.

Other Options:

Magnifying Mirror: POMM, SOMM
See page 272.

Glass Bins
See page 272.

Note: Models in **bold** indicate Quick Ship product.

SEE PAGE 230 FOR TIPS AND FEATURES.

PL Series Cabinets – PLM24 – 23-1/4" Wide Door



A luxurious yet affordable medicine cabinet, the PL Series offers a wide range of technology, style and storage options.

- Door styles: Flat and Arch
- Interior options: White, Black or Classic Gray
- Electrical components are ETL listed



Two Week Lead Time



Modular



Electrical Outlet



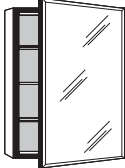
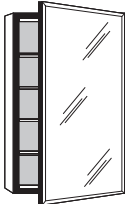
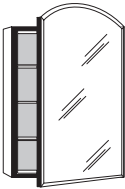

Magnifying Mirror

23-1/4" W PLM24 Cabinets

Description	Black Interior	Classic Gray Interior	White Interior	Price
Flat Door – 23-1/4" W x 30" H (RO: 22-1/2" W x 29-1/4" H x 4" D)				
	Polished Edge – Non-Handed	PLM2430B	PLM2430G	PLM2430W \$ 649.
	Bevel Edge – Non-Handed	PLM2430BB	PLM2430GB	PLM2430WB \$ 649.
	Polished Edge – Left – Electric	PLM2430BLE	PLM2430GLE	PLM2430WLE \$ 929.
	Bevel Edge – Left – Electric	PLM2430BBLE	PLM2430GBLE	PLM2430WBLE \$ 929.
	Polished Edge – Right – Electric	PLM2430BRE	PLM2430GRE	PLM2430WRE \$ 929.
	Bevel Edge – Right – Electric	PLM2430BBRE	PLM2430GBRE	PLM2430WBRE \$ 929.
Flat Door – 23-1/4" W x 39-3/8" H (RO: 22-1/2" W x 38-5/8" H x 4" D)				
	Polished Edge – Non-Handed	PLM2440B	PLM2440G	PLM2440W \$ 749.
	Bevel Edge – Non-Handed	PLM2440BB	PLM2440GB	PLM2440WB \$ 749.
	Polished Edge – Left – Electric	PLM2440BLE	PLM2440GLE	PLM2440WLE \$ 1,029.
	Bevel Edge – Left – Electric	PLM2440BBLE	PLM2440GBLE	PLM2440WBLE \$ 1,029.
	Polished Edge – Right – Electric	PLM2440BRE	PLM2440GRE	PLM2440WRE \$ 1,029.
	Bevel Edge – Right – Electric	PLM2440BBRE	PLM2440GBRE	PLM2440WBRE \$ 1,029.
Arch Door – 23-1/4" W x 34" H (RO: 22-1/2" W x 29-1/4" H x 4" D)				
 Right hinge only	Bevel Edge – Right	PLM2434BBA	PLM2434GBA	PLM2434WBA \$ 899.
	Bevel Edge – Right – Electric	PLM2434BBARE	PLM2434GBARE	PLM2434WBARE \$ 1,199.

Accessories & Options

Description	Model	Price	Light Options include:	
	Surface-Mount Kit for Cabinets Quantity 1 = Pair of Side Kits and Mounting Hardware		Vertical Lights Sconces Refer to pages 252 – 259 for more information.	
	30" H Polished Edge Mirror	PLSMK30D4P		\$ 149.
	30" H White Glass	MSMK30D4W		\$ 199.
40" H Polished Edge Mirror	PLSMK40D4P	\$ 249.	Other Options: Magnifying Mirror: POMM, SOMM See page 272.	
Safety Lock Box Full compartment keyed lock box in an anodized aluminum finish	SLB-*	\$ 279.		Glass Bins See page 272.
* Follow SLB with first 2 numbers (width) of cabinet model, then depth of cabinet model. Example: SLB24D4				
	PL Ganging Kit	PLGKIT	\$ 49.	
Hardware required for installing 2 or 3 cabinets side-by-side See Bottom Kits on page 275.				

 **Note:** Models in **bold** indicate Quick Ship product.

SEE PAGE 230 FOR TIPS AND FEATURES.

PL Series Cabinets – PLM30 & PLM36 – 3 Door



A luxurious yet affordable medicine cabinet, the PL Series offers a wide range of technology, style and storage options.

- Three door style
- Interior options: White, Black or Classic Gray
- Electrical components are ETL listed



Two Week Lead Time



Modular



Electrical Outlet



Magnifying Mirror

3 Door PLM30 & PLM36 Cabinets

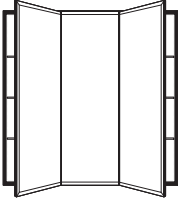
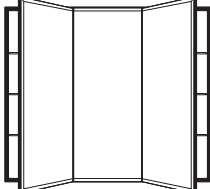
Description	Black Interior	Classic Gray Interior	White Interior	Price	
PLM30 – 30" W x 30" H (RO: 29-1/4" W x 29-1/4" H x 4" D)					
	Bevel Edge – 3 Door	PLM3030B	PLM3030G	PLM3030W	\$ 1,229.
	Bevel Edge – 3 Door – Electric	PLM3030BE	PLM3030GE	PLM3030WE	\$ 1,529.
PLM36 – 36" W x 30" H (RO: 35-1/4" W x 29-1/4" H x 4" D)					
	Bevel Edge – 3 Door	PLM3630B	PLM3630G	PLM3630W	\$ 1,399.
	Bevel Edge – 3 Door – Electric	PLM3630BE	PLM3630GE	PLM3630WE	\$ 1,679.

Cabinets

Accessories & Options

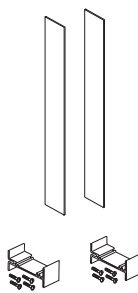

Description	Model	Price
Surface-Mount Kit for Cabinets Quantity 1 = Pair of Side Kits and Mounting Hardware		
30" H Polished Edge Mirror	PLSMK30D4P	\$ 149.
30" H White Glass	MSMK30D4W	\$ 199.
PL Ganging Kit	PLGKIT	\$ 49.
Hardware required for installing 2 or 3 cabinets side-by-side		

Light Options include:

Vertical Lights
Sconces
Refer to pages 252 – 259 for more information.

Other Options:

Magnifying Mirror: POMM, SOMM
See page 272.
Glass Bins
See page 272.

SEE PAGE 230 FOR TIPS AND FEATURES.

R³® Series Cabinets – Table of Contents, Tips & Features

Table of Contents

R³ Series Cabinet Worksheet	237
R³ Series Cabinets	238 – 240
16" Wide, Flat Door Cabinets	238
20" Wide, Flat Door Cabinets	239
24" Wide, Flat Door Cabinets	240
Cabinet Accessories	271 – 275

Tips & Features

Dimensions & Weight

- Width:
 - 16" (406 mm)
 - 20" (508 mm)
 - 24" (610 mm)
- Height:
 - 20" (508 mm)
 - 26" (660 mm)
 - 36" (914 mm)
- Depth: 4-3/4" (121 mm)
- Net Weight: 15 – 40 lbs

Features & Benefits

- Ideal for remodeling: features 1" (25 mm) flange to hide gaps, paint lines or any wall imperfections
- Slow-close functionality
- Cantilever Shelving: clean interior due to "hidden" shelf adjustments and off-set door hinge
- Thin door and off-set hinge allow for more storage than any cabinet of similar size

Configurable Options

- Edge Type: Polished or bevel edge

Construction

- Durable rust-free anodized aluminum and glass construction – glass resists intense moisture, ensuring long-lasting beauty
- Satin anodized aluminum body
- 3 mirror design – rear of cabinet and both sides of door
- 108-degree in-set adjustable hinge system
- Two adjustable cantilever glass shelves
- 1/4" (6 mm) thick adjustable clear glass shelves
- Low-profile laminated door design

Installation

- Recessed or surface-mount installation
- Cabinets include hardware for recessed installation. Surface-mount installations require the purchase of a surface-mount kit which includes the side kit as well as mounting hardware.
- Non-handed single door cabinets can be installed with left or right opening. Left or Right = hinge side when facing cabinet.
- Recessed cabinets project 1" from wall

Accessories

- Surface-Mount Kit (RSMK_D4P)
- Glass Bins (GLASSBIN3.25, GLASSBIN5.25, GLASSBIN8.5)



R³ Series Cabinet Worksheet

FEATURES

Select Width:

16"

20"

24"

Select Height:

20"*

26"

36"

Select Mirror Edge:

Polished Edge

Bevel Edge

Select Number of Doors:

One

MODEL

RC

D4

F

16

20

24

20

26

36

P

B

1

Note:

* 20" H cabinets are only available for 16" W cabinets.

CUSTOMER INFORMATION

Name

Address

City/State/Zip

Telephone

Date Ordered

Light Selection

Notes

R³® Series Cabinets – RC16 – 16" Wide, Flat Door



A high quality medicine cabinet designed for easy retrofit renovation, the R3 Series Collection offers Robern quality at our entry price point.

- Ideal for remodeling: features 1" (25 mm) flange to hide gaps, paint lines or any wall imperfections
- Slow-close functionality
- Clean interior due to "hidden" shelf adjustments and off-set door hinge



Two Week
Lead Time

RC16 – 16" W Cabinets

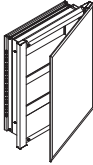
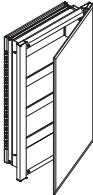
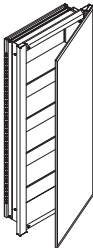
	Description	Model	Price
RC1620 – 16" W x 20" H (RO: 14" W x 18" H x 4" D)			
	Polished Edge Mirrored – Single Door	RC1620D4FP1	\$ 279.
	Bevel Edge Mirrored – Single Door	RC1620D4FB1	\$ 279.
RC1626 – 16" W x 26" H (RO: 14" W x 24" H x 4" D)			
	Polished Edge Mirrored – Single Door	RC1626D4FP1	\$ 429.
	Bevel Edge Mirrored – Single Door	RC1626D4FB1	\$ 429.
RC1636 – 16" W x 36" H (RO: 14" W x 34" H x 4" D)			
	Polished Edge Mirrored – Single Door	RC1636D4FP1	\$ 529.
	Bevel Edge Mirrored – Single Door	RC1636D4FB1	\$ 529.

Cabinets

Accessories & Options



Description	Model	Price
Surface-Mount Kit for Cabinets Quantity 1 = Pair of Mirrored Side Kits and Mounting Hardware		
20" Polished Edge Mirrored	RSMK20D4P	\$ 149.
26" Polished Edge Mirrored	RSMK26D4P	\$ 149.
36" Polished Edge Mirrored	RSMK36D4P	\$ 149.

 **Note:** Models in **bold** indicate Quick Ship product.

SEE PAGE 236 FOR TIPS AND FEATURES.

R³® Series Cabinets – RC20 – 20" Wide, Flat Door

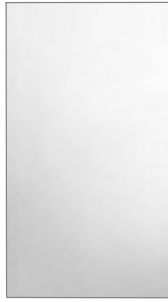

A high quality medicine cabinet designed for easy retrofit renovation, the R3 Series Collection offers Robern quality at our entry price point.

- Ideal for remodeling: features 1" (25 mm) flange to hide gaps, paint lines or any wall imperfections
- Slow-close functionality
- Clean interior due to "hidden" shelf adjustments and off-set door hinge



Two Week
Lead Time

RC20 – 20" W Cabinets

	Description	Model	Price
	RC2026 – 20" W x 26" H (RO: 18" W x 24" H x 4" D)		
	Polished Edge Mirrored – Single Door	RC2026D4FP1	\$ 479.
	Bevel Edge Mirrored – Single Door	RC2026D4FB1	\$ 479.
	RC2036 – 20" W x 36" H (RO: 18" W x 34" H x 4" D)		
	Polished Edge Mirrored – Single Door	RC2036D4FP1	\$ 649.
	Bevel Edge Mirrored – Single Door	RC2036D4FB1	\$ 649.

Cabinets

Accessories & Options



Description	Model	Price
Surface-Mount Kit for Cabinets Quantity 1 = Pair of Mirrored Side Kits and Mounting Hardware		
26" Polished Edge Mirrored	RSMK26D4P	\$ 149.
36" Polished Edge Mirrored	RSMK36D4P	\$ 149.

Note: Models in **bold** indicate Quick Ship product.

SEE PAGE 236 FOR TIPS AND FEATURES.

R³® Series Cabinets – RC24 – 24" Wide, Flat Door

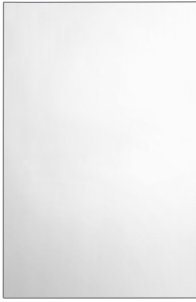

A high quality medicine cabinet designed for easy retrofit renovation, the R3 Series Collection offers Robern quality at our entry price point.

- Ideal for remodeling: features 1" (25 mm) flange to hide gaps, paint lines or any wall imperfections
- Slow-close functionality
- Clean interior due to "hidden" shelf adjustments and off-set door hinge



Two Week
Lead Time

RC24 – 24" W Cabinets

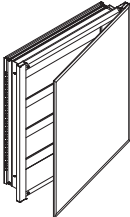
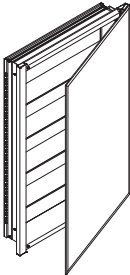
	Description	Model	Price
	RC2426 – 24" W x 26" H (RO: 22" W x 24" H x 4" D) Polished Edge Mirrored – Single Door	RC2426D4FP1	\$ 529.
	Bevel Edge Mirrored – Single Door	RC2426D4FB1	\$ 529.
	RC2436 – 24" W x 36" H (RO: 22" W x 34" H x 4" D) Polished Edge Mirrored – Single Door	RC2436D4FP1	\$ 749.
	Bevel Edge Mirrored – Single Door	RC2436D4FB1	\$ 749.

Accessories & Options



Description	Model	Price
Surface-Mount Kit for Cabinets Quantity 1 = Pair of Mirrored Side Kits and Mounting Hardware		
26" Polished Edge Mirrored	RSMK26D4P	\$ 149.
36" Polished Edge Mirrored	RSMK36D4P	\$ 149.

 **Note:** Models in **bold** indicate Quick Ship product.

SEE PAGE 236 FOR TIPS AND FEATURES.

Vertical Lighting – Ganging Reference

InLine

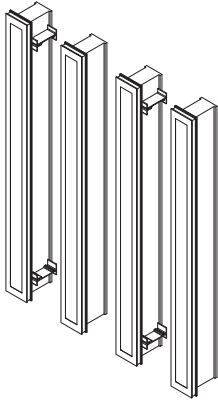

(4) ML3.540ILSFMRDV

+

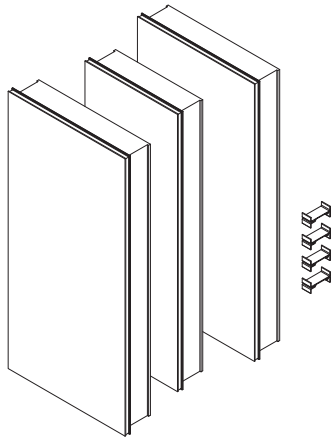

(1) MC2040D4FPRE4
 (1) MC1640D4FPRE4
 (1) MC2040D4FPLE4
 (1) MGKIT

=

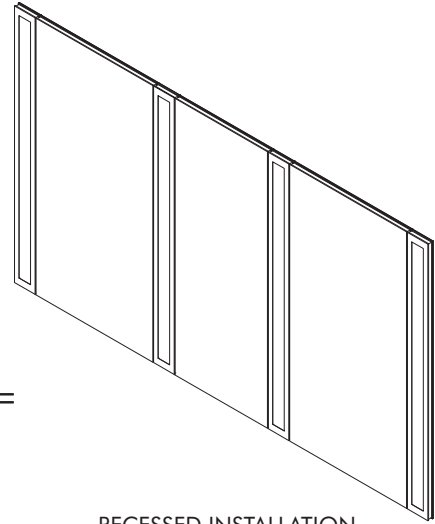

RECESSED INSTALLATION
 67-3/4" x 39-3/8"

Profiles™

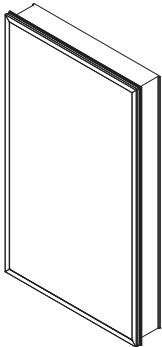

(1) PC2040D4TLE ___
 (1) VP30H1D21T ___ S ___
 (1) VP30H1D21P ___ S ___
 (1) VP30H2D21F ___ S ___

+

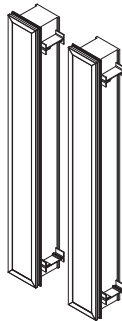

(2) PL5.040TLSC ___ DV
 (1) VM2SKH4D21- ___

=

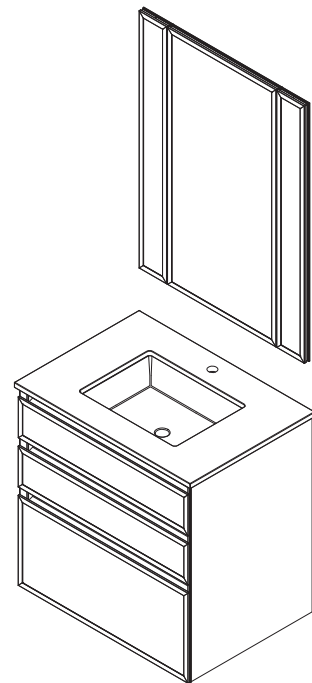

(1) TC31UCO ___ -1

Vertical Lighting – Ganging Reference

1.5 Series

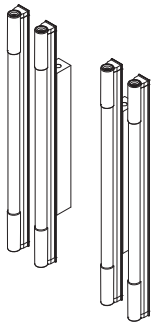

(2) PL30GBL

+

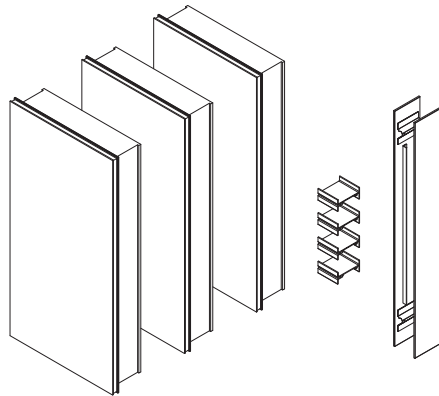

(2) PLM2030BLE
(1) PLM2030BRE
(1) 1.5GKIT
(1) PLSMK30D4P

=

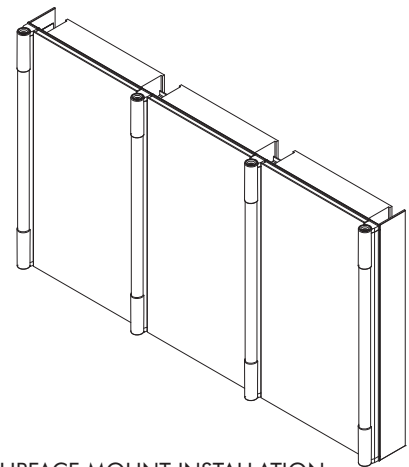

SURFACE MOUNT INSTALLATION
51-3/4" x 30"

Reflexion®

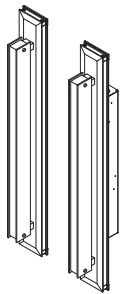

(1) ML3.530RFSBBNNN

+

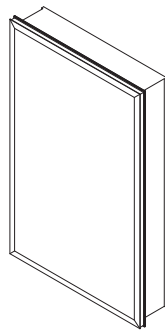

(1) MC2030D4FBLE2

=

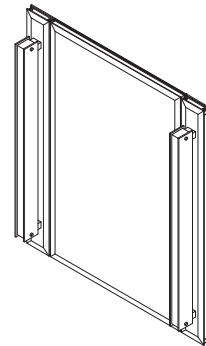

RECESSED INSTALLATION
26-1/4" x 30"

Profiles™ Vertical Lighting – Table of Contents, Tips & Features

Table of Contents

Vertical Lighting Ganging Reference	247 – 248
Profiles™ Vertical Lighting	249 – 251
Profiles Framed Mirrors	28 – 29
Profiles Framed Cabinets	159 – 177

Tips & Features

Dimensions & Weight

- Width: 3-1/2" (89 mm), 5" (127 mm)
- Height: 30" (762 mm), 39-3/8" (1000 mm)
- Depth: 4-5/8" (117 mm) surface-mount, 7/8" (22 mm) when recessed
- Net Weight: 10 – 15 lbs

Features & Benefits

- Create a coordinated ensemble by pairing with Profiles Medicine Cabinets, Profiles Mirrors and Profiles Vanities
- Match all fixtures in your styling space with Profiles metal frame finishes for a coordinated look: Chrome, Polished Nickel, Matte Gold, Matte Black
- Modular vertical lighting can be ganged with Profiles Medicine Cabinets and Profiles Mirrors
- Choose between warm, relaxing tones (2700K) that replicate indoor lighting and cool, invigorating tones (4000K), which simulate bright daylight or choose variable lighting that lets you fine-tune your color temperature between warm (2700K) and cool light (5600K) with the use of dimmers
- Remarkably accurate color rendering with a CRI value of 90+ and R9 of 50+, so you can see your truest reflection
- Light direction and output eliminates dark shadows, provides bright even task lighting and rich, saturated tone in your reflection
- Dimmable LED task lighting to 1% lets you select the ideal brightness for any task, using a standard residential dimmer that works with your home's existing wiring
- Energy efficient LEDs with an estimated life of 53,000 hours
- Will operate in high humidity or damp spaces. ETL certified to UL 1598 CSA Standard C22.2 No. 250.0

Configurable Options

- Metal Frame Finishes:
Chrome, Polished Nickel, Matte Gold, Matte Black
- Color Temperature:
2700K, 4000K, Variable (2700K – 5600K)

Construction

- Durable rust-free anodized aluminum and glass construction – glass resists intense moisture, ensures long-lasting beauty
- Satin anodized aluminum body

Installation

- This installation may require more than one person
- Sold as a single unit (not as pairs)
- Fixture adds 3-1/2" or 5" per light to the overall rough-in width
- Can be recessed or surface-mounted with 4" depth (D4) cabinets (D4 surface-mount kit required) and fully recessed with 6" depth (D6) cabinets
- Ganging kit required if used to mount with multiple cabinets – light comes with ganging hardware on one side
- Operates on 120VAC and 0.5A (2700K/4000K) or 1.0A (variable) per fixture
- Glass lens plane sits flush when paired with a Profiles Medicine Cabinet and Mirror (the mirror when used with ganging kit)
- Wired internally – front access serviceability
- Optional MGKIT includes hardware to gang to both sides of a cabinet. As a result, three lights and two cabinets can be ganged together from one MGKIT.
- Recommended dimmer for Profile fixture: Lutron® C•L Dimmers. This dimmer has full range control, low light adjustment, stops flickering and last setting memory.

Accessories

- Surface-Mount Kit (MSMK__D_P)
- Ganging Kit (MGKIT) – for ganging with cabinets
- Ganging Kit (PMGKIT____) – for ganging with Profiles Mirrors



Profiles™ Vertical Lighting



Wherever you start your day, high-quality task lighting can make all the difference. Profiles Lighting offers remarkably accurate color rendering; adjustable color temperature and bright, consistent output that eliminates harsh shadows on the face - so you see your truest reflection, every time.

- Create a coordinated ensemble by pairing with Profiles medicine cabinets, Profiles mirrors and Profiles vanities
- Choose between warm, relaxing tones (2700K) that replicate indoor lighting and cool, invigorating tones (4000K), which simulate bright daylight or choose variable lighting that lets you fine-tune your color temperature between warm (2700K) and cool light (5600K) with the use of dimmers
- Modular lighting can be ganged with Profiles Medicine Cabinets and Profiles Mirrors



Two Week Lead Time



Dimmable LED



Tunable



Modular

Profiles Lighting (Quantity 1 = Single)

Description	Model	FRAME FINISHES		
		76, 77 Price	82, 83 Price	
Profiles 30" H Lights				
	3-1/2" W – 2700K, Dimmable	PL3.530TLSC __ D3	\$ 1,029.	\$ 1,149.
	3-1/2" W – 4000K, Dimmable	PL3.530TLSC __ D4	\$ 1,029.	\$ 1,149.
	3-1/2" W – Variable, Dimmable	PL3.530TLSC __ DV	\$ 1,199.	\$ 1,299.
	5" W – 2700K, Dimmable	PL5.030TLSC __ D3	\$ 1,349.	\$ 1,479.
	5" W – 4000K, Dimmable	PL5.030TLSC __ D4	\$ 1,349.	\$ 1,479.
	5" W – Variable, Dimmable	PL5.030TLSC __ DV	\$ 1,529.	\$ 1,629.
Profiles 40" H Lights				
	3-1/2" W – 2700K, Dimmable	PL3.540TLSC __ D3	\$ 1,249.	\$ 1,349.
	3-1/2" W – 4000K, Dimmable	PL3.540TLSC __ D4	\$ 1,249.	\$ 1,349.
	3-1/2" W – Variable, Dimmable	PL3.540TLSC __ DV	\$ 1,429.	\$ 1,529.
	5" W – 2700K, Dimmable	PL5.040TLSC __ D3	\$ 1,579.	\$ 1,679.
	5" W – 4000K, Dimmable	PL5.040TLSC __ D4	\$ 1,579.	\$ 1,679.
	5" W – Variable, Dimmable	PL5.040TLSC __ DV	\$ 1,749.	\$ 1,849.

Ganging kit required if Profile lights are used with multiple cabinets: MGKIT \$ 49.

PMGKIT__ ganging kit required if Profile lights are used with Profiles mirrors – refer to the following page.

Operates on 120 volts AC and 0.5A (2700K/4000K) or 1.0A (variable) per fixture. LEDs are CRI 90+ and dimmable.

Frame Finish Options

Fill in __ designator to Model listed above with desired finish. Example: **PL5.040TLSC76DV**.

- 76 Chrome
- 77 Polished Nickel
- 82 Matte Gold
- 83 Matte Black

See Surface-Mount Kits, Accessories & Options on the following page.

Profiles™ Vertical Lighting

Surface-Mount Kits

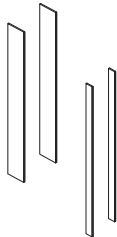
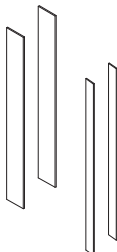
Description	Model	MIRRORED	DECORATIVE		
		Polished Edge	Stock Colors 11, 20, 21	Classic Colors 22, 26, 27, 28	Special Order Colors 12, 19, 23, 24, 25
		Price	Price	Price	Price
30" H – Quantity 1 = Pair of Side Kits and Mounting Hardware					
 D4 Surface-Mount, Polished Edge	MSMK30D4P	\$ 149.	N/A	N/A	N/A
D4 Surface-Mount, Decorative*	MSMK30D4 __	N/A	\$ 199.	\$ 249.	\$ 329.
D6 Surface-Mount, Polished Edge	MSMK30D6P	\$ 199.	N/A	N/A	N/A
D6 Surface-Mount, Decorative*	MSMK30D6 __	N/A	\$ 249.	\$ 329.	\$ 379.
40" H – Quantity 1 = Pair of Side Kits and Mounting Hardware					
 D4 Surface-Mount, Polished Edge	MSMK40D4P	\$ 249.	N/A	N/A	N/A
D4 Surface-Mount, Decorative*	MSMK40D4 __	N/A	\$ 329.	\$ 379.	\$ 429.
D6 Surface-Mount, Polished Edge	MSMK40D6P	\$ 329.	N/A	N/A	N/A
D6 Surface-Mount, Decorative*	MSMK40D6 __	N/A	\$ 379.	\$ 429.	\$ 479.

Surface-Mount Kit Color Options

*Fill in __ designator to Decorative Model listed above with desired color. Example: **MSMK30D620**.

Stock Colors

- 11 Tinted Gray Mirror
- 20 Black
- 21 White

Classic Colors

- 22 Beach
- 26 Matte White
- 27 Matte Gray
- 28 Matte Black

Special Order Colors

- 12 Satin Bronze
- 19 Satin White
- 23 Ocean
- 24 Smoke Screen
- 25 Silver Screen

Accessories & Options

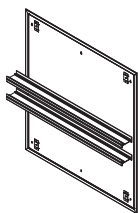

Description	Model	Price
Profiles Mirror/Lighting Ganging Kit		
Hardware required for ganging Profiles Mirrors with Profiles Lighting and Cabinets		
24x30	PMGKIT2430	\$ 379.
30x30	PMGKIT3030	\$ 429.
36x30	PMGKIT3630	\$ 479.
24x40	PMGKIT2440	\$ 379.
30x40	PMGKIT3040	\$ 429.
36x40	PMGKIT3640	\$ 479.

SEE PAGE 249 FOR TIPS AND FEATURES.

InLine Vertical Lighting – Table of Contents, Tips & Features

Table of Contents

Vertical Lighting Ganging Reference 247 – 248

InLine Vertical Lighting 253

Tips & Features

Dimensions & Weight

- Width: 3-1/2" (89 mm)
- Height: 30" (762 mm), 39-3/8" (1000 mm)
- Depth: 4-5/8" (117 mm) surface-mount, 7/8" (22 mm) when recessed
- Net Weight: 10 – 15 lbs

Features & Benefits

- Seamless and flush aesthetic that can be ganged with medicine cabinets
- Choose between warm, relaxing tones (3000K) that replicate indoor lighting and cool, invigorating tones (4000K), which simulate bright daylight or choose variable lighting that lets you fine-tune your color temperature between warm (3000K) and cool (4000K) tones with the use of dimmers
- Remarkably accurate color rendering with a CRI value of 90+ and R9 of 50+, so you can see your truest reflection
- Light direction and output eliminates dark shadows, provides bright even task lighting and rich, saturated tone in your reflection
- Dimmable LED task lighting to 1% lets you select the ideal brightness for any task, using a standard residential dimmer that works with your home's existing wiring
- Modular vertical lighting can be ganged with M Series and PL Series cabinets
- Energy efficient LEDs with an estimated life of 53,000 hours
- Will operate in high humidity or damp spaces. ETL certified to UL 1598 CSA Standard C22.2 No. 250.0

Configurable Options

- Color Temperature: 3000K, 4000K, Variable (3000K – 4000K)

Construction

- Durable rust-free anodized aluminum and glass construction – glass resists intense moisture, ensures long-lasting beauty
- Satin anodized aluminum body
- Can be recessed or surface-mounted with 4" depth (D4) cabinets (D4 surface-mount kit required) and fully recessed with 6" depth (D6) and 8" depth (D8) cabinets
- Ganging kit required if used to mount with multiple cabinets – light comes with ganging hardware on one side
- Fixture adds 3-1/2" per light to the overall rough-in width
- Operates on 120 volts AC and 0.5A (3000K/4000K) or 1.0A (variable) per fixture
- Glass lens plane sits flush when paired with an M Series or PL Series cabinet
- Wired internally – front access serviceability
- MGKIT includes hardware to gang to both sides of a cabinet. As a result, three lights and two cabinets can be ganged together from one MGKIT.
- Recommended dimmer for InLine fixture: Lutron® C•L Dimmers. This dimmer has full range control, low light adjustment, stops flickering and last setting memory.

Installation

- Sold as a single unit (not as pairs)

Accessories

- Ganging Kit (MGKIT)
- Surface-Mount Kit (MSMK__D_P)
- Semi-Recess Mount Kit (MSMK__D8SRP)



Inline Vertical Lighting

A tunable LED task lighting solution, InLine lighting provides a seamless and flush aesthetic that can be ganged with medicine cabinets and mirrors.

- Choose between warm, relaxing tones (3000K) that replicate indoor lighting, cool, invigorating tones (4000K), which simulate bright daylight or variable lighting that allows you to adjust between warm and cool light with the use of dimmers
- Modular lighting can be ganged with M Series and PL Series Cabinets
- Dimmable LED task lighting to 1% lets you select the ideal brightness for any task, using a standard residential dimmer that works with your home's existing wiring



Two Week
Lead Time



Dimmable
LED



Tunable



Modular

ML3.5 InLine Modular LED Light (Quantity 1 = Single) – M Series & PL Series



Description	For Use With M Series & PL Series	Model	Price
3000K, Dimmable	30" H Cabinets	ML3.530ILSFMRD3	\$ 829.
4000K, Dimmable	30" H Cabinets	ML3.530ILSFMRD4	\$ 829.
Variable, Dimmable	30" H Cabinets	ML3.530ILSFMRDV	\$ 979.
3000K, Dimmable	40" H Cabinets	ML3.540ILSFMRD3	\$ 929.
4000K, Dimmable	40" H Cabinets	ML3.540ILSFMRD4	\$ 929.
Variable, Dimmable	40" H Cabinets	ML3.540ILSFMRDV	\$ 1,099.

Ganging kit required if InLine lights are used with multiple cabinets: MGKIT \$ 49.

Operates on 120 VAC and 0.5A (3000K/4000K) or 1.0A (variable) per fixture. LEDs are CRI 90 and dimmable.

Surface-Mount Kits

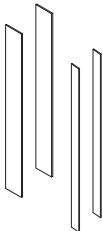
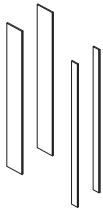

Description	Model	Mirror	Stock Colors	Classic Colors	Special Order Colors
For 30" H Cabinets – Quantity 1 = Pair of Side Kits and Mounting Hardware					
D4 Surface-Mount, Polished Edge	MSMK30D4P	\$ 149.	N/A	N/A	N/A
D4 Surface-Mount, Decorative*	MSMK30D4 __	N/A	\$ 199.	\$ 249.	\$ 329.
D6 Surface-Mount, Polished Edge	MSMK30D6P	\$ 199.	N/A	N/A	N/A
D6 Surface-Mount, Decorative*	MSMK30D6 __	N/A	\$ 249.	\$ 329.	\$ 379.
D8 Semi-Recessed, Polished Edge	MSMK30D8SRP	\$ 149.	N/A	N/A	N/A
D8 Semi-Recessed, Decorative*	MSMK30D8SR __	N/A	\$ 199.	\$ 249.	\$ 329.
For 40" H Cabinets – Quantity 1 = Pair of Side Kits and Mounting Hardware					
D4 Surface-Mount, Polished Edge	MSMK40D4P	\$ 249.	N/A	N/A	N/A
D4 Surface-Mount, Decorative*	MSMK40D4 __	N/A	\$ 329.	\$ 379.	\$ 429.
D6 Surface-Mount, Polished Edge	MSMK40D6P	\$ 329.	N/A	N/A	N/A
D6 Surface-Mount, Decorative*	MSMK40D6 __	N/A	\$ 379.	\$ 429.	\$ 479.
D8 Semi-Recessed, Polished Edge	MSMK40D8SRP	\$ 249.	N/A	N/A	N/A
D8 Semi-Recessed, Decorative*	MSMK40D8SR __	N/A	\$ 329.	\$ 379.	\$ 429.

Surface-Mount Kit Color Options

*Fill in __ designator to Model listed above with desired color. Example: **MSMK40D620**.

Stock Colors

- 11 Tinted Gray Mirror
- 20 Black
- 21 White

Classic Colors

- 22 Beach
- 26 Matte White
- 27 Matte Gray
- 28 Matte Black

Special Order Colors

- 12 Satin Bronze
- 19 Satin White
- 23 Ocean
- 24 Smoke Screen
- 25 Silver Screen

Note: Models in **bold** indicate Quick Ship product.

SEE PAGE 252 FOR TIPS AND FEATURES.

1.5 Series Vertical Lighting – Table of Contents, Tips & Features

Table of Contents

Vertical Lighting Ganging Reference 247 – 248

M Series & PL Series 1.5 Series Vertical Lighting 255

Tips & Features

Dimensions & Weight

- Width: 1-1/2" (38 mm)
- Height:
30" (762 mm)
39-3/8" (1000 mm)
- Net Weight: 11 lbs

Features & Benefits

- A choice between glass or acrylic lens
- End caps:
Chrome or Brushed Nickel for M Series
White, Chrome or Black for PL Series
- Dimmable ballast and non-dimmable options
- Includes 3000K T8, color-corrected bulbs for optimal task lighting
- Works with surface-mount or recessed applications
- Title 24 compliant when used with a Title 24 certified bulb (certified bulb not included)
- UL listed for damp locations

Installation

- Two lights per kit includes: 3,000K T-8 color corrected bulb, dimmable electronic ballast and choice of glass or acrylic shade and end cap finishes
- Dimmable bulbs carry a lifetime bulb replacement warranty
- Not available as a half kit. Two fixtures required for installation.
- Single light is 1-1/2" W. Light kit adds 3" to overall width of installation. Include this in rough opening calculation.
- Recommended dimmer: Lightolier – Sunrise Series, Model # ZP600-EB or the Lutron[®], Model# DVFTU-5A3P (4 sets of lights can go on one dimmer). Light uses the advanced Mark X ballast.
- 40" H = 25 watts each bulb (Model BULBFL3602);
30" H = 17 watt each bulb (Model BULBFL2402).
Bulbs are included. Two bulbs per pack.
- Ganging kit required if used to mount with multiple cabinets
- The Master-to-Remote Cable is included with the fixture, but is sold separately for rough-in

Accessories

- Ganging Kit (1.5GKIT)
- Master-to-Remote Cable (MFL1.5CABL)



1.5 Series Vertical Lighting – M Series & PL Series

With a sleek style and a modular design, 1.5 Series lighting simplifies the styling experience.

- A choice between glass or acrylic lens
- End caps are available in Chrome, Brushed Nickel, White or Black
- Dimmable or non-dimmable ballast options



Two Week
Lead Time



Dimming



Modular

ML1.5 Modular Vertical Fluorescent Light Kits – M Series

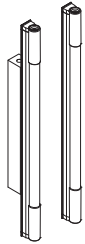

Description	For Use With M Series	Chrome End Caps	Brushed Nickel End Caps	Price
Glass Shade – Dimmable	30" H Cabinets	ML1.530VFSGCRDN	ML1.530VFSGBNDN	\$ 1,299.
Acrylic Shade – Dimmable	30" H Cabinets	ML1.530VFSACRDN	ML1.530VFSABNDN	\$ 1,029.
Glass Shade – Dimmable	40" H Cabinets	ML1.540VFSGCRDN	ML1.540VFSGBNDN	\$ 1,429.
Acrylic Shade – Dimmable	40" H Cabinets	ML1.540VFSACRDN	ML1.540VFSABNDN	\$ 1,149.

Ganging kit required if vertical fluorescent lights are used with multiple cabinets:

1.5GKIT

\$ 49.

Master-to-Remote Cable*

MFL1.5CABL

\$ 99.

*The cable is included with the fixture but is sold separately for rough-in.

Title 24 compliant when used with a Title 24 certified bulb (certified bulb not included).

PL30_/PL40_ 1.5 Vertical Fluorescent Light Kits – PL Series

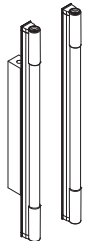

Description	For Use With PL Series	White End Caps	Chrome End Caps	Black End Caps	Price
Glass Shade – Dimmable	30" H Cabinets	PL30GWH	PL30GCH	PL30GBL	\$ 1,299.
Acrylic Shade – Dimmable	30" H Cabinets	PL30PWH	PL30PCH	PL30PBL	\$ 1,029.
Acrylic Shade – Non-Dimmable	30" H Cabinets	PL30PWHN	PL30PCHN	PL30PBLN	\$ 829.
Glass Shade – Dimmable	40" H Cabinets	PL40GWH	PL40GCH	PL40GBL	\$ 1,429.
Acrylic Shade – Dimmable	40" H Cabinets	PL40PWH	PL40PCH	PL40PBL	\$ 1,149.

Ganging kit required if vertical fluorescent lights are used with multiple cabinets:

1.5GKIT

\$ 49.

Title 24 compliant when used with a Title 24 certified bulb (certified bulb not included).



Note: Models in **bold** indicate Quick Ship product.

SEE PAGE 254 FOR TIPS AND FEATURES.

Reflexion® Vertical Lighting

Tips & Features

Dimensions & Weight

- Width: 3-1/2" (89 mm)
- Height:
30" (762 mm),
39-3/8" (1000 mm)
- Depth: 2-5/8" (67 mm)
- Net Weight: 25 – 28 lbs

Features & Benefits

- Available with polished or bevel edge front mirrors, Polished Chrome or Brushed Nickel stanchions
- Efficient 3000K, CRI 85, T5 fluorescent bulbs included
- Coordinates with M Series and PL Series interior, gasket and door
- Title 24 compliant when used with a Title 24 certified bulb (certified bulb not included)
- ETL listed for damp locations

Installation

- Not available as a half kit. Two fixtures required for installation.
- Works with surface-mount or recessed applications
- Light kits add 7" to overall width of cabinet(s). Include this added width in rough opening calculation.
- Lights project 2-5/8" from the wall when fully recessed
- Line voltage fixture uses one T5 21 watt (for 40" H) or 14 watt (for 30" H) 3000K fluorescent bulb per fixture (40" H Model BULBT5212, 30" H Model BULBT5142). Bulbs are included. Two bulbs per pack. Two lights per kit.

Accessories

- Ganging Kit (RGKIT)
Note: See Vertical Lighting Ganging Reference on pages 247 – 248.



Inspired by modern minimalist architectural style, Reflexion lighting provides warm, even illumination for any grooming task and meets energy efficiency standards.

- Available with polished or bevel edge front with chrome or brushed nickel stanchions
- Efficient 3000K, CRI 85, T5 fluorescent bulbs included
- ETL-listed for damp locations



Modular

ML3.5 Reflexion® Modular Fluorescent Light Kits – M Series & PL Series

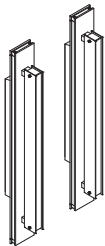

Description	For Use With		Bevel Edge	Polished Edge	Price
	M Series & PL Series				
Chrome Stanchion	30" H Cabinets	ML3.530RFSBCRNN	ML3.530RFSPCRNN	\$ 1,349.	
Brushed Nickel Stanchion	30" H Cabinets	ML3.530RFSBBNNN	ML3.530RFSPBNNN	\$ 1,349.	
Chrome Stanchion	40" H Cabinets	ML3.540RFSBCRNN	ML3.540RFSPCRNN	\$ 1,479.	
Brushed Nickel Stanchion	40" H Cabinets	ML3.540RFSBBNNN	ML3.540RFSPBNNN	\$ 1,479.	

Ganging kit required if Reflexion lights are used with multiple cabinets:

RGKIT \$ 49.

Line voltage fixture uses one T5 21 watt (for 40" H) or 14 watt (for 30" H) 3000K fluorescent bulb per fixture (40" H Model BULBT5212, 30" H Model BULBT5142). Bulbs are included. Two bulbs per pack. Two lights per kit.

Title 24 compliant when used with a Title 24 certified bulb (certified bulb not included).

Note: Models in **bold** indicate Quick Ship product.

Uplift® Lighting – Table of Contents, Tips & Features

Table of Contents

Uplift® Lighting 258

Tips & Features

Uplift Pendant: Dimensions & Weight

- Width: 6-1/2" (165 mm)
- Height: 16-3/4" (426 mm)
- Net Weight: 4 lbs

Uplift Pendant: Features & Benefits

- Sleek and minimalist in style, warm and inviting in use
- Available in Anodized Aluminum, Polished Chrome, Brushed Nickel and Polished Nickel
- Night Light provides a soft, warm glow that allows you to use the space safely at night
- Title 24 compliant when used with a Title 24 certified bulb (certified bulb not included)
- UL listed for damp locations

Uplift Pendant: Installation

- Ceiling mounted
- Sold as a single unit – bulbs not included
- Recommended Bulbs – Robern's 24W, 3000K, 2G11 base (X219-1145) or Philips PL-L24W/830/4D or Sylvania FT24DL/830/ECO

Uplift Sconce: Dimensions & Weight

- Width: 3" (76 mm)
- Height: 22" (559 mm)
- Depth: 4" (102 mm)
- Net Weight: 4 lbs

Uplift Sconce: Features & Benefits

- Sleek and minimalist in style, warm and inviting in use
- Available in Anodized Aluminum, Polished Chrome, Brushed Nickel and Polished Nickel
- Night Light provides a soft, warm glow that allows you to use the space safely at night
- Title 24 compliant when used with a Title 24 certified bulb (certified bulb not included)
- UL listed for damp locations

Uplift Sconce: Installation

- Sold as a single unit – bulbs not included
- Recommended Bulbs – Robern's 24W, 3000K, 2G11 base (X219-1145) or Philips PL-L24W/830/4D or Sylvania FT24DL/830/ECO



Uplift® Lighting



A sleek and minimalist lighting solution, Uplift pendant and sconce provides both task and night light; available in four metal finishes.

- Available in Anodized Aluminum, Chrome, Brushed Nickel and Polished Nickel
- Night light provides a soft, warm glow that allows you to use the space safely at night
- Sold as a single unit; bulb not included



Two Week
Lead Time

Uplift Pendant with Night Light – 6-1/2" x 16-3/4" H

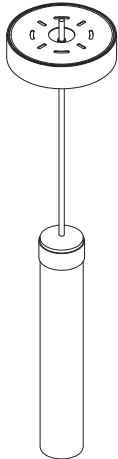

Description	For Use With	Model	Price
Anodized Aluminum Finish	All Cabinets	UFLPAL	\$ 699.
Polished Chrome Finish	All Cabinets	UFLPCRL	\$ 829.
Brushed Nickel Finish	All Cabinets	UFLPBNL	\$ 829.
Polished Nickel Finish	All Cabinets	UFLPPNL	\$ 829.
Bulb: 24W, 3000K, 2G11 base	Uplift Lighting	X219-1145	\$ 99.

Recommended Bulbs – available online and in most lighting supply stores:
Philips PL-L24W/830/4D or Sylvania FT24DL/830/ECO

Title 24 compliant when used with a Title 24 certified bulb (certified bulb not included).

Lighting

Uplift Sconce with Night Light – 3" W x 22" H x 4" D

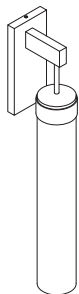

Description	For Use With	Model	Price
Anodized Aluminum Finish	All Cabinets	UFLWAL	\$ 699.
Polished Chrome Finish	All Cabinets	UFLWCRL	\$ 829.
Brushed Nickel Finish	All Cabinets	UFLWBNL	\$ 829.
Polished Nickel Finish	All Cabinets	UFLWPNL	\$ 829.
Bulb: 24W, 3000K, 2G11 base	Uplift Lighting	X219-1145	\$ 99.

Recommended Bulbs – available online and in most lighting supply stores:
Philips PL-L24W/830/4D or Sylvania FT24DL/830/ECO

Title 24 compliant when used with a Title 24 certified bulb (certified bulb not included).

Note: Models in **bold** indicate Quick Ship product.

SEE PAGE 257 FOR TIPS AND FEATURES.

Main Line Sconce

Tips & Features

Dimensions & Weight

- Width: 3-1/8" (79 mm)
- Height: 10-1/4" (260 mm)
- Depth: 3-3/4" (95 mm)
- Net Weight: 4 lbs

Features & Benefits

- Add style, sophistication and light to your space
- Base fixture available in Chrome and Polished Nickel
- Title 24 compliant when used with a Title 24 certified bulb (certified bulb not included)
- UL listed for damp locations

Installation

- Sold as a single unit – bulbs not included
- Recommended for grooming tasks: a 2700K, 26W or 18W 4-pin compact fluorescent bulb



Designed to be the perfect coordinating lighting solution, Main Line sconces allow you to choose from two metal finish options to deliver a dramatic impact to any part of your home.

- Add style, sophistication and light to your space
- Base fixture available in Chrome and Polished Nickel to coordinate with fixtures in your space
- Sold as a single unit; bulb not included

Main Line Sconce – 3-1/8" W x 10-1/4" H x 3-3/4" D



Description	For Use With	Model	Price
Frosted Shade, Chrome Finish	All Cabinets	DLFML76	\$ 699.
Frosted Shade, Polished Nickel Finish	All Cabinets	DLFML77	\$ 699.

Recommended for grooming tasks: a 2700 K, 26W or 18W 4-pin compact fluorescent bulb.

Title 24 compliant when used with a Title 24 certified bulb (certified bulb not included).

Note: Models in **bold** indicate Quick Ship product.

Vanity Accessories – Table of Contents

Electric Accessory	266
Hair Styling Organizer	266
Accessory Night Lights	266
Slim Drawer Inserts	267
Plumbing Drawer Inserts	267
Full Storage Drawer Inserts	267
Balletto® Side Storage Inserts	268
Balletto Side Stop	268
Toilet Paper Holder	268
Accessory Glass Bins	268
Undercounter Sink	269
Vanity Ganging Kits	269
Vanity Alcove Finishing Kits	269
Vanity Stacking Kits	269
Vanity Side Kits	270

Vanity Accessories

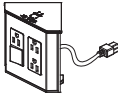
	Model	For Use With Vanities	Price
Electric Accessory			
	VAELECTRIC18	Profiles™ 15" H x 18" D Cartesian® 15" H x 18" D	\$ 449.
	VAELECTRIC21	Profiles 15" H x 21" D Curated Cartesian 15" H x 21" D Cartesian 15" H x 21" D Balletto® 15" H x 21" D	\$ 449.
	VFELECTRIC	V14®	\$ 449.
In-drawer accessory, three plugs and a switch. 120V, 1500W rated. ETL listed.			

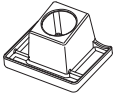
	Model	For Use With Vanities	Price
Hair Styling Organizer			
	VAHAIRORG	Profiles 15" H (except 24" plumbing drawer) Curated Cartesian 15" H (except 24" plumbing drawer) Cartesian 15" H (except 24" plumbing drawer) Balletto 15" H (except 30" plumbing drawer) V14 (except 24" plumbing drawer)	\$ 229.
	Recommend combining Hair Styling Organizer with Electric Accessory. Hair Styling Organizer cannot be used in combination with Slim Drawer Inserts.		

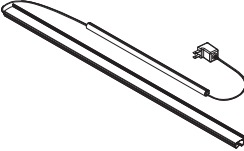
	Model	Description	For Use With Vanities	Price
Accessory Night Lights				
	CLEDS12	12" W Vanities in 5000K	Curated Cartesian Cartesian	\$ 279.
	CLEDS24	24" W Vanities in 5000K	Balletto V14	\$ 329.
	CLEDS30	30" W Vanities in 5000K		\$ 379.
	CLEDS36	36" W Vanities in 5000K		\$ 449.
	SLEDS12	12" W Vanities in 2700K/4000K	Profiles Curated Cartesian Cartesian	\$ 279.
	SLEDS24	24" W Vanities in 2700K/4000K	Balletto	\$ 329.
	SLEDS30	30" W Vanities: in 2700K/4000K		\$ 379.
	SLEDS36	36" W Vanities: in 2700K/4000K		\$ 449.

 **Note:** Models in **bold** indicate Quick Ship product.

Vanity Accessories

Slim Drawer Inserts

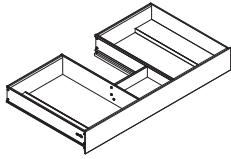

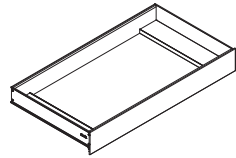

Model	Drawer Size	For Use With Vanities	Price
Plumbing Drawer Inserts			
VADRAWER24P	22-3/16" x 3-3/4" x 15-3/8"	Profiles [™] 24" W x 15" H Curated Cartesian [®] 24" W x 15" H Cartesian 24" W x 15" H Balletto [®] 30" W x 15" H	\$ 629.
VADRAWER30P	28-3/16" x 3-3/4" x 15-3/8"	Profiles 30" W x 15" H Curated Cartesian 30" W x 15" H Cartesian 30" W x 15" H Balletto 36" W x 15" H	\$ 729.
VADRAWER36P	34-3/16" x 3-3/4" x 15-3/8"	Profiles 36" W x 15" H Curated Cartesian 36" W x 15" H Cartesian 36" W x 15" H Balletto 42" W x 15" H	\$ 799.
VFDRAWER24P	22-3/16" x 3-3/4" x 15-3/8"	V14 [®] 24" W V14 36" W (24" plumbing drawer) V14 48" W (24" plumbing drawer)	\$ 629.
VFDRAWER30P	28-3/16" x 3-3/4" x 15-3/8"	V14 30" W	\$ 729.
VFDRAWER36P	34-3/16" x 3-3/4" x 15-3/8"	V14 36" W V14 60" W (36" plumbing drawer)	\$ 799.
Notes: Not for use with plumbing drawer undercounter sink installations or with Robern's stone vanity tops. Can be used in above-counter vessel installations. Profiles, Curated Cartesian, Cartesian & Balletto Plumbing Drawer Inserts include five glass bins.			
Full Storage Drawer Inserts			
VADRAWER12X	10-3/16" x 3-3/4" x 15-3/8"	Profiles 12" W x 15" H Cartesian 12" W x 15" H	\$ 499.
VADRAWER24X	22-3/16" x 3-3/4" x 15-3/8"	Profiles 24" W x 15" H Curated Cartesian 24" W x 15" H Cartesian 24" W x 15" H	\$ 629.
VADRAWER30X	28-3/16" x 3-3/4" x 15-3/8"	Profiles 30" W x 15" H Curated Cartesian 30" W x 15" H Cartesian 30" W x 15" H	\$ 729.
VADRAWER36X	34-3/16" x 3-3/4" x 15-3/8"	Profiles 36" W x 15" H Curated Cartesian 36" W x 15" H Cartesian 36" W x 15" H	\$ 799.
VFDRAWER12X	10-3/16" x 3-3/4" x 15-3/8"	V14 12" W V14 36" W (12" side drawer) V14 48" W (12" side drawer) V14 60" W (12" side drawer)	\$ 499.
VFDRAWER24X	22-3/16" x 3-3/4" x 15-3/8"	V14 24" W	\$ 629.
VFDRAWER30X	28-3/16" x 3-3/4" x 15-3/8"	V14 30" W	\$ 729.
VFDRAWER36X	34-3/16" x 3-3/4" x 15-3/8"	V14 36" W	\$ 799.
Notes: Not for use with plumbing drawer undercounter sink installations or with Robern's stone vanity tops. Can be used with dry top installations. Profiles, Curated Cartesian & Cartesian Full Drawer Inserts include four glass bins.			

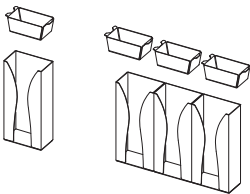
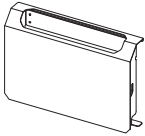
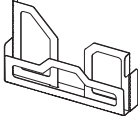
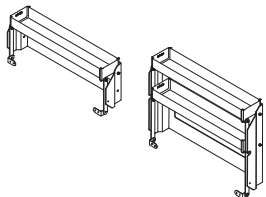

Vanity Accessories

	Model	For Use With Vanities	Price
Balletto® Side Storage Inserts			
	Cotton		
	VACOTTON1	Balletto 15" H	\$ 229.
	VACOTTON3	Balletto 15" H	\$ 449.
For storing tissues and other items in an easy to organize space.			
	Waste		
	VAWASTE	Balletto 15" H	\$ 279.
For storing away items that would rather be kept hidden.			
	Literature		
	VALITERATURE	Balletto 15" H	\$ 279.
For storing magazines, tablets or books for quick access.			
	Articulating		
	VALEVELH1	Balletto 7-1/2" H	\$ 279.
	VALEVELH2	Balletto 15" H	\$ 399.
For storing small items on a self-leveling shelf.			

Balletto Side Stop			
	Side Stop		
	VASIDESTOP	Balletto 15" H	\$ 49.
Limits the distance the side storage drawer can open from 8-3/4" to 5-1/8".			

Toilet Paper Holder			
	VATP	V14® (except 12" W)	\$ 99.
	Can be installed on either side of vanity.		

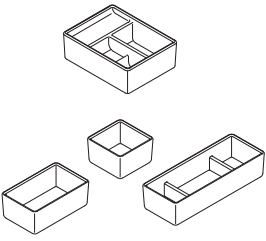
Accessory Glass Bins			
	GLASSBIN6.38	All Vanities	\$ 49.
	Divided Storage, 4-7/8" W x 6-3/8" L x 2-1/8" D		
	GLASSBIN3.25	All Vanities	\$ 49.
	Small, 3-1/4" W x 3-1/4" L		
	GLASSBIN5.25	All Vanities	\$ 49.
Medium, 3-1/4" W x 5-1/4" L			
	GLASSBIN8.5	All Vanities	\$ 49.
Large, 3-1/4" W x 8-1/2" L			

 **Note:** Models in **bold** indicate Quick Ship product.

Vanity Accessories

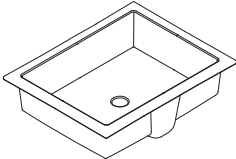
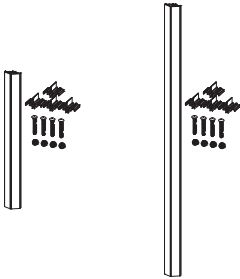
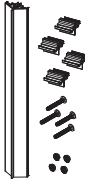
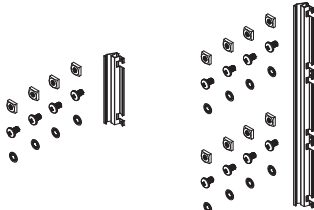
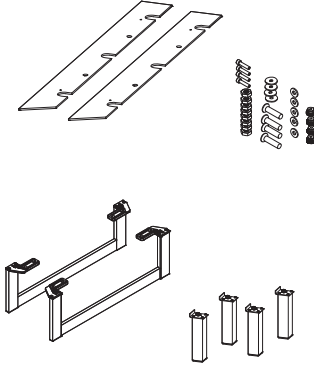
	Description	Model	Price
White Undercounter Sink	 <p>17-1/4" W x 13" L x 5" D Undercounter Sink (can be used with custom countertops)</p> <p>Includes mounting brackets and silicone.</p>	LAV1UM-101	\$ 429.
ProfilesSM/Cartesian[®] Vanity Ganging Kits		<p>Hardware required when combining two or more vanities</p> <p>Ganging Kit, 7-1/2" H VMGKITH1</p> <p>Ganging Kit, 15" H VMGKITH2</p> <p>Ganging Kit, 22-1/2" H VMGKITH3</p> <p>Ganging Kit, 30" H VMGKITH4</p>	<p>\$ 99.</p> <p>\$ 99.</p> <p>\$ 229.</p> <p>\$ 229.</p>
<p>Profiles ganging information can be found on pages 72. Cartesian ganging information can be found on pages 108 – 110. Components needed for stacking are included with each Profiles and Cartesian vanity.</p>			
V14[®] Vanity Ganging Kits		<p>Hardware required when combining two or more vanities</p> <p>Ganging Kit VFGKIT</p>	\$ 99.
<p>V14 ganging information can be found on pages 104 and 105.</p>			
Profiles/Cartesian Vanity Alcove Finishing Kits		<p>Hardware required for corner or alcove installations</p> <p>Alcove Finishing Kit, 7-1/2" H VMAKITH1</p> <p>Alcove Finishing Kit, 15" H VMAKITH2</p> <p>Alcove Finishing Kit, 22-1/2" H VMAKITH3</p> <p>Alcove Finishing Kit, 30" H VMAKITH4</p>	<p>\$ 99.</p> <p>\$ 99.</p> <p>\$ 229.</p> <p>\$ 229.</p>
<p>Note: One kit required per side of vanity.</p>			
V14 Vanity Stacking Kits		<p>Hardware required for stacking two or more wall-hung vanities</p> <p>Stacking Kit VFSTACK</p> <p>Legs and hardware for stacking two or more wall-hung vanities</p> <p>Legs (2) and hardware VFSTACKA</p> <p>Legs (4) and hardware VFSTACKL</p>	<p>\$ 99.</p> <p>\$ 279.</p> <p>\$ 179.</p>

 **Note:** Models in **bold** indicate Quick Ship product.

Vanity Accessories

Profiles™/Cartesian® Vanity Side Kits

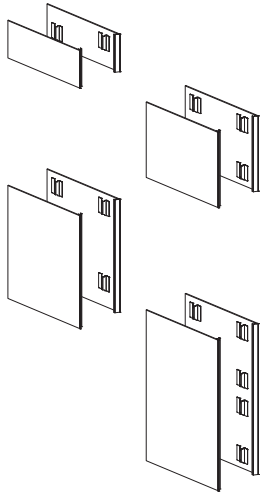

Description	Model	Stock Colors	Classic Colors	Special Order Colors
Includes glass panel(s) & hardware				
Single, 7-1/2" H, 18" D	VM1SKH1D18-__	\$ 229.	\$ 279.	\$ 329.
Single, 7-1/2" H, 21" D	VM1SKH1D21-__	\$ 229.	\$ 279.	\$ 329.
Pair, 7-1/2" H, 18" D	VM2SKH1D18-__	\$ 329.	\$ 449.	\$ 549.
Pair, 7-1/2" H, 21" D	VM2SKH1D21-__	\$ 329.	\$ 449.	\$ 549.
Single, 15" H, 18" D	VM1SKH2D18-__	\$ 279.	\$ 329.	\$ 399.
Single, 15" H, 21" D	VM1SKH2D21-__	\$ 279.	\$ 329.	\$ 399.
Pair, 15" H, 18" D	VM2SKH2D18-__	\$ 399.	\$ 499.	\$ 629.
Pair, 15" H, 21" D	VM2SKH2D21-__	\$ 399.	\$ 499.	\$ 629.
Single, 22-1/2" H, 18" D	VM1SKH3D18-__	\$ 329.	\$ 399.	\$ 449.
Single, 22-1/2" H, 21" D	VM1SKH3D21-__	\$ 329.	\$ 399.	\$ 449.
Pair, 22-1/2" H, 18" D	VM2SKH3D18-__	\$ 549.	\$ 679.	\$ 799.
Pair, 22-1/2" H, 21" D	VM2SKH3D21-__	\$ 549.	\$ 679.	\$ 799.
Single, 30" H, 18" D	VM1SKH4D18-__	\$ 399.	\$ 449.	\$ 499.
Single, 30" H, 21" D	VM1SKH4D21-__	\$ 399.	\$ 449.	\$ 499.
Pair, 30" H, 18" D	VM2SKH4D18-__	\$ 679.	\$ 799.	\$ 899.
Pair, 30" H, 21" D	VM2SKH4D21-__	\$ 679.	\$ 799.	\$ 899.

Note: You must choose one side kit for every exposed side. Side kits sold separately to allow for customization.

Profiles/Cartesian Side Kit Color Options

Fill in __ designator to Model listed above with desired color. Example: VM2SKH4D21-19.

Stock Colors	Classic Colors	Special Order Colors
10 Mirror	22 Beach	12 Satin Bronze
11 Tinted Gray Mirror	26 Matte White	19 Satin White
20 Black	27 Matte Gray	23 Ocean
21 White	28 Matte Black	24 Smoke Screen
		25 Silver Screen

V14® 12" W Vanity Side Kits

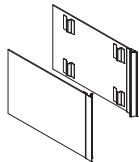

Description	Model	Stock Colors	Classic Colors	Special Order Colors
Includes 2 glass assemblies and hardware	VFSK-__	\$ 549.	\$ 679.	\$ 799.

Note: Side Kits are only required as an additional item when the 12" V14 units are being used independently (i.e. not being ganged with other V14 vanities).

V14 Side Kit Color/Pattern Options

Fill in __ designator to Model listed above with desired color. Example: VFSK-11.

Stock Colors	Classic Colors	Special Order Colors
10 Mirror	22 Beach	12 Satin Bronze
11 Tinted Gray Mirror	26 Matte White	19 Satin White
20 Black	27 Matte Gray	23 Ocean
21 White	28 Matte Black	24 Smoke Screen
		25 Silver Screen

Cabinet Accessories – Table of Contents

Magnifying Mirrors	272
Entice®	272
POMM	272
SOMM	272
CAMM	272
Miscellaneous Cabinet Accessories	272
Safety Lock Box	272
Door Opening Accessories	272
Accessory Glass Bins	272
Accessory Trays	272
Cabinet Ganging Kits	273
Cabinet Stacking Filler System	273
Cabinet Surface-Mount Kits	274 – 275
Cabinet Top & Bottom Kits	275
Profiles™ Mirror Ganging Kit	275

Cabinet Accessories

Magnifying Mirrors

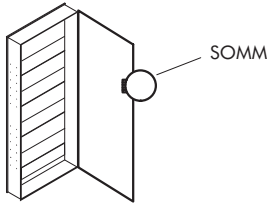
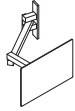
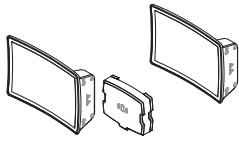

Description	Model	For Use With Cabinets	Price
Entice® Magnification Mirror			
Entice magnification mirror	ENTICE	AiO [®] and M Series	\$ 449.
Entice magnification mirror with inductive charging dock	ENTICEDOCK	AiO and M Series	\$ 499.
Note: Entice does not mount to an M Series Decorative cabinet.			
Pull-Out Magnifying Mirror	POMM	All cabinets except Uplift [®] Tech, AiO 30" & 36" W or R ³ _® Series	\$ 229.
Magnifies at 3X and retracts neatly into cabinet.			
Silver Swing-Out Magnifying Mirror	SOMM	All cabinets except Uplift Tech, AiO 30" & 36" W or R ³ Series	\$ 99.
6.88" diameter x 2X magnification.			
SOMM Magnifying Mirror should be installed on the door, in between shelves.			
Compact Adjustable Magnification Mirror	CAMP	AiO and M Series	\$ 49.
5X magnification.			

Miscellaneous Cabinet Accessories

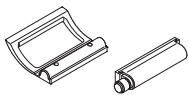
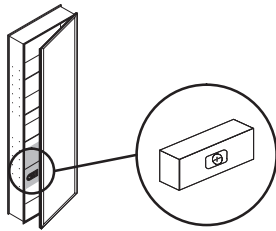

Safety Lock Box			
Full compartment keyed lock box in an anodized aluminum finish	SLB-*	Profiles [™] (except 12" W), AiO 24" W, M Series (except 12" W), Main Line, PL Series	\$ 279.
* Follow SLB with first 2 numbers (width) of cabinet model, then depth of cabinet model. Example: SLB16D6.			

Door Opening Accessories			
Chrome Handle	MHANDLEKIT	AiO, M Series, PL Series	\$ 179.
Push-to-Open Mechanism	MPUSHKIT	Profiles, AiO, M Series, Main Line, PL Series	\$ 99.
Handle options are required when ganging 70" full length cabinets; optional for single cabinets.			

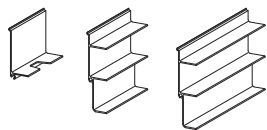
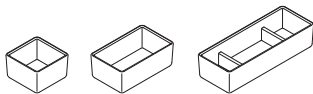

Accessory Glass Bins			
Small, 3-1/4" W x 3-1/4" L	GLASSBIN3.25	All cabinets	\$ 49.
Medium, 3-1/4" W x 5-1/4" L	GLASSBIN5.25	All cabinets	\$ 49.
Large, 3-1/4" W x 8-1/2" L	GLASSBIN8.5	All cabinets	\$ 49.
Accessory Trays			
Razor/Phone Holder	MA-TRAY2.5	Profiles, AiO, M Series	\$ 29.
3" Accessory Tray	MA-TRAY3	Profiles, AiO, M Series	\$ 29.
5" Accessory Tray	MA-TRAY5	Profiles, AiO, M Series	\$ 29.

Note: Models in **bold** indicate Quick Ship product.

Cabinet Accessories

Cabinet Ganging Kits

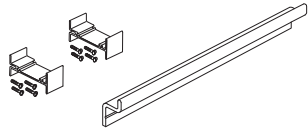

Description	Model	For Use With Cabinets	Price
Quantity 1 = Pair of Side Kits and Mounting Hardware			
Ganging Kit	MGKIT	Profiles [™] , AiO [®] and M Series 30"/40" H Cabinets, InLine Light	\$ 49.
Ganging Kit	MGKIT70	M Series 70" H Full Length Cabinets	\$ 99.
PL Ganging Kit	PLGKIT	PL Series Cabinets	\$ 49.
Hardware required for installing 2 or 3 cabinets side-by-side			
Reflexion [®] Lights Ganging Kit	RGKIT	M Series & PL Series Cabinets	\$ 49.
1.5 Series Lights Ganging Kit	1.5GKIT	M Series & PL Series Cabinets	\$ 49.
Hardware required if lights are used with multiple cabinets			
Uplift [®] Tech Ganging Kit	UGKIT	Uplift Tech Cabinets	\$ 179.
Required when pairing Uplift Tech cabinets			

Cabinet Stacking Filler System

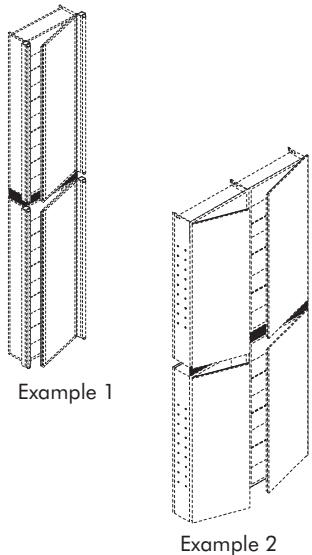

MSF Systems are made to order.
MSF – model designation.
Dimension – total width of all components in inches.
Mounting Configuration:

Surface	MSF – *	Profiles, AiO, M Series, PL Series	\$ 99.
Recessed	MSF – R	Profiles, AiO, M Series, PL Series	\$ 99.
Semi-Recessed	MSF – D2	Profiles, AiO, M Series, PL Series	\$ 99.

* Follow MSF with width in inches of overall cabinet array.

Example 1 – MSF22.25S – MC2040 cabinet with ML1.540_ lights
Example 2 – MSF30.5R – (2) MC1630 cabinets

Notes: Stack filler is required only when vertically stacking cabinets.
MSF adds 5/8" to combined height of cabinets.
Rough opening height is 1-3/8" plus the combined R.O. heights of cabinets.
For special layouts, send sketch to Robern Customer Service.
Bold/Solid line drawing represents actual model number,
Faded/Dotted line drawings are for design reference only.

70" H Stack Filler	MSFMF **	Profiles, M Series, PL Series	\$ 99.
--------------------	----------	-------------------------------	--------

** The MSFMF is only required when ganging 30" H & 40" H surface-mounted cabinets.
When ganging 30" H & 40" H cabinets, single surface-mount side kit models are available,
please contact customer service for model numbers to complete your order.

Note: Not recommended to stack two AiO Cabinets.

Note: Models in **bold** indicate Quick Ship product.

Cabinet Accessories

Surface-Mount Kits for Profiles™, AiO® M Series & Main Line Cabinets

Description	Model	Mirror	Stock Colors	Classic Colors	Special Order Colors
For 30" H Cabinets – Quantity 1 = Pair of Side Kits and Mounting Hardware					
D4 Surface-Mount, Polished Edge	MSMK30D4P	\$ 149.	N/A	N/A	N/A
D4 Surface-Mount, Decorative*	MSMK30D4 __	N/A	\$ 199.	\$ 249.	\$ 329.
D6 Surface-Mount, Polished Edge	MSMK30D6P	\$ 199.	N/A	N/A	N/A
D6 Surface-Mount, Decorative*	MSMK30D6 __	N/A	\$ 249.	\$ 329.	\$ 379.
D6 Semi-Recessed, Polished Edge	MSMK30D6SRP	\$ 149.	N/A	N/A	N/A
D6 Semi-Recessed, Decorative*	MSMK30D6SR __	N/A	\$ 199.	\$ 249.	\$ 329.
D8 Surface-Mount, Polished Edge	MSMK30D8P	\$ 249.	N/A	N/A	N/A
D8 Surface-Mount, Decorative*	MSMK30D8 __	N/A	\$ 329.	\$ 379.	\$ 429.
D8 Semi-Recessed, Polished Edge	MSMK30D8SRP	\$ 149.	N/A	N/A	N/A
D8 Semi-Recessed, Decorative*	MSMK30D8SR __	N/A	\$ 199.	\$ 249.	\$ 329.
For 40" H Cabinets – Quantity 1 = Pair of Side Kits and Mounting Hardware					
D4 Surface-Mount, Polished Edge	MSMK40D4P	\$ 249.	N/A	N/A	N/A
D4 Surface-Mount, Decorative*	MSMK40D4 __	N/A	\$ 329.	\$ 379.	\$ 429.
D6 Surface-Mount, Polished Edge	MSMK40D6P	\$ 329.	N/A	N/A	N/A
D6 Surface-Mount, Decorative*	MSMK40D6 __	N/A	\$ 379.	\$ 429.	\$ 479.
D6 Semi-Recessed, Polished Edge	MSMK40D6SRP	\$ 249.	N/A	N/A	N/A
D6 Semi-Recessed, Decorative*	MSMK40D6SR __	N/A	\$ 329.	\$ 379.	\$ 429.
D8 Surface-Mount, Polished Edge	MSMK40D8P	\$ 379.	N/A	N/A	N/A
D8 Surface-Mount, Decorative*	MSMK40D8 __	N/A	\$ 429.	\$ 479.	\$ 549.
D8 Semi-Recessed, Polished Edge	MSMK40D8SRP	\$ 249.	N/A	N/A	N/A
D8 Semi-Recessed, Decorative*	MSMK40D8SR __	N/A	\$ 329.	\$ 379.	\$ 429.
For 70" H Cabinets – Quantity 1 = Pair of Side Kits and Mounting Hardware					
D4 Surface-Mount, Polished Edge	MSMK70D4P	\$ 429.	N/A	N/A	N/A
D4 Surface-Mount, Decorative*	MSMK70D4 __	N/A	\$ 479.	\$ 599.	\$ 699.
D6 Surface-Mount, Polished Edge	MSMK70D6P	\$ 549.	N/A	N/A	N/A
D6 Surface-Mount, Decorative*	MSMK70D6 __	N/A	\$ 599.	\$ 699.	\$ 829.
D6 Semi-Recessed, Polished Edge	MSMK70D6SRP	\$ 429.	N/A	N/A	N/A
D6 Semi-Recessed, Decorative*	MSMK70D6SR __	N/A	\$ 479.	\$ 599.	\$ 699.
D8 Surface-Mount, Polished Edge	MSMK70D8P	\$ 649.	N/A	N/A	N/A
D8 Surface-Mount, Decorative*	MSMK70D8 __	N/A	\$ 699.	\$ 829.	\$ 929.
D8 Semi-Recessed, Polished Edge	MSMK70D8SRP	\$ 429.	N/A	N/A	N/A
D8 Semi-Recessed, Decorative*	MSMK70D8SR __	N/A	\$ 479.	\$ 599.	\$ 699.

Note: Profiles is not available with 8" depth (D8) cabinets.

Surface-Mount Kit Color Options

*Fill in __ designator to Model listed above with desired color. Example: **MSMK40D620**.

Stock Colors

- 11 Tinted Gray Mirror
- 20 Black
- 21 White

Classic Colors

- 22 Beach
- 26 Matte White
- 27 Matte Gray
- 28 Matte Black

Special Order Colors

- 12 Satin Bronze
- 19 Satin White
- 23 Ocean
- 24 Smoke Screen
- 25 Silver Screen

 **Note:** Models in **bold** indicate Quick Ship product.

Cabinet Accessories

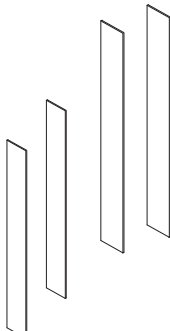
Description	Model	For Use With Cabinets	Price
Surface-Mount Kits for Uplift® Tech, PL Series & R³ Series Cabinets			
Quantity 1 = Pair of Side Kits and Mounting Hardware			
	Surface-Mount, Polished Edge Mirror	USMK27D6P	Uplift Tech \$ 179.
	Semi-Recessed, Polished Edge Mirror	USMK27D6SRP	Uplift Tech \$ 179.
	30" H Surface-Mount, White	MSMK30D4W	PL Series \$ 199.
	30" H Surface-Mount, Polished Edge Mirror	PLSMK30D4P	PL Series \$ 149.
	40" H Surface-Mount, Polished Edge Mirror	PLSMK40D4P	PL Series \$ 249.
	20" H Surface-Mount, Polished Edge Mirror	RSMK20D4P	R ³ Series \$ 149.
	26" H Surface-Mount, Polished Edge Mirror	RSMK26D4P	R ³ Series \$ 149.
	36" H Surface-Mount, Polished Edge Mirror	RSMK36D4P	R ³ Series \$ 149.

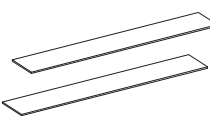
Aluminum Top & Bottom Kits for Uplift Tech Cabinets			
Description	Model	For Use With Cabinets	Price
Required when top or bottom is visible			
	Surface-Mount, 24" W	UTK24D6A	Uplift Tech \$ 229.
	Semi-Recessed, 24" W	UTK24D6ASR	Uplift Tech \$ 229.
	Surface-Mount, 30" W	UTK30D6A	Uplift Tech \$ 229.
	Semi-Recessed, 30" W	UTK30D6ASR	Uplift Tech \$ 229.
	Surface-Mount, 36" W	UTK36D6A	Uplift Tech \$ 229.
	Semi-Recessed, 36" W	UTK36D6ASR	Uplift Tech \$ 229.
	Surface-Mount, 48" W	UTK48D6A	Uplift Tech \$ 229.
	Semi-Recessed, 48" W	UTK48D6ASR	Uplift Tech \$ 229.

Aluminum Bottom Kits for all Cabinets except Uplift Tech or R3 Series					
Description	16" W	20" W	24" W	For Use w/Cabinets	Price
Can be added to any surface-mount or semi-recessed installation to cover bottom of cabinet.					
	Surface-Mount, D4	MBK16D4A	MBK20D4A	MBK24D4A	Profiles™, AiO, M Series, PL Series \$ 99.
	Surface-Mount, D6	MBK16D6A	MBK20D6A	MBK24D6A	Profiles, M Series, Main Line \$ 99.
	Surface-Mount, D8	MBK16D8A	MBK20D8A	MBK24D8A	M Series \$ 99.
	Semi-Recessed, D6	MBK16D6ASR	MBK20D6ASR	MBK24D6ASR	Profiles, M Series, Main Line \$ 99.
	Semi-Recessed, D8	MBK16D8ASR	MBK20D8ASR	MBK24D8ASR	M Series \$ 99.

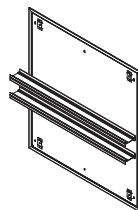
Profiles Ganging Kit			
Description	Model	For Use With Cabinets	Price
Hardware required for ganging Profiles Mirrors with Profiles Lighting and Cabinets			
	24x30	PMGKIT2430	\$ 379.
	30x30	PMGKIT3030	\$ 429.
	36x30	PMGKIT3630	\$ 479.
	24x40	PMGKIT2440	\$ 379.
	30x40	PMGKIT3040	\$ 429.
	36x40	PMGKIT3640	\$ 479.

 **Note:** Models in **bold** indicate Quick Ship product.

Replacement Parts

Cabinets	277 – 278
Shelves	277 – 278
Miscellaneous	278
Lighting	279
Bulbs	279
Miscellaneous	279

Replacement Parts – Cabinets

Cabinet Shelves

Each shelf part contains one shelf and four shelf pins. 4-Packs contain four shelves and 16 shelf pins.

Part No.	For Use With	Price	Part No.	For Use With	Price
AiO® Cabinets			Profiles® Series Cabinets		
SHLF24D4	24" Single Shelf	\$ 99.	SHLF16D4	PC16D4	\$ 99.
SHLF24D4S3	24" 3-Pack of Shelves	\$ 149.	SHLF20D4	PC20D4	\$ 99.
SHLF8D4	30" Single Shelf for Smaller Side of Two Door Cabinet	\$ 60.	SHLF24D4	PC24D4	\$ 99.
SHLF8D4S3	30" 3-Pack of Shelves for Smaller Side of Two Door Cabinet	\$ 71.	SHLF16D6	PC16D6	\$ 99.
SHLF20D4	30" Single Shelf for Larger Side of Two Door Cabinet	\$ 99.	SHLF20D6	PC20D6	\$ 99.
SHLF20D4S3	30" 3-Pack of Shelves for Larger Side of Two Door Cabinet	\$ 149.	SHLF24D6	PC24D6	\$ 99.
SHLF10D4	36" Single Shelf for Smaller Side of Two Door Cabinet	\$ 59.	PL Series Cabinets		
SHLF10D4S3	36" 3-Pack of Shelves for Smaller Side of Two Door Cabinet	\$ 69.	SHLF16D4	PLM16	\$ 99.
SHLF24D4	36" Single Shelf for Larger Side of Two Door Cabinet	\$ 99.	SHLF20D4	PLM20	\$ 99.
SHLF24D4S3	36" 3-Pack of Shelves for Larger Side of Two Door Cabinet	\$ 149.	SHLF24D4	PLM24	\$ 99.
Uplift® Cabinets			SHLFPLM30	PLM30	\$ 99.
X202-1108	21-3/4" W shelf used with Uplift 48" cabinet	\$ 99.	SHLFPLM36	PLM36	\$ 99.
X202-1109	19-7/8" W shelf used with larger compartments of Uplift 30" & Uplift 36" cabinets	\$ 99.	R³® Series Cabinets		
X202-1110	11-1/2" W shelf used w/smaller compartment of Uplift 36" cabinet	\$ 99.	X202-1136	RC16	\$ 99.
X202-1111	6-1/2" W shelf used w/smaller compartment of Uplift 30" cabinet	\$ 99.	X202-1137	RC20	\$ 99.
M Series Cabinets			X202-1138	RC24	\$ 99.
SHLF12D4	12D4	\$ 99.			
SHLF16D4	16D4	\$ 99.			
SHLF16D4S4	16D4 4-Pack	\$ 199.			
SHLF20D4	20D4	\$ 99.			
SHLF20D4S4	20D4 4-Pack	\$ 199.			
SHLF24D4	24D4	\$ 99.			
SHLF24D4S4	24D4 4-Pack	\$ 199.			
SHLF12D6	12D6	\$ 99.			
SHLF16D6	16D6	\$ 99.			
SHLF20D6	20D6	\$ 99.			
SHLF24D6	24D6	\$ 99.			
SHLF16D8	16D8	\$ 99.			
SHLF20D8	20D8	\$ 99.			
SHLF24D8	24D8	\$ 99.			

Replacement Parts – Cabinets

Miscellaneous – Cabinets

Part No.	Description	For Use With	Price
X205-1783	Magnification Mirror	AiO _®	\$ 49.
XSS131-12	Shelf Clips	For all cabinets except R3 _® Series, Uplift _® and Uplift Tech	\$ 9.
X216-1058	40" Cabinet Hinge Bag (3 Hinge)	M Series, PL Series	\$ 43.
X216-1059	30" Cabinet Hinge Bag (2 Hinge)	M Series, PL Series	\$ 34.
X216-1112	Hardware Bag	M Series, PL Series	\$ 10.
XSS134-36	Gray Hole Plugs	For all cabinets except R3 Series, Uplift and Uplift Tech	\$ 8.
XSS712-2	Top Clips for Surface-Mount and Semi-Recessed Installations	For all cabinets except R3 Series, Uplift and Uplift Tech	\$ 9.
X216-1035	38" W Uplift Shelf Pins	Uplift	\$ 21.
X205-1557	48" W Uplift Handle with LED Light	Uplift	\$ 310.
X205-1558	36" W Uplift Handle with LED Light	Uplift	\$ 254.
X205-1559	30" W Uplift Handle with LED Light	Uplift	\$ 224.
X216-1025	Hardware Bag	Uplift	\$ 42.
X216-1055	26" W Single Door Hardware Bag	R3 Series	\$ 11.
X216-1056	26" W Two Door Hardware Bag	R3 Series	\$ 11.
X216-1057	36" W Hardware Bag	R3 Series	\$ 12.
X216-1054	20" W Hardware Bag	R3 Series	\$ 10.
X216-1166	Hardware Bag	Vitality _™	\$ 15.

Replacement Parts – Lighting

Bulbs

Shipping charges are added to shipment of bulbs and not combined with cabinet orders.

Fixture Model	Description	Package Qty.	Order Code	Price per Pack
Uplift® Sconce and Pendant	24 Watt, 3000K, 2G11 Base, Fluorescent	Single	X219-1145	\$ 99.
ML3.540 Reflexion® (40" H)	T5 21 Watt, 3000K Fluorescent	2 per Pack	BULBT5212	\$ 199.
ML3.530 Reflexion (30" H)	T5 14 Watt, 3000K Fluorescent	2 per Pack	BULBT5142	\$ 199.
1.5 Series (40" H)	T-8 3000K, 36" Med. Bipin, 25W Fluorescent	2 per Pack	BULBFL3602	\$ 199.
1.5 Series (30" H)	T-8 3000K, 24" Med. Bipin, 17W Fluorescent	2 per Pack	BULBFL2402	\$ 199.
16" W Eyezon®	24 Watt, 3500K, 2G11 Base, Fluorescent	Single	X219-1151	\$ 99.
20" W & 24" W Eyezon	36 Watt, 3500K, 2G11 Base, Fluorescent	Single	X219-1152	\$ 99.



Note: Models in **bold** indicate Quick Ship product.

Miscellaneous – Lighting

Fixture Model	Description	For Use With	Price
X202-1116	Shade for Sconce and Pendant	Uplift®	\$ 105.
X202-1081	Glass Shade	Main Line Sconce, Decorative Glass Sconce	\$ 15.
X219-1091	Sconce Ballast	Main Line Sconce, Decorative Glass Sconce, Uplift	\$ 102.
X219-1096	Pendant Ballast	Uplift	\$ 103.

Warranty/Terms and Conditions/Care and Cleaning

Limited Warranty, One-Year Term

ROBERN warrants to the original purchaser that it will, at its election, repair, replace, or make appropriate adjustment to products made by this company shown to have significant defects in material or workmanship which are reported to ROBERN in writing within one (1) year from the date of delivery. ROBERN is not responsible for installation costs.

The warranty time period for operating components including door hinges and opening devices to the original owner extends beyond the one-year term.

The warranty is void in the event the product is damaged in transit, or if damage or failure is caused by abuse, misuse, abnormal usage, faulty installation, damage in an accident, improper maintenance, or any repairs other than those authorized by ROBERN. At the expiration of the one-year warranty period, ROBERN shall be under no further obligation under any warranty, expressed or implied, including the implied warranty of merchantability.

ROBERN shall not be liable for any consequential damages arising out of or in connection with the use or performance of its products. Some states do not allow limitations on how long an implied warranty lasts or do not allow the exclusion or limitation of incidental or consequential damages, so the above limitation or exclusion may not apply to you.

Any liability against ROBERN under any implied warranty, including the warranty of merchantability, is expressly limited to the terms of this warranty.

Permission to return any merchandise under this warranty must be authorized by ROBERN and returned prepaid by the purchaser.

Claims under this warranty should be sent directly to your dealer.

Terms and Conditions

Conditions of Purchase

ROBERN products are built to order. Products shipped and received in accordance with customers accepted orders are non-refundable. Certain products are non-cancelable once orders are processed:

- Classic Colors, Special Order Colors:
Vanities, M Series Decorative Cabinets,
Surface-Mount Kits and Side Kits
- Purchase orders cannot be adjusted after 48 hours

Payment Terms

- Payment Terms: Net 30 days.
- Free Freight Allowed on Dealer orders greater than \$1000 net.
- Free Freight Allowed on Distributor orders greater than \$6000 net.

Care and Cleaning

HOW TO CLEAN:

Robern products are constructed of mirrored glass and aluminum. A 50/50 solution of water and isopropyl alcohol is recommended for cleaning the mirrors. Ammonia or vinegar-based cleaners can damage mirrors. A mild detergent may be used on the surfaces. Do not use abrasive cleansers on any part of the cabinet. Use only a soft damp cloth to clean. When cleaning, spray the cloth, not the cabinet, mirror or surrounding surfaces.

Warranty Request Form

Robern Customer Service

701 North Wilson Avenue
Bristol, PA 19007

Fax: 267-540-2053

Email: reference page 11

Phone: 800-877-2376

Registered Robern Dealers and Distributors may request service parts for damaged or defective product using this warranty request form.

- Forms received after 5PM (EST) will be processed on the following business day.
- Warranty parts generally ship within 7 days of order entry.
- Robern Customer Service will email or fax an order confirmation (as preferred) when the order is entered.

We appreciate your business and apologize for any inconvenience this situation may have caused.

Dealer Information

Date: _____

Company Name: _____

Contact Name: _____

Phone Number: _____

Email: _____

Fax Number: _____

Product Information

Please include as much information about the product as possible. Items with an asterisk (*) are required. If required information is missing, this form will be rejected and returned to the sender.

*Model Number: _____

*Robern's PO Number: _____

*Invoice Number: _____

*Description of missing or damaged part: _____

If item is shipping to an end consumer, serial number is required to process: _____

Ship-To Information

If the ship-to address for the warranty parts order is different than that of the original order, please provide the information below.

Complete Name: _____

Street Address: _____

City, State, Zip Code: _____

Contact Phone Number: _____

Contact Email Address: _____

Confirmation Information

Robern Customer Service will provide an order confirmation to the contact information listed below, please indicate your contact preference (email or fax).

Fax: _____

Email: _____

Freight and Return Policy

Freight Policy

Distributors

- \$6000 net minimum order for freight paid by ROBERN
- Under \$6000 net minimum will incur a \$400 handling charge and freight charges as follows:
Zone 1 - \$200 Zone 2 - \$250 Zone 3 - \$300

Dealers

- \$1000 net minimum order for freight paid by ROBERN
- Under \$1000 net minimum will incur freight charges as follows:
Zone 1 - \$85 Zone 2 - \$100 Zone 3 - \$125
- Under \$500 net minimum will incur a \$35 handling charge and freight charges as follows:
Zone 1 - \$15 Zone 2 - \$20 Zone 3 - \$25

Return Policy

Return Policy

- Prior written approval in the form of an RGA (**Return Goods Authorization**) must be obtained from ROBERN Customer Service
- Product must be available in the current price book and not be discontinued or available as limited quantities
- 90 days return window from invoice date
- Buyer will incur a 25% restocking fee
- All products must be returned freight paid by customer
- Product must be received within 14 days of RGA issue date
- ROBERN reserves the right to approve or deny all returns

Ineligible Product

- All Frames
- All Wall Mirrors, except AiO® and Vitality™
- All Replacement Doors
- All Accessories
- Classic Colors and Special Order Colors: Vanities, M Series Decorative Cabinets, Surface-Mount Kits and Side Kits
- Previously installed or opened product
- **All product marked for discontinuation**

Zones

- Zone 1: CT, DE, FL, GA, MA, MD, ME, NC, NH, NJ, NY, PA, RI, SC, VA, VT
- Zone 2: AL, AR, IA, IL, IN, KS, KY, LA, MI, MN, MS, MO, NE, OH, OK, SD, ND, TN, TX, WI, WV
- Zone 3: AZ, CA, CO, ID, MT, NM, NV, OR, UT, WA, WY

Overseas and Shipments Outside Contiguous United States

- All overseas shipments and shipments outside the contiguous United States will be rate quoted and the customer will pay actual freight costs.

How To Make A Return

Fax or email a note requesting an RGA to your Customer Service Agent (CSA) at ROBERN with the following:

- Model and serial number of the product
- Copy of the invoice to verify date and purchase price of the product

Fax 267-540-2053

Email reference page 11

Return product along with a copy of the RGA and RGA # written on the carton. Product must be received in original packaging. Once received at ROBERN, the product will be inspected and credit issued. The product must arrive at ROBERN in A-1 condition to receive credit.

Safe Arrival Policy

ROBERN takes every reasonable precaution against breakage or other damage in transit. It is the Buyer's responsibility to inspect products upon delivery for transit damage and/or shortage. If damage or shortage is detected, it should be duly noted on the bill of lading prior to signing for the merchandise. Buyer must then contact ROBERN to determine if the product can be repaired with replacement parts or returned to ROBERN in exchange for a new unit.

Please do not refuse delivery of damaged product.

Model Number Price Index

Model Number	Price	Page	Model Number	Price	Page
1.5GKIT	\$ 49.	273	36219100TB00001	\$ 4,799.	58
24119400NB00001	\$ 3,479.	54	36219100TB00002	\$ 7,399.	58
24119400NB00002	\$ 4,999.	54	36219100TB00003	\$ 9,299.	58
24119400NB00003	\$ 5,829.	54	36279200NB00001	\$ 4,999.	58
24119400SB00001	\$ 3,799.	54	36279200NB00002	\$ 8,049.	58
24119400SB00002	\$ 5,329.	54	36279200NB00003	\$ 10,399.	58
24119400SB00003	\$ 6,149.	54	36279200SB00001	\$ 5,449.	58
24119400TB00001	\$ 3,799.	54	36279200SB00002	\$ 8,499.	58
24119400TB00002	\$ 5,329.	54	36279200SB00003	\$ 10,849.	58
24119400TB00003	\$ 6,149.	54	36279200TB00001	\$ 5,449.	58
24219100NB00001	\$ 3,049.	54	36279200TB00002	\$ 8,499.	58
24219100NB00002	\$ 4,579.	54	36279200TB00003	\$ 10,849.	58
24219100NB00003	\$ 5,399.	54	AC2430D4P1L	\$ 1,949.	157
24219100SB00001	\$ 3,379.	54	AC2430D4P1LA	\$ 2,499.	157
24219100SB00002	\$ 4,899.	54	AC2430D4P1LAW	\$ 2,499.	157
24219100SB00003	\$ 5,729.	54	AC2430D4P1LW	\$ 1,949.	157
24219100TB00001	\$ 3,379.	54	AC2430D4P1R	\$ 1,949.	157
24219100TB00002	\$ 4,899.	54	AC2430D4P1RA	\$ 2,499.	157
24219100TB00003	\$ 5,729.	54	AC2430D4P1RAW	\$ 2,499.	157
24279200NB00001	\$ 3,699.	54	AC2430D4P1RW	\$ 1,949.	157
24279200NB00002	\$ 5,649.	54	AC2440D4P1L	\$ 2,449.	157
24279200NB00003	\$ 6,929.	54	AC2440D4P1LA	\$ 2,999.	157
24279200SB00001	\$ 4,029.	54	AC2440D4P1LAW	\$ 2,999.	157
24279200SB00002	\$ 5,999.	54	AC2440D4P1LW	\$ 2,449.	157
24279200SB00003	\$ 7,249.	54	AC2440D4P1R	\$ 2,449.	157
24279200TB00001	\$ 4,029.	54	AC2440D4P1RA	\$ 2,999.	157
24279200TB00002	\$ 5,999.	54	AC2440D4P1RAW	\$ 2,999.	157
24279200TB00003	\$ 7,249.	54	AC2440D4P1RW	\$ 2,449.	157
30119400NB00001	\$ 4,149.	56	AC3030D4P2L	\$ 2,349.	157
30119400NB00002	\$ 6,199.	56	AC3030D4P2LA	\$ 2,879.	157
30119400NB00003	\$ 7,579.	56	AC3030D4P2LAW	\$ 2,879.	157
30119400SB00001	\$ 4,529.	56	AC3030D4P2LW	\$ 2,349.	157
30119400SB00002	\$ 6,599.	56	AC3040D4P2L	\$ 2,779.	157
30119400SB00003	\$ 7,949.	56	AC3040D4P2LA	\$ 3,329.	157
30119400TB00001	\$ 4,529.	56	AC3040D4P2LAW	\$ 3,329.	157
30119400TB00002	\$ 6,599.	56	AC3040D4P2LW	\$ 2,779.	157
30119400TB00003	\$ 7,949.	56	AC3630D4P2L	\$ 2,679.	157
30219100NB00001	\$ 3,699.	56	AC3630D4P2LA	\$ 3,199.	157
30219100NB00002	\$ 5,779.	56	AC3630D4P2LAW	\$ 3,199.	157
30219100NB00003	\$ 7,129.	56	AC3630D4P2LW	\$ 2,679.	157
30219100SB00001	\$ 4,079.	56	AC3640D4P2L	\$ 3,099.	157
30219100SB00002	\$ 6,149.	56	AC3640D4P2LA	\$ 3,649.	157
30219100SB00003	\$ 7,529.	56	AC3640D4P2LAW	\$ 3,649.	157
30219100TB00001	\$ 4,079.	56	AC3640D4P2LW	\$ 3,099.	157
30219100TB00002	\$ 6,149.	56	AM2430RFP	\$ 1,429.	27
30219100TB00003	\$ 7,529.	56	AM2430RFPA	\$ 1,849.	27
30279200NB00001	\$ 4,349.	56	AM2430RFPW	\$ 1,849.	27
30279200NB00002	\$ 6,849.	56	AM2430RFPW	\$ 1,429.	27
30279200NB00003	\$ 8,649.	56	AM2440RFP	\$ 1,699.	27
30279200SB00001	\$ 4,729.	56	AM2440RFPA	\$ 2,149.	27
30279200SB00002	\$ 7,249.	56	AM2440RFPW	\$ 2,149.	27
30279200SB00003	\$ 9,049.	56	AM2440RFPW	\$ 1,699.	27
30279200TB00001	\$ 4,729.	56	AM2470RFP	\$ 3,099.	27
30279200TB00002	\$ 7,249.	56	AM3030RFP	\$ 1,599.	27
30279200TB00003	\$ 9,049.	56	AM3030RFPA	\$ 2,049.	27
36119400NB00001	\$ 4,799.	58	AM3030RFPW	\$ 2,049.	27
36119400NB00002	\$ 7,399.	58	AM3030RFPW	\$ 1,599.	27
36119400NB00003	\$ 9,299.	58	AM3040RFP	\$ 1,849.	27
36119400SB00001	\$ 5,229.	58	AM3040RFPA	\$ 2,299.	27
36119400SB00002	\$ 7,849.	58	AM3040RFPW	\$ 2,299.	27
36119400SB00003	\$ 9,749.	58	AM3040RFPW	\$ 1,849.	27
36119400TB00001	\$ 5,229.	58	AM3070RFP	\$ 3,329.	27
36119400TB00002	\$ 7,849.	58	AM3630RFP	\$ 1,779.	27
36119400TB00003	\$ 9,749.	58	AM3630RFPA	\$ 2,229.	27
36219100NB00001	\$ 4,349.	58	AM3630RFPW	\$ 2,229.	27
36219100NB00002	\$ 6,979.	58	AM3630RFPW	\$ 1,779.	27
36219100NB00003	\$ 8,879.	58	AM3640RFP	\$ 2,049.	27
36219100SB00001	\$ 4,799.	58	AM3640RFPA	\$ 2,499.	27
36219100SB00002	\$ 7,399.	58	AM3640RFPW	\$ 2,499.	27
36219100SB00003	\$ 9,299.	58	AM3640RFPW	\$ 2,049.	27

— [] denotes Color/Pattern/Style options.

Model Number Price Index

Model Number	Price	Page	Model Number	Price	Page
AM367ORFP	\$ 3,549.	27	DC1630D6PVGRE__ [70/71]	\$ 1,299.	217
BULBFL2402	\$ 199.	279	DC1630D6PVGRE__ [74/75/79]	\$ 1,429.	217
BULBFL3602	\$ 199.	279	DC1630D6PVGRE__ [76/77]	\$ 1,629.	217
BULBT5142	\$ 199.	279	DC1630D6RMG__ [70/71]	\$ 1,029.	223
BULBT5212	\$ 199.	279	DC1630D6RMG__ [74/75/79]	\$ 1,129.	223
CAMM	\$ 49.	272	DC1630D6RMG__ [76/77]	\$ 1,329.	223
CLEDS12	\$ 279.	266	DC1630D6RMGLE__ [70/71]	\$ 1,299.	223
CLEDS24	\$ 329.	266	DC1630D6RMGLE__ [74/75/79]	\$ 1,429.	223
CLEDS30	\$ 379.	266	DC1630D6RMGLE__ [76/77]	\$ 1,629.	223
CLEDS36	\$ 449.	266	DC1630D6RMGRE__ [70/71]	\$ 1,299.	223
DC1630D4BMG__ [70/71]	\$ 749.	205	DC1630D6RMGRE__ [74/75/79]	\$ 1,429.	223
DC1630D4BMG__ [74/75/79]	\$ 849.	205	DC1630D6RMGRE__ [76/77]	\$ 1,629.	223
DC1630D4BMG__ [76/77]	\$ 1,079.	205	DC1640D4BMG__ [70/71]	\$ 949.	208
DC1630D4BMGLE__ [70/71]	\$ 1,029.	205	DC1640D4BMG__ [74/75/79]	\$ 1,079.	208
DC1630D4BMGLE__ [74/75/79]	\$ 1,149.	205	DC1640D4BMG__ [76/77]	\$ 1,279.	208
DC1630D4BMGLE__ [76/77]	\$ 1,349.	205	DC1640D4BMGLE__ [70/71]	\$ 1,249.	208
DC1630D4BMGRE__ [70/71]	\$ 1,029.	205	DC1640D4BMGLE__ [74/75/79]	\$ 1,349.	208
DC1630D4BMGRE__ [74/75/79]	\$ 1,149.	205	DC1640D4BMGLE__ [76/77]	\$ 1,579.	208
DC1630D4BMGRE__ [76/77]	\$ 1,349.	205	DC1640D4BMGRE__ [70/71]	\$ 1,249.	208
DC1630D4MEG__ [70/71]	\$ 749.	211	DC1640D4BMGRE__ [74/75/79]	\$ 1,349.	208
DC1630D4MEG__ [74/75/79]	\$ 849.	211	DC1640D4BMGRE__ [76/77]	\$ 1,579.	208
DC1630D4MEG__ [76/77]	\$ 1,079.	211	DC1640D4MEG__ [70/71]	\$ 949.	214
DC1630D4MEGLE__ [70/71]	\$ 1,029.	211	DC1640D4MEG__ [74/75/79]	\$ 1,079.	214
DC1630D4MEGLE__ [74/75/79]	\$ 1,149.	211	DC1640D4MEG__ [76/77]	\$ 1,279.	214
DC1630D4MEGLE__ [76/77]	\$ 1,349.	211	DC1640D4MEGLE__ [70/71]	\$ 1,249.	214
DC1630D4MEGRE__ [70/71]	\$ 1,029.	211	DC1640D4MEGLE__ [74/75/79]	\$ 1,349.	214
DC1630D4MEGRE__ [74/75/79]	\$ 1,149.	211	DC1640D4MEGLE__ [76/77]	\$ 1,579.	214
DC1630D4MEGRE__ [76/77]	\$ 1,349.	211	DC1640D4MEGRE__ [70/71]	\$ 1,249.	214
DC1630D4PVG__ [70/71]	\$ 749.	217	DC1640D4MEGRE__ [74/75/79]	\$ 1,349.	214
DC1630D4PVG__ [74/75/79]	\$ 849.	217	DC1640D4MEGRE__ [76/77]	\$ 1,579.	214
DC1630D4PVG__ [76/77]	\$ 1,079.	217	DC1640D4PVG__ [70/71]	\$ 949.	220
DC1630D4PVGLE__ [70/71]	\$ 1,029.	217	DC1640D4PVG__ [74/75/79]	\$ 1,079.	220
DC1630D4PVGLE__ [74/75/79]	\$ 1,149.	217	DC1640D4PVG__ [76/77]	\$ 1,279.	220
DC1630D4PVGLE__ [76/77]	\$ 1,349.	217	DC1640D4PVGLE__ [70/71]	\$ 1,249.	220
DC1630D4PVGRE__ [70/71]	\$ 1,029.	217	DC1640D4PVGLE__ [74/75/79]	\$ 1,349.	220
DC1630D4PVGRE__ [74/75/79]	\$ 1,149.	217	DC1640D4PVGLE__ [76/77]	\$ 1,579.	220
DC1630D4PVGRE__ [76/77]	\$ 1,349.	217	DC1640D4PVGRE__ [70/71]	\$ 1,249.	220
DC1630D4RMG__ [70/71]	\$ 749.	223	DC1640D4PVGRE__ [74/75/79]	\$ 1,349.	220
DC1630D4RMG__ [74/75/79]	\$ 849.	223	DC1640D4PVGRE__ [76/77]	\$ 1,579.	220
DC1630D4RMG__ [76/77]	\$ 1,079.	223	DC1640D4RMG__ [70/71]	\$ 949.	226
DC1630D4RMGLE__ [70/71]	\$ 1,029.	223	DC1640D4RMG__ [74/75/79]	\$ 1,079.	226
DC1630D4RMGLE__ [74/75/79]	\$ 1,149.	223	DC1640D4RMG__ [76/77]	\$ 1,279.	226
DC1630D4RMGLE__ [76/77]	\$ 1,349.	223	DC1640D4RMGLE__ [70/71]	\$ 1,249.	226
DC1630D4RMGRE__ [70/71]	\$ 1,029.	223	DC1640D4RMGLE__ [74/75/79]	\$ 1,349.	226
DC1630D4RMGRE__ [74/75/79]	\$ 1,149.	223	DC1640D4RMGLE__ [76/77]	\$ 1,579.	226
DC1630D4RMGRE__ [76/77]	\$ 1,349.	223	DC1640D4RMGRE__ [70/71]	\$ 1,249.	226
DC1630D6BMG__ [70/71]	\$ 1,029.	205	DC1640D4RMGRE__ [74/75/79]	\$ 1,349.	226
DC1630D6BMG__ [74/75/79]	\$ 1,129.	205	DC1640D4RMGRE__ [76/77]	\$ 1,579.	226
DC1630D6BMG__ [76/77]	\$ 1,329.	205	DC1640D6BMG__ [70/71]	\$ 1,229.	208
DC1630D6BMGLE__ [70/71]	\$ 1,299.	205	DC1640D6BMG__ [74/75/79]	\$ 1,329.	208
DC1630D6BMGLE__ [74/75/79]	\$ 1,429.	205	DC1640D6BMG__ [76/77]	\$ 1,549.	208
DC1630D6BMGLE__ [76/77]	\$ 1,629.	205	DC1640D6BMGLE__ [70/71]	\$ 1,529.	208
DC1630D6BMGRE__ [70/71]	\$ 1,299.	205	DC1640D6BMGLE__ [74/75/79]	\$ 1,629.	208
DC1630D6BMGRE__ [74/75/79]	\$ 1,429.	205	DC1640D6BMGLE__ [76/77]	\$ 1,849.	208
DC1630D6BMGRE__ [76/77]	\$ 1,629.	205	DC1640D6BMGRE__ [70/71]	\$ 1,529.	208
DC1630D6MEG__ [70/71]	\$ 1,029.	211	DC1640D6BMGRE__ [74/75/79]	\$ 1,629.	208
DC1630D6MEG__ [74/75/79]	\$ 1,129.	211	DC1640D6BMGRE__ [76/77]	\$ 1,849.	208
DC1630D6MEG__ [76/77]	\$ 1,329.	211	DC1640D6MEG__ [70/71]	\$ 1,229.	214
DC1630D6MEGLE__ [70/71]	\$ 1,299.	211	DC1640D6MEG__ [74/75/79]	\$ 1,329.	214
DC1630D6MEGLE__ [74/75/79]	\$ 1,429.	211	DC1640D6MEG__ [76/77]	\$ 1,549.	214
DC1630D6MEGLE__ [76/77]	\$ 1,629.	211	DC1640D6MEGLE__ [70/71]	\$ 1,529.	214
DC1630D6MEGRE__ [70/71]	\$ 1,299.	211	DC1640D6MEGLE__ [74/75/79]	\$ 1,629.	214
DC1630D6MEGRE__ [74/75/79]	\$ 1,429.	211	DC1640D6MEGLE__ [76/77]	\$ 1,849.	214
DC1630D6MEGRE__ [76/77]	\$ 1,629.	211	DC1640D6MEGRE__ [70/71]	\$ 1,529.	214
DC1630D6PVG__ [70/71]	\$ 1,029.	217	DC1640D6MEGRE__ [74/75/79]	\$ 1,629.	214
DC1630D6PVG__ [74/75/79]	\$ 1,129.	217	DC1640D6MEGRE__ [76/77]	\$ 1,849.	214
DC1630D6PVG__ [76/77]	\$ 1,329.	217	DC1640D6PVG__ [70/71]	\$ 1,229.	220
DC1630D6PVGLE__ [70/71]	\$ 1,299.	217	DC1640D6PVG__ [74/75/79]	\$ 1,329.	220
DC1630D6PVGLE__ [74/75/79]	\$ 1,429.	217	DC1640D6PVG__ [76/77]	\$ 1,549.	220
DC1630D6PVGLE__ [76/77]	\$ 1,629.	217			

[_] denotes Color/Pattern/Style options.

Model Number Price Index

Model Number	Price	Page
DC1640D6PVGLE__ [70/71]	\$ 1,529.	220
DC1640D6PVGLE__ [74/75/79]	\$ 1,629.	220
DC1640D6PVGLE__ [76/77]	\$ 1,849.	220
DC1640D6PVGRE__ [70/71]	\$ 1,529.	220
DC1640D6PVGRE__ [74/75/79]	\$ 1,629.	220
DC1640D6PVGRE__ [76/77]	\$ 1,849.	220
DC1640D6RMG__ [70/71]	\$ 1,229.	226
DC1640D6RMG__ [74/75/79]	\$ 1,329.	226
DC1640D6RMG__ [76/77]	\$ 1,549.	226
DC1640D6RMGLE__ [70/71]	\$ 1,529.	226
DC1640D6RMGLE__ [74/75/79]	\$ 1,629.	226
DC1640D6RMGLE__ [76/77]	\$ 1,849.	226
DC1640D6RMGRE__ [70/71]	\$ 1,529.	226
DC1640D6RMGRE__ [74/75/79]	\$ 1,629.	226
DC1640D6RMGRE__ [76/77]	\$ 1,849.	226
DC2030D4BMG__ [70/71]	\$ 849.	206
DC2030D4BMG__ [74/75/79]	\$ 949.	206
DC2030D4BMG__ [76/77]	\$ 1,179.	206
DC2030D4BMGLE__ [70/71]	\$ 1,149.	206
DC2030D4BMGLE__ [74/75/79]	\$ 1,249.	206
DC2030D4BMGLE__ [76/77]	\$ 1,479.	206
DC2030D4BMGRE__ [70/71]	\$ 1,149.	206
DC2030D4BMGRE__ [74/75/79]	\$ 1,249.	206
DC2030D4BMGRE__ [76/77]	\$ 1,479.	206
DC2030D4MEG__ [70/71]	\$ 849.	212
DC2030D4MEG__ [74/75/79]	\$ 949.	212
DC2030D4MEG__ [76/77]	\$ 1,179.	212
DC2030D4MEGLE__ [70/71]	\$ 1,149.	212
DC2030D4MEGLE__ [74/75/79]	\$ 1,249.	212
DC2030D4MEGLE__ [76/77]	\$ 1,479.	212
DC2030D4MEGRE__ [70/71]	\$ 1,149.	212
DC2030D4MEGRE__ [74/75/79]	\$ 1,249.	212
DC2030D4MEGRE__ [76/77]	\$ 1,479.	212
DC2030D4PVG__ [70/71]	\$ 849.	218
DC2030D4PVG__ [74/75/79]	\$ 949.	218
DC2030D4PVG__ [76/77]	\$ 1,179.	218
DC2030D4PVGLE__ [70/71]	\$ 1,149.	218
DC2030D4PVGLE__ [74/75/79]	\$ 1,249.	218
DC2030D4PVGLE__ [76/77]	\$ 1,479.	218
DC2030D4PVGRE__ [70/71]	\$ 1,149.	218
DC2030D4PVGRE__ [74/75/79]	\$ 1,249.	218
DC2030D4PVGRE__ [76/77]	\$ 1,479.	218
DC2030D4RMG__ [70/71]	\$ 849.	224
DC2030D4RMG__ [74/75/79]	\$ 949.	224
DC2030D4RMG__ [76/77]	\$ 1,179.	224
DC2030D4RMGLE__ [70/71]	\$ 1,149.	224
DC2030D4RMGLE__ [74/75/79]	\$ 1,249.	224
DC2030D4RMGLE__ [76/77]	\$ 1,479.	224
DC2030D4RMGRE__ [70/71]	\$ 1,149.	224
DC2030D4RMGRE__ [74/75/79]	\$ 1,249.	224
DC2030D4RMGRE__ [76/77]	\$ 1,479.	224
DC2030D6BMG__ [70/71]	\$ 1,129.	206
DC2030D6BMG__ [74/75/79]	\$ 1,229.	206
DC2030D6BMG__ [76/77]	\$ 1,449.	206
DC2030D6BMGLE__ [70/71]	\$ 1,429.	206
DC2030D6BMGLE__ [74/75/79]	\$ 1,529.	206
DC2030D6BMGLE__ [76/77]	\$ 1,749.	206
DC2030D6BMGRE__ [70/71]	\$ 1,429.	206
DC2030D6BMGRE__ [74/75/79]	\$ 1,529.	206
DC2030D6BMGRE__ [76/77]	\$ 1,749.	206
DC2030D6MEG__ [70/71]	\$ 1,129.	212
DC2030D6MEG__ [74/75/79]	\$ 1,229.	212
DC2030D6MEG__ [76/77]	\$ 1,449.	212
DC2030D6MEGLE__ [70/71]	\$ 1,429.	212
DC2030D6MEGLE__ [74/75/79]	\$ 1,529.	212
DC2030D6MEGLE__ [76/77]	\$ 1,749.	212
DC2030D6MEGRE__ [70/71]	\$ 1,429.	212
DC2030D6MEGRE__ [74/75/79]	\$ 1,529.	212
DC2030D6MEGRE__ [76/77]	\$ 1,749.	212

Model Number	Price	Page
DC2030D6PVG__ [70/71]	\$ 1,129.	218
DC2030D6PVG__ [74/75/79]	\$ 1,229.	218
DC2030D6PVG__ [76/77]	\$ 1,449.	218
DC2030D6PVGLE__ [70/71]	\$ 1,429.	218
DC2030D6PVGLE__ [74/75/79]	\$ 1,529.	218
DC2030D6PVGLE__ [76/77]	\$ 1,749.	218
DC2030D6PVGRE__ [70/71]	\$ 1,429.	218
DC2030D6PVGRE__ [74/75/79]	\$ 1,529.	218
DC2030D6PVGRE__ [76/77]	\$ 1,749.	218
DC2030D6RMG__ [70/71]	\$ 1,129.	224
DC2030D6RMG__ [74/75/79]	\$ 1,229.	224
DC2030D6RMG__ [76/77]	\$ 1,449.	224
DC2030D6RMGLE__ [70/71]	\$ 1,429.	224
DC2030D6RMGLE__ [74/75/79]	\$ 1,529.	224
DC2030D6RMGLE__ [76/77]	\$ 1,749.	224
DC2030D6RMGRE__ [70/71]	\$ 1,429.	224
DC2030D6RMGRE__ [74/75/79]	\$ 1,529.	224
DC2030D6RMGRE__ [76/77]	\$ 1,749.	224
DC2040D4BMG__ [70/71]	\$ 1,079.	209
DC2040D4BMG__ [74/75/79]	\$ 1,179.	209
DC2040D4BMG__ [76/77]	\$ 1,399.	209
DC2040D4BMGLE__ [70/71]	\$ 1,349.	209
DC2040D4BMGLE__ [74/75/79]	\$ 1,479.	209
DC2040D4BMGLE__ [76/77]	\$ 1,679.	209
DC2040D4BMGRE__ [70/71]	\$ 1,349.	209
DC2040D4BMGRE__ [74/75/79]	\$ 1,479.	209
DC2040D4BMGRE__ [76/77]	\$ 1,679.	209
DC2040D4MEG__ [70/71]	\$ 1,079.	215
DC2040D4MEG__ [74/75/79]	\$ 1,179.	215
DC2040D4MEG__ [76/77]	\$ 1,399.	215
DC2040D4MEGLE__ [70/71]	\$ 1,349.	215
DC2040D4MEGLE__ [74/75/79]	\$ 1,479.	215
DC2040D4MEGLE__ [76/77]	\$ 1,679.	215
DC2040D4MEGRE__ [70/71]	\$ 1,349.	215
DC2040D4MEGRE__ [74/75/79]	\$ 1,479.	215
DC2040D4MEGRE__ [76/77]	\$ 1,679.	215
DC2040D4PVG__ [70/71]	\$ 1,079.	221
DC2040D4PVG__ [74/75/79]	\$ 1,179.	221
DC2040D4PVG__ [76/77]	\$ 1,399.	221
DC2040D4PVGLE__ [70/71]	\$ 1,349.	221
DC2040D4PVGLE__ [74/75/79]	\$ 1,479.	221
DC2040D4PVGLE__ [76/77]	\$ 1,679.	221
DC2040D4PVGRE__ [70/71]	\$ 1,349.	221
DC2040D4PVGRE__ [74/75/79]	\$ 1,479.	221
DC2040D4PVGRE__ [76/77]	\$ 1,679.	221
DC2040D4RMG__ [70/71]	\$ 1,079.	227
DC2040D4RMG__ [74/75/79]	\$ 1,179.	227
DC2040D4RMG__ [76/77]	\$ 1,399.	227
DC2040D4RMGLE__ [70/71]	\$ 1,349.	227
DC2040D4RMGLE__ [74/75/79]	\$ 1,479.	227
DC2040D4RMGLE__ [76/77]	\$ 1,679.	227
DC2040D4RMGRE__ [70/71]	\$ 1,349.	227
DC2040D4RMGRE__ [74/75/79]	\$ 1,479.	227
DC2040D4RMGRE__ [76/77]	\$ 1,679.	227
DC2040D6BMG__ [70/71]	\$ 1,329.	209
DC2040D6BMG__ [74/75/79]	\$ 1,449.	209
DC2040D6BMG__ [76/77]	\$ 1,649.	209
DC2040D6BMGLE__ [70/71]	\$ 1,629.	209
DC2040D6BMGLE__ [74/75/79]	\$ 1,749.	209
DC2040D6BMGLE__ [76/77]	\$ 1,949.	209
DC2040D6BMGRE__ [70/71]	\$ 1,629.	209
DC2040D6BMGRE__ [74/75/79]	\$ 1,749.	209
DC2040D6BMGRE__ [76/77]	\$ 1,949.	209
DC2040D6MEG__ [70/71]	\$ 1,329.	215
DC2040D6MEG__ [74/75/79]	\$ 1,449.	215
DC2040D6MEG__ [76/77]	\$ 1,649.	215
DC2040D6MEGLE__ [70/71]	\$ 1,629.	215
DC2040D6MEGLE__ [74/75/79]	\$ 1,749.	215
DC2040D6MEGLE__ [76/77]	\$ 1,949.	215

__ [] denotes Color/Pattern/Style options.

Model Number Price Index

Model Number	Price	Page	Model Number	Price	Page
DC2040D6MEGRE__ [70/71]	\$ 1,629.	215	DC2430D6MEGLE__ [70/71]	\$ 1,529.	213
DC2040D6MEGRE__ [74/75/79]	\$ 1,749.	215	DC2430D6MEGLE__ [74/75/79]	\$ 1,629.	213
DC2040D6MEGRE__ [76/77]	\$ 1,949.	215	DC2430D6MEGLE__ [76/77]	\$ 1,849.	213
DC2040D6PVG__ [70/71]	\$ 1,329.	221	DC2430D6MEGRE__ [70/71]	\$ 1,529.	213
DC2040D6PVG__ [74/75/79]	\$ 1,449.	221	DC2430D6MEGRE__ [74/75/79]	\$ 1,629.	213
DC2040D6PVG__ [76/77]	\$ 1,649.	221	DC2430D6MEGRE__ [76/77]	\$ 1,849.	213
DC2040D6PVGLE__ [70/71]	\$ 1,629.	221	DC2430D6PVG__ [70/71]	\$ 1,229.	219
DC2040D6PVGLE__ [74/75/79]	\$ 1,749.	221	DC2430D6PVG__ [74/75/79]	\$ 1,329.	219
DC2040D6PVGLE__ [76/77]	\$ 1,949.	221	DC2430D6PVG__ [76/77]	\$ 1,549.	219
DC2040D6PVGRE__ [70/71]	\$ 1,629.	221	DC2430D6PVGLE__ [70/71]	\$ 1,529.	219
DC2040D6PVGRE__ [74/75/79]	\$ 1,749.	221	DC2430D6PVGLE__ [74/75/79]	\$ 1,629.	219
DC2040D6PVGRE__ [76/77]	\$ 1,949.	221	DC2430D6PVGLE__ [76/77]	\$ 1,849.	219
DC2040D6RMG__ [70/71]	\$ 1,329.	227	DC2430D6PVGRE__ [70/71]	\$ 1,529.	219
DC2040D6RMG__ [74/75/79]	\$ 1,449.	227	DC2430D6PVGRE__ [74/75/79]	\$ 1,629.	219
DC2040D6RMG__ [76/77]	\$ 1,649.	227	DC2430D6PVGRE__ [76/77]	\$ 1,849.	219
DC2040D6RMGLE__ [70/71]	\$ 1,629.	227	DC2430D6RMG__ [70/71]	\$ 1,229.	225
DC2040D6RMGLE__ [74/75/79]	\$ 1,749.	227	DC2430D6RMG__ [74/75/79]	\$ 1,329.	225
DC2040D6RMGLE__ [76/77]	\$ 1,949.	227	DC2430D6RMG__ [76/77]	\$ 1,549.	225
DC2040D6RMGRE__ [70/71]	\$ 1,629.	227	DC2430D6RMGLE__ [70/71]	\$ 1,529.	225
DC2040D6RMGRE__ [74/75/79]	\$ 1,749.	227	DC2430D6RMGLE__ [74/75/79]	\$ 1,629.	225
DC2040D6RMGRE__ [76/77]	\$ 1,949.	227	DC2430D6RMGLE__ [76/77]	\$ 1,849.	225
DC2430D4BMG__ [70/71]	\$ 949.	207	DC2430D6RMGRE__ [70/71]	\$ 1,529.	225
DC2430D4BMG__ [74/75/79]	\$ 1,079.	207	DC2430D6RMGRE__ [74/75/79]	\$ 1,629.	225
DC2430D4BMG__ [76/77]	\$ 1,279.	207	DC2430D6RMGRE__ [76/77]	\$ 1,849.	225
DC2430D4BMGLE__ [70/71]	\$ 1,249.	207	DC2440D4BMG__ [70/71]	\$ 1,179.	210
DC2430D4BMGLE__ [74/75/79]	\$ 1,349.	207	DC2440D4BMG__ [74/75/79]	\$ 1,279.	210
DC2430D4BMGLE__ [76/77]	\$ 1,579.	207	DC2440D4BMG__ [76/77]	\$ 1,499.	210
DC2430D4BMGRE__ [70/71]	\$ 1,249.	207	DC2440D4BMGLE__ [70/71]	\$ 1,479.	210
DC2430D4BMGRE__ [74/75/79]	\$ 1,349.	207	DC2440D4BMGLE__ [74/75/79]	\$ 1,579.	210
DC2430D4BMGRE__ [76/77]	\$ 1,579.	207	DC2440D4BMGLE__ [76/77]	\$ 1,799.	210
DC2430D4MEG__ [70/71]	\$ 949.	213	DC2440D4BMGRE__ [70/71]	\$ 1,479.	210
DC2430D4MEG__ [74/75/79]	\$ 1,079.	213	DC2440D4BMGRE__ [74/75/79]	\$ 1,579.	210
DC2430D4MEG__ [76/77]	\$ 1,279.	213	DC2440D4BMGRE__ [76/77]	\$ 1,799.	210
DC2430D4MEGLE__ [70/71]	\$ 1,249.	213	DC2440D4MEG__ [70/71]	\$ 1,179.	216
DC2430D4MEGLE__ [74/75/79]	\$ 1,349.	213	DC2440D4MEG__ [74/75/79]	\$ 1,279.	216
DC2430D4MEGLE__ [76/77]	\$ 1,579.	213	DC2440D4MEG__ [76/77]	\$ 1,499.	216
DC2430D4MEGRE__ [70/71]	\$ 1,249.	213	DC2440D4MEGLE__ [70/71]	\$ 1,479.	216
DC2430D4MEGRE__ [74/75/79]	\$ 1,349.	213	DC2440D4MEGLE__ [74/75/79]	\$ 1,579.	216
DC2430D4MEGRE__ [76/77]	\$ 1,579.	213	DC2440D4MEGLE__ [76/77]	\$ 1,799.	216
DC2430D4PVG__ [70/71]	\$ 949.	219	DC2440D4MEGRE__ [70/71]	\$ 1,479.	216
DC2430D4PVG__ [74/75/79]	\$ 1,079.	219	DC2440D4MEGRE__ [74/75/79]	\$ 1,579.	216
DC2430D4PVG__ [76/77]	\$ 1,279.	219	DC2440D4MEGRE__ [76/77]	\$ 1,799.	216
DC2430D4PVGLE__ [70/71]	\$ 1,249.	219	DC2440D4PVG__ [70/71]	\$ 1,179.	222
DC2430D4PVGLE__ [74/75/79]	\$ 1,349.	219	DC2440D4PVG__ [74/75/79]	\$ 1,279.	222
DC2430D4PVGLE__ [76/77]	\$ 1,579.	219	DC2440D4PVG__ [76/77]	\$ 1,499.	222
DC2430D4PVGRE__ [70/71]	\$ 1,249.	219	DC2440D4PVGLE__ [70/71]	\$ 1,479.	222
DC2430D4PVGRE__ [74/75/79]	\$ 1,349.	219	DC2440D4PVGLE__ [74/75/79]	\$ 1,579.	222
DC2430D4PVGRE__ [76/77]	\$ 1,579.	219	DC2440D4PVGLE__ [76/77]	\$ 1,799.	222
DC2430D4RMG__ [70/71]	\$ 949.	225	DC2440D4PVGRE__ [70/71]	\$ 1,479.	222
DC2430D4RMG__ [74/75/79]	\$ 1,079.	225	DC2440D4PVGRE__ [74/75/79]	\$ 1,579.	222
DC2430D4RMG__ [76/77]	\$ 1,279.	225	DC2440D4PVGRE__ [76/77]	\$ 1,799.	222
DC2430D4RMGLE__ [70/71]	\$ 1,249.	225	DC2440D4RMG__ [70/71]	\$ 1,179.	228
DC2430D4RMGLE__ [74/75/79]	\$ 1,349.	225	DC2440D4RMG__ [74/75/79]	\$ 1,279.	228
DC2430D4RMGLE__ [76/77]	\$ 1,579.	225	DC2440D4RMG__ [76/77]	\$ 1,499.	228
DC2430D4RMGRE__ [70/71]	\$ 1,249.	225	DC2440D4RMGLE__ [70/71]	\$ 1,479.	228
DC2430D4RMGRE__ [74/75/79]	\$ 1,349.	225	DC2440D4RMGLE__ [74/75/79]	\$ 1,579.	228
DC2430D4RMGRE__ [76/77]	\$ 1,579.	225	DC2440D4RMGLE__ [76/77]	\$ 1,799.	228
DC2430D6BMG__ [70/71]	\$ 1,229.	207	DC2440D4RMGRE__ [70/71]	\$ 1,479.	228
DC2430D6BMG__ [74/75/79]	\$ 1,329.	207	DC2440D4RMGRE__ [74/75/79]	\$ 1,579.	228
DC2430D6BMG__ [76/77]	\$ 1,549.	207	DC2440D4RMGRE__ [76/77]	\$ 1,799.	228
DC2430D6BMGLE__ [70/71]	\$ 1,529.	207	DC2440D6BMG__ [70/71]	\$ 1,449.	210
DC2430D6BMGLE__ [74/75/79]	\$ 1,629.	207	DC2440D6BMG__ [74/75/79]	\$ 1,549.	210
DC2430D6BMGLE__ [76/77]	\$ 1,849.	207	DC2440D6BMG__ [76/77]	\$ 1,749.	210
DC2430D6BMGRE__ [70/71]	\$ 1,529.	207	DC2440D6BMGLE__ [70/71]	\$ 1,749.	210
DC2430D6BMGRE__ [74/75/79]	\$ 1,629.	207	DC2440D6BMGLE__ [74/75/79]	\$ 1,849.	210
DC2430D6BMGRE__ [76/77]	\$ 1,849.	207	DC2440D6BMGLE__ [76/77]	\$ 2,079.	210
DC2430D6MEG__ [70/71]	\$ 1,229.	213	DC2440D6BMGRE__ [70/71]	\$ 1,749.	210
DC2430D6MEG__ [74/75/79]	\$ 1,329.	213	DC2440D6BMGRE__ [74/75/79]	\$ 1,849.	210
DC2430D6MEG__ [76/77]	\$ 1,549.	213	DC2440D6BMGRE__ [76/77]	\$ 2,079.	210

__ [] denotes Color/Pattern/Style options.

Model Number Price Index

Model Number	Price	Page	Model Number	Price	Page
DC2440D6MEG_[70/71]	\$ 1,449.	216	DM2040PV_[70/71]	\$ 879.	35
DC2440D6MEG_[74/75/79]	\$ 1,549.	216	DM2040PV_[74/75/79]	\$ 999.	35
DC2440D6MEG_[76/77]	\$ 1,749.	216	DM2040PV_[76/77]	\$ 1,229.	35
DC2440D6MEGLE_[70/71]	\$ 1,749.	216	DM2040RM_[70/71]	\$ 879.	35
DC2440D6MEGLE_[74/75/79]	\$ 1,849.	216	DM2040RM_[74/75/79]	\$ 999.	35
DC2440D6MEGLE_[76/77]	\$ 2,079.	216	DM2040RM_[76/77]	\$ 1,229.	35
DC2440D6MEGRE_[70/71]	\$ 1,749.	216	DM2430BM_[70/71]	\$ 779.	35
DC2440D6MEGRE_[74/75/79]	\$ 1,849.	216	DM2430BM_[74/75/79]	\$ 879.	35
DC2440D6MEGRE_[76/77]	\$ 2,079.	216	DM2430BM_[76/77]	\$ 1,099.	35
DC2440D6PVG_[70/71]	\$ 1,449.	222	DM2430ME_[70/71]	\$ 779.	35
DC2440D6PVG_[74/75/79]	\$ 1,549.	222	DM2430ME_[74/75/79]	\$ 879.	35
DC2440D6PVG_[76/77]	\$ 1,749.	222	DM2430ME_[76/77]	\$ 1,099.	35
DC2440D6PVGLE_[70/71]	\$ 1,749.	222	DM2430PV_[70/71]	\$ 779.	35
DC2440D6PVGLE_[74/75/79]	\$ 1,849.	222	DM2430PV_[74/75/79]	\$ 879.	35
DC2440D6PVGLE_[76/77]	\$ 2,079.	222	DM2430PV_[76/77]	\$ 1,099.	35
DC2440D6PVGRE_[70/71]	\$ 1,749.	222	DM2430RM_[70/71]	\$ 779.	35
DC2440D6PVGRE_[74/75/79]	\$ 1,849.	222	DM2430RM_[74/75/79]	\$ 879.	35
DC2440D6PVGRE_[76/77]	\$ 2,079.	222	DM2430RM_[76/77]	\$ 1,099.	35
DC2440D6RMG_[70/71]	\$ 1,449.	228	DM2440BM_[70/71]	\$ 999.	35
DC2440D6RMG_[74/75/79]	\$ 1,549.	228	DM2440BM_[74/75/79]	\$ 1,099.	35
DC2440D6RMG_[76/77]	\$ 1,749.	228	DM2440BM_[76/77]	\$ 1,329.	35
DC2440D6RMGLE_[70/71]	\$ 1,749.	228	DM2440ME_[70/71]	\$ 999.	35
DC2440D6RMGLE_[74/75/79]	\$ 1,849.	228	DM2440ME_[74/75/79]	\$ 1,099.	35
DC2440D6RMGLE_[76/77]	\$ 2,079.	228	DM2440ME_[76/77]	\$ 1,329.	35
DC2440D6RMGRE_[70/71]	\$ 1,749.	228	DM2440PV_[70/71]	\$ 999.	35
DC2440D6RMGRE_[74/75/79]	\$ 1,849.	228	DM2440PV_[74/75/79]	\$ 1,099.	35
DC2440D6RMGRE_[76/77]	\$ 2,079.	228	DM2440PV_[76/77]	\$ 1,329.	35
DLFML76	\$ 699.	259	DM2440RM_[70/71]	\$ 999.	35
DLFML77	\$ 699.	259	DM2440RM_[74/75/79]	\$ 1,099.	35
DM1630BM_[70/71]	\$ 549.	35	DM2440RM_[76/77]	\$ 1,329.	35
DM1630BM_[74/75/79]	\$ 679.	35	ENTICE	\$ 449.	272
DM1630BM_[76/77]	\$ 879.	35	ENTICEDOCK	\$ 499.	272
DM1630ME_[70/71]	\$ 549.	35	GLASSBIN3.25	\$ 49.	268, 272
DM1630ME_[74/75/79]	\$ 679.	35	GLASSBIN5.25	\$ 49.	268, 272
DM1630ME_[76/77]	\$ 879.	35	GLASSBIN6.38	\$ 49.	268
DM1630PV_[70/71]	\$ 549.	35	GLASSBIN8.5	\$ 49.	268, 272
DM1630PV_[74/75/79]	\$ 679.	35	LAVIUM-101	\$ 429.	135, 269
DM1630PV_[76/77]	\$ 879.	35	MA-TRAY2.5	\$ 29.	272
DM1630RM_[70/71]	\$ 549.	35	MA-TRAY3	\$ 29.	272
DM1630RM_[74/75/79]	\$ 679.	35	MA-TRAY5	\$ 29.	272
DM1630RM_[76/77]	\$ 879.	35	MBK16D4A	\$ 99.	275
DM1640BM_[70/71]	\$ 779.	35	MBK16D6A	\$ 99.	275
DM1640BM_[74/75/79]	\$ 879.	35	MBK16D6ASR	\$ 99.	275
DM1640BM_[76/77]	\$ 1,099.	35	MBK16D8A	\$ 99.	275
DM1640ME_[70/71]	\$ 779.	35	MBK16D8ASR	\$ 99.	275
DM1640ME_[74/75/79]	\$ 879.	35	MBK20D4A	\$ 99.	275
DM1640ME_[76/77]	\$ 1,099.	35	MBK20D6A	\$ 99.	275
DM1640PV_[70/71]	\$ 779.	35	MBK20D6ASR	\$ 99.	275
DM1640PV_[74/75/79]	\$ 879.	35	MBK20D8A	\$ 99.	275
DM1640PV_[76/77]	\$ 1,099.	35	MBK20D8ASR	\$ 99.	275
DM1640RM_[70/71]	\$ 779.	35	MBK24D4A	\$ 99.	275
DM1640RM_[74/75/79]	\$ 879.	35	MBK24D6A	\$ 99.	275
DM1640RM_[76/77]	\$ 1,099.	35	MBK24D6ASR	\$ 99.	275
DM2030BM_[70/71]	\$ 679.	35	MBK24D8A	\$ 99.	275
DM2030BM_[74/75/79]	\$ 779.	35	MBK24D8ASR	\$ 99.	275
DM2030BM_[76/77]	\$ 999.	35	MC1230D4_[11/20/21]L	\$ 979.	182
DM2030ME_[70/71]	\$ 679.	35	MC1230D4_[12/19/23/24/25]L	\$ 1,299.	182
DM2030ME_[74/75/79]	\$ 779.	35	MC1230D4_[22/26/27/28]L	\$ 1,149.	182
DM2030ME_[76/77]	\$ 999.	35	MC1230D4_[11/20/21]LE2	\$ 1,429.	182
DM2030PV_[70/71]	\$ 679.	35	MC1230D4_[12/19/23/24/25]LE2	\$ 1,749.	182
DM2030PV_[74/75/79]	\$ 779.	35	MC1230D4_[22/26/27/28]LE2	\$ 1,579.	182
DM2030PV_[76/77]	\$ 999.	35	MC1230D4_[FB/FP]L	\$ 829.	182
DM2030RM_[70/71]	\$ 679.	35	MC1230D4_[FB/FP]LE2	\$ 1,249.	182
DM2030RM_[74/75/79]	\$ 779.	35	MC1230D4_[11/20/21]R	\$ 979.	182
DM2030RM_[76/77]	\$ 999.	35	MC1230D4_[12/19/23/24/25]R	\$ 1,299.	182
DM2040BM_[70/71]	\$ 879.	35	MC1230D4_[22/26/27/28]R	\$ 1,149.	182
DM2040BM_[74/75/79]	\$ 999.	35	MC1230D4_[11/20/21]RE2	\$ 1,429.	182
DM2040BM_[76/77]	\$ 1,229.	35	MC1230D4_[12/19/23/24/25]RE2	\$ 1,749.	182
DM2040ME_[70/71]	\$ 879.	35	MC1230D4_[22/26/27/28]RE2	\$ 1,579.	182
DM2040ME_[74/75/79]	\$ 999.	35	MC1230D4_[FB/FP]R	\$ 829.	182
DM2040ME_[76/77]	\$ 1,229.	35	MC1230D4_[FB/FP]RE2	\$ 1,249.	182

[_] denotes Color/Pattern/Style options.

Model Number Price Index

Model Number	Price	Page	Model Number	Price	Page
MC1230D6__ [11/20/21] L	\$ 1,249.	182	MC1630D4__ [FB/FP] R	\$ 929.	184
MC1230D6__ [12/19/23/24/25] L	\$ 1,579.	182	MC1630D4__ [FB/FP] RE2	\$ 1,379.	184
MC1230D6__ [22/26/27/28] L	\$ 1,429.	182	MC1630D4__ [FB/FP] RE4	\$ 1,699.	184
MC1230D6__ [11/20/21] LE2	\$ 1,699.	182	MC1630D6__ [11/20/21] L	\$ 1,429.	184
MC1230D6__ [12/19/23/24/25] LE2	\$ 2,029.	182	MC1630D6__ [12/19/23/24/25] L	\$ 1,849.	184
MC1230D6__ [22/26/27/28] LE2	\$ 1,849.	182	MC1630D6__ [22/26/27/28] L	\$ 1,649.	184
MC1230D6__ [FB/FP] L	\$ 1,099.	182	MC1630D6__ [11/20/21] LE2	\$ 1,849.	184
MC1230D6__ [FB/FP] LE2	\$ 1,529.	182	MC1630D6__ [12/19/23/24/25] LE2	\$ 2,299.	184
MC1230D6__ [11/20/21] R	\$ 1,249.	182	MC1630D6__ [22/26/27/28] LE2	\$ 2,079.	184
MC1230D6__ [12/19/23/24/25] R	\$ 1,579.	182	MC1630D6__ [AB] L	\$ 1,479.	184
MC1230D6__ [22/26/27/28] R	\$ 1,429.	182	MC1630D6__ [AB] LE2	\$ 1,929.	184
MC1230D6__ [11/20/21] RE2	\$ 1,699.	182	MC1630D6__ [AB] LE4	\$ 2,249.	184
MC1230D6__ [12/19/23/24/25] RE2	\$ 2,029.	182	MC1630D6__ [FB/FP] L	\$ 1,199.	184
MC1230D6__ [22/26/27/28] RE2	\$ 1,849.	182	MC1630D6__ [FB/FP] LE2	\$ 1,649.	184
MC1230D6__ [FB/FP] R	\$ 1,099.	182	MC1630D6__ [FB/FP] LE4	\$ 1,979.	184
MC1230D6__ [FB/FP] RE2	\$ 1,529.	182	MC1630D6__ [11/20/21] R	\$ 1,429.	184
MC1240D4__ [11/20/21] L	\$ 1,379.	190	MC1630D6__ [12/19/23/24/25] R	\$ 1,849.	184
MC1240D4__ [12/19/23/24/25] L	\$ 1,799.	190	MC1630D6__ [22/26/27/28] R	\$ 1,649.	184
MC1240D4__ [22/26/27/28] L	\$ 1,579.	190	MC1630D6__ [11/20/21] RE2	\$ 1,849.	184
MC1240D4__ [11/20/21] LE2	\$ 1,799.	190	MC1630D6__ [12/19/23/24/25] RE2	\$ 2,299.	184
MC1240D4__ [12/19/23/24/25] LE2	\$ 2,249.	190	MC1630D6__ [22/26/27/28] RE2	\$ 2,079.	184
MC1240D4__ [22/26/27/28] LE2	\$ 2,029.	190	MC1630D6__ [AB] R	\$ 1,479.	184
MC1240D4__ [FB/FP] L	\$ 1,149.	190	MC1630D6__ [AB] RE2	\$ 1,929.	184
MC1240D4__ [FB/FP] LE2	\$ 1,579.	190	MC1630D6__ [AB] RE4	\$ 2,249.	184
MC1240D4__ [11/20/21] R	\$ 1,379.	190	MC1630D6__ [FB/FP] R	\$ 1,199.	184
MC1240D4__ [12/19/23/24/25] R	\$ 1,799.	190	MC1630D6__ [FB/FP] RE2	\$ 1,649.	184
MC1240D4__ [22/26/27/28] R	\$ 1,579.	190	MC1630D6__ [FB/FP] RE4	\$ 1,979.	184
MC1240D4__ [11/20/21] RE2	\$ 1,799.	190	MC1630D8__ [11/20/21] L	\$ 1,529.	184
MC1240D4__ [12/19/23/24/25] RE2	\$ 2,249.	190	MC1630D8__ [12/19/23/24/25] L	\$ 1,979.	184
MC1240D4__ [22/26/27/28] RE2	\$ 2,029.	190	MC1630D8__ [22/26/27/28] L	\$ 1,749.	184
MC1240D4__ [FB/FP] R	\$ 1,149.	190	MC1630D8__ [11/20/21] LE2	\$ 1,979.	184
MC1240D4__ [FB/FP] RE2	\$ 1,579.	190	MC1630D8__ [12/19/23/24/25] LE2	\$ 2,399.	184
MC1240D6__ [11/20/21] L	\$ 1,649.	190	MC1630D8__ [22/26/27/28] LE2	\$ 2,199.	184
MC1240D6__ [12/19/23/24/25] L	\$ 2,079.	190	MC1630D8__ [AB] L	\$ 1,579.	184
MC1240D6__ [22/26/27/28] L	\$ 1,849.	190	MC1630D8__ [AB] LE2	\$ 2,029.	184
MC1240D6__ [11/20/21] LE2	\$ 2,079.	190	MC1630D8__ [AB] LE4	\$ 2,349.	184
MC1240D6__ [12/19/23/24/25] LE2	\$ 2,529.	190	MC1630D8__ [FB/FP] L	\$ 1,299.	184
MC1240D6__ [22/26/27/28] LE2	\$ 2,299.	190	MC1630D8__ [FB/FP] LE2	\$ 1,749.	184
MC1240D6__ [FB/FP] L	\$ 1,429.	190	MC1630D8__ [FB/FP] LE4	\$ 2,079.	184
MC1240D6__ [FB/FP] LE2	\$ 1,849.	190	MC1630D8__ [11/20/21] R	\$ 1,529.	184
MC1240D6__ [11/20/21] R	\$ 1,649.	190	MC1630D8__ [12/19/23/24/25] R	\$ 1,979.	184
MC1240D6__ [12/19/23/24/25] R	\$ 2,079.	190	MC1630D8__ [22/26/27/28] R	\$ 1,749.	184
MC1240D6__ [22/26/27/28] R	\$ 1,849.	190	MC1630D8__ [11/20/21] RE2	\$ 1,979.	184
MC1240D6__ [11/20/21] RE2	\$ 2,079.	190	MC1630D8__ [12/19/23/24/25] RE2	\$ 2,399.	184
MC1240D6__ [12/19/23/24/25] RE2	\$ 2,529.	190	MC1630D8__ [22/26/27/28] RE2	\$ 2,199.	184
MC1240D6__ [22/26/27/28] RE2	\$ 2,299.	190	MC1630D8__ [AB] R	\$ 1,579.	184
MC1240D6__ [FB/FP] R	\$ 1,429.	190	MC1630D8__ [AB] RE2	\$ 2,029.	184
MC1240D6__ [FB/FP] RE2	\$ 1,849.	190	MC1630D8__ [AB] RE4	\$ 2,349.	184
MC1630D4__ [11/20/21] L	\$ 1,149.	184	MC1630D8__ [FB/FP] R	\$ 1,299.	184
MC1630D4__ [12/19/23/24/25] L	\$ 1,579.	184	MC1630D8__ [FB/FP] RE2	\$ 1,749.	184
MC1630D4__ [22/26/27/28] L	\$ 1,379.	184	MC1630D8__ [FB/FP] RE4	\$ 2,079.	184
MC1630D4__ [11/20/21] LE2	\$ 1,579.	184	MC1640D4__ [11/20/21] L	\$ 1,529.	192
MC1630D4__ [12/19/23/24/25] LE2	\$ 2,029.	184	MC1640D4__ [12/19/23/24/25] L	\$ 2,079.	192
MC1630D4__ [22/26/27/28] LE2	\$ 1,799.	184	MC1640D4__ [22/26/27/28] L	\$ 1,799.	192
MC1630D4__ [AB] L	\$ 1,199.	184	MC1640D4__ [11/20/21] LE2	\$ 1,979.	192
MC1630D4__ [AB] LE2	\$ 1,649.	184	MC1640D4__ [12/19/23/24/25] LE2	\$ 2,529.	192
MC1630D4__ [AB] LE4	\$ 1,979.	184	MC1640D4__ [22/26/27/28] LE2	\$ 2,249.	192
MC1630D4__ [FB/FP] L	\$ 929.	184	MC1640D4__ [AB] L	\$ 1,529.	192
MC1630D4__ [FB/FP] LE2	\$ 1,379.	184	MC1640D4__ [AB] LE2	\$ 1,979.	192
MC1630D4__ [FB/FP] LE4	\$ 1,699.	184	MC1640D4__ [AB] LE4	\$ 2,299.	192
MC1630D4__ [11/20/21] R	\$ 1,149.	184	MC1640D4__ [FB/FP] L	\$ 1,249.	192
MC1630D4__ [12/19/23/24/25] R	\$ 1,579.	184	MC1640D4__ [FB/FP] LE2	\$ 1,699.	192
MC1630D4__ [22/26/27/28] R	\$ 1,379.	184	MC1640D4__ [FB/FP] LE4	\$ 2,029.	192
MC1630D4__ [11/20/21] RE2	\$ 1,579.	184	MC1640D4__ [11/20/21] R	\$ 1,529.	192
MC1630D4__ [12/19/23/24/25] RE2	\$ 2,029.	184	MC1640D4__ [12/19/23/24/25] R	\$ 2,079.	192
MC1630D4__ [22/26/27/28] RE2	\$ 1,799.	184	MC1640D4__ [22/26/27/28] R	\$ 1,799.	192
MC1630D4__ [AB] R	\$ 1,199.	184	MC1640D4__ [11/20/21] RE2	\$ 1,979.	192
MC1630D4__ [AB] RE2	\$ 1,649.	184	MC1640D4__ [12/19/23/24/25] RE2	\$ 2,529.	192
MC1630D4__ [AB] RE4	\$ 1,979.	184	MC1640D4__ [22/26/27/28] RE2	\$ 2,249.	192

__ [] denotes Color/Pattern/Style options.

Model Number Price Index

Model Number	Price	Page	Model Number	Price	Page
MC1640D4__[AB]R	\$ 1,529.	192	MC1670D6__[11/20/21]L	\$ 3,229.	198
MC1640D4__[AB]RE2	\$ 1,979.	192	MC1670D6__[12/19/23/24/25]L	\$ 4,229.	198
MC1640D4__[AB]RE4	\$ 2,299.	192	MC1670D6__[22/26/27/28]L	\$ 3,729.	198
MC1640D4__[FB/FP]R	\$ 1,249.	192	MC1670D6__[11/20/21]LE2	\$ 3,679.	198
MC1640D4__[FB/FP]RE2	\$ 1,699.	192	MC1670D6__[12/19/23/24/25]LE2	\$ 4,649.	198
MC1640D4__[FB/FP]RE4	\$ 2,029.	192	MC1670D6__[22/26/27/28]LE2	\$ 4,149.	198
MC1640D6__[11/20/21]L	\$ 1,799.	192	MC1670D6__[FB/FP]L	\$ 2,729.	198
MC1640D6__[12/19/23/24/25]L	\$ 2,349.	192	MC1670D6__[FB/FP]LE2	\$ 3,179.	198
MC1640D6__[22/26/27/28]L	\$ 2,079.	192	MC1670D6__[11/20/21]R	\$ 3,229.	198
MC1640D6__[11/20/21]LE2	\$ 2,249.	192	MC1670D6__[12/19/23/24/25]R	\$ 4,229.	198
MC1640D6__[12/19/23/24/25]LE2	\$ 2,799.	192	MC1670D6__[22/26/27/28]R	\$ 3,729.	198
MC1640D6__[22/26/27/28]LE2	\$ 2,529.	192	MC1670D6__[11/20/21]RE2	\$ 3,679.	198
MC1640D6__[AB]L	\$ 1,799.	192	MC1670D6__[12/19/23/24/25]RE2	\$ 4,649.	198
MC1640D6__[AB]LE2	\$ 2,249.	192	MC1670D6__[22/26/27/28]RE2	\$ 4,149.	198
MC1640D6__[AB]LE4	\$ 2,579.	192	MC1670D6__[FB/FP]R	\$ 2,729.	198
MC1640D6__[FB/FP]L	\$ 1,529.	192	MC1670D6__[FB/FP]RE2	\$ 3,179.	198
MC1640D6__[FB/FP]LE2	\$ 1,979.	192	MC1670D8__[11/20/21]L	\$ 3,349.	198
MC1640D6__[FB/FP]LE4	\$ 2,299.	192	MC1670D8__[12/19/23/24/25]L	\$ 4,329.	198
MC1640D6__[11/20/21]R	\$ 1,799.	192	MC1670D8__[22/26/27/28]L	\$ 3,829.	198
MC1640D6__[12/19/23/24/25]R	\$ 2,349.	192	MC1670D8__[11/20/21]LE2	\$ 3,779.	198
MC1640D6__[22/26/27/28]R	\$ 2,079.	192	MC1670D8__[12/19/23/24/25]LE2	\$ 4,749.	198
MC1640D6__[11/20/21]RE2	\$ 2,249.	192	MC1670D8__[22/26/27/28]LE2	\$ 4,279.	198
MC1640D6__[12/19/23/24/25]RE2	\$ 2,799.	192	MC1670D8__[FB/FP]L	\$ 2,849.	198
MC1640D6__[22/26/27/28]RE2	\$ 2,529.	192	MC1670D8__[FB/FP]LE2	\$ 3,279.	198
MC1640D6__[AB]R	\$ 1,799.	192	MC1670D8__[11/20/21]R	\$ 3,349.	198
MC1640D6__[AB]RE2	\$ 2,249.	192	MC1670D8__[12/19/23/24/25]R	\$ 4,329.	198
MC1640D6__[AB]RE4	\$ 2,579.	192	MC1670D8__[22/26/27/28]R	\$ 3,829.	198
MC1640D6__[FB/FP]R	\$ 1,529.	192	MC1670D8__[11/20/21]RE2	\$ 3,779.	198
MC1640D6__[FB/FP]RE2	\$ 1,979.	192	MC1670D8__[12/19/23/24/25]RE2	\$ 4,749.	198
MC1640D6__[FB/FP]RE4	\$ 2,299.	192	MC1670D8__[22/26/27/28]RE2	\$ 4,279.	198
MC1640D8__[11/20/21]L	\$ 1,929.	192	MC1670D8__[FB/FP]R	\$ 2,849.	198
MC1640D8__[12/19/23/24/25]L	\$ 2,449.	192	MC1670D8__[FB/FP]RE2	\$ 3,279.	198
MC1640D8__[22/26/27/28]L	\$ 2,199.	192	MC2030D4__[11/20/21]L	\$ 1,379.	186
MC1640D8__[11/20/21]LE2	\$ 2,349.	192	MC2030D4__[12/19/23/24/25]L	\$ 1,929.	186
MC1640D8__[12/19/23/24/25]LE2	\$ 2,899.	192	MC2030D4__[22/26/27/28]L	\$ 1,649.	186
MC1640D8__[22/26/27/28]LE2	\$ 2,629.	192	MC2030D4__[11/20/21]LE2	\$ 1,799.	186
MC1640D8__[AB]L	\$ 1,929.	192	MC2030D4__[12/19/23/24/25]LE2	\$ 2,349.	186
MC1640D8__[AB]LE2	\$ 2,349.	192	MC2030D4__[22/26/27/28]LE2	\$ 2,079.	186
MC1640D8__[AB]LE4	\$ 2,679.	192	MC2030D4__[AB]L	\$ 1,379.	186
MC1640D8__[FB/FP]L	\$ 1,649.	192	MC2030D4__[AB]LE2	\$ 1,799.	186
MC1640D8__[FB/FP]LE2	\$ 2,079.	192	MC2030D4__[AB]LE4	\$ 2,129.	186
MC1640D8__[FB/FP]LE4	\$ 2,399.	192	MC2030D4__[FB/FP]L	\$ 1,099.	186
MC1640D8__[11/20/21]R	\$ 1,929.	192	MC2030D4__[FB/FP]LE2	\$ 1,529.	186
MC1640D8__[12/19/23/24/25]R	\$ 2,449.	192	MC2030D4__[FB/FP]LE4	\$ 1,849.	186
MC1640D8__[22/26/27/28]R	\$ 2,199.	192	MC2030D4__[11/20/21]R	\$ 1,379.	186
MC1640D8__[11/20/21]RE2	\$ 2,349.	192	MC2030D4__[12/19/23/24/25]R	\$ 1,929.	186
MC1640D8__[12/19/23/24/25]RE2	\$ 2,899.	192	MC2030D4__[22/26/27/28]R	\$ 1,649.	186
MC1640D8__[22/26/27/28]RE2	\$ 2,629.	192	MC2030D4__[11/20/21]RE2	\$ 1,799.	186
MC1640D8__[AB]R	\$ 1,929.	192	MC2030D4__[12/19/23/24/25]RE2	\$ 2,349.	186
MC1640D8__[AB]RE2	\$ 2,349.	192	MC2030D4__[22/26/27/28]RE2	\$ 2,079.	186
MC1640D8__[AB]RE4	\$ 2,679.	192	MC2030D4__[AB]R	\$ 1,379.	186
MC1640D8__[FB/FP]R	\$ 1,649.	192	MC2030D4__[AB]RE2	\$ 1,799.	186
MC1640D8__[FB/FP]RE2	\$ 2,079.	192	MC2030D4__[AB]RE4	\$ 2,129.	186
MC1640D8__[FB/FP]RE4	\$ 2,399.	192	MC2030D4__[FB/FP]R	\$ 1,099.	186
MC1670D4__[11/20/21]L	\$ 2,949.	198	MC2030D4__[FB/FP]RE2	\$ 1,529.	186
MC1670D4__[12/19/23/24/25]L	\$ 3,949.	198	MC2030D4__[FB/FP]RE4	\$ 1,849.	186
MC1670D4__[22/26/27/28]L	\$ 3,449.	198	MC2030D6__[11/20/21]L	\$ 1,649.	186
MC1670D4__[11/20/21]LE2	\$ 3,399.	198	MC2030D6__[12/19/23/24/25]L	\$ 2,199.	186
MC1670D4__[12/19/23/24/25]LE2	\$ 4,379.	198	MC2030D6__[22/26/27/28]L	\$ 1,929.	186
MC1670D4__[22/26/27/28]LE2	\$ 3,879.	198	MC2030D6__[11/20/21]LE2	\$ 2,079.	186
MC1670D4__[FB/FP]L	\$ 2,449.	198	MC2030D6__[12/19/23/24/25]LE2	\$ 2,629.	186
MC1670D4__[FB/FP]LE2	\$ 2,899.	198	MC2030D6__[22/26/27/28]LE2	\$ 2,349.	186
MC1670D4__[11/20/21]R	\$ 2,949.	198	MC2030D6__[AB]L	\$ 1,649.	186
MC1670D4__[12/19/23/24/25]R	\$ 3,949.	198	MC2030D6__[AB]LE2	\$ 2,079.	186
MC1670D4__[22/26/27/28]R	\$ 3,449.	198	MC2030D6__[AB]LE4	\$ 2,399.	186
MC1670D4__[11/20/21]RE2	\$ 3,399.	198	MC2030D6__[FB/FP]L	\$ 1,379.	186
MC1670D4__[12/19/23/24/25]RE2	\$ 4,379.	198	MC2030D6__[FB/FP]LE2	\$ 1,799.	186
MC1670D4__[22/26/27/28]RE2	\$ 3,879.	198	MC2030D6__[FB/FP]LE4	\$ 2,129.	186
MC1670D4__[FB/FP]R	\$ 2,449.	198	MC2030D6__[11/20/21]R	\$ 1,649.	186
MC1670D4__[FB/FP]RE2	\$ 2,899.	198	MC2030D6__[12/19/23/24/25]R	\$ 2,199.	186
			MC2030D6__[22/26/27/28]R	\$ 1,929.	186

__[] denotes Color/Pattern/Style options.

Model Number Price Index

Model Number	Price	Page	Model Number	Price	Page
MC2030D6__ [11/20/21] RE2	\$ 2,079.	186	MC2040D6__ [11/20/21] R	\$ 1,979.	194
MC2030D6__ [12/19/23/24/25] RE2	\$ 2,629.	186	MC2040D6__ [12/19/23/24/25] R	\$ 2,629.	194
MC2030D6__ [22/26/27/28] RE2	\$ 2,349.	186	MC2040D6__ [22/26/27/28] R	\$ 2,299.	194
MC2030D6__ [AB] R	\$ 1,649.	186	MC2040D6__ [11/20/21] RE2	\$ 2,399.	194
MC2030D6__ [AB] RE2	\$ 2,079.	186	MC2040D6__ [12/19/23/24/25] RE2	\$ 3,079.	194
MC2030D6__ [AB] RE4	\$ 2,399.	186	MC2040D6__ [22/26/27/28] RE2	\$ 2,729.	194
MC2030D6__ [FB/FP] R	\$ 1,379.	186	MC2040D6__ [AB] R	\$ 1,929.	194
MC2030D6__ [FB/FP] RE2	\$ 1,799.	186	MC2040D6__ [AB] RE2	\$ 2,349.	194
MC2030D6__ [FB/FP] RE4	\$ 2,129.	186	MC2040D6__ [AB] RE4	\$ 2,679.	194
MC2030D8__ [11/20/21] L	\$ 1,749.	186	MC2040D6__ [FB/FP] R	\$ 1,649.	194
MC2030D8__ [12/19/23/24/25] L	\$ 2,299.	186	MC2040D6__ [FB/FP] RE2	\$ 2,079.	194
MC2030D8__ [22/26/27/28] L	\$ 2,029.	186	MC2040D6__ [FB/FP] RE4	\$ 2,399.	194
MC2030D8__ [11/20/21] LE2	\$ 2,199.	186	MC2040D8__ [11/20/21] L	\$ 2,079.	194
MC2030D8__ [12/19/23/24/25] LE2	\$ 2,729.	186	MC2040D8__ [12/19/23/24/25] L	\$ 2,729.	194
MC2030D8__ [22/26/27/28] LE2	\$ 2,449.	186	MC2040D8__ [22/26/27/28] L	\$ 2,399.	194
MC2030D8__ [AB] L	\$ 1,749.	186	MC2040D8__ [11/20/21] LE2	\$ 2,529.	194
MC2030D8__ [AB] LE2	\$ 2,199.	186	MC2040D8__ [12/19/23/24/25] LE2	\$ 3,179.	194
MC2030D8__ [AB] LE4	\$ 2,529.	186	MC2040D8__ [22/26/27/28] LE2	\$ 2,849.	194
MC2030D8__ [FB/FP] L	\$ 1,479.	186	MC2040D8__ [AB] L	\$ 2,029.	194
MC2030D8__ [FB/FP] LE2	\$ 1,929.	186	MC2040D8__ [AB] LE2	\$ 2,449.	194
MC2030D8__ [FB/FP] LE4	\$ 2,249.	186	MC2040D8__ [AB] LE4	\$ 2,799.	194
MC2030D8__ [11/20/21] R	\$ 1,749.	186	MC2040D8__ [FB/FP] L	\$ 1,749.	194
MC2030D8__ [12/19/23/24/25] R	\$ 2,299.	186	MC2040D8__ [FB/FP] LE2	\$ 2,199.	194
MC2030D8__ [22/26/27/28] R	\$ 2,029.	186	MC2040D8__ [FB/FP] LE4	\$ 2,529.	194
MC2030D8__ [11/20/21] RE2	\$ 2,199.	186	MC2040D8__ [11/20/21] R	\$ 2,079.	194
MC2030D8__ [12/19/23/24/25] RE2	\$ 2,729.	186	MC2040D8__ [12/19/23/24/25] R	\$ 2,729.	194
MC2030D8__ [22/26/27/28] RE2	\$ 2,449.	186	MC2040D8__ [22/26/27/28] R	\$ 2,399.	194
MC2030D8__ [AB] R	\$ 1,749.	186	MC2040D8__ [11/20/21] RE2	\$ 2,529.	194
MC2030D8__ [AB] RE2	\$ 2,199.	186	MC2040D8__ [12/19/23/24/25] RE2	\$ 3,179.	194
MC2030D8__ [AB] RE4	\$ 2,529.	186	MC2040D8__ [22/26/27/28] RE2	\$ 2,849.	194
MC2030D8__ [FB/FP] R	\$ 1,479.	186	MC2040D8__ [AB] R	\$ 2,029.	194
MC2030D8__ [FB/FP] RE2	\$ 1,929.	186	MC2040D8__ [AB] RE2	\$ 2,449.	194
MC2030D8__ [FB/FP] RE4	\$ 2,249.	186	MC2040D8__ [AB] RE4	\$ 2,799.	194
MC2040D4__ [11/20/21] L	\$ 1,699.	194	MC2040D8__ [FB/FP] L	\$ 1,749.	194
MC2040D4__ [12/19/23/24/25] L	\$ 2,349.	194	MC2040D8__ [FB/FP] LE2	\$ 2,199.	194
MC2040D4__ [22/26/27/28] L	\$ 2,029.	194	MC2040D8__ [FB/FP] LE4	\$ 2,529.	194
MC2040D4__ [11/20/21] LE2	\$ 2,129.	194	MC2040D8__ [11/20/21] R	\$ 2,079.	194
MC2040D4__ [12/19/23/24/25] LE2	\$ 2,799.	194	MC2040D8__ [12/19/23/24/25] R	\$ 2,729.	194
MC2040D4__ [22/26/27/28] LE2	\$ 2,449.	194	MC2040D8__ [22/26/27/28] R	\$ 2,399.	194
MC2040D4__ [AB] L	\$ 1,649.	194	MC2040D8__ [11/20/21] RE2	\$ 2,529.	194
MC2040D4__ [AB] LE2	\$ 2,079.	194	MC2040D8__ [12/19/23/24/25] RE2	\$ 3,179.	194
MC2040D4__ [AB] LE4	\$ 2,399.	194	MC2040D8__ [22/26/27/28] RE2	\$ 2,849.	194
MC2040D4__ [FB/FP] L	\$ 1,379.	194	MC2040D8__ [AB] R	\$ 2,029.	194
MC2040D4__ [FB/FP] LE2	\$ 1,799.	194	MC2040D8__ [AB] RE2	\$ 2,449.	194
MC2040D4__ [FB/FP] LE4	\$ 2,129.	194	MC2040D8__ [AB] RE4	\$ 2,799.	194
MC2040D4__ [11/20/21] R	\$ 1,699.	194	MC2040D8__ [FB/FP] R	\$ 1,749.	194
MC2040D4__ [12/19/23/24/25] R	\$ 2,349.	194	MC2040D8__ [FB/FP] RE2	\$ 2,199.	194
MC2040D4__ [22/26/27/28] R	\$ 2,029.	194	MC2040D8__ [FB/FP] RE4	\$ 2,529.	194
MC2040D4__ [11/20/21] RE2	\$ 2,129.	194	MC2070D4__ [11/20/21] L	\$ 3,279.	200
MC2040D4__ [12/19/23/24/25] RE2	\$ 2,799.	194	MC2070D4__ [12/19/23/24/25] L	\$ 4,379.	200
MC2040D4__ [22/26/27/28] RE2	\$ 2,449.	194	MC2070D4__ [22/26/27/28] L	\$ 3,829.	200
MC2040D4__ [AB] R	\$ 1,649.	194	MC2070D4__ [11/20/21] LE2	\$ 3,729.	200
MC2040D4__ [AB] RE2	\$ 2,079.	194	MC2070D4__ [12/19/23/24/25] LE2	\$ 4,829.	200
MC2040D4__ [AB] RE4	\$ 2,399.	194	MC2070D4__ [22/26/27/28] LE2	\$ 4,279.	200
MC2040D4__ [FB/FP] R	\$ 1,379.	194	MC2070D4__ [FB/FP] L	\$ 2,729.	200
MC2040D4__ [FB/FP] RE2	\$ 1,799.	194	MC2070D4__ [FB/FP] LE2	\$ 3,179.	200
MC2040D4__ [FB/FP] RE4	\$ 2,129.	194	MC2070D4__ [11/20/21] R	\$ 3,279.	200
MC2040D6__ [11/20/21] L	\$ 1,979.	194	MC2070D4__ [12/19/23/24/25] R	\$ 4,379.	200
MC2040D6__ [12/19/23/24/25] L	\$ 2,629.	194	MC2070D4__ [22/26/27/28] R	\$ 3,829.	200
MC2040D6__ [22/26/27/28] L	\$ 2,299.	194	MC2070D4__ [11/20/21] RE2	\$ 3,729.	200
MC2040D6__ [11/20/21] LE2	\$ 2,399.	194	MC2070D4__ [12/19/23/24/25] RE2	\$ 4,829.	200
MC2040D6__ [12/19/23/24/25] LE2	\$ 3,079.	194	MC2070D4__ [22/26/27/28] RE2	\$ 4,279.	200
MC2040D6__ [22/26/27/28] LE2	\$ 2,729.	194	MC2070D4__ [FB/FP] R	\$ 2,729.	200
MC2040D6__ [AB] L	\$ 1,929.	194	MC2070D4__ [FB/FP] RE2	\$ 3,179.	200
MC2040D6__ [AB] LE2	\$ 2,349.	194	MC2070D6__ [11/20/21] L	\$ 3,549.	200
MC2040D6__ [AB] LE4	\$ 2,679.	194	MC2070D6__ [12/19/23/24/25] L	\$ 4,649.	200
MC2040D6__ [FB/FP] L	\$ 1,649.	194	MC2070D6__ [22/26/27/28] L	\$ 4,099.	200
MC2040D6__ [FB/FP] LE2	\$ 2,079.	194	MC2070D6__ [11/20/21] LE2	\$ 3,999.	200
MC2040D6__ [FB/FP] LE4	\$ 2,129.	194	MC2070D6__ [12/19/23/24/25] LE2	\$ 5,099.	200
MC2040D6__ [11/20/21] RE2	\$ 2,399.	194	MC2070D6__ [22/26/27/28] LE2	\$ 4,549.	200
MC2040D6__ [12/19/23/24/25] RE2	\$ 3,079.	194	MC2070D6__ [FB/FP] L	\$ 2,999.	200
MC2040D6__ [22/26/27/28] RE2	\$ 2,729.	194	MC2070D6__ [FB/FP] LE2	\$ 3,449.	200
MC2040D6__ [AB] R	\$ 1,929.	194	MC2070D6__ [11/20/21] R	\$ 3,549.	200
MC2040D6__ [AB] LE2	\$ 2,349.	194	MC2070D6__ [12/19/23/24/25] R	\$ 4,649.	200
MC2040D6__ [AB] LE4	\$ 2,679.	194	MC2070D6__ [22/26/27/28] R	\$ 4,099.	200
MC2040D6__ [FB/FP] L	\$ 1,649.	194	MC2070D6__ [11/20/21] RE2	\$ 3,999.	200
MC2040D6__ [FB/FP] LE2	\$ 2,079.	194	MC2070D6__ [12/19/23/24/25] RE2	\$ 5,099.	200
MC2040D6__ [FB/FP] LE4	\$ 2,129.	194	MC2070D6__ [22/26/27/28] RE2	\$ 4,549.	200
MC2040D8__ [11/20/21] L	\$ 2,079.	194	MC2070D6__ [FB/FP] R	\$ 2,999.	200
MC2040D8__ [12/19/23/24/25] L	\$ 2,729.	194	MC2070D6__ [FB/FP] RE2	\$ 3,449.	200
MC2040D8__ [22/26/27/28] L	\$ 2,399.	194	MC2070D8__ [11/20/21] L	\$ 3,679.	200
MC2040D8__ [11/20/21] LE2	\$ 2,529.	194	MC2070D8__ [12/19/23/24/25] L	\$ 4,749.	200
MC2040D8__ [12/19/23/24/25] LE2	\$ 3,179.	194	MC2070D8__ [22/26/27/28] L	\$ 4,229.	200
MC2040D8__ [22/26/27/28] LE2	\$ 2,849.	194			

__ [] denotes Color/Pattern/Style options.

Model Number Price Index

Model Number	Price	Page
MC2070D8__ [11/20/21] LE2	\$ 4,099.	200
MC2070D8__ [12/19/23/24/25] LE2	\$ 5,199.	200
MC2070D8__ [22/26/27/28] LE2	\$ 4,649.	200
MC2070D8__ [FB/FP] L	\$ 3,129.	200
MC2070D8__ [FB/FP] LE2	\$ 3,549.	200
MC2070D8__ [11/20/21] R	\$ 3,679.	200
MC2070D8__ [12/19/23/24/25] R	\$ 4,749.	200
MC2070D8__ [22/26/27/28] R	\$ 4,229.	200
MC2070D8__ [11/20/21] RE2	\$ 4,099.	200
MC2070D8__ [12/19/23/24/25] RE2	\$ 5,199.	200
MC2070D8__ [22/26/27/28] RE2	\$ 4,649.	200
MC2070D8__ [FB/FP] R	\$ 3,129.	200
MC2070D8__ [FB/FP] RE2	\$ 3,549.	200
MC2430D4__ [11/20/21] L	\$ 1,429.	188
MC2430D4__ [12/19/23/24/25] L	\$ 1,979.	188
MC2430D4__ [22/26/27/28] L	\$ 1,699.	188
MC2430D4__ [11/20/21] LE2	\$ 1,849.	188
MC2430D4__ [12/19/23/24/25] LE2	\$ 2,399.	188
MC2430D4__ [22/26/27/28] LE2	\$ 2,129.	188
MC2430D4__ [AB] L	\$ 1,429.	188
MC2430D4__ [AB] LE2	\$ 1,849.	188
MC2430D4__ [AB] LE4	\$ 2,199.	188
MC2430D4__ [FB/FP] L	\$ 1,149.	188
MC2430D4__ [FB/FP] LE2	\$ 1,579.	188
MC2430D4__ [FB/FP] LE4	\$ 1,929.	188
MC2430D4__ [11/20/21] R	\$ 1,429.	188
MC2430D4__ [12/19/23/24/25] R	\$ 1,979.	188
MC2430D4__ [22/26/27/28] R	\$ 1,699.	188
MC2430D4__ [11/20/21] RE2	\$ 1,849.	188
MC2430D4__ [12/19/23/24/25] RE2	\$ 2,399.	188
MC2430D4__ [22/26/27/28] RE2	\$ 2,129.	188
MC2430D4__ [AB] R	\$ 1,429.	188
MC2430D4__ [AB] RE2	\$ 1,849.	188
MC2430D4__ [AB] RE4	\$ 2,199.	188
MC2430D4__ [FB/FP] R	\$ 1,149.	188
MC2430D4__ [FB/FP] RE2	\$ 1,579.	188
MC2430D4__ [FB/FP] RE4	\$ 1,929.	188
MC2430D6__ [11/20/21] L	\$ 1,699.	188
MC2430D6__ [12/19/23/24/25] L	\$ 2,249.	188
MC2430D6__ [22/26/27/28] L	\$ 1,979.	188
MC2430D6__ [11/20/21] LE2	\$ 2,129.	188
MC2430D6__ [12/19/23/24/25] LE2	\$ 2,679.	188
MC2430D6__ [22/26/27/28] LE2	\$ 2,399.	188
MC2430D6__ [AB] L	\$ 1,699.	188
MC2430D6__ [AB] LE2	\$ 2,129.	188
MC2430D6__ [AB] LE4	\$ 2,449.	188
MC2430D6__ [FB/FP] L	\$ 1,429.	188
MC2430D6__ [FB/FP] LE2	\$ 1,849.	188
MC2430D6__ [FB/FP] LE4	\$ 2,199.	188
MC2430D6__ [11/20/21] R	\$ 1,699.	188
MC2430D6__ [12/19/23/24/25] R	\$ 2,249.	188
MC2430D6__ [22/26/27/28] R	\$ 1,979.	188
MC2430D6__ [11/20/21] RE2	\$ 2,129.	188
MC2430D6__ [12/19/23/24/25] RE2	\$ 2,679.	188
MC2430D6__ [22/26/27/28] RE2	\$ 2,399.	188
MC2430D6__ [AB] R	\$ 1,699.	188
MC2430D6__ [AB] RE2	\$ 2,129.	188
MC2430D6__ [AB] RE4	\$ 2,449.	188
MC2430D6__ [FB/FP] R	\$ 1,429.	188
MC2430D6__ [FB/FP] RE2	\$ 1,849.	188
MC2430D6__ [FB/FP] RE4	\$ 2,199.	188
MC2430D8__ [11/20/21] L	\$ 1,799.	188
MC2430D8__ [12/19/23/24/25] L	\$ 2,349.	188
MC2430D8__ [22/26/27/28] L	\$ 2,079.	188
MC2430D8__ [11/20/21] LE2	\$ 2,249.	188
MC2430D8__ [12/19/23/24/25] LE2	\$ 2,799.	188
MC2430D8__ [22/26/27/28] LE2	\$ 2,529.	188
MC2430D8__ [AB] L	\$ 1,799.	188
MC2430D8__ [AB] LE2	\$ 2,249.	188
MC2430D8__ [AB] LE4	\$ 2,579.	188

Model Number	Price	Page
MC2430D8__ [FB/FP] L	\$ 1,529.	188
MC2430D8__ [FB/FP] LE2	\$ 1,979.	188
MC2430D8__ [FB/FP] LE4	\$ 2,299.	188
MC2430D8__ [11/20/21] R	\$ 1,799.	188
MC2430D8__ [12/19/23/24/25] R	\$ 2,349.	188
MC2430D8__ [22/26/27/28] R	\$ 2,079.	188
MC2430D8__ [11/20/21] RE2	\$ 2,249.	188
MC2430D8__ [12/19/23/24/25] RE2	\$ 2,799.	188
MC2430D8__ [22/26/27/28] RE2	\$ 2,529.	188
MC2430D8__ [AB] R	\$ 1,799.	188
MC2430D8__ [AB] RE2	\$ 2,249.	188
MC2430D8__ [AB] RE4	\$ 2,579.	188
MC2430D8__ [FB/FP] R	\$ 1,529.	188
MC2430D8__ [FB/FP] RE2	\$ 1,979.	188
MC2430D8__ [FB/FP] RE4	\$ 2,299.	188
MC2440D4__ [11/20/21] L	\$ 1,749.	196
MC2440D4__ [12/19/23/24/25] L	\$ 2,399.	196
MC2440D4__ [22/26/27/28] L	\$ 2,079.	196
MC2440D4__ [11/20/21] LE2	\$ 2,199.	196
MC2440D4__ [12/19/23/24/25] LE2	\$ 2,849.	196
MC2440D4__ [22/26/27/28] LE2	\$ 2,529.	196
MC2440D4__ [AB] L	\$ 1,699.	196
MC2440D4__ [AB] LE2	\$ 2,129.	196
MC2440D4__ [AB] LE4	\$ 2,449.	196
MC2440D4__ [FB/FP] L	\$ 1,429.	196
MC2440D4__ [FB/FP] LE2	\$ 1,849.	196
MC2440D4__ [FB/FP] LE4	\$ 2,199.	196
MC2440D4__ [11/20/21] R	\$ 1,749.	196
MC2440D4__ [12/19/23/24/25] R	\$ 2,399.	196
MC2440D4__ [22/26/27/28] R	\$ 2,079.	196
MC2440D4__ [11/20/21] RE2	\$ 2,199.	196
MC2440D4__ [12/19/23/24/25] RE2	\$ 2,849.	196
MC2440D4__ [22/26/27/28] RE2	\$ 2,529.	196
MC2440D4__ [AB] R	\$ 1,699.	196
MC2440D4__ [AB] RE2	\$ 2,129.	196
MC2440D4__ [AB] RE4	\$ 2,449.	196
MC2440D4__ [FB/FP] R	\$ 1,429.	196
MC2440D4__ [FB/FP] RE2	\$ 1,849.	196
MC2440D4__ [FB/FP] RE4	\$ 2,199.	196
MC2440D6__ [11/20/21] L	\$ 2,029.	196
MC2440D6__ [12/19/23/24/25] L	\$ 2,679.	196
MC2440D6__ [22/26/27/28] L	\$ 2,349.	196
MC2440D6__ [11/20/21] LE2	\$ 2,449.	196
MC2440D6__ [12/19/23/24/25] LE2	\$ 3,129.	196
MC2440D6__ [22/26/27/28] LE2	\$ 2,799.	196
MC2440D6__ [AB] L	\$ 1,979.	196
MC2440D6__ [AB] LE2	\$ 2,399.	196
MC2440D6__ [AB] LE4	\$ 2,729.	196
MC2440D6__ [FB/FP] L	\$ 1,699.	196
MC2440D6__ [FB/FP] LE2	\$ 2,129.	196
MC2440D6__ [FB/FP] LE4	\$ 2,449.	196
MC2440D6__ [11/20/21] R	\$ 2,029.	196
MC2440D6__ [12/19/23/24/25] R	\$ 2,679.	196
MC2440D6__ [22/26/27/28] R	\$ 2,349.	196
MC2440D6__ [11/20/21] RE2	\$ 2,449.	196
MC2440D6__ [12/19/23/24/25] RE2	\$ 3,129.	196
MC2440D6__ [22/26/27/28] RE2	\$ 2,799.	196
MC2440D6__ [AB] R	\$ 1,979.	196
MC2440D6__ [AB] RE2	\$ 2,399.	196
MC2440D6__ [AB] RE4	\$ 2,729.	196
MC2440D6__ [FB/FP] R	\$ 1,699.	196
MC2440D6__ [FB/FP] RE2	\$ 2,129.	196
MC2440D6__ [FB/FP] RE4	\$ 2,449.	196
MC2440D8__ [11/20/21] L	\$ 2,129.	196
MC2440D8__ [12/19/23/24/25] L	\$ 2,799.	196
MC2440D8__ [22/26/27/28] L	\$ 2,449.	196
MC2440D8__ [11/20/21] LE2	\$ 2,579.	196
MC2440D8__ [12/19/23/24/25] LE2	\$ 3,229.	196
MC2440D8__ [22/26/27/28] LE2	\$ 2,899.	196

__ [] denotes Color/Pattern/Style options.

Model Number Price Index

Model Number	Price	Page	Model Number	Price	Page
MC2440D8__ [AB] L	\$ 2,079.	196	MSMK40D4__ [11/20/21]	\$ 329.	274
MC2440D8__ [AB] LE2	\$ 2,529.	196	MSMK40D4__ [12/19/23/24/25]	\$ 429.	274
MC2440D8__ [AB] LE4	\$ 2,849.	196	MSMK40D4__ [22/26/27/28]	\$ 379.	274
MC2440D8__ [FB/FP] L	\$ 1,799.	196	MSMK40D4P	\$ 249.	274
MC2440D8__ [FB/FP] LE2	\$ 2,249.	196	MSMK40D6__ [11/20/21]	\$ 379.	274
MC2440D8__ [FB/FP] LE4	\$ 2,579.	196	MSMK40D6__ [12/19/23/24/25]	\$ 479.	274
MC2440D8__ [11/20/21] R	\$ 2,129.	196	MSMK40D6__ [22/26/27/28]	\$ 429.	274
MC2440D8__ [12/19/23/24/25] R	\$ 2,799.	196	MSMK40D6P	\$ 329.	274
MC2440D8__ [22/26/27/28] R	\$ 2,449.	196	MSMK40D6SR__ [11/20/21]	\$ 329.	274
MC2440D8__ [11/20/21] RE2	\$ 2,579.	196	MSMK40D6SR__ [12/19/23/24/25]	\$ 429.	274
MC2440D8__ [12/19/23/24/25] RE2	\$ 3,229.	196	MSMK40D6SR__ [22/26/27/28]	\$ 379.	274
MC2440D8__ [22/26/27/28] RE2	\$ 2,899.	196	MSMK40D6SRP	\$ 249.	274
MC2440D8__ [AB] R	\$ 2,079.	196	MSMK40D8__ [11/20/21]	\$ 429.	274
MC2440D8__ [AB] RE2	\$ 2,529.	196	MSMK40D8__ [12/19/23/24/25]	\$ 549.	274
MC2440D8__ [AB] RE4	\$ 2,849.	196	MSMK40D8__ [22/26/27/28]	\$ 479.	274
MC2440D8__ [FB/FP] R	\$ 1,799.	196	MSMK40D8P	\$ 379.	274
MC2440D8__ [FB/FP] RE2	\$ 2,249.	196	MSMK40D8SR__ [11/20/21]	\$ 329.	274
MC2440D8__ [FB/FP] RE4	\$ 2,579.	196	MSMK40D8SR__ [12/19/23/24/25]	\$ 429.	274
MFL1.5CABL	\$ 99.	255	MSMK40D8SR__ [22/26/27/28]	\$ 379.	274
MGKIT	\$ 49.	273	MSMK40D8SRP	\$ 249.	274
MGKIT70	\$ 99.	273	MSMK70D4__ [11/20/21]	\$ 479.	274
MHANDLEKIT	\$ 179.	272	MSMK70D4__ [12/19/23/24/25]	\$ 699.	274
ML1.530VFSABNDN	\$ 1,029.	255	MSMK70D4__ [22/26/27/28]	\$ 599.	274
ML1.530VFSACRDN	\$ 1,029.	255	MSMK70D4P	\$ 429.	274
ML1.530VFSGBNDN	\$ 1,299.	255	MSMK70D6__ [11/20/21]	\$ 599.	274
ML1.530VFSGCRDN	\$ 1,299.	255	MSMK70D6__ [12/19/23/24/25]	\$ 829.	274
ML1.540VFSABNDN	\$ 1,149.	255	MSMK70D6__ [22/26/27/28]	\$ 699.	274
ML1.540VFSACRDN	\$ 1,149.	255	MSMK70D6P	\$ 549.	274
ML1.540VFSGBNDN	\$ 1,429.	255	MSMK70D6SR__ [11/20/21]	\$ 479.	274
ML1.540VFSGCRDN	\$ 1,429.	255	MSMK70D6SR__ [12/19/23/24/25]	\$ 699.	274
ML3.530ILSFMRD3	\$ 829.	253	MSMK70D6SR__ [22/26/27/28]	\$ 599.	274
ML3.530ILSFMRD4	\$ 829.	253	MSMK70D6SRP	\$ 429.	274
ML3.530ILSFMRDV	\$ 979.	253	MSMK70D8__ [11/20/21]	\$ 699.	274
ML3.530RFSBBNNN	\$ 1,349.	256	MSMK70D8__ [12/19/23/24/25]	\$ 929.	274
ML3.530RFSBCRNN	\$ 1,349.	256	MSMK70D8__ [22/26/27/28]	\$ 829.	274
ML3.530RFSBNNN	\$ 1,349.	256	MSMK70D8P	\$ 649.	274
ML3.530RFSPCRNN	\$ 1,349.	256	MSMK70D8SR__ [11/20/21]	\$ 479.	274
ML3.540ILSFMRD3	\$ 929.	253	MSMK70D8SR__ [12/19/23/24/25]	\$ 699.	274
ML3.540ILSFMRD4	\$ 929.	253	MSMK70D8SR__ [22/26/27/28]	\$ 599.	274
ML3.540ILSFMRDV	\$ 1,099.	253	MSMK70D8SRP	\$ 429.	274
ML3.540RFSBBNNN	\$ 1,479.	256	PC1230D4TLE__ [76/77]	\$ 1,479.	162
ML3.540RFSBCRNN	\$ 1,479.	256	PC1230D4TLE__ [82/83]	\$ 1,579.	162
ML3.540RFSBNNN	\$ 1,479.	256	PC1230D4TNN__ [76/77]	\$ 1,099.	162
ML3.540RFSPCRNN	\$ 1,479.	256	PC1230D4TNN__ [82/83]	\$ 1,199.	162
MPUSHKIT	\$ 99.	272	PC1230D4TRE__ [76/77]	\$ 1,479.	162
MSF SYSTEMS	\$ 99.	273	PC1230D4TRE__ [82/83]	\$ 1,579.	162
MSFMF	\$ 99.	273	PC1230D6TLE__ [76/77]	\$ 1,749.	162
MSMK30D4__ [11/20/21]	\$ 199.	274	PC1230D6TLE__ [82/83]	\$ 1,849.	162
MSMK30D4__ [12/19/23/24/25]	\$ 329.	274	PC1230D6TNN__ [76/77]	\$ 1,349.	162
MSMK30D4__ [22/26/27/28]	\$ 249.	274	PC1230D6TNN__ [82/83]	\$ 1,479.	162
MSMK30D4P	\$ 149.	274	PC1230D6TRE__ [76/77]	\$ 1,749.	162
MSMK30D4W	\$ 199.	275	PC1230D6TRE__ [82/83]	\$ 1,849.	162
MSMK30D6__ [11/20/21]	\$ 249.	274	PC1240D4TLE__ [76/77]	\$ 1,679.	170
MSMK30D6__ [12/19/23/24/25]	\$ 379.	274	PC1240D4TLE__ [82/83]	\$ 1,799.	170
MSMK30D6__ [22/26/27/28]	\$ 329.	274	PC1240D4TNN__ [76/77]	\$ 1,299.	170
MSMK30D6P	\$ 199.	274	PC1240D4TNN__ [82/83]	\$ 1,429.	170
MSMK30D6SR__ [11/20/21]	\$ 199.	274	PC1240D4TRE__ [76/77]	\$ 1,679.	170
MSMK30D6SR__ [12/19/23/24/25]	\$ 329.	274	PC1240D4TRE__ [82/83]	\$ 1,799.	170
MSMK30D6SR__ [22/26/27/28]	\$ 249.	274	PC1240D6TLE__ [76/77]	\$ 1,949.	170
MSMK30D6SRP	\$ 149.	274	PC1240D6TLE__ [82/83]	\$ 2,079.	170
MSMK30D8__ [11/20/21]	\$ 329.	274	PC1240D6TNN__ [76/77]	\$ 1,579.	170
MSMK30D8__ [12/19/23/24/25]	\$ 429.	274	PC1240D6TNN__ [82/83]	\$ 1,679.	170
MSMK30D8__ [22/26/27/28]	\$ 379.	274	PC1240D6TRE__ [76/77]	\$ 1,949.	170
MSMK30D8P	\$ 249.	274	PC1240D6TRE__ [82/83]	\$ 2,079.	170
MSMK30D8SR__ [11/20/21]	\$ 199.	274	PC1630D4TLE__ [76/77]	\$ 1,579.	164
MSMK30D8SR__ [12/19/23/24/25]	\$ 329.	274	PC1630D4TLE__ [82/83]	\$ 1,679.	164
MSMK30D8SR__ [22/26/27/28]	\$ 249.	274	PC1630D4TNN__ [76/77]	\$ 1,199.	164
MSMK30D8SRP	\$ 149.	274	PC1630D4TNN__ [82/83]	\$ 1,299.	164
			PC1630D4TRE__ [76/77]	\$ 1,579.	164
			PC1630D4TRE__ [82/83]	\$ 1,679.	164

__ [] denotes Color/Pattern/Style options.

Model Number Price Index

Model Number	Price	Page
PC1630D6TLE__ [76/77]	\$ 1,849.	164
PC1630D6TLE__ [82/83]	\$ 1,949.	164
PC1630D6TNN__ [76/77]	\$ 1,479.	164
PC1630D6TNN__ [82/83]	\$ 1,579.	164
PC1630D6TRE__ [76/77]	\$ 1,849.	164
PC1630D6TRE__ [82/83]	\$ 1,949.	164
PC1640D4TLE__ [76/77]	\$ 1,799.	172
PC1640D4TLE__ [82/83]	\$ 1,899.	172
PC1640D4TNN__ [76/77]	\$ 1,429.	172
PC1640D4TNN__ [82/83]	\$ 1,529.	172
PC1640D4TRE__ [76/77]	\$ 1,799.	172
PC1640D4TRE__ [82/83]	\$ 1,899.	172
PC1640D6TLE__ [76/77]	\$ 2,079.	172
PC1640D6TLE__ [82/83]	\$ 2,179.	172
PC1640D6TNN__ [76/77]	\$ 1,679.	172
PC1640D6TNN__ [82/83]	\$ 1,799.	172
PC1640D6TRE__ [76/77]	\$ 2,079.	172
PC1640D6TRE__ [82/83]	\$ 2,179.	172
PC2030D4TLE__ [76/77]	\$ 1,679.	166
PC2030D4TLE__ [82/83]	\$ 1,799.	166
PC2030D4TNN__ [76/77]	\$ 1,299.	166
PC2030D4TNN__ [82/83]	\$ 1,429.	166
PC2030D4TRE__ [76/77]	\$ 1,679.	166
PC2030D4TRE__ [82/83]	\$ 1,799.	166
PC2030D6TLE__ [76/77]	\$ 1,949.	166
PC2030D6TLE__ [82/83]	\$ 2,079.	166
PC2030D6TNN__ [76/77]	\$ 1,579.	166
PC2030D6TNN__ [82/83]	\$ 1,679.	166
PC2030D6TRE__ [76/77]	\$ 1,949.	166
PC2030D6TRE__ [82/83]	\$ 2,079.	166
PC2040D4TLE__ [76/77]	\$ 1,899.	174
PC2040D4TLE__ [82/83]	\$ 2,029.	174
PC2040D4TNN__ [76/77]	\$ 1,529.	174
PC2040D4TNN__ [82/83]	\$ 1,629.	174
PC2040D4TRE__ [76/77]	\$ 1,899.	174
PC2040D4TRE__ [82/83]	\$ 2,029.	174
PC2040D6TLE__ [76/77]	\$ 2,179.	174
PC2040D6TLE__ [82/83]	\$ 2,279.	174
PC2040D6TNN__ [76/77]	\$ 1,799.	174
PC2040D6TNN__ [82/83]	\$ 1,899.	174
PC2040D6TRE__ [76/77]	\$ 2,179.	174
PC2040D6TRE__ [82/83]	\$ 2,279.	174
PC2430D4TLE__ [76/77]	\$ 1,799.	168
PC2430D4TLE__ [82/83]	\$ 1,899.	168
PC2430D4TNN__ [76/77]	\$ 1,429.	168
PC2430D4TNN__ [82/83]	\$ 1,529.	168
PC2430D4TRE__ [76/77]	\$ 1,799.	168
PC2430D4TRE__ [82/83]	\$ 1,899.	168
PC2430D6TLE__ [76/77]	\$ 2,079.	168
PC2430D6TLE__ [82/83]	\$ 2,179.	168
PC2430D6TNN__ [76/77]	\$ 1,679.	168
PC2430D6TNN__ [82/83]	\$ 1,799.	168
PC2430D6TRE__ [76/77]	\$ 2,079.	168
PC2430D6TRE__ [82/83]	\$ 2,179.	168
PC2440D4TLE__ [76/77]	\$ 2,029.	176
PC2440D4TLE__ [82/83]	\$ 2,129.	176
PC2440D4TNN__ [76/77]	\$ 1,629.	176
PC2440D4TNN__ [82/83]	\$ 1,749.	176
PC2440D4TRE__ [76/77]	\$ 2,029.	176
PC2440D4TRE__ [82/83]	\$ 2,129.	176
PC2440D6TLE__ [76/77]	\$ 2,279.	176
PC2440D6TLE__ [82/83]	\$ 2,399.	176
PC2440D6TNN__ [76/77]	\$ 1,899.	176
PC2440D6TNN__ [82/83]	\$ 2,029.	176
PC2440D6TRE__ [76/77]	\$ 2,279.	176
PC2440D6TRE__ [82/83]	\$ 2,399.	176
PL3.530TLSC__ [76/77] D3	\$ 1,029.	250
PL3.530TLSC__ [82/83] D3	\$ 1,149.	250
PL3.530TLSC__ [76/77] D4	\$ 1,029.	250
PL3.530TLSC__ [82/83] D4	\$ 1,149.	250

Model Number	Price	Page
PL3.530TLSC__ [76/77] DV	\$ 1,199.	250
PL3.530TLSC__ [82/83] DV	\$ 1,299.	250
PL3.540TLSC__ [76/77] D3	\$ 1,249.	250
PL3.540TLSC__ [82/83] D3	\$ 1,349.	250
PL3.540TLSC__ [76/77] D4	\$ 1,249.	250
PL3.540TLSC__ [82/83] D4	\$ 1,349.	250
PL3.540TLSC__ [76/77] DV	\$ 1,429.	250
PL3.540TLSC__ [82/83] DV	\$ 1,529.	250
PL5.030TLSC__ [76/77] D3	\$ 1,349.	250
PL5.030TLSC__ [82/83] D3	\$ 1,479.	250
PL5.030TLSC__ [76/77] D4	\$ 1,349.	250
PL5.030TLSC__ [82/83] D4	\$ 1,479.	250
PL5.030TLSC__ [76/77] DV	\$ 1,529.	250
PL5.030TLSC__ [82/83] DV	\$ 1,629.	250
PL5.040TLSC__ [76/77] D3	\$ 1,579.	250
PL5.040TLSC__ [82/83] D3	\$ 1,679.	250
PL5.040TLSC__ [76/77] D4	\$ 1,579.	250
PL5.040TLSC__ [82/83] D4	\$ 1,679.	250
PL5.040TLSC__ [76/77] DV	\$ 1,749.	250
PL5.040TLSC__ [82/83] DV	\$ 1,849.	250
PL30GBL	\$ 1,299.	255
PL30GCH	\$ 1,299.	255
PL30GWH	\$ 1,299.	255
PL30PBL	\$ 1,029.	255
PL30PBLN	\$ 829.	255
PL30PCH	\$ 1,029.	255
PL30PCHN	\$ 829.	255
PL30PWH	\$ 1,029.	255
PL30PWHN	\$ 829.	255
PL40GBL	\$ 1,429.	255
PL40GCH	\$ 1,429.	255
PL40GWH	\$ 1,429.	255
PL40PBL	\$ 1,149.	255
PL40PCH	\$ 1,149.	255
PL40PWH	\$ 1,149.	255
PLGKIT	\$ 49.	273
PLM1630B	\$ 529.	232
PLM1630BB	\$ 529.	232
PLM1630BBLE	\$ 829.	232
PLM1630BBRE	\$ 829.	232
PLM1630BLE	\$ 829.	232
PLM1630BRE	\$ 829.	232
PLM1630G	\$ 529.	232
PLM1630GB	\$ 529.	232
PLM1630GBLE	\$ 829.	232
PLM1630GBRE	\$ 829.	232
PLM1630GLE	\$ 829.	232
PLM1630GRE	\$ 829.	232
PLM1630W	\$ 529.	232
PLM1630WB	\$ 529.	232
PLM1630WBLE	\$ 829.	232
PLM1630WBRE	\$ 829.	232
PLM1630WLE	\$ 829.	232
PLM1630WRE	\$ 829.	232
PLM1634BBA	\$ 799.	232
PLM1634BBARE	\$ 1,099.	232
PLM1634GBA	\$ 799.	232
PLM1634GBARE	\$ 1,099.	232
PLM1634WBA	\$ 799.	232
PLM1634WBARE	\$ 1,099.	232
PLM1640B	\$ 649.	232
PLM1640BB	\$ 649.	232
PLM1640BBLE	\$ 929.	232
PLM1640BBRE	\$ 929.	232
PLM1640BLE	\$ 929.	232
PLM1640BRE	\$ 929.	232
PLM1640G	\$ 649.	232
PLM1640GB	\$ 649.	232
PLM1640GBLE	\$ 929.	232
PLM1640GBRE	\$ 929.	232

[] denotes Color/Pattern/Style options.

Model Number Price Index

Model Number	Price	Page	Model Number	Price	Page
PLM1640GLE	\$ 929.	232	PLM2434GBA	\$ 899.	234
PLM1640GRE	\$ 929.	232	PLM2434GBARE	\$ 1,199.	234
PLM1640W	\$ 649.	232	PLM2434WBA	\$ 899.	234
PLM1640WB	\$ 649.	232	PLM2434WBARE	\$ 1,199.	234
PLM1640WBLE	\$ 929.	232	PLM2440B	\$ 749.	234
PLM1640WBRE	\$ 929.	232	PLM2440BB	\$ 749.	234
PLM1640WLE	\$ 929.	232	PLM2440BBLE	\$ 1,029.	234
PLM1640WRE	\$ 929.	232	PLM2440BBRE	\$ 1,029.	234
PLM2030B	\$ 579.	233	PLM2440BLE	\$ 1,029.	234
PLM2030BB	\$ 579.	233	PLM2440BRE	\$ 1,029.	234
PLM2030BBLE	\$ 879.	233	PLM2440G	\$ 749.	234
PLM2030BBRE	\$ 879.	233	PLM2440GB	\$ 749.	234
PLM2030BLE	\$ 879.	233	PLM2440GBLE	\$ 1,029.	234
PLM2030BRE	\$ 879.	233	PLM2440GBRE	\$ 1,029.	234
PLM2030G	\$ 579.	233	PLM2440GLE	\$ 1,029.	234
PLM2030GB	\$ 579.	233	PLM2440GRE	\$ 1,029.	234
PLM2030GBLE	\$ 879.	233	PLM2440W	\$ 749.	234
PLM2030GBRE	\$ 879.	233	PLM2440WB	\$ 749.	234
PLM2030GLE	\$ 879.	233	PLM2440WBLE	\$ 1,029.	234
PLM2030GRE	\$ 879.	233	PLM2440WBRE	\$ 1,029.	234
PLM2030W	\$ 579.	233	PLM2440WLE	\$ 1,029.	234
PLM2030WB	\$ 579.	233	PLM2440WRE	\$ 1,029.	234
PLM2030WBLE	\$ 879.	233	PLM3030B	\$ 1,229.	235
PLM2030WBRE	\$ 879.	233	PLM3030BE	\$ 1,529.	235
PLM2030WLE	\$ 879.	233	PLM3030G	\$ 1,229.	235
PLM2030WRE	\$ 879.	233	PLM3030GE	\$ 1,529.	235
PLM2034BBA	\$ 849.	233	PLM3030W	\$ 1,229.	235
PLM2034BBARE	\$ 1,149.	233	PLM3030WE	\$ 1,529.	235
PLM2034GBA	\$ 849.	233	PLM3630B	\$ 1,399.	235
PLM2034GBARE	\$ 1,129.	233	PLM3630BE	\$ 1,679.	235
PLM2034WBA	\$ 849.	233	PLM3630G	\$ 1,399.	235
PLM2034WBARE	\$ 1,149.	233	PLM3630GE	\$ 1,679.	235
PLM2040B	\$ 699.	233	PLM3630W	\$ 1,399.	235
PLM2040BB	\$ 699.	233	PLM3630WE	\$ 1,679.	235
PLM2040BBLE	\$ 979.	233	PLSMK30D4P	\$ 149.	275
PLM2040BBRE	\$ 979.	233	PLSMK40D4P	\$ 249.	275
PLM2040BLE	\$ 979.	233	PM2430T__[76/77]	\$ 1,049.	29
PLM2040BRE	\$ 979.	233	PM2430T__[82/83]	\$ 1,149.	29
PLM2040G	\$ 699.	233	PM2440T__[76/77]	\$ 1,149.	29
PLM2040GB	\$ 699.	233	PM2440T__[82/83]	\$ 1,279.	29
PLM2040GBLE	\$ 979.	233	PM3030T__[76/77]	\$ 1,079.	29
PLM2040GBRE	\$ 979.	233	PM3030T__[82/83]	\$ 1,199.	29
PLM2040GLE	\$ 979.	233	PM3040T__[76/77]	\$ 1,249.	29
PLM2040GRE	\$ 979.	233	PM3040T__[82/83]	\$ 1,349.	29
PLM2040W	\$ 699.	233	PM3630T__[76/77]	\$ 1,199.	29
PLM2040WB	\$ 699.	233	PM3630T__[82/83]	\$ 1,299.	29
PLM2040WBLE	\$ 979.	233	PM3640T__[76/77]	\$ 1,349.	29
PLM2040WBRE	\$ 979.	233	PM3640T__[82/83]	\$ 1,479.	29
PLM2040WLE	\$ 979.	233	PMGKIT2430	\$ 379.	29, 275
PLM2040WRE	\$ 979.	233	PMGKIT2440	\$ 379.	29, 275
PLM2430B	\$ 649.	234	PMGKIT3030	\$ 429.	29, 275
PLM2430BB	\$ 649.	234	PMGKIT3040	\$ 429.	29, 275
PLM2430BBLE	\$ 929.	234	PMGKIT3630	\$ 479.	29, 275
PLM2430BBRE	\$ 929.	234	PMGKIT3640	\$ 479.	29, 275
PLM2430BLE	\$ 929.	234	POMM	\$ 229.	272
PLM2430BRE	\$ 929.	234	RC1620D4FB1	\$ 279.	238
PLM2430G	\$ 649.	234	RC1620D4FP1	\$ 279.	238
PLM2430GB	\$ 649.	234	RC1626D4FB1	\$ 429.	238
PLM2430GBLE	\$ 929.	234	RC1626D4FP1	\$ 429.	238
PLM2430GBRE	\$ 929.	234	RC1636D4FB1	\$ 529.	238
PLM2430GLE	\$ 929.	234	RC1636D4FP1	\$ 529.	238
PLM2430GRE	\$ 929.	234	RC2026D4FB1	\$ 479.	239
PLM2430W	\$ 649.	234	RC2026D4FP1	\$ 479.	239
PLM2430WB	\$ 649.	234	RC2036D4FB1	\$ 649.	239
PLM2430WBLE	\$ 929.	234	RC2036D4FP1	\$ 649.	239
PLM2430WBRE	\$ 929.	234	RC2426D4FB1	\$ 529.	240
PLM2430WLE	\$ 929.	234	RC2426D4FP1	\$ 529.	240
PLM2430WRE	\$ 929.	234	RC2436D4FB1	\$ 749.	240
PLM2434BBA	\$ 899.	234	RC2436D4FP1	\$ 749.	240
PLM2434BBARE	\$ 1,199.	234	RGKIT	\$ 49.	273

[] denotes Color/Pattern/Style options.

Model Number Price Index

Model Number	Price	Page
RSMK20D4P	\$ 149.	275
RSMK26D4P	\$ 149.	275
RSMK36D4P	\$ 149.	275
SHLF8D4	\$ 60.	277
SHLF8D4S3	\$ 71.	277
SHLF10D4	\$ 59.	277
SHLF10D4S3	\$ 69.	277
SHLF12D4	\$ 99.	277
SHLF12D6	\$ 99.	277
SHLF16D4	\$ 99.	277
SHLF16D4S4	\$ 199.	277
SHLF16D6	\$ 99.	277
SHLF16D8	\$ 99.	277
SHLF20D4	\$ 99.	277
SHLF20D4S3	\$ 149.	277
SHLF20D4S4	\$ 199.	277
SHLF20D6	\$ 99.	277
SHLF20D8	\$ 99.	277
SHLF24D4	\$ 99.	277
SHLF24D4S3	\$ 149.	277
SHLF24D4S4	\$ 199.	277
SHLF24D6	\$ 99.	277
SHLF24D8	\$ 99.	277
SHLFPLM30	\$ 99.	277
SHLFPLM36	\$ 99.	277
SLB-*	\$ 279.	272
SLEDS12	\$ 279.	266
SLEDS24	\$ 329.	266
SLEDS30	\$ 379.	266
SLEDS36	\$ 449.	266
SOMM	\$ 99.	272
TC25UCN21-1	\$ 1,029.	128
TC25UCN21-8	\$ 1,029.	128
TC31UCN21-1	\$ 1,129.	129
TC31UCN21-8	\$ 1,129.	129
TC37UCN21-1	\$ 1,349.	130
TC37UCN21-8	\$ 1,349.	130
TE13G90	\$ 879.	128
TE13G91	\$ 879.	128
TE13G92	\$ 979.	128
TE13G93	\$ 1,299.	128
TE13G94	\$ 1,299.	128
TE25G90	\$ 1,099.	128
TE25G91	\$ 1,099.	128
TE25G92	\$ 1,199.	128
TE25G93	\$ 1,529.	128
TE25G94	\$ 1,529.	128
TE31G90	\$ 1,199.	129
TE31G91	\$ 1,199.	129
TE31G92	\$ 1,299.	129
TE31G93	\$ 1,629.	129
TE31G94	\$ 1,629.	129
TE37G90	\$ 1,299.	130
TE37G91	\$ 1,299.	130
TE37G92	\$ 1,429.	130
TE37G93	\$ 1,749.	130
TE37G94	\$ 1,749.	130
TE43G90	\$ 1,529.	131
TE43G91	\$ 1,529.	131
TE43G92	\$ 1,629.	131
TE43G93	\$ 1,949.	131
TE43G94	\$ 1,949.	131
TE49G90	\$ 1,629.	132
TE49G91	\$ 1,629.	132
TE49G92	\$ 1,749.	132
TE49G93	\$ 2,179.	132
TE49G94	\$ 2,179.	132
TE61G90	\$ 1,849.	133
TE61G91	\$ 1,849.	133
TE61G92	\$ 1,949.	133

Model Number	Price	Page
TE61G93	\$ 2,399.	133
TE61G94	\$ 2,399.	133
TE73G90	\$ 2,179.	135
TE73G91	\$ 2,179.	135
TE73G92	\$ 2,279.	135
TE73G93	\$ 2,729.	135
TE73G94	\$ 2,729.	135
TF13G90	\$ 879.	128
TF13G91	\$ 879.	128
TF13G92	\$ 979.	128
TF13G93	\$ 1,299.	128
TF13G94	\$ 1,299.	128
TF25G90	\$ 1,099.	128
TF25G91	\$ 1,099.	128
TF25G92	\$ 1,199.	128
TF25G93	\$ 1,529.	128
TF25G94	\$ 1,529.	128
TF25UCO90-1	\$ 1,429.	128
TF25UCO90-8	\$ 1,429.	128
TF25UCO91-1	\$ 1,429.	128
TF25UCO91-8	\$ 1,429.	128
TF25UCO92-1	\$ 1,529.	128
TF25UCO92-8	\$ 1,529.	128
TF25UCO93-1	\$ 1,849.	128
TF25UCO93-8	\$ 1,849.	128
TF25UCO94-1	\$ 1,849.	128
TF25UCO94-8	\$ 1,849.	128
TF31G90	\$ 1,199.	129
TF31G91	\$ 1,199.	129
TF31G92	\$ 1,299.	129
TF31G93	\$ 1,629.	129
TF31G94	\$ 1,629.	129
TF31UCO90-1	\$ 1,529.	129
TF31UCO90-8	\$ 1,529.	129
TF31UCO91-1	\$ 1,529.	129
TF31UCO91-8	\$ 1,529.	129
TF31UCO92-1	\$ 1,629.	129
TF31UCO92-8	\$ 1,629.	129
TF31UCO93-1	\$ 1,949.	129
TF31UCO93-8	\$ 1,949.	129
TF31UCO94-1	\$ 1,949.	129
TF31UCO94-8	\$ 1,949.	129
TF37G90	\$ 1,299.	130
TF37G91	\$ 1,299.	130
TF37G92	\$ 1,429.	130
TF37G93	\$ 1,749.	130
TF37G94	\$ 1,749.	130
TF37UCO90-1	\$ 1,629.	130
TF37UCO90-8	\$ 1,629.	130
TF37UCO91-1	\$ 1,629.	130
TF37UCO91-8	\$ 1,629.	130
TF37UCO92-1	\$ 1,749.	130
TF37UCO92-8	\$ 1,749.	130
TF37UCO93-1	\$ 2,079.	130
TF37UCO93-8	\$ 2,079.	130
TF37UCO94-1	\$ 2,079.	130
TF37UCO94-8	\$ 2,079.	130
TF37ULO90-1	\$ 1,629.	130
TF37ULO90-8	\$ 1,629.	130
TF37ULO91-1	\$ 1,629.	130
TF37ULO91-8	\$ 1,629.	130
TF37ULO92-1	\$ 1,749.	130
TF37ULO92-8	\$ 1,749.	130
TF37ULO93-1	\$ 2,079.	130
TF37ULO93-8	\$ 2,079.	130
TF37ULO94-1	\$ 2,079.	130
TF37ULO94-8	\$ 2,079.	130
TF37URO90-1	\$ 1,629.	130
TF37URO90-8	\$ 1,629.	130
TF37URO91-1	\$ 1,629.	130
TF37URO91-8	\$ 1,629.	130

__[] denotes Color/Pattern/Style options.

Model Number Price Index

Model Number	Price	Page	Model Number	Price	Page
TF37URO92-1	\$ 1,749.	130	TF49ULO92-1	\$ 2,079.	132
TF37URO92-8	\$ 1,749.	130	TF49ULO92-8	\$ 2,079.	132
TF37URO93-1	\$ 2,079.	130	TF49ULO93-1	\$ 2,499.	132
TF37URO93-8	\$ 2,079.	130	TF49ULO93-8	\$ 2,499.	132
TF37URO94-1	\$ 2,079.	130	TF49ULO94-1	\$ 2,499.	132
TF37URO94-8	\$ 2,079.	130	TF49ULO94-8	\$ 2,499.	132
TF43G90	\$ 1,529.	131	TF49URO90-1	\$ 1,949.	132
TF43G91	\$ 1,529.	131	TF49URO90-8	\$ 1,949.	132
TF43G92	\$ 1,629.	131	TF49URO91-1	\$ 1,949.	132
TF43G93	\$ 1,949.	131	TF49URO91-8	\$ 1,949.	132
TF43G94	\$ 1,949.	131	TF49URO92-1	\$ 2,079.	132
TF43UCO90-1	\$ 1,849.	131	TF49URO92-8	\$ 2,079.	132
TF43UCO90-8	\$ 1,849.	131	TF49URO93-1	\$ 2,499.	132
TF43UCO91-1	\$ 1,849.	131	TF49URO93-8	\$ 2,499.	132
TF43UCO91-8	\$ 1,849.	131	TF49URO94-1	\$ 2,499.	132
TF43UCO92-1	\$ 1,949.	131	TF49URO94-8	\$ 2,499.	132
TF43UCO92-8	\$ 1,949.	131	TF61G90	\$ 1,849.	133
TF43UCO93-1	\$ 2,279.	131	TF61G91	\$ 1,849.	133
TF43UCO93-8	\$ 2,279.	131	TF61G92	\$ 1,949.	133
TF43UCO94-1	\$ 2,279.	131	TF61G93	\$ 2,399.	133
TF43UCO94-8	\$ 2,279.	131	TF61G94	\$ 2,399.	133
TF43ULO90-1	\$ 1,849.	131	TF61UCO90-1	\$ 2,179.	133
TF43ULO90-8	\$ 1,849.	131	TF61UCO90-8	\$ 2,179.	133
TF43ULO91-1	\$ 1,849.	131	TF61UCO91-1	\$ 2,179.	133
TF43ULO91-8	\$ 1,849.	131	TF61UCO91-8	\$ 2,179.	133
TF43ULO92-1	\$ 1,949.	131	TF61UCO92-1	\$ 2,279.	133
TF43ULO92-8	\$ 1,949.	131	TF61UCO92-8	\$ 2,279.	133
TF43ULO93-1	\$ 2,279.	131	TF61UCO93-1	\$ 2,729.	133
TF43ULO93-8	\$ 2,279.	131	TF61UCO93-8	\$ 2,729.	133
TF43ULO94-1	\$ 2,279.	131	TF61UCO94-1	\$ 2,729.	133
TF43ULO94-8	\$ 2,279.	131	TF61UCO94-8	\$ 2,729.	133
TF43URO90-1	\$ 1,849.	131	TF61UDO90-1D2	\$ 2,729.	133
TF43URO90-8	\$ 1,849.	131	TF61UDO90-1D4	\$ 2,729.	133
TF43URO91-1	\$ 1,849.	131	TF61UDO90-8D2	\$ 2,729.	133
TF43URO91-8	\$ 1,849.	131	TF61UDO90-8D4	\$ 2,729.	133
TF43URO92-1	\$ 1,949.	131	TF61UDO91-1D2	\$ 2,729.	133
TF43URO92-8	\$ 1,949.	131	TF61UDO91-1D4	\$ 2,729.	133
TF43URO93-1	\$ 2,279.	131	TF61UDO91-8D2	\$ 2,729.	133
TF43URO93-8	\$ 2,279.	131	TF61UDO91-8D4	\$ 2,729.	133
TF43URO94-1	\$ 2,279.	131	TF61UDO92-1D2	\$ 2,829.	133
TF43URO94-8	\$ 2,279.	131	TF61UDO92-1D4	\$ 2,829.	133
TF49G90	\$ 1,629.	132	TF61UDO92-8D2	\$ 2,829.	133
TF49G91	\$ 1,629.	132	TF61UDO92-8D4	\$ 2,829.	133
TF49G92	\$ 1,749.	132	TF61UDO93-1D2	\$ 3,279.	133
TF49G93	\$ 2,179.	132	TF61UDO93-1D4	\$ 3,279.	133
TF49G94	\$ 2,179.	132	TF61UDO93-8D2	\$ 3,279.	133
TF49UCO90-1	\$ 1,949.	132	TF61UDO93-8D4	\$ 3,279.	133
TF49UCO90-8	\$ 1,949.	132	TF61UDO94-1D2	\$ 3,279.	133
TF49UCO91-1	\$ 1,949.	132	TF61UDO94-1D4	\$ 3,279.	133
TF49UCO91-8	\$ 1,949.	132	TF61UDO94-8D2	\$ 3,279.	133
TF49UCO92-1	\$ 2,079.	132	TF61UDO94-8D4	\$ 3,279.	133
TF49UCO92-8	\$ 2,079.	132	TF73G90	\$ 2,179.	135
TF49UCO93-1	\$ 2,499.	132	TF73G91	\$ 2,179.	135
TF49UCO93-8	\$ 2,499.	132	TF73G92	\$ 2,279.	135
TF49UCO94-1	\$ 2,499.	132	TF73G93	\$ 2,729.	135
TF49UCO94-8	\$ 2,499.	132	TF73G94	\$ 2,729.	135
TF49UDO90-1D1	\$ 2,499.	132	TF73UDO90-1D3	\$ 3,049.	134
TF49UDO90-8D1	\$ 2,499.	132	TF73UDO90-1D5	\$ 3,049.	134
TF49UDO91-1D1	\$ 2,499.	132	TF73UDO90-1D6	\$ 3,049.	134
TF49UDO91-8D1	\$ 2,499.	132	TF73UDO90-8D3	\$ 3,049.	134
TF49UDO92-1D1	\$ 2,629.	132	TF73UDO90-8D5	\$ 3,049.	134
TF49UDO92-8D1	\$ 2,629.	132	TF73UDO90-8D6	\$ 3,049.	134
TF49UDO93-1D1	\$ 3,049.	132	TF73UDO91-1D3	\$ 3,049.	134
TF49UDO93-8D1	\$ 3,049.	132	TF73UDO91-1D5	\$ 3,049.	134
TF49UDO94-1D1	\$ 3,049.	132	TF73UDO91-1D6	\$ 3,049.	134
TF49UDO94-8D1	\$ 3,049.	132	TF73UDO91-8D3	\$ 3,049.	134
TF49ULO90-1	\$ 1,949.	132	TF73UDO91-8D5	\$ 3,049.	134
TF49ULO90-8	\$ 1,949.	132	TF73UDO91-8D6	\$ 3,049.	134
TF49ULO91-1	\$ 1,949.	132	TF73UDO92-1D3	\$ 3,149.	134
TF49ULO91-8	\$ 1,949.	132	TF73UDO92-1D5	\$ 3,149.	134
			TF73UDO92-1D6	\$ 3,149.	134

[] denotes Color/Pattern/Style options.

Model Number Price Index

Model Number	Price	Page	Model Number	Price	Page
TF73UDO92-8D3	\$ 3,149.	134	UHANDLE3076	\$ 379.	151
TF73UDO92-8D5	\$ 3,149.	134	UHANDLE3077	\$ 379.	151
TF73UDO92-8D6	\$ 3,149.	134	UHANDLE3082	\$ 399.	151
TF73UDO93-1D3	\$ 3,599.	134	UHANDLE3083	\$ 399.	151
TF73UDO93-1D5	\$ 3,599.	134	UHANDLE3676	\$ 429.	151
TF73UDO93-1D6	\$ 3,599.	134	UHANDLE3677	\$ 429.	151
TF73UDO93-8D3	\$ 3,599.	134	UHANDLE3682	\$ 449.	151
TF73UDO93-8D5	\$ 3,599.	134	UHANDLE3683	\$ 449.	151
TF73UDO93-8D6	\$ 3,599.	134	UHANDLE4876	\$ 479.	151
TF73UDO94-1D3	\$ 3,599.	134	UHANDLE4877	\$ 479.	151
TF73UDO94-1D5	\$ 3,599.	134	UHANDLE4882	\$ 499.	151
TF73UDO94-1D6	\$ 3,599.	134	UHANDLE4883	\$ 499.	151
TF73UDO94-8D3	\$ 3,599.	134	UORGSHSELF12	\$ 279.	154
TF73UDO94-8D5	\$ 3,599.	134	UORGSHSELF20	\$ 329.	154
TF73UDO94-8D6	\$ 3,599.	134	UORGSHSELF22	\$ 329.	154
TF73UTO90-1T1	\$ 3,599.	134	USK27D6P	\$ 179.	154
TF73UTO90-8T1	\$ 3,599.	134	USK27D6SR	\$ 179.	154
TF73UTO91-1T1	\$ 3,599.	134	USMK27D6P	\$ 179.	151, 275
TF73UTO91-8T1	\$ 3,599.	134	USMK27D6SRP	\$ 179.	151, 275
TF73UTO92-1T1	\$ 3,699.	134	UTK24D6A	\$ 229.	151, 275
TF73UTO92-8T1	\$ 3,699.	134	UTK24D6ASR	\$ 229.	151, 275
TF73UTO93-1T1	\$ 4,149.	134	UTK30D6A	\$ 229.	151, 275
TF73UTO93-8T1	\$ 4,149.	134	UTK30D6ASR	\$ 229.	151, 275
TF73UTO94-1T1	\$ 4,149.	134	UTK36D6A	\$ 229.	151, 275
TF73UTO94-8T1	\$ 4,149.	134	UTK36D6ASR	\$ 229.	151, 275
TS25UCN21-1	\$ 1,029.	128	UTK48D6A	\$ 229.	151, 275
TS25UCN21-8	\$ 1,029.	128	UTK48D6ASR	\$ 229.	151, 275
TS31UCN21-1	\$ 1,129.	129	VACOTTON1	\$ 229.	268
TS31UCN21-8	\$ 1,129.	129	VACOTTON3	\$ 449.	268
TVMOUNT20	\$ 179.	154	VADRAWER12X	\$ 499.	267
TVMOUNT22	\$ 179.	154	VADRAWER24P	\$ 629.	267
UBK30D6A	\$ 229.	154	VADRAWER24X	\$ 629.	267
UBK30D6ASR	\$ 229.	154	VADRAWER30P	\$ 729.	267
UBK36D6A	\$ 229.	154	VADRAWER30X	\$ 729.	267
UBK36D6ASR	\$ 229.	154	VADRAWER36P	\$ 799.	267
UBK48D6A	\$ 229.	154	VADRAWER36X	\$ 799.	267
UBK48D6ASR	\$ 229.	154	VAELECTRIC18	\$ 449.	266
UC24276FPNE0N	\$ 1,999.	149	VAELECTRIC21	\$ 449.	266
UC3027FPE	\$ 2,949.	153	VAHAIRORG	\$ 229.	266
UC3027FPL	\$ 3,379.	153	VALEVELH1	\$ 279.	268
UC30276FPNE0N	\$ 2,299.	149	VALEVELH2	\$ 399.	268
UC30276FPNE2N	\$ 2,599.	149	VALITERATURE	\$ 279.	268
UC30276FPNE4N	\$ 3,099.	149	VASIDESTOP	\$ 49.	268
UC30276RP3E2N	\$ 3,099.	149	VATP	\$ 99.	268
UC30276RP3E4N	\$ 3,599.	149	VAWASTE	\$ 279.	268
UC3627FPE	\$ 3,479.	153	VB30H1D21P__[10/11/20/21]L71	\$ 3,049.	64
UC3627FPL	\$ 3,929.	153	VB30H1D21P__[10/11/20/21]L74	\$ 3,049.	64
UC36276FPNE2N	\$ 3,099.	150	VB30H1D21P__[10/11/20/21]L76	\$ 3,049.	64
UC36276FPNE4N	\$ 3,599.	150	VB30H1D21P__[10/11/20/21]N71	\$ 2,679.	64
UC36276RP3E2N	\$ 3,599.	150	VB30H1D21P__[10/11/20/21]N74	\$ 2,679.	64
UC36276RP3E4N	\$ 4,099.	150	VB30H1D21P__[10/11/20/21]N76	\$ 2,679.	64
UC4827FPE	\$ 4,199.	153	VB30H1D21P__[10/11/20/21]S71	\$ 3,049.	64
UC4827FPL	\$ 4,629.	153	VB30H1D21P__[10/11/20/21]S74	\$ 3,049.	64
UC48276FPNE2N	\$ 3,749.	150	VB30H1D21P__[10/11/20/21]S76	\$ 3,049.	64
UC48276FPNE4N	\$ 4,249.	150	VB30H1D21P__[12/19/23/24/25]L71	\$ 4,149.	64
UC48276RP3E2N	\$ 4,249.	150	VB30H1D21P__[12/19/23/24/25]L74	\$ 4,149.	64
UC48276RP3E4N	\$ 4,749.	150	VB30H1D21P__[12/19/23/24/25]L76	\$ 4,149.	64
UFKIT	\$ 179.	154	VB30H1D21P__[12/19/23/24/25]N71	\$ 3,749.	64
UFLPAL	\$ 699.	154, 258	VB30H1D21P__[12/19/23/24/25]N74	\$ 3,749.	64
UFLPBNL	\$ 829.	154, 258	VB30H1D21P__[12/19/23/24/25]N76	\$ 3,749.	64
UFLPCRL	\$ 829.	154, 258	VB30H1D21P__[12/19/23/24/25]S71	\$ 4,149.	64
UFLPPNL	\$ 829.	154, 258	VB30H1D21P__[12/19/23/24/25]S74	\$ 4,149.	64
UFLWAL	\$ 699.	154, 258	VB30H1D21P__[12/19/23/24/25]S76	\$ 4,149.	64
UFLWBNL	\$ 829.	154, 258	VB30H1D21P__[22/26/27/28]L71	\$ 3,599.	64
UFLWCRL	\$ 829.	154, 258	VB30H1D21P__[22/26/27/28]L74	\$ 3,599.	64
UFLWPNL	\$ 829.	154, 258	VB30H1D21P__[22/26/27/28]L76	\$ 3,599.	64
UGKIT	\$ 179.	151, 273	VB30H1D21P__[22/26/27/28]N71	\$ 3,199.	64
UHANDLE2476	\$ 329.	151	VB30H1D21P__[22/26/27/28]N74	\$ 3,199.	64
UHANDLE2477	\$ 329.	151	VB30H1D21P__[22/26/27/28]N76	\$ 3,199.	64
UHANDLE2482	\$ 349.	151			
UHANDLE2483	\$ 349.	151			

[_] denotes Color/Pattern/Style options.

Model Number Price Index

Model Number	Price	Page	Model Number	Price	Page
VB42H1D21P__ [10/11/20/21] L71	\$ 4,249.	68	VB42H2D21P__ [12/19/23/24/25] S71	\$ 5,599.	68
VB42H1D21P__ [10/11/20/21] L74	\$ 4,249.	68	VB42H2D21P__ [12/19/23/24/25] S74	\$ 5,599.	68
VB42H1D21P__ [10/11/20/21] L76	\$ 4,249.	68	VB42H2D21P__ [12/19/23/24/25] S76	\$ 5,599.	68
VB42H1D21P__ [10/11/20/21] N71	\$ 3,749.	68	VB42H2D21P__ [22/26/27/28] L71	\$ 5,079.	68
VB42H1D21P__ [10/11/20/21] N74	\$ 3,749.	68	VB42H2D21P__ [22/26/27/28] L74	\$ 5,079.	68
VB42H1D21P__ [10/11/20/21] N76	\$ 3,749.	68	VB42H2D21P__ [22/26/27/28] L76	\$ 5,079.	68
VB42H1D21P__ [10/11/20/21] S71	\$ 4,249.	68	VB42H2D21P__ [22/26/27/28] N71	\$ 4,579.	68
VB42H1D21P__ [10/11/20/21] S74	\$ 4,249.	68	VB42H2D21P__ [22/26/27/28] N74	\$ 4,579.	68
VB42H1D21P__ [10/11/20/21] S76	\$ 4,249.	68	VB42H2D21P__ [22/26/27/28] N76	\$ 4,579.	68
VB42H1D21P__ [12/19/23/24/25] L71	\$ 5,349.	68	VB42H2D21P__ [22/26/27/28] S71	\$ 5,079.	68
VB42H1D21P__ [12/19/23/24/25] L74	\$ 5,349.	68	VB42H2D21P__ [22/26/27/28] S74	\$ 5,079.	68
VB42H1D21P__ [12/19/23/24/25] L76	\$ 5,349.	68	VB42H2D21P__ [22/26/27/28] S76	\$ 5,079.	68
VB42H1D21P__ [12/19/23/24/25] N71	\$ 4,849.	68	VF12FDXLPWM__ [10/11/20/21]	\$ 1,479.	92
VB42H1D21P__ [12/19/23/24/25] N74	\$ 4,849.	68	VF12FDXLPWM__ [12/19/23/24/25]	\$ 2,549.	92
VB42H1D21P__ [12/19/23/24/25] N76	\$ 4,849.	68	VF12FDXLPWM__ [22/26/27/28]	\$ 2,029.	92
VB42H1D21P__ [12/19/23/24/25] S71	\$ 5,349.	68	VF12FDXLSWM__ [10/11/20/21]	\$ 1,479.	92
VB42H1D21P__ [12/19/23/24/25] S74	\$ 5,349.	68	VF12FDXLSWM__ [12/19/23/24/25]	\$ 2,549.	92
VB42H1D21P__ [12/19/23/24/25] S76	\$ 5,349.	68	VF12FDXLSWM__ [22/26/27/28]	\$ 2,029.	92
VB42H1D21P__ [22/26/27/28] L71	\$ 4,799.	68	VF12FDXNPWM__ [10/11/20/21]	\$ 1,199.	92
VB42H1D21P__ [22/26/27/28] L74	\$ 4,799.	68	VF12FDXNPWM__ [12/19/23/24/25]	\$ 2,279.	92
VB42H1D21P__ [22/26/27/28] L76	\$ 4,799.	68	VF12FDXNPWM__ [22/26/27/28]	\$ 1,749.	92
VB42H1D21P__ [22/26/27/28] N71	\$ 4,299.	68	VF12FDXNSWM__ [10/11/20/21]	\$ 1,199.	92
VB42H1D21P__ [22/26/27/28] N74	\$ 4,299.	68	VF12FDXNSWM__ [12/19/23/24/25]	\$ 2,279.	92
VB42H1D21P__ [22/26/27/28] N76	\$ 4,299.	68	VF12FDXNSWM__ [22/26/27/28]	\$ 1,749.	92
VB42H1D21P__ [22/26/27/28] S71	\$ 4,799.	68	VF24FDXLPWM__ [10/11/20/21]	\$ 2,079.	94
VB42H1D21P__ [22/26/27/28] S74	\$ 4,799.	68	VF24FDXLPWM__ [12/19/23/24/25]	\$ 3,149.	94
VB42H1D21P__ [22/26/27/28] S76	\$ 4,799.	68	VF24FDXLPWM__ [22/26/27/28]	\$ 2,629.	94
VB42H1D21T__ [10/11/20/21] L71	\$ 4,249.	68	VF24FDXLSWM__ [10/11/20/21]	\$ 2,079.	94
VB42H1D21T__ [10/11/20/21] L74	\$ 4,249.	68	VF24FDXLSWM__ [12/19/23/24/25]	\$ 3,149.	94
VB42H1D21T__ [10/11/20/21] L76	\$ 4,249.	68	VF24FDXLSWM__ [22/26/27/28]	\$ 2,629.	94
VB42H1D21T__ [10/11/20/21] N71	\$ 3,749.	68	VF24FDXNPWM__ [10/11/20/21]	\$ 1,749.	94
VB42H1D21T__ [10/11/20/21] N74	\$ 3,749.	68	VF24FDXNPWM__ [12/19/23/24/25]	\$ 2,829.	94
VB42H1D21T__ [10/11/20/21] N76	\$ 3,749.	68	VF24FDXNPWM__ [22/26/27/28]	\$ 2,279.	94
VB42H1D21T__ [10/11/20/21] S71	\$ 4,249.	68	VF24FDXNSWM__ [10/11/20/21]	\$ 1,749.	94
VB42H1D21T__ [10/11/20/21] S74	\$ 4,249.	68	VF24FDXNSWM__ [12/19/23/24/25]	\$ 2,829.	94
VB42H1D21T__ [10/11/20/21] S76	\$ 4,249.	68	VF24FDXNSWM__ [22/26/27/28]	\$ 2,279.	94
VB42H1D21T__ [12/19/23/24/25] L71	\$ 5,349.	68	VF24PDCLPWM__ [10/11/20/21]	\$ 2,079.	94
VB42H1D21T__ [12/19/23/24/25] L74	\$ 5,349.	68	VF24PDCLPWM__ [12/19/23/24/25]	\$ 3,149.	94
VB42H1D21T__ [12/19/23/24/25] L76	\$ 5,349.	68	VF24PDCLPWM__ [22/26/27/28]	\$ 2,629.	94
VB42H1D21T__ [12/19/23/24/25] N71	\$ 4,849.	68	VF24PDCLPWM__ [10/11/20/21]	\$ 2,079.	94
VB42H1D21T__ [12/19/23/24/25] N74	\$ 4,849.	68	VF24PDCLPWM__ [12/19/23/24/25]	\$ 3,149.	94
VB42H1D21T__ [12/19/23/24/25] N76	\$ 4,849.	68	VF24PDCLPWM__ [22/26/27/28]	\$ 2,629.	94
VB42H1D21T__ [12/19/23/24/25] S71	\$ 5,349.	68	VF24PDCNPWM__ [10/11/20/21]	\$ 1,749.	94
VB42H1D21T__ [12/19/23/24/25] S74	\$ 5,349.	68	VF24PDCNPWM__ [12/19/23/24/25]	\$ 2,829.	94
VB42H1D21T__ [12/19/23/24/25] S76	\$ 5,349.	68	VF24PDCNPWM__ [22/26/27/28]	\$ 2,279.	94
VB42H1D21T__ [22/26/27/28] L71	\$ 4,799.	68	VF24PDCNSWM__ [10/11/20/21]	\$ 1,749.	94
VB42H1D21T__ [22/26/27/28] L74	\$ 4,799.	68	VF24PDCNSWM__ [12/19/23/24/25]	\$ 2,829.	94
VB42H1D21T__ [22/26/27/28] L76	\$ 4,799.	68	VF24PDCNSWM__ [22/26/27/28]	\$ 2,279.	94
VB42H1D21T__ [22/26/27/28] N71	\$ 4,299.	68	VF30FDXLPWM__ [10/11/20/21]	\$ 2,679.	96
VB42H1D21T__ [22/26/27/28] N74	\$ 4,299.	68	VF30FDXLPWM__ [12/19/23/24/25]	\$ 3,749.	96
VB42H1D21T__ [22/26/27/28] N76	\$ 4,299.	68	VF30FDXLPWM__ [22/26/27/28]	\$ 3,199.	96
VB42H1D21T__ [22/26/27/28] S71	\$ 4,799.	68	VF30FDXLSWM__ [10/11/20/21]	\$ 2,679.	96
VB42H1D21T__ [22/26/27/28] S74	\$ 4,799.	68	VF30FDXLSWM__ [12/19/23/24/25]	\$ 3,749.	96
VB42H1D21T__ [22/26/27/28] S76	\$ 4,799.	68	VF30FDXLSWM__ [22/26/27/28]	\$ 3,199.	96
VB42H2D21P__ [10/11/20/21] L71	\$ 4,529.	68	VF30FDXNPWM__ [10/11/20/21]	\$ 2,279.	96
VB42H2D21P__ [10/11/20/21] L74	\$ 4,529.	68	VF30FDXNPWM__ [12/19/23/24/25]	\$ 3,379.	96
VB42H2D21P__ [10/11/20/21] L76	\$ 4,529.	68	VF30FDXNPWM__ [22/26/27/28]	\$ 2,829.	96
VB42H2D21P__ [10/11/20/21] N71	\$ 4,029.	68	VF30FDXNSWM__ [10/11/20/21]	\$ 2,279.	96
VB42H2D21P__ [10/11/20/21] N74	\$ 4,029.	68	VF30FDXNSWM__ [12/19/23/24/25]	\$ 3,379.	96
VB42H2D21P__ [10/11/20/21] N76	\$ 4,029.	68	VF30FDXNSWM__ [22/26/27/28]	\$ 2,829.	96
VB42H2D21P__ [10/11/20/21] S71	\$ 4,529.	68	VF30PDCLPWM__ [10/11/20/21]	\$ 2,679.	96
VB42H2D21P__ [10/11/20/21] S74	\$ 4,529.	68	VF30PDCLPWM__ [12/19/23/24/25]	\$ 3,749.	96
VB42H2D21P__ [10/11/20/21] S76	\$ 4,529.	68	VF30PDCLPWM__ [22/26/27/28]	\$ 3,199.	96
VB42H2D21P__ [12/19/23/24/25] L71	\$ 5,599.	68	VF30PDCLPWM__ [10/11/20/21]	\$ 2,679.	96
VB42H2D21P__ [12/19/23/24/25] L74	\$ 5,599.	68	VF30PDCLPWM__ [12/19/23/24/25]	\$ 3,749.	96
VB42H2D21P__ [12/19/23/24/25] L76	\$ 5,599.	68	VF30PDCLPWM__ [22/26/27/28]	\$ 3,199.	96
VB42H2D21P__ [12/19/23/24/25] N71	\$ 5,129.	68	VF30PDCNPWM__ [10/11/20/21]	\$ 2,279.	96
VB42H2D21P__ [12/19/23/24/25] N74	\$ 5,129.	68	VF30PDCNPWM__ [12/19/23/24/25]	\$ 3,379.	96
VB42H2D21P__ [12/19/23/24/25] N76	\$ 5,129.	68	VF30PDCNPWM__ [22/26/27/28]	\$ 2,829.	96

[] denotes Color/Pattern/Style options.

Model Number Price Index

Model Number	Price	Page	Model Number	Price	Page
VF30PDCNSWM__ [10/11/20/21]	\$ 2,279.	96	VF60PDCNPWM__ [10/11/20/21]	\$ 5,229.	102
VF30PDCNSWM__ [12/19/23/24/25]	\$ 3,379.	96	VF60PDCNPWM__ [12/19/23/24/25]	\$ 8,499.	102
VF30PDCNSWM__ [22/26/27/28]	\$ 2,829.	96	VF60PDCNPWM__ [22/26/27/28]	\$ 6,879.	102
VF36FDXLPWM__ [10/11/20/21]	\$ 3,279.	98	VF60PDCNSWM__ [10/11/20/21]	\$ 5,229.	102
VF36FDXLPWM__ [12/19/23/24/25]	\$ 4,349.	98	VF60PDCNSWM__ [12/19/23/24/25]	\$ 8,499.	102
VF36FDXLPWM__ [22/26/27/28]	\$ 3,799.	98	VF60PDCNSWM__ [22/26/27/28]	\$ 6,879.	102
VF36FDXLSWM__ [10/11/20/21]	\$ 3,279.	98	VFDRAWER12X	\$ 499.	267
VF36FDXLSWM__ [12/19/23/24/25]	\$ 4,349.	98	VFDRAWER24P	\$ 629.	267
VF36FDXLSWM__ [22/26/27/28]	\$ 3,799.	98	VFDRAWER24X	\$ 629.	267
VF36FDXNPWM__ [10/11/20/21]	\$ 2,829.	98	VFDRAWER30P	\$ 729.	267
VF36FDXNPWM__ [12/19/23/24/25]	\$ 3,929.	98	VFDRAWER30X	\$ 799.	267
VF36FDXNPWM__ [22/26/27/28]	\$ 3,379.	98	VFDRAWER36P	\$ 799.	267
VF36FDXNSWM__ [10/11/20/21]	\$ 2,829.	98	VFDRAWER36X	\$ 799.	267
VF36FDXNSWM__ [12/19/23/24/25]	\$ 3,929.	98	VFELECTRIC	\$ 449.	266
VF36FDXNSWM__ [22/26/27/28]	\$ 3,379.	98	VFGKIT	\$ 99.	269
VF36PDCLPWM__ [10/11/20/21]	\$ 3,279.	98	VFSK__ [10/11/20/21]	\$ 549.	270
VF36PDCLPWM__ [12/19/23/24/25]	\$ 4,349.	98	VFSK__ [12/19/23/24/25]	\$ 799.	270
VF36PDCLPWM__ [22/26/27/28]	\$ 3,799.	98	VFSK__ [22/26/27/28]	\$ 679.	270
VF36PDCLSWM__ [10/11/20/21]	\$ 3,279.	98	VFSTACK	\$ 99.	269
VF36PDCLSWM__ [12/19/23/24/25]	\$ 4,349.	98	VFSTACKA	\$ 279.	269
VF36PDCLSWM__ [22/26/27/28]	\$ 3,799.	98	VFSTACKL	\$ 179.	269
VF36PDCNPWM__ [10/11/20/21]	\$ 2,829.	98	VM1SKH1D18__ [10/11/20/21]	\$ 229.	270
VF36PDCNPWM__ [12/19/23/24/25]	\$ 3,929.	98	VM1SKH1D18__ [12/19/23/24/25]	\$ 329.	270
VF36PDCNPWM__ [22/26/27/28]	\$ 3,379.	98	VM1SKH1D18__ [22/26/27/28]	\$ 279.	270
VF36PDCNSWM__ [10/11/20/21]	\$ 2,829.	98	VM1SKH1D21__ [10/11/20/21]	\$ 229.	270
VF36PDCNSWM__ [12/19/23/24/25]	\$ 3,929.	98	VM1SKH1D21__ [12/19/23/24/25]	\$ 329.	270
VF36PDCNSWM__ [22/26/27/28]	\$ 3,379.	98	VM1SKH1D21__ [22/26/27/28]	\$ 279.	270
VF36PDLLPWM__ [10/11/20/21]	\$ 3,379.	98	VM1SKH2D18__ [10/11/20/21]	\$ 279.	270
VF36PDLLPWM__ [12/19/23/24/25]	\$ 5,549.	98	VM1SKH2D18__ [12/19/23/24/25]	\$ 399.	270
VF36PDLLPWM__ [22/26/27/28]	\$ 4,479.	98	VM1SKH2D18__ [22/26/27/28]	\$ 329.	270
VF36PDLLSWM__ [10/11/20/21]	\$ 3,379.	98	VM1SKH2D21__ [10/11/20/21]	\$ 279.	270
VF36PDLLSWM__ [12/19/23/24/25]	\$ 5,549.	98	VM1SKH2D21__ [12/19/23/24/25]	\$ 399.	270
VF36PDLLSWM__ [22/26/27/28]	\$ 4,479.	98	VM1SKH2D21__ [22/26/27/28]	\$ 329.	270
VF36PDLNPWM__ [10/11/20/21]	\$ 2,949.	98	VM1SKH3D18__ [10/11/20/21]	\$ 329.	270
VF36PDLNPWM__ [12/19/23/24/25]	\$ 5,129.	98	VM1SKH3D18__ [12/19/23/24/25]	\$ 449.	270
VF36PDLNPWM__ [22/26/27/28]	\$ 4,029.	98	VM1SKH3D18__ [22/26/27/28]	\$ 399.	270
VF36PDLNSWM__ [10/11/20/21]	\$ 2,949.	98	VM1SKH3D21__ [10/11/20/21]	\$ 329.	270
VF36PDLNSWM__ [12/19/23/24/25]	\$ 5,129.	98	VM1SKH3D21__ [12/19/23/24/25]	\$ 449.	270
VF36PDLNSWM__ [22/26/27/28]	\$ 4,029.	98	VM1SKH3D21__ [22/26/27/28]	\$ 399.	270
VF36PDRLPWM__ [10/11/20/21]	\$ 3,379.	98	VM1SKH4D18__ [10/11/20/21]	\$ 399.	270
VF36PDRLPWM__ [12/19/23/24/25]	\$ 5,549.	98	VM1SKH4D18__ [12/19/23/24/25]	\$ 499.	270
VF36PDRLPWM__ [22/26/27/28]	\$ 4,479.	98	VM1SKH4D18__ [22/26/27/28]	\$ 449.	270
VF36PDRLSWM__ [10/11/20/21]	\$ 3,379.	98	VM1SKH4D21__ [10/11/20/21]	\$ 399.	270
VF36PDRLSWM__ [12/19/23/24/25]	\$ 5,549.	98	VM1SKH4D21__ [12/19/23/24/25]	\$ 499.	270
VF36PDRLSWM__ [22/26/27/28]	\$ 4,479.	98	VM1SKH4D21__ [22/26/27/28]	\$ 449.	270
VF36PDRNPWM__ [10/11/20/21]	\$ 2,949.	98	VM2SKH1D18__ [10/11/20/21]	\$ 329.	270
VF36PDRNPWM__ [12/19/23/24/25]	\$ 5,129.	98	VM2SKH1D18__ [12/19/23/24/25]	\$ 549.	270
VF36PDRNPWM__ [22/26/27/28]	\$ 4,029.	98	VM2SKH1D18__ [22/26/27/28]	\$ 449.	270
VF36PDRNSWM__ [10/11/20/21]	\$ 2,949.	98	VM2SKH1D21__ [10/11/20/21]	\$ 329.	270
VF36PDRNSWM__ [12/19/23/24/25]	\$ 5,129.	98	VM2SKH1D21__ [12/19/23/24/25]	\$ 549.	270
VF36PDRNSWM__ [22/26/27/28]	\$ 4,029.	98	VM2SKH1D21__ [22/26/27/28]	\$ 449.	270
VF48PDCLPWM__ [10/11/20/21]	\$ 4,749.	100	VM2SKH2D18__ [10/11/20/21]	\$ 399.	270
VF48PDCLPWM__ [12/19/23/24/25]	\$ 7,999.	100	VM2SKH2D18__ [12/19/23/24/25]	\$ 629.	270
VF48PDCLPWM__ [22/26/27/28]	\$ 6,379.	100	VM2SKH2D18__ [22/26/27/28]	\$ 499.	270
VF48PDCLSWM__ [10/11/20/21]	\$ 4,749.	100	VM2SKH2D21__ [10/11/20/21]	\$ 399.	270
VF48PDCLSWM__ [12/19/23/24/25]	\$ 7,999.	100	VM2SKH2D21__ [12/19/23/24/25]	\$ 629.	270
VF48PDCLSWM__ [22/26/27/28]	\$ 6,379.	100	VM2SKH2D21__ [22/26/27/28]	\$ 499.	270
VF48PDCNPWM__ [10/11/20/21]	\$ 4,149.	100	VM2SKH3D18__ [10/11/20/21]	\$ 549.	270
VF48PDCNPWM__ [12/19/23/24/25]	\$ 7,399.	100	VM2SKH3D18__ [12/19/23/24/25]	\$ 799.	270
VF48PDCNPWM__ [22/26/27/28]	\$ 5,779.	100	VM2SKH3D18__ [22/26/27/28]	\$ 679.	270
VF48PDCNSWM__ [10/11/20/21]	\$ 4,149.	100	VM2SKH3D21__ [10/11/20/21]	\$ 549.	270
VF48PDCNSWM__ [12/19/23/24/25]	\$ 7,399.	100	VM2SKH3D21__ [12/19/23/24/25]	\$ 799.	270
VF48PDCNSWM__ [22/26/27/28]	\$ 5,779.	100	VM2SKH3D21__ [22/26/27/28]	\$ 679.	270
VF60PDCLPWM__ [10/11/20/21]	\$ 5,829.	102	VM2SKH3D21-58	\$ 1,199.	48
VF60PDCLPWM__ [12/19/23/24/25]	\$ 9,099.	102	VM2SKH3D21-59	\$ 1,199.	48
VF60PDCLPWM__ [22/26/27/28]	\$ 7,479.	102	VM2SKH4D18__ [10/11/20/21]	\$ 679.	270
VF60PDCLSWM__ [10/11/20/21]	\$ 5,829.	102	VM2SKH4D18__ [12/19/23/24/25]	\$ 899.	270
VF60PDCLSWM__ [12/19/23/24/25]	\$ 9,099.	102	VM2SKH4D18__ [22/26/27/28]	\$ 799.	270
VF60PDCLSWM__ [22/26/27/28]	\$ 7,479.	102	VM2SKH4D21__ [10/11/20/21]	\$ 679.	270
			VM2SKH4D21__ [12/19/23/24/25]	\$ 899.	270
			VM2SKH4D21__ [22/26/27/28]	\$ 799.	270

__ [] denotes Color/Pattern/Style options.

Model Number Price Index

Model Number	Price	Page	Model Number	Price	Page
VM12H1D18F__ [10/11/20/21]L	\$ 749.	112	VM24H1D21F__ [22/26/27/28]L	\$ 1,799.	116
VM12H1D18F__ [10/11/20/21]N	\$ 499.	112	VM24H1D21F__ [22/26/27/28]N	\$ 1,479.	116
VM12H1D18F__ [10/11/20/21]S	\$ 749.	112	VM24H1D21F__ [22/26/27/28]S	\$ 1,799.	116
VM12H1D18F__ [12/19/23/24/25]L	\$ 1,629.	112	VM24H1D21P__ [10/11/20/21]L	\$ 1,349.	116
VM12H1D18F__ [12/19/23/24/25]N	\$ 1,349.	112	VM24H1D21P__ [10/11/20/21]N	\$ 1,029.	116
VM12H1D18F__ [12/19/23/24/25]S	\$ 1,629.	112	VM24H1D21P__ [10/11/20/21]S	\$ 1,349.	116
VM12H1D18F__ [22/26/27/28]L	\$ 1,199.	112	VM24H1D21P__ [12/19/23/24/25]L	\$ 2,229.	116
VM12H1D18F__ [22/26/27/28]N	\$ 929.	112	VM24H1D21P__ [12/19/23/24/25]N	\$ 1,899.	116
VM12H1D18F__ [22/26/27/28]S	\$ 1,199.	112	VM24H1D21P__ [12/19/23/24/25]S	\$ 2,229.	116
VM12H1D21F__ [10/11/20/21]L	\$ 749.	112	VM24H1D21P__ [22/26/27/28]L	\$ 1,799.	116
VM12H1D21F__ [10/11/20/21]N	\$ 499.	112	VM24H1D21P__ [22/26/27/28]N	\$ 1,479.	116
VM12H1D21F__ [10/11/20/21]S	\$ 749.	112	VM24H1D21P__ [22/26/27/28]S	\$ 1,799.	116
VM12H1D21F__ [12/19/23/24/25]L	\$ 1,629.	112	VM24H1D21T__ [10/11/20/21]L	\$ 1,349.	116
VM12H1D21F__ [12/19/23/24/25]N	\$ 1,349.	112	VM24H1D21T__ [10/11/20/21]N	\$ 1,029.	116
VM12H1D21F__ [12/19/23/24/25]S	\$ 1,629.	112	VM24H1D21T__ [10/11/20/21]S	\$ 1,349.	116
VM12H1D21F__ [22/26/27/28]L	\$ 1,199.	112	VM24H1D21T__ [12/19/23/24/25]L	\$ 2,229.	116
VM12H1D21F__ [22/26/27/28]N	\$ 929.	112	VM24H1D21T__ [12/19/23/24/25]N	\$ 1,899.	116
VM12H1D21F__ [22/26/27/28]S	\$ 1,199.	112	VM24H1D21T__ [12/19/23/24/25]S	\$ 2,229.	116
VM12H2D18F__ [10/11/20/21]L	\$ 979.	112	VM24H1D21T__ [22/26/27/28]L	\$ 1,799.	116
VM12H2D18F__ [10/11/20/21]N	\$ 699.	112	VM24H1D21T__ [22/26/27/28]N	\$ 1,479.	116
VM12H2D18F__ [10/11/20/21]S	\$ 979.	112	VM24H1D21T__ [22/26/27/28]S	\$ 1,799.	116
VM12H2D18F__ [12/19/23/24/25]L	\$ 1,849.	112	VM24H2D18F__ [10/11/20/21]L	\$ 1,579.	114
VM12H2D18F__ [12/19/23/24/25]N	\$ 1,579.	112	VM24H2D18F__ [10/11/20/21]N	\$ 1,249.	114
VM12H2D18F__ [12/19/23/24/25]S	\$ 1,849.	112	VM24H2D18F__ [10/11/20/21]S	\$ 1,579.	114
VM12H2D18F__ [22/26/27/28]L	\$ 1,429.	112	VM24H2D18F__ [12/19/23/24/25]L	\$ 2,449.	114
VM12H2D18F__ [22/26/27/28]N	\$ 1,149.	112	VM24H2D18F__ [12/19/23/24/25]N	\$ 2,129.	114
VM12H2D18F__ [22/26/27/28]S	\$ 1,429.	112	VM24H2D18F__ [12/19/23/24/25]S	\$ 2,449.	114
VM12H2D21F__ [10/11/20/21]L	\$ 979.	112	VM24H2D18F__ [22/26/27/28]L	\$ 2,029.	114
VM12H2D21F__ [10/11/20/21]N	\$ 699.	112	VM24H2D18F__ [22/26/27/28]N	\$ 1,679.	114
VM12H2D21F__ [10/11/20/21]S	\$ 979.	112	VM24H2D18F__ [22/26/27/28]S	\$ 2,029.	114
VM12H2D21F__ [12/19/23/24/25]L	\$ 1,849.	112	VM24H2D18P__ [10/11/20/21]L	\$ 1,579.	114
VM12H2D21F__ [12/19/23/24/25]N	\$ 1,579.	112	VM24H2D18P__ [10/11/20/21]N	\$ 1,249.	114
VM12H2D21F__ [12/19/23/24/25]S	\$ 1,849.	112	VM24H2D18P__ [10/11/20/21]S	\$ 1,579.	114
VM12H2D21F__ [22/26/27/28]L	\$ 1,429.	112	VM24H2D18P__ [12/19/23/24/25]L	\$ 2,449.	114
VM12H2D21F__ [22/26/27/28]N	\$ 1,149.	112	VM24H2D18P__ [12/19/23/24/25]N	\$ 2,129.	114
VM12H2D21F__ [22/26/27/28]S	\$ 1,429.	112	VM24H2D18P__ [12/19/23/24/25]S	\$ 2,449.	114
VM24H1D18F__ [10/11/20/21]L	\$ 1,349.	114	VM24H2D18P__ [22/26/27/28]L	\$ 2,029.	114
VM24H1D18F__ [10/11/20/21]N	\$ 1,029.	114	VM24H2D18P__ [22/26/27/28]N	\$ 1,679.	114
VM24H1D18F__ [10/11/20/21]S	\$ 1,349.	114	VM24H2D18P__ [22/26/27/28]S	\$ 2,029.	114
VM24H1D18F__ [12/19/23/24/25]L	\$ 2,229.	114	VM24H2D18P__ [10/11/20/21]L	\$ 1,579.	116
VM24H1D18F__ [12/19/23/24/25]N	\$ 1,899.	114	VM24H2D21F__ [10/11/20/21]N	\$ 1,249.	116
VM24H1D18F__ [12/19/23/24/25]S	\$ 2,229.	114	VM24H2D21F__ [10/11/20/21]S	\$ 1,579.	116
VM24H1D18F__ [22/26/27/28]L	\$ 1,799.	114	VM24H2D21F__ [12/19/23/24/25]L	\$ 2,449.	116
VM24H1D18F__ [22/26/27/28]N	\$ 1,479.	114	VM24H2D21F__ [12/19/23/24/25]N	\$ 2,129.	116
VM24H1D18F__ [22/26/27/28]S	\$ 1,799.	114	VM24H2D21F__ [12/19/23/24/25]S	\$ 2,449.	116
VM24H1D18P__ [10/11/20/21]L	\$ 1,349.	114	VM24H2D21F__ [22/26/27/28]L	\$ 2,029.	116
VM24H1D18P__ [10/11/20/21]N	\$ 1,029.	114	VM24H2D21F__ [22/26/27/28]N	\$ 1,679.	116
VM24H1D18P__ [10/11/20/21]S	\$ 1,349.	114	VM24H2D21F__ [22/26/27/28]S	\$ 2,029.	116
VM24H1D18P__ [12/19/23/24/25]L	\$ 2,229.	114	VM24H2D21P__ [10/11/20/21]L	\$ 1,579.	116
VM24H1D18P__ [12/19/23/24/25]N	\$ 1,899.	114	VM24H2D21P__ [10/11/20/21]N	\$ 1,249.	116
VM24H1D18P__ [12/19/23/24/25]S	\$ 2,229.	114	VM24H2D21P__ [10/11/20/21]S	\$ 1,579.	116
VM24H1D18P__ [22/26/27/28]L	\$ 1,799.	114	VM24H2D21P__ [12/19/23/24/25]L	\$ 2,449.	116
VM24H1D18P__ [22/26/27/28]N	\$ 1,479.	114	VM24H2D21P__ [12/19/23/24/25]N	\$ 2,129.	116
VM24H1D18P__ [22/26/27/28]S	\$ 1,799.	114	VM24H2D21P__ [12/19/23/24/25]S	\$ 2,449.	116
VM24H1D18T__ [10/11/20/21]L	\$ 1,349.	114	VM24H2D21P__ [22/26/27/28]L	\$ 2,029.	116
VM24H1D18T__ [10/11/20/21]N	\$ 1,029.	114	VM24H2D21P__ [22/26/27/28]N	\$ 1,679.	116
VM24H1D18T__ [10/11/20/21]S	\$ 1,349.	114	VM24H2D21P__ [22/26/27/28]S	\$ 2,029.	116
VM24H1D18T__ [12/19/23/24/25]L	\$ 2,229.	114	VM30H1D18F__ [10/11/20/21]L	\$ 1,949.	118
VM24H1D18T__ [12/19/23/24/25]N	\$ 1,899.	114	VM30H1D18F__ [10/11/20/21]N	\$ 1,579.	118
VM24H1D18T__ [12/19/23/24/25]S	\$ 2,229.	114	VM30H1D18F__ [10/11/20/21]S	\$ 1,949.	118
VM24H1D18T__ [22/26/27/28]L	\$ 1,799.	114	VM30H1D18F__ [12/19/23/24/25]L	\$ 2,829.	118
VM24H1D18T__ [22/26/27/28]N	\$ 1,479.	114	VM30H1D18F__ [12/19/23/24/25]N	\$ 2,449.	118
VM24H1D18T__ [22/26/27/28]S	\$ 1,799.	114	VM30H1D18F__ [12/19/23/24/25]S	\$ 2,829.	118
VM24H1D21F__ [10/11/20/21]L	\$ 1,349.	116	VM30H1D18F__ [22/26/27/28]L	\$ 2,399.	118
VM24H1D21F__ [10/11/20/21]N	\$ 1,029.	116	VM30H1D18F__ [22/26/27/28]N	\$ 2,029.	118
VM24H1D21F__ [10/11/20/21]S	\$ 1,349.	116	VM30H1D18F__ [22/26/27/28]S	\$ 2,399.	118
VM24H1D21F__ [12/19/23/24/25]L	\$ 2,229.	116	VM30H1D18P__ [10/11/20/21]L	\$ 1,949.	118
VM24H1D21F__ [12/19/23/24/25]N	\$ 1,899.	116	VM30H1D18P__ [10/11/20/21]N	\$ 1,579.	118
VM24H1D21F__ [12/19/23/24/25]S	\$ 2,229.	116	VM30H1D18P__ [10/11/20/21]S	\$ 1,949.	118

__ [] denotes Color/Pattern/Style options.

Model Number Price Index

Model Number	Price	Page	Model Number	Price	Page
VM30H1D18P__ [12/19/23/24/25]L	\$ 2,829.	118	VM30H2D21P__ [10/11/20/21]L	\$ 2,179.	120
VM30H1D18P__ [12/19/23/24/25]N	\$ 2,449.	118	VM30H2D21P__ [10/11/20/21]N	\$ 1,799.	120
VM30H1D18P__ [12/19/23/24/25]S	\$ 2,829.	118	VM30H2D21P__ [10/11/20/21]S	\$ 2,179.	120
VM30H1D18P__ [22/26/27/28]L	\$ 2,399.	118	VM30H2D21P__ [12/19/23/24/25]L	\$ 3,049.	120
VM30H1D18P__ [22/26/27/28]N	\$ 2,029.	118	VM30H2D21P__ [12/19/23/24/25]N	\$ 2,679.	120
VM30H1D18P__ [22/26/27/28]S	\$ 2,399.	118	VM30H2D21P__ [12/19/23/24/25]S	\$ 3,049.	120
VM30H1D18T__ [10/11/20/21]L	\$ 1,949.	118	VM30H2D21P__ [22/26/27/28]L	\$ 2,629.	120
VM30H1D18T__ [10/11/20/21]N	\$ 1,579.	118	VM30H2D21P__ [22/26/27/28]N	\$ 2,229.	120
VM30H1D18T__ [10/11/20/21]S	\$ 1,949.	118	VM30H2D21P__ [22/26/27/28]S	\$ 2,629.	120
VM30H1D18T__ [12/19/23/24/25]L	\$ 2,829.	118	VM36H1D18F__ [10/11/20/21]L	\$ 2,549.	122
VM30H1D18T__ [12/19/23/24/25]N	\$ 2,449.	118	VM36H1D18F__ [10/11/20/21]N	\$ 2,129.	122
VM30H1D18T__ [12/19/23/24/25]S	\$ 2,829.	118	VM36H1D18F__ [10/11/20/21]S	\$ 2,549.	122
VM30H1D18T__ [22/26/27/28]L	\$ 2,399.	118	VM36H1D18F__ [12/19/23/24/25]L	\$ 3,429.	122
VM30H1D18T__ [22/26/27/28]N	\$ 2,029.	118	VM36H1D18F__ [12/19/23/24/25]N	\$ 2,999.	122
VM30H1D18T__ [22/26/27/28]S	\$ 2,399.	118	VM36H1D18F__ [12/19/23/24/25]S	\$ 3,429.	122
VM30H1D21F__ [10/11/20/21]L	\$ 1,949.	120	VM36H1D18F__ [22/26/27/28]L	\$ 2,999.	122
VM30H1D21F__ [10/11/20/21]N	\$ 1,579.	120	VM36H1D18F__ [22/26/27/28]N	\$ 2,549.	122
VM30H1D21F__ [10/11/20/21]S	\$ 1,949.	120	VM36H1D18F__ [22/26/27/28]S	\$ 2,999.	122
VM30H1D21F__ [12/19/23/24/25]L	\$ 2,829.	120	VM36H1D18P__ [10/11/20/21]L	\$ 2,549.	122
VM30H1D21F__ [12/19/23/24/25]N	\$ 2,449.	120	VM36H1D18P__ [10/11/20/21]N	\$ 2,129.	122
VM30H1D21F__ [12/19/23/24/25]S	\$ 2,829.	120	VM36H1D18P__ [10/11/20/21]S	\$ 2,549.	122
VM30H1D21F__ [22/26/27/28]L	\$ 2,399.	120	VM36H1D18P__ [12/19/23/24/25]L	\$ 3,429.	122
VM30H1D21F__ [22/26/27/28]N	\$ 2,029.	120	VM36H1D18P__ [12/19/23/24/25]N	\$ 2,999.	122
VM30H1D21F__ [22/26/27/28]S	\$ 2,399.	120	VM36H1D18P__ [12/19/23/24/25]S	\$ 3,429.	122
VM30H1D21P__ [10/11/20/21]L	\$ 1,949.	120	VM36H1D18P__ [22/26/27/28]L	\$ 2,999.	122
VM30H1D21P__ [10/11/20/21]N	\$ 1,579.	120	VM36H1D18P__ [22/26/27/28]N	\$ 2,549.	122
VM30H1D21P__ [10/11/20/21]S	\$ 1,949.	120	VM36H1D18P__ [22/26/27/28]S	\$ 2,999.	122
VM30H1D21P__ [12/19/23/24/25]L	\$ 2,829.	120	VM36H1D18T__ [10/11/20/21]L	\$ 2,549.	122
VM30H1D21P__ [12/19/23/24/25]N	\$ 2,449.	120	VM36H1D18T__ [10/11/20/21]N	\$ 2,129.	122
VM30H1D21P__ [12/19/23/24/25]S	\$ 2,829.	120	VM36H1D18T__ [10/11/20/21]S	\$ 2,549.	122
VM30H1D21P__ [22/26/27/28]L	\$ 2,399.	120	VM36H1D18T__ [12/19/23/24/25]L	\$ 3,429.	122
VM30H1D21P__ [22/26/27/28]N	\$ 2,029.	120	VM36H1D18T__ [12/19/23/24/25]N	\$ 2,999.	122
VM30H1D21P__ [22/26/27/28]S	\$ 2,399.	120	VM36H1D18T__ [12/19/23/24/25]S	\$ 3,429.	122
VM30H1D21T__ [10/11/20/21]L	\$ 1,949.	120	VM36H1D18T__ [22/26/27/28]L	\$ 2,999.	122
VM30H1D21T__ [10/11/20/21]N	\$ 1,579.	120	VM36H1D18T__ [22/26/27/28]N	\$ 2,549.	122
VM30H1D21T__ [10/11/20/21]S	\$ 1,949.	120	VM36H1D18T__ [22/26/27/28]S	\$ 2,999.	122
VM30H1D21T__ [12/19/23/24/25]L	\$ 2,829.	120	VM36H1D21F__ [10/11/20/21]L	\$ 2,549.	124
VM30H1D21T__ [12/19/23/24/25]N	\$ 2,449.	120	VM36H1D21F__ [10/11/20/21]N	\$ 2,129.	124
VM30H1D21T__ [12/19/23/24/25]S	\$ 2,829.	120	VM36H1D21F__ [10/11/20/21]S	\$ 2,549.	124
VM30H1D21T__ [22/26/27/28]L	\$ 2,399.	120	VM36H1D21F__ [12/19/23/24/25]L	\$ 3,429.	124
VM30H1D21T__ [22/26/27/28]N	\$ 2,029.	120	VM36H1D21F__ [12/19/23/24/25]N	\$ 2,999.	124
VM30H1D21T__ [22/26/27/28]S	\$ 2,399.	120	VM36H1D21F__ [12/19/23/24/25]S	\$ 3,429.	124
VM30H2D18F__ [10/11/20/21]L	\$ 2,179.	118	VM36H1D21F__ [22/26/27/28]L	\$ 2,999.	124
VM30H2D18F__ [10/11/20/21]N	\$ 1,799.	118	VM36H1D21F__ [22/26/27/28]N	\$ 2,549.	124
VM30H2D18F__ [10/11/20/21]S	\$ 2,179.	118	VM36H1D21F__ [22/26/27/28]S	\$ 2,999.	124
VM30H2D18F__ [12/19/23/24/25]L	\$ 3,049.	118	VM36H1D21P__ [10/11/20/21]L	\$ 2,549.	124
VM30H2D18F__ [12/19/23/24/25]N	\$ 2,679.	118	VM36H1D21P__ [10/11/20/21]N	\$ 2,129.	124
VM30H2D18F__ [12/19/23/24/25]S	\$ 3,049.	118	VM36H1D21P__ [10/11/20/21]S	\$ 2,549.	124
VM30H2D18F__ [22/26/27/28]L	\$ 2,629.	118	VM36H1D21P__ [12/19/23/24/25]L	\$ 3,429.	124
VM30H2D18F__ [22/26/27/28]N	\$ 2,229.	118	VM36H1D21P__ [12/19/23/24/25]N	\$ 2,999.	124
VM30H2D18F__ [22/26/27/28]S	\$ 2,629.	118	VM36H1D21P__ [12/19/23/24/25]S	\$ 3,429.	124
VM30H2D18P__ [10/11/20/21]L	\$ 2,179.	118	VM36H1D21P__ [22/26/27/28]L	\$ 2,999.	124
VM30H2D18P__ [10/11/20/21]N	\$ 1,799.	118	VM36H1D21P__ [22/26/27/28]N	\$ 2,549.	124
VM30H2D18P__ [10/11/20/21]S	\$ 2,179.	118	VM36H1D21P__ [22/26/27/28]S	\$ 2,999.	124
VM30H2D18P__ [12/19/23/24/25]L	\$ 3,049.	118	VM36H1D21T__ [10/11/20/21]L	\$ 2,549.	124
VM30H2D18P__ [12/19/23/24/25]N	\$ 2,679.	118	VM36H1D21T__ [10/11/20/21]N	\$ 2,129.	124
VM30H2D18P__ [12/19/23/24/25]S	\$ 3,049.	118	VM36H1D21T__ [10/11/20/21]S	\$ 2,549.	124
VM30H2D18P__ [22/26/27/28]L	\$ 2,629.	118	VM36H1D21T__ [12/19/23/24/25]L	\$ 3,429.	124
VM30H2D18P__ [22/26/27/28]N	\$ 2,229.	118	VM36H1D21T__ [12/19/23/24/25]N	\$ 2,999.	124
VM30H2D18P__ [22/26/27/28]S	\$ 2,629.	118	VM36H1D21T__ [12/19/23/24/25]S	\$ 3,429.	124
VM30H2D21F__ [10/11/20/21]L	\$ 2,179.	120	VM36H1D21T__ [22/26/27/28]L	\$ 2,999.	124
VM30H2D21F__ [10/11/20/21]N	\$ 1,799.	120	VM36H1D21T__ [22/26/27/28]N	\$ 2,549.	124
VM30H2D21F__ [10/11/20/21]S	\$ 2,179.	120	VM36H1D21T__ [22/26/27/28]S	\$ 2,999.	124
VM30H2D21F__ [12/19/23/24/25]L	\$ 3,049.	120	VM36H2D18F__ [10/11/20/21]L	\$ 2,779.	122
VM30H2D21F__ [12/19/23/24/25]N	\$ 2,679.	120	VM36H2D18F__ [10/11/20/21]N	\$ 2,349.	122
VM30H2D21F__ [12/19/23/24/25]S	\$ 3,049.	120	VM36H2D18F__ [10/11/20/21]S	\$ 2,779.	122
VM30H2D21F__ [22/26/27/28]L	\$ 2,629.	120	VM36H2D18F__ [12/19/23/24/25]L	\$ 3,649.	122
VM30H2D21F__ [22/26/27/28]N	\$ 2,229.	120	VM36H2D18F__ [12/19/23/24/25]N	\$ 3,199.	122
VM30H2D21F__ [22/26/27/28]S	\$ 2,629.	120	VM36H2D18F__ [12/19/23/24/25]S	\$ 3,649.	122

__ [] denotes Color/Pattern/Style options.

Model Number Price Index

Model Number	Price	Page	Model Number	Price	Page
VM36H2D18F__ [22/26/27/28]L	\$ 3,199.	122	VP12H1D21F__ [10/11/20/21]N83	\$ 829.	74
VM36H2D18F__ [22/26/27/28]N	\$ 2,779.	122	VP12H1D21F__ [12/19/23]N83	\$ 1,679.	74
VM36H2D18F__ [22/26/27/28]S	\$ 3,199.	122	VP12H1D21F__ [22/26/27/28]N83	\$ 1,249.	74
VM36H2D18P__ [10/11/20/21]L	\$ 2,779.	122	VP12H1D21F__ [10/11/20/21]S76	\$ 979.	74
VM36H2D18P__ [10/11/20/21]N	\$ 2,349.	122	VP12H1D21F__ [12/19/23]S76	\$ 1,849.	74
VM36H2D18P__ [10/11/20/21]S	\$ 2,779.	122	VP12H1D21F__ [22/26/27/28]S76	\$ 1,429.	74
VM36H2D18P__ [12/19/23/24/25]L	\$ 3,649.	122	VP12H1D21F__ [10/11/20/21]S77	\$ 979.	74
VM36H2D18P__ [12/19/23/24/25]N	\$ 3,199.	122	VP12H1D21F__ [12/19/23]S77	\$ 1,849.	74
VM36H2D18P__ [12/19/23/24/25]S	\$ 3,649.	122	VP12H1D21F__ [22/26/27/28]S77	\$ 1,429.	74
VM36H2D18P__ [22/26/27/28]L	\$ 3,199.	122	VP12H1D21F__ [10/11/20/21]S82	\$ 1,099.	74
VM36H2D18P__ [22/26/27/28]N	\$ 2,779.	122	VP12H1D21F__ [12/19/23]S82	\$ 1,949.	74
VM36H2D18P__ [22/26/27/28]S	\$ 3,199.	122	VP12H1D21F__ [22/26/27/28]S82	\$ 1,529.	74
VM36H2D21F__ [10/11/20/21]L	\$ 2,779.	124	VP12H1D21F__ [10/11/20/21]S83	\$ 1,099.	74
VM36H2D21F__ [10/11/20/21]N	\$ 2,349.	124	VP12H1D21F__ [12/19/23]S83	\$ 1,949.	74
VM36H2D21F__ [10/11/20/21]S	\$ 2,779.	124	VP12H1D21F__ [22/26/27/28]S83	\$ 1,529.	74
VM36H2D21F__ [12/19/23/24/25]L	\$ 3,649.	124	VP12H2D18F__ [10/11/20/21]N76	\$ 929.	74
VM36H2D21F__ [12/19/23/24/25]N	\$ 3,199.	124	VP12H2D18F__ [12/19/23]N76	\$ 1,799.	74
VM36H2D21F__ [12/19/23/24/25]S	\$ 3,649.	124	VP12H2D18F__ [22/26/27/28]N76	\$ 1,349.	74
VM36H2D21F__ [22/26/27/28]L	\$ 3,199.	124	VP12H2D18F__ [10/11/20/21]N77	\$ 929.	74
VM36H2D21F__ [22/26/27/28]N	\$ 2,779.	124	VP12H2D18F__ [12/19/23]N77	\$ 1,799.	74
VM36H2D21F__ [22/26/27/28]S	\$ 3,199.	124	VP12H2D18F__ [22/26/27/28]N77	\$ 1,349.	74
VM36H2D21P__ [10/11/20/21]L	\$ 2,779.	124	VP12H2D18F__ [10/11/20/21]N82	\$ 1,029.	74
VM36H2D21P__ [10/11/20/21]N	\$ 2,349.	124	VP12H2D18F__ [12/19/23]N82	\$ 1,899.	74
VM36H2D21P__ [10/11/20/21]S	\$ 2,779.	124	VP12H2D18F__ [22/26/27/28]N82	\$ 1,479.	74
VM36H2D21P__ [12/19/23/24/25]L	\$ 3,649.	124	VP12H2D18F__ [10/11/20/21]N83	\$ 1,029.	74
VM36H2D21P__ [12/19/23/24/25]N	\$ 3,199.	124	VP12H2D18F__ [12/19/23]N83	\$ 1,899.	74
VM36H2D21P__ [12/19/23/24/25]S	\$ 3,649.	124	VP12H2D18F__ [22/26/27/28]N83	\$ 1,479.	74
VM36H2D21P__ [22/26/27/28]L	\$ 3,199.	124	VP12H2D18F__ [10/11/20/21]S76	\$ 1,199.	74
VM36H2D21P__ [22/26/27/28]N	\$ 2,779.	124	VP12H2D18F__ [12/19/23]S76	\$ 2,079.	74
VM36H2D21P__ [22/26/27/28]S	\$ 3,199.	124	VP12H2D18F__ [22/26/27/28]S76	\$ 1,629.	74
VMAKITH1	\$ 99.	269	VP12H2D18F__ [10/11/20/21]S77	\$ 1,199.	74
VMAKITH2	\$ 99.	269	VP12H2D18F__ [12/19/23]S77	\$ 2,079.	74
VMAKITH3	\$ 229.	269	VP12H2D18F__ [22/26/27/28]S77	\$ 1,629.	74
VMAKITH4	\$ 229.	269	VP12H2D18F__ [10/11/20/21]S82	\$ 1,299.	74
VMGKITH1	\$ 99.	269	VP12H2D18F__ [12/19/23]S82	\$ 2,179.	74
VMGKITH2	\$ 99.	269	VP12H2D18F__ [22/26/27/28]S82	\$ 1,749.	74
VMGKITH3	\$ 229.	269	VP12H2D18F__ [10/11/20/21]S83	\$ 1,299.	74
VMGKITH4	\$ 229.	269	VP12H2D18F__ [12/19/23]S83	\$ 2,179.	74
VP12H1D18F__ [10/11/20/21]N76	\$ 699.	74	VP12H2D18F__ [22/26/27/28]S83	\$ 1,749.	74
VP12H1D18F__ [12/19/23]N76	\$ 1,579.	74	VP12H2D21F__ [10/11/20/21]N76	\$ 929.	74
VP12H1D18F__ [22/26/27/28]N76	\$ 1,149.	74	VP12H2D21F__ [12/19/23]N76	\$ 1,799.	74
VP12H1D18F__ [10/11/20/21]N77	\$ 699.	74	VP12H2D21F__ [22/26/27/28]N76	\$ 1,349.	74
VP12H1D18F__ [12/19/23]N77	\$ 1,579.	74	VP12H2D21F__ [10/11/20/21]N77	\$ 929.	74
VP12H1D18F__ [22/26/27/28]N77	\$ 1,149.	74	VP12H2D21F__ [12/19/23]N77	\$ 1,799.	74
VP12H1D18F__ [10/11/20/21]N82	\$ 829.	74	VP12H2D21F__ [22/26/27/28]N77	\$ 1,349.	74
VP12H1D18F__ [12/19/23]N82	\$ 1,679.	74	VP12H2D21F__ [10/11/20/21]N82	\$ 1,029.	74
VP12H1D18F__ [22/26/27/28]N82	\$ 1,249.	74	VP12H2D21F__ [12/19/23]N82	\$ 1,899.	74
VP12H1D18F__ [10/11/20/21]N83	\$ 829.	74	VP12H2D21F__ [22/26/27/28]N82	\$ 1,479.	74
VP12H1D18F__ [12/19/23]N83	\$ 1,679.	74	VP12H2D21F__ [10/11/20/21]N83	\$ 1,029.	74
VP12H1D18F__ [22/26/27/28]N83	\$ 1,249.	74	VP12H2D21F__ [12/19/23]N83	\$ 1,899.	74
VP12H1D18F__ [10/11/20/21]S76	\$ 979.	74	VP12H2D21F__ [22/26/27/28]N83	\$ 1,479.	74
VP12H1D18F__ [12/19/23]S76	\$ 1,849.	74	VP12H2D21F__ [10/11/20/21]S76	\$ 1,199.	74
VP12H1D18F__ [22/26/27/28]S76	\$ 1,429.	74	VP12H2D21F__ [12/19/23]S76	\$ 2,079.	74
VP12H1D18F__ [10/11/20/21]S77	\$ 979.	74	VP12H2D21F__ [22/26/27/28]S76	\$ 1,629.	74
VP12H1D18F__ [12/19/23]S77	\$ 1,849.	74	VP12H2D21F__ [10/11/20/21]S77	\$ 1,199.	74
VP12H1D18F__ [22/26/27/28]S77	\$ 1,429.	74	VP12H2D21F__ [12/19/23]S77	\$ 2,079.	74
VP12H1D18F__ [10/11/20/21]S82	\$ 1,099.	74	VP12H2D21F__ [22/26/27/28]S77	\$ 1,629.	74
VP12H1D18F__ [12/19/23]S82	\$ 1,949.	74	VP12H2D21F__ [10/11/20/21]S82	\$ 1,299.	74
VP12H1D18F__ [22/26/27/28]S82	\$ 1,529.	74	VP12H2D21F__ [12/19/23]S82	\$ 2,179.	74
VP12H1D18F__ [10/11/20/21]S83	\$ 1,099.	74	VP12H2D21F__ [22/26/27/28]S82	\$ 1,749.	74
VP12H1D18F__ [12/19/23]S83	\$ 1,949.	74	VP12H2D21F__ [10/11/20/21]S83	\$ 1,299.	74
VP12H1D18F__ [22/26/27/28]S83	\$ 1,529.	74	VP12H2D21F__ [12/19/23]S83	\$ 2,179.	74
VP12H1D21F__ [10/11/20/21]N76	\$ 699.	74	VP12H2D21F__ [22/26/27/28]S83	\$ 1,749.	74
VP12H1D21F__ [12/19/23]N76	\$ 1,579.	74	VP12H2D21F__ [10/11/20/21]N76	\$ 929.	74
VP12H1D21F__ [22/26/27/28]N76	\$ 1,149.	74	VP24H1D18F__ [10/11/20/21]N76	\$ 1,249.	76
VP12H1D21F__ [10/11/20/21]N77	\$ 699.	74	VP24H1D18F__ [12/19/23]N76	\$ 2,129.	76
VP12H1D21F__ [12/19/23]N77	\$ 1,579.	74	VP24H1D18F__ [22/26/27/28]N76	\$ 1,679.	76
VP12H1D21F__ [22/26/27/28]N77	\$ 1,149.	74	VP24H1D18F__ [10/11/20/21]N77	\$ 1,249.	76
VP12H1D21F__ [10/11/20/21]N82	\$ 829.	74	VP24H1D18F__ [12/19/23]N77	\$ 2,129.	76
VP12H1D21F__ [12/19/23]N82	\$ 1,679.	74	VP24H1D18F__ [22/26/27/28]N77	\$ 1,679.	76
VP12H1D21F__ [22/26/27/28]N82	\$ 1,249.	74			

__ [] denotes Color/Pattern/Style options.

Model Number Price Index

Model Number	Price	Page	Model Number	Price	Page
VP30H1D18P__ [10/11/20/21] S82	\$ 2,279.	80	VP30H1D21P__ [10/11/20/21] S77	\$ 2,179.	82
VP30H1D18P__ [12/19/23] S82	\$ 3,149.	80	VP30H1D21P__ [12/19/23] S77	\$ 3,049.	82
VP30H1D18P__ [22/26/27/28] S82	\$ 2,729.	80	VP30H1D21P__ [22/26/27/28] S77	\$ 2,629.	82
VP30H1D18P__ [10/11/20/21] S83	\$ 2,279.	80	VP30H1D21P__ [10/11/20/21] S82	\$ 2,279.	82
VP30H1D18P__ [12/19/23] S83	\$ 3,149.	80	VP30H1D21P__ [12/19/23] S82	\$ 3,149.	82
VP30H1D18P__ [22/26/27/28] S83	\$ 2,729.	80	VP30H1D21P__ [22/26/27/28] S82	\$ 2,729.	82
VP30H1D18T__ [10/11/20/21] N76	\$ 1,799.	80	VP30H1D21P__ [10/11/20/21] S83	\$ 2,279.	82
VP30H1D18T__ [12/19/23] N76	\$ 2,679.	80	VP30H1D21P__ [12/19/23] S83	\$ 3,149.	82
VP30H1D18T__ [22/26/27/28] N76	\$ 2,229.	80	VP30H1D21P__ [22/26/27/28] S83	\$ 2,729.	82
VP30H1D18T__ [10/11/20/21] N77	\$ 1,799.	80	VP30H1D21T__ [10/11/20/21] N76	\$ 1,799.	82
VP30H1D18T__ [12/19/23] N77	\$ 2,679.	80	VP30H1D21T__ [12/19/23] N76	\$ 2,679.	82
VP30H1D18T__ [22/26/27/28] N77	\$ 2,229.	80	VP30H1D21T__ [22/26/27/28] N76	\$ 2,229.	82
VP30H1D18T__ [10/11/20/21] N82	\$ 1,899.	80	VP30H1D21T__ [10/11/20/21] N77	\$ 1,799.	82
VP30H1D18T__ [12/19/23] N82	\$ 2,779.	80	VP30H1D21T__ [12/19/23] N77	\$ 2,679.	82
VP30H1D18T__ [22/26/27/28] N82	\$ 2,349.	80	VP30H1D21T__ [22/26/27/28] N77	\$ 2,229.	82
VP30H1D18T__ [10/11/20/21] N83	\$ 1,899.	80	VP30H1D21T__ [10/11/20/21] N82	\$ 1,899.	82
VP30H1D18T__ [12/19/23] N83	\$ 2,779.	80	VP30H1D21T__ [12/19/23] N82	\$ 2,779.	82
VP30H1D18T__ [22/26/27/28] N83	\$ 2,349.	80	VP30H1D21T__ [22/26/27/28] N82	\$ 2,349.	82
VP30H1D18T__ [10/11/20/21] S76	\$ 2,179.	80	VP30H1D21T__ [10/11/20/21] N83	\$ 1,899.	82
VP30H1D18T__ [12/19/23] S76	\$ 3,049.	80	VP30H1D21T__ [12/19/23] N83	\$ 2,779.	82
VP30H1D18T__ [22/26/27/28] S76	\$ 2,629.	80	VP30H1D21T__ [22/26/27/28] N83	\$ 2,349.	82
VP30H1D18T__ [10/11/20/21] S77	\$ 2,179.	80	VP30H1D21T__ [10/11/20/21] S76	\$ 2,179.	82
VP30H1D18T__ [12/19/23] S77	\$ 3,049.	80	VP30H1D21T__ [12/19/23] S76	\$ 3,049.	82
VP30H1D18T__ [22/26/27/28] S77	\$ 2,629.	80	VP30H1D21T__ [22/26/27/28] S76	\$ 2,629.	82
VP30H1D18T__ [10/11/20/21] S82	\$ 2,279.	80	VP30H1D21T__ [10/11/20/21] S77	\$ 2,179.	82
VP30H1D18T__ [12/19/23] S82	\$ 3,149.	80	VP30H1D21T__ [12/19/23] S77	\$ 3,049.	82
VP30H1D18T__ [22/26/27/28] S82	\$ 2,729.	80	VP30H1D21T__ [22/26/27/28] S77	\$ 2,629.	82
VP30H1D18T__ [10/11/20/21] S83	\$ 2,279.	80	VP30H1D21T__ [10/11/20/21] S82	\$ 2,279.	82
VP30H1D18T__ [12/19/23] S83	\$ 3,149.	80	VP30H1D21T__ [12/19/23] S82	\$ 3,149.	82
VP30H1D18T__ [22/26/27/28] S83	\$ 2,729.	80	VP30H1D21T__ [22/26/27/28] S82	\$ 2,729.	82
VP30H1D21F__ [10/11/20/21] N76	\$ 1,799.	82	VP30H1D21T__ [10/11/20/21] S83	\$ 2,279.	82
VP30H1D21F__ [12/19/23] N76	\$ 2,679.	82	VP30H1D21T__ [12/19/23] S83	\$ 3,149.	82
VP30H1D21F__ [22/26/27/28] N76	\$ 2,229.	82	VP30H1D21T__ [22/26/27/28] S83	\$ 2,729.	82
VP30H1D21F__ [10/11/20/21] N77	\$ 1,799.	82	VP30H1D21T58S82	\$ 3,399.	48
VP30H1D21F__ [12/19/23] N77	\$ 2,679.	82	VP30H1D21T59S83	\$ 3,399.	48
VP30H1D21F__ [22/26/27/28] N77	\$ 2,229.	82	VP30H2D18F__ [10/11/20/21] N76	\$ 2,029.	80
VP30H1D21F__ [10/11/20/21] N82	\$ 1,899.	82	VP30H2D18F__ [12/19/23] N76	\$ 2,879.	80
VP30H1D21F__ [12/19/23] N82	\$ 2,779.	82	VP30H2D18F__ [22/26/27/28] N76	\$ 2,449.	80
VP30H1D21F__ [22/26/27/28] N82	\$ 2,349.	82	VP30H2D18F__ [10/11/20/21] N77	\$ 2,029.	80
VP30H1D21F__ [10/11/20/21] N83	\$ 1,899.	82	VP30H2D18F__ [12/19/23] N77	\$ 2,879.	80
VP30H1D21F__ [12/19/23] N83	\$ 2,779.	82	VP30H2D18F__ [22/26/27/28] N77	\$ 2,449.	80
VP30H1D21F__ [22/26/27/28] N83	\$ 2,349.	82	VP30H2D18F__ [10/11/20/21] N82	\$ 2,129.	80
VP30H1D21F__ [10/11/20/21] S76	\$ 2,179.	82	VP30H2D18F__ [12/19/23] N82	\$ 2,999.	80
VP30H1D21F__ [12/19/23] S76	\$ 3,049.	82	VP30H2D18F__ [22/26/27/28] N82	\$ 2,549.	80
VP30H1D21F__ [22/26/27/28] S76	\$ 2,629.	82	VP30H2D18F__ [10/11/20/21] N83	\$ 2,129.	80
VP30H1D21F__ [10/11/20/21] S77	\$ 2,179.	82	VP30H2D18F__ [12/19/23] N83	\$ 2,999.	80
VP30H1D21F__ [12/19/23] S77	\$ 3,049.	82	VP30H2D18F__ [22/26/27/28] N83	\$ 2,549.	80
VP30H1D21F__ [22/26/27/28] S77	\$ 2,629.	82	VP30H2D18F__ [10/11/20/21] S76	\$ 2,399.	80
VP30H1D21F__ [10/11/20/21] S82	\$ 2,279.	82	VP30H2D18F__ [12/19/23] S76	\$ 3,279.	80
VP30H1D21F__ [12/19/23] S82	\$ 3,149.	82	VP30H2D18F__ [22/26/27/28] S76	\$ 2,829.	80
VP30H1D21F__ [22/26/27/28] S82	\$ 2,729.	82	VP30H2D18F__ [10/11/20/21] S77	\$ 2,399.	80
VP30H1D21F__ [10/11/20/21] S83	\$ 2,279.	82	VP30H2D18F__ [12/19/23] S77	\$ 3,279.	80
VP30H1D21F__ [12/19/23] S83	\$ 3,149.	82	VP30H2D18F__ [22/26/27/28] S77	\$ 2,829.	80
VP30H1D21F__ [22/26/27/28] S83	\$ 2,729.	82	VP30H2D18F__ [10/11/20/21] S82	\$ 2,499.	80
VP30H1D21P__ [10/11/20/21] N76	\$ 1,799.	82	VP30H2D18F__ [12/19/23] S82	\$ 3,379.	80
VP30H1D21P__ [12/19/23] N76	\$ 2,679.	82	VP30H2D18F__ [22/26/27/28] S82	\$ 2,949.	80
VP30H1D21P__ [22/26/27/28] N76	\$ 2,229.	82	VP30H2D18F__ [10/11/20/21] S83	\$ 2,499.	80
VP30H1D21P__ [10/11/20/21] N77	\$ 1,799.	82	VP30H2D18F__ [12/19/23] S83	\$ 3,379.	80
VP30H1D21P__ [12/19/23] N77	\$ 2,679.	82	VP30H2D18F__ [22/26/27/28] S83	\$ 2,949.	80
VP30H1D21P__ [22/26/27/28] N77	\$ 2,229.	82	VP30H2D18P__ [10/11/20/21] N76	\$ 2,029.	80
VP30H1D21P__ [10/11/20/21] N82	\$ 1,899.	82	VP30H2D18P__ [12/19/23] N76	\$ 2,879.	80
VP30H1D21P__ [12/19/23] N82	\$ 2,779.	82	VP30H2D18P__ [22/26/27/28] N76	\$ 2,449.	80
VP30H1D21P__ [22/26/27/28] N82	\$ 2,349.	82	VP30H2D18P__ [10/11/20/21] N77	\$ 2,029.	80
VP30H1D21P__ [10/11/20/21] N83	\$ 1,899.	82	VP30H2D18P__ [12/19/23] N77	\$ 2,879.	80
VP30H1D21P__ [12/19/23] N83	\$ 2,779.	82	VP30H2D18P__ [22/26/27/28] N77	\$ 2,449.	80
VP30H1D21P__ [22/26/27/28] N83	\$ 2,349.	82	VP30H2D18P__ [10/11/20/21] N82	\$ 2,129.	80
VP30H1D21P__ [10/11/20/21] S76	\$ 2,179.	82	VP30H2D18P__ [12/19/23] N82	\$ 2,999.	80
VP30H1D21P__ [12/19/23] S76	\$ 3,049.	82	VP30H2D18P__ [22/26/27/28] N82	\$ 2,549.	80
VP30H1D21P__ [22/26/27/28] S76	\$ 2,629.	82	VP30H2D18P__ [10/11/20/21] N83	\$ 2,129.	80
			VP30H2D18P__ [12/19/23] N83	\$ 2,999.	80
			VP30H2D18P__ [22/26/27/28] N83	\$ 2,549.	80

__ [] denotes Color/Pattern/Style options.

Model Number Price Index

Model Number	Price	Page	Model Number	Price	Page
VP30H2D18P__ [10/11/20/21]S76	\$ 2,399.	80	VP36H1D18F__ [10/11/20/21]N83	\$ 2,449.	84
VP30H2D18P__ [12/19/23]S76	\$ 3,279.	80	VP36H1D18F__ [12/19/23]N83	\$ 3,329.	84
VP30H2D18P__ [22/26/27/28]S76	\$ 2,829.	80	VP36H1D18F__ [22/26/27/28]N83	\$ 2,879.	84
VP30H2D18P__ [10/11/20/21]S77	\$ 2,399.	80	VP36H1D18F__ [10/11/20/21]S76	\$ 2,779.	84
VP30H2D18P__ [12/19/23]S77	\$ 3,279.	80	VP36H1D18F__ [12/19/23]S76	\$ 3,649.	84
VP30H2D18P__ [22/26/27/28]S77	\$ 2,829.	80	VP36H1D18F__ [22/26/27/28]S76	\$ 3,199.	84
VP30H2D18P__ [10/11/20/21]S82	\$ 2,499.	80	VP36H1D18F__ [10/11/20/21]S77	\$ 2,779.	84
VP30H2D18P__ [12/19/23]S82	\$ 3,379.	80	VP36H1D18F__ [12/19/23]S77	\$ 3,649.	84
VP30H2D18P__ [22/26/27/28]S82	\$ 2,949.	80	VP36H1D18F__ [22/26/27/28]S77	\$ 3,199.	84
VP30H2D18P__ [10/11/20/21]S83	\$ 2,499.	80	VP36H1D18F__ [10/11/20/21]S82	\$ 2,879.	84
VP30H2D18P__ [12/19/23]S83	\$ 3,379.	80	VP36H1D18F__ [12/19/23]S82	\$ 3,749.	84
VP30H2D18P__ [22/26/27/28]S83	\$ 2,949.	80	VP36H1D18F__ [22/26/27/28]S82	\$ 3,329.	84
VP30H2D21F__ [10/11/20/21]N76	\$ 2,029.	82	VP36H1D18F__ [10/11/20/21]S83	\$ 2,879.	84
VP30H2D21F__ [12/19/23]N76	\$ 2,879.	82	VP36H1D18F__ [12/19/23]S83	\$ 3,749.	84
VP30H2D21F__ [22/26/27/28]N76	\$ 2,449.	82	VP36H1D18F__ [22/26/27/28]S83	\$ 3,329.	84
VP30H2D21F__ [10/11/20/21]N77	\$ 2,029.	82	VP36H1D18F__ [10/11/20/21]N76	\$ 2,349.	84
VP30H2D21F__ [12/19/23]N77	\$ 2,879.	82	VP36H1D18P__ [12/19/23]N76	\$ 3,199.	84
VP30H2D21F__ [22/26/27/28]N77	\$ 2,449.	82	VP36H1D18P__ [22/26/27/28]N76	\$ 2,779.	84
VP30H2D21F__ [10/11/20/21]N82	\$ 2,129.	82	VP36H1D18P__ [10/11/20/21]N77	\$ 2,349.	84
VP30H2D21F__ [12/19/23]N82	\$ 2,999.	82	VP36H1D18P__ [12/19/23]N77	\$ 3,199.	84
VP30H2D21F__ [22/26/27/28]N82	\$ 2,549.	82	VP36H1D18P__ [22/26/27/28]N77	\$ 2,779.	84
VP30H2D21F__ [10/11/20/21]N83	\$ 2,129.	82	VP36H1D18P__ [10/11/20/21]N82	\$ 2,449.	84
VP30H2D21F__ [12/19/23]N83	\$ 2,999.	82	VP36H1D18P__ [12/19/23]N82	\$ 3,329.	84
VP30H2D21F__ [22/26/27/28]N83	\$ 2,549.	82	VP36H1D18P__ [22/26/27/28]N82	\$ 2,879.	84
VP30H2D21F__ [10/11/20/21]S76	\$ 2,399.	82	VP36H1D18P__ [10/11/20/21]N83	\$ 2,449.	84
VP30H2D21F__ [12/19/23]S76	\$ 3,279.	82	VP36H1D18P__ [12/19/23]N83	\$ 3,329.	84
VP30H2D21F__ [22/26/27/28]S76	\$ 2,829.	82	VP36H1D18P__ [22/26/27/28]N83	\$ 2,879.	84
VP30H2D21F__ [10/11/20/21]S77	\$ 2,399.	82	VP36H1D18P__ [10/11/20/21]S76	\$ 2,779.	84
VP30H2D21F__ [12/19/23]S77	\$ 3,279.	82	VP36H1D18P__ [12/19/23]S76	\$ 3,649.	84
VP30H2D21F__ [22/26/27/28]S77	\$ 2,829.	82	VP36H1D18P__ [22/26/27/28]S76	\$ 3,199.	84
VP30H2D21F__ [10/11/20/21]S82	\$ 2,499.	82	VP36H1D18P__ [10/11/20/21]S77	\$ 2,779.	84
VP30H2D21F__ [12/19/23]S82	\$ 3,379.	82	VP36H1D18P__ [12/19/23]S77	\$ 3,649.	84
VP30H2D21F__ [22/26/27/28]S82	\$ 2,949.	82	VP36H1D18P__ [22/26/27/28]S77	\$ 3,199.	84
VP30H2D21F__ [10/11/20/21]S83	\$ 2,499.	82	VP36H1D18P__ [10/11/20/21]S82	\$ 2,879.	84
VP30H2D21F__ [12/19/23]S83	\$ 3,379.	82	VP36H1D18P__ [12/19/23]S82	\$ 3,749.	84
VP30H2D21F__ [22/26/27/28]S83	\$ 2,949.	82	VP36H1D18P__ [22/26/27/28]S82	\$ 3,329.	84
VP30H2D21F58S82	\$ 3,599.	48	VP36H1D18P__ [10/11/20/21]S83	\$ 2,879.	84
VP30H2D21F59S83	\$ 3,599.	48	VP36H1D18P__ [12/19/23]S83	\$ 3,749.	84
VP30H2D21P__ [10/11/20/21]N76	\$ 2,029.	82	VP36H1D18P__ [22/26/27/28]S83	\$ 3,329.	84
VP30H2D21P__ [12/19/23]N76	\$ 2,879.	82	VP36H1D18P__ [10/11/20/21]N76	\$ 2,349.	84
VP30H2D21P__ [22/26/27/28]N76	\$ 2,449.	82	VP36H1D18T__ [12/19/23]N76	\$ 3,199.	84
VP30H2D21P__ [10/11/20/21]N77	\$ 2,029.	82	VP36H1D18T__ [22/26/27/28]N76	\$ 2,779.	84
VP30H2D21P__ [12/19/23]N77	\$ 2,879.	82	VP36H1D18T__ [10/11/20/21]N77	\$ 2,349.	84
VP30H2D21P__ [22/26/27/28]N77	\$ 2,449.	82	VP36H1D18T__ [12/19/23]N77	\$ 3,199.	84
VP30H2D21P__ [10/11/20/21]N82	\$ 2,129.	82	VP36H1D18T__ [22/26/27/28]N77	\$ 2,779.	84
VP30H2D21P__ [12/19/23]N82	\$ 2,999.	82	VP36H1D18T__ [10/11/20/21]N82	\$ 2,449.	84
VP30H2D21P__ [22/26/27/28]N82	\$ 2,549.	82	VP36H1D18T__ [12/19/23]N82	\$ 3,329.	84
VP30H2D21P__ [10/11/20/21]N83	\$ 2,129.	82	VP36H1D18T__ [22/26/27/28]N82	\$ 2,879.	84
VP30H2D21P__ [12/19/23]N83	\$ 2,999.	82	VP36H1D18T__ [10/11/20/21]N83	\$ 2,449.	84
VP30H2D21P__ [22/26/27/28]N83	\$ 2,549.	82	VP36H1D18T__ [12/19/23]N83	\$ 3,329.	84
VP30H2D21P__ [10/11/20/21]S76	\$ 2,399.	82	VP36H1D18T__ [22/26/27/28]N83	\$ 2,879.	84
VP30H2D21P__ [12/19/23]S76	\$ 3,279.	82	VP36H1D18T__ [10/11/20/21]S76	\$ 2,779.	84
VP30H2D21P__ [22/26/27/28]S76	\$ 2,829.	82	VP36H1D18T__ [12/19/23]S76	\$ 3,649.	84
VP30H2D21P__ [10/11/20/21]S77	\$ 2,399.	82	VP36H1D18T__ [22/26/27/28]S76	\$ 3,199.	84
VP30H2D21P__ [12/19/23]S77	\$ 3,279.	82	VP36H1D18T__ [10/11/20/21]S77	\$ 2,779.	84
VP30H2D21P__ [22/26/27/28]S77	\$ 2,829.	82	VP36H1D18T__ [12/19/23]S77	\$ 3,649.	84
VP30H2D21P__ [10/11/20/21]S82	\$ 2,499.	82	VP36H1D18T__ [22/26/27/28]S77	\$ 3,199.	84
VP30H2D21P__ [12/19/23]S82	\$ 3,379.	82	VP36H1D18T__ [10/11/20/21]S82	\$ 2,879.	84
VP30H2D21P__ [22/26/27/28]S82	\$ 2,949.	82	VP36H1D18T__ [12/19/23]S82	\$ 3,749.	84
VP30H2D21P__ [10/11/20/21]S83	\$ 2,499.	82	VP36H1D18T__ [22/26/27/28]S82	\$ 3,329.	84
VP30H2D21P__ [12/19/23]S83	\$ 3,379.	82	VP36H1D18T__ [10/11/20/21]S83	\$ 2,879.	84
VP30H2D21P__ [22/26/27/28]S83	\$ 2,949.	82	VP36H1D18T__ [12/19/23]S83	\$ 3,749.	84
VP36H1D18F__ [10/11/20/21]N76	\$ 2,349.	84	VP36H1D18T__ [22/26/27/28]S83	\$ 3,329.	84
VP36H1D18F__ [12/19/23]N76	\$ 3,199.	84	VP36H1D21F__ [10/11/20/21]N76	\$ 2,349.	86
VP36H1D18F__ [22/26/27/28]N76	\$ 2,779.	84	VP36H1D21F__ [12/19/23]N76	\$ 3,199.	86
VP36H1D18F__ [10/11/20/21]N77	\$ 2,349.	84	VP36H1D21F__ [22/26/27/28]N76	\$ 2,779.	86
VP36H1D18F__ [12/19/23]N77	\$ 3,199.	84	VP36H1D21F__ [10/11/20/21]N77	\$ 2,349.	86
VP36H1D18F__ [22/26/27/28]N77	\$ 2,779.	84	VP36H1D21F__ [12/19/23]N77	\$ 3,199.	86
VP36H1D18F__ [10/11/20/21]N82	\$ 2,449.	84	VP36H1D21F__ [22/26/27/28]N77	\$ 2,779.	86
VP36H1D18F__ [12/19/23]N82	\$ 3,329.	84			
VP36H1D18F__ [22/26/27/28]N82	\$ 2,879.	84			

__ [] denotes Color/Pattern/Style options.

Model Number Price Index

Model Number	Price	Page	Model Number	Price	Page
VP36H1D21F__ [10/11/20/21]N82	\$ 2,449.	86	VP36H2D18F__ [10/11/20/21]N77	\$ 2,549.	84
VP36H1D21F__ [12/19/23]N82	\$ 3,329.	86	VP36H2D18F__ [12/19/23]N77	\$ 3,429.	84
VP36H1D21F__ [22/26/27/28]N82	\$ 2,879.	86	VP36H2D18F__ [22/26/27/28]N77	\$ 2,999.	84
VP36H1D21F__ [10/11/20/21]N83	\$ 2,449.	86	VP36H2D18F__ [10/11/20/21]N82	\$ 2,679.	84
VP36H1D21F__ [12/19/23]N83	\$ 3,329.	86	VP36H2D18F__ [12/19/23]N82	\$ 3,549.	84
VP36H1D21F__ [22/26/27/28]N83	\$ 2,879.	86	VP36H2D18F__ [22/26/27/28]N82	\$ 3,099.	84
VP36H1D21F__ [10/11/20/21]S76	\$ 2,779.	86	VP36H2D18F__ [10/11/20/21]N83	\$ 2,679.	84
VP36H1D21F__ [12/19/23]S76	\$ 3,649.	86	VP36H2D18F__ [12/19/23]N83	\$ 3,549.	84
VP36H1D21F__ [22/26/27/28]S76	\$ 3,199.	86	VP36H2D18F__ [22/26/27/28]N83	\$ 3,099.	84
VP36H1D21F__ [10/11/20/21]S77	\$ 2,779.	86	VP36H2D18F__ [10/11/20/21]S76	\$ 2,999.	84
VP36H1D21F__ [12/19/23]S77	\$ 3,649.	86	VP36H2D18F__ [12/19/23]S76	\$ 3,879.	84
VP36H1D21F__ [22/26/27/28]S77	\$ 3,199.	86	VP36H2D18F__ [22/26/27/28]S76	\$ 3,429.	84
VP36H1D21F__ [10/11/20/21]S82	\$ 2,879.	86	VP36H2D18F__ [10/11/20/21]S77	\$ 2,999.	84
VP36H1D21F__ [12/19/23]S82	\$ 3,749.	86	VP36H2D18F__ [12/19/23]S77	\$ 3,879.	84
VP36H1D21F__ [22/26/27/28]S82	\$ 3,329.	86	VP36H2D18F__ [22/26/27/28]S77	\$ 3,429.	84
VP36H1D21F__ [10/11/20/21]S83	\$ 2,879.	86	VP36H2D18F__ [10/11/20/21]S82	\$ 3,099.	84
VP36H1D21F__ [12/19/23]S83	\$ 3,749.	86	VP36H2D18F__ [12/19/23]S82	\$ 3,979.	84
VP36H1D21F__ [22/26/27/28]S83	\$ 3,329.	86	VP36H2D18F__ [22/26/27/28]S82	\$ 3,549.	84
VP36H1D21P__ [10/11/20/21]N76	\$ 2,349.	86	VP36H2D18F__ [10/11/20/21]S83	\$ 3,099.	84
VP36H1D21P__ [12/19/23]N76	\$ 3,199.	86	VP36H2D18F__ [12/19/23]S83	\$ 3,979.	84
VP36H1D21P__ [22/26/27/28]N76	\$ 2,779.	86	VP36H2D18F__ [22/26/27/28]S83	\$ 3,549.	84
VP36H1D21P__ [10/11/20/21]N77	\$ 2,349.	86	VP36H2D18P__ [10/11/20/21]N76	\$ 2,549.	84
VP36H1D21P__ [12/19/23]N77	\$ 3,199.	86	VP36H2D18P__ [12/19/23]N76	\$ 3,429.	84
VP36H1D21P__ [22/26/27/28]N77	\$ 2,779.	86	VP36H2D18P__ [22/26/27/28]N76	\$ 2,999.	84
VP36H1D21P__ [10/11/20/21]N82	\$ 2,449.	86	VP36H2D18P__ [10/11/20/21]N77	\$ 2,549.	84
VP36H1D21P__ [12/19/23]N82	\$ 3,329.	86	VP36H2D18P__ [12/19/23]N77	\$ 3,429.	84
VP36H1D21P__ [22/26/27/28]N82	\$ 2,879.	86	VP36H2D18P__ [22/26/27/28]N77	\$ 2,999.	84
VP36H1D21P__ [10/11/20/21]N83	\$ 2,449.	86	VP36H2D18P__ [10/11/20/21]N82	\$ 2,679.	84
VP36H1D21P__ [12/19/23]N83	\$ 3,329.	86	VP36H2D18P__ [12/19/23]N82	\$ 3,549.	84
VP36H1D21P__ [22/26/27/28]N83	\$ 2,879.	86	VP36H2D18P__ [22/26/27/28]N82	\$ 3,099.	84
VP36H1D21P__ [10/11/20/21]S76	\$ 2,779.	86	VP36H2D18P__ [10/11/20/21]N83	\$ 2,679.	84
VP36H1D21P__ [12/19/23]S76	\$ 3,649.	86	VP36H2D18P__ [12/19/23]N83	\$ 3,549.	84
VP36H1D21P__ [22/26/27/28]S76	\$ 3,199.	86	VP36H2D18P__ [22/26/27/28]N83	\$ 3,099.	84
VP36H1D21P__ [10/11/20/21]S77	\$ 2,779.	86	VP36H2D18P__ [10/11/20/21]S76	\$ 2,999.	84
VP36H1D21P__ [12/19/23]S77	\$ 3,649.	86	VP36H2D18P__ [12/19/23]S76	\$ 3,879.	84
VP36H1D21P__ [22/26/27/28]S77	\$ 3,199.	86	VP36H2D18P__ [22/26/27/28]S76	\$ 3,429.	84
VP36H1D21P__ [10/11/20/21]S82	\$ 2,879.	86	VP36H2D18P__ [10/11/20/21]S77	\$ 2,999.	84
VP36H1D21P__ [12/19/23]S82	\$ 3,749.	86	VP36H2D18P__ [12/19/23]S77	\$ 3,879.	84
VP36H1D21P__ [22/26/27/28]S82	\$ 3,329.	86	VP36H2D18P__ [22/26/27/28]S77	\$ 3,429.	84
VP36H1D21P__ [10/11/20/21]S83	\$ 2,879.	86	VP36H2D18P__ [10/11/20/21]S82	\$ 3,099.	84
VP36H1D21P__ [12/19/23]S83	\$ 3,749.	86	VP36H2D18P__ [12/19/23]S82	\$ 3,979.	84
VP36H1D21P__ [22/26/27/28]S83	\$ 3,329.	86	VP36H2D18P__ [22/26/27/28]S82	\$ 3,549.	84
VP36H1D21T__ [10/11/20/21]N76	\$ 2,349.	86	VP36H2D18P__ [10/11/20/21]S83	\$ 3,099.	84
VP36H1D21T__ [12/19/23]N76	\$ 3,199.	86	VP36H2D18P__ [12/19/23]S83	\$ 3,979.	84
VP36H1D21T__ [22/26/27/28]N76	\$ 2,779.	86	VP36H2D18P__ [22/26/27/28]S83	\$ 3,549.	84
VP36H1D21T__ [10/11/20/21]N77	\$ 2,349.	86	VP36H2D21F__ [10/11/20/21]N76	\$ 2,549.	86
VP36H1D21T__ [12/19/23]N77	\$ 3,199.	86	VP36H2D21F__ [12/19/23]N76	\$ 3,429.	86
VP36H1D21T__ [22/26/27/28]N77	\$ 2,779.	86	VP36H2D21F__ [22/26/27/28]N76	\$ 2,999.	86
VP36H1D21T__ [10/11/20/21]N82	\$ 2,449.	86	VP36H2D21F__ [10/11/20/21]N77	\$ 2,549.	86
VP36H1D21T__ [12/19/23]N82	\$ 3,329.	86	VP36H2D21F__ [12/19/23]N77	\$ 3,429.	86
VP36H1D21T__ [22/26/27/28]N82	\$ 2,879.	86	VP36H2D21F__ [22/26/27/28]N77	\$ 2,999.	86
VP36H1D21T__ [10/11/20/21]N83	\$ 2,449.	86	VP36H2D21F__ [10/11/20/21]N82	\$ 2,679.	86
VP36H1D21T__ [12/19/23]N83	\$ 3,329.	86	VP36H2D21F__ [12/19/23]N82	\$ 3,549.	86
VP36H1D21T__ [22/26/27/28]N83	\$ 2,879.	86	VP36H2D21F__ [22/26/27/28]N82	\$ 3,099.	86
VP36H1D21T__ [10/11/20/21]S76	\$ 2,779.	86	VP36H2D21F__ [10/11/20/21]N83	\$ 2,679.	86
VP36H1D21T__ [12/19/23]S76	\$ 3,649.	86	VP36H2D21F__ [12/19/23]N83	\$ 3,549.	86
VP36H1D21T__ [22/26/27/28]S76	\$ 3,199.	86	VP36H2D21F__ [22/26/27/28]N83	\$ 3,099.	86
VP36H1D21T__ [10/11/20/21]S77	\$ 2,779.	86	VP36H2D21F__ [10/11/20/21]S76	\$ 2,999.	86
VP36H1D21T__ [12/19/23]S77	\$ 3,649.	86	VP36H2D21F__ [12/19/23]S76	\$ 3,879.	86
VP36H1D21T__ [22/26/27/28]S77	\$ 3,199.	86	VP36H2D21F__ [22/26/27/28]S76	\$ 3,429.	86
VP36H1D21T__ [10/11/20/21]S82	\$ 2,879.	86	VP36H2D21F__ [10/11/20/21]S77	\$ 2,999.	86
VP36H1D21T__ [12/19/23]S82	\$ 3,749.	86	VP36H2D21F__ [12/19/23]S77	\$ 3,879.	86
VP36H1D21T__ [22/26/27/28]S82	\$ 3,329.	86	VP36H2D21F__ [22/26/27/28]S77	\$ 3,429.	86
VP36H1D21T__ [10/11/20/21]S83	\$ 2,879.	86	VP36H2D21F__ [10/11/20/21]S82	\$ 3,099.	86
VP36H1D21T__ [12/19/23]S83	\$ 3,749.	86	VP36H2D21F__ [12/19/23]S82	\$ 3,979.	86
VP36H1D21T__ [22/26/27/28]S83	\$ 3,329.	86	VP36H2D21F__ [22/26/27/28]S82	\$ 3,549.	86
VP36H2D18F__ [10/11/20/21]N76	\$ 2,549.	84	VP36H2D21F__ [10/11/20/21]S83	\$ 3,099.	86
VP36H2D18F__ [12/19/23]N76	\$ 3,429.	84	VP36H2D21F__ [12/19/23]S83	\$ 3,979.	86
VP36H2D18F__ [22/26/27/28]N76	\$ 2,999.	84	VP36H2D21F__ [22/26/27/28]S83	\$ 3,549.	86

__ [] denotes Color/Pattern/Style options.

Model Number Price Index

Model Number	Price	Page
VP36H2D21P__[10/11/20/21]N76	\$ 2,549.	86
VP36H2D21P__[12/19/23]N76	\$ 3,429.	86
VP36H2D21P__[22/26/27/28]N76	\$ 2,999.	86
VP36H2D21P__[10/11/20/21]N77	\$ 2,549.	86
VP36H2D21P__[12/19/23]N77	\$ 3,429.	86
VP36H2D21P__[22/26/27/28]N77	\$ 2,999.	86
VP36H2D21P__[10/11/20/21]N82	\$ 2,679.	86
VP36H2D21P__[12/19/23]N82	\$ 3,549.	86
VP36H2D21P__[22/26/27/28]N82	\$ 3,099.	86
VP36H2D21P__[10/11/20/21]N83	\$ 2,679.	86
VP36H2D21P__[12/19/23]N83	\$ 3,549.	86
VP36H2D21P__[22/26/27/28]N83	\$ 3,099.	86
VP36H2D21P__[10/11/20/21]S76	\$ 2,999.	86
VP36H2D21P__[12/19/23]S76	\$ 3,879.	86
VP36H2D21P__[22/26/27/28]S76	\$ 3,429.	86
VP36H2D21P__[10/11/20/21]S77	\$ 2,999.	86
VP36H2D21P__[12/19/23]S77	\$ 3,879.	86
VP36H2D21P__[22/26/27/28]S77	\$ 3,429.	86
VP36H2D21P__[10/11/20/21]S82	\$ 3,099.	86
VP36H2D21P__[12/19/23]S82	\$ 3,979.	86
VP36H2D21P__[22/26/27/28]S82	\$ 3,549.	86
VP36H2D21P__[10/11/20/21]S83	\$ 3,099.	86
VP36H2D21P__[12/19/23]S83	\$ 3,979.	86
VP36H2D21P__[22/26/27/28]S83	\$ 3,549.	86
X202-1081	\$ 15.	279
X202-1108	\$ 99.	277
X202-1109	\$ 99.	277
X202-1110	\$ 99.	277
X202-1111	\$ 99.	277
X202-1116	\$ 105.	279
X202-1136	\$ 99.	277
X202-1137	\$ 99.	277
X202-1138	\$ 99.	277
X205-1557	\$ 310.	278
X205-1558	\$ 254.	278
X205-1559	\$ 224.	278
X205-1783	\$ 49.	278
X216-1025	\$ 42.	278
X216-1035	\$ 21.	278
X216-1054	\$ 10.	278
X216-1055	\$ 11.	278
X216-1056	\$ 11.	278
X216-1057	\$ 12.	278
X216-1058	\$ 43.	278
X216-1059	\$ 34.	278
X216-1112	\$ 10.	278
X216-1166	\$ 15.	278
X219-1091	\$ 102.	279
X219-1096	\$ 103.	279
X219-1145	\$ 99.	279
X219-1151	\$ 99.	279
X219-1152	\$ 99.	279
XSS131-12	\$ 9.	278
XSS134-36	\$ 8.	278
XSS712-2	\$ 9.	278
YM0030CIFPD3	\$ 879.	33
YM0030CIFPD4	\$ 879.	33
YM0030CPFPD3	\$ 829.	33
YM0040CIFPD3	\$ 1,049.	33
YM0040CIFPD4	\$ 1,049.	33

Model Number	Price	Page
YM0040CPFPD3	\$ 999.	33
YM2430RCFPD3	\$ 549.	32
YM2430RCFPD4	\$ 549.	32
YM2430RIFPD3	\$ 779.	32
YM2430RIFPD4	\$ 779.	32
YM2430RPFPD3	\$ 729.	32
YM2430RPFPD3K	\$ 899.	32
YM2440RCFPD3	\$ 599.	32
YM2440RCFPD4	\$ 599.	32
YM2440RIFPD3	\$ 829.	32
YM2440RIFPD4	\$ 829.	32
YM2440RPFPD3	\$ 779.	32
YM2440RPFPD3K	\$ 949.	32
YM2531RPSMD3__[76/77]	\$ 1,099.	25
YM2531RPSMD3__[82/83]	\$ 1,199.	25
YM2531RPSMD3K__[76/77]	\$ 1,199.	25
YM2531RPSMD3K__[82/83]	\$ 1,299.	25
YM2541RPSMD3__[76/77]	\$ 1,299.	25
YM2541RPSMD3__[82/83]	\$ 1,549.	25
YM2541RPSMD3K__[76/77]	\$ 1,399.	25
YM2541RPSMD3K__[82/83]	\$ 1,649.	25
YM2733RPCMD3__[76/77]	\$ 1,449.	25
YM2733RPCMD3__[82/83]	\$ 1,699.	25
YM2733RPCMD3K__[76/77]	\$ 1,549.	25
YM2733RPCMD3K__[82/83]	\$ 1,799.	25
YM2743RPCMD3__[76/77]	\$ 1,649.	25
YM2743RPCMD3__[82/83]	\$ 1,899.	25
YM2743RPCMD3K__[76/77]	\$ 1,749.	25
YM2743RPCMD3K__[82/83]	\$ 1,999.	25
YM3030RCFPD3	\$ 679.	32
YM3030RCFPD4	\$ 679.	32
YM3030RIFPD3	\$ 879.	32
YM3030RIFPD4	\$ 879.	32
YM3030RPFPD3	\$ 829.	32
YM3040RCFPD3	\$ 729.	32
YM3040RCFPD4	\$ 729.	32
YM3040RIFPD3	\$ 949.	32
YM3040RIFPD4	\$ 949.	32
YM3040RPFPD3	\$ 879.	32
YM3040RPFPD3K	\$ 1,049.	32
YM3141RPSMD3__[76/77]	\$ 1,429.	25
YM3141RPSMD3__[82/83]	\$ 1,679.	25
YM3141RPSMD3K__[76/77]	\$ 1,499.	25
YM3141RPSMD3K__[82/83]	\$ 1,749.	25
YM3343RPCMD3__[76/77]	\$ 1,779.	25
YM3343RPCMD3__[82/83]	\$ 2,029.	25
YM3343RPCMD3K__[76/77]	\$ 1,849.	25
YM3343RPCMD3K__[82/83]	\$ 2,099.	25
YM3630RCFPD3	\$ 779.	32
YM3630RCFPD4	\$ 779.	32
YM3630RIFPD3	\$ 999.	32
YM3630RIFPD4	\$ 999.	32
YM3630RPFPD3	\$ 949.	32
YM3640RCFPD3	\$ 829.	32
YM3640RCFPD4	\$ 829.	32
YM3640RIFPD3	\$ 1,049.	32
YM3640RIFPD4	\$ 1,049.	32
YM3640RPFPD3	\$ 999.	32
YM3640RPFPD3K	\$ 1,149.	32

__[] denotes Color/Pattern/Style options.

robern[®]
A **KOHLER** COMPANY

217-1313 ©2019 by Robern, Inc

DISCOVER WHAT ROBERN CAN DO FOR YOU

Visit us at robern.com

800-877-2376

customerservice@robern.com