



2019 Product Addendum

New Products:

AC553P



66" x 36"
Addendum Pg. 4

AD553P



66" x 36"
Addendum Pg. 5

HE5527

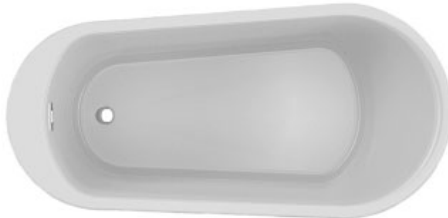

66" x 32"
Addendum Pg. 6

HE5527PS



66" x 32"
Addendum Pg. 7

AS553



66" x 36"
Addendum Pg. 8

AS553P



*Shown with Decorative Ring Base
66" x 36"
Addendum Pg. 9

Items being retired February, 1, 2019:











Hannah™ HE525 & HE525PS:

The larger, 32" wide HE5527 & HE5527PS will join the HE527 & HE527PS tubs in the Hannah™ Series, replacing the narrower 30" Hannah™ HE525 & HE525PS tubs.

Alexia™ AL3648 Shower Bath :

The Alexia™ AL3648 Shower Bath is to be retired.

Our modern, minimalist forma[®] series baths offer a variety of Freestanding options which feature a number of different shapes, sizes, and accoutrements, along with stylish skirt selections to help bring together any bathroom design.

	 "P" Skirt	 "PS" Skirt	 "PX" Skirt	Faucetry Deck
AC 	AC553P (66 x 36) (Product Addendum Pg. 4)	AC553PS (66 x 36) ... Pg. 19 AC635PS (72 x 42) ... Pg. 23	AC553PX (66 x 36) ... Pg. 20	
AD 	AD553P (66 x 36) (Product Addendum Pg. 5)	AD553PS (66 x 36) ... Pg. 25	AD553PX (66 x 36) ... Pg. 26	✓
HE 		HE527PS (60 x 32) ... Pg. 31 HE5527PS (66 x 42) (Product Addendum Pg. 7)		✓
ME 		ME553PS (66 x 36) ... Pg. 33		✓
RC 		RC553PS (66 x 36) ... Pg. 35 RC630PS (72 x 36) ... Pg. 38	RC553PX (66 x 36) ... Pg. 36	
RD 		RD553PS (66 x 36) ... Pg. 41	RD553PX (66 x 36) ... Pg. 42	✓
RE 		RE553PS (66 x 36) ... Pg. 48 RE630PS (72 x 36) ... Pg. 50		

*The page numbers listed in this addendum correlate to the Jason 2018 Pricelist unless otherwise noted



Bath Prefix - 1186.07

	STANDARD	PREMIER	SIGNATURE
	<ul style="list-style-type: none"> • 120V • Touch Control • 20-minute timer 	<ul style="list-style-type: none"> • 120V • Touch Control • 20-minute timer • Ozone • LED Light 	<ul style="list-style-type: none"> • 120V • Digital Control • 20-minute timer • Ozone • LED Light • Bluetooth • Sound Immersion • Water Level Sensor
(m) MICROSILK [®]	\$7,090 (1186.07.61.CC)	\$7,620 (1186.07.65.CC)	\$8,715 (1186.07.63.CC)
(a) AIRMASSEUR [®]	\$6,165 (1186.07.21.CC)	\$6,945 (1186.07.25.CC)	\$7,905 (1186.07.23.CC)
(S) SOAKING	\$3,540 (1186.07.00.CC)		

Please specify when ordering

- **Standard Color:** CC= White-WT (01), Bisquite-BQ (40).
- CUSTOM COLOR** for color chart & codes, see pg. 151

Bath Options

GH300 OR GH400 HANDLE Factory installed, Accepts 1 handle across from overflow. Page 142			
ACRYLIC EQUIPMENT CABINET (a)			\$900
BLUETOOTH SOUND IMMERSION SYSTEM - Page 143			\$595
THERMO COMFORT - Page 144 (S) (m)			\$620
MICROSILK SHOWER WAND Page 144 (m)	Polished Chrome	8705-51-091	\$360
LINEAR OVERFLOW DRAIN KITS For color options, see pg. 144	Polished Chrome	LDK-PC	Included
	Optional Finishes	LDK-XX	ADD \$80
OTHER OPTIONS		For details and other options, see Page 143	
TILE FLANGE KIT		For details see page 144	

Feature Information

- (m)** Includes 1 MicroSilk delivery port, MicroSilk unit in acrylic equipment cabinet
- (a)** Includes 40 strategically located air jets, 1hp blower w/ heater. Blower must be remote mounted if Acrylic Equipment Cabinet not selected.

Consult Spec Sheet on website for Boxed Weight & Cube. Operating Cap: 39 U.S. Gal. 120V, 20A (US)

- (E)** Equipment Cabinet Standard Location
- (C)** Control Location

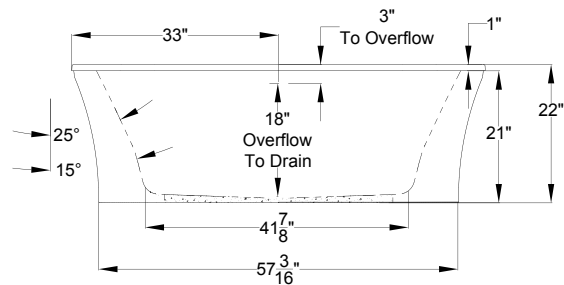
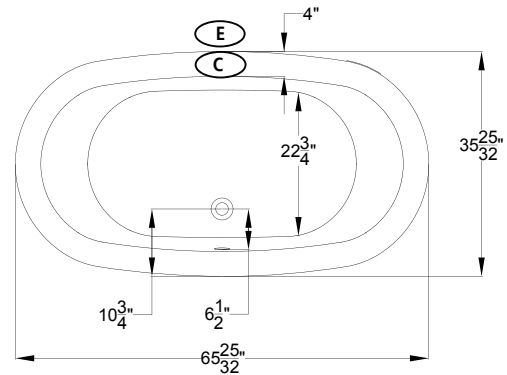

Acrylic Equipment Cabinet is standard and required on MicroSilk[®] baths and is available as an option on Airmasseur[®] baths.

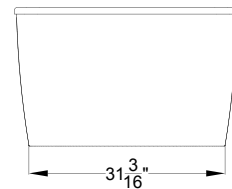
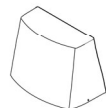
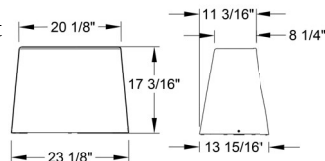



Bath Prefix - 1192.07

	STANDARD	PREMIER	SIGNATURE
	<ul style="list-style-type: none"> • 120V • Touch Control • 20-minute timer 	<ul style="list-style-type: none"> • 120V • Touch Control • 20-minute timer • Ozone • LED Light 	<ul style="list-style-type: none"> • 120V • Digital Control • 20-minute timer • Ozone • LED Light • Bluetooth • Sound Immersion • Water Level Sensor
(m) MICROSILK [®]	\$7,090 (1192.07.61.CC)	\$7,620 (1192.07.65.CC)	\$8,715 (1192.07.63.CC)
(a) AIRMASSEUR [®]	\$6,165 (1192.07.21.CC)	\$6,945 (1192.07.25.CC)	\$7,905 (1192.07.23.CC)
(S) SOAKING	\$3,540 (1192.07.00.CC)		

Please specify when ordering

- **Standard Color:** CC= White-WT (01), Bisquite-BQ (40).
- CUSTOM COLOR** for color chart & codes, see pg. 151

Bath Options

GH300 OR GH400 HANDLE Factory installed, Accepts 1 handle across from overflow. Page 142			
ACRYLIC EQUIPMENT CABINET (a)			\$900
BLUETOOTH SOUND IMMERSION SYSTEM - Page 143			\$595
THERMO COMFORT - Page 144 (S) (m)			\$620
MICROSILK SHOWER WAND Page 144 (m)	Polished Chrome	8705-51-091	\$360
LINEAR OVERFLOW DRAIN KITS For color options, see pg. 144	Polished Chrome	LDK-PC	Included
	Optional Finishes	LDK-XX	ADD \$80
OTHER OPTIONS For details and other options, see Page 143			
TILE FLANGE KIT For details see page 144 N/A			

Feature Information

- (m)** Includes 1 MicroSilk delivery port, MicroSilk unit in acrylic equipment cabinet
- (a)** Includes 52 strategically located air jets, 1hp blower w/ heater. Blower must be remote mounted if Acrylic Equipment Cabinet not selected.

Consult Spec Sheet on website for Boxed Weight & Cube. Operating Cap: 41 U.S. Gal. 120V, 20A (US)

- (E)** Equipment Cabinet Standard Location
- (C)** Control Location

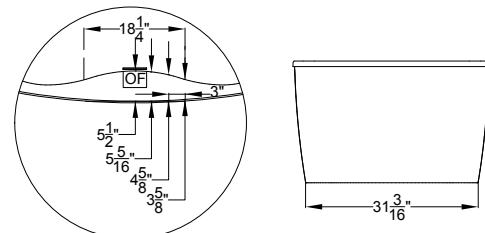
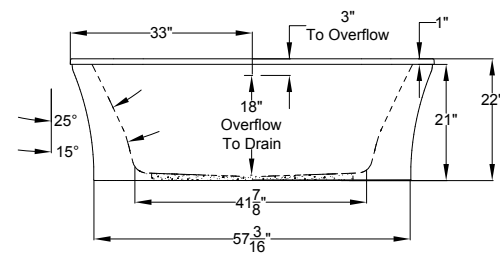
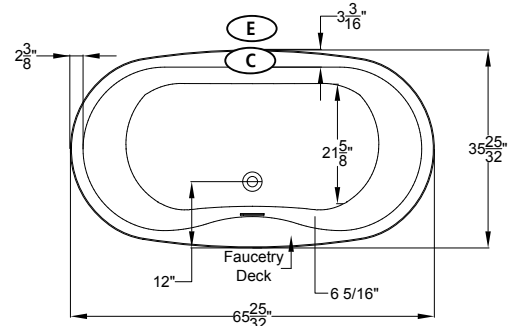

Acrylic Equipment Cabinet is standard and required on MicroSilk[®] baths and is available as an option on Airmasseur[®] baths.

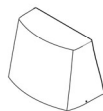
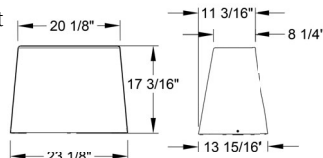



Bath Prefix - 1203.00			
	STANDARD	PREMIER	SIGNATURE
	<ul style="list-style-type: none"> •120V • Touch Control • 20-minute timer 	<ul style="list-style-type: none"> •120V • Touch Control • 20-minute timer • Ozone • LED Light 	<ul style="list-style-type: none"> • 120V • Digital Control • 20-minute timer • Ozone • LED Light • Bluetooth • Sound Immersion • Water Level Sensor
(m) MICROSILK [®]	\$5,195 (1203.00.61.CC)	\$5,725 (1203.00.65.CC)	\$6,820 (1203.00.63.CC)
(a) AIRMASSEUR [®]	\$4,570 (1203.00.21.CC)	\$5,350 (1203.00.25.CC)	\$6,310 (1203.00.23.CC)
(w) WHIRLPOOL	\$4,320 with 1-speed pump (1203.00.11.CC)	\$5,170 with pump/heater (1203.00.15.CC)	\$6,450 with pump/heater (1203.00.13.CC)
(ma) MICROSILK [®] AIRMASSEUR [®]	\$7,845 (1203.00.81.CC)	\$8,370 (1203.00.85.CC)	\$9,325 (1203.00.83.CC)
(mw) MICROSILK [®] WHIRLPOOL	N/A	N/A	N/A
(aw) AIRMASSEUR [®] WHIRLPOOL	\$6,425 with 1-speed pump (1203.00.31.CC)	\$7,275 with pump/heater (1203.00.35.CC)	\$8,425 with pump/heater (1203.00.33.CC)
(s) SOAKING	\$1,945 (1203.00.00.CC)		

- (C)** Control Location
- (P)** Pump Location
- (M)** MicroSilk[®] Unit Location
- (B)** Blower Location

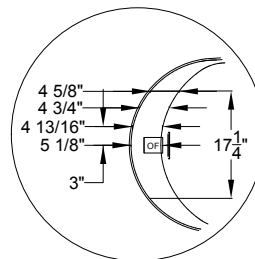
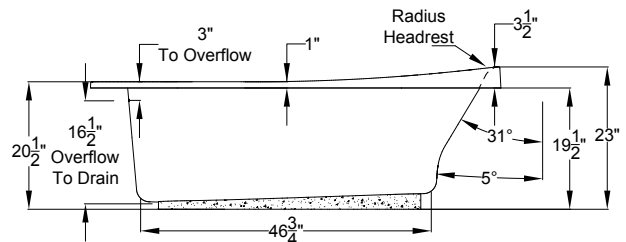
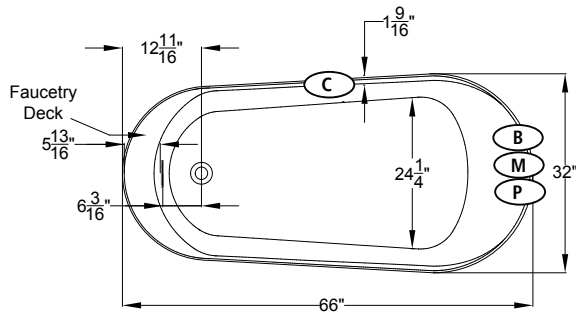

NOTE: Overflow fitting will extend approx. 3". Allow for faucetry plumbing accordingly.

Faucetry Deck Flat Dimensions

Please specify when ordering

• **Standard Color:** CC= White-WT (01), Bisquite-BQ (40).

CUSTOM COLOR for color chart & codes, see pg. 151

Bath Options

GH300 OR GH400 HANDLE Factory installed. Accepts 2 handles. If ordering 1 handle, indicate installation location. Page 142

JETTED NECK PILLOW - Page 143 White (JNP-WT) / Black (JNP-BK) **(w) (mw)** \$815

BACKSTACK™ JETS **(w) (mw)** N/A

BLUETOOTH SOUND IMMERSION SYSTEM - Page 143 \$595

THERMO COMFORT - Page 144 **(s) (m) (w) (mw)** \$620

MICROSILK SHOWER WAND Page 144 **(m) (ma) (mw)** Polished Chrome **8705-51-091** \$360

LINEAR OVERFLOW DRAIN KITS Polished Chrome **LDK-PC** Included
For color options, see pg. 144 Optional Finishes **LDK-XX** ADD \$80

OTHER OPTIONS For details and other options, see Page 143

TILE FLANGE KIT For details see page 144 N/A

Feature Information

- (m)** Includes 1 MicroSilk delivery port, MicroSilk unit
- (a)** Includes 43 strategically located air jets, 1hp blower w/ heater
- (w)** Includes 5 adjustable jets and 2 foot jets with pump unit indicated.
- Includes 1 MicroSilk delivery port, 38 strategically located air jets; MicroSilk unit; 1hp blower w/ heater. Combines all features provided with both **(m)** & **(a)** equipped Standard, Premier or Signature baths, respectively.
- Includes 5 adjustable jets, 2 foot jets, and 38 air jets; 1.5 hp pump; 1hp blower w/ heater.
- (aw)** Combines all features provided with both **(a)** & **(w)** equipped Standard, Premier or Signature baths, respectively.

Consult Spec Sheet on website for Boxed Weight & Cube. Operating Cap: 39 U.S. Gal. 120V, 20A (US)

ORDER DESK: Phone: 800.255.5766 • Fax: 501.771.2333 • E-Mail: orderdesk@jasonint.com
Subject to our published Conditions of Sale and subject to change without notice.

Effective Date: February 15, 2019



Bath Prefix - 1203.04			
	STANDARD	PREMIER	SIGNATURE
	<ul style="list-style-type: none"> • 120V • Touch Control • 20-minute timer 	<ul style="list-style-type: none"> • 120V • Touch Control • 20-minute timer • Ozone • LED Light 	<ul style="list-style-type: none"> • 120V • Digital Control • 20-minute timer • Ozone • LED Light • Bluetooth • Sound Immersion • Water Level Sensor
(m) MICROSILK [®]	\$7,050 (1203.04.61.CC)	\$7,580 (1203.04.65.CC)	\$8,675 (1203.04.63.CC)
(a) AIRMASSEUR [®]	\$6,425 (1203.04.21.CC)	\$7,205 (1203.04.25.CC)	\$8,165 (1203.04.23.CC)
(S) SOAKING	\$3,500 (1203.04.00.CC)		

Please specify when ordering

- **Standard Color:** CC= White-WT (01), Bisquite-BQ (40).

CUSTOM COLOR for color chart & codes, see pg. 151

- (E)** Equipment Cabinet Standard Location
- (C)** Control Location
- (OE)** Equipment Cabinet Optional Location

Bath Options			
GH300 OR GH400 HANDLE Factory installed. Accepts 2 handles. If ordering 1 handle, indicate installation location. Page 142			
ACRYLIC EQUIPMENT CABINET (a)			\$900
BLUETOOTH SOUND IMMERSION SYSTEM - Page 143			\$595
THERMO COMFORT - Page 144 (S) (m)			\$620
MICROSILK SHOWER WAND Page 144 (m)	Polished Chrome	8705-51-091	\$360
LINEAR OVERFLOW DRAIN KITS For color options, see pg. 144	Polished Chrome	LDK-PC	Included
	Optional Finishes	LDK-XX	ADD \$80
OTHER OPTIONS	For details and other options, see Page 143		
TILE FLANGE KIT	For details see page 144		N/A

Feature Information			
(m)	Includes 1 MicroSilk delivery port, MicroSilk unit in acrylic equipment cabinet		
(a)	Includes 43 strategically located air jets, 1hp blower w/ heater. Blower must be remote mounted if Acrylic Equipment Cabinet not selected.		
Consult Spec Sheet on website for Boxed Weight & Cube.		Operating Cap: 39 U.S. Gal.	120V, 20A (US)

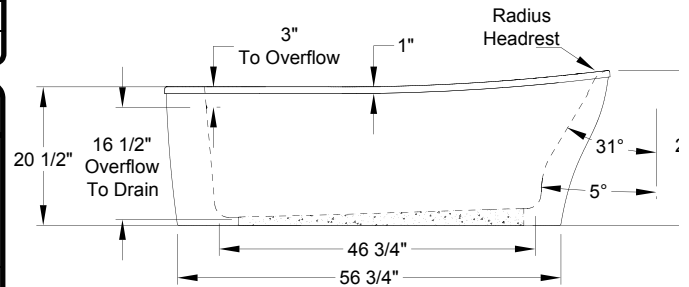
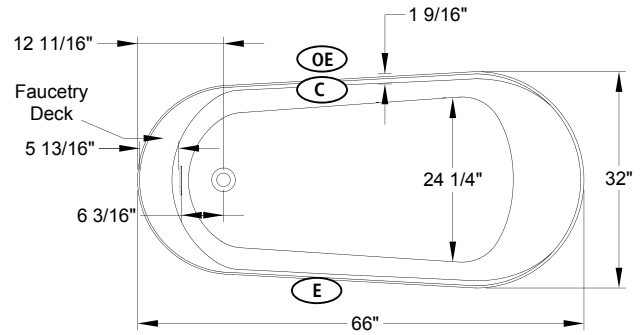

Acrylic Equipment Cabinet is standard and required on MicroSilk[®] baths and is available as an option on Airmasseur[®] baths.

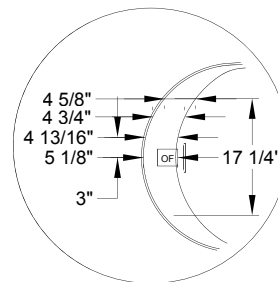
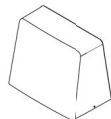
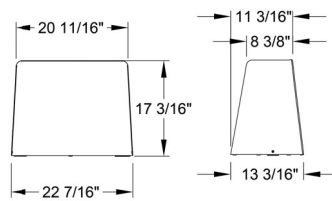

Faucetry Deck Flat Dimensions

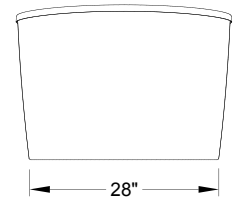



Bath Prefix - 2204.00		
STANDARD	PREMIER	SIGNATURE
<ul style="list-style-type: none"> • 120V • Touch Control • 20-minute timer 	<ul style="list-style-type: none"> • 120V • Touch Control • 20-minute timer • Ozone • LED Light 	<ul style="list-style-type: none"> • 120V • Digital Control • 20-minute timer • Ozone • LED Light • Bluetooth Sound Immersion • Water Level Sensor

(m) MICROSILK [®]	\$4,780 (2204.00.61.CC)	\$5,310 (2204.00.65.CC)	\$6,405 (2204.00.63.CC)
(a) AIRMASSEUR [®]	\$4,430 (2204.00.21.CC)	\$5,210 (2204.00.25.CC)	\$6,170 (2204.00.23.CC)
(w) WHIRLPOOL	\$4,170 with 1-speed pump (2204.00.11.CC)	\$5,020 with pump/heater (2204.00.15.CC)	\$6,300 with pump/heater (2204.00.13.CC)
(ma) MICROSILK [®] AIRMASSEUR [®]	\$7,080 (2204.00.81.CC)	\$7,605 (2204.00.85.CC)	\$8,560 (2204.00.83.CC)
(mw) MICROSILK [®] WHIRLPOOL	\$7,075 with 1-speed pump (2204.00.71.CC)	\$7,950 with pump/heater (2204.00.75.CC)	\$9,075 with pump/heater (2204.00.73.CC)
(aw) AIRMASSEUR [®] WHIRLPOOL	\$6,250 with 1-speed pump (2204.00.31.CC)	\$7,100 with pump/heater (2204.00.35.CC)	\$8,250 with pump/heater (2204.00.33.CC)
(s) SOAKING	\$1,930 (2204.00.00.CC)		



(Optional) 1 set of Back-Stack™ jets on **(w)** **(mw)**

- (P)** Whirlpool Pump Location
- (C)** Control Location
- (OP)** Optional pump location available on **(w)** only. Please designate pump location. On **(mw)** the pump will be in this location.
- (M)** MicroSilk[®] Unit Location
- (B)** Blower Location

Please specify when ordering

- **Standard Color:** CC= White-WT (01), Bisquite-BQ (40).
- CUSTOM COLOR** For color chart & codes, see pg. 151

Bath Options			
GH200 HANDLE - Factory installed, Accepts 1 handle across from overflow. Page 142			
JETTED NECK PILLOW - Page 143	White (JNP-WT) / Black (JNP-BK)	(w) (mw) (aw)	\$815
BACK-STACK™ JETS	(w) (mw)		\$670
BLUETOOTH SOUND IMMERSION SYSTEM - Page 143			\$595
THERMO COMFORT - Page 144	(s) (m) (w) (mw)		\$620
MICROSILK SHOWER WAND Page 144	(m) (ma)	Polished Chrome	8705-51-091 \$360
DESIGNER OVERFLOW DRAIN KITS For color options, see pg. 144	Polished Chrome	DDK-PC	Included
	Optional Finishes	DDK-XX	ADD \$80
OTHER OPTIONS	For details and other options, see page 143		
TILE FLANGE KIT	For details see page 144 N/A		
LATERAL SKIRT - Pages 146	N/A		

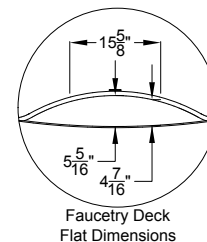
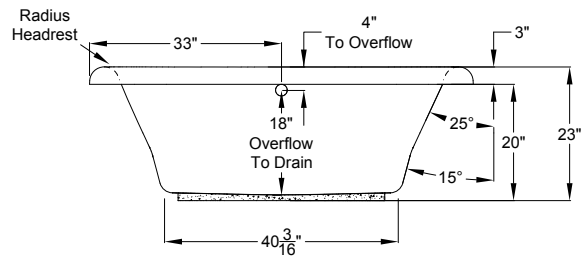
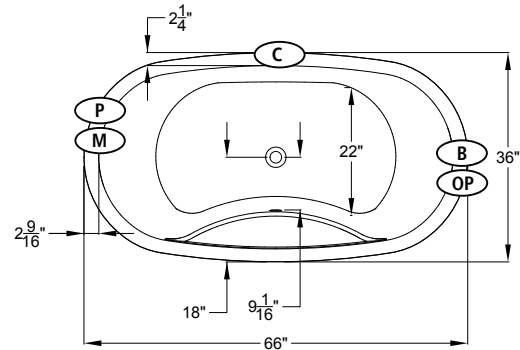

Feature Information	Undermountable
(m) Includes 1 MicroSilk delivery port, MicroSilk unit	
(a) Includes 35 strategically located air jets, 1hp blower w/ heater	
(w) Includes 6 adjustable jets with pump unit indicated.	
(ma) Includes 1 MicroSilk delivery port, 35 strategically located air jets; MicroSilk unit; 1hp blower w/ heater. Combines all features provided with both (m) & (a) equipped Standard, Premier or Signature baths, respectively.	
(mw) Includes 6 adjustable jets and 1 MicroSilk delivery port; MicroSilk unit; 1.5 hp pump. Combines all features provided with both (m) & (w) equipped Standard, Premier or Signature baths, respectively..	
(aw) Includes 6 adjustable jets and 35 air jets; 1.5 hp pump; 1hp blower w/ heater. Combines all features provided with both (a) & (w) equipped Standard, Premier or Signature baths, respectively.	
Consult Spec Sheet on website for Boxed Weight & Cube. Operating Cap: 41 U.S. Gal. 120V, 20A (US)	

ORDER DESK: Phone: 800.255.5766 • Fax: 501.771.2333 • E-Mail: orderdesk@jasonint.com
Subject to our published Conditions of Sale and subject to change without notice.

Effective Date: February 15, 2019



*Shown with optional Ring Base.

Bath Prefix - 2204.07

STANDARD	PREMIER	SIGNATURE
<ul style="list-style-type: none"> • 120V • Touch Control • 20-minute timer 	<ul style="list-style-type: none"> • 120V • Touch Control • 20-minute timer • Ozone • LED Light 	<ul style="list-style-type: none"> • 120V • Digital Control • 20-minute timer • Ozone • LED Light • Bluetooth Sound Immersion • Water Level Sensor

(m) MICROSILK [®]	\$6,335 (2204.07.61.CC)	\$6,865 (2204.07.65.CC)	\$7,960 (2204.07.63.CC)
(a) AIRMASSEUR [®]	\$5,985 (2204.07.21.CC)	\$6,765 (2204.07.25.CCC)	\$7,725 (2204.07.23.CC)
(S) SOAKING	\$3,485 (2204.07.00.CC)		

Please specify when ordering

- **Standard Color:** CC= White-WT (01), Bisquite-BQ (40).
- CUSTOM COLOR** for color chart & codes, see pg. 151

Bath Options

GH200 HANDLE - Factory installed, Accepts 1 handle across from overflow. Page 142			
ACRYLIC EQUIPMENT CABINET (a)		\$900	
PEDESTAL SKIRT RING BASE (S) (m) (a)		\$1,000	
BLUETOOTH SOUND IMMERSION SYSTEM - Page 143		\$595	
THERMO COMFORT - Page 144 (S) (m)		\$620	
MICROSILK SHOWER WAND Page 144 (m)	Polished Chrome	8705-51-091	\$360
DESIGNER OVERFLOW DRAIN KITS For color options, see pg. 144	Polished Chrome	DDK-PC	Included
	Optional Finishes	DDK-XX	ADD \$80
OTHER OPTIONS		For details and other options, see Page 143	
TILE FLANGE KIT		For details see page 144	

Feature Information

- (m) Includes 1 MicroSilk delivery port, MicroSilk unit in acrylic equipment cabinet
- (a) Includes 35 strategically located air jets, 1hp blower w/ heater. Blower must be remote mounted if Acrylic Equipment Cabinet not selected.

Consult Spec Sheet on website for Boxed Weight & Cube. Operating Cap: 41 U.S. Gal. 120V, 20A (US)



Acrylic Equipment Cabinet is standard and required on MicroSilk[®] baths and is available as an option on Airmasseur[®] baths.

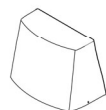
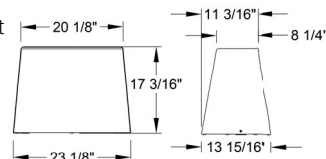

- (E) Equipment Cabinet Standard Location
- (C) Control Location

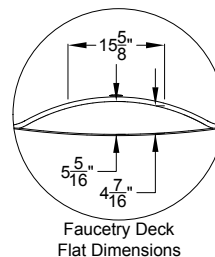
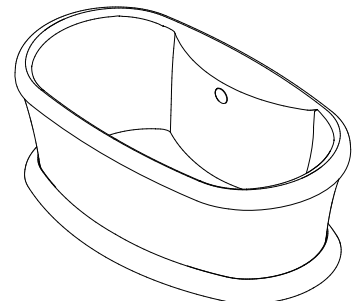
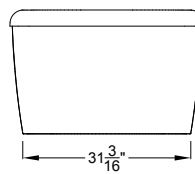
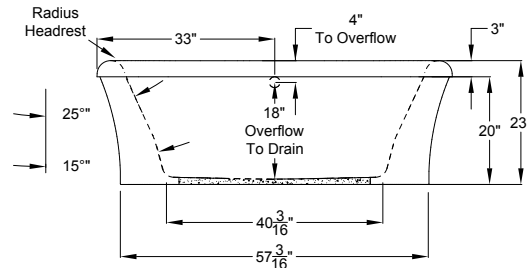
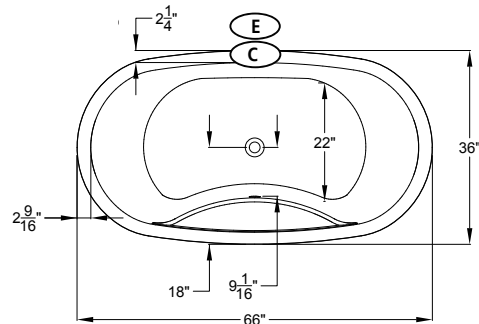

Faucetry Deck Flat Dimensions

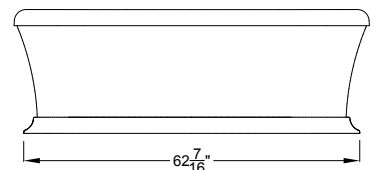

Shown with optional Ring Base

ORDER DESK: Phone: 800.255.5766 • Fax: 501.771.2333 • E-Mail: orderdesk@jasonint.com
Subject to our published Conditions of Sale and subject to change without notice.

Effective Date: February 15, 2019

Why Jason Freestanding Baths Stand Out - Pg. 16

JASON
HYDROTHERAPY

forma®
FREESTANDING BATHS

What Makes Our Products Stand Out?



ERGO-SPATIAL DESIGN

All Jason baths are ergo-spatial, meaning you are placed in the ideal position to achieve perfect alignment while the spacious well of the bath allows for full body immersion in warm water.

STYLISH FEATURES

Each bath comes standard with a chrome linear overflow and drain, and the smooth bottom design is both simple and elegant.

TWO-PIECE ACRYLIC DESIGN

Our baths are crafted from durable, easy-clean acrylic, and the two-piece design makes for easy install and a bath you can enjoy longer.

DECK MOUNTED FAUCETRY

Faucets set the tone for your bathroom decor. The simple elegance of deck mounted faucetry is both beautiful and functional. Our AD, RD, Hammah™ and McKenzie™ baths can accommodate center mounted faucetry, while our other freestanding baths can accommodate off-center or end deck mounted faucetry.



OURS

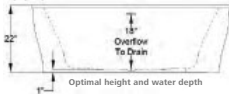

ACCESSIBILITY

Our baths are made for easy entry. The Level-Form™ base under each bath is 1" thick, (compared to up to 5" from competing freestanding bath options). Because of this, our baths have shorter overall height and a deeper bathing well than competitors.

THEIRS

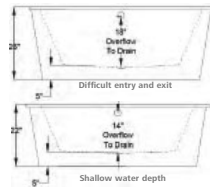

Walk-In Baths with MicroSilk® - Pg. 98

Vivere® Collection
Group BE

Accessible • Comfortable • Style

Refined Luxury, for a Refined Bathing Experience

Also available with Soaking, MicroSilk®, Whirlpool, and combination hydrotherapies.



A03052 SL/SR.....Pg. 99
Inward Door



A03252 SL/SR.....Pg. 100
Outward Door
Includes Hoyer Lift Panel

2 MODELS TO CHOOSE FROM

- Low Threshold Across Entry Way
- Ergonomically Dual Angled Grab Bar
- Slip Resistant Floor
- Easy Access Panels
- Secondary Door Drain
- Extension Panels to fit 60" width.
- Adjustable legs
- 17" High Contoured Seat.
- Inward or Outward Door with Lifetime Warranty on the Door Seal

MANY OPTIONS TO CHOOSE FROM - PLEASE REFER TO PAGE 143 "BATH OPTIONS"

TZ3260 SHOWERBASE

All models are provided with a Level-Form™ full support base, and with integral tile lips to assure watertight installation. Additionally, the TZ3260 is equipped with Zero Threshold, easy entry. The Linear Drain is integral with removable stainless steel drain cover and 3-1/4" shower drain.

TZ3260 Seat Left



TZ3260 Seat Left.....Pg. 101

TZ3260 Seat Right



TZ3260 Seat Right.....Pg. 101

TZ3260 No Seat



TZ3260 No Seat.....Pg. 101

Why Jason MicroSilk® Surpasses All Others

MICROSILK®

Some call it the Fountain of Youth. We think you'll simply call it wonderful.

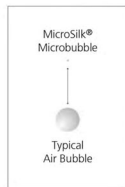

The Beauty of MicroSilk®

Blankets your body with billions of oxygen-rich microbubbles

- Microbubbles are 50 microns or less in size
- Gives your skin a silky feel

Moisturizing and cleansing at the same time

- Microbubbles enter pores and lift away impurities
- Plumps and hydrates the skin
- Reduces fine lines and wrinkles

An oxygen-rich bath is good for your health

- Increases oxygen levels in the bath up to 70%
- Oxygen improves collagen production
- Energizes cells
- Stimulates immune system
- Kills bacteria
- Promotes healing

The positives of negatively charged ions

- Therapeutic levels of Negative Ions
- Improves serotonin levels
- Neutralizes free radicals
- Relaxes mind and body

Continual, consistent warmth

- Microbubbles stay suspended in water
- Maintains bath temperature
- Creates an improved "sauna effect"

Clean and Green

- Reduces need for soaps and oils
- Eliminates need for heaters

Pg. 152

Unique Competitive Advantages

- 120V/60Hz (Available as 220V/50Hz for export)
- Operating Performance **7 to 8 GPM**
- Completely fills a bath in under 2 minutes
- IAPMO/ETL Listed
- Increases dissolved oxygen levels by **up to 70%**
- Billions of microbubbles producing a dense oxygen saturated cloud
- Therapeutic levels of negative ions: **in excess of 87,000 ions/cc**
- Maintains bath temperature, enhances Sauna Effect: **1°F per 20 minutes**
- Independent testing that reinforces our claims (ESC – Environmental Services Company, Inc.)
- Available as a single hydrotherapy or on Whirlpool or AirMasseur® Combination Baths
- **93% of all our bath models have the option for MicroSilk® (including all freestanding baths)**
- **Features Jason's Quiet Design™ Technology**

Connect With Us:

