



2019 COLLECTION

MAKE IT WONDERFUL

FRANKE

OVER 100 YEARS



PIONEER OF STAINLESS STEEL

In 1911, Hermann Franke, an industrial pioneer, passionate entrepreneur and gifted craftsman, founded a sheet metal business in the small Swiss town of Rorschach. His **pioneering work in stainless steel** set the stage for more than a century of innovation and worldwide success and established Franke as the global leader in smart systems for home kitchens.



1939

CHALLENGES DURING WARTIME

Following Hermann Franke's sudden death in 1939, son **Walter Franke assumed company leadership**. During World War II, Franke met the challenge posed by the scarcity of raw materials by developing the **first standardized home kitchen design**, which allowed sinks to be made using less labor and raw materials and with a manufacturing process that no longer required each element to be produced individually.



1972

COMING TO AMERICA

From the time they met on a train in 1941, Walter Franke, an engineering and manufacturing expert, and Willi Pieper, a sales and finance whiz, had entered many successful ventures. In 1972, the company gained global recognition by supplying a **commercial kitchen system in McDonald's** in Munich, Germany. During that period, Walter Franke, coping with failing health, passed the reigns of leadership to Pieper, who **led the company into the U.S. market** by acquiring a Philadelphia kitchen systems company.

POST-WAR YEARS: BOOM TIME

With the post-war construction boom came a growing demand for sinks, and Franke **began exporting to European countries**, including Austria, Belgium, Italy, Germany, the Netherlands and Sweden and eventually to the United Kingdom. By 1961, business growth required expansion of the company's Aarburg, Switzerland, headquarters and its workforce grew to 750 employees.



2019

Today, Franke is the largest stainless steel sink manufacturer in the world, with 10,500 employees on six continents.

CONTENTS

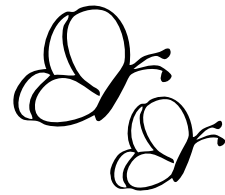

franke.us/ks
facebook.com/FrankeKitchen
pinterest.com/FrankeKitchenUS
instagram.com/FrankeKitchen

houzz.com/pro/FrankeKitchenUS
linkedin.com/company/Franke-Kitchen
architizer.com/brands/Franke
twitter.com/FrankeLuxuryUSA

CONTACT US
 Franke Kitchen Systems
 800 Aviation Parkway, Smyrna, TN 37167
 800-626-5771
ks-customerservice.us@franke.com



- Stainless Steel Sinks
- Fireclay Sinks
- Granite Sinks
- Faucets
- Filtration
- Soap Dispensers
- Waste Disposers
- Accessories
- Quick Reference

STAINLESS STEEL SERIES LUXURY COLLECTION

34-37	Manor House
38-41	Culinary Center
42-45	Chef Center
46-51	Peak
52-58	Professional 2.0
59	Professional Outdoor
60-63	Crystal
64-69	Kubus
70-73	Planar 8
74-79	Pescara
80-82	Orca 2.0
83-85	Orca
86-89	Prestige
90-93	Regatta
94-101	Cube
102-107	Grande
108-111	Rotondo

HOME COLLECTION

114-123	Fast-In
124-127	Home Stainless

FIRECLAY SERIES LUXURY COLLECTION

132-135	Manor House
136-141	Farm House
142-145	Orca
146-149	Prestige
150-153	Cisterna

HOME COLLECTION

154-157	Kinetic
---------	---------

GRANITE SERIES LUXURY COLLECTION

162-167	Peak
168-171	Orca
172-175	Kubus
176-181	Ellipse

HOME COLLECTION

182-185	Primo
186-189	Gravity
190-193	Quantum

FAUCET SERIES LUXURY COLLECTION

202-207	Farm House
208-209	Professional
210	Crystal
211	Masterchef
212-213	Purus
214-215	Chillout
216-217	Planar 8
218-223	Absinthe
224-228	Pescara
229	Peak
230-235	Ambient
236-239	Orca
240-242	Steel
243	Fluence
244-245	Manhattan
246-247	Active
248-249	Kubus
250-253	Cube

HOME COLLECTION

256	Fast-In Faucets
257-259	Home Collection Faucets

FILTRATION

262-273	Filtration Faucets
274-281	Filtration System

SOAP DISPENSERS

282-287	
---------	--

WASTE DISPOSERS

288-295	
---------	--

ACCESSORIES

296-303	
---------	--

QUICK REFERENCE

304-309	Stainless Sinks & Accessories
310	Fireclay Sinks & Accessories
311-312	Granite Sinks & Accessories
313-315	Minimum Cabinet Size
316-319	Faucet Style Guide
320-323	Terms & Conditions
324-327	Category Index
328-331	Alphabetical Index

Cover: CUX16021-W sink with FF4400 faucet

NEW & EXCITING PRODUCTS



A **fireclay sink** that lets you choose which apron front to install. A **kitchen workstation** with an array of essentials built in. Exciting **new features** for a favorite sink. Beautiful **new finishes** to enhance your faucet. And a filtration tap with a **cleverly designed filter** that's installed right on the faucet. These are a few of the exciting additions to Franke's kitchen collection for 2019. Take a look and see how Franke can help you make your kitchen wonderful.

- 1. Farm House Fireclay 138 & 139
- 2. Culinary Center 38-41
- 3. Metallic Faucet Finishes 22-23
- 4. Purus Faucet 212-213
- 5. Orca 2.0 80-82
- 6. Professional Outdoor 59
- 7. Professional Faucets 208-209
- 8. Peak Faucet 229
- 9. Kubus Faucets 248-249
- 10. EcO³ Sanitizing System 301



CULINARY CENTER

COMPACT AND CONVENIENT

Whether it's breakfast on the run or a gourmet dinner for friends, the new Culinary Center makes meal preparation and cleanup a breeze. No more cluttering your cupboards with bulky cutting boards and colanders. No more rummaging through drawers for your favorite knife. With Culinary Center these cooking essentials are always at hand when you need them and neatly tucked away when you don't.

MINIMALIST BEAUTY

The Culinary Center's appeal extends beyond its innovative practicality. The minimalist beauty of clean lines and details such as the round drain cover accentuate the simple elegance of the design.

See pages 38-41 for details.

PERFECTLY ORGANIZED

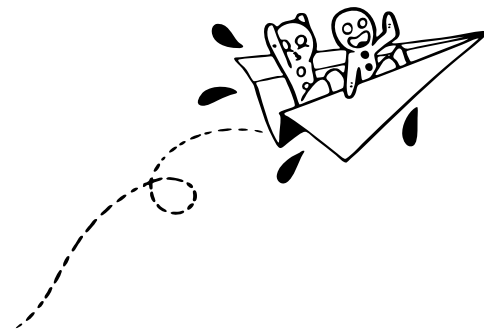

A PLACE FOR EVERYTHING

Think of it as the Swiss Army knife of kitchen workstations. The double-sink Culinary Center features **essential accessories** built right into the sleek design. When tasks are complete, everything stores neatly into this **well-thought-out system**.



DESIGNED FOR THE WAY YOU WORK

The Culinary Center's two cutting boards, colander and draining rack are easily removed and positioned to fit the workflow that's most efficient for you. Rinsing, draining, chopping, dicing and slicing are a snap when **the right tools are at hand**.

DETAILS MATTER

The Culinary Center features dual sinks, both with easy-to-reach corners. The custom-fitted accessories compartment allows you to dry and store the tools you use most so they're ready when you need them. At the end of the day you'll have a **neat and organized kitchen workstation** with everything in its place.

See pages 38-41 for details.



CUTTING BOARDS

CUTTING MAT

COLANDER

DRAINING RACK

3 KNIVES & KNIFE HOLDER

FRAME COVER

GLASS COVER/ CUTTING BOARD

ORCA 2.0

MODERN EDGE

Franke introduces the second generation of Orca – Orca 2.0. **This generously sized sink** is not only larger than its predecessor, but also features an updated design with a modern edge.

ENHANCED PERFORMANCE

Orca 2.0 has **more than a new look**. We've added a shelf grid roller mat and wire basket that fit the integral ledge and enhance your workspace's performance.

WELL-LOVED ACCESSORIES

Complete your Orca 2.0 workstation by adding a solid wood cutting board, a stainless steel colander and a universal roller mat to **make every meal you prepare effortless**.

See pages 80-82 for details.



Pictured: OR2X110 sink with FF3550 faucet



Pictured: FH3K7 10-33WH sink with FF5200 faucet

FARM HOUSE FIRECLAY



FREEDOM OF CHOICE

One finely crafted fireclay sink. Two stunning design options. Franke's new Farm House fireclay sinks are designed with **two distinct apron front styles:** a smooth front for a more traditional look and a fluted side to add texture to the look. You choose the side to install for the look that fits your kitchen style.

EASY CARE

It's easy to maintain the beauty of your Franke Farm House fireclay sink. A dirt-repelling finishing polish **allows stains to be wiped away** with soap and water.

See page 138-139 for details.

PROFESSIONAL OUTDOOR

OUTDOOR STYLE

Whether your preference is for casual backyard barbecues or elaborate summertime soirées, your outdoor kitchen workspace requires a sink that stands up to the elements and enhances your entertaining style. Professional Outdoor is designed with the **attention to detail and quality** that is the hallmark of Franke products.

WEATHER RESISTANT

Manufactured with **high-grade, 18-gauge T316 stainless steel** – the most corrosion resistant grade available – Professional Outdoor can handle rain, cold, snow and heavy use. The simple styling of this undermount design features angled interior lines to promote better draining and help keep your sink clean. Pair it with the weather-resistant Cube faucet, also made of 18-gauge T316 stainless, for an outdoor kitchen that will **retain its beauty and integrity for years**.

Note: It is recommended to cover sink in the winter to prevent ice build up. Ice may damage the bowl by expansion.

See page 59 for details.

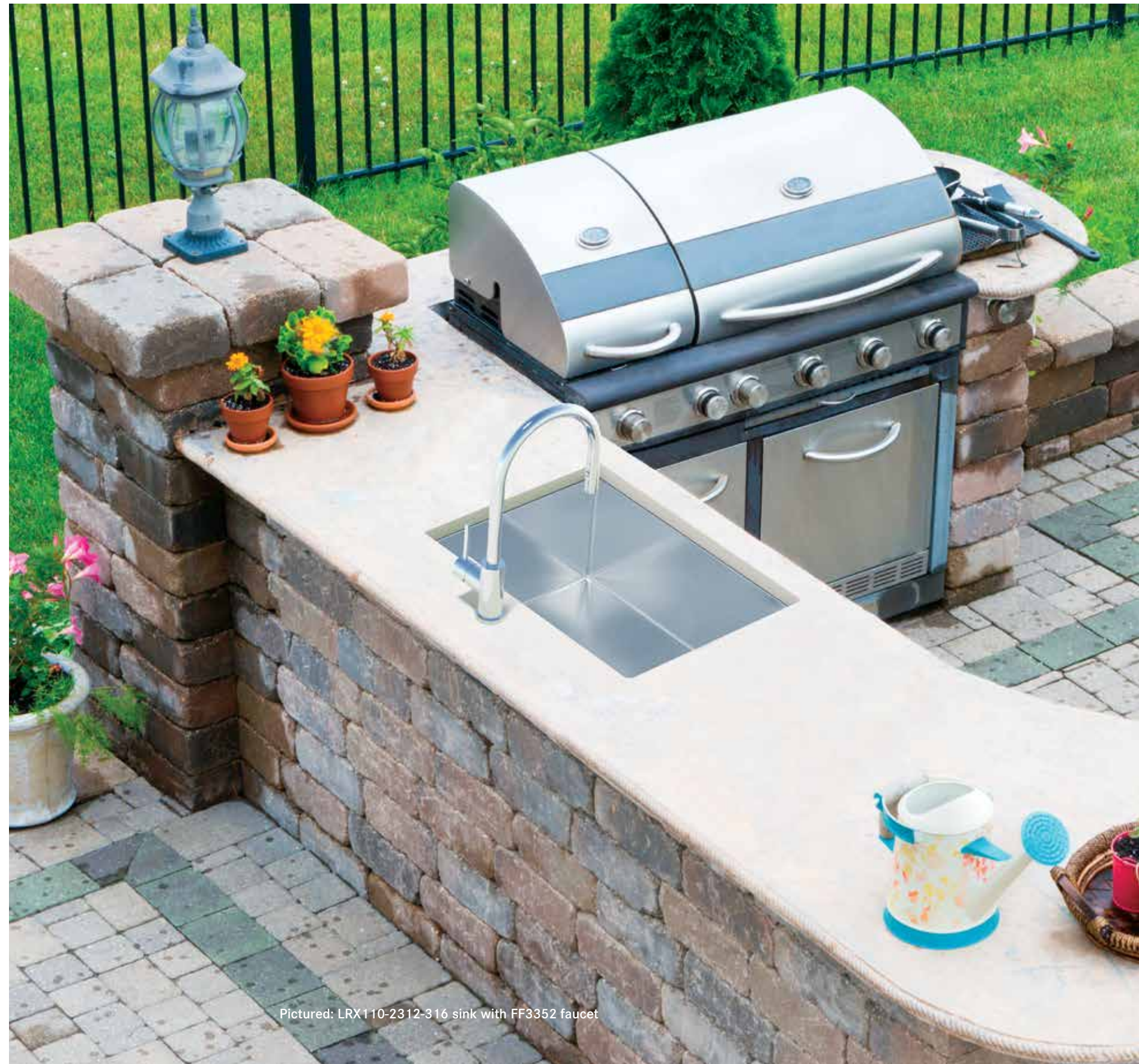

Pictured: LRX110-2312-316 sink with FF3352 faucet



Pictured: FFPD5620 faucet

PURUS FILTRATION

THE EASIEST WAY TO ENJOY CLEAN WATER

Thanks to its **patented filter technology**, the Franke Clear Water Capsule System cleans water simply, quickly and reliably. Developed in Switzerland, easy to use and impeccably designed, it's the **most advanced water filter system in the world**. For the most wonderful tap water you've ever tasted.

CONVENIENT & EASY TO USE

The system is so compact that **no filter installation under the sink is required**. Simply order capsules conveniently online and enjoy superb water day after day.

HYGIENIC & SAFE

The flow of water from the filter straight into the glass and the combination of **activated carbon** and a **high-tech membrane** ensure supreme water quality. The filter removes bacteria, viruses, pesticides, hormones and microplastics. Not only does tap water taste better, it is also much healthier.

STYLISH & ICONIC

The Purus faucets with the Franke Clear Water Capsule System look stunning in any kitchen: an **iconic design, space-saving** and available in various designs and colors.

See pages 212-213 for details.

FILLED WITH MANY ADVANTAGES

- Reduces 99.9999% of bacteria*
- Reduces 99% of viruses*
- Filters out rust and sediments
- Filters out microplastics
- Removes odors and improves taste
- Filters up to 132 gallons



*Restrictions apply for the States of California, Iowa and Wisconsin

PURUS FILTRATION

A LITTLE WONDER

Our water filter is not only the **smallest in the world**, but is also the first to combine activated carbon with a bionic membrane. Modelled on nature; developed in Switzerland.

1. PRE-FILTER

The pre-filter is the first line of defense, **eliminating coarse contamination**. Larger particles are filtered out and retained.

2. MEMBRANE

Nanotechnology makes it possible: the 0.06 mm thick membrane, enclosed in a fine nylon mesh, even filters bacteria from your drinking water.

3. ACTIVATED CARBON FILTER

Activated carbon **removes impurities**. The underlying technology is a natural physical process that has been proven over decades.

4. WATER FLOW

First through the pre-filter, then through the membrane, finally through the activated carbon and filtered straight into the glass. Our patented filter technology prevents filtered and unfiltered water crossing each other's path.

See pages 212-213 for details.



Pictured: FF4250 faucet with DW5600 filtration faucet

WHERE THE MAGIC HAPPENS

The best water filter in the world is also the smallest. That's something of a marvel given what's inside. It is the **first system ever to combine activated carbon with a high-tech membrane** and turns **132 gallons** of tap water into pure refreshment.

REORDERING

When the LED light turns red on the faucet, the filter has to be changed.



METALLIC FAUCET FINISHES

MAKE YOUR STATEMENT

Franke's new metallic faucet finishes complete the design statement in your well-appointed kitchen. Complement or contrast your sink with one of **seven new finishes**, from Matte Black for a sophisticated, modern appeal; to earthy Bronze or rich, bold Copper, to accent cabinetry and countertops.



20

MATTE BLACK



22

SHINY BLACK



40

GUN METAL



61

COPPER



65

BRONZE



70

POLISHED NICKEL



90

SATIN BRASS



Note: Numbers correspond to last two digits of product number. e.g., FF39**40**. Finishes available on select faucets.

PROFESSIONAL FAUCETS

WORK LIKE A PRO

Now serious home chefs can have the same faucets used by the pros. Franke's Professional series faucets feature a **360-degree swivel**, **one-handed operation** and a **powerful pull-down spray**, giving you the flexibility to prep, cook and clean. For pure water right from the tap, choose the FFPD5400 **all-in-one filtration faucet**.

See pages 208-209 for details.

Pictured: FFPD5400 faucet

FF5300

FFPD5300

FFPD5400



PEAK FAUCET

MODERN DESIGN STATEMENT
The **clean lines** and **metropolitan elegance** of the new Peak faucets demonstrates that design and function can hold equal status in your kitchen. Pair this semi-pro pull-down faucet with a Peak granite or stainless steel sink, for a kitchen that works and looks the way you want it to.



See page 229 for details.



KUBUS FAUCETS



SIMPLY BEAUTIFUL
Like the Kubus family of sinks, the new Kubus faucets bring a strikingly simple design to your kitchen while offering a **host of useful features** including a cleverly designed **pull-down spray**. When work is complete, the hose neatly retracts. The inclined design is the perfect height for large pots.

See pages 248-249 for details.





POWERFUL GREEN & CLEAN

Now your kitchen can be clean and sanitized without using harmful chemicals. The new Franke EcO³ Sanitizing System **kills 99.9 percent of harmful bacteria** found on hard, nonporous kitchen surfaces, including E. coli, salmonella and staph. In fact, EcO³ is twice as effective as bleach, kills bacteria 3,000 times faster and reduces odor when used as directed.

The EcO³ Sanitizing System turns common tap water into a **natural aqueous ozone solution**. It's the same technology that has been used for years to disinfect and purify drinking water and sanitize food processing areas. Just spray and wipe; no rinsing is required.

See page 301 for details.



DID YOU KNOW

You can contract food poisoning by simply touching a contaminated surface then putting your fingers in your mouth.



WHY FRANKE STAINLESS STEEL?

Stainless steel is the material most frequently used for sinks, and the most popular countertop for commercial kitchens. As one of the world's largest buyers of stainless steel for kitchens, we have perfected its evolution over decades to bring you unique quality.

WHAT MAKES IT SO SPECIAL?

A classic material that can handle any temperature, is very hygienic and offers a timeless aesthetic.

Corrosion resistant: premium quality chrome nickel steel makes sinks highly resistant to staining, rust and corrosion

Pore-free: naturally hygienic

Self-regenerating: stainless steel surfaces develop a passive protective layer that continuously renews, so your sink is easy to clean and care for

Durable: temperature and acid resistant

Environmentally-friendly: 100% recyclable

CHOOSING THE IDEAL GAUGE

The standard gauge describes the thickness of a metal sheet, on a scale from 8 to 30. The lower the number, the thicker the metal sheet. The thicker it is, the less it can be bent or dented and the quieter it is in use. But if too thin, it becomes impossible to produce a sink from a single sheet of metal. So we take great care when choosing the right standard gauge for our sinks:

- Deep-drawn sinks in full size have a standard 18-20 gauge
- Hand-made sinks have a standard 16-18 gauge
- Smaller accessory bowls are standard gauge 18-22

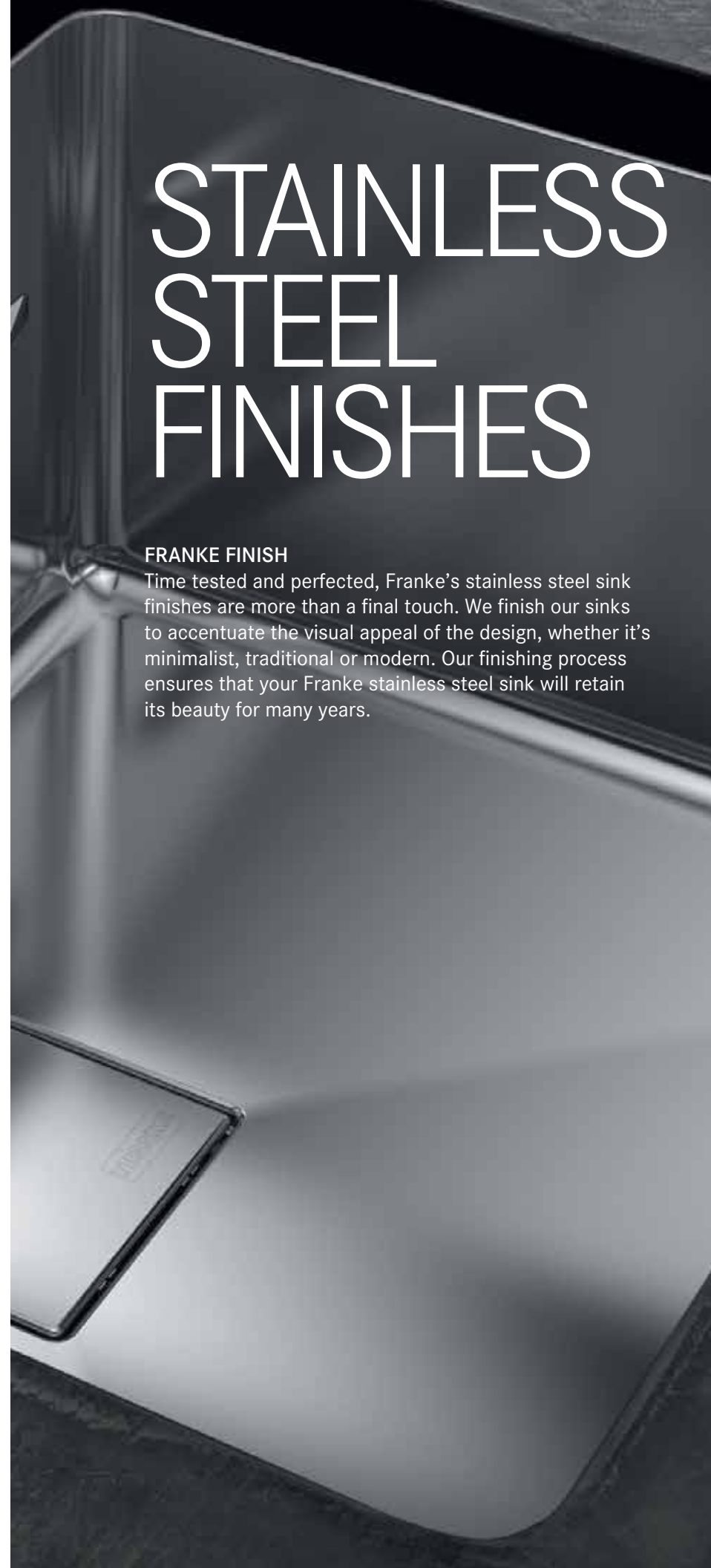

STAINLESS STEEL FINISHES

FRANKE FINISH

Time tested and perfected, Franke's stainless steel sink finishes are more than a final touch. We finish our sinks to accentuate the visual appeal of the design, whether it's minimalist, traditional or modern. Our finishing process ensures that your Franke stainless steel sink will retain its beauty for many years.



DIAMOND FINISH

Our Diamond finish creates a shiny, almost flawless, appearance that highlights the sink's elegance and makes it an attractive centerpiece to your kitchen.



PEARL FINISH

This Franke exclusive is fingerprint proof and feels warm to the touch.



SILK FINISH

This elegant, easy-to-clean finish is beautifully shiny in appearance and nearly scratch resistant.



STAINLESS STEEL SINKS

LUXURY COLLECTION

Manor House	34-37
Culinary Center	38-41
Chef Center	42-45
Peak	46-51
Professional 2.0	52-58
Professional Outdoor	59
Crystal	60-63
Kubus	64-69
Planar 8	70-73
Pescara	74-79
Orca 2.0	80-82
Orca	83-85
Prestige	86-89
Regatta	90-93
Cube	94-101
Grande	102-107
Rotondo	108-111

HOME COLLECTION

Fast-In	114-123
Home Stainless	124-127



Pictured: PS2X110-33 sink with FFP3450 faucet, LB13150 filtration faucet and SD3450 soap dispenser



Pictured: MHX710-36 sink with FF6000A faucet



MANOR HOUSE

Reminiscent of fine family heirlooms, the elegant timeless details of the Manor House **apron front** sink creates heritage-inspired design. **Soft lines, commercial grade stainless steel** and a **large deep bowl** add a refined sophistication to any kitchen.



MHX710-30 \$1,995



SPECIFICATIONS

Interior Dimensions: 26 1/2" x 16 3/16" x 9 1/16"
 Exterior Dimensions: 30" x 20 7/8"
 Minimum Cabinet Size: 30"
 Gauge: 16
 Weight: 39 lbs.
 Sound Dampening: Sound Pad
 Stainless Finish: Pearl
 Corner Radius: 19mm
 Installation: Apron Front
 Sides and back are not finished.

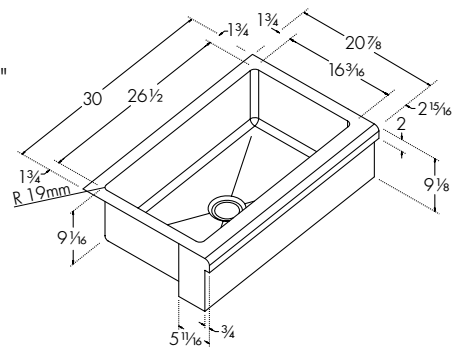

ACCESSORIES

1 Bottom Grid MH30-36S	4 Cutting Board OA-40S	5 Twist Waste Kit FRTWIST-SN	6 Strainer Basket 906 906SN	7 Inox Cream 903
----------------------------------	----------------------------------	--	--	----------------------------

MHX710-33 \$2,395



SPECIFICATIONS

Interior Dimensions: 29 1/2" x 16 3/16" x 9 1/16"
 Exterior Dimensions: 33" x 20 7/8"
 Minimum Cabinet Size: 33"
 Gauge: 16
 Weight: 46 lbs.
 Sound Dampening: Sound Pad
 Stainless Finish: Pearl
 Corner Radius: 19mm
 Installation: Apron Front
 Sides and back are not finished.

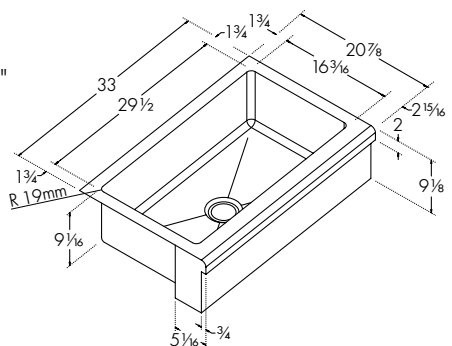

ACCESSORIES

2 Bottom Grid MH33-36S	4 Cutting Board OA-40S	5 Twist Waste Kit FRTWIST-SN	6 Strainer Basket 906 906SN	7 Inox Cream 903
----------------------------------	----------------------------------	--	--	----------------------------

MHX710-36 \$2,895



SPECIFICATIONS



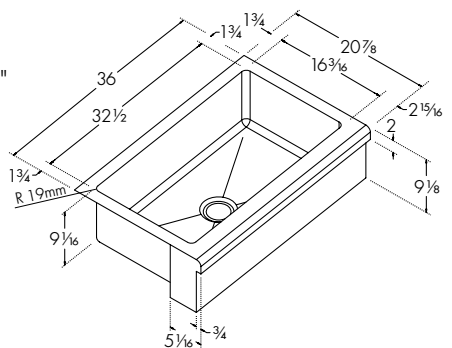



Interior Dimensions: 32 1/2" x 16 3/16" x 9 1/16"
 Exterior Dimensions: 36" x 20 7/8"
 Minimum Cabinet Size: 36"
 Gauge: 16
 Weight: 46 lbs.
 Sound Dampening: Sound Pad
 Stainless Finish: Pearl
 Corner Radius: 19mm
 Installation: Apron Front
 Sides and back are not finished.

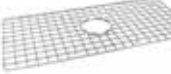

ACCESSORIES

3 Bottom Grid MH36-36S	4 Cutting Board OA-40S	5 Twist Waste Kit FRTWIST-SN	6 Strainer Basket 906 906SN	7 Inox Cream 903
----------------------------------	----------------------------------	--	--	----------------------------

ACCESSORIES

-  **1 Bottom Grid**
26 1/8" x 15 13/16"
Stainless
MH30-36S
\$212
-  **2 Bottom Grid**
29 1/8" x 15 13/16"
Stainless
MH33-36S
\$233
-  **3 Bottom Grid**
32 1/8" x 15 13/16"
Stainless
MH36-36S
\$254
-  **4 Cutting Board**
14 1/2" x 21 7/8"
Solid Wood
OA-40S
\$350
-  **5 Twist Waste Kit**
FRTWIST-SN
\$155
-  **6 Strainer Basket**
Chrome
906
\$62
Satin Nickel
906SN
\$85
-  **7 Inox Cream**
Stainless
Steel Polish
903
\$31



WONDERFUL EXTRAS

TWIST WASTE KIT

OUR TWIST WASTE KIT ALLOWS THE SINK TO DRAIN WITH A SIMPLE TWIST. NO NEED TO PUT YOUR HANDS INTO THE DIRTY WATER.

Note: All accessories sold separately unless otherwise indicated. Design of custom accessories subject to change without notice. It is absolutely critical that you have the sink and any custom sink accessories on site prior to any cut or modification to the countertop. Franke will not be responsible for any errors in countertop preparation and sink installation.

CULINARY CENTER

Innovation meets **minimalist beauty** with the new Culinary Center. Packed with **built-in features** that put everyday tools at your fingertips as you work, this **double-sink workstation** makes a magnificent transformation to a clean, modern statement in elegance.



Pictured: CUX16021-W sink with FF4400 faucet

CULINARY CENTER STAINLESS

FRANKE.US/KS

NEW CUX11010-W \$1,695
Available Spring 2019



SPECIFICATIONS

Interior Dimensions: 10⁵/₁₆" x 18⁷/₈" x 8¹/₁₆"
Exterior Dimensions: 13¹/₈" x 21³/₈"
Minimum Cabinet Size: 18"
Gauge: 19
Weight: 19 lbs.
Sound Dampening: Sound Pad
Stainless Finish: Diamond
Corner Radius: 12mm
Installation: Undermount with 1/2" Reveal

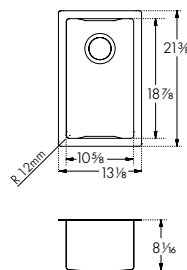

ACCESSORIES (SOLD SEPARATELY)

- | | | | | | | | | |
|------------------------------------|------------------------------------|----------------------------------|--|---|-------------------------------|--------------------------------|-------------------------------|---------------------------------|
| 1 Cutting Board
CU-40S | 2 Cutting Board
CU-40P | 3 Cutting Mat
SP-41S | 4 Glass Cover/
Cutting Board
CU-GC | 5 Knife Holder +
Cutting Board
CU-40K | 6 Knife Set
CU-KS | 7 Colander
CUW-70S | 8 Wire Rack
CU-WR | 9 Frame Cover
CU-FC |
|------------------------------------|------------------------------------|----------------------------------|--|---|-------------------------------|--------------------------------|-------------------------------|---------------------------------|

NEW CUX16021-W \$2,295
Available Spring 2019



SPECIFICATIONS

Interior Dimensions: 32¹/₁₆" x 18⁷/₈" x 9³/₁₆" & 8¹/₁₆"
Exterior Dimensions: 35³/₁₆" x 21³/₈"
Minimum Cabinet Size: 39"
Gauge: 19
Weight: 50 lbs.
Sound Dampening: Sound Pad
Stainless Finish: Diamond
Corner Radius: 12mm
Installation: Undermount with 1/2" Reveal

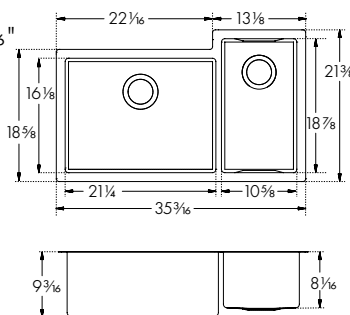

INCLUDED ACCESSORIES

- | | | | | | | | | |
|------------------------------------|------------------------------------|----------------------------------|--|---|-------------------------------|--------------------------------|-------------------------------|---------------------------------|
| 1 Cutting Board
CU-40S | 2 Cutting Board
CU-40P | 3 Cutting Mat
SP-41S | 4 Glass Cover/
Cutting Board
CU-GC | 5 Knife Holder +
Cutting Board
CU-40K | 6 Knife Set
CU-KS | 7 Colander
CUW-70S | 8 Wire Rack
CU-WR | 9 Frame Cover
CU-FC |
|------------------------------------|------------------------------------|----------------------------------|--|---|-------------------------------|--------------------------------|-------------------------------|---------------------------------|

ACCESSORIES

- | | | | | |
|--|---|---|---|--|
| 
1 Cutting Board
7 ¹ / ₁₆ " x 16 ⁷ / ₈ "
Walnut
CU-40S
\$145
Included with
CUX16021-W only | 
2 Cutting Board
7 ¹ / ₁₆ " x 16 ⁷ / ₈ "
Black Plastic
CU-40P
\$95
Included with
CUX16021-W only | 
3 Cutting Mat
17 ³ / ₄ " x 11 ¹ / ₄ "
Silicone
SP-41S
\$29
Included with
CUX16021-W only | 
4 Glass Cover/
Cutting Board
11 ¹ / ₂ " x 19 ³ / ₄ "
Black Glass
CU-GC
\$115
Included with
CUX16021-W only | 
5 Knife Holder+
Cutting Board
7 ³ / ₁₆ " x 16 ⁷ / ₈ "
Walnut
CU-40K
\$235
Included with
CUX16021-W only |
| 
6 Knife Set
Set of 3
Black
CU-KS
\$95
Included with
CUX16021-W only | 
7 Colander
6 ³ / ₁₆ " x 17 ⁷ / ₈ " x 2 ¹ / ₈ "
Stainless
CUW-70S
\$191
Included with
CUX16021-W only | 
8 Wire Rack
18 ³ / ₄ " x 11"
Stainless
CU-WR
\$125
Included with
CUX16021-W only | 
9 Frame Cover
10 ¹ / ₂ " x 18 ¹³ / ₁₆ "
Black
CU-FC
\$195
Included with
CUX16021-W only | |

Note: All accessories sold separately unless otherwise indicated. Design of custom accessories subject to change without notice. It is absolutely critical that you have the sink and any custom sink accessories on site prior to any cut or modification to the countertop. Franke will not be responsible for any errors in countertop preparation and sink installation.





Chef Center
Stainless



Chef Center
Stainless



CHEF CENTER

Franke's Chef Center gives you the power of a beautifully designed sink system. **Every accessory is included** and right at hand.

The Chef Center's **wide basin** accommodates large pots and pans easily. The **multi-level sink grid** and **roller mat** are practical accessories designed for any kitchen task, including drying dishes and stemware. A generously sized **drain board** features a sloped design that fits over the edge of the sink to direct water back into the sink.



Pictured: CUX11024-W sink with FF4980 faucet

CUX11018-W \$2,399

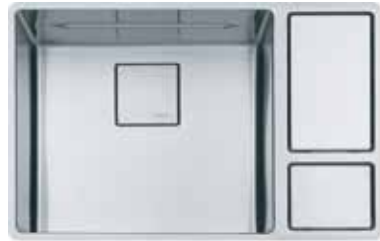

SPECIFICATIONS

Interior Dimensions: 18 1/8" x 16 1/8" x 9"
 Exterior Dimensions: 28 1/8" x 18 7/8"
 Minimum Cabinet Size: 33"
 Gauge: 18
 Weight: 55 lbs.
 Sound Dampening: Sound Pad & Spray Coat
 Stainless Finish: Diamond
 Integral Franke Ledge System
 Corner Radius: 12mm
 Installation: Undermount with 1/2" Reveal

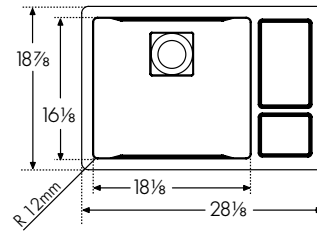

INCLUDED ACCESSORIES

- | | | | | | | |
|--|---|--------------------------------|------------------------------|---------------------------------|---------------------------------|--------------------------------|
| 1 Bottom/ Shelf Grid
CUW18-36S | 4 Glass Cutting Board
CUW-40S | 5 Cutting Mat
SP-40S | 6 Colander
CUW-70S | 7 Roller Mat
CUW-36RM | 8 Drain Board
CUW-60S | 9 Drain Cover
PKGCVR |
|--|---|--------------------------------|------------------------------|---------------------------------|---------------------------------|--------------------------------|

CUX11024-W \$2,599



SPECIFICATIONS

Interior Dimensions: 23 5/8" x 16 1/8" x 9"
 Exterior Dimensions: 33 5/8" x 18 7/8"
 Minimum Cabinet Size: 36"
 Gauge: 18
 Weight: 57 lbs.
 Sound Dampening: Sound Pad & Spray Coat
 Stainless Finish: Diamond
 Integral Franke Ledge System
 Corner Radius: 12mm
 Installation: Undermount with 1/2" Reveal

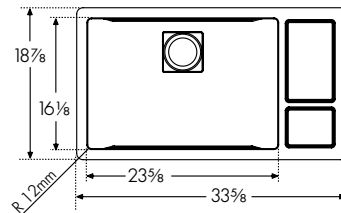

INCLUDED ACCESSORIES

- | | | | | | | |
|--|---|--------------------------------|------------------------------|---------------------------------|---------------------------------|--------------------------------|
| 2 Bottom/ Shelf Grid
CUW24-36S | 4 Glass Cutting Board
CUW-40S | 5 Cutting Mat
SP-40S | 6 Colander
CUW-70S | 7 Roller Mat
CUW-36RM | 8 Drain Board
CUW-60S | 9 Drain Cover
PKGCVR |
|--|---|--------------------------------|------------------------------|---------------------------------|---------------------------------|--------------------------------|

CUX11031-W \$2,799



SPECIFICATIONS

Interior Dimensions: 31 5/8" x 16 1/8" x 9"
 Exterior Dimensions: 41 5/8" x 18 7/8"
 Minimum Cabinet Size: 45"
 Gauge: 18
 Weight: 60 lbs.
 Sound Dampening: Sound Pad & Spray Coat
 Stainless Finish: Diamond
 Integral Franke Ledge System
 Corner Radius: 12mm
 Installation: Undermount with 1/2" Reveal

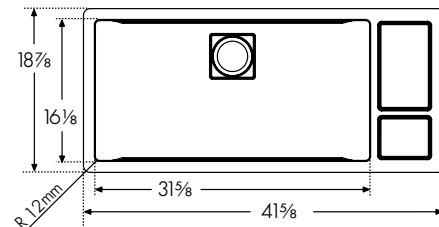

INCLUDED ACCESSORIES

- | | | | | | | |
|--|---|--------------------------------|------------------------------|---------------------------------|---------------------------------|--------------------------------|
| 3 Bottom/ Shelf Grid
CUW31-36S | 4 Glass Cutting Board
CUW-40S | 5 Cutting Mat
SP-40S | 6 Colander
CUW-70S | 7 Roller Mat
CUW-36RM | 8 Drain Board
CUW-60S | 9 Drain Cover
PKGCVR |
|--|---|--------------------------------|------------------------------|---------------------------------|---------------------------------|--------------------------------|

INCLUDED ACCESSORIES

- | | | | | | |
|--|--|--|---|--|---|
| 1 Bottom/ Shelf Grid
17 13/16" x 15 7/8"
Stainless
CUW18-36S
Included | 2 Bottom/ Shelf Grid
23 11/32" x 15 7/8"
Stainless
CUW24-36S
Included | 3 Bottom/ Shelf Grid
31 1/2" x 16"
Stainless
CUW31-36S
Included | 4 Glass Cutting Board
10 9/16" x 17 1/16"
Glass
CUW-40S
Included | 5 Cutting Mat
9 13/16" x 14 7/8"
Silicone
SP-40S
Included | 6 Colander
6 3/16" x 17 5/8" x 2 1/8"
Stainless
CUW-70S
Included |
|--|--|--|---|--|---|

OPTIONAL ACCESSORIES

- | | | | | | |
|---|---|--|--|--|---|
| 7 Roller Mat
17" x 15 7/8"
Stainless
CUW-36RM
Included | 8 Drain Board
13 1/2" x 18 3/8"
Stainless
CUW-60S
Included | 9 Drain Cover
4 7/8" x 4 7/8"
Stainless
PKGCVR
Included | Push Button Strainer Kit
Chrome
906P-C
\$124
Satin Nickel
906P-SN
\$145 | Strainer Basket
Chrome
906
\$62
Satin Nickel
906SN
\$85 | Inox Cream
Stainless
Steel Polish
903
\$31 |
|---|---|--|--|--|---|



WONDERFUL EXTRAS
 THE CHEF CENTER

ALLOWS YOU TO CHOP AND TRIM YOUR FOOD THEN DISPOSE OF SCRAPS INTO THE COMPOST BUCKET. ONCE YOUR PREP IS COMPLETE, REMOVE THE BUCKET AND EMPTY ITS CONTENTS INTO YOUR COMPOST PILE.

Note: All accessories sold separately unless otherwise indicated. Design of custom accessories subject to change without notice. It is absolutely critical that you have the sink and any custom sink accessories on site prior to any cut or modification to the countertop. Franke will not be responsible for any errors in countertop preparation and sink installation.



Pictured: PKX11025 sink with FFPD5550 faucet and SD2600 soap dispenser



PEAK

Elegantly simple and exceedingly functional, the Peak Collection exudes luxury. **Clean lines** and **5mm corner radius** maximize workspace. The **square drain cover** complements the minimalist design while obscuring the strainer and waste disposer.

Accessories such as shelf grids, colanders and cutting boards fit perfectly in the **integral ledge system** and expand functionality to fit any chef's food preparation style.



PKX1108 \$1,170



SPECIFICATIONS

Interior Dimensions: 7 1/8" x 16 1/2" x 7 1/8"
 Exterior Dimensions: 8 1/4" x 17 3/4"
 Minimum Cabinet Size: 12"
 Gauge: 18
 Weight: 9 lbs.
 Sound Dampening: Sound Pad & Spray Coat
 Stainless Finish: Diamond
 Corner Radius: 5mm
 Installation: Undermount

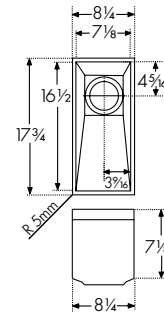

ACCESSORIES

- | | | | | |
|-----------------------------|---|---|--|--------------------------------|
| 6 Colander
PX-70S | 7 Universal
Roller Mat
UV-36RM | 8 Twist
Waste Kit
FRTWIST-SN | 9 Drain Cover
PKXCVR
Included | 10 Inox
Cream
903 |
|-----------------------------|---|---|--|--------------------------------|

PKX11013 \$1,870



SPECIFICATIONS

Interior Dimensions: 13 3/8" x 16 1/2" x 9 5/8"
 Exterior Dimensions: 14 1/8" x 17 3/4"
 Minimum Cabinet Size: 18"
 Gauge: 16
 Weight: 19 lbs.
 Sound Dampening: Sound Pad & Spray Coat
 Stainless Finish: Diamond
 Integral Franke Ledge System
 Corner Radius: 5mm
 Installation: Undermount

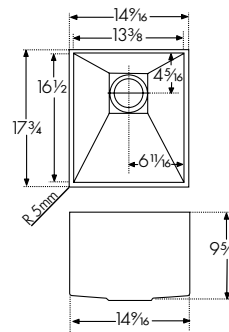

ACCESSORIES

- | | | | | | |
|--|-----------------------------|---|---|--|--------------------------------|
| 1 Bottom/
Shelf Grid
PX-13S | 6 Colander
PX-70S | 7 Universal
Roller Mat
UV-36RM | 8 Twist
Waste Kit
FRTWIST-SN | 9 Drain Cover
PKXCVR
Included | 10 Inox
Cream
903 |
|--|-----------------------------|---|---|--|--------------------------------|

PKX11016 \$2,070



SPECIFICATIONS

Interior Dimensions: 15 3/4" x 16 1/2" x 9 5/8"
 Exterior Dimensions: 16 7/8" x 17 3/4"
 Minimum Cabinet Size: 21"
 Gauge: 16
 Weight: 21 lbs.
 Sound Dampening: Sound Pad & Spray Coat
 Stainless Finish: Diamond
 Integral Franke Ledge System
 Corner Radius: 5mm
 Installation: Undermount

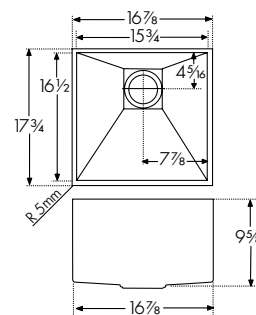

ACCESSORIES

- | | | | | | | |
|--|-------------------------------------|-----------------------------|---|---|--|--------------------------------|
| 2 Bottom/
Shelf Grid
PX-16S | 5 Cutting
Board
PX-40S | 6 Colander
PX-70S | 7 Universal
Roller Mat
UV-36RM | 8 Twist
Waste Kit
FRTWIST-SN | 9 Drain Cover
PKXCVR
Included | 10 Inox
Cream
903 |
|--|-------------------------------------|-----------------------------|---|---|--|--------------------------------|

PKX11018 \$2,230



SPECIFICATIONS

Interior Dimensions: 17 3/4" x 16 1/2" x 9 5/8"
 Exterior Dimensions: 18 7/8" x 17 3/4"
 Minimum Cabinet Size: 24"
 Gauge: 16
 Weight: 22 lbs.
 Sound Dampening: Sound Pad & Spray Coat
 Stainless Finish: Diamond
 Integral Franke Ledge System
 Corner Radius: 5mm
 Installation: Undermount

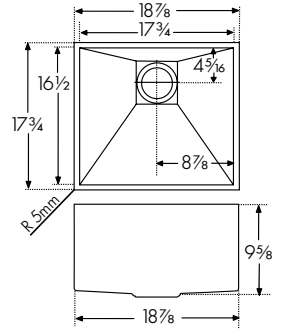

ACCESSORIES

- | | | | | | | |
|--|-------------------------------------|-----------------------------|---|---|--|--------------------------------|
| 3 Bottom/
Shelf Grid
PX-18S | 5 Cutting
Board
PX-40S | 6 Colander
PX-70S | 7 Universal
Roller Mat
UV-36RM | 8 Twist
Waste Kit
FRTWIST-SN | 9 Drain Cover
PKXCVR
Included | 10 Inox
Cream
903 |
|--|-------------------------------------|-----------------------------|---|---|--|--------------------------------|

PKX11021 \$2,370



SPECIFICATIONS

Interior Dimensions: 21 5/8" x 16 1/2" x 9 5/8"
 Exterior Dimensions: 22 13/16" x 17 3/4"
 Minimum Cabinet Size: 27"
 Gauge: 16
 Weight: 25 lbs.
 Sound Dampening: Sound Pad & Spray Coat
 Stainless Finish: Diamond
 Integral Franke Ledge System
 Corner Radius: 5mm
 Installation: Undermount

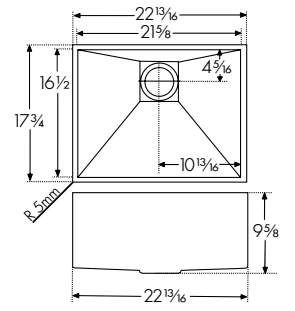

ACCESSORIES

- | | | | | | | |
|--|-------------------------------------|-----------------------------|---|---|--|--------------------------------|
| 4 Bottom/
Shelf Grid
PX-21S | 5 Cutting
Board
PX-40S | 6 Colander
PX-70S | 7 Universal
Roller Mat
UV-36RM | 8 Twist
Waste Kit
FRTWIST-SN | 9 Drain Cover
PKXCVR
Included | 10 Inox
Cream
903 |
|--|-------------------------------------|-----------------------------|---|---|--|--------------------------------|

ACCESSORIES

- | | | | | |
|--|--|--|--|---|
| 1 Bottom/
Shelf Grid
13 1/8" x 16 1/4"
Stainless
PX-13S
\$137 | 2 Bottom/
Shelf Grid
15 1/2" x 16 1/4"
Stainless
PX-16S
\$137 | 3 Bottom/
Shelf Grid
17 1/2" x 16 1/4"
Stainless
PX-18S
\$150 | 4 Bottom/
Shelf Grid
21 3/8" x 16 1/4"
Stainless
PX-21S
\$181 | 5 Cutting Board
14 3/8" x 17 1/8"
Solid Wood
PX-40S
\$212 |
|--|--|--|--|---|

- | | | | | |
|---|---|--|--|---|
| 6 Colander
17 7/8" x 6 1/8" x 2 1/8"
Stainless
PX-70S
\$202 | 7 Universal
Roller Mat
18 7/8" x 20"
Stainless
UV-36RM
\$160 | 8 Twist Waste Kit
FRTWIST-SN
\$155 | 9 Drain Cover
4 7/8" x 4 7/8"
Stainless
PKXCVR
\$95

One included
with each sink. | 10 Inox Cream
Stainless
Steel Polish
903
\$31 |
|---|---|--|--|---|

Note: All accessories sold separately unless otherwise indicated. Design of custom accessories subject to change without notice. It is absolutely critical that you have the sink and any custom sink accessories on site prior to any cut or modification to the countertop. Franke will not be responsible for any errors in countertop preparation and sink installation.

Note: All accessories sold separately unless otherwise indicated. Design of custom accessories subject to change without notice. It is absolutely critical that you have the sink and any custom sink accessories on site prior to any cut or modification to the countertop. Franke will not be responsible for any errors in countertop preparation and sink installation.

PKX11025 \$2,430



SPECIFICATIONS

Interior Dimensions: 25" x 16 1/2" x 9 5/8"
 Exterior Dimensions: 26 3/16" x 17 3/4"
 Minimum Cabinet Size: 30"
 Gauge: 16
 Weight: 27 lbs.
 Sound Dampening: Sound Pad & Spray Coat
 Integral Franke Ledge System
 Stainless Finish: Diamond
 Corner Radius: 5mm
 Installation: Undermount

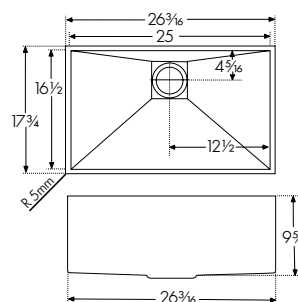

ACCESSORIES

- 2 **Bottom/ Shelf Grid** PX-25S
- 4 **Cutting Board** PX-40S
- 5 **Colander** PX-70S
- 6 **Universal Roller Mat** UV-36RM
- 7 **Twist Waste Kit** FRTWIST-SN
- 8 **Drain Cover** PKXCVR Included
- 9 **Inox Cream** 903

PKX11028 \$2,530



SPECIFICATIONS

Interior Dimensions: 27 9/16" x 16 1/2" x 9 5/8"
 Exterior Dimensions: 28 3/4" x 17 3/4"
 Minimum Cabinet Size: 33"
 Gauge: 16
 Weight: 29 lbs.
 Sound Dampening: Sound Pad & Spray Coat
 Integral Franke Ledge System
 Stainless Finish: Diamond
 Corner Radius: 5mm
 Installation: Undermount

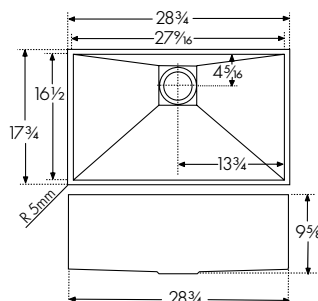

ACCESSORIES

- 3 **Bottom/ Shelf Grid** PX-28S
- 4 **Cutting Board** PX-40S
- 5 **Colander** PX-70S
- 6 **Universal Roller Mat** UV-36RM
- 7 **Twist Waste Kit** FRTWIST-SN
- 8 **Drain Cover** PKXCVR Included
- 9 **Inox Cream** 903

PKX160 \$2,870
PKX160LH \$2,870



(PKX160 Shown)

SPECIFICATIONS

Interior Dimensions: 29 3/4" x 16 1/2" x 9 5/8" & 7 1/8"
 Exterior Dimensions: 30 7/8" x 17 3/4"
 Minimum Cabinet Size: 36"
 Gauge: 16
 Weight: 35 lbs.
 Sound Dampening: Sound Pad & Spray Coat
 Stainless Finish: Diamond
 Integral Franke Ledge System: Left Bowl
 Corner Radius: 5mm
 Installation: Undermount

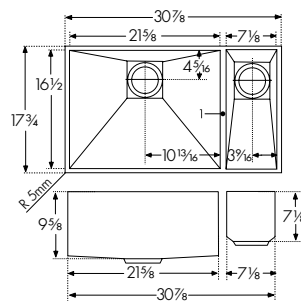

ACCESSORIES

- 1 **Bottom/ Shelf Grid** PX-21S
- 4 **Cutting Board** PX-40S
- 5 **Colander** PX-70S
- 6 **Universal Roller Mat** UV-36RM
- 7 **Twist Waste Kit** FRTWIST-SN
- 8 **Drain Cover** PKXCVR (2) Included
- 9 **Inox Cream** 903

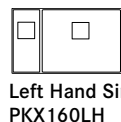

ACCESSORIES

- 1 **Bottom/ Shelf Grid** 21 3/8" x 16 1/4" Stainless PX-21S **\$181**
- 2 **Bottom/ Shelf Grid** 24 3/4" x 16 15/16" Stainless PX-25S **\$191**
- 3 **Bottom/ Shelf Grid** 27 9/16" x 16 5/16" Stainless PX-28S **\$202**
- 4 **Cutting Board** 14 3/8" x 17 1/8" Solid Wood PX-40S **\$212**
- 5 **Colander** 17 9/16" x 6 1/8" x 2 1/8" Stainless PX-70S **\$202**
- 6 **Universal Roller Mat** 18 7/16" x 20" Stainless UV-36RM **\$160**
- 7 **Twist Waste Kit** FRTWIST-SN **\$155**
- 8 **Drain Cover** 4 7/8" x 4 7/8" Stainless PKXCVR **\$95**

One included with each sink. PKX160 & PKX160LH include two.
- 9 **Inox Cream** Stainless Steel Polish 903 **\$31**

PERFECT TOGETHER
PEAK FAUCET

For the complete PEAK Faucet Collection see page 229



Note: All accessories sold separately unless otherwise indicated. Design of custom accessories subject to change without notice. It is absolutely critical that you have the sink and any custom sink accessories on site prior to any cut or modification to the countertop. Franke will not be responsible for any errors in countertop preparation and sink installation.

PROFESSIONAL 2.0

The second generation of this hard-working sink features an **updated diamond stainless finish** that offers enduring beauty for years. Made of **16 gauge**, commercial-grade stainless steel and available in **a variety of size and configuration options**, it's the perfect partner for the serious home chef.



Pictured: PS2X110-33 sink with FFP3450 faucet, LB13150 filtration faucet and SD3450 soap dispenser

PS2X110-15 \$1,395



SPECIFICATIONS

Interior Dimensions: 15" x 17" x 8"
 Exterior Dimensions: 17½" x 19½"
 Minimum Cabinet Size: 21"
 Gauge: 16
 Weight: 21 lbs.
 Sound Dampening: Sound Pad and Spray Coat
 Stainless Finish: Diamond
 Corner Radius: 8mm
 Installation: Undermount with ½" Reveal

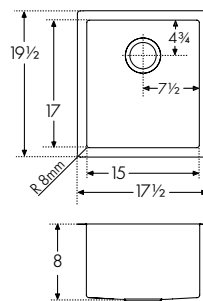

ACCESSORIES

1 Bottom Grid PS2-15-36S	5 Cutting Board PS2-40S	6 Cutting Board PS2-45S	7 Colander PE-70S	8 Drain Cover RNDCVR Included	9 Roller Mat RM18S	10 Strainer Basket 906 906SN	11 Inox Cream 903
--------------------------------------	-------------------------------------	-------------------------------------	-------------------------------	--	--------------------------------	---	-------------------------------

PS2X110-18 \$1,445



SPECIFICATIONS

Interior Dimensions: 18" x 17" x 10"
 Exterior Dimensions: 20½" x 19½"
 Minimum Cabinet Size: 24"
 Gauge: 16
 Weight: 23 lbs.
 Sound Dampening: Sound Pad and Spray Coat
 Stainless Finish: Diamond
 Corner Radius: 8mm
 Installation: Undermount with ½" Reveal

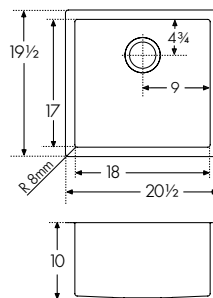

ACCESSORIES

2 Bottom Grid PS2-18-36S	5 Cutting Board PS2-40S	6 Cutting Board PS2-45S	7 Colander PE-70S	8 Drain Cover RNDCVR Included	9 Roller Mat RM18S	10 Strainer Basket 906 906SN	11 Inox Cream 903
--------------------------------------	-------------------------------------	-------------------------------------	-------------------------------	--	--------------------------------	---	-------------------------------

PS2X110-21 \$1,495



SPECIFICATIONS

Interior Dimensions: 23½" x 17" x 10"
 Exterior Dimensions: 21" x 19½"
 Minimum Cabinet Size: 27"
 Gauge: 16
 Weight: 25 lbs.
 Sound Dampening: Sound Pad and Spray Coat
 Stainless Finish: Diamond
 Corner Radius: 8mm
 Installation: Undermount with ½" Reveal

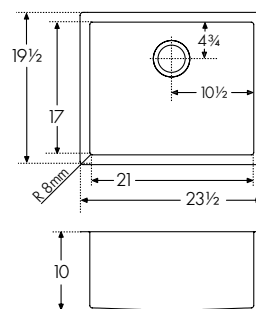

ACCESSORIES

3 Bottom Grid PS2-21-36S	5 Cutting Board PS2-40S	6 Cutting Board PS2-45S	7 Colander PE-70S	8 Drain Cover RNDCVR Included	9 Roller Mat RM18S	10 Strainer Basket 906 906SN	11 Inox Cream 903
--------------------------------------	-------------------------------------	-------------------------------------	-------------------------------	--	--------------------------------	---	-------------------------------

PS2X110-24 \$1,555



SPECIFICATIONS

Interior Dimensions: 24" x 17" x 10"
 Exterior Dimensions: 26½" x 19½"
 Minimum Cabinet Size: 30"
 Gauge: 16
 Weight: 27 lbs.
 Sound Dampening: Sound Pad and Spray Coat
 Stainless Finish: Diamond
 Corner Radius: 8mm
 Installation: Undermount with ½" Reveal

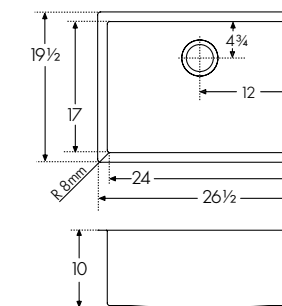

ACCESSORIES

4 Bottom Grid PS2-24-36S	5 Cutting Board PS2-40S	6 Cutting Board PS2-45S	7 Colander PE-70S	8 Drain Cover RNDCVR Included	9 Roller Mat RM18S	10 Strainer Basket 906 906SN	11 Inox Cream 903
--------------------------------------	-------------------------------------	-------------------------------------	-------------------------------	--	--------------------------------	---	-------------------------------

PS2X110-24-12 \$1,595



SPECIFICATIONS



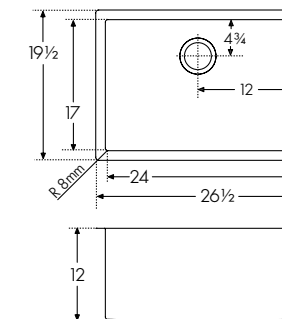







Interior Dimensions: 24" x 17" x 12"
 Exterior Dimensions: 26½" x 19½"
 Minimum Cabinet Size: 30"
 Gauge: 16
 Weight: 29 lbs.
 Sound Dampening: Sound Pad and Spray Coat
 Stainless Finish: Diamond
 Corner Radius: 8mm
 Installation: Undermount with ½" Reveal



ACCESSORIES

4 Bottom Grid PS2-24-36S	5 Cutting Board PS2-40S	6 Cutting Board PS2-45S	7 Colander PE-70S	8 Drain Cover RNDCVR Included	9 Roller Mat RM18S	10 Strainer Basket 906 906SN	11 Inox Cream 903
--------------------------------------	-------------------------------------	-------------------------------------	-------------------------------	--	--------------------------------	---	-------------------------------

ACCESSORIES

 1 Bottom Grid 14½" x 16½" Stainless PS2-15-36S \$140	 2 Bottom Grid 17½" x 16½" Stainless PS2-18-36S \$150	 3 Bottom Grid 20½" x 16½" Stainless PS2-21-36S \$181	 4 Bottom Grid 23½" x 16½" Stainless PS2-24-36S \$191	 5 Cutting Board 18 13⁄16" x 11" x 1" Maple PS2-40S \$212	 6 Cutting Board 17 7⁄8" x 11" x 1" Maple PS2-45S \$212
 7 Colander 17 5⁄8" x 6 1⁄8" x 2 1⁄8" Stainless PE-70S \$212	 8 Drain Cover 4½" Stainless RNDCVR \$82 One included with each sink.	 9 Roller Mat 12 13⁄16" x 17 7⁄8" Stainless RM18S \$147	 10 Strainer Basket Chrome 906 \$62 Satin Nickel 906SN \$85	 11 Inox Cream Stainless Steel Polish 903 \$31	

PS2X110-27 \$1,655



SPECIFICATIONS

Interior Dimensions: 27" x 17" x 10"
 Exterior Dimensions: 29½" x 19½"
 Minimum Cabinet Size: 33"
 Gauge: 16
 Weight: 29 lbs.
 Sound Dampening: Sound Pad and Spray Coat
 Stainless Finish: Diamond
 Corner Radius: 8mm
 Installation: Undermount with ½" Reveal

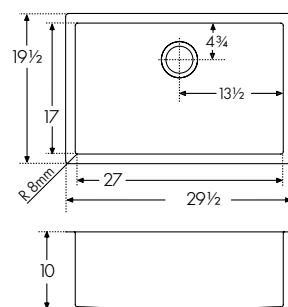

ACCESSORIES

3 Bottom Grid PS2-27-36S	6 Cutting Board PS2-40S	7 Cutting Board PS2-45S	8 Colander PE-70S	9 Drain Cover RNDCVR Included	10 Roller Mat RM18S	11 Strainer Basket 906 906SN	12 Inox Cream 903
--------------------------------------	-------------------------------------	-------------------------------------	-------------------------------	--	---------------------------------	---	-------------------------------

PS2X110-30 \$1,755



SPECIFICATIONS

Interior Dimensions: 30" x 17" x 10"
 Exterior Dimensions: 32½" x 19½"
 Minimum Cabinet Size: 36"
 Gauge: 16
 Weight: 31 lbs.
 Sound Dampening: Sound Pad and Spray Coat
 Stainless Finish: Diamond
 Corner Radius: 8mm
 Installation: Undermount with ½" Reveal

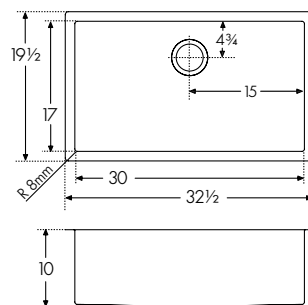

ACCESSORIES

4 Bottom Grid PS2-30-36S	6 Cutting Board PS2-40S	7 Cutting Board PS2-45S	8 Colander PE-70S	9 Drain Cover RNDCVR Included	10 Roller Mat RM18S	11 Strainer Basket 906 906SN	12 Inox Cream 903
--------------------------------------	-------------------------------------	-------------------------------------	-------------------------------	--	---------------------------------	---	-------------------------------

PS2X110-30-12 \$1,855



SPECIFICATIONS

Interior Dimensions: 30" x 17" x 12"
 Exterior Dimensions: 32½" x 19½"
 Minimum Cabinet Size: 36"
 Gauge: 16
 Weight: 32 lbs.
 Sound Dampening: Sound Pad and Spray Coat
 Stainless Finish: Diamond
 Corner Radius: 8mm
 Installation: Undermount with ½" Reveal

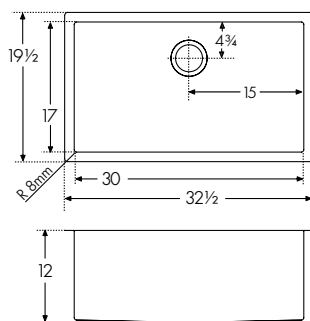

ACCESSORIES

4 Bottom Grid PS2-30-36S	6 Cutting Board PS2-40S	7 Cutting Board PS2-45S	8 Colander PE-70S	9 Drain Cover RNDCVR Included	10 Roller Mat RM18S	11 Strainer Basket 906 906SN	12 Inox Cream 903
--------------------------------------	-------------------------------------	-------------------------------------	-------------------------------	--	---------------------------------	---	-------------------------------

PS2X110-33 \$1,955



SPECIFICATIONS

Interior Dimensions: 33" x 17" x 10"
 Exterior Dimensions: 35½" x 19½"
 Minimum Cabinet Size: 39"
 Gauge: 16
 Weight: 33 lbs.
 Sound Dampening: Sound Pad and Spray Coat
 Stainless Finish: Diamond
 Corner Radius: 8mm
 Installation: Undermount with ½" Reveal

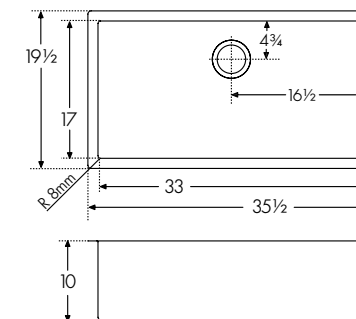

ACCESSORIES

5 Bottom Grid PS2-33-36S	6 Cutting Board PS2-40S	7 Cutting Board PS2-45S	8 Colander PE-70S	9 Drain Cover RNDCVR Included	10 Roller Mat RM18S	11 Strainer Basket 906 906SN	12 Inox Cream 903
--------------------------------------	-------------------------------------	-------------------------------------	-------------------------------	--	---------------------------------	---	-------------------------------

PS2X160-18-11 \$2,095



SPECIFICATIONS

Interior Dimensions: 30" x 17" x 10" & 9"
 Exterior Dimensions: 32½" x 19½"
 Minimum Cabinet Size: 36"
 Gauge: 16
 Weight: 34 lbs.
 Sound Dampening: Sound Pad and Spray Coat
 Stainless Finish: Diamond
 Corner Radius: 8mm
 Installation: Undermount with ½" Reveal

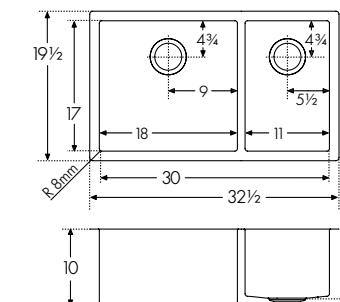

ACCESSORIES

1 Bottom Grid PS2-11-36S	2 Bottom Grid PS2-18-36S	6 Cutting Board PS2-40S	7 Cutting Board PS2-45S	8 Colander PE-70S	9 Drain Cover RNDCVR Included	10 Roller Mat RM18S	11 Strainer Basket 906 906SN	12 Inox Cream 903
--------------------------------------	--------------------------------------	-------------------------------------	-------------------------------------	-------------------------------	--	---------------------------------	---	-------------------------------

ACCESSORIES

1 Bottom Grid 10½" x 16½" Stainless PS2-11-36S \$119	2 Bottom Grid 17½" x 16½" Stainless PS2-18-36S \$150	3 Bottom Grid 26½" x 16½" Stainless PS2-27-36S \$212	4 Bottom Grid 29½" x 16½" Stainless PS2-30-36S \$243	5 Bottom Grid 32½" x 16½" Stainless PS2-33-36S \$264	6 Cutting Board 18 13/16" x 11" x 1" Maple PS2-40S \$212
7 Cutting Board 17 7/8" x 11" x 1" Maple PS2-45S \$212	8 Colander 17 5/8" x 6 1/8" x 2 1/8" Stainless PE-70S \$212	9 Drain Cover 4 1/2" Stainless RNDCVR \$82 One included with each sink.	10 Roller Mat 12 13/16" x 17 7/8" Stainless RM18S \$147	11 Strainer Basket Chrome 906 \$62 Satin Nickel 906SN \$85	12 Inox Cream Stainless Steel Polish 903 \$31

PS2X120-14-14 \$2,095

SPECIFICATIONS

Interior Dimensions: 29" x 17" x 10"
 Exterior Dimensions: 31 1/2" x 19 1/2"
 Minimum Cabinet Size: 36"
 Gauge: 16
 Weight: 32 lbs.
 Sound Dampening: Sound Pad and Spray Coat
 Stainless Finish: Diamond
 Corner Radius: 8mm
 Installation: Undermount with 1/2" Reveal

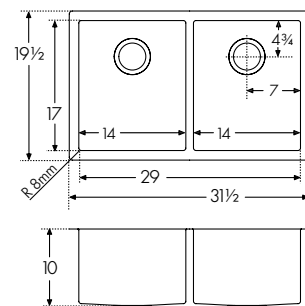

ACCESSORIES

1	Bottom Grid PS2-14-36S	4	Cutting Board PS2-40S	5	Cutting Board PS2-45S	6	Colander PE-70S	7	Drain Cover RNDCVR Included	8	Roller Mat RM18S	9	Strainer Basket 906 906SN	10	Inox Cream 903
---	----------------------------------	---	---------------------------------	---	---------------------------------	---	---------------------------	---	--	---	----------------------------	---	--	----	--------------------------

PS2X120-16-16 \$2,195

SPECIFICATIONS

Interior Dimensions: 33" x 17" x 10"
 Exterior Dimensions: 35 1/2" x 19 1/2"
 Minimum Cabinet Size: 39"
 Gauge: 16
 Weight: 38 lbs.
 Sound Dampening: Sound Pad and Spray Coat
 Stainless Finish: Diamond
 Corner Radius: 8mm
 Installation: Undermount with 1/2" Reveal

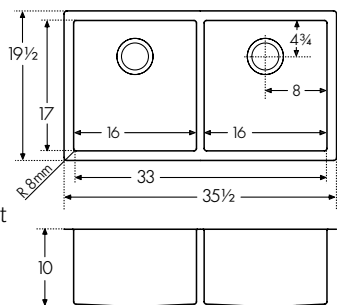

ACCESSORIES

2	Bottom Grid PS2-16-36S	4	Cutting Board PS2-40S	5	Cutting Board PS2-45S	6	Colander PE-70S	7	Drain Cover RNDCVR Included	8	Roller Mat RM18S	9	Strainer Basket 906 906SN	10	Inox Cream 903
---	----------------------------------	---	---------------------------------	---	---------------------------------	---	---------------------------	---	--	---	----------------------------	---	--	----	--------------------------

PERFECT TOGETHER

PROFESSIONAL FAUCETS

For the complete PROFESSIONAL Faucet Collection see pages 208-209



NEW FF5300



NEW FFPD5300



NEW FFPD5400

NEW LRX110-2310-316 \$825

Available Spring 2019



Suitable for outdoor use

T316 strainer
basket included

SPECIFICATIONS

Interior Dimensions: 23" x 17" x 10"
 Exterior Dimensions: 25" x 19"
 Minimum Cabinet Size: 30"
 Gauge: 18 T316 Stainless Steel
 Weight: 31 lbs.
 Sound Dampening: Sound Pad and Spray Coat
 Finish: Pearl
 Corner Radius: 10mm
 Installation: Undermount with 1/2" Reveal

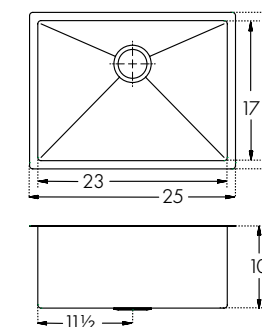

ACCESSORIES

3	Bottom Grid PS23-36S	9	Strainer Basket 906 906SN	10	Inox Cream 903
---	--------------------------------	---	--	----	--------------------------

NEW LRX110-2312-316 \$875

Available Spring 2019

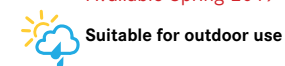

Suitable for outdoor use

T316 strainer
basket included

SPECIFICATIONS

Interior Dimensions: 23" x 17" x 12"
 Exterior Dimensions: 25" x 19"
 Minimum Cabinet Size: 30"
 Gauge: 18 T316 Stainless Steel
 Weight: 31 lbs.
 Sound Dampening: Sound Pad and Spray Coat
 Finish: Pearl
 Corner Radius: 10mm
 Installation: Undermount with 1/2" Reveal

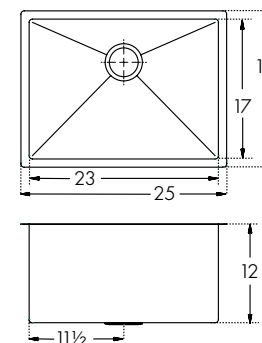

ACCESSORIES

3	Bottom Grid PS23-36S	9	Strainer Basket 906 906SN	10	Inox Cream 903
---	--------------------------------	---	--	----	--------------------------

ACCESSORIES

1 Bottom Grid 13 1/2" x 16 1/2" Stainless PS2-14-36S \$129	2 Bottom Grid 15 1/2" x 16 1/2" Stainless PS2-16-36S \$140	3 Bottom Grid 16 1/4" x 22 1/4" Stainless PS23-36S \$245	4 Cutting Board 18 13/16" x 11" x 1" Maple PS2-40S \$212	5 Cutting Board 17 7/8" x 11" x 1" Maple PS2-45S \$212
6 Colander 17 5/8" x 6 1/8" x 2 1/8" Stainless PE-70S \$212	7 Drain Cover 4 1/2" Stainless RNDCVR \$82 One included with each sink.	8 Roller Mat 12 13/16" x 17 7/8" Stainless RM18S \$147	9 Strainer Basket Chrome 906 \$62 Satin Nickel 906SN \$85	10 Inox Cream Stainless Steel Polish 903 \$31



Crystal
Stainless



Crystal
Stainless

CRYSTAL

Crystal adds a new dimension to cutting-edge sink design. A **shatter-resistant glass cover**, available in black, white or stainless steel, cleverly obscures the drain and pairs elegantly with the **stainless steel, diamond finish bowl**.



CLV110-24 \$1,545



SPECIFICATIONS

Interior Dimensions: 24½" x 17" x 9"
 Exterior Dimensions: 26½" x 19"
 Minimum Cabinet Size: 30"
 Gauge: 16
 Weight: 28 lbs.
 Sound Dampening: Sound Pad & Spray Coat
 Stainless Finish: Diamond
 Corner Radius: 0mm
 Installation: Undermount with ½" Reveal

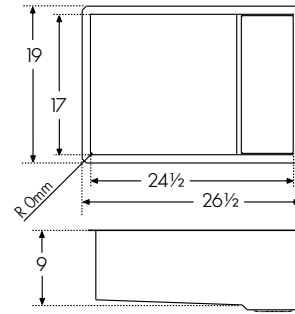

ACCESSORIES

2 Bottom Grid CL-24-36S	5 Cutting Board PS2-40S	6 Cutting Board PS2-45S	7 Colander PE-70S	8 Roller Mat RM18S	9 Drain Cover CL-BGC Included CL-WGC CL-SSC	10 Push Button Strainer Kit 906P-C 906P-SN	11 Inox Cream 903
-----------------------------------	-----------------------------------	-----------------------------------	-----------------------------	------------------------------	---	---	-----------------------------

CLV110-28 \$1,645



SPECIFICATIONS

Interior Dimensions: 27½" x 17" x 9"
 Exterior Dimensions: 29½" x 19"
 Minimum Cabinet Size: 33"
 Gauge: 16
 Weight: 31 lbs.
 Sound Dampening: Sound Pad & Spray Coat
 Stainless Finish: Diamond
 Corner Radius: 0mm
 Installation: Undermount with ½" Reveal

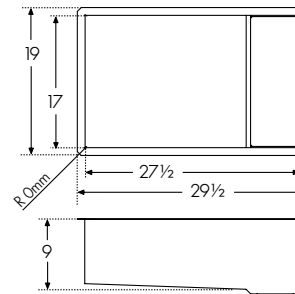

ACCESSORIES

3 Bottom Grid CL-28-36S	5 Cutting Board PS2-40S	6 Cutting Board PS2-45S	7 Colander PE-70S	8 Roller Mat RM18S	9 Drain Cover CL-BGC Included CL-WGC CL-SSC	10 Push Button Strainer Kit 906P-C 906P-SN	11 Inox Cream 903
-----------------------------------	-----------------------------------	-----------------------------------	-----------------------------	------------------------------	---	---	-----------------------------

CLV110-31 \$1,745



SPECIFICATIONS

Interior Dimensions: 30½" x 17" x 9"
 Exterior Dimensions: 32½" x 19"
 Minimum Cabinet Size: 36"
 Gauge: 16
 Weight: 34 lbs.
 Sound Dampening: Sound Pad & Spray Coat
 Stainless Finish: Diamond
 Corner Radius: 0mm
 Installation: Undermount with ½" Reveal

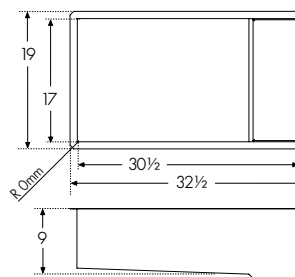

ACCESSORIES

4 Bottom Grid CL-31-36S	5 Cutting Board PS2-40S	6 Cutting Board PS2-45S	7 Colander PE-70S	8 Roller Mat RM18S	9 Drain Cover CL-BGC Included CL-WGC CL-SSC	10 Push Button Strainer Kit 906P-C 906P-SN	11 Inox Cream 903
-----------------------------------	-----------------------------------	-----------------------------------	-----------------------------	------------------------------	---	---	-----------------------------

CLV120-33 \$1,845



SPECIFICATIONS

Interior Dimensions: 30½" x 17" x 9"
 Exterior Dimensions: 32½" x 19"
 Minimum Cabinet Size: 36"
 Gauge: 16
 Weight: 35 lbs.
 Sound Dampening: Sound Pad & Spray Coat
 Stainless Finish: Diamond
 Corner Radius: 0mm
 Installation: Undermount with ½" Reveal

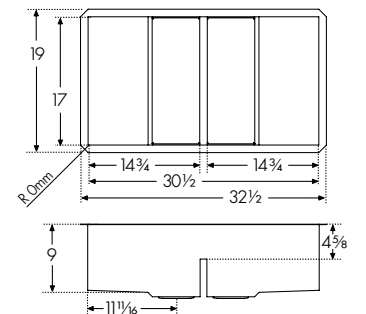

ACCESSORIES

1 Bottom Grid CL-14-36S	5 Cutting Board PS2-40S	6 Cutting Board PS2-45S	7 Colander PE-70S	8 Roller Mat RM18S	9 Drain Cover CL-BGC Included CL-WGC CL-SSC	10 Push Button Strainer Kit 906P-C 906P-SN	11 Inox Cream 903
-----------------------------------	-----------------------------------	-----------------------------------	-----------------------------	------------------------------	---	---	-----------------------------

ACCESSORIES

1 Bottom Grid 15" x 16¾" x 4¾" Stainless CL-14-36S \$150	2 Bottom Grid 16 1/16" x 16 1/8" Stainless CL-24-36S \$150	3 Bottom Grid 19 1/2" x 16 1/8" Stainless CL-28-36S \$160	4 Bottom Grid 22 3/4" x 16 1/8" Stainless CL-31-36S \$171	5 Cutting Board 18 1/8" x 11" x 1" Maple PS2-40S \$212	6 Cutting Board 17 7/8" x 11" x 1" Maple PS2-45S \$212
7 Colander 17 7/8" x 6 1/8" x 2 1/8" Stainless PE-70S \$212	8 Roller Mat 12 13/16" x 17 7/8" Stainless RM18S \$147	9 Drain Cover 16 7/8" x 6 1/4" Black CL-BGC \$137 Included White CL-WGC \$137 Stainless Steel CL-SSC \$116	10 Push Button Strainer Kit Chrome 906P-C \$124 Satin Nickel 906P-SN \$145	11 Inox Cream Stainless Steel Polish 903 \$31	

PERFECT TOGETHER
 CRYSTAL FAUCET

For the complete CRYSTAL Faucet Collection see page 210



FFPD4600



Kubus
Stainless



Kubus
Stainless

KUBUS

Straight lines create a clean, modern look. Clever accessories, such as the **pop-up strainer basket** and the **integrated ledge system**, make this stylish sink work harder so you don't have to.



Pictured: KBX12034 with FFPD2000 faucet, LB10200 filtration faucet, SD-500 soap dispenser and 900P pop-up strainer

KBX110-8 \$620



SPECIFICATIONS

Interior Dimensions: 7⁷/₈" x 15³/₄" x 5⁷/₈"
 Exterior Dimensions: 9¹/₁₆" x 16¹⁵/₁₆"
 Minimum Cabinet Size: 12"
 Gauge: 20
 Weight: 6 lbs.
 Sound Dampening: Sound Pad & Spray Coat
 Stainless Finish: Silk
 Corner Radius: 25mm
 Installation: Undermount with 1/16" Reveal

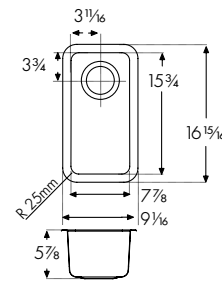

ACCESSORIES

10 Colander KB-70C	12 Pop-Up Strainer 900P 900P-SN27	13 Strainer Basket 906 906SN	14 Inox Cream 903
------------------------------	--	---	-----------------------------

KBX110-13 \$620



SPECIFICATIONS

Interior Dimensions: 13³/₈" x 15³/₄" x 7⁷/₈"
 Exterior Dimensions: 14¹/₁₆" x 16¹⁵/₁₆"
 Minimum Cabinet Size: 18"
 Gauge: 20
 Weight: 15 lbs.
 Sound Dampening: Sound Pad & Spray Coat
 Stainless Finish: Silk
 Corner Radius: 25mm
 Installation: Undermount with 1/16" Reveal

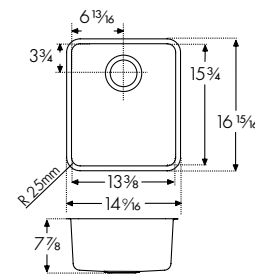

ACCESSORIES

1 Bottom Grid KB13-36S	10 Colander KB-70C	11 Roller Mat KB-36RM	12 Pop-Up Strainer 900P 900P-SN27	13 Strainer Basket 906 906SN	14 Inox Cream 903
----------------------------------	------------------------------	---------------------------------	--	---	-----------------------------

KBX110-18 \$860



SPECIFICATIONS

Interior Dimensions: 17³/₄" x 15³/₄" x 9¹/₁₆"
 Exterior Dimensions: 18⁷/₈" x 16¹⁵/₁₆"
 Minimum Cabinet Size: 24"
 Gauge: 18
 Weight: 19 lbs.
 Sound Dampening: Sound Pad & Spray Coat
 Stainless Finish: Silk
 Integral Franke Ledge System
 Corner Radius: 25mm
 Installation: Undermount with 1/16" Reveal

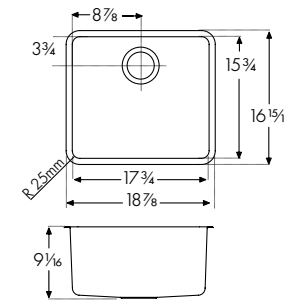

ACCESSORIES

2 Bottom Grid KB18-36S	5 Shelf Grid KB18-31S	8 Counter Grid KB17-31C	9 Cutting Board KB-40S	10 Colander KB-70C	11 Roller Mat KB-36RM	12 Pop-Up Strainer 900P 900P-SN27	13 Strainer Basket 906 906SN	14 Inox Cream 903
----------------------------------	---------------------------------	-----------------------------------	----------------------------------	------------------------------	---------------------------------	--	---	-----------------------------

KBX11021 \$ 960



SPECIFICATIONS

Interior Dimensions: 21⁵/₈" x 15³/₄" x 9¹/₁₆"
 Exterior Dimensions: 22¹³/₁₆" x 16¹⁵/₁₆"
 Minimum Cabinet Size: 27"
 Gauge: 18
 Weight: 21 lbs.
 Sound Dampening: Sound Pad & Spray Coat
 Stainless Finish: Silk
 Integral Franke Ledge System
 Corner Radius: 25mm
 Installation: Undermount with 1/16" Reveal

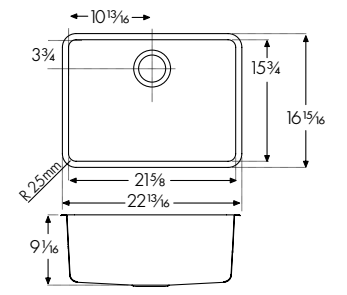

ACCESSORIES

3 Bottom Grid KB21-36S	6 Shelf Grid KB21-31S	8 Counter Grid KB17-31C	9 Cutting Board KB-40S	10 Colander KB-70C	11 Roller Mat KB-36RM	12 Pop-Up Strainer 900P 900P-SN27	13 Strainer Basket 906 906SN	14 Inox Cream 903
----------------------------------	---------------------------------	-----------------------------------	----------------------------------	------------------------------	---------------------------------	--	---	-----------------------------

KBX11028 \$1,065



SPECIFICATIONS

Interior Dimensions: 27⁷/₁₆" x 15³/₄" x 9¹/₁₆"
 Exterior Dimensions: 28³/₄" x 16¹⁵/₁₆"
 Minimum Cabinet Size: 33"
 Gauge: 18
 Weight: 24 lbs.
 Sound Dampening: Sound Pad & Spray Coat
 Stainless Finish: Silk
 Integral Franke Ledge System
 Corner Radius: 25mm
 Installation: Undermount with 1/16" Reveal

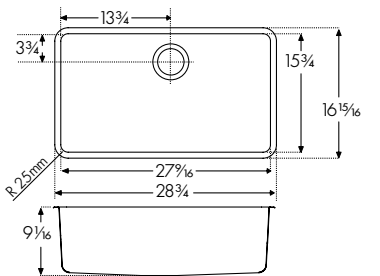

ACCESSORIES

4 Bottom Grid KB28-36S	7 Shelf Grid KB28-31S	8 Counter Grid KB17-31C	9 Cutting Board KB-40S	10 Colander KB-70C	11 Roller Mat KB-36RM	12 Pop-Up Strainer 900P 900P-SN27	13 Strainer Basket 906 906SN	14 Inox Cream 903
----------------------------------	---------------------------------	-----------------------------------	----------------------------------	------------------------------	---------------------------------	--	---	-----------------------------

ACCESSORIES

 1 Bottom Grid 12 ³ / ₈ " x 14 ³ / ₄ " Stainless KB13-36S \$126	 2 Bottom Grid 16 ¹ / ₁₆ " x 15 ¹ / ₁₆ " Stainless KB18-36S \$137	 3 Bottom Grid 20 ¹ / ₈ " x 14 ³ / ₁₆ " Stainless KB21-36S \$160	 4 Bottom Grid 26 ¹ / ₄ " x 14 ⁷ / ₁₆ " Stainless KB28-36S \$243	 5 Shelf Grid 17 ¹ / ₁₆ " x 15 ¹ / ₁₆ " Stainless KB18-31S \$126	 6 Shelf Grid 21" x 15 ¹ / ₁₆ " Stainless KB21-31S \$160	 7 Shelf Grid 13 ³ / ₈ " x 15 ³ / ₁₆ " Stainless KB28-31S \$160
 8 Counter Grid 13 ¹ / ₄ " x 16 ¹ / ₂ " Stainless KB17-31C \$95	 9 Cutting Board 14 ³ / ₁₆ " x 16 ¹ / ₂ " Solid Wood KB-40S \$202	 10 Colander 18 ¹ / ₂ " x 8 ¹ / ₂ " x 2 ¹ / ₄ " Polished Stainless KB-70C \$245	 11 Roller Mat 18 ³ / ₁₆ " x 16 ¹ / ₂ " Stainless KB-36RM \$150	 12 Pop-Up Strainer Chrome 900P \$116 Satin Nickel 900P-SN27 \$137	 13 Strainer Basket Chrome 906 \$62 Satin Nickel 906SN \$85	 14 Inox Cream Stainless Steel Polish 903 \$31

Note: All accessories sold separately unless otherwise indicated. Design of custom accessories subject to change without notice. It is absolutely critical that you have the sink and any custom sink accessories on site prior to any cut or modification to the countertop. Franke will not be responsible for any errors in countertop preparation and sink installation.

Note: All accessories sold separately unless otherwise indicated. Design of custom accessories subject to change without notice. It is absolutely critical that you have the sink and any custom sink accessories on site prior to any cut or modification to the countertop. Franke will not be responsible for any errors in countertop preparation and sink installation.

KBX12034 \$1,765



SPECIFICATIONS

Interior Dimensions: 32³/₁₆" x 15³/₄" x 9¹/₁₆" & 7⁷/₈"
 Exterior Dimensions: 34¹/₂" x 17¹⁵/₁₆"
 Minimum Cabinet Size: 39"
 Gauge: 18
 Weight: 25 lbs.
 Sound Dampening: Sound Pad & Spray Coat
 Stainless Finish: Silk
 Integral Franke Ledge System: Left Bowl
 Corner Radius: 25mm
 Installation: Undermount with 1/2" Reveal

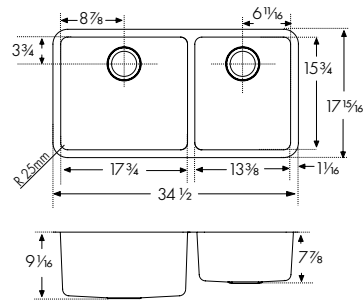

ACCESSORIES

1	Bottom Grid KB13-36S	2	Bottom Grid KB18-36S	4	Shelf Grid KB18-31S	6	Counter Grid KB17-31C	7	Cutting Board KB-40S	8	Colander KB-70C	9	Roller Mat KB-36RM	10	Pop-Up Strainer 900P 900P-SN27	11	Strainer Basket 906 906SN	12	Inox Cream 903
---	--------------------------------	---	--------------------------------	---	-------------------------------	---	---------------------------------	---	--------------------------------	---	---------------------------	---	------------------------------	----	---	----	--	----	--------------------------

KBX12039 \$1,810



SPECIFICATIONS

Interior Dimensions: 36³/₈" x 15³/₄" x 9¹/₁₆" & 7⁷/₈"
 Exterior Dimensions: 39" x 17¹⁵/₁₆"
 Minimum Cabinet Size: 42"
 Gauge: 18
 Weight: 33 lbs.
 Sound Dampening: Sound Pad & Spray Coat
 Stainless Finish: Silk
 Integral Franke Ledge System: Left Bowl
 Corner Radius: 25mm
 Installation: Undermount with 1/2" Reveal

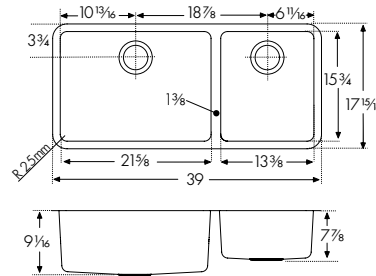

ACCESSORIES

1	Bottom Grid KB13-36S	3	Bottom Grid KB21-36S	5	Shelf Grid KB21-31S	6	Counter Grid KB17-31C	7	Cutting Board KB-40S	8	Colander KB-70C	9	Roller Mat KB-36RM	10	Pop-Up Strainer 900P 900P-SN27	11	Strainer Basket 906 906SN	12	Inox Cream 903
---	--------------------------------	---	--------------------------------	---	-------------------------------	---	---------------------------------	---	--------------------------------	---	---------------------------	---	------------------------------	----	---	----	--	----	--------------------------

KBX12043 \$1,960



SPECIFICATIONS

Interior Dimensions: 40³/₄" x 15³/₄" x 9¹/₁₆"
 Exterior Dimensions: 42¹⁵/₁₆" x 17¹⁵/₁₆"
 Minimum Cabinet Size: 48"
 Gauge: 18
 Weight: 35 lbs.
 Sound Dampening: Sound Pad & Spray Coat
 Stainless Finish: Silk
 Integral Franke Ledge System: Both Bowls
 Corner Radius: 25mm
 Installation: Undermount with 1/2" Reveal

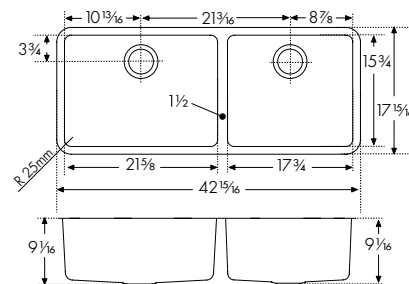

ACCESSORIES

2	Bottom Grid KB18-36S	3	Bottom Grid KB21-36S	4	Shelf Grid KB18-31S	5	Shelf Grid KB21-31S	6	Counter Grid KB17-31C	7	Cutting Board KB-40S	8	Colander KB-70C	9	Roller Mat KB-36RM	10	Pop-Up Strainer 900P 900P-SN27	11	Strainer Basket 906 906SN	12	Inox Cream 903
---	--------------------------------	---	--------------------------------	---	-------------------------------	---	-------------------------------	---	---------------------------------	---	--------------------------------	---	---------------------------	---	------------------------------	----	---	----	--	----	--------------------------

KBX160 \$1,760



SPECIFICATIONS

Interior Dimensions: 30⁷/₈" x 15³/₄" x 9¹/₁₆" & 5⁷/₈"
 Exterior Dimensions: 33¹/₁₆" x 17¹⁵/₁₆"
 Minimum Cabinet Size: 39"
 Gauge: 18
 Weight: 28 lbs.
 Sound Dampening: Sound Pad & Spray Coat
 Stainless Finish: Silk
 Integral Franke Ledge System: Left Bowl
 Corner Radius: 25mm
 Installation: Undermount with 1/2" Reveal

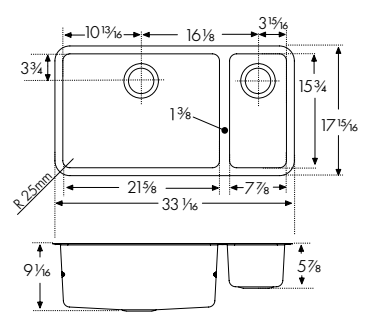

ACCESSORIES

3	Bottom Grid KB21-36S	5	Shelf Grid KB21-31S	6	Counter Grid KB17-31C	7	Cutting Board KB-40S	8	Colander KB-70C	9	Roller Mat KB-36RM	10	Pop-Up Strainer 900P 900P-SN27	11	Strainer Basket 906 906SN	12	Inox Cream 903
---	--------------------------------	---	-------------------------------	---	---------------------------------	---	--------------------------------	---	---------------------------	---	------------------------------	----	---	----	--	----	--------------------------

ACCESSORIES

1 Bottom Grid 12 ³ / ₈ " x 14 ³ / ₄ " Stainless KB13-36S \$126	2 Bottom Grid 16 ¹ / ₈ " x 15 ⁵ / ₈ " Stainless KB18-36S \$137	3 Bottom Grid 20 ¹ / ₈ " x 14 ⁵ / ₈ " Stainless KB21-36S \$160	4 Shelf Grid 17 ¹ / ₈ " x 15 ¹ / ₈ " Stainless KB18-31S \$126	5 Shelf Grid 21" x 15 ¹ / ₈ " Stainless KB21-31S \$160	6 Counter Grid 13 ¹ / ₄ " x 16 ¹ / ₂ " Stainless KB17-31C \$95
7 Cutting Board 14 ³ / ₈ " x 16 ¹ / ₂ " Solid Wood KB-40S \$202	8 Colander 18 ¹ / ₂ " x 8 ¹ / ₂ " x 2 ¹ / ₄ " Polished Stainless KB-70C \$245	9 Roller Mat 18 ⁷ / ₈ " x 16 ¹ / ₂ " Stainless KB-36RM \$150	10 Pop-Up Strainer Chrome 900P \$116 Satin Nickel 900P-SN27 \$137	11 Strainer Basket Chrome 906 \$62 Satin Nickel 906SN \$85	12 Inox Cream Stainless Steel Polish 903 \$31

PERFECT TOGETHER
KUBUS FAUCETS

For the complete KUBUS Faucet Collection see pages 248-249



NEW FF4250



NEW FFP4250



NEW FFB4250

Note: All accessories sold separately unless otherwise indicated. Design of custom accessories subject to change without notice. It is absolutely critical that you have the sink and any custom sink accessories on site prior to any cut or modification to the countertop. Franke will not be responsible for any errors in countertop preparation and sink installation.

Note: All accessories sold separately unless otherwise indicated. Design of custom accessories subject to change without notice. It is absolutely critical that you have the sink and any custom sink accessories on site prior to any cut or modification to the countertop. Franke will not be responsible for any errors in countertop preparation and sink installation.

PLANAR 8

The Planar 8 brings modern design to the kitchen. The **precise 8mm radius corners** impart a stunning visual appeal for the ultimate **contemporary** urban look.



Pictured: PEX1 10-31 sink with FF2800 faucet

PEX110-14 \$1,115



SPECIFICATIONS

Interior Dimensions: 14" x 17" x 9 1/2"
 Exterior Dimensions: 15 1/2" x 18 1/2"
 Minimum Cabinet Size: 18"
 Gauge: 18
 Weight: 21 lbs.
 Sound Dampening: Sound Pad
 Stainless Finish: Diamond
 Corner Radius: 8mm
 Installation: Undermount

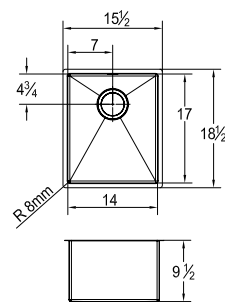

ACCESSORIES

- | | | | | | | |
|----------------------------------|------------------------------------|-------------------------------|--|--|--|-------------------------------|
| 1 Bottom Grid
PE-14S | 5 Cutting Board
PE-40S | 6 Colander
PE-70S | 7 Universal Roller Mat
UV-36RM | 8 Push Button Strainer Kit
906P-C
906P-SN | 9 Strainer Basket
906
906SN | 10 Inox Cream
903 |
|----------------------------------|------------------------------------|-------------------------------|--|--|--|-------------------------------|

PEX110-21 \$1,375



SPECIFICATIONS

Interior Dimensions: 21" x 17" x 9 1/2"
 Exterior Dimensions: 22 1/2" x 18 1/2"
 Minimum Cabinet Size: 27"
 Gauge: 18
 Weight: 25 lbs.
 Sound Dampening: Sound Pad
 Stainless Finish: Diamond
 Corner Radius: 8mm
 Installation: Undermount

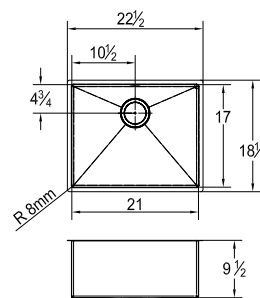

ACCESSORIES

- | | | | | | | |
|----------------------------------|------------------------------------|-------------------------------|--|--|--|-------------------------------|
| 2 Bottom Grid
PE-21S | 5 Cutting Board
PE-40S | 6 Colander
PE-70S | 7 Universal Roller Mat
UV-36RM | 8 Push Button Strainer Kit
906P-C
906P-SN | 9 Strainer Basket
906
906SN | 10 Inox Cream
903 |
|----------------------------------|------------------------------------|-------------------------------|--|--|--|-------------------------------|

PEX110-28 \$1,475



SPECIFICATIONS

Interior Dimensions: 28" x 17" x 9 1/2"
 Exterior Dimensions: 29 1/2" x 18 1/2"
 Minimum Cabinet Size: 33"
 Gauge: 18
 Weight: 31 lbs.
 Sound Dampening: Sound Pad
 Stainless Finish: Diamond
 Corner Radius: 8mm
 Installation: Undermount

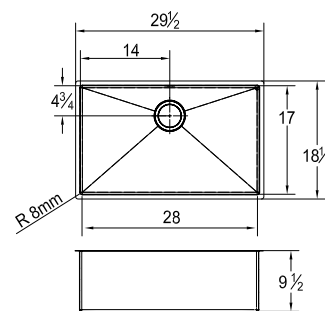

ACCESSORIES

- | | | | | | | |
|----------------------------------|------------------------------------|-------------------------------|--|--|--|-------------------------------|
| 3 Bottom Grid
PE-28S | 5 Cutting Board
PE-40S | 6 Colander
PE-70S | 7 Universal Roller Mat
UV-36RM | 8 Push Button Strainer Kit
906P-C
906P-SN | 9 Strainer Basket
906
906SN | 10 Inox Cream
903 |
|----------------------------------|------------------------------------|-------------------------------|--|--|--|-------------------------------|

PEX110-31 \$1,575



SPECIFICATIONS

Interior Dimensions: 31" x 17" x 9 1/2"
 Exterior Dimensions: 32 1/2" x 18 1/2"
 Minimum Cabinet Size: 36"
 Gauge: 18
 Weight: 33 lbs.
 Sound Dampening: Sound Pad
 Stainless Finish: Diamond
 Corner Radius: 8mm
 Installation: Undermount

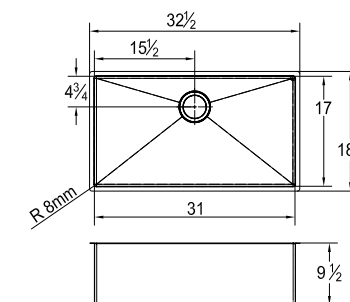

ACCESSORIES

- | | | | | | | |
|----------------------------------|------------------------------------|-------------------------------|--|--|--|-------------------------------|
| 4 Bottom Grid
PE-31S | 5 Cutting Board
PE-40S | 6 Colander
PE-70S | 7 Universal Roller Mat
UV-36RM | 8 Push Button Strainer Kit
906P-C
906P-SN | 9 Strainer Basket
906
906SN | 10 Inox Cream
903 |
|----------------------------------|------------------------------------|-------------------------------|--|--|--|-------------------------------|

ACCESSORIES

- | | | | | |
|---|---|--|--|---|
| 1 Bottom Grid
13 1/2" x 16 1/2"
Stainless
PE-14S
\$137 | 2 Bottom Grid
20 1/2" x 16 1/2"
Stainless
PE-21S
\$171 | 3 Bottom Grid
27 1/2" x 16 1/2"
Stainless
PE-28S
\$191 | 4 Bottom Grid
30 1/2" x 16 1/2"
Stainless
PE-31S
\$212 | 5 Cutting Board
14 3/8" x 17 3/8"
Solid Wood
PE-40S
\$243 |
| 6 Colander
17 3/8" x 6 1/8" x 2 1/8"
Stainless
PE-70S
\$212 | 7 Universal Roller Mat
18 7/16" x 20"
Stainless
UV-36RM
\$160 | 8 Push Button Strainer Kit
Chrome
906P-C
\$124
Satin Nickel
906P-SN
\$145 | 9 Strainer Basket
Chrome
906
\$62
Satin Nickel
906SN
\$85 | 10 Inox Cream
Stainless
Steel Polish
903
\$31 |

PERFECT TOGETHER

PLANAR 8 FAUCETS & DISPENSER

For the complete PLANAR 8 Faucet Collection see pages 216-217
 For dispenser details see page 284



FF2800



FFP2800



FFB2800



NEW SD2600

Note: All accessories sold separately unless otherwise indicated. Design of custom accessories subject to change without notice. It is absolutely critical that you have the sink and any custom sink accessories on site prior to any cut or modification to the countertop. Franke will not be responsible for any errors in countertop preparation and sink installation.

Note: All accessories sold separately unless otherwise indicated. Design of custom accessories subject to change without notice. It is absolutely critical that you have the sink and any custom sink accessories on site prior to any cut or modification to the countertop. Franke will not be responsible for any errors in countertop preparation and sink installation.



Pescara
Stainless



Pescara
Stainless



PESCARA

Whether it's used in a kitchen, bar area, or prep area, Pescara is sure to be a head-turner. The **hidden drain** accents its **contemporary look**, while an **integrated ledge system** takes functionality to a whole new level.

PTX110-14 \$595



SPECIFICATIONS

Interior Dimensions: 13½" x 17" x 8"
 Exterior Dimensions: 14⅞" x 18⅜"
 Minimum Cabinet Size: 18"
 Gauge: 18
 Weight: 11 lbs.
 Sound Dampening: Sound Pad & Spray Coat
 Stainless Finish: Pearl
 Corner Radius: 20mm
 Installation: Undermount with 3mm Reveal

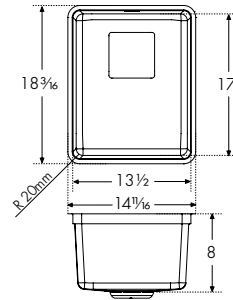

ACCESSORIES

1	Bottom Grid PT14-36S	7	Cutting Board PT-40S	8	Self Healing Cutting Mat SP-40S	9	Cutting Board PT-41S	10	Colander PE-70S	11	Universal Roller Mat UV-36RM	12	Push Button Strainer Kit 906P-C 906P-SN	13	Strainer Basket 906 906SN	14	Drain Cover PKGCVR Included
---	-------------------------	---	-------------------------	---	------------------------------------	---	-------------------------	----	--------------------	----	---------------------------------	----	---	----	---------------------------------	----	-----------------------------------

PTX110-17 \$675



SPECIFICATIONS

Interior Dimensions: 16⅞" x 17" x 8½"
 Exterior Dimensions: 17¾" x 18⅜"
 Minimum Cabinet Size: 21"
 Gauge: 18
 Weight: 14 lbs.
 Sound Dampening: Sound Pad & Spray Coat
 Stainless Finish: Pearl
 Integral Franke Ledge System
 Corner Radius: 20mm
 Installation: Undermount with 3mm Reveal

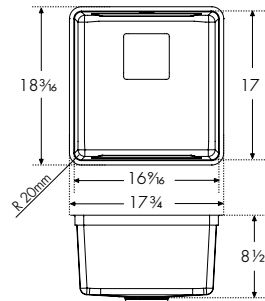

ACCESSORIES

2	Bottom Grid PT17-36S	6	Shelf Grid PT14-31S	7	Cutting Board PT-40S	8	Self Healing Cutting Mat SP-40S	9	Cutting Board PT-41S	10	Colander PE-70S	11	Universal Roller Mat UV-36RM	12	Push Button Strainer Kit 906P-C 906P-SN	13	Strainer Basket 906 906SN	14	Drain Cover PKGCVR Included
---	-------------------------	---	------------------------	---	-------------------------	---	------------------------------------	---	-------------------------	----	--------------------	----	---------------------------------	----	---	----	---------------------------------	----	-----------------------------------

PTX110-20 \$875

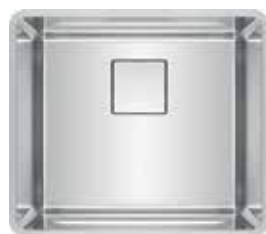

SPECIFICATIONS

Interior Dimensions: 19½" x 17" x 9"
 Exterior Dimensions: 20⅝" x 18⅜"
 Minimum Cabinet Size: 24"
 Gauge: 18
 Weight: 16 lbs.
 Sound Dampening: Sound Pad & Spray Coat
 Stainless Finish: Pearl
 Integral Franke Ledge System
 Corner Radius: 20mm
 Installation: Undermount with 3mm Reveal

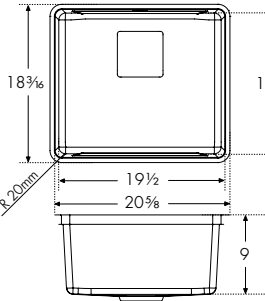

ACCESSORIES

3	Bottom Grid PT20-36S	6	Shelf Grid PT14-31S	7	Cutting Board PT-40S	8	Self Healing Cutting Mat SP-40S	9	Cutting Board PT-41S	10	Colander PE-70S	11	Universal Roller Mat UV-36RM	12	Push Button Strainer Kit 906P-C 906P-SN	13	Strainer Basket 906 906SN	14	Drain Cover PKGCVR Included
---	-------------------------	---	------------------------	---	-------------------------	---	------------------------------------	---	-------------------------	----	--------------------	----	---------------------------------	----	---	----	---------------------------------	----	-----------------------------------

PTX110-22 \$ 975

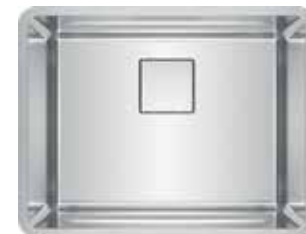

SPECIFICATIONS

Interior Dimensions: 22⅞" x 17" x 9½"
 Exterior Dimensions: 23⅝" x 18½"
 Minimum Cabinet Size: 27"
 Gauge: 18
 Weight: 18 lbs.
 Sound Dampening: Sound Pad & Spray Coat
 Stainless Finish: Pearl
 Integral Franke Ledge System
 Corner Radius: 20mm
 Installation: Undermount with 3mm Reveal

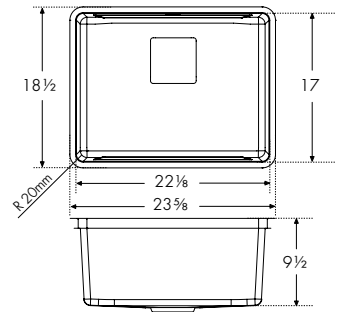

ACCESSORIES

4	Bottom Grid PT22-36S	6	Shelf Grid PT14-31S	7	Cutting Board PT-40S	8	Self Healing Cutting Mat SP-40S	9	Cutting Board PT-41S	10	Colander PE-70S	11	Universal Roller Mat UV-36RM	12	Push Button Strainer Kit 906P-C 906P-SN	13	Strainer Basket 906 906SN	14	Drain Cover PKGCVR Included
---	-------------------------	---	------------------------	---	-------------------------	---	------------------------------------	---	-------------------------	----	--------------------	----	---------------------------------	----	---	----	---------------------------------	----	-----------------------------------

PTX110-25 \$1,025

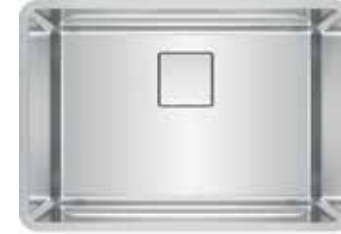

SPECIFICATIONS

Interior Dimensions: 25" x 17" x 9½"
 Exterior Dimensions: 26½" x 18½"
 Minimum Cabinet Size: 30"
 Gauge: 18
 Weight: 20 lbs.
 Sound Dampening: Sound Pad & Spray Coat
 Stainless Finish: Pearl
 Integral Franke Ledge System
 Corner Radius: 20mm
 Installation: Undermount with 3mm Reveal

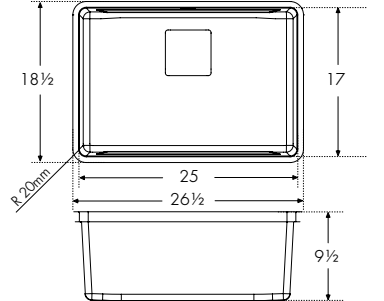

ACCESSORIES

5	Bottom Grid PT25-36S	6	Shelf Grid PT14-31S	7	Cutting Board PT-40S	8	Self Healing Cutting Mat SP-40S	9	Cutting Board PT-41S	10	Colander PE-70S	11	Universal Roller Mat UV-36RM	12	Push Button Strainer Kit 906P-C 906P-SN	13	Strainer Basket 906 906SN	14	Drain Cover PKGCVR Included
---	-------------------------	---	------------------------	---	-------------------------	---	------------------------------------	---	-------------------------	----	--------------------	----	---------------------------------	----	---	----	---------------------------------	----	-----------------------------------

ACCESSORIES

1	Bottom Grid 12⅝" x 15⅜" Stainless PT14-36S \$137	2	Bottom Grid 15⅜" x 15⅜" Stainless PT17-36S \$137	3	Bottom Grid 18⅝" x 15⅜" Stainless PT20-36S \$150	4	Bottom Grid 20⅝" x 15⅜" Stainless PT22-36S \$150	5	Bottom Grid 23⅜" x 15⅜" Stainless PT25-36S \$150	6	Shelf Grid 14" x 16¼" Stainless PT14-31S \$137	7	Cutting Board 10⅞" x 18½" Tempered Glass PT-40S \$202
8	Self Healing Cutting Mat 9⅜" x 14⅞" Silicone SP-40S \$52	9	Cutting Board 11" x 18½" Solid Wood PT-41S \$191	10	Colander 17⅞" x 6⅞" x 2⅞" Stainless PE-70S \$212	11	Universal Roller Mat 18⅞" x 20" Stainless UV-36RM \$160	12	Push Button Strainer Kit Chrome 906P-C \$124 Satin Nickel 906P-SN \$145	13	Strainer Basket Chrome 906 \$62 Satin Nickel 906SN \$85	14	Drain Cover Stainless PKGCVR \$82 One included with each sink.

Note: All accessories sold separately unless otherwise indicated. Design of custom accessories subject to change without notice. It is absolutely critical that you have the sink and any custom sink accessories on site prior to any cut or modification to the countertop. Franke will not be responsible for any errors in countertop preparation and sink installation.

Note: All accessories sold separately unless otherwise indicated. Design of custom accessories subject to change without notice. It is absolutely critical that you have the sink and any custom sink accessories on site prior to any cut or modification to the countertop. Franke will not be responsible for any errors in countertop preparation and sink installation.

PTX110-28 \$1,095

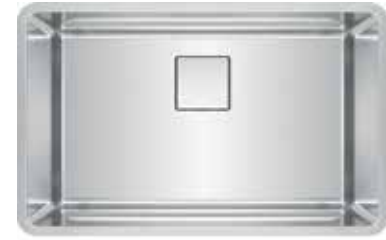

SPECIFICATIONS

Interior Dimensions: 28" x 17" x 9 1/2"
 Exterior Dimensions: 29 1/2" x 18 1/8"
 Minimum Cabinet Size: 33"
 Gauge: 18
 Weight: 21 lbs.
 Sound Dampening: Sound Pad & Spray Coat
 Stainless Finish: Pearl
 Integral Franke Ledge System
 Corner Radius: 20mm
 Installation: Undermount with 3mm Reveal

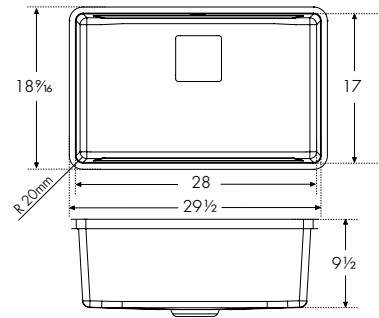

ACCESSORIES

1	Bottom Grid PT28-36S	3	Shelf Grid PT14-31S	4	Cutting Board PT-40S	5	Self Healing Cutting Mat SP-40S	6	Cutting Board PT-41S	7	Colander PE-70S	8	Universal Roller Mat UV-36RM	9	Push Button Strainer Kit 906P-C 906P-SN	10	Strainer Basket 906 906SN	11	Drain Cover PKGCVR Included
---	--------------------------------	---	-------------------------------	---	--------------------------------	---	---	---	--------------------------------	---	---------------------------	---	--	---	--	----	--	----	--

PTX110-31 \$1,195

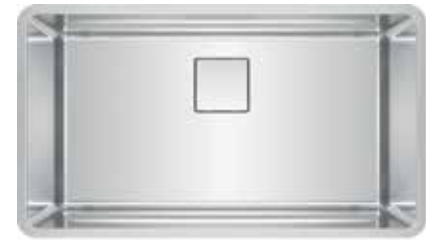

SPECIFICATIONS

Interior Dimensions: 31" x 17" x 9 1/2"
 Exterior Dimensions: 32 1/2" x 18 1/8"
 Minimum Cabinet Size: 36"
 Gauge: 18
 Weight: 23 lbs.
 Sound Dampening: Sound Pad & Spray Coat
 Stainless Finish: Silk
 Integral Franke Ledge System
 Corner Radius: 20mm
 Installation: Undermount with 3mm Reveal

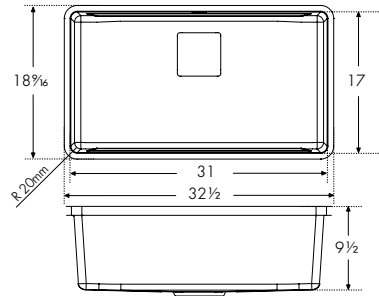

ACCESSORIES

2	Bottom Grid PT31-36S	3	Shelf Grid PT14-31S	4	Cutting Board PT-40S	5	Self Healing Cutting Mat SP-40S	6	Cutting Board PT-41S	7	Colander PE-70S	8	Universal Roller Mat UV-36RM	9	Push Button Strainer Kit 906P-C 906P-SN	10	Strainer Basket 906 906SN	11	Drain Cover PKGCVR Included
---	--------------------------------	---	-------------------------------	---	--------------------------------	---	---	---	--------------------------------	---	---------------------------	---	--	---	--	----	--	----	--

ACCESSORIES

1	Bottom Grid 26 3/4" x 15 13/16" Stainless PT28-36S \$160	2	Bottom Grid 29 13/16" x 15 13/16" Stainless PT31-36S \$171	3	Shelf Grid 14" x 16 1/4" Stainless PT14-31S \$137	4	Cutting Board 10 7/8" x 18 1/2" Tempered Glass PT-40S \$202	5	Self Healing Cutting Mat 9 13/16" x 14 7/8" Silicone SP-40S \$52	6	Cutting Board 11" x 18 1/2" Solid Wood PT-41S \$191
7	Colander 17 5/8" x 6 1/8" x 2 1/8" Stainless PE-70S \$212	8	Universal Roller Mat 18 7/16" x 20" Stainless UV-36RM \$160	9	Push Button Strainer Kit Chrome 906P-C \$124 Satin Nickel 906P-SN \$145	10	Strainer Basket Chrome 906 \$62 Satin Nickel 906SN \$85	11	Drain Cover Stainless PKGCVR \$82 (One included with each sink)		

Note: All accessories sold separately unless otherwise indicated. Design of custom accessories subject to change without notice. It is absolutely critical that you have the sink and any custom sink accessories on site prior to any cut or modification to the countertop. Franke will not be responsible for any errors in countertop preparation and sink installation.

PERFECT TOGETHER
PESCARA FAUCETS

For the complete PESCARA Faucet Collection see pages 224-228



FFPD4300



NEW FF4800



FF4400

Extended View



PFD4400



FFP4400



DW16000



Pictured: OR2X110 sink with FF3550 faucet



ORCA 2.0

For home chefs who want a **roomy sink** that will accommodate large cookware and big tasks, Orca 2.0 is not only spacious, but also has several optional accessories such as a **shelf grid roller mat** and **wire basket** that fit the **integral ledge** for enhanced performance. Gentle curves and a **rear drain** with a smooth round cover create easy-to-clean surfaces and enduring visual appeal.



NEW OR2X110 \$995

Available Spring 2019



SPECIFICATIONS

Interior Dimensions: 29 3/4" x 19 1/8" x 9 1/16"
 Exterior Dimensions: 30 1/16" x 20 1/16"
 Minimum Cabinet Size: 36"
 Gauge: 18
 Weight: 24 lbs.
 Sound Dampening: Sound Pad & Spray Coat
 Stainless Finish: Silk
 Integral Franke Ledge System
 Corner Radius: 30mm
 Installation: Undermount

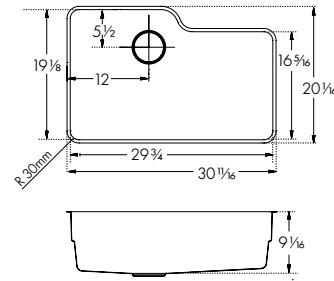

ACCESSORIES

- | | | | | | | | | |
|-----------------------------------|--|--------------------------------------|-----------------------------------|--------------------------------|--|----------------------------------|--|------------------------------|
| 1 Bottom Grid
OC2-36S | 2 Shelf Grid Roller Mat
OC2-31S-RH | 3 Cutting Board
OC2-45SP | 4 Wire Basket
OC2-50C | 5 Colander
OC2-60S | 6 Universal Roller Mat
UV-36RM | 7 Drain Cover
RNDCVR | 8 Strainer Basket
906
906SN | 9 Inox Cream
903 |
|-----------------------------------|--|--------------------------------------|-----------------------------------|--------------------------------|--|----------------------------------|--|------------------------------|

ORX110 \$1,035



SPECIFICATIONS

Interior Dimensions: 29 1/2" x 18 7/8" x 9 1/16"
 Exterior Dimensions: 30 1/16" x 20 1/16"
 Minimum Cabinet Size: 36"
 Gauge: 18
 Weight: 23 lbs.
 Sound Dampening: Sound Pad & Spray Coat
 Stainless Finish: Silk
 Integral Franke Ledge System
 Corner Radius: 83.5mm
 Installation: Undermount

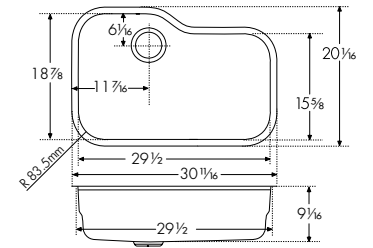

ACCESSORIES

- | | | | | | | | |
|----------------------------------|------------------------------------|------------------------------------|-------------------------------------|-------------------------------|--|--|------------------------------|
| 1 Bottom Grid
OC-36S | 2 Shelf Grid
OC-31S-LH | 3 Shelf Grid
OC-31S-RH | 4 Cutting Board
OC-45SP | 5 Colander
OC-60S | 6 Universal Roller Mat
UV-36RM | 7 Strainer Basket
906
906SN | 8 Inox Cream
903 |
|----------------------------------|------------------------------------|------------------------------------|-------------------------------------|-------------------------------|--|--|------------------------------|

ACCESSORIES

- | | | | |
|---|--|--|--|
| 1 Bottom Grid
27 7/16" x 16 3/4"
Stainless
OC2-36S
\$215 | 2 Shelf Grid Roller Mat
10 1/2" x 15 3/8"
Stainless
OC2-31S-RH
\$155 | 3 Cutting Board
17 1/8" x 19 13/16"
Solid Wood with
Stainless Colander
OC2-45SP
\$325 | 4 Wire Basket
13 3/8" x 18 1/2" x 2 5/8"
Stainless
OC2-50C
\$155 |
| 5 Colander
12 1/2" x 7" x 2 1/2"
Polished Stainless
OC2-60S
\$125 | 6 Universal Roller Mat
18 7/16" x 20"
Stainless
UV-36RM
\$160 | 7 Drain Cover
4 1/2"
Stainless
RNDCVR
\$82
One included
with each sink. | 8 Strainer Basket
Chrome
906
\$62
Satin Nickel
906SN
\$85 |
| 9 Inox Cream
Stainless
Steel Polish
903
\$31 | | | |

ACCESSORIES

- | | | | |
|---|---|--|---|
| 1 Bottom Grid
26 3/8" x 16 1/8"
Stainless
OC-36S
\$223 | 2 Shelf Grid
15" x 18 1/4"
Stainless
OC-31S-LH
\$160 | 3 Shelf Grid
13 3/4" x 14 7/8"
Stainless
OC-31S-RH
\$160 | 4 Cutting Board
18 3/4" x 19 5/8"
Solid Wood with
Stainless Colander
OC-45SP
\$424 |
| 5 Colander
16 1/2" x 11 5/8" x 1 1/2"
Polished Stainless
OC-60S
\$150 | 6 Universal Roller Mat
18 7/16" x 20"
Stainless
UV-36RM
\$160 | 7 Strainer Basket
Chrome
906
\$62
Satin Nickel
906SN
\$85 | 8 Inox Cream
Stainless
Steel Polish
903
\$31 |

PERFECT TOGETHER

ORCA FAUCETS

For the complete ORCA Faucet Collection see pages 236-238



FF3550



PF3550



DW14050



WONDERFUL EXTRAS

POT FILLERS

A POT FILLER FAUCET IS TYPICALLY MOUNTED NEAR THE RANGE AND DISPENSES COLD WATER. NO MORE CARRYING HEAVY POTS FROM THE SINK!

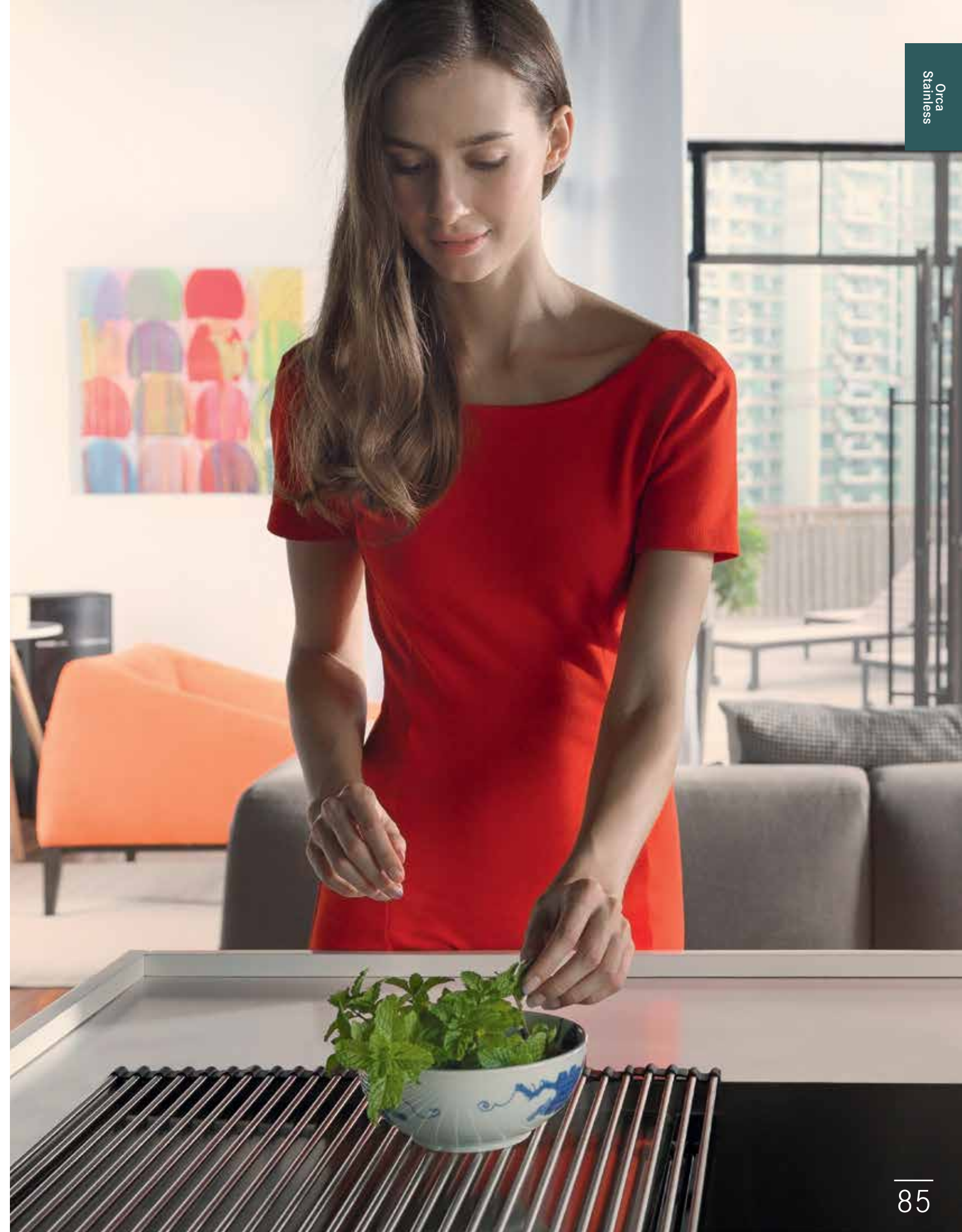

PRESTIGE

You'll be amazed by the volume that the **deep-bowl** Prestige sink can handle. Add a **ledge system** for added convenience and **ergonomic** ease of use. A final polish after production creates a **silky glistening surface**, resulting in a beautiful finish that is hygienic and easy to clean.



Pictured: PRX11021 sink with FF3450 faucet and SD-580N soap dispenser

PCX1102109 \$675



SPECIFICATIONS

Interior Dimensions: 21 1/4" x 18 7/8" x 9 1/16"
 Exterior Dimensions: 22 1/4" x 19 7/8"
 Minimum Cabinet Size: 27"
 Gauge: 18
 Weight: 20 lbs.
 Sound Dampening: Sound Pad & Spray Coat
 Stainless Finish: Silk
 Corner Radius: 83mm
 Installation: Undermount

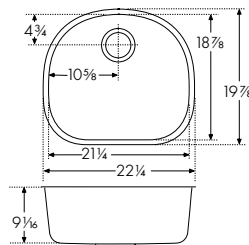

ACCESSORIES

- | | | | | |
|--------------------------------|--|---|--|----------------------------|
| 1 Bottom Grid
PR-36S | 3 Universal Roller Mat
UV-36RM | 4 Pop-Up Strainer
900P
900P-SN27 | 5 Strainer Basket
906
906SN | 6 Inox Cream
903 |
|--------------------------------|--|---|--|----------------------------|

PRX11021 \$775



SPECIFICATIONS

Interior Dimensions: 21 1/4" x 18 7/8" x 9 1/16"
 Exterior Dimensions: 22 1/4" x 19 7/8"
 Minimum Cabinet Size: 27"
 Gauge: 18
 Weight: 20 lbs.
 Sound Dampening: Sound Pad & Spray Coat
 Stainless Finish: Silk
 Integral Franke Ledge System
 Corner Radius: 83mm
 Installation: Undermount

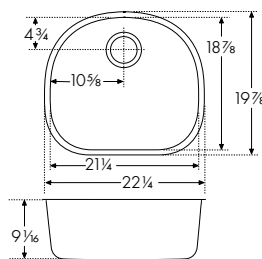

ACCESSORIES

- | | | | | | |
|--------------------------------|-------------------------------|--|---|--|----------------------------|
| 1 Bottom Grid
PR-36S | 2 Shelf Grid
PR-31S | 3 Universal Roller Mat
UV-36RM | 4 Pop-Up Strainer
900P
900P-SN27 | 5 Strainer Basket
906
906SN | 6 Inox Cream
903 |
|--------------------------------|-------------------------------|--|---|--|----------------------------|

ACCESSORIES

- | | | | | | |
|---|---|--|---|--|---|
|  |  |  |  |  |  |
| 1 Bottom Grid
18 13/32" x 16 3/8"
Stainless
PR-36S
\$150 | 2 Shelf Grid
20 3/16" x 13 7/16"
Stainless
PR-31S
\$150 | 3 Universal Roller Mat
18 7/8" x 20"
Stainless
UV-36RM
\$160 | 4 Pop-Up Strainer
Chrome
900P
\$116

Satin Nickel
900P-SN27
\$137 | 5 Strainer Basket
Chrome
906
\$62

Satin Nickel
906SN
\$85 | 6 Inox Cream
Stainless
Steel Polish
903
\$31 |



Note: All accessories sold separately unless otherwise indicated. Design of custom accessories subject to change without notice. It is absolutely critical that you have the sink and any custom sink accessories on site prior to any cut or modification to the countertop. Franke will not be responsible for any errors in countertop preparation and sink installation.



Pictured: RGX 160 sink with FFS5200 faucet



REGATTA

The innovative design of the Regatta offers **large deep bowls** while remaining space conscious. The **silky glistening surface** of the sinks are as beautiful as they are easy to clean.



RGX160 \$965



SPECIFICATIONS

Interior Dimensions: 29 1/8" x 18 7/8" x 8 7/8" & 6 7/8"
 Exterior Dimensions: 31 1/2" x 20 1/2"
 Minimum Cabinet Size: 36"
 Gauge: 18
 Weight: 24 lbs.
 Sound Dampening: Sound Pad & Spray Coat
 Stainless Finish: Silk
 Corner Radius: 113mm
 Installation: Undermount

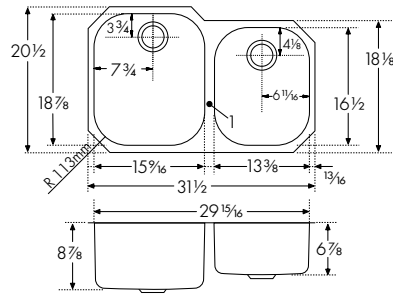

ACCESSORIES

1	Bottom Grid RG-36S	2	Bottom Grid RG-36S-RH	3	Small Drain Basket CP-50C	4	Universal Roller Mat UV-36RM	5	Pop-Up Strainer 900P 900P-SN27	6	Strainer Basket 906 906SN	7	Inox Cream 903
---	------------------------------	---	---------------------------------	---	-------------------------------------	---	--	---	---	---	--	---	--------------------------

ACCESSORIES



1 | **Bottom Grid**
13" x 16 7/8"
Stainless
RG-36S
\$150



2 | **Bottom Grid**
11 1/2" x 14 1/4"
Stainless
RG-36S-RH
\$150



3 | **Small Drain Basket**
15 3/8" x 12 1/2"
Coated Stainless
CP-50C
\$254

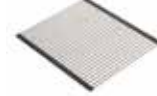

4 | **Universal Roller Mat**
18 7/8" x 20"
Stainless
UV-36RM
\$160



5 | **Pop-Up Strainer**
Chrome
900P
\$116
Satin Nickel
900P-SN27
\$137



6 | **Strainer Basket**
Chrome
906
\$62
Satin Nickel
906SN
\$85



7 | **Inox Cream**
Stainless
Steel Polish
903
\$31



Note: All accessories sold separately unless otherwise indicated. Design of custom accessories subject to change without notice. It is absolutely critical that you have the sink and any custom sink accessories on site prior to any cut or modification to the countertop. Franke will not be responsible for any errors in countertop preparation and sink installation.



Cube
Stainless



Cube
Stainless



CUBE

With the modern **18 gauge stainless steel** design of the Cube family, this **Swiss engineered** line of sinks has it all. The **single and double bowl** styles offer a clean, sleek look with an easy-to-clean **pearl finish**, deep, **9" bowls** to accommodate any task and **sound dampening pads**.



CUX11015 \$615



SPECIFICATIONS

Interior Dimensions: 15" x 16 1/8" x 9"
 Exterior Dimensions: 16 1/2" x 17 3/4"
 Minimum Cabinet Size: 21"
 Gauge: 18
 Weight: 13 lbs.
 Sound Dampening: Sound Pad & Spray Coat
 Stainless Finish: Pearl
 Corner Radius: 12mm
 Installation: Undermount

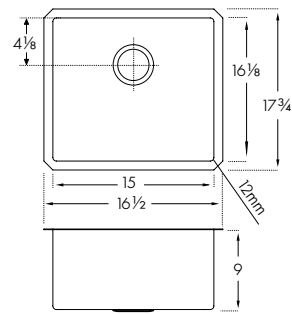

ACCESSORIES

- | | | | | | | | | | | | | | | | |
|---|-------------------------|---|-------------------------|---|-------------------------|---|---------------------|---|---------------------------------|---|---|----|---------------------------------|----|-------------------|
| 1 | Bottom Grid
CU15-36S | 5 | Cutting Board
CU-40S | 6 | Cutting Board
CU-40P | 7 | Colander
CUW-70S | 8 | Universal Roller Mat
UV-36RM | 9 | Push Button Strainer Kit
906P-C
906P-SN | 10 | Strainer Basket
906
906SN | 11 | Inox Cream
903 |
|---|-------------------------|---|-------------------------|---|-------------------------|---|---------------------|---|---------------------------------|---|---|----|---------------------------------|----|-------------------|

CUX11021 \$715



SPECIFICATIONS

Interior Dimensions: 21 1/4" x 16 1/8" x 9"
 Exterior Dimensions: 22 3/4" x 17 3/4"
 Minimum Cabinet Size: 27"
 Gauge: 18
 Weight: 16 lbs.
 Sound Dampening: Sound Pad & Spray Coat
 Stainless Finish: Pearl
 Corner Radius: 12mm
 Installation: Undermount

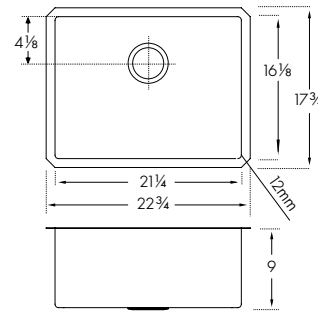

ACCESSORIES

- | | | | | | | | | | | | | | | | |
|---|-------------------------|---|-------------------------|---|-------------------------|---|---------------------|---|---------------------------------|---|---|----|---------------------------------|----|-------------------|
| 2 | Bottom Grid
CU21-36S | 5 | Cutting Board
CU-40S | 6 | Cutting Board
CU-40P | 7 | Colander
CUW-70S | 8 | Universal Roller Mat
UV-36RM | 9 | Push Button Strainer Kit
906P-C
906P-SN | 10 | Strainer Basket
906
906SN | 11 | Inox Cream
903 |
|---|-------------------------|---|-------------------------|---|-------------------------|---|---------------------|---|---------------------------------|---|---|----|---------------------------------|----|-------------------|

CUX11023 \$745



SPECIFICATIONS

Interior Dimensions: 23" x 16 1/8" x 9"
 Exterior Dimensions: 24 7/16" x 17 1/16"
 Minimum Cabinet Size: 30"
 Gauge: 18
 Weight: 17 lbs.
 Sound Dampening: Sound Pad & Spray Coat
 Stainless Finish: Pearl
 Corner Radius: 12mm
 Installation: Undermount

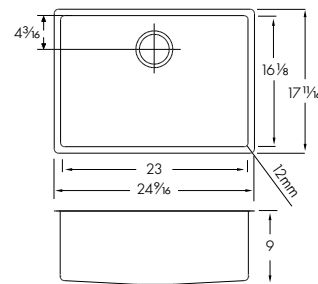

ACCESSORIES

- | | | | | | | | | | | | | | | | |
|---|-------------------------|---|-------------------------|---|-------------------------|---|---------------------|---|---------------------------------|---|---|----|---------------------------------|----|-------------------|
| 3 | Bottom Grid
CU23-36S | 5 | Cutting Board
CU-40S | 6 | Cutting Board
CU-40P | 7 | Colander
CUW-70S | 8 | Universal Roller Mat
UV-36RM | 9 | Push Button Strainer Kit
906P-C
906P-SN | 10 | Strainer Basket
906
906SN | 11 | Inox Cream
903 |
|---|-------------------------|---|-------------------------|---|-------------------------|---|---------------------|---|---------------------------------|---|---|----|---------------------------------|----|-------------------|

CUX11025 \$775



SPECIFICATIONS

Interior Dimensions: 25" x 16 1/8" x 9"
 Exterior Dimensions: 26 5/8" x 17 3/4"
 Minimum Cabinet Size: 30"
 Gauge: 18
 Weight: 18 lbs.
 Sound Dampening: Sound Pad & Spray Coat
 Stainless Finish: Pearl
 Corner Radius: 12mm
 Installation: Undermount

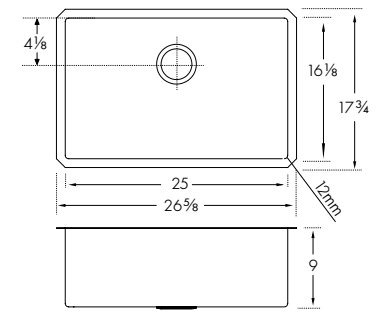

ACCESSORIES

- | | | | | | | | | | | | | | | | |
|---|-------------------------|---|-------------------------|---|-------------------------|---|---------------------|---|---------------------------------|---|---|----|---------------------------------|----|-------------------|
| 4 | Bottom Grid
CU25-36S | 5 | Cutting Board
CU-40S | 6 | Cutting Board
CU-40P | 7 | Colander
CUW-70S | 8 | Universal Roller Mat
UV-36RM | 9 | Push Button Strainer Kit
906P-C
906P-SN | 10 | Strainer Basket
906
906SN | 11 | Inox Cream
903 |
|---|-------------------------|---|-------------------------|---|-------------------------|---|---------------------|---|---------------------------------|---|---|----|---------------------------------|----|-------------------|

NEW CUX11025-8 \$775

Available Spring 2019



SPECIFICATIONS

Interior Dimensions: 25" x 16 1/8" x 8"
 Exterior Dimensions: 26 5/8" x 17 3/4"
 Minimum Cabinet Size: 30"
 Gauge: 18
 Weight: 18 lbs.
 Sound Dampening: Sound Pad & Spray Coat
 Stainless Finish: Pearl
 Corner Radius: 12mm
 Installation: Undermount

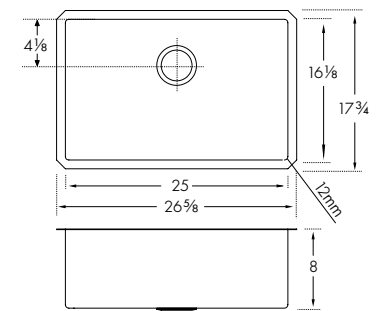

ACCESSORIES

- | | | | | | | | | | | | | | | | |
|---|-------------------------|---|-------------------------|---|-------------------------|---|---------------------|---|---------------------------------|---|---|----|---------------------------------|----|-------------------|
| 4 | Bottom Grid
CU25-36S | 5 | Cutting Board
CU-40S | 6 | Cutting Board
CU-40P | 7 | Colander
CUW-70S | 8 | Universal Roller Mat
UV-36RM | 9 | Push Button Strainer Kit
906P-C
906P-SN | 10 | Strainer Basket
906
906SN | 11 | Inox Cream
903 |
|---|-------------------------|---|-------------------------|---|-------------------------|---|---------------------|---|---------------------------------|---|---|----|---------------------------------|----|-------------------|

ACCESSORIES

- | | | | | | | | | | | | |
|---|---|---|---|---|---|----|---|----|--|---|--|
| 1 | Bottom Grid
13 3/4" x 15 3/8"
Stainless
CU15-36S
\$126 | 2 | Bottom Grid
20 3/16" x 15 3/8"
Stainless
CU21-36S
\$137 | 3 | Bottom Grid
22 1/2" x 15 3/8"
Stainless
CU23-36S
\$137 | 4 | Bottom Grid
24 7/32" x 15 3/8"
Stainless
CU25-36S
\$150 | 5 | Cutting Board
7 1/8" x 16 7/8"
Walnut
CU-40S
\$145 | 6 | Cutting Board
7 1/8" x 16 7/8"
Black Plastic
CU-40P
\$95 |
| 7 | Colander
6 3/16" x 17 7/8" x 2 1/8"
Stainless
CUW-70S
\$191 | 8 | Universal Roller Mat
18 7/16" x 20"
Stainless
UV-36RM
\$160 | 9 | Push Button Strainer Kit
Chrome
906P-C
\$124
Satin Nickel
906P-SN
\$145 | 10 | Strainer Basket
Chrome
906
\$62
Satin Nickel
906SN
\$85 | 11 | Inox Cream
Stainless
Steel Polish
903
\$31 | | |

Note: All accessories sold separately unless otherwise indicated. Design of custom accessories subject to change without notice. It is absolutely critical that you have the sink and any custom sink accessories on site prior to any cut or modification to the countertop. Franke will not be responsible for any errors in countertop preparation and sink installation.

Note: All accessories sold separately unless otherwise indicated. Design of custom accessories subject to change without notice. It is absolutely critical that you have the sink and any custom sink accessories on site prior to any cut or modification to the countertop. Franke will not be responsible for any errors in countertop preparation and sink installation.

CUX11027 \$825



SPECIFICATIONS

Interior Dimensions: 27" x 16 1/8" x 9"
 Exterior Dimensions: 28 1/2" x 17 3/4"
 Minimum Cabinet Size: 33"
 Gauge: 18
 Weight: 19 lbs.
 Sound Dampening: Sound Pad & Spray Coat
 Stainless Finish: Pearl
 Corner Radius: 12mm
 Installation: Undermount

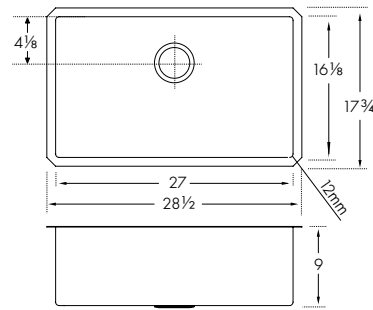

ACCESSORIES

- | | | | | | | | | | | | | | | | |
|---|--------------------------------|---|--------------------------------|---|--------------------------------|---|----------------------------|---|--|---|--|---|--|----|--------------------------|
| 2 | Bottom Grid
CU27-36S | 4 | Cutting Board
CU-40S | 5 | Cutting Board
CU-40P | 6 | Colander
CUW-70S | 7 | Universal Roller Mat
UV-36RM | 8 | Push Button Strainer Kit
906P-C
906P-SN | 9 | Strainer Basket
906
906SN | 10 | Inox Cream
903 |
|---|--------------------------------|---|--------------------------------|---|--------------------------------|---|----------------------------|---|--|---|--|---|--|----|--------------------------|

CUX11027-8 \$825

Available Spring 2019



SPECIFICATIONS

Interior Dimensions: 27" x 16 1/8" x 8"
 Exterior Dimensions: 28 1/2" x 17 3/4"
 Minimum Cabinet Size: 33"
 Gauge: 18
 Weight: 19 lbs.
 Sound Dampening: Sound Pad & Spray Coat
 Stainless Finish: Pearl
 Corner Radius: 12mm
 Installation: Undermount

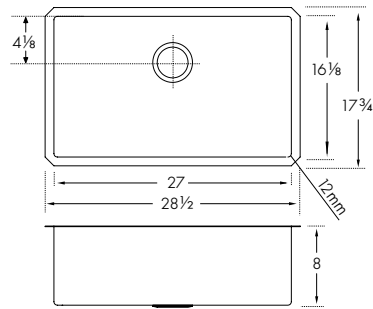

ACCESSORIES

- | | | | | | | | | | | | | | | | |
|---|--------------------------------|---|--------------------------------|---|--------------------------------|---|----------------------------|---|--|---|--|---|--|----|--------------------------|
| 2 | Bottom Grid
CU27-36S | 4 | Cutting Board
CU-40S | 5 | Cutting Board
CU-40P | 6 | Colander
CUW-70S | 7 | Universal Roller Mat
UV-36RM | 8 | Push Button Strainer Kit
906P-C
906P-SN | 9 | Strainer Basket
906
906SN | 10 | Inox Cream
903 |
|---|--------------------------------|---|--------------------------------|---|--------------------------------|---|----------------------------|---|--|---|--|---|--|----|--------------------------|

CUX11030 \$925



SPECIFICATIONS

Interior Dimensions: 30" x 16 1/8" x 9"
 Exterior Dimensions: 31 1/2" x 17 3/4"
 Minimum Cabinet Size: 36"
 Gauge: 18
 Weight: 21 lbs.
 Sound Dampening: Sound Pad & Spray Coat
 Stainless Finish: Pearl
 Corner Radius: 12mm
 Installation: Undermount

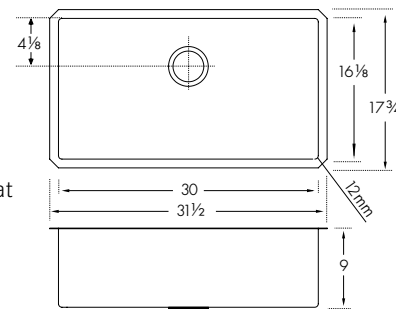

ACCESSORIES

- | | | | | | | | | | | | | | | | |
|---|--------------------------------|---|--------------------------------|---|--------------------------------|---|----------------------------|---|--|---|--|---|--|----|--------------------------|
| 3 | Bottom Grid
CU30-36S | 4 | Cutting Board
CU-40S | 5 | Cutting Board
CU-40P | 6 | Colander
CUW-70S | 7 | Universal Roller Mat
UV-36RM | 8 | Push Button Strainer Kit
906P-C
906P-SN | 9 | Strainer Basket
906
906SN | 10 | Inox Cream
903 |
|---|--------------------------------|---|--------------------------------|---|--------------------------------|---|----------------------------|---|--|---|--|---|--|----|--------------------------|

CUX11030-8 \$ 925

Available Spring 2019



SPECIFICATIONS

Interior Dimensions: 30" x 16 1/8" x 8"
 Exterior Dimensions: 31 1/2" x 17 3/4"
 Minimum Cabinet Size: 36"
 Gauge: 18
 Weight: 21 lbs.
 Sound Dampening: Sound Pad & Spray Coat
 Stainless Finish: Pearl
 Corner Radius: 12mm
 Installation: Undermount

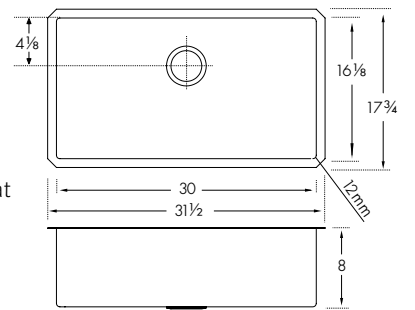

ACCESSORIES

- | | | | | | | | | | | | | | | | |
|---|--------------------------------|---|--------------------------------|---|--------------------------------|---|----------------------------|---|--|---|--|---|--|----|--------------------------|
| 3 | Bottom Grid
CU30-36S | 4 | Cutting Board
CU-40S | 5 | Cutting Board
CU-40P | 6 | Colander
CUW-70S | 7 | Universal Roller Mat
UV-36RM | 8 | Push Button Strainer Kit
906P-C
906P-SN | 9 | Strainer Basket
906
906SN | 10 | Inox Cream
903 |
|---|--------------------------------|---|--------------------------------|---|--------------------------------|---|----------------------------|---|--|---|--|---|--|----|--------------------------|

CUX120 \$1,025



SPECIFICATIONS



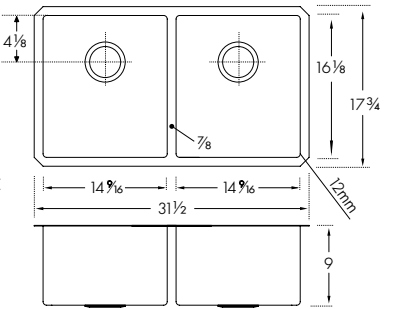







Interior Dimensions: 30" x 16 1/8" x 9"
 Exterior Dimensions: 31 1/2" x 17 3/4"
 Minimum Cabinet Size: 36"
 Gauge: 18
 Weight: 24 lbs.
 Sound Dampening: Sound Pad & Spray Coat
 Stainless Finish: Pearl
 Corner Radius: 12mm
 Installation: Undermount

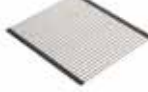

ACCESSORIES

- | | | | | | | | | | | | | | | | |
|---|--------------------------------|---|--------------------------------|---|--------------------------------|---|----------------------------|---|--|---|--|---|--|----|--------------------------|
| 1 | Bottom Grid
CU15-36S | 4 | Cutting Board
CU-40S | 5 | Cutting Board
CU-40P | 6 | Colander
CUW-70S | 7 | Universal Roller Mat
UV-36RM | 8 | Push Button Strainer Kit
906P-C
906P-SN | 9 | Strainer Basket
906
906SN | 10 | Inox Cream
903 |
|---|--------------------------------|---|--------------------------------|---|--------------------------------|---|----------------------------|---|--|---|--|---|--|----|--------------------------|

ACCESSORIES

- | | | | | |
|--|--|--|--|---|
|  |  |  |  |  |
| 1 Bottom Grid
13 3/4" x 15 3/8"
Stainless
CU15-36S
\$126 | 2 Bottom Grid
26 3/8" x 15 3/8"
Stainless
CU27-36S
\$150 | 3 Bottom Grid
29 1/4" x 15 3/8"
Stainless
CU30-36S
\$160 | 4 Cutting Board
7 1/8" x 16 7/8"
Walnut
CU-40S
\$145 | 5 Cutting Board
7 1/8" x 16 7/8"
Black Plastic
CU-40P
\$95 |
|  |  |  |  |  |
| 6 Colander
6 3/8" x 17 5/8" x 2 1/8"
Stainless
CUW-70S
\$191 | 7 Universal Roller Mat
18 7/8" x 20"
Stainless
UV-36RM
\$160 | 8 Push Button Strainer Kit
Chrome
906P-C
\$124
Satin Nickel
906P-SN
\$145 | 9 Strainer Basket
Chrome
906
\$62
Satin Nickel
906SN
\$85 | 10 Inox Cream
Stainless
Steel Polish
903
\$31 |

Note: All accessories sold separately unless otherwise indicated. Design of custom accessories subject to change without notice. It is absolutely critical that you have the sink and any custom sink accessories on site prior to any cut or modification to the countertop. Franke will not be responsible for any errors in countertop preparation and sink installation.

Note: All accessories sold separately unless otherwise indicated. Design of custom accessories subject to change without notice. It is absolutely critical that you have the sink and any custom sink accessories on site prior to any cut or modification to the countertop. Franke will not be responsible for any errors in countertop preparation and sink installation.

CUX160 \$1,025



SPECIFICATIONS

Interior Dimensions: 30" x 16 1/8" x 9"
 Exterior Dimensions: 31 1/2" x 17 3/4"
 Minimum Cabinet Size: 36"
 Gauge: 18
 Weight: 24 lbs.
 Sound Dampening: Sound Pad & Spray Coat
 Stainless Finish: Pearl
 Corner Radius: 12mm
 Installation: Undermount

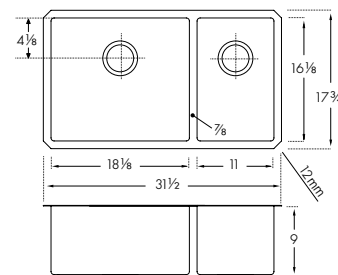

ACCESSORIES

1	Bottom Grid CU11-36S	2	Bottom Grid CU18-36S	5	Cutting Board CU-40S	6	Cutting Board CU-40P	7	Colander CUW-70S	8	Universal Roller Mat UV-36RM	9	Push Button Strainer Kit 906P-C 906P-SN	10	Strainer Basket 906 906SN	11	Inox Cream 903
---	--------------------------------	---	--------------------------------	---	--------------------------------	---	--------------------------------	---	----------------------------	---	--	---	--	----	--	----	--------------------------

ACCESSORIES

1	Bottom Grid 10 1/4" x 15 3/8" Stainless CU11-36S \$116	2	Bottom Grid 17 7/8" x 15 3/8" Stainless CU18-36S \$137	3	Bottom Grid 20 3/8" x 15 3/8" Stainless CU21-36S \$137	4	Bottom Grid 26 3/8" x 15 3/8" Stainless CU27-36S \$150	5	Cutting Board 7 1/8" x 16 7/8" Walnut CU-40S \$145	6	Cutting Board 7 1/8" x 16 7/8" Black Plastic CU-40P \$95
7	Colander 6 3/8" x 17 5/8" x 2 1/8" Stainless CUW-70S \$191	8	Universal Roller Mat 18 7/8" x 20" Stainless UV-36RM \$160	9	Push Button Strainer Kit Chrome 906P-C \$124 Satin Nickel 906P-SN \$145	10	Strainer Basket Chrome 906 \$62 Satin Nickel 906SN \$85	11	Inox Cream Stainless Steel Polish 903 \$31		

CUX11021-ADA \$ 715



SPECIFICATIONS

Interior Dimensions: 21 1/4" x 16 1/8" x 5"
 Exterior Dimensions: 22 3/4" x 17 3/4"
 Minimum Cabinet Size: 27"
 Gauge: 18
 Weight: 16 lbs.
 Sound Dampening: Sound Pad
 Stainless Finish: Pearl
 Corner Radius: 12mm
 Installation: Undermount
 ADA Compliant

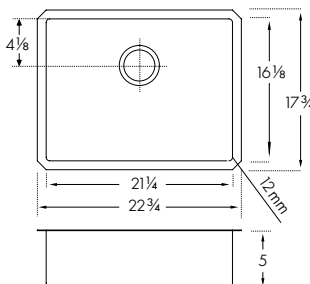

ACCESSORIES

3	Bottom Grid CU21-36S	5	Cutting Board CU-40S	6	Cutting Board CU-40P	7	Colander CUW-70S	8	Universal Roller Mat UV-36RM	9	Push Button Strainer Kit 906P-C 906P-SN	10	Strainer Basket 906 906SN	11	Inox Cream 903
---	--------------------------------	---	--------------------------------	---	--------------------------------	---	----------------------------	---	--	---	--	----	--	----	--------------------------

CUX11027-ADA \$ 825



SPECIFICATIONS

Interior Dimensions: 27" x 16 1/8" x 5"
 Exterior Dimensions: 28 1/2" x 17 3/4"
 Minimum Cabinet Size: 33"
 Gauge: 18
 Weight: 19 lbs.
 Sound Dampening: Sound Pad
 Stainless Finish: Pearl
 Corner Radius: 12mm
 Installation: Undermount
 ADA Compliant

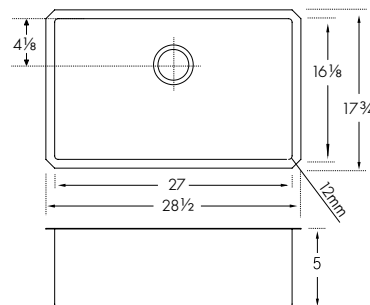

ACCESSORIES

4	Bottom Grid CU27-36S	5	Cutting Board CU-40S	6	Cutting Board CU-40P	7	Colander CUW-70S	8	Universal Roller Mat UV-36RM	9	Push Button Strainer Kit 906P-C 906P-SN	10	Strainer Basket 906 906SN	11	Inox Cream 903
---	--------------------------------	---	--------------------------------	---	--------------------------------	---	----------------------------	---	--	---	--	----	--	----	--------------------------

PERFECT TOGETHER
 CUBE FAUCETS

For the complete CUBE Faucet Collection see pages 250-253



GRANDE

While providing the functionality of a **large surface** and the convenience of **wide corners**, the Grande series will meet your everyday kitchen needs. These design elements provide a unique collaboration of utility and **ease of cleaning**. Grande is the perfect sink.



GDX11012 \$540



SPECIFICATIONS

Interior Dimensions: 12" x 17" x 8"
 Exterior Dimensions: 13 3/4" x 18 3/4"
 Minimum Cabinet Size: 18"
 Gauge: 18
 Weight: 12 lbs.
 Sound Dampening: Sound Pad & Spray Coat
 Stainless Finish: Silk
 Corner Radius: 50mm
 Installation: Undermount

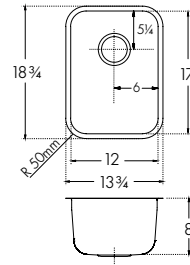

ACCESSORIES

- | | | | | |
|----------------------------------|--|---|---|-----------------------------|
| 1 Bottom Grid
GD12-36S | 8 Universal Roller Mat
UV-36RM | 9 Pop-Up Strainer
900P
900P-SN27 | 10 Strainer Basket
906
906SN | 11 Inox Cream
903 |
|----------------------------------|--|---|---|-----------------------------|

GDX11015 \$585



SPECIFICATIONS

Interior Dimensions: 15" x 17" x 9"
 Exterior Dimensions: 16 3/4" x 18 3/4"
 Minimum Cabinet Size: 21"
 Gauge: 18
 Weight: 15 lbs.
 Sound Dampening: Sound Pad & Spray Coat
 Stainless Finish: Silk
 Corner Radius: 50mm
 Installation: Undermount

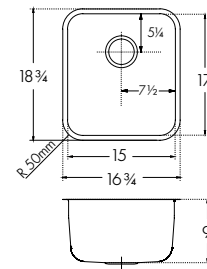

ACCESSORIES

- | | | | | |
|----------------------------------|--|---|---|-----------------------------|
| 2 Bottom Grid
GD15-36S | 8 Universal Roller Mat
UV-36RM | 9 Pop-Up Strainer
900P
900P-SN27 | 10 Strainer Basket
906
906SN | 11 Inox Cream
903 |
|----------------------------------|--|---|---|-----------------------------|

GDX11018 \$675



SPECIFICATIONS

Interior Dimensions: 18" x 19 3/4" x 9"
 Exterior Dimensions: 19 3/4" x 21 1/2"
 Minimum Cabinet Size: 24"
 Gauge: 18
 Weight: 17 lbs.
 Sound Dampening: Sound Pad & Spray Coat
 Stainless Finish: Silk
 Corner Radius: 50mm
 Installation: Undermount

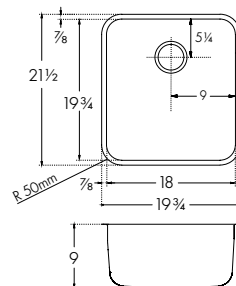

ACCESSORIES

- | | | | |
|----------------------------------|---|---|-----------------------------|
| 3 Bottom Grid
GD18-36S | 9 Pop-Up Strainer
900P
900P-SN27 | 10 Strainer Basket
906
906SN | 11 Inox Cream
903 |
|----------------------------------|---|---|-----------------------------|

GDX11023 \$745



SPECIFICATIONS

Interior Dimensions: 23" x 17" x 9"
 Exterior Dimensions: 24 3/4" x 18 3/4"
 Minimum Cabinet Size: 30"
 Gauge: 18
 Weight: 21 lbs.
 Sound Dampening: Sound Pad & Spray Coat
 Stainless Finish: Silk
 Corner Radius: 50mm
 Installation: Undermount

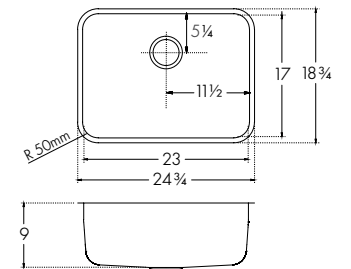

ACCESSORIES

- | | | | | | |
|----------------------------------|----------------------------------|--|---|---|-----------------------------|
| 4 Bottom Grid
GD23-36S | 6 Cutting Board
GD-40S | 8 Universal Roller Mat
UV-36RM | 9 Pop-Up Strainer
900P
900P-SN27 | 10 Strainer Basket
906
906SN | 11 Inox Cream
903 |
|----------------------------------|----------------------------------|--|---|---|-----------------------------|

GDX11028 \$795



SPECIFICATIONS

Interior Dimensions: 28" x 17" x 9"
 Exterior Dimensions: 30 1/8" x 19 1/8"
 Minimum Cabinet Size: 36"
 Gauge: 18
 Weight: 25 lbs.
 Sound Dampening: Sound Pad & Spray Coat
 Stainless Finish: Silk
 Corner Radius: 70mm
 Installation: Undermount

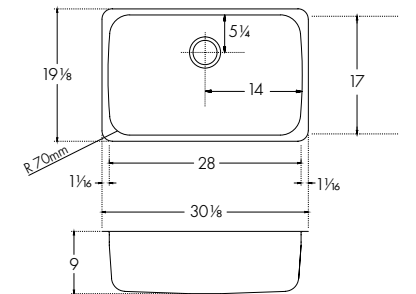

ACCESSORIES

- | | | | | | |
|----------------------------------|------------------------------------|--|---|---|-----------------------------|
| 5 Bottom Grid
GD28-36S | 7 Cutting Board
GD28-40S | 8 Universal Roller Mat
UV-36RM | 9 Pop-Up Strainer
900P
900P-SN27 | 10 Strainer Basket
906
906SN | 11 Inox Cream
903 |
|----------------------------------|------------------------------------|--|---|---|-----------------------------|

ACCESSORIES

- | | | | | | |
|--|---|---|---|--|---|
| 1 Bottom Grid
10 1/2" x 15 1/2"
Stainless
GD12-36S
\$126 | 2 Bottom Grid
13 5/8" x 15 1/2"
Stainless
GD15-36S
\$137 | 3 Bottom Grid
16 1/2" x 18 1/4"
Stainless
GD18-36S
\$150 | 4 Bottom Grid
21 1/2" x 15 1/2"
Stainless
GD23-36S
\$160 | 5 Bottom Grid
25 7/8" x 15 5/8"
Stainless
GD28-36S
\$191 | 6 Cutting Board
18 3/8" x 14 3/4"
Solid Wood
GD-40S
\$243 |
| 7 Cutting Board
18 7/16" x 14 3/4"
Solid Wood
GD28-40S
\$243 | 8 Universal Roller Mat
18 7/16" x 20"
Stainless
UV-36RM
\$160 | 9 Pop-Up Strainer
Chrome
900P
\$116
Satin Nickel
900P-SN27
\$137 | 10 Strainer Basket
Chrome
906
\$62
Satin Nickel
906SN
\$85 | 11 Inox Cream
Stainless
Steel Polish
903
\$31 | |

Note: All accessories sold separately unless otherwise indicated. Design of custom accessories subject to change without notice. It is absolutely critical that you have the sink and any custom sink accessories on site prior to any cut or modification to the countertop. Franke will not be responsible for any errors in countertop preparation and sink installation.

Note: All accessories sold separately unless otherwise indicated. Design of custom accessories subject to change without notice. It is absolutely critical that you have the sink and any custom sink accessories on site prior to any cut or modification to the countertop. Franke will not be responsible for any errors in countertop preparation and sink installation.

GDX11031 \$855



SPECIFICATIONS

Interior Dimensions: 31" x 17" x 9"
 Exterior Dimensions: 32 3/4" x 18 3/4"
 Minimum Cabinet Size: 36"
 Gauge: 18
 Weight: 28 lbs.
 Sound Dampening: Sound Pad & Spray Coat
 Stainless Finish: Silk
 Corner Radius: 50mm
 Installation: Undermount

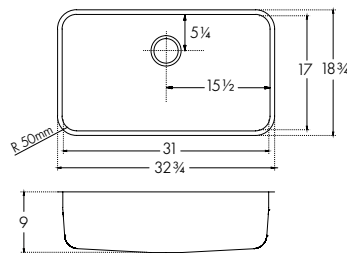

ACCESSORIES

- | | | | | | |
|----------------------------------|----------------------------------|--|---|--|----------------------------|
| 1 Bottom Grid
GD31-36S | 3 Cutting Board
GD-40S | 4 Universal Roller Mat
UV-36RM | 5 Pop-Up Strainer
900P
900P-SN27 | 6 Strainer Basket
906
906SN | 7 Inox Cream
903 |
|----------------------------------|----------------------------------|--|---|--|----------------------------|

GDX12031 \$925



SPECIFICATIONS

Interior Dimensions: 31 1/8" x 17" x 9"
 Exterior Dimensions: 32 7/8" x 18 3/4"
 Minimum Cabinet Size: 36"
 Gauge: 18
 Weight: 29 lbs.
 Sound Dampening: Sound Pad & Spray Coat
 Stainless Finish: Silk
 Corner Radius: 50mm
 Installation: Undermount

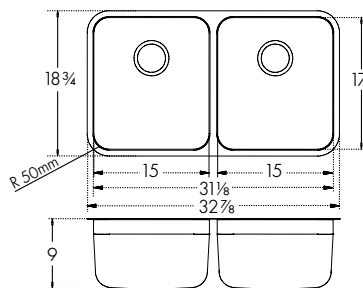

ACCESSORIES

- | | | | | | |
|----------------------------------|----------------------------------|--|---|--|----------------------------|
| 2 Bottom Grid
NC15-36S | 3 Cutting Board
GD-40S | 4 Universal Roller Mat
UV-36RM | 5 Pop-Up Strainer
900P
900P-SN27 | 6 Strainer Basket
906
906SN | 7 Inox Cream
903 |
|----------------------------------|----------------------------------|--|---|--|----------------------------|

ACCESSORIES

- | | | | |
|---|--|---|--|
|
1 Bottom Grid
29 3/8" x 15 1/2"
Stainless
GD31-36S
\$202 |
2 Bottom Grid
13" x 15 1/8"
Stainless
NC15-36S
\$120 |
3 Cutting Board
18 3/8" x 14 3/4"
Solid Wood
GD-40S
\$243 |
4 Universal Roller Mat
18 7/8" x 20"
Stainless
UV-36RM
\$160 |
|
5 Pop-Up Strainer
Chrome
900P
\$116
Satin Nickel
900P-SN27
\$137 |
6 Strainer Basket
Chrome
906
\$62
Satin Nickel
906SN
\$85 |
7 Inox Cream
Stainless
Steel Polish
903
\$31 | |

Note: All accessories sold separately unless otherwise indicated. Design of custom accessories subject to change without notice. It is absolutely critical that you have the sink and any custom sink accessories on site prior to any cut or modification to the countertop. Franke will not be responsible for any errors in countertop preparation and sink installation.





ROTONDO

The Rotondo offers the option of **topmount or undermount** installation along with a **smaller size** that works well in the kitchen, bar or laundry. Its attractive **round design** perks up even the most utilitarian space.



RBX-110 \$535



SPECIFICATIONS

Interior Dimensions: 14 3/4" x 6 7/16"
 Exterior Dimensions: 17 1/8" x 6 7/16"
 Minimum Cabinet Size: 21" (undermount)
 18" (topmount)

Gauge: 20
 Weight: 5 lbs.
 Sound Dampening: Sound Pad
 Stainless Finish: Silk
 Installation: Undermount
 with 1/2" Reveal or Topmount

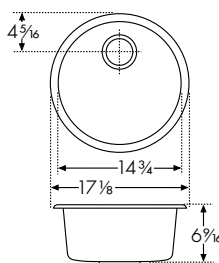





May be used as a topmount (has polished rim).
 May be undermounted (requires EL-Clips).
 Use interior dimensions as cutout guide.

ACCESSORIES

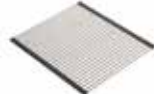
- | | | | | |
|---------------------------------|--|---|--|----------------------------|
| 1 Bottom Grid
RBG-36S | 2 Universal Roller Mat
UV-36RM | 3 Pop-Up Strainer
900P
900P-SN27 | 4 Strainer Basket
906
906SN | 5 Inox Cream
903 |
|---------------------------------|--|---|--|----------------------------|

ACCESSORIES

- | | | | | |
|--|--|--|---|--|
| 
1 Bottom Grid
14 1/4"
Stainless
RBG-36S
\$150 | 
2 Universal Roller Mat
18 7/16" x 20"
Stainless
UV-36RM
\$160 | 
3 Pop-Up Strainer
Chrome
900P
\$116
Satin Nickel
900P-SN27
\$137 | 
4 Strainer Basket
Chrome
906
\$62
Satin Nickel
906SN
\$85 | 
5 Inox Cream
Stainless
Steel Polish
903
\$31 |
|--|--|--|---|--|

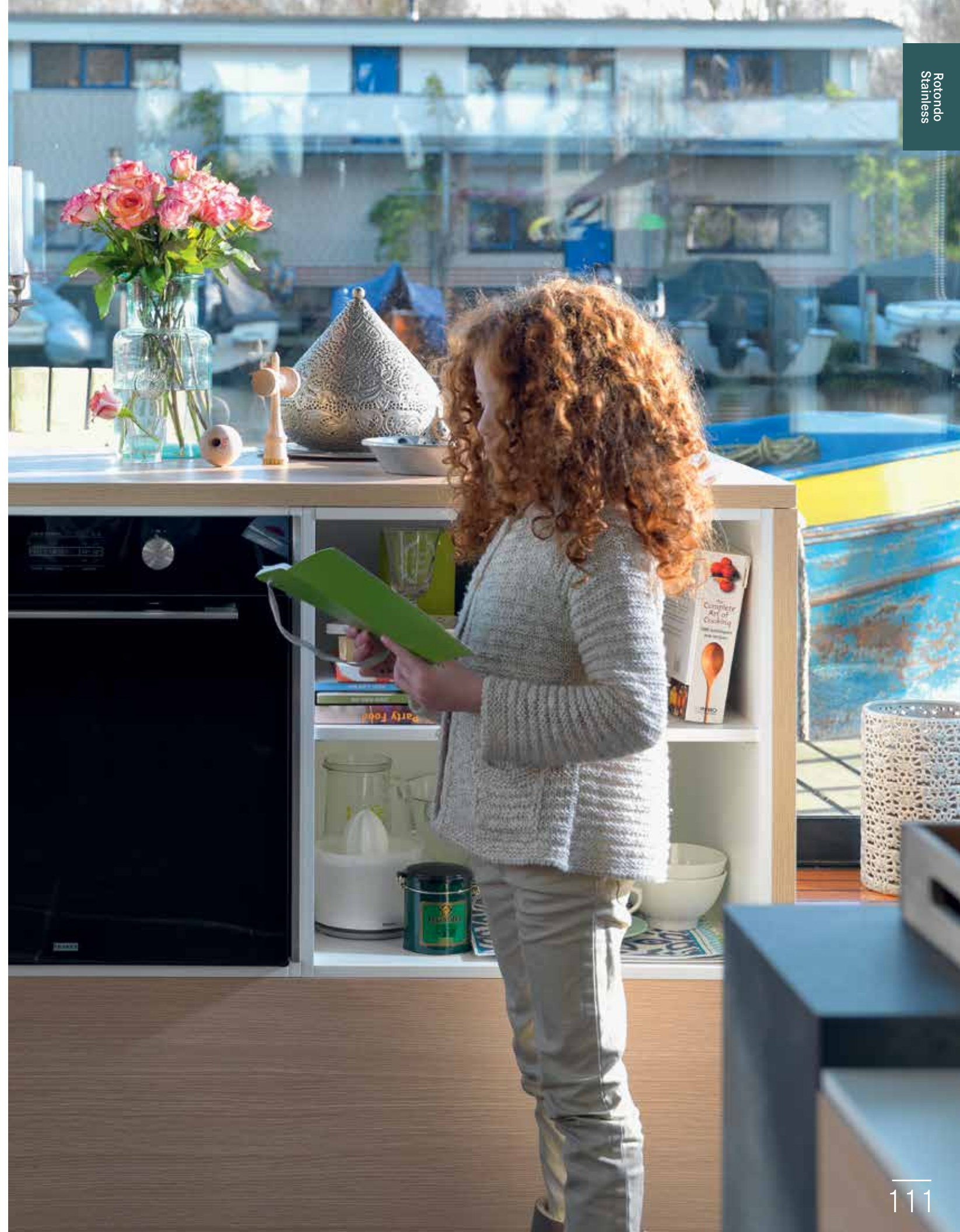

The kitchen is the heart of your home and your sink should reflect your kitchen's style. Whether it's family breakfast on the go, a leisurely weekend brunch or holiday dinner for 20, your Franke Home Collection sink is a reliable helpmate at the center of kitchen activity.



PERFECT SOLUTIONS



LITTLE THINGS GO A LONG WAY

Our Home Collection sinks are crafted with attention to the details that make your time in the kitchen more productive and rewarding.

- **Double bowl sinks** are created using seamless press technology, which eliminates the needs to buff or grind center seam weld marks and results in a smoother, blemish-free finish.
- **Ultra Quiet™** sound-deadening pads insulate against excess noise vibration.
- **Extra-deep ledges** help to keep water in the sink and off the countertop.
- **Integrated installation rails** are created as sink decks are fabricated to eliminate unsightly weld blemishes.
- **The reinforced Safe-T Rim** eliminates sharp sink edges, adds strength and creates a stylish finished product.



REVOLUTIONARY INSTALLATION SYSTEM



The Fast-in® Revolutionary Installation System securely anchors a topmount sink or faucet to the countertop without the need to be underneath the sink. All installation hardware required comes pre-attached to the Fast-in faucets and sinks.



Look for the Fast-in logo to see which Franke sinks and faucets are available with the Fast-in Revolutionary Installation System.



FAST-IN SINK INSTALLATION



STEP 1
Lower your Franke Fast-in sink into the opening in the worktop surface.



STEP 2
Press the Franke Fast-in sink downward until you hear a click. This means the pre-attached clips have snapped into place. Job done!

FAST-IN FAUCET INSTALLATION

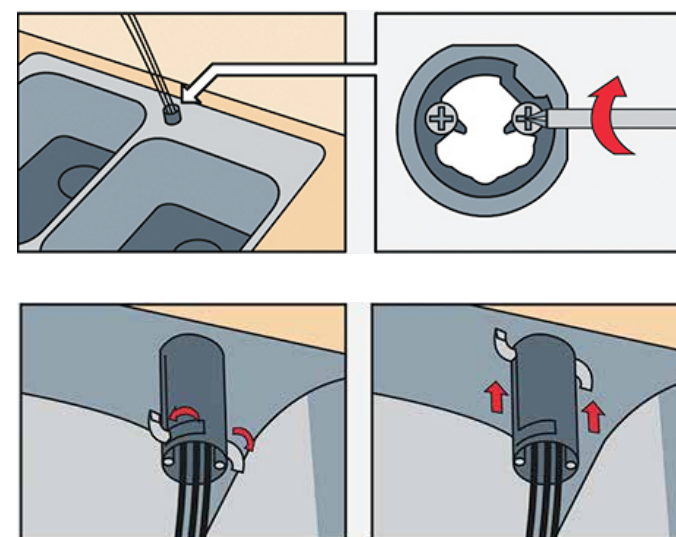

STEP 1
Feed the supply hoses through the sink hole and position the Fast-in faucet base on top.

STEP 2
Tighten the mounting screws located on the Fast-in base with a screwdriver. Two mounting cleats will activate and rise until they connect with the mounting surface, guaranteeing a secure custom fit and installation.

STEP 3
Secure faucet to Fast-in base with set screw.

VECTOR
HTS1722-1 \$475

(1 faucet hole)
NEW HTS1722-1KIT \$525

(1 faucet hole)
Kit Available Spring 2019



SPECIFICATIONS

Interior Dimensions: 15 3/8" x 18 1/8" x 9"
Exterior Dimensions: 17" x 22 3/8"
Minimum Cabinet Size: 21"
Gauge: 18
Weight: 20 lbs.
Sound Dampening: Sound Pad
Finish: Polished Satin
Corner Radius: 12mm
Installation: Dual Mount

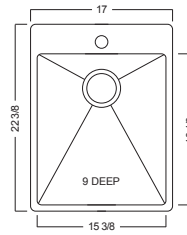

ACCESSORIES

- | | | | |
|---|-------------------------------|---|--------------------------|
| 1 | Bottom Grid
BGHF200 | 5 | Inox Cream
903 |
|---|-------------------------------|---|--------------------------|



HTS1722-1KIT

- Kit includes:
- Sink
 - Adjustable Basket
 - Bottom Grid
 - Strainer Basket (1)

VECTOR
HTS2022-1 \$555

(1 faucet hole)
NEW HTS2022-1KIT \$575

(1 faucet hole)
Kit Available Spring 2019



SPECIFICATIONS

Interior Dimensions: 18 1/8" x 18 1/8" x 9"
Exterior Dimensions: 19 1/2" x 22 1/2"
Minimum Cabinet Size: 24"
Gauge: 18
Weight: 23 lbs.
Sound Dampening: Sound Pad
Finish: Polished Satin
Corner Radius: 12mm
Installation: Dual Mount

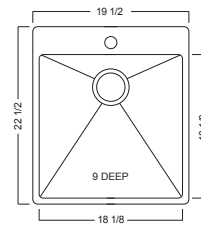

ACCESSORIES

- | | | | |
|---|-------------------------------|---|--------------------------|
| 2 | Bottom Grid
BGHF300 | 5 | Inox Cream
903 |
|---|-------------------------------|---|--------------------------|



HTS2022-1KIT

- Kit includes:
- Sink
 - Utensil Holder
 - Bottom Grid
 - Strainer Basket (1)

VECTOR
HFS2522-1 \$660

(1 faucet hole)
NEW HFS2522-1KIT \$715

(1 faucet hole)
Kit Available Spring 2019



SPECIFICATIONS

Interior Dimensions: 23 7/16" x 18 1/8" x 9"
Exterior Dimensions: 25" x 22 7/16"
Minimum Cabinet Size: 27"
Gauge: 18
Weight: 26 lbs.
Sound Dampening: Sound Pad
Finish: Polished Satin
Corner Radius: 12mm
Installation: Dual Mount

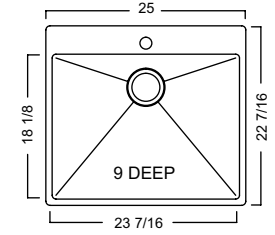

ACCESSORIES

- | | | | |
|---|-------------------------------|---|--------------------------|
| 3 | Bottom Grid
BGHF101 | 5 | Inox Cream
903 |
|---|-------------------------------|---|--------------------------|



HFS2522-1KIT

- Kit includes:
- Sink
 - Utensil Holder
 - Bottom Grid
 - Strainer Basket (1)

VECTOR
HFS3322-1 \$805

(1 faucet hole)
NEW HFS3322-1KIT \$860

(1 faucet hole)
HFS3322-2 \$805

(2 faucet holes)
Kit Available Spring 2019



SPECIFICATIONS

Interior Dimensions: 31 7/8" x 18 1/8" x 9"
Exterior Dimensions: 33 7/16" x 22 7/16"
Minimum Cabinet Size: 36"
Gauge: 18
Weight: 36 lbs.
Sound Dampening: Sound Pad
Finish: Polished Satin
Corner Radius: 12mm
Installation: Dual Mount

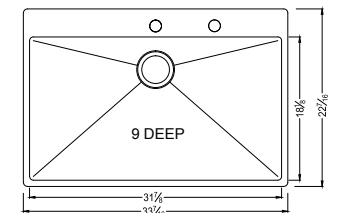

ACCESSORIES

- | | | | |
|---|-------------------------------|---|--------------------------|
| 4 | Bottom Grid
BGHF115 | 5 | Inox Cream
903 |
|---|-------------------------------|---|--------------------------|

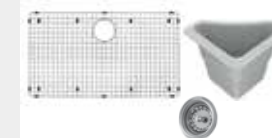

HFS3322-1KIT

- Kit includes:
- Sink
 - Utensil Holder
 - Bottom Grid
 - Strainer Basket (1)

ACCESSORIES

- | | | | | |
|---|--|--|--|--|
| | | | | |
| 1 Bottom Grid
17 5/16" x 14 3/4"
Stainless
BGHF200
\$95 | 2 Bottom Grid
17 5/16" x 17 5/16"
Stainless
BGHF300
\$95 | 3 Bottom Grid
17 5/16" x 21 3/4"
Stainless
BGHF101
\$105 | 4 Bottom Grid
17 5/16" x 31 1/8"
Stainless
BGHF115
\$116 | 5 Inox Cream
Stainless
Steel Polish
903
\$31 |

VECTOR
HF3322-1 \$825

NEW **HF3322-1KIT** \$880

Kit Available Spring 2019



SPECIFICATIONS

Interior Dimensions: 31 3/4" x 18 1/8" x 9"
Exterior Dimensions: 33 7/16" x 22 7/16"
Minimum Cabinet Size: 36"
Gauge: 18
Weight: 34 lbs.
Sound Dampening: Sound Pad
Finish: Polished Satin
Corner Radius: 12mm
Installation: Dual Mount

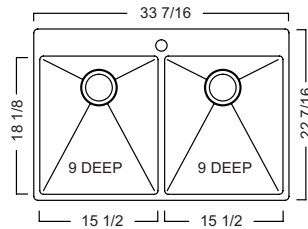

ACCESSORIES

- 2** Bottom Grid
BGHF210
- 4** Inox Cream
903



HF3322-1KIT

- Kit includes:
- Sink
 - Adjustable Basket
 - Bottom Grid (1)
 - Strainer Baskets (2)

EVOLUTION
EVSAS801-20 \$320

EVSAS804-20 \$320



SPECIFICATIONS

Interior Dimensions: 22 1/2" x 16 1/2" x 8"
Exterior Dimensions: 25 1/2" x 22 1/2"
Minimum Cabinet Size: 27"
Gauge: 20
Weight: 15 lbs.
Sound Dampening: Sound Pad & Spray Coat
Finish: Polished Satin
Corner Radius: 70mm
Installation: Topmount

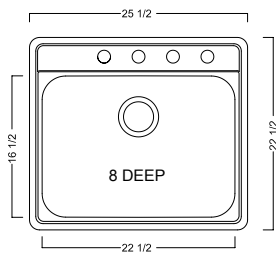

ACCESSORIES

- 3** Bottom Grid
EVBG2115
- 4** Inox Cream
903

EVOLUTION
EVSCG801-18 \$385

NEW **EVSCG801-18KIT** \$435

EVSCG804-18 \$385

NEW **EVSCG804-18KIT** \$435

Kits Available Spring 2019



SPECIFICATIONS

Interior Dimensions: 22 1/2" x 16 1/2" x 8"
Exterior Dimensions: 25 1/2" x 22 1/2"
Minimum Cabinet Size: 27"
Gauge: 18
Weight: 16 lbs.
Sound Dampening: Sound Pad & Spray Coat
Finish: Polished Satin
Corner Radius: 70mm
Installation: Topmount

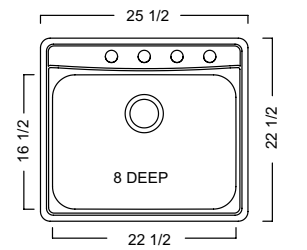

ACCESSORIES

- 3** Bottom Grid
EVBG2115
- 4** Inox Cream
903

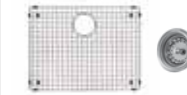

EVSCG801-18KIT

- Kit includes:
- Sink
 - Bottom Grid
 - Strainer Basket (1)

EVOLUTION
EVDAS801-20 \$375

EVDAS804-20 \$375



SPECIFICATIONS

Interior Dimensions: 31 1/2" x 16 1/2" x 8"
Exterior Dimensions: 33 1/2" x 22 1/2"
Minimum Cabinet Size: 36"
Gauge: 20
Weight: 24 lbs.
Sound Dampening: Sound Pad & Spray Coat
Finish: Polished Satin
Corner Radius: 70mm
Installation: Topmount

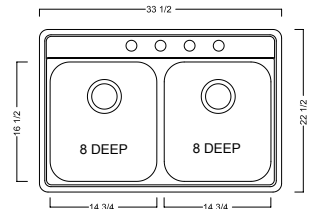

ACCESSORIES

- 1** Bottom Grid
EVBG1315
- 4** Inox Cream
903

ACCESSORIES

- 1** Bottom Grid
15" x 13 1/4"
Stainless
EVBG1315
\$95
- 2** Bottom Grid
14" x 16 1/2"
Stainless
BGHF210
\$92
- 3** Bottom Grid
21" x 15"
Stainless
EVBG2115
\$116
- 4** Inox Cream
Stainless
Steel Polish
903
\$31

EVOLUTION

EVDCG801-18 \$430

(1 faucet hole)

EVDCG804-18 \$430

(4 faucet holes)

EVDCG804-18KIT \$490

(4 faucet holes)

Kit Available Spring 2019

SPECIFICATIONS

Interior Dimensions: 31 1/2" x 16 1/2" x 8"
 Exterior Dimensions: 33 1/2" x 22 1/2"
 Minimum Cabinet Size: 36"
 Gauge: 18
 Weight: 24 lbs.
 Sound Dampening: Sound Pad & Spray Coat
 Finish: Polished Satin
 Corner Radius: 70mm
 Installation: Topmount

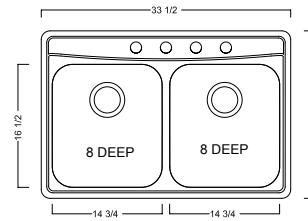

ACCESSORIES

- 1 Bottom Grid EVBG1315
- 3 Inox Cream 903

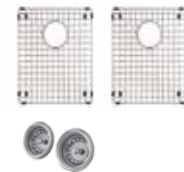

EVDCG804-18KIT

Kit includes:

- Sink
- Bottom Grids (2)
- Strainer Baskets (2)

EVOLUTION

EVDCG901-18 \$480

(1 faucet hole)

EVDCG901-18KIT \$555

(1 faucet hole)

EVDCG904-18 \$480

(4 faucet holes)

EVDCG904-18KIT \$555

(4 faucet holes)

Kits Available Spring 2019

SPECIFICATIONS

Interior Dimensions: 31 1/2" x 16 1/2" x 9"
 Exterior Dimensions: 33 1/2" x 22 1/2"
 Minimum Cabinet Size: 36"
 Gauge: 18
 Weight: 26 lbs.
 Sound Dampening: Sound Pad & Spray Coat
 Finish: Polished Satin
 Corner Radius: 70mm
 Installation: Topmount

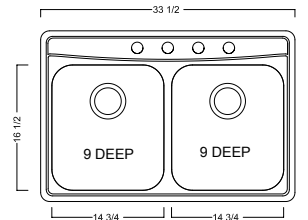

ACCESSORIES

- 1 Bottom Grid EVBG1315
- 3 Inox Cream 903

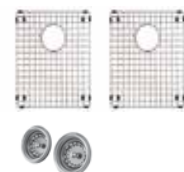

EVDCG901-18KIT
EVDCG904-18KIT

Kit includes:

- Sink
- Bottom Grids (2)
- Strainer Baskets (2)

EVOLUTION

EVCAG901-18 \$510

(1 faucet hole)

EVCAG901-18KIT \$585

(1 faucet hole)

EVCAG902-18KIT \$675

(2 faucet holes)

EVCAG904-18 \$510

(4 faucet holes)

EVCAG904-18KIT \$585

(4 faucet holes)

Kits Available Spring 2019

SPECIFICATIONS

Interior Dimensions: 31 1/2" x 19 1/2" x 16 1/2" x 9" & 8"
 Exterior Dimensions: 33 1/2" x 22 1/2"
 Minimum Cabinet Size: 36"
 Gauge: 18
 Weight: 26 lbs.
 Sound Dampening: Sound Pad & Spray Coat
 Finish: Polished Satin
 Corner Radius: 70mm
 Installation: Topmount

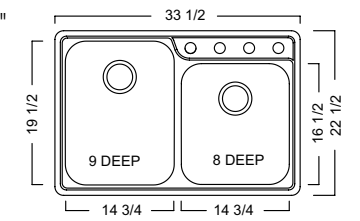

ACCESSORIES

- 1 Bottom Grid EVBG1315
- 2 Bottom Grid EVBG1318
- 3 Inox Cream 903



EVCAG902-18KIT

Kit includes:

- Sink
- Faucet
- Soap Dispenser
- Strainer Baskets (2)

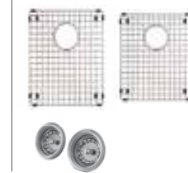

EVCAG901-18KIT
EVCAG904-18KIT

Kit includes:

- Sink
- Bottom Grids (2)
- Strainer Baskets (2)

EVOLUTION

EVDAG901-18 \$465

(1 faucet hole)

EVDAG901-18KIT \$535

(1 faucet hole)

EVDAG904-18 \$465

(4 faucet holes)

EVDAG904-18KIT \$535

(4 faucet holes)

Kits Available Spring 2019

SPECIFICATIONS

Interior Dimensions: 31 1/2" x 16 1/2" x 9"
 Exterior Dimensions: 33 1/2" x 22 1/2"
 Minimum Cabinet Size: 36"
 Gauge: 20
 Weight: 26 lbs.
 Sound Dampening: Sound Pad & Spray Coat
 Finish: Polished Satin
 Corner Radius: 70mm
 Installation: Topmount

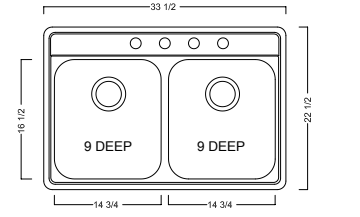

ACCESSORIES

- 1 Bottom Grid EVBG1315
- 3 Inox Cream 903

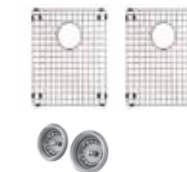

EVSCG801-18KIT
EVSCG804-18KIT

Kit includes:

- Sink
- Bottom Grids (2)
- Strainer Baskets (2)

ACCESSORIES

- 1 Bottom Grid 15" x 13 1/4" Stainless EVBG1315 \$95
- 2 Bottom Grid 18" x 13 1/4" Stainless EVBG1318 \$106
- 3 Inox Cream Stainless Steel Polish 903 \$31

EVOLUTION
EVDCS802KIT

(2 faucet holes)

\$585 SPECIFICATIONS



Interior Dimensions: 31 1/2" x 16 1/2" x 8"
 Exterior Dimensions: 33 1/2" x 22 1/2"
 Minimum Cabinet Size: 36"
 Gauge: 20
 Weight: 34 lbs.
 Sound Dampening: Sound Pad & Spray Coat
 Finish: Polished Satin
 Corner Radius: 65mm
 Installation: Topmount

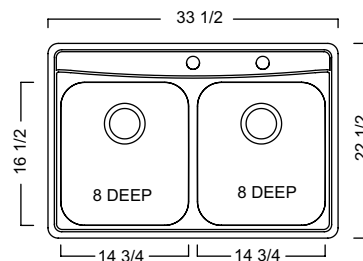

ACCESSORIES

- | | |
|--|------------------------------------|
| <p>1 Bottom Grid
EVBG1315</p> | <p>2 Inox Cream
903</p> |
|--|------------------------------------|



EVDCS802KIT

- Kit includes:
- Sink
 - Satin Nickel Faucet
 - Satin Nickel Soap Dispenser
 - Strainer Baskets (2)

ACCESSORIES



- | | |
|--|---|
| <p>1 Bottom Grid
15" x 13 1/4"
Stainless
EVBG1315
\$95</p> | <p>2 Inox Cream
Stainless
Steel Polish
903
\$31</p> |
|--|---|

PERFECT TOGETHER
FAST-IN FAUCETS

For the complete FAST-IN Faucet Collection see page 256



BERN PRO
FFPD20850



BERN
FF20750



BERNARD
FFPS20550



BERNADINE
FF20650



KINETIC

FFS30B-10-18 \$895

NEW FFS30B-10-18KIT \$970

Kit Available Spring 2019



SPECIFICATIONS

Interior Dimensions: 27" x 16" x 10"
 Exterior Dimensions: 30" x 20 3/4"
 Minimum Cabinet Size: 30"
 Gauge: 18
 Weight: 58 lbs.
 Sound Dampening: Sound Pad
 Finish: Satin Rim & Bowl
 Corner Radius: 12mm
 Installation: Apron Front

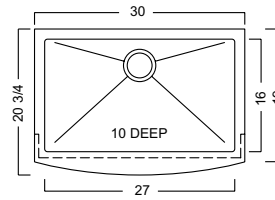

ACCESSORIES

3 Bottom Grid CU27-36S



FFS30B-10-18KIT

Kit includes:
 • Sink
 • Bottom Grid
 • Strainer Basket (1)

KINETIC

FFS33B-10-18 \$925

NEW FFS33B-10-18KIT \$995

Kit Available Spring 2019



SPECIFICATIONS

Interior Dimensions: 30" x 16" x 10"
 Exterior Dimensions: 33" x 20 3/4"
 Minimum Cabinet Size: 33"
 Gauge: 18
 Weight: 59 lbs.
 Sound Dampening: Sound Pad
 Finish: Satin Rim & Bowl
 Corner Radius: 12mm
 Installation: Apron Front

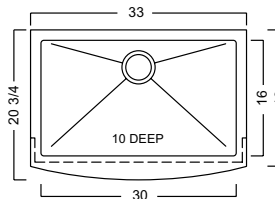

ACCESSORIES

4 Bottom Grid CU30-36S



FFS33B-10-18KIT

Kit includes:
 • Sink
 • Bottom Grid
 • Strainer Basket (1)

KINETIC

FFD33B-9-18 \$995



SPECIFICATIONS

Interior Dimensions: 30" x 14 3/4" x 9"
 Exterior Dimensions: 33" x 19"
 Minimum Cabinet Size: 33"
 Gauge: 18
 Weight: 60 lbs.
 Sound Dampening: Sound Pad
 Finish: Satin Rim & Bowls
 Corner Radius: 12mm
 Installation: Apron Front

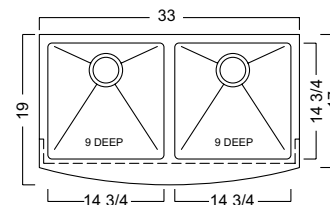

VECTOR

HF3322-2 \$825

(2 faucet holes)



SPECIFICATIONS

Interior Dimensions: 30 1/4" x 16 3/4" x 9"
 Exterior Dimensions: 33" x 22"
 Minimum Cabinet Size: 36"
 Gauge: 18
 Weight: 34 lbs.
 Sound Dampening: Sound Pad
 Finish: Polished Satin
 Corner Radius: 12mm
 Installation: Dual Mount

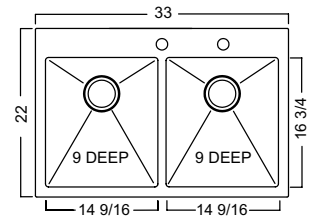

ACCESSORIES

1 Bottom Grid FBGH1613

VECTOR

HFT4322-2 \$ 995

(2 faucet holes)

NEW HFT4322-2KIT \$1,055

(2 faucet holes)

HFT4322-4 \$ 995

(4 faucet holes)

NEW HFT4322-4KIT \$1,055

(4 faucet holes)

Kits Available Spring 2019



SPECIFICATIONS

Interior Dimensions: 41 1/2" x 17 3/4" x 9"
 Exterior Dimensions: 43" x 22"
 Minimum Cabinet Size: 45"
 Gauge: 18
 Weight: 46 lbs.
 Sound Dampening: Sound Pad
 Finish: Polished Satin
 Corner Radius: 12mm
 Installation: Dual Mount

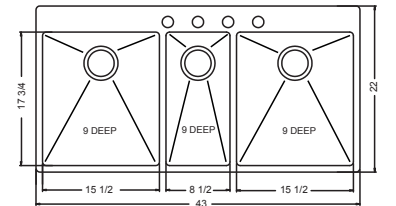

ACCESSORIES

2 Bottom Grid BGHF200



HFT4322-2KIT
HFT4322-4KIT

Kit includes:
 • Sink
 • Adjustable Basket
 • Bottom Grids (2)
 • Strainer Baskets (3)

ACCESSORIES



1 Bottom Grid 15 7/8" x 13 3/4" Stainless FBGH1613 \$90



2 Bottom Grid 17 5/8" x 14 3/4" Stainless BGHF200 \$95

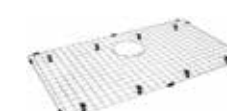

3 Bottom Grid 26 3/16" x 15 3/8" Stainless CU27-36S \$150



4 Bottom Grid 29 1/4" x 15 3/8" Stainless CU30-36S \$160

VECTOR
NEW HFO3322-1 \$820
 Available Spring 2019



SPECIFICATIONS

Interior Dimensions: 31 7/8" x 20 7/8" x 9"
 Exterior Dimensions: 33 7/16" x 22 7/16"
 Minimum Cabinet Size: 36"
 Gauge: 18
 Weight: 34 lbs.
 Sound Dampening: Sound Pad
 Finish: Polished Satin
 Corner Radius: 12mm
 Installation: Dual Mount

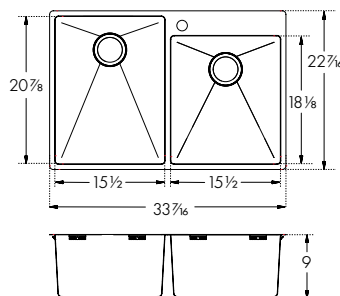

ACCESSORIES

- 1 | **Bottom Grid**
BGHF210
- 2 | **Bottom Grid**
BGHF400

AXIS
BMSK802 \$268
 (2 faucet holes)
BMSK803 \$268
 (3 faucet holes)



SPECIFICATIONS

Interior Dimensions: 17" x 12" x 8"
 Exterior Dimensions: 19 1/8" x 17"
 Minimum Cabinet Size: 21"
 Gauge: 20
 Weight: 8 lbs.
 Sound Dampening: Sound Pad
 Finish: Mirror Deck/Silk Bowl
 Corner Radius: 70mm
 Installation: Dual Mount

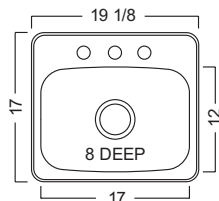

ACCESSORIES

- 3 | **Bottom Grid**
FBG65S

AXIS
SL101BX \$278
 (1 faucet hole)
SL103BX \$278
NEW SL103BXKIT \$330
 (3 faucet holes)
 Kit Available Spring 2019



SPECIFICATIONS

Interior Dimensions: 18" x 16" x 10"
 Exterior Dimensions: 20 1/8" x 20 7/16"
 Minimum Cabinet Size: 24"
 Gauge: 20
 Weight: 13 lbs.
 Sound Dampening: Sound Pad
 Finish: Silk Deck & Bowl
 Corner Radius: 70mm
 Installation: Dual Mount

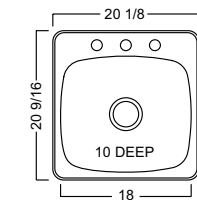

ACCESSORIES

- 4 | **Bottom Grid**
FBG110S



SL103BXKIT

- Kit includes:
- Sink
 - Bottom Grid
 - Strainer Basket (1)

AXIS
NEW FBSLD901-18BXKIT \$495
 (1 faucet hole)
FBSLD904-18BX \$460
 (4 faucet holes)
 Kit Available Spring 2019



SPECIFICATIONS

Interior Dimensions: 29 7/16" x 18 1/2" x 9"
 Exterior Dimensions: 33" x 22"
 Minimum Cabinet Size: 36"
 Gauge: 18
 Weight: 19 lbs.
 Sound Dampening: Sound Pad & Spray Coat
 Finish: Polished Satin
 Corner Radius: 70mm
 Installation: Dual Mount

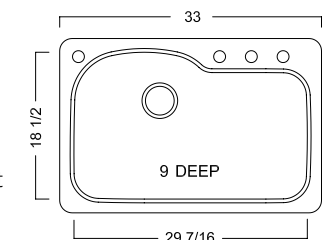

ACCESSORIES

- 5 | **Bottom Grid**
FBG2817



FBSLD901-18BXKIT

- Kit includes:
- Sink
 - Bottom Grid
 - Strainer Basket (1)

ACCESSORIES

- 1 | **Bottom Grid**
14" x 16 1/2"
Stainless
BGHF210
\$92
- 2 | **Bottom Grid**
14" x 19 1/4"
Stainless
BGHF400
\$102
- 3 | **Bottom Grid**
14 3/4" x 9 1/2"
Stainless
FBG65S
\$67
- 4 | **Bottom Grid**
15 7/8" x 13 7/8"
Stainless
FBG110S
\$92
- 5 | **Bottom Grid**
16 3/8" x 27 1/2"
Stainless
FBG2817
\$144

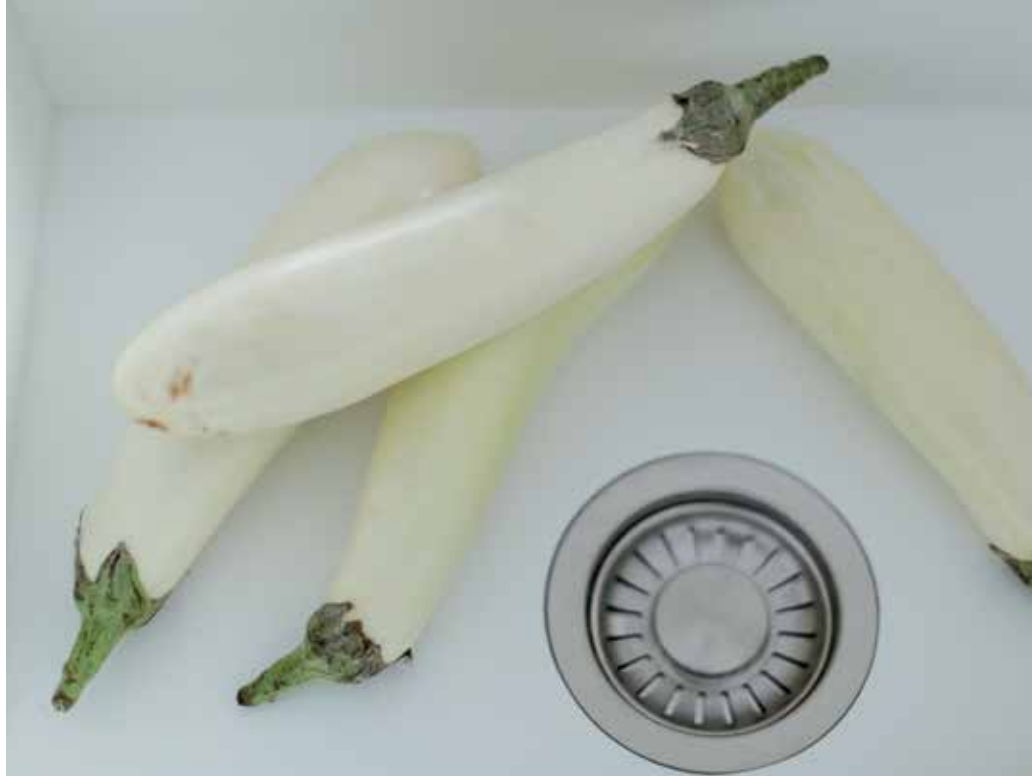

FIRECLAY SINKS

- LUXURY COLLECTION
- Manor House 132-135
 - Farm House 136-141
 - Orca 142-145
 - Prestige 146-149
 - Cisterna 150-153
- HOME COLLECTION
- Kinetic 154-157





WONDERFULLY ELEGANT FIRECLAY



The perfect blend of nature and design, fireclay is made of liquid ceramic which is then fired to create a material that feels incomparably smooth and is tremendously hard-wearing. Whether you prefer classic or modern design, you will simply love the delicate shapes and expressive colors of our Fireclay sinks.

Note: Color may vary between series.



HOW YOUR FIRECLAY SINK IS MADE

Liquid ceramic consisting of quartz, china clay and kaolin is injected into a mold under high pressure. Prior to drying, surface imperfections are smoothed with soft sponges and a level surface is created with water. The final drying process involves 20 hours in a tunnel kiln at 2200° F. At every stage, each sink is subjected to stringent quality checks performed by experts to make it wonderful.

A LIFETIME OF SERVICE

Fireclay is entirely natural, very stylish and amazingly practical. We apply a dirt-repellent finishing polish which means that any mess, tea or red wine stains can simply be wiped with a little soapy water.

SILKY SMOOTH GOOD LOOKS

Fireclay sinks combine beautifully with a variety of work surfaces such as wood, glass and granite. It's a durable choice that stands up to heat, staining and impact with ease.

VILLEROY & BOCH

Many handcrafted Franke Fireclay sinks are designed in partnership with Villeroy & Boch, a world-renowned premium porcelain and ceramic producer since 1748. Together, Franke and Villeroy & Boch create distinctive designs that enhance your personal kitchen style.



MANOR HOUSE

Villeroy & Boch brings centuries of excellence to the handcrafted beauty of Manor House **apron-front** sinks. **Scratch-resistant** and **hygienic** fireclay offers the qualities most desired in today's kitchens.



Note: Color may vary between series.

Pictured: MHK720-35WH sink with FF7000A faucet, LB12200 filtration faucet, SD6000 soap dispenser and WD3428C air switch

MHK110-20WH White \$1,050



SPECIFICATIONS

Interior Dimensions: 18 1/8" x 13 1/4" x 5 7/8"
 Exterior Dimensions: 19 1/2" x 16" x 6 3/4"
 Minimum Cabinet Size: 21"
 Weight: 40 lbs.
 Corner Radius: 12mm
 Installation: Undermount
 Apron Front

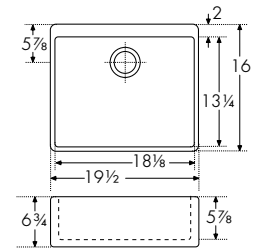

Note: Dimensions may vary by 2% (plus or minus), due to material attributes and firing process. See website for Fireclay Repair Kits. Pop-Up strainer not compatible. **Special installation required - see website.** Finished on front and sides only.

ACCESSORIES

- 7 **Cutting Board**
OA-40S
- 8 **Strainer Basket**
906
906SN

MHK110-24WH White \$1,390



SPECIFICATIONS

Interior Dimensions: 22" x 16 7/8" x 7 1/8"
 Exterior Dimensions: 23 5/8" x 19 7/8" x 8 1/8"
 Minimum Cabinet Size: 24"
 Weight: 58 lbs.
 Corner Radius: 12mm
 Installation: Undermount
 Apron Front

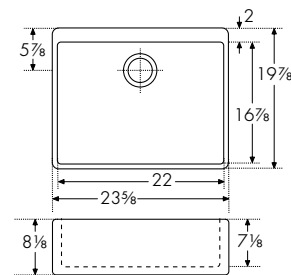

Note: Dimensions may vary by 2% (plus or minus), due to material attributes and firing process. See website for Fireclay Repair Kits. Pop-Up strainer not compatible. **Special installation required - see website.** Finished on front and sides only.

ACCESSORIES

- 1 **Bottom Grid**
MK24-36C
- 7 **Cutting Board**
OA-40S
- 8 **Strainer Basket**
906
906SN

MHK110-28WH White \$1,475



SPECIFICATIONS

Interior Dimensions: 26" x 17 3/8" x 7 1/8"
 Exterior Dimensions: 27 1/8" x 19 7/8" x 7 7/8"
 Minimum Cabinet Size: 30"
 Weight: 64 lbs.
 Corner Radius: 12mm
 Installation: Undermount

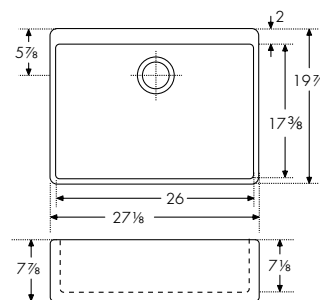

Note: Dimensions may vary by 2% (plus or minus), due to material attributes and firing process. See website for Fireclay Repair Kits. Pop-Up strainer not compatible. **Special installation required - see website.** Finished on front and sides only.

ACCESSORIES

- 2 **Bottom Grid**
MK28-36C
- 7 **Cutting Board**
OA-40S
- 8 **Strainer Basket**
906
906SN

MHK720-31WH White \$1,860



SPECIFICATIONS

Interior Dimensions: 29 7/8" x 18 1/2" x 7 7/8"
 Exterior Dimensions: 31 1/4" x 19 7/8" x 8 5/8"
 Minimum Cabinet Size: 33"
 Weight: 82 lbs.
 Corner Radius: 12mm
 Installation: Undermount
 Apron Front

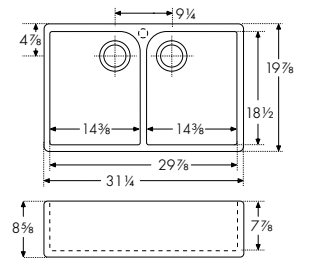

Note: Dimensions may vary by 2% (plus or minus), due to material attributes and firing process. See website for Fireclay Repair Kits. Pop-Up strainer not compatible. **Special installation required - see website.** Finished on front and sides only.

ACCESSORIES

- 3 **Bottom Grid**
MK31-36C-LH
- 4 **Bottom Grid**
MK31-36C-RH
- 7 **Cutting Board**
OA-40S
- 8 **Strainer Basket**
906
906SN

MHK720-35WH White \$2,485



SPECIFICATIONS

Interior Dimensions: 34" x 20 1/2" x 7 7/8"
 Exterior Dimensions: 35 5/8" x 21 7/8" x 8 5/8"
 Minimum Cabinet Size: 36"
 Weight: 96 lbs.
 Corner Radius: 12mm
 Installation: Undermount
 Apron Front

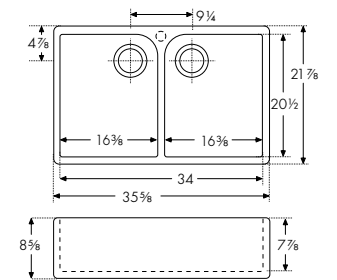

Note: Dimensions may vary by 2% (plus or minus), due to material attributes and firing process. See website for Fireclay Repair Kits. Pop-Up strainer not compatible. **Special installation required - see website.** Finished on front and sides only.

ACCESSORIES

- 5 **Bottom Grid**
MK35-36C-LH
- 6 **Bottom Grid**
MK35-36C-RH
- 7 **Cutting Board**
OA-40S
- 8 **Strainer Basket**
906
906SN

ACCESSORIES

- 1 **Bottom Grid**
21" x 15 7/8"
Coated
Stainless
MK24-36C
\$212
- 2 **Bottom Grid**
25 3/16" x 15 7/8"
Coated
Stainless
MK28-36C
\$233
- 3 **Bottom Grid**
17 1/16" x 13 11/16"
Coated Stainless
MK31-36C-LH
\$223
- 4 **Bottom Grid**
17 1/16" x 13 11/16"
Coated Stainless
MK31-36C-RH
\$223
- 5 **Bottom Grid**
19 3/16" x 15 3/8"
Coated
Stainless
MK35-36C-LH
\$264
- 6 **Bottom Grid**
19 3/16" x 15 3/8"
Coated
Stainless
MK35-36C-RH
\$264
- 7 **Cutting Board**
14 1/2" x 21 7/8"
Solid Wood
OA-40S
\$350
- 8 **Strainer Basket**
Chrome
906
\$62

Satin Nickel
906SN
\$85



Pictured: FHK710-36WH sink with FF7000A faucet, LB12200 filtration faucet and WD3428SN air switch



FARM HOUSE

Franke's **apron front** farmhouse sinks are made of attractive fireclay for a **smooth, polished finish** that's both durable and **easy to clean**. For design flexibility, we offer two sinks (FH3K710-30 and FH3K710-33) that let you install either a **traditional flat apron front** or a **fluted front** design.



Note: Color may vary between series.

NEW Available Spring 2019

FH2K110-24WH  White **\$ 825**
FH2K110-24MB  Matte Black **\$ 925**



SPECIFICATIONS

Interior Dimensions: 21 1/2" x 15 3/4" x 9"
 Exterior Dimensions: 23 7/8" x 18 1/8" x 10"
 Minimum Cabinet Size: 24"
 Weight: 51 lbs.
 Corner Radius: 15mm
 Installation: Undermount
 Apron Front

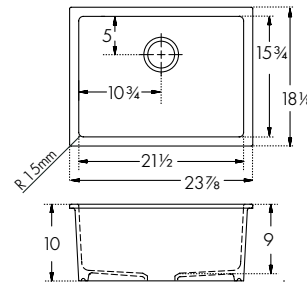

ACCESSORIES

- 1 **Bottom Grid** FK2-24-36S
- 7 **Strainer Basket** 906 906SN

Note: Dimensions may vary by 2% (plus or minus), due to material attributes and firing process. See website for Fireclay Repair Kits. Pop-Up strainer not compatible. **Special installation required - see website.**

NEW Available Spring 2019

FH2K110-30WH  White **\$ 925**
FH2K110-30MB  Matte Black **\$1,025**



SPECIFICATIONS

Interior Dimensions: 28 1/4" x 16 7/16" x 9"
 Exterior Dimensions: 29 15/16" x 18 1/8" x 10"
 Minimum Cabinet Size: 30"
 Weight: 59 lbs.
 Corner Radius: 15mm
 Installation: Undermount
 Apron Front

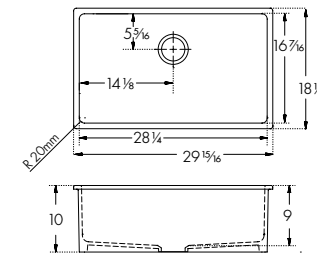

ACCESSORIES

- 2 **Bottom Grid** FK2-30-36S
- 7 **Strainer Basket** 906 906SN

Note: Dimensions may vary by 2% (plus or minus), due to material attributes and firing process. See website for Fireclay Repair Kits. Pop-Up strainer not compatible. **Special installation required - see website.**

NEW Available Spring 2019

FH3K710-30WH  White **\$1,250**
FH3K710-30MG  Matte Gray **\$1,550**
FH3K710-30MB  Matte Black **\$1,550**



SPECIFICATIONS

Interior Dimensions: 28 3/16" x 18 5/16" x 9 3/16"
 Exterior Dimensions: 29 15/16" x 20 1/16" x 10 3/16"
 Minimum Cabinet Size: 30"
 Weight: 101 lbs.
 Corner Radius: 15mm
 Installation: Undermount
 Reversible Apron Front

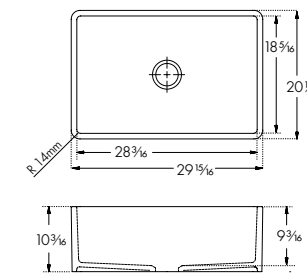
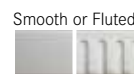



ACCESSORIES

- 3 **Bottom Grid** FK3-30-36S
- 7 **Strainer Basket** 906 906SN

Note: Dimensions may vary by 2% (plus or minus), due to material attributes and firing process. See website for Fireclay Repair Kits. Pop-Up strainer not compatible. **Special installation required - see website.**

NEW Available Spring 2019

FH3K710-33WH  White **\$1,525**
FH3K710-33MG  Matte Gray **\$1,775**
FH3K710-33MB  Matte Black **\$1,775**



SPECIFICATIONS

Interior Dimensions: 30 15/16" x 18 5/16" x 9 3/16"
 Exterior Dimensions: 32 1/16" x 20 1/16" x 10 3/16"
 Minimum Cabinet Size: 33"
 Weight: 108 lbs.
 Corner Radius: 15mm
 Installation: Undermount
 Reversible Apron Front

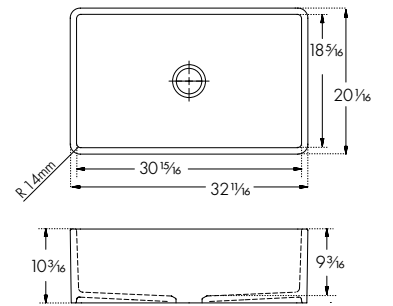
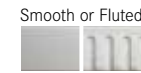

ACCESSORIES

- 4 **Bottom Grid** FK3-33-36S
- 7 **Strainer Basket** 906 906SN

Note: Dimensions may vary by 2% (plus or minus), due to material attributes and firing process. See website for Fireclay Repair Kits. Pop-Up strainer not compatible. **Special installation required - see website.** Finished on all sides.

FHK710-30WH  White **\$1,550**



SPECIFICATIONS

Interior Dimensions: 28 1/8" x 18 1/4" x 9 3/16"
 Exterior Dimensions: 30 1/8" x 20" x 10 1/8"
 Minimum Cabinet Size: 33"
 Weight: 103 lbs.
 Corner Radius: 19mm
 Installation: Undermount
 Apron Front

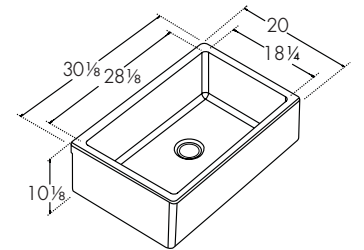

ACCESSORIES

- 5 **Bottom Grid** FK30-36S
- 6 **Cutting Board** OA-40S
- 7 **Strainer Basket** 906 906SN

Note: Dimensions may vary by 2% (plus or minus), due to material attributes and firing process. See website for Fireclay Repair Kits. Pop-Up strainer not compatible. **Special installation required - see website.** Finished on front and sides only.

ACCESSORIES

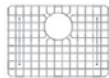
- 

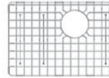
1 **Bottom Grid**
19 9/16" x 13 15/16"
Stainless
FK2-24-36S
\$175
- 

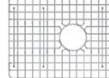
2 **Bottom Grid**
25 3/16" x 14 7/16"
Stainless
FK2-30-36S
\$215
- 

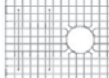
3 **Bottom Grid**
26 1/8" x 17"
Stainless
FK3-30-36S
\$225
- 

4 **Bottom Grid**
29 1/4" x 17"
Stainless
FK3-33-36S
\$245
- 

5 **Bottom Grid**
27 1/8" x 16 7/8"
Stainless
FK30-36S
\$243
- 

6 **Cutting Board**
14 1/2" x 21 7/8"
Solid Wood
OA-40S
\$350
- 

7 **Strainer Basket**
Chrome
906
\$62

Satin Nickel
906SN
\$85

FHK710-33WH White \$1,795



SPECIFICATIONS

Interior Dimensions: 31 7/16" x 18 1/4" x 9 3/16"
 Exterior Dimensions: 33" x 20" x 10 1/8"
 Minimum Cabinet Size: 33"
 Weight: 110 lbs.
 Corner Radius: 19mm
 Installation: Undermount
 Apron Front

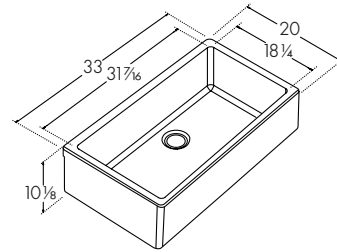

Note: Dimensions may vary by 2% (plus or minus), due to material attributes and firing process. See website for Fireclay Repair Kits. Pop-Up strainer not compatible. **Special installation required - see website.** Finished on front and sides only.

ACCESSORIES

- 1 **Bottom Grid**
FK33-36S
- 3 **Cutting Board**
OA-40S
- 4 **Strainer Basket**
906
906SN

FHK710-36WH White \$2,075



SPECIFICATIONS

Interior Dimensions: 34 7/16" x 18 1/4" x 9 3/16"
 Exterior Dimensions: 36" x 20" x 10 1/8"
 Minimum Cabinet Size: 36"
 Weight: 117 lbs.
 Corner Radius: 19mm
 Installation: Undermount
 Apron Front

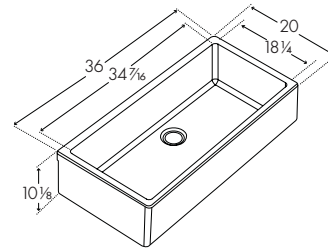

Note: Dimensions may vary by 2% (plus or minus), due to material attributes and firing process. See website for Fireclay Repair Kits. Pop-Up strainer not compatible. **Special installation required - see website.** Finished on front and sides only.

ACCESSORIES

- 2 **Bottom Grid**
FK36-36S
- 3 **Cutting Board**
OA-40S
- 4 **Strainer Basket**
906
906SN

ACCESSORIES

- 1 **Bottom Grid**
29 13/16" x 16 7/8"
Stainless
FK33-36S
\$274
- 2 **Bottom Grid**
32 1/16" x 16 7/8"
Stainless
FK36-36S
\$285
- 3 **Cutting Board**
14 1/2" x 21 7/8"
Solid Wood
OA-40S
\$350
- 4 **Strainer Basket**
Chrome
906
\$62

Satin Nickel
906SN
\$85

Note: All accessories sold separately unless otherwise indicated. Design of custom accessories subject to change without notice. It is absolutely critical that you have the sink and any custom sink accessories on site prior to any cut or modification to the countertop. Franke will not be responsible for any errors in countertop preparation and sink installation.

PERFECT TOGETHER

FARM HOUSE FAUCETS & DISPENSER

For the complete FARM HOUSE Faucet Collection see pages 202-207
 For dispenser details see page 285



FF6000A



FFPD400



PF7000A



DW6100C



DW12000



SD6000



WONDERFUL EXTRAS

FIRECLAY

FIRECLAY SINKS HAVE A DIRT-REPELLING PROTECTIVE FINISH WHICH ALLOWS STAINS TO BE WIPED AWAY WITH SOAP AND WATER.

Note: All accessories sold separately unless otherwise indicated. Design of custom accessories subject to change without notice. It is absolutely critical that you have the sink and any custom sink accessories on site prior to any cut or modification to the countertop. Franke will not be responsible for any errors in countertop preparation and sink installation.



Orca
Fireclay



Orca
Fireclay

ORCA

With Franke's Orca fireclay sink, you'll enjoy the versatility of a **contemporary design** with a softer **classical look**. Orca is rimmed with the unique **accessory shelf** to create additional work space without forgoing a **deep basin**. This sophisticated spacious sink is designed to meet your largest culinary challenges head-on.



Note: Color may vary between series.

ORK110WH

White

\$1,650



SPECIFICATIONS

Interior Dimensions: 27½" x 17½" x 9"
 Exterior Dimensions: 29⅞" x 19½" x 9⅞"
 Minimum Cabinet Size: 33"
 Weight: 57 lbs.
 Integral Franke Ledge System
 Corner Radius: 70mm
 Installation: Undermount

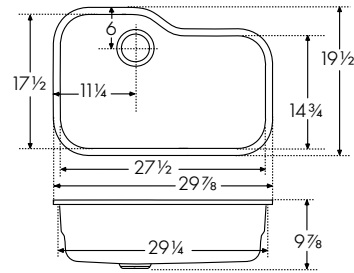

ACCESSORIES

1 Bottom Grid OK-36C	2 Shelf Grid OK-31C-LH	3 Shelf Grid OK-31C-RH	4 Cutting Board OA-40S	5 Universal Roller Mat UV-36RM	6 Strainer Basket 906 906SN
--------------------------------	----------------------------------	----------------------------------	----------------------------------	--	--

Note: Dimensions may vary by 2% (plus or minus), due to material attributes and firing process. See website for Fireclay Repair Kits. Pop-Up strainer not compatible. **Special installation required - see website.**

ACCESSORIES

 1 Bottom Grid 24⅜" x 13⅞" Coated Stainless OK-36C \$223	 2 Shelf Grid 13⅞" x 16⅞" Coated Stainless OK-31C-LH \$160	 3 Shelf Grid 13⅞" x 13⅞" Coated Stainless OK-31C-RH \$160	 4 Cutting Board 14½" x 21⅞" Solid Wood OA-40S \$350	 5 Universal Roller Mat 18⅞" x 20" Stainless UV-36RM \$160	 6 Strainer Basket Chrome 906 \$62 Satin Nickel 906SN \$85
--	--	--	--	---	---

Note: All accessories sold separately unless otherwise indicated. Design of custom accessories subject to change without notice. It is absolutely critical that you have the sink and any custom sink accessories on site prior to any cut or modification to the countertop. Franke will not be responsible for any errors in countertop preparation and sink installation.

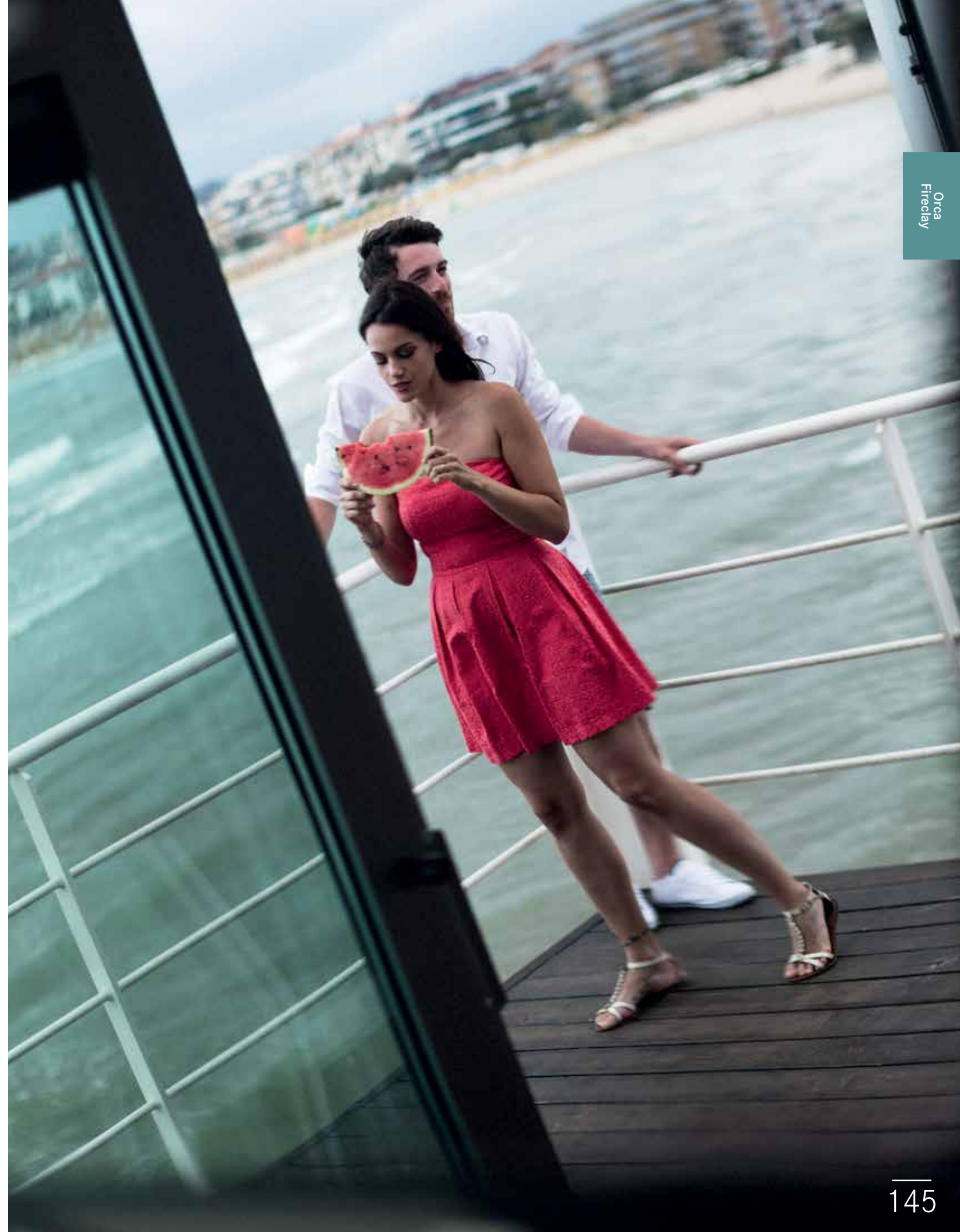



PRESTIGE

Renowned ceramics manufacturer Villeroy & Boch created the Prestige **single bowl** sink in a **classic design** to suit any kitchen. The **CeramicPlus® finish** ensures this sink's beauty will endure for years to come.



Pictured: PRK11021WH sink with FF7000A faucet

Note: Color may vary between series.

PRK11021WH

White \$1,015



SPECIFICATIONS

Interior Dimensions: 21 1/8" x 18 1/2" x 8 3/4"
 Exterior Dimensions: 23 3/8" x 20 1/2" x 9 5/8"
 Minimum Cabinet Size: 27"
 Weight: 42 lbs.
 Integral Franke Ledge System
 Corner Radius: 83mm
 Installation: Undermount

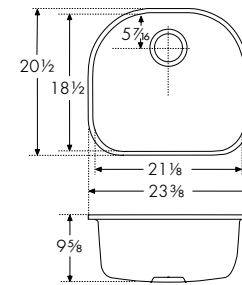

ACCESSORIES

- | | | | | |
|----------------------------------|---------------------------------|----------------------------------|--|--|
| 1 Bottom Grid
PK21-36S | 2 Shelf Grid
PK21-31S | 3 Cutting Board
OA-40S | 4 Universal Roller Mat
UV-36RM | 5 Strainer Basket
906
906SN |
|----------------------------------|---------------------------------|----------------------------------|--|--|

Note: Dimensions may vary by 2% (plus or minus), due to material attributes and firing process. See website for Fireclay Repair Kits. Pop-Up strainer not compatible. **Special installation required - see website.** Finished on front and sides only.

ACCESSORIES

- | | | | | |
|--|---|---|---|--|
| 1 Bottom Grid
17 1/2" x 15 13/16"
Stainless
PK21-36S
\$150 | 2 Shelf Grid
22" x 15 1/2"
Stainless
PK21-31S
\$150 | 3 Cutting Board
14 1/2" x 21 7/8"
Solid Wood
OA-40S
\$350 | 4 Universal Roller Mat
18 7/16" x 20"
Stainless
UV-36RM
\$160 | 5 Strainer Basket
Chrome
906
\$62

Satin Nickel
906SN
\$85 |
|--|---|---|---|--|



CISTERNA

Designed by **Villeroy & Boch** with a **classic design** and **three sizes**, the Cisterna fireclay sink is a perfect fit for the kitchen and beyond. Use the smallest size as a bar or prep sink – or pair it with a larger size to create a unique two-bowl design.



Note: Color may vary between series.



Pictured: CCK110-19WH sink with FFP3180 faucet and DW10080 filtration faucet

CCK110-13WH White \$825



SPECIFICATIONS

Interior Dimensions: 12⁵/₈" x 15³/₈" x 6⁷/₈"
 Exterior Dimensions: 14³/₈" x 17¹/₈" x 7⁵/₈"
 Minimum Cabinet Size: 18"
 Weight: 29 lbs.
 Corner Radius: 68mm
 Installation: Undermount

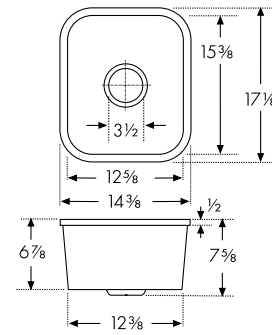

Note: Dimensions may vary by 2% (plus or minus), due to material attributes and firing process. See website for Fireclay Repair Kits. Pop-Up strainer not compatible. **Special installation required - see website.**

ACCESSORIES

- | | | | |
|----------------------------------|----------------------------------|--|--|
| 1 Bottom Grid
CK13-36C | 4 Cutting Board
OA-40S | 5 Universal Roller Mat
UV-36RM | 6 Strainer Basket
906
906SN |
|----------------------------------|----------------------------------|--|--|

CCK110-15WH White \$845



SPECIFICATIONS

Interior Dimensions: 15³/₈" x 15³/₈" x 6⁷/₈"
 Exterior Dimensions: 17¹/₂" x 17¹/₂" x 7⁵/₈"
 Minimum Cabinet Size: 21"
 Weight: 33 lbs.
 Corner Radius: 68mm
 Installation: Undermount

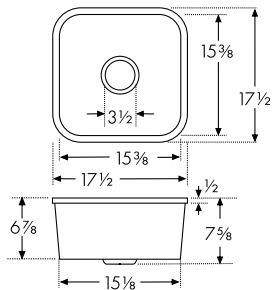

Note: Dimensions may vary by 2% (plus or minus), due to material attributes and firing process. See website for Fireclay Repair Kits. Pop-Up strainer not compatible. **Special installation required - see website.**

ACCESSORIES

- | | | | |
|----------------------------------|----------------------------------|--|--|
| 2 Bottom Grid
CK15-36C | 4 Cutting Board
OA-40S | 5 Universal Roller Mat
UV-36RM | 6 Strainer Basket
906
906SN |
|----------------------------------|----------------------------------|--|--|

CCK110-19WH White \$910



SPECIFICATIONS

Interior Dimensions: 19⁵/₈" x 15³/₈" x 6⁷/₈"
 Exterior Dimensions: 21⁵/₈" x 17³/₈" x 7⁵/₈"
 Minimum Cabinet Size: 27"
 Weight: 39 lbs.
 Corner Radius: 68mm
 Installation: Undermount

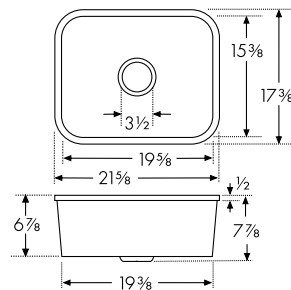

Note: Dimensions may vary by 2% (plus or minus), due to material attributes and firing process. See website for Fireclay Repair Kits. Pop-Up strainer not compatible. **Special installation required - see website.**

ACCESSORIES

- | | | | |
|----------------------------------|----------------------------------|--|--|
| 3 Bottom Grid
CK19-36C | 4 Cutting Board
OA-40S | 5 Universal Roller Mat
UV-36RM | 6 Strainer Basket
906
906SN |
|----------------------------------|----------------------------------|--|--|

ACCESSORIES



1 **Bottom Grid**
13³/₄" x 10¹⁵/₁₆"
Coated Stainless
CK13-36C
\$202



2 **Bottom Grid**
13³/₄" x 13³/₄"
Coated Stainless
CK15-36C
\$212



3 **Bottom Grid**
18" x 13¹/₁₆"
Coated Stainless
CK19-36C
\$223



4 **Cutting Board**
14¹/₂" x 21⁷/₈"
Solid Wood
OA-40S
\$350

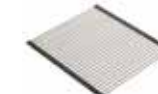

5 **Universal Roller Mat**
18⁷/₁₆" x 20"
Stainless
UV-36RM
\$160



6 **Strainer Basket**
Chrome
906
\$62

Satin Nickel
906SN
\$85



WONDERFUL EXTRAS
ROLLER MAT

OUR MULTIFUNCTIONAL ROLLER MAT IS A WONDERFUL KITCHEN ACCESSORY WITH A HOST OF APPLICATIONS, FROM A DISH DRAINER TO A TRIVET.



Pictured: FH2K710-33WH sink with FF7000A faucet



KINETIC

Our Kinetic fireclay sink collection features a **reversible apron front design**. You get to pick which side to showcase before installation, the **smooth apron front** for a clean, classic look or the **fluted apron front** to add texture and visual interest. With **multiple sizes and colors** to choose from, the perfect sink awaits.



Note: Color may vary between series.

FH2K710-30WH
FH2K710-30GB
FH2K710-30BC

- White
- Glossy Black
- Biscuit

\$1,295
\$1,395
\$1,395



SPECIFICATIONS

Interior Dimensions: 27 $\frac{1}{8}$ " x 15 $\frac{3}{8}$ " x 9"
Exterior Dimensions: 30" x 18 $\frac{1}{8}$ " x 10"
Minimum Cabinet Size: 30"
Weight: 90 lbs.
Corner Radius: 15mm
Installation: Undermount
Reversible Apron Front

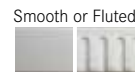
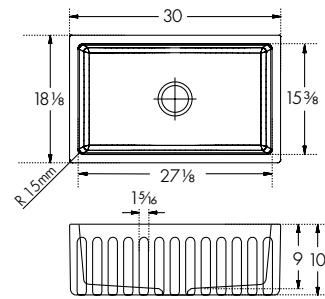

Note: Dimensions may vary by 2% (plus or minus), due to material attributes and firing process. See website for Fireclay Repair Kits. Pop-Up strainer not compatible. **Special installation required - see website.** Finished on all sides.

ACCESSORIES

- | | | | |
|------------------------------------|----------------------------------|--|--|
| 1 Bottom Grid
FK2-30-36S | 4 Cutting Board
OA-40S | 5 Universal Roller Mat
UV-36RM | 6 Strainer Basket
906
906SN |
|------------------------------------|----------------------------------|--|--|

FH2K710-33WH
FH2K710-33GB
FH2K710-33BC

- White
- Glossy Black
- Biscuit

\$1,495
\$1,595
\$1,595



SPECIFICATIONS

Interior Dimensions: 30 $\frac{3}{8}$ " x 15 $\frac{3}{8}$ " x 9"
Exterior Dimensions: 33" x 18 $\frac{1}{8}$ " x 10"
Minimum Cabinet Size: 33"
Weight: 94 lbs.
Corner Radius: 15mm
Installation: Undermount
Reversible Apron Front

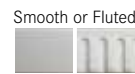
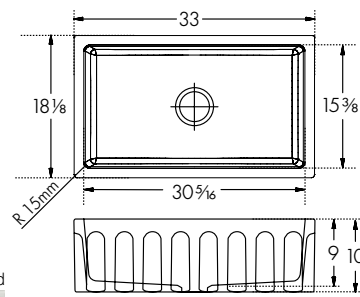

Note: Dimensions may vary by 2% (plus or minus), due to material attributes and firing process. See website for Fireclay Repair Kits. Pop-Up strainer not compatible. **Special installation required - see website.** Finished on all sides.

ACCESSORIES

- | | | | |
|------------------------------------|----------------------------------|--|--|
| 2 Bottom Grid
FK2-33-36S | 4 Cutting Board
OA-40S | 5 Universal Roller Mat
UV-36RM | 6 Strainer Basket
906
906SN |
|------------------------------------|----------------------------------|--|--|

FH2K710-36WH
FH2K710-36GB
FH2K710-36BC

- White
- Glossy Black
- Biscuit

\$1,695
\$1,795
\$1,795



SPECIFICATIONS

Interior Dimensions: 33 $\frac{1}{8}$ " x 15 $\frac{3}{8}$ " x 9"
Exterior Dimensions: 36" x 18 $\frac{1}{8}$ " x 10"
Minimum Cabinet Size: 36"
Weight: 104 lbs.
Corner Radius: 15mm
Installation: Undermount
Reversible Apron Front

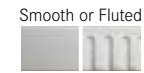
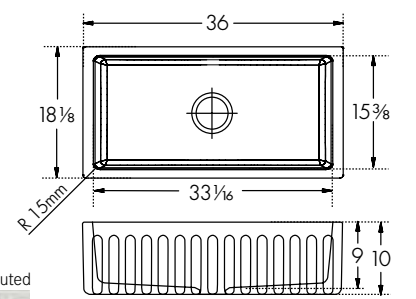

Note: Dimensions may vary by 2% (plus or minus), due to material attributes and firing process. See website for Fireclay Repair Kits. Pop-Up strainer not compatible. **Special installation required - see website.** Finished on all sides.

ACCESSORIES

- | | | | |
|------------------------------------|----------------------------------|--|--|
| 3 Bottom Grid
FK2-36-36S | 4 Cutting Board
OA-40S | 5 Universal Roller Mat
UV-36RM | 6 Strainer Basket
906
906SN |
|------------------------------------|----------------------------------|--|--|

ACCESSORIES

- | | | | | | |
|--|--|--|---|---|--|
| 1 Bottom Grid
25 $\frac{1}{4}$ " x 13 $\frac{3}{8}$ "
Stainless
FK2-30-36S
\$215 | 2 Bottom Grid
28 $\frac{1}{4}$ " x 13 $\frac{3}{8}$ "
Stainless
FK2-33-36S
\$245 | 3 Bottom Grid
31 $\frac{1}{4}$ " x 13 $\frac{3}{8}$ "
Stainless
FK2-36-36S
\$255 | 4 Cutting Board
14 $\frac{1}{2}$ " x 21 $\frac{7}{8}$ "
Solid Wood
OA-40S
\$350 | 5 Universal Roller Mat
18 $\frac{7}{8}$ " x 20"
Stainless
UV-36RM
\$160 | 6 Strainer Basket
Chrome
906
\$62
Satin Nickel
906SN
\$85 |
|--|--|--|---|---|--|



GRANITE SINKS

LUXURY COLLECTION

Peak	162-167
Orca	168-171
Kubus	172-175
Ellipse	176-181

HOME COLLECTION

Primo	182-185
Gravity	186-189
Quantum	190-193



COLOR YOUR KITCHEN WITH GRANITE

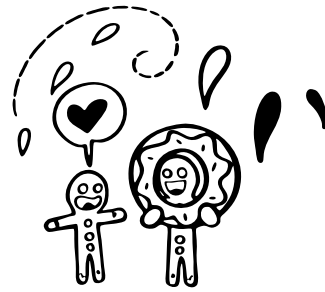

Sinks made of granite are particularly elegant and bring a natural look into your kitchen. Our processed granite has a subtle shine and feels warm to the touch. The surface is finely textured but not porous, ensuring a high standard of hygiene. Composed of 80% quartz sand and 20% hard acrylic resin, Franke's hard-wearing granite gives you a lifetime of beauty.

WONDERFUL FOR ACTIVE FAMILIES

Kitchens need to be free from bacterial odors, and kitchen sinks need to be free from biofilm, a slimy buildup of bacteria that adheres to surfaces. Thanks to the Sanitized® hygiene function, Franke is recognized as a pioneer in the development of granite compounds for sinks. Sanitized® reduces the growth of microbes on the granite material. At the same time, the granite remains resistant to stains and can withstand high temperatures up to 536°F.

OUR SANITIZED® MATERIAL

The Sanitized® hygiene function in Franke's granite sinks helps to keep sink areas clean and reduces the growth of biofilm and bacterial odors on the material, providing excellent protection every day. That means less work, giving you more time to enjoy the things you love and the peace of mind in knowing your kitchen is clean.



WONDERFUL IN MANY COLORS

Fill your kitchen with beautiful color and elegant granite. There's a Franke granite sink that's perfect for you. See our Active Plus faucets on page 247 for an ideal color match to your granite sink.



Peak
Granite

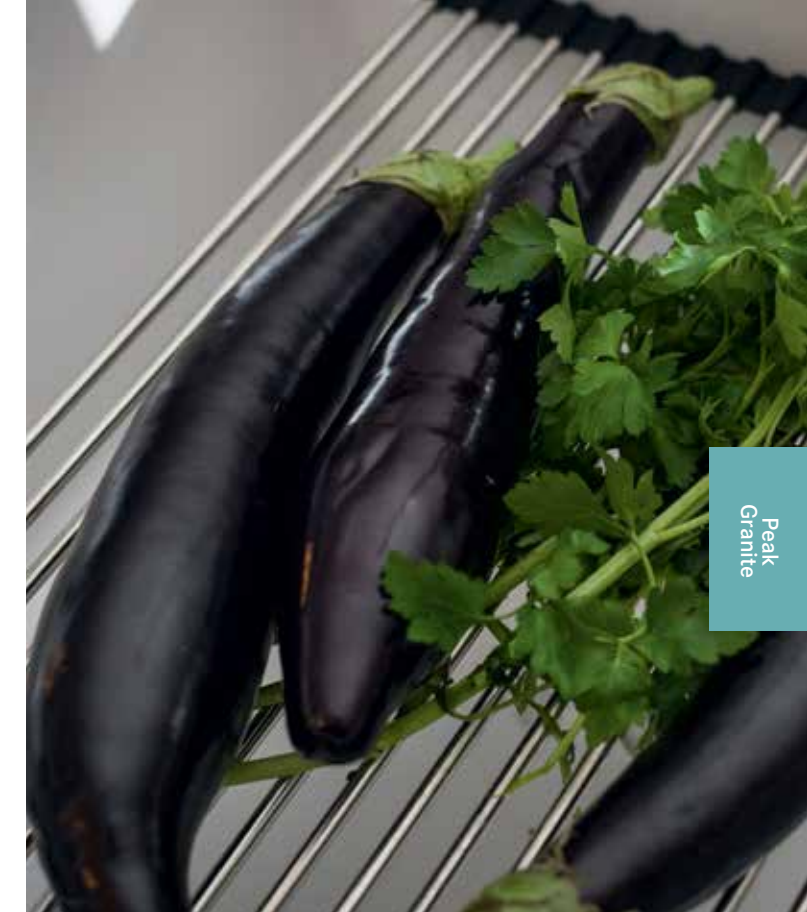

Peak
Granite

PEAK

Available in **single bowl** and **double bowl** styles in **seven finish colors**, Peak granite sinks let you create the kitchen that fits your style. A wide range of accessories allows you to create the ultimate workspace for the way you use your sink.



Pictured: PKG 11031VAN sink with FF3880 faucet

NEW Available Spring 2019

- PKG11014ONY ■ Onyx \$495
- PKG11014MOC ■ Mocha \$495
- PKG11014STO ■ Storm \$495
- PKG11014OYS ■ Oyster \$495
- PKG11014CHA ■ Champagne \$495
- PKG11014VAN ■ Vanilla \$495
- PKG11014SHG ■ Shadow Grey \$495

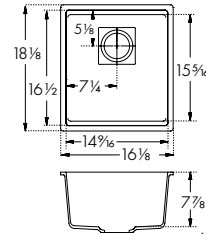

SPECIFICATIONS

Interior Dimensions: 14⁹/₁₆" x 16¹/₂" x 7⁷/₈"
 Exterior Dimensions: 16¹/₈" x 18¹/₈"
 Minimum Cabinet Size: 21"
 Weight: 20 lbs.
 Integral Franke Ledge System
 Corner Radius: 10mm
 Installation: Undermount

ACCESSORIES

- 2** Bottom Roller Mat PKG14-36RM
- 6** Shelf Roller Mat PKG14-31RM
- 7** Cutting Board PG2-40S
- 9** Strainer Basket 906 906SN
- 10** Drain Cover PKGCVR Included

NEW Available Spring 2019

- PKG11020ONY ■ Onyx \$595
- PKG11020MOC ■ Mocha \$595
- PKG11020STO ■ Storm \$595
- PKG11020OYS ■ Oyster \$595
- PKG11020CHA ■ Champagne \$595
- PKG11020VAN ■ Vanilla \$595
- PKG11020SHG ■ Shadow Grey \$595

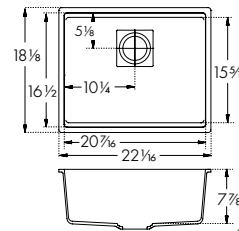

SPECIFICATIONS

Interior Dimensions: 20⁷/₁₆" x 16¹/₂" x 7⁷/₈"
 Exterior Dimensions: 22¹/₁₆" x 18¹/₈"
 Minimum Cabinet Size: 27"
 Weight: 24 lbs.
 Integral Franke Ledge System
 Corner Radius: 10mm
 Installation: Undermount

ACCESSORIES

- 3** Bottom Roller Mat PKG20-36RM
- 6** Shelf Roller Mat PKG14-31RM
- 7** Cutting Board PG2-40S
- 9** Strainer Basket 906 906SN
- 10** Drain Cover PKGCVR Included

- PKG11031ONY ■ Onyx \$695
- PKG11031MOC ■ Mocha \$695
- PKG11031STO ■ Storm \$695
- PKG11031OYS ■ Oyster \$695
- PKG11031CHA ■ Champagne \$695
- PKG11031VAN ■ Vanilla \$695
- PKG11031SHG ■ Shadow Grey \$695

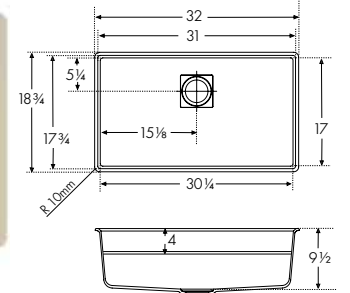

SPECIFICATIONS

Interior Dimensions: 31" x 17³/₄" x 9¹/₂"
 Exterior Dimensions: 32" x 18³/₄"
 Minimum Cabinet Size: 36"
 Weight: 38 lbs.
 Integral Franke Ledge System
 Corner Radius: 10mm
 Installation: Undermount

ACCESSORIES

- 1** Bottom Grid PKG31-36S
- 4** Bottom Roller Mat PKG31-36RM
- 5** Shelf Roller Mat PKG18-31RM
- 8** Cutting Board PG-40S
- 9** Strainer Basket 906 906SN
- 10** Drain Cover PKGCVR Included

ACCESSORIES

- 1** Bottom Grid 28¹/₂" x 14¹/₂" Stainless PKG31-36S \$212
- 2** Bottom Roller Mat 11¹/₁₆" x 13¹/₂" Stainless PKG14-36RM \$155
- 3** Bottom Roller Mat 17³/₄" x 13¹/₂" Stainless PKG20-36RM \$175
- 4** Bottom Roller Mat 25³/₄" x 13³/₄" Stainless PKG31-36RM \$202
- 5** Shelf Roller Mat 18⁷/₁₆" x 16³/₁₆" Stainless PKG18-31RM \$149
- 6** Shelf Roller Mat 11³/₄" x 16¹/₈" Stainless PKG14-31RM \$125
- 7** Cutting Board 11" x 17⁷/₁₆" Solid Wood PG2-40S \$205
- 8** Cutting Board 14³/₈" x 18³/₈" Solid Wood PG-40S \$212
- 9** Strainer Basket 906 \$62
Satin Nickel 906SN \$85
- 10** Drain Cover 4⁷/₈" x 4⁷/₈" Stainless PKGCVR \$82
One included

- PKG1600NY
- PKG160MOC
- PKG160STO
- PKG160OYS
- PKG160CHA
- PKG160VAN
- PKG160SHG

- Onyx \$755
- Mocha \$755
- Storm \$755
- Oyster \$755
- Champagne \$755
- Vanilla \$755
- Shadow Grey \$755

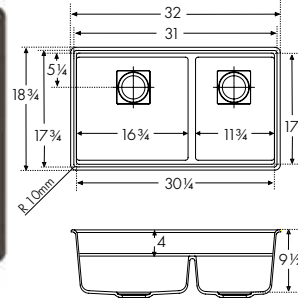





SPECIFICATIONS

Interior Dimensions: 31" x 17 3/4" x 9 1/2"
 Exterior Dimensions: 32" x 18 3/4"
 Minimum Cabinet Size: 36"
 Weight: 40 lbs.
 Integral Franke Ledge System
 Corner Radius: 10mm
 Installation: Undermount

ACCESSORIES

1 Bottom Grid PKG17-36S	2 Bottom Grid PKG12-36S	3 Bottom Roller Mat PKG17-36RM	4 Bottom Roller Mat PKG12-36RM	5 Shelf Roller Mat PKG18-31RM	6 Cutting Board PG-40S	7 Strainer Basket 906 906SN	8 Drain Cover PKGCVR Included
----------------------------	----------------------------	-----------------------------------	-----------------------------------	----------------------------------	---------------------------	-----------------------------------	-------------------------------------

ACCESSORIES

-  1 Bottom Grid 15 1/2" x 14 1/2" Stainless PKG17-36S \$159
-  2 Bottom Grid 10 1/2" x 14 1/2" Stainless PKG12-36S \$138
-  3 Bottom Roller Mat 15" x 13 3/4" Stainless PKG17-36RM \$159
-  4 Bottom Roller Mat 9 3/4" x 13 3/4" Stainless PKG12-36RM \$127
-  5 Shelf Roller Mat 18 7/8" x 16 3/8" Stainless PKG18-31RM \$149
-  6 Cutting Board 14 3/8" x 18 3/8" Solid Wood PG-40S \$212
-  7 Strainer Basket Chrome 906 \$62
Satin Nickel 906SN \$85
-  8 Drain Cover 4 7/8" x 4 7/8" Stainless PKGCVR \$82
One included

Note: All accessories sold separately unless otherwise indicated. Design of custom accessories subject to change without notice. It is absolutely critical that you have the sink and any custom sink accessories on site prior to any cut or modification to the countertop. Franke will not be responsible for any errors in countertop preparation and sink installation.



Peak Granite

ORCA

The simple design of the Orca **single bowl** granite sink is a match for a wide range of countertops and kitchen styles and pairs beautifully with many Franke faucets. Personalize it to fit your work style by adding a **bottom grid, shelf grid** or other accessory.

Orca
Granite



Orca
Granite

Pictured: ORG110VAN sink with FF3550 faucet and DW14050 filtration faucet

- ORG1100NY Onyx \$755
- ORG110MOC Mocha \$755
- ORG110STO Storm \$755
- ORG110OYS Oyster \$755
- ORG110CHA Champagne \$755
- ORG110VAN Vanilla \$755
- ORG110SHG Shadow Grey \$755

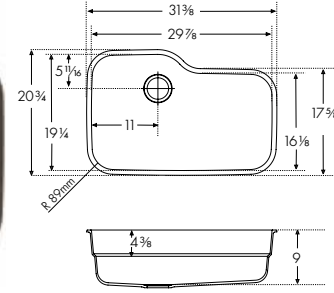

SPECIFICATIONS

Interior Dimensions: 29 7/8" x 19 1/4" x 9"
 Exterior Dimensions: 31 3/8" x 20 3/4"
 Minimum Cabinet Size: 36"
 Weight: 35 lbs.
 Integral Franke Ledge System
 Corner Radius: 89mm
 Installation: Undermount

ACCESSORIES

- | | | | | | |
|--|--|--|---|--|---|
| <p>1 Bottom Grid
OC-36S</p> | <p>2 Shelf Grid
OC-31S-LH</p> | <p>3 Shelf Grid
OC-31S-RH</p> | <p>4 Cutting Board
OC-45SP</p> | <p>5 Universal Roller Mat
UV-36RM</p> | <p>6 Strainer Basket
906
906SN</p> |
|--|--|--|---|--|---|

ACCESSORIES



1 Bottom Grid
26 3/8" x 15 1/8"
Stainless
OC-36S
\$223



2 Shelf Grid
14 1/8" x 17 1/8"
Stainless
OC-31S-LH
\$160



3 Shelf Grid
13 1/8" x 15 1/8"
Stainless
OC-31S-RH
\$160



4 Cutting Board
18 3/4" x 19 5/8"
Solid Wood with
Stainless Colander
OC-45SP
\$424

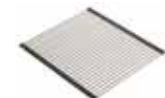

5 Universal Roller Mat
18 7/8" x 20"
Stainless
UV-36RM
\$160



6 Strainer Basket
Chrome
906
\$62

Satin Nickel
906SN
\$85

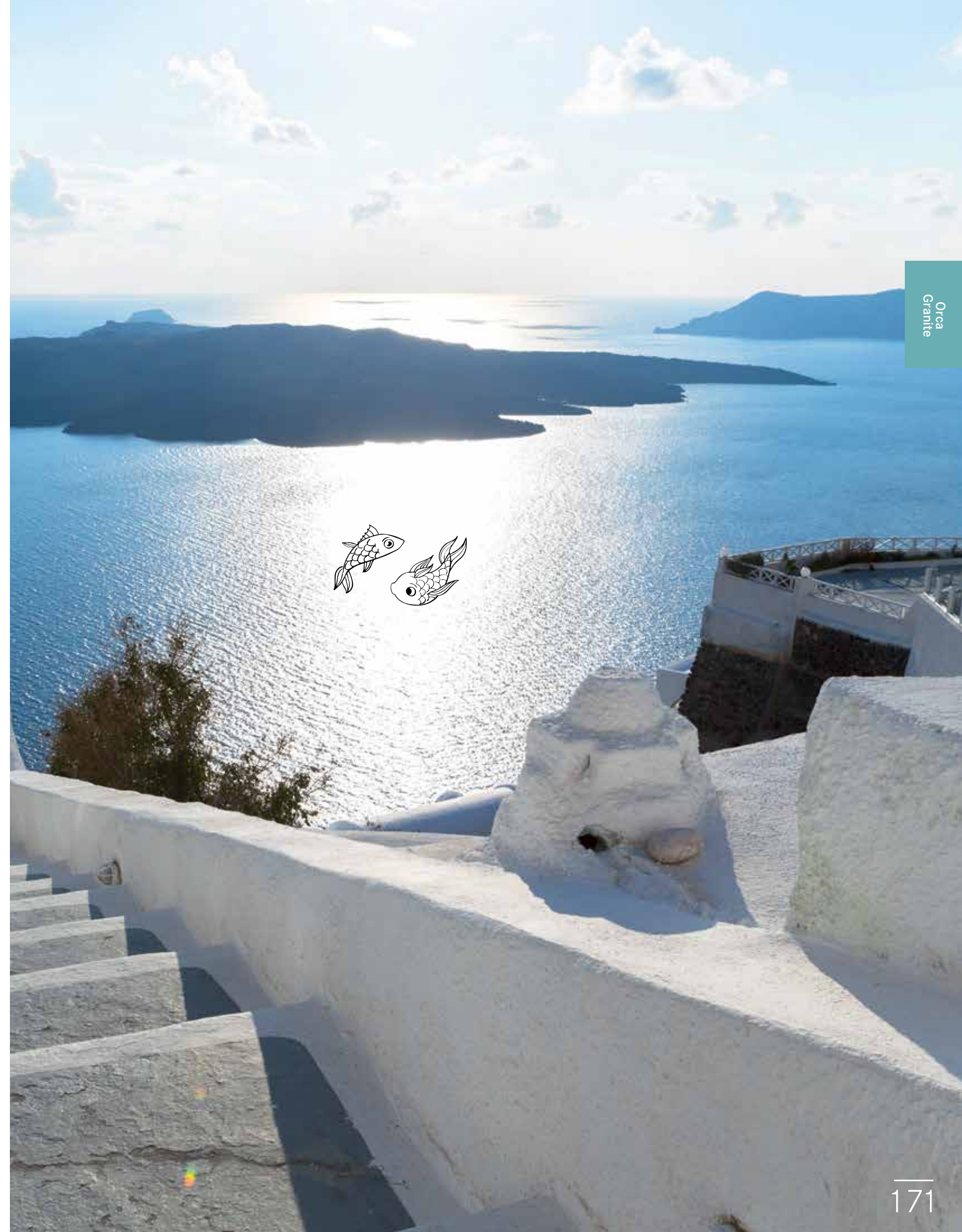



Kubus
Granite



Kubus
Granite

KUBUS

Kubus fits wherever you need it, whether it's your primary kitchen sink or in a prep area. Choose from **seven granite colors** to create the kitchen workspace you've always imagined.



- KBG11013ONY Onyx \$475
- KBG11013MOC Mocha \$475
- KBG11013STO Storm \$475
- KBG11013OYS Oyster \$475
- KBG11013CHA Champagne \$475
- KBG11013VAN Vanilla \$475
- KBG11013SHG Shadow Grey \$475

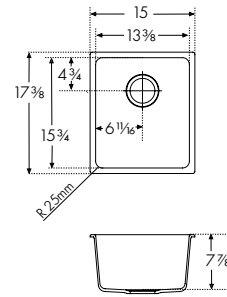

SPECIFICATIONS

Interior Dimensions: 13 3/8" x 15 3/4" x 7 7/8"
 Exterior Dimensions: 15" x 17 3/8"
 Minimum Cabinet Size: 21"
 Weight: 18 lbs.
 Corner Radius: 25mm
 Installation: Undermount

ACCESSORIES

- | | | |
|---|--|---|
| <p>1 Bottom Grid
KBG13-36S</p> | <p>3 Universal Roller Mat
UV-36RM</p> | <p>4 Strainer Basket
906
906SN</p> |
|---|--|---|

- KBG11031ONY Onyx \$575
- KBG11031MOC Mocha \$575
- KBG11031STO Storm \$575
- KBG11031OYS Oyster \$575
- KBG11031CHA Champagne \$575
- KBG11031VAN Vanilla \$575
- KBG11031SHG Shadow Grey \$575

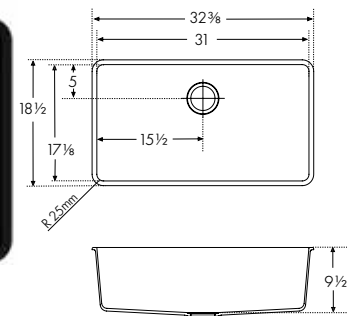

SPECIFICATIONS

Interior Dimensions: 31" x 17 1/8" x 9 1/2"
 Exterior Dimensions: 32 3/8" x 18 1/2"
 Minimum Cabinet Size: 36"
 Weight: 39 lbs.
 Corner Radius: 25mm
 Installation: Undermount

ACCESSORIES

- | | | |
|---|--|---|
| <p>2 Bottom Grid
KBG31-36S</p> | <p>3 Universal Roller Mat
UV-36RM</p> | <p>4 Strainer Basket
906
906SN</p> |
|---|--|---|

ACCESSORIES

- | | | | |
|--|--|---|--|
| <p>1 Bottom Grid
13 1/8" x 14 1/8"
Stainless
KBG13-36S
\$126</p> | <p>2 Bottom Grid
29 1/2" x 15 1/8"
Stainless
KBG31-36S
\$202</p> | <p>3 Universal Roller Mat
18 7/8" x 20"
Stainless
UV-36RM
\$160</p> | <p>4 Strainer Basket
Chrome
906
\$62

Satin Nickel
906SN
\$85</p> |
|--|--|---|--|

Note: All accessories sold separately unless otherwise indicated. Design of custom accessories subject to change without notice. It is absolutely critical that you have the sink and any custom sink accessories on site prior to any cut or modification to the countertop. Franke will not be responsible for any errors in countertop preparation and sink installation.



ELLIPSE

Available in **three configurations**, there's an Ellipse sink that's perfect for your space. Franke granite sinks are made from **80% quartz**, the hardest component of granite, and bonded using **high-quality acrylic resins**, for a sink that will serve you for years to come.



Pictured: ELG120MOC sink with FFT3350 filtration faucet and SD3450 soap dispenser

Ellipse
Granite

Ellipse
Granite

- ELG11022ONY Onyx \$495
- ELG11022MOC Mocha \$495
- ELG11022STO Storm \$495
- ELG11022OYS Oyster \$495
- ELG11022CHA Champagne \$495
- ELG11022VAN Vanilla \$495
- ELG11022SHG Shadow Grey \$495

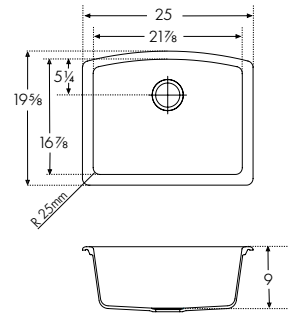

SPECIFICATIONS

Interior Dimensions: 21 7/8" x 16 7/8" x 9"
 Exterior Dimensions: 25" x 19 5/8"
 Minimum Cabinet Size: 27"
 Weight: 30 lbs.
 Corner Radius: 25mm
 Installation: Undermount

ACCESSORIES

- 4 Bottom Grid**
ELG22-36S
- 5 Universal Roller Mat**
UV-36RM
- 6 Strainer Basket**
906
906SN

- ELG1200NY Onyx \$575
- ELG1200MOC Mocha \$575
- ELG1200STO Storm \$575
- ELG1200OYS Oyster \$575
- ELG1200CHA Champagne \$575
- ELG1200VAN Vanilla \$575
- ELG1200SHG Shadow Grey \$575

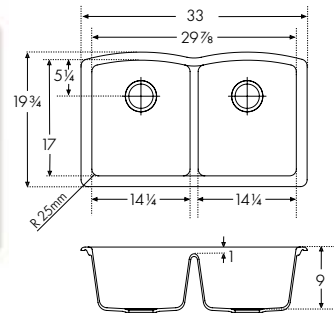

SPECIFICATIONS

Interior Dimensions: 29 7/8" x 17" x 9"
 Exterior Dimensions: 33" x 19 3/4"
 Minimum Cabinet Size: 36"
 Weight: 37 lbs.
 Corner Radius: 25mm
 Installation: Undermount

ACCESSORIES

- 2 Bottom Grid**
ELG14-36S
- 5 Universal Roller Mat**
UV-36RM
- 6 Strainer Basket**
906
906SN

- ELG1600NY Onyx \$575
- ELG1600MOC Mocha \$575
- ELG1600STO Storm \$575
- ELG1600OYS Oyster \$575
- ELG1600CHA Champagne \$575
- ELG1600VAN Vanilla \$575
- ELG1600SHG Shadow Grey \$575

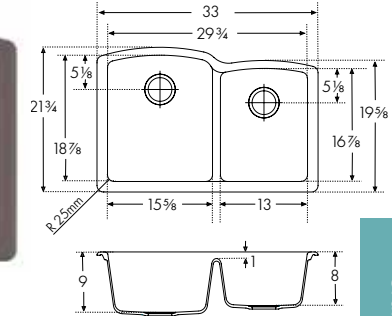

SPECIFICATIONS

Interior Dimensions: 29 3/4" x 18 7/8" x 9" & 8"
 Exterior Dimensions: 33" x 21 3/4"
 Minimum Cabinet Size: 36"
 Weight: 42 lbs.
 Corner Radius: 25mm
 Installation: Undermount

ACCESSORIES

- 3 Bottom Grid**
ELG16-36S
- 1 Bottom Grid**
ELG13-36S
- 5 Universal Roller Mat**
UV-36RM
- 6 Strainer Basket**
906
906SN

ACCESSORIES

- 1 Bottom Grid**
10 3/4" x 14 1/4"
Stainless
ELG13-36S
\$126
- 2 Bottom Grid**
11 3/4" x 14 1/4"
Stainless
ELG14-36S
\$137
- 3 Bottom Grid**
13 1/8" x 16 1/8"
Stainless
ELG16-36S
\$150
- 4 Bottom Grid**
19 1/4" x 14 1/4"
Stainless
ELG22-36S
\$150
- 5 Universal Roller Mat**
18 7/8" x 20"
Stainless
UV-36RM
\$160
- 6 Strainer Basket**
Chrome
906
\$62

Satin Nickel
906SN
\$85

- ESOX25229-1** Onyx **\$435**
(1 faucet hole; 3 predrilled)
- ESDB25229-1** Mocha **\$435**
(1 faucet hole; 3 predrilled)
- ESCH25229-1** Champagne **\$435**
(1 faucet hole; 3 predrilled)

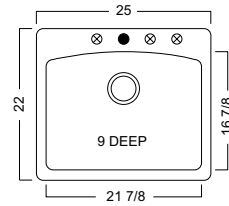

SPECIFICATIONS

Interior Dimensions: 21 7/8" x 16 7/8" x 9"
 Exterior Dimensions: 25" x 22"
 Minimum Cabinet Size: 27"
 Weight: 30 lbs.
 Corner Radius: 25mm
 Installation: Dual Mount

ACCESSORIES

- 4 Bottom Grid**
FBGG1914

- EDOX33229-1** Onyx **\$485**
(1 faucet hole; 3 predrilled)
- EDDB33229-1** Mocha **\$485**
(1 faucet hole; 3 predrilled)
- EDCH33229-1** Champagne **\$485**
(1 faucet hole; 3 predrilled)

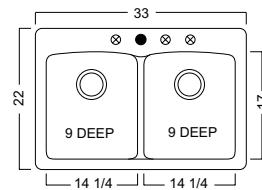

SPECIFICATIONS

Interior Dimensions: 29 7/8" x 17" x 9"
 Exterior Dimensions: 33" x 22"
 Minimum Cabinet Size: 36"
 Weight: 42 lbs.
 Corner Radius: 25mm
 Installation: Dual Mount

ACCESSORIES

- 1 Bottom Grid**
FBGG1114

- EOOX33229-1** Onyx **\$495**
(1 faucet hole; 3 predrilled)
- EODB33229-1** Mocha **\$495**
(1 faucet hole; 3 predrilled)
- EOCH33229-1** Champagne **\$495**
(1 faucet hole; 3 predrilled)

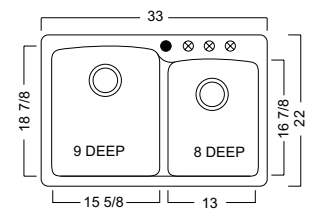





SPECIFICATIONS

Interior Dimensions: 29 3/4" x 18 7/8" x 9" & 8"
 Exterior Dimensions: 33" x 22"
 Minimum Cabinet Size: 36"
 Weight: 42 lbs.
 Corner Radius: 25mm
 Installation: Dual Mount

ACCESSORIES

- 3 Bottom Grid** FBGG1316
- 2 Bottom Grid** FBGG1014

ACCESSORIES

- 
1 Bottom Grid
11 1/2" x 14"
Stainless
FBGG1114
\$95
- 
2 Bottom Grid
10" x 14"
Stainless
FBGG1014
\$95
- 
3 Bottom Grid
12 3/4" x 16"
Stainless
FBGG1316
\$106
- 
4 Bottom Grid
18 3/4" x 13 3/4"
Stainless
FBGG1914
\$116



Primo
Granite



Primo
Granite

PRIMO

Sleek aesthetics, **plenty of prep space** and the **durability** every kitchen requires grace the Primo sink. The deep **9" bowls** allow for easy, splash-free washing of large dishes.



- DIG61091-GRA** ■ Graphite \$485
(1 faucet hole; 3 predrilled)
- DIG61091-MOC** ■ Mocha \$485
(1 faucet hole; 3 predrilled)
- DIG61091-CHA** ■ Champagne \$485
(1 faucet hole; 3 predrilled)
- DIG61091-WHT** ■ White \$485
(1 faucet hole; 3 predrilled)
- DIG61091-SHG** ■ Shadow Grey \$485
(1 faucet hole; 3 predrilled)

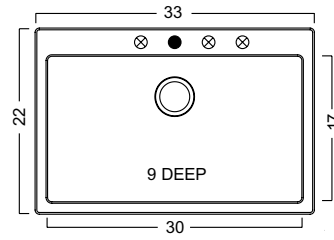

SPECIFICATIONS

Interior Dimensions: 30" x 17" x 9"
 Exterior Dimensions: 33" x 22"
 Minimum Cabinet Size: 36"
 Weight: 36 lbs.
 Corner Radius: 13mm
 Installation: Dual Mount

ACCESSORIES

- 1 | Bottom Grid**
BGD110

- DIG62D91-GRA** ■ Graphite \$545
(1 faucet hole; 3 predrilled)
- DIG62D91-MOC** ■ Mocha \$545
(1 faucet hole; 3 predrilled)
- DIG62D91-CHA** ■ Champagne \$545
(1 faucet hole; 3 predrilled)
- DIG62D91-WHT** ■ White \$545
(1 faucet hole; 3 predrilled)
- DIG62D91-SHG** ■ Shadow Grey \$545
(1 faucet hole; 3 predrilled)

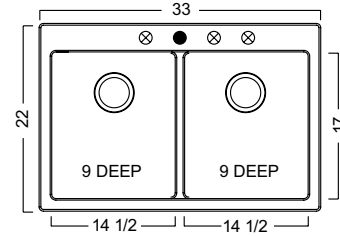

SPECIFICATIONS

Interior Dimensions: 30" x 17" x 9"
 Exterior Dimensions: 33" x 22"
 Minimum Cabinet Size: 36"
 Weight: 42 lbs.
 Corner Radius: 13mm
 Installation: Dual Mount

ACCESSORIES

- 2 | Bottom Grid**
BGD1100

ACCESSORIES

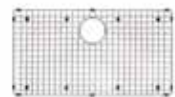

- 1 | Bottom Grid**
27 7/8" x 15"
Stainless
BGD1110
\$126



- 2 | Bottom Grid**
12 3/8" x 15"
Stainless
BGD1100
\$116



Primo Granite

GRAVITY

The beauty of granite offsets the subtly **curved design** of Gravity to create a sink that adds an attractive element to your kitchen. **Durable and hygienic**, it's perfect for the family kitchen.



Pictured: SP3322-1 sink with FF20750 faucet

SGR3322-1
(1 faucet hole; 3 predrilled)

■ Graphite \$485

SC3322-1
(1 faucet hole; 3 predrilled)

■ Champagne \$485

SP3322-1
(1 faucet hole; 3 predrilled)

■ White \$485

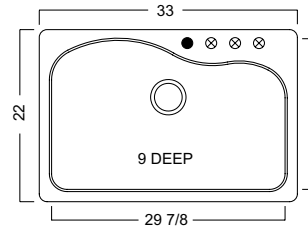

SPECIFICATIONS

Interior Dimensions: 29 7/8" x 19" x 9"
 Exterior Dimensions: 33" x 22"
 Minimum Cabinet Size: 36"
 Weight: 34 lbs.
 Corner Radius: 26mm
 Installation: Dual Mount

ACCESSORIES

- 1 **Bottom Grid**
FBBG2716

DIG62F91-GRA ■ Graphite \$525
(1 faucet hole; 3 predrilled)

DIG62F91-MOC ■ Mocha \$525
(1 faucet hole; 3 predrilled)

DIG62F91-CHA ■ Champagne \$525
(1 faucet hole; 3 predrilled)

DIG62F91-WHT ■ White \$525
(1 faucet hole; 3 predrilled)

DIG62F91-SHG ■ Shadow Grey \$525
(1 faucet hole; 3 predrilled)

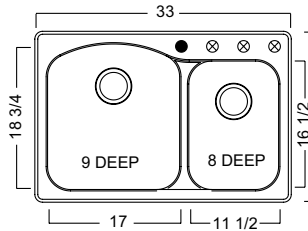

SPECIFICATIONS

Interior Dimensions: 29 3/4" x 18 3/4" x 16 1/2" x 9" & 8"
 Exterior Dimensions: 33" x 22"
 Minimum Cabinet Size: 36"
 Weight: 42 lbs.
 Corner Radius: 75mm
 Installation: Dual Mount

ACCESSORIES

- 2 **Bottom Grid**
BGDIS150
- 3 **Bottom Grid**
BGDIL150

ACCESSORIES

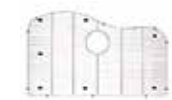

- 1 **Bottom Grid**
27" x 16 1/2"
Stainless
FBBG2716
\$137



- 2 **Bottom Grid**
14 1/2" x 9 1/2"
Stainless
BGDIS150
\$116



- 3 **Bottom Grid**
16 1/2" x 15 7/8"
Stainless
BGDIL150
\$116

Note: All accessories sold separately unless otherwise indicated. Design of custom accessories subject to change without notice. It is absolutely critical that you have the sink and any custom sink accessories on site prior to any cut or modification to the countertop. Franke will not be responsible for any errors in countertop preparation and sink installation.





Pictured: SZCH1720-1 sink with FF3180 faucet



QUANTUM

Beautiful and durable, Quantum is the perfect bar or prep sink. Thanks to its **UV protection**, granite does not fade, ensuring that your sink will look like new for many years. Granite also offers **superior resistance to scratches**, chips and heat too.



- SOX1720-1
(1 faucet hole; 2 predrilled)
■ Onyx
\$365
- SZGR1720-1
(1 faucet hole; 2 predrilled)
■ Graphite
\$365
- SZCH1720-1
(1 faucet hole; 2 predrilled)
■ Champagne
\$365
- SZPW1720-1
(1 faucet hole; 2 predrilled)
■ White
\$410

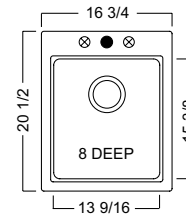

SPECIFICATIONS

Interior Dimensions: 13⁹/₁₆" x 15³/₈" x 8"
 Exterior Dimensions: 16³/₄" x 20¹/₂"
 Minimum Cabinet Size: 18"
 Weight: 22 lbs.
 Corner Radius: 25mm
 Installation: Dual Mount

ACCESSORIES

- 1 **Bottom Grid**
FBG180S

ACCESSORIES



- 1 **Bottom Grid**
11⁷/₈" x 13⁵/₈"
Stainless
FBG180S
\$85



Quantum Granite

Quantum Granite



YOUR KITCHEN. YOUR DESIGN.

Personalize your kitchen workspace and create a smooth flow from preparation to cleanup. Versatile, space-expanding accessories play multiple roles in the kitchen and fit within your Franke sink or directly on the kitchen counter.

Practical by design and aesthetically beautiful, accessories simplify every task and match the unique way you cook and entertain at home.

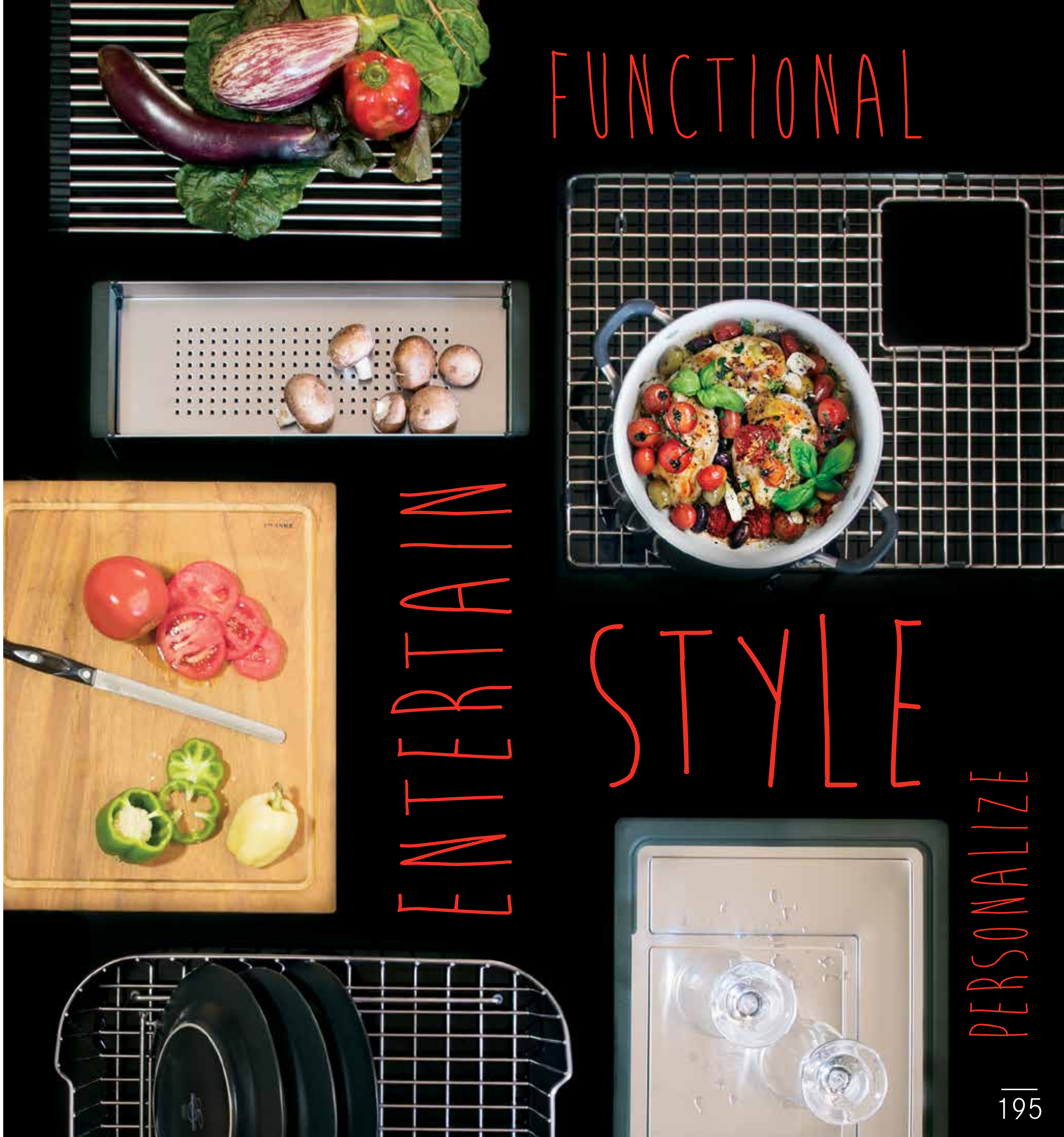

FUNCTIONAL

ENTERTAIN

STYLE

PERSONALIZE



FAUCETS

LUXURY COLLECTION

Farm House	202-207
Professional	208-209
Crystal	210
Masterchef	211
Purus	212-213
Chillout	214-215
Planar 8	216-217
Absinthe	218-223
Pescara	224-228
Peak	229
Ambient	230-235
Orca	236-239
Steel	240-242
Fluence	243
Manhattan	244-245
Active	246-247
Kubus	248-249
Cube	250-253

HOME COLLECTION

Fast-In Faucets	256
Home Collection Faucets	257-259



FAUCETS TO THE HIGHEST STANDARDS



Faucets

From extravagant to purist. From satin nickel to polished chrome. Whether you prefer a flexible, pull-out, or integrated water filter, the Franke faucet range meets every need in every kitchen. Your favorite Franke faucet will be the perfect match for your ideal Franke sink.

MANUFACTURING TO FINEST STANDARDS

Outstanding design and quality components come together during the Franke manufacturing process. Strict adherence to Franke manufacturing standards in forming, finishing and final assembly achieves the exceptional quality and durability that makes a Franke faucet the most desired addition to a kitchen.

QUALITY ASSURANCE AND CERTIFICATIONS

Franke faucets are manufactured under the supervision and testing of local and international certifying bodies, including CSA, IAPMO, ICC, and NSF. All Franke faucets meet the requirements of the Federal Safe Drinking Water Act, NSF372 and NSF61.



Faucets

WATER SAVING FEATURE

Turning the faucet handle one click will start a water conserving 50% flow. A second click of the handle brings the faucet to 100% water flow.

Franke faucets are in compliance with CalGreen, California's Green Building Standards, an initiative to reduce water usage by 20 percent in new construction projects.



Look for faucets with water saving feature as not all faucets have this feature.

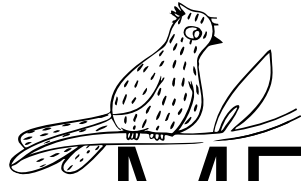

METALLIC FAUCET FINISHES

Faucets



Faucets

MAKE YOUR STATEMENT

Franke's new metallic faucet finishes complete the design statement in your well-appointed kitchen. Complement or contrast your sink with one of **seven new finishes**, from Matte Black for a sophisticated, modern appeal; to earthy Bronze or rich, bold Copper, to accent cabinetry and countertops.



Note: Numbers correspond to last two digits of product number. e.g., FF3940. Finishes available on select faucets.



Farmhouse
Faucets

Pictured: FF7000A faucet



Farmhouse
Faucets

FARM HOUSE

Farm House faucets bring country charm to sinks and kitchens of any design. Choose among **chrome and nickel finishes** to reflect your personal style. Most faucets come with a **side spray** for added convenience in cooking and cleanup.



FF6000A

- FF6000A** Polished Chrome **\$1,598**
- FF6070A** Polished Nickel **\$1,785**
- FF6080A** Satin Nickel **\$1,785**



FEATURES AND BENEFITS

3-Hole Bridge Faucet with Side Spray
 Flow Rate: 1.75 gpm
 Spray Function: Press & Hold
 Spray Type: Full & Needle
 Spout Swivel Range: 180°
 Cartridge: ½" Ceramic
 Check Valve: Integrated Double
 Countertop Hole Diameter: 1 ¾"
 Weight: 14 lbs.

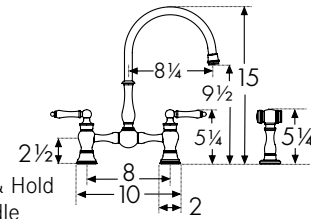

FFPD400

- FFPD400** Polished Chrome **\$795**
- FFPD470** Polished Nickel **\$925**
- FFPD480** Satin Nickel **\$925**



FEATURES AND BENEFITS

1-Hole Pull-Down
 Flow Rate: 1.75 gpm
 Spray Function: Toggle
 Spray Type: Full & Needle
 Spout Swivel Range: 360°
 Cartridge: 25mm Ceramic
 Check Valve: Integrated Double
 Countertop Hole Diameter: 1 ¾"
 Weight: 10 lbs.

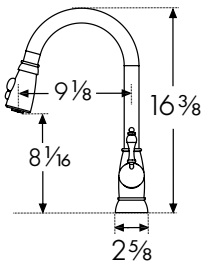

FF7000A

- FF7000A** Polished Chrome **\$1,598**
- FF7070A** Polished Nickel **\$1,785**
- FF7080A** Satin Nickel **\$1,785**



FEATURES AND BENEFITS

3-Hole Bridge Faucet with Side Spray
 Flow Rate: 1.75 gpm
 Spray Function: Press & Hold
 Spray Type: Full & Needle
 Spout Swivel Range: 180°
 Cartridge: ½" Ceramic
 Check Valve: Integrated Double
 Countertop Hole Diameter: 1 ¾"
 Weight: 15 lbs.

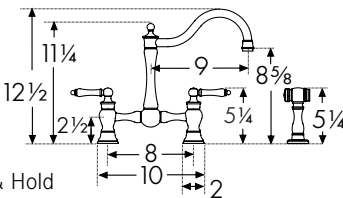

PF7000A

- PF7000A** Polished Chrome **\$825**
- PF7070A** Polished Nickel **\$925**
- PF7080A** Satin Nickel **\$925**



FEATURES AND BENEFITS

Wall Mount Pot Filler
 Flow Rate: 2.2 gpm
 Spray Type: Full
 Spout Swivel Range: 180°
 Cartridge: ½" Ceramic
 Weight: 5 lbs.

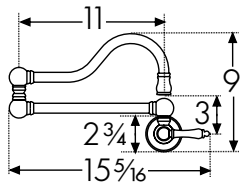

FFS100

- FFS100** Polished Chrome **\$ 925**
- FFS170** Polished Nickel **\$1,030**
- FFS180** Satin Nickel **\$1,030**



FEATURES AND BENEFITS

1-Hole with Side Spray
 Flow Rate: 1.75 gpm
 Spray Function: Press & Hold
 Spray Type: Full & Needle
 Spout Swivel Range: 180°
 Cartridge: 25mm Ceramic
 Check Valve: Integrated Double
 Countertop Hole Diameter: 1 ¾"
 Weight: 9 lbs.

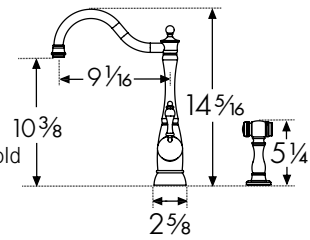

PF3300

- PF3300** Polished Chrome **\$645**
- PF3380** Satin Nickel **\$745**



FEATURES AND BENEFITS

Wall Mount Pot Filler
 Flow Rate: 2.2 gpm
 Spray Type: Full
 Spout Swivel Range: 180°
 Cartridge: ½" Ceramic
 Weight: 5 lbs.

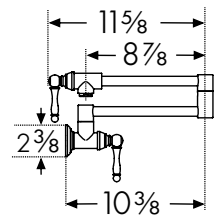

FFS400

- FFS400** Polished Chrome **\$ 925**
- FFS470** Polished Nickel **\$1,030**
- FFS480** Satin Nickel **\$1,030**



FEATURES AND BENEFITS

1-Hole with Side Spray
 Flow Rate: 1.75 gpm
 Spray Function: Press & Hold
 Spray Type: Full & Needle
 Spout Swivel Range: 180°
 Cartridge: ½" Ceramic
 Check Valve: Integrated Double
 Countertop Hole Diameter: 1 ¾"
 Weight: 11 lbs.

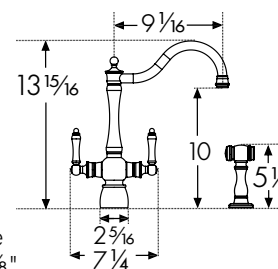

DW6100C

- DW6100C** Polished Chrome **\$395**
- DW6170C** Polished Nickel **\$480**
- DW6180C** Satin Nickel **\$480**



FEATURES AND BENEFITS

The Little Butler® Cold Filtered
 Flow Rate: 0.5 gpm
 Spray Type: Stream
 Spout Swivel Range: 360°
 Cartridge: ¾" Ceramic
 Countertop Hole Diameter: 1 ¾"
 Weight: 3 lbs.

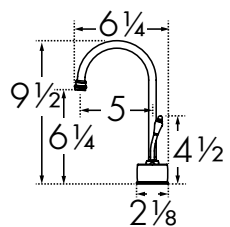

Faucet supply lines are U.S. standard 3/8" O.D. All faucets can accommodate at least 1 3/4" countertop thickness. Several can accommodate up to 3". Call for additional thickness.

Faucet supply lines are U.S. standard 3/8" O.D. All faucets can accommodate at least 1 3/4" countertop thickness. Several can accommodate up to 3". Call for additional thickness.

LB6100C

- LB6100C** Polished Chrome **\$395**
- LB6170C** Polished Nickel **\$480**
- LB6180C** Satin Nickel **\$480**



FEATURES AND BENEFITS

The Little Butler® Hot Filtered
 Flow Rate: 0.5 gpm
 Spray Type: Stream
 Spout Swivel Range: 360°
 Cartridge: 3/8" Ceramic
 Countertop Hole Diameter: 1 3/8"
 Weight: 3 lbs.

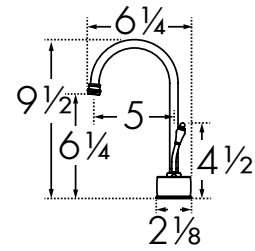

LB12200

- LB12200** Polished Chrome **\$525**
- LB12280** Satin Nickel **\$635**



FEATURES AND BENEFITS

The Little Butler® Hot/Cold Filtered
 Flow Rate: 0.5 gpm
 Spray Type: Stream
 Spout Swivel Range: 360°
 Cartridge: 3/8" Ceramic
 Countertop Hole Diameter: 1 1/4"
 Weight: 4 lbs.

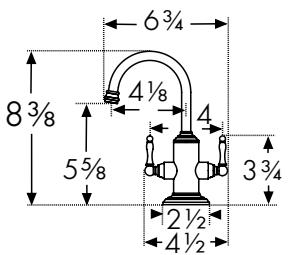

LB6200C

- LB6200C** Polished Chrome **\$545**
- LB6270C** Polished Nickel **\$655**
- LB6280C** Satin Nickel **\$655**



FEATURES AND BENEFITS

The Little Butler® Hot/Cold Filtered
 Flow Rate: 0.5 gpm
 Spray Type: Stream
 Spout Swivel Range: 360°
 Cartridge: 3/8" Ceramic
 Countertop Hole Diameter: 1 3/8"
 Weight: 3 lbs.

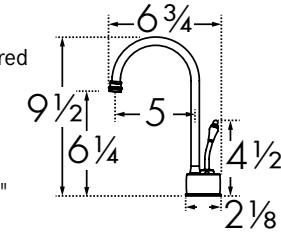

SD6000

- SD6000** Polished Chrome **\$180**
- SD6070** Polished Nickel **\$210**
- SD6080** Satin Nickel **\$210**



FEATURES AND BENEFITS

Hole Size: 1 1/8"
 Weight: 1 lb.
 Capacity: 12 oz.

Dispenser Head Detail

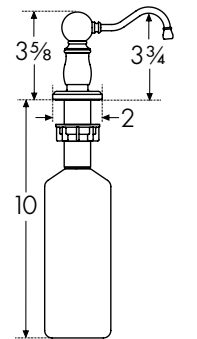
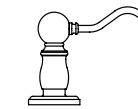

DW12000

- DW12000** Polished Chrome **\$420**
- DW12080** Satin Nickel **\$495**



FEATURES AND BENEFITS

The Little Butler® Cold Filtered
 Flow Rate: 0.5 gpm
 Spray Type: Stream
 Spout Swivel Range: 360°
 Cartridge: 3/8" Ceramic
 Countertop Hole Diameter: 1 1/4"
 Weight: 2 lbs.

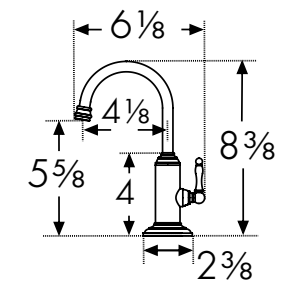

LB12100

- LB12100** Polished Chrome **\$420**
- LB12180** Satin Nickel **\$495**



FEATURES AND BENEFITS

The Little Butler® Hot Filtered
 Flow Rate: 0.5 gpm
 Spray Type: Stream
 Spout Swivel Range: 360°
 Cartridge: 3/8" Ceramic
 Countertop Hole Diameter: 1 1/4"
 Weight: 3 lbs.

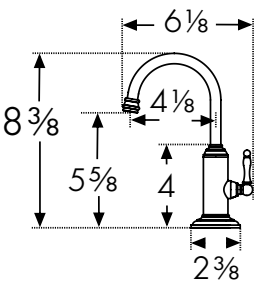

Indicates: Cold Hot Hot/Cold

Indicates: Cold Hot Hot/Cold

Faucet supply lines are U.S. standard 3/8" O.D. All faucets can accommodate at least 1 3/4" countertop thickness. Several can accommodate up to 3". Call for additional thickness.

Faucet supply lines are U.S. standard 3/8" O.D. All faucets can accommodate at least 1 3/4" countertop thickness. Several can accommodate up to 3". Call for additional thickness.



Pictured: FFPD5400 faucet

NEW FFPD5400

Available Spring 2019

- FFPD5400 Polished Chrome \$1,095
- FFPD5480 Satin Nickel \$1,295



FEATURES AND BENEFITS

1-Hole Semi-Pro & Point-of-Use
Flow Rate: 1.75 gpm & .5 gpm
Spray Function: Press & Hold
Spray Type: Full & Needle
Spout Swivel Range: 360°
Cartridge: 35mm Ceramic
Check Valve: Integrated Double
Countertop Hole Diameter: 1 3/8"
Weight: 12 lbs.

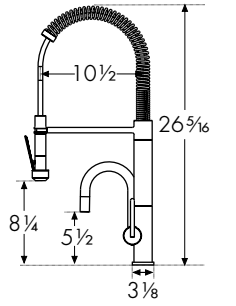

NEW FFPD5300

Available Spring 2019

- FFPD5300 Polished Chrome \$ 995
- FFPD5380 Satin Nickel \$1,195



FEATURES AND BENEFITS

1-Hole Semi-Pro
Flow Rate: 1.75 gpm
Spray Function: Press & Hold
Spray Type: Full & Needle
Spout Swivel Range: 360°
Cartridge: 35mm Ceramic
Check Valve: Integrated Double
Countertop Hole Diameter: 1 3/8"
Weight: 11 lbs.

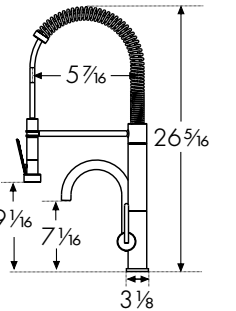

NEW FF5300

Available Spring 2019

- FF5300 Polished Chrome \$ 675
- FF5380 Satin Nickel \$ 795



FEATURES AND BENEFITS

1-Hole Semi-Pro
Flow Rate: 1.75 gpm
Spray Function: Toggle
Spray Type: Full & Needle
Spout Swivel Range: 360°
Cartridge: 35mm Ceramic
Check Valve: Integrated Double
Countertop Hole Diameter: 1 3/8"
Weight: 8 lbs.

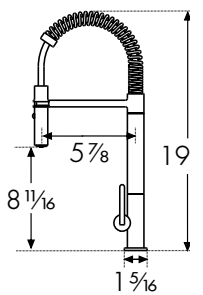

PROFESSIONAL

Professional faucets are available in **three sizes** to fit your workstyle and your design preference. All feature a **360-degree swivel spout** for a powerful, directional spray. Pair your new faucet with one of Franke's Professional series sinks for a kitchen that not only works hard but is also a beautiful addition to your kitchen.



Faucet supply lines are U.S. standard 3/8" O.D. All faucets can accommodate at least 1 3/4" countertop thickness. Several can accommodate up to 3". Call for additional thickness.



Pictured: FFPD4621 faucet

CRYSTAL

Crystal faucets beautifully complement the sinks in our Crystal Collection. But they also make a **bold statement** – and offer extraordinary function – when paired with any Franke sink.



FFPD4600

- FFPD4600 Polished Chrome \$1,125
- FFPD4611 Chrome with White Glass \$1,225
- FFPD4621 Chrome with Black Glass \$1,225
- FFPD4680 Satin Nickel \$1,325



FEATURES AND BENEFITS

- 1-Hole Semi-Pro
- Flow Rate: 1.75 gpm
- Spray Function: Toggle
- Spray Type: Full & Needle
- Spout Swivel Range: 360°
- Cartridge: 35mm Ceramic
- Check Valve: Integrated Double
- Countertop Hole Diameter: 1 3/8"
- Weight: 11 lbs.
- Magnetic Spray Dock

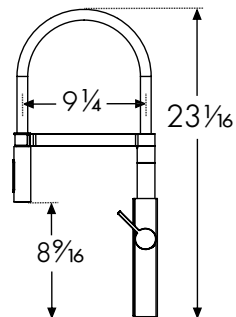

Faucet supply lines are U.S. standard 3/8" O.D. All faucets can accommodate at least 1 3/4" countertop thickness. Several can accommodate up to 3". Call for additional thickness.



MASTERCHEF

Enjoy the advantages of a **commercial kitchen** with a Masterchef faucet. The **pull-down spray** offers the ultimate in **maneuverability**, whether you're filling a pot on an adjacent counter or washing produce in the sink.

FFPD2000

- FFPD2000 Polished Chrome \$1,025
- FFPD2080 Satin Nickel \$1,225



FEATURES AND BENEFITS

- 1-Hole Semi-Pro
- Flow Rate: 1.75 gpm
- Spray Function: Toggle
- Spray Type: Full & Needle
- Spout Swivel Range: 360°
- Cartridge: 25mm Ceramic
- Check Valve: Integrated Double
- Countertop Hole Diameter: 1 3/8"
- Weight: 8 lbs.

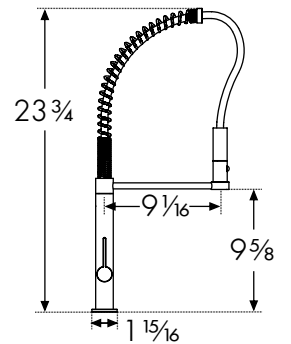

Pictured: FFPD2000 faucet

PURUS



The new Purus filtered faucet features Franke's **patented triple-filter process technology** cleverly housed within a stylish compact capsule that fits right on the tap. The Purus filter **removes more than 95%* of chlorine and 99%* of other harmful particles** while retaining all beneficial minerals. Available in three styles and two finishes, Purus requires no under-sink filter so it fits beautifully in even the smallest of spaces.



PURUS

NEW FFPD5600

Available Spring 2019

FFPD5600  Chrome/Gun Metal \$895
FFPD5620  Black/Satin Nickel \$995



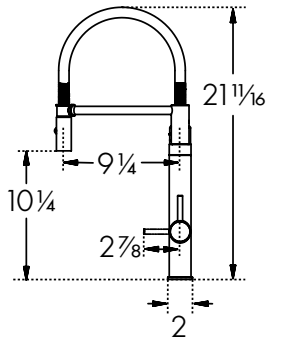

FEATURES AND BENEFITS

1-Hole Semi-Pro & Point-of-Use
Flow Rate: 1.75 & .9 gpm
Spray Function: Toggle
Spray Type: Full & Needle
Spout Swivel Range: 360°
Cartridge: 35mm & 1/2" Ceramic
Check Valve: Integrated Double
Countertop Hole Diameter: 1 3/8"
Weight: 11 lbs.



NEW DW5600

Available Spring 2019

DW5600  Chrome/Gun Metal \$375
DW5620  Black/Satin Nickel \$425



FEATURES AND BENEFITS

1-Hole Point-of-Use
Flow Rate: .9 gpm
Spray Type: Full
Spout Swivel Range: 360°
Cartridge: 1/2" Ceramic
Check Valve: Integrated
Countertop Hole Diameter: 1"
Weight: 6 lbs.

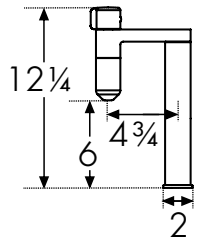

NEW SP-FC1

Available Spring 2019

Purus Filter

\$ 59



FEATURES AND BENEFITS

Reduces:

- Chlorine & Chloramine (taste and odor)
- Particulate & Turbidity
- Cysts (Cryptosporidium), THMS & VOC's
- Rust, Dirt, Sediment & More
- Micro plastics

132 gal. capacity (2 Months)

NEW SP-FC3

Available Spring 2019

3 Pack Purus Filter

\$149



FEATURES AND BENEFITS

Reduces:

- Chlorine & Chloramine (taste and odor)
- Particulate & Turbidity
- Cysts (Cryptosporidium), THMS & VOC's
- Rust, Dirt, Sediment & More
- Micro plastics

3 x 132 gal. capacity (6 Months)



Pictured: FFPD5620 faucet

*Restrictions apply for the states of California, Iowa and Wisconsin.

Faucet supply lines are U.S. standard 3/8" O.D. All faucets can accommodate at least 1 1/4" countertop thickness. Several can accommodate up to 3". Call for additional thickness.

Purus
Faucets

Purus
Faucets





CHILLOUT



The **modern minimalist design** enables the Chillout to perfectly fulfill the demanding requirements of any culinary kitchen. The **flexible swivel spout** offers **maximum clearance** for all types of cookware - even large pots and pans.

FF4900

- FF4900  Polished Chrome \$760
- FF4980  Satin Nickel \$925



FEATURES AND BENEFITS

- 1-Hole Semi-Pro
- Flow Rate: 1.75 gpm
- Spray Type: Full
- Spout Swivel Range: 360°
- Cartridge: 25mm Ceramic
- Check Valve: Integrated Double
- Countertop Hole Diameter: 1 3/8"
- Weight: 7 lbs.

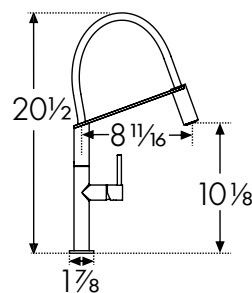

Faucet supply lines are U.S. standard 3/8" O.D. All faucets can accommodate at least 1 1/4" countertop thickness. Several can accommodate up to 3". Call for additional thickness.



Pictured: FF4980 faucet

PLANAR 8

The **semi-pro pull-down** spray head and **single-hand operation** are just two of the reasons home chefs love the Planar 8 faucet. Made to **coordinate with Planar 8 sinks**, this faucet also enhances many other styles in the Franke sink collections.



FF2800

FF2800  Polished Chrome \$745
 FF2880  Satin Nickel \$950



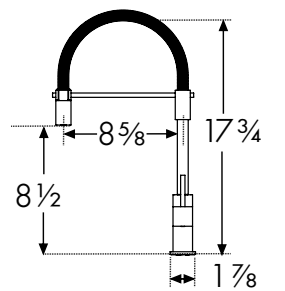

FEATURES AND BENEFITS

1-Hole Semi-Pro
 Flow Rate: 1.75 gpm
 Spray Function: Toggle
 Spray Type: Full & Needle
 Spout Swivel Range: 360°
 Cartridge: 25mm Ceramic
 Check Valve: Integrated Double
 Countertop Hole Diameter: 1 3/8"
 Weight: 7 lbs.
 Magnetic Spray Dock



FFP2800

FFP2800  Polished Chrome \$535
 FFP2880  Satin Nickel \$635



FEATURES AND BENEFITS

1-Hole Prep
 Flow Rate: 1.75 gpm
 Spray Type: Full
 Spout Swivel Range: 360°
 Cartridge: 25mm Ceramic
 Countertop Hole Diameter: 1 3/8"
 Weight: 5 lbs.

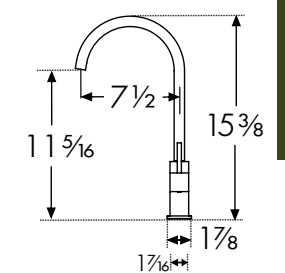

FFB2800

FFB2800  Polished Chrome \$430
 FFB2880  Satin Nickel \$515



FEATURES AND BENEFITS

1-Hole Bar
 Flow Rate: 1.75 gpm
 Spray Type: Full
 Spout Swivel Range: 360°
 Cartridge: 25mm Ceramic
 Countertop Hole Diameter: 1 3/8"
 Weight: 5 lbs.

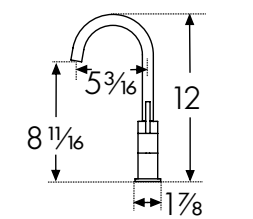

PLANAR 8 DISPENSER

NEW SD2600

Available Spring 2019
 SD2600  Polished Chrome \$185
 SD2680  Satin Nickel \$215



FEATURES AND BENEFITS

Hole Size: 1 1/8"
 Weight: 1 lb.
 Capacity: 8.5 oz.

Dispenser Head Detail

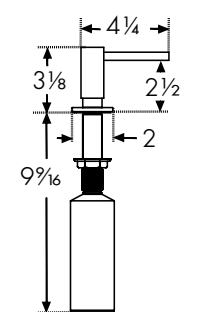
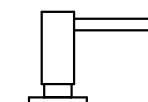

Planar 8
Faucets

Planar 8
Faucets



Pictured: FF2880 faucet

Faucet supply lines are U.S. standard 3/8" O.D. All faucets can accommodate at least 1 3/4" countertop thickness. Several can accommodate up to 3". Call for additional thickness.



Absinthe
Faucets

ABSINTHE

Beauty across the entire range. Oriented on current trends in product design, the combination of the **transitional style** and sculptured form provide **sleek aesthetics** that will delight any chef day after day.



Absinthe
Faucets



FFS5200

- FFS5200** Polished Chrome \$720
- FFS5220** Matte Black \$865
- FFS5270** Polished Nickel \$865
- FFS5280** Satin Nickel \$865



FEATURES AND BENEFITS

1-Hole Faucet with Side Spray
 Flow Rate: 1.75 gpm
 Spray Function: Press & Hold
 Spray Type: Full & Needle
 Spout Swivel Range: 360°
 Cartridge: 1/2" Ceramic
 Check Valve: Integrated Double
 Countertop Hole Diameter: 1 3/8"
 Weight: 10 lbs.

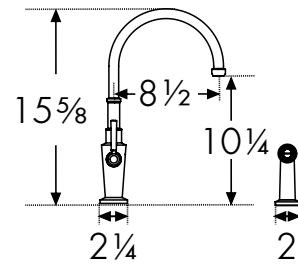

FFP5200

- FFP5200** Polished Chrome \$585
- FFP5220** Matte Black \$710
- FFP5270** Polished Nickel \$710
- FFP5280** Satin Nickel \$710



FEATURES AND BENEFITS

1-Hole Prep
 Flow Rate: 1.75 gpm
 Spray Function: Toggle
 Spray Type: Full & Needle
 Spout Swivel Range: 180°
 Cartridge: 35mm Ceramic
 Countertop Hole Diameter: 1 3/8"
 Weight: 11 lbs.
 Magnetic Spray Dock

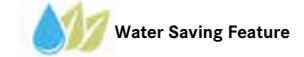
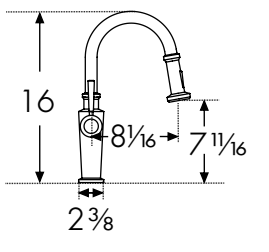

FF5200

- FF5200** Polished Chrome \$615
- FF5220** Matte Black \$750
- FF5270** Polished Nickel \$750
- FF5280** Satin Nickel \$750



FEATURES AND BENEFITS

1-Hole Pull-Down
 Flow Rate: 1.75 gpm
 Spray Function: Toggle
 Spray Type: Full & Needle
 Spout Swivel Range: 180°
 Cartridge: 35mm Ceramic
 Countertop Hole Diameter: 1 3/8"
 Weight: 11 lbs.
 Magnetic Spray Dock

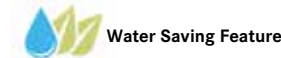
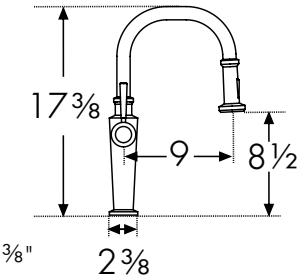

FFB5200

- FFB5200** Polished Chrome \$440
- FFB5220** Matte Black \$540
- FFB5270** Polished Nickel \$540
- FFB5280** Satin Nickel \$540



FEATURES AND BENEFITS

1-Hole Bar
 Flow Rate: 1.75 gpm
 Spray Type: Full
 Spout Swivel Range: 360°
 Cartridge: 28mm Ceramic
 Countertop Hole Diameter: 1 3/8"
 Weight: 6 lbs.

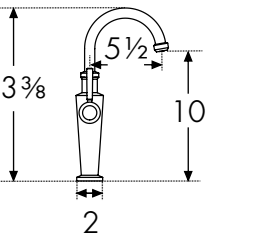

FFPS5200

- FFPS5200** Polished Chrome \$615
- FFPS5220** Matte Black \$750
- FFPS5270** Polished Nickel \$750
- FFPS5280** Satin Nickel \$750



FEATURES AND BENEFITS

1-Hole Pull-Out
 Flow Rate: 1.75 gpm
 Spray Function: Toggle
 Spray Type: Full & Needle
 Spout Swivel Range: 180°
 Cartridge: 35mm Ceramic
 Countertop Hole Diameter: 1 3/8"
 Weight: 9 lbs.

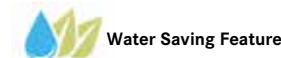
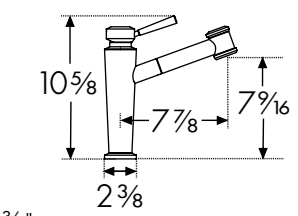

FFT5200

- FFT5200** Polished Chrome \$515
- FFT5220** Matte Black \$615
- FFT5270** Polished Nickel \$615
- FFT5280** Satin Nickel \$615



FEATURES AND BENEFITS

3 in 1 Hot/Cold/Filtered Cold
 Flow Rate: 1.75 gpm/0.5 gpm
 Spray Type: Full & Stream
 Spout Swivel Range: 360°
 Cartridge: 28mm Ceramic
 Countertop Hole Diameter: 1 3/8"
 Weight: 10 lbs.

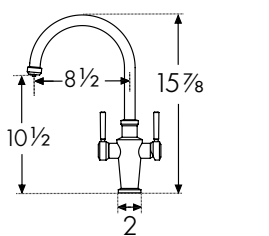

Note: Filter is not included. Please reference pages 274-280 for filtration options.

PF5200

- PF5200** Polished Chrome \$615
- PF5220** Matte Black \$750
- PF5270** Polished Nickel \$750
- PF5280** Satin Nickel \$750



FEATURES AND BENEFITS

Wall Mount Pot Filler
 Flow Rate: 2.2 gpm
 Spout Swivel Range: 180°
 Cartridge: 1/2" Ceramic
 Weight: 6 lbs.

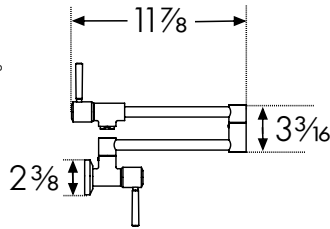

DW15000

- DW15000** Polished Chrome \$430
- DW15020** Matte Black \$505
- DW15070** Polished Nickel \$505
- DW15080** Satin Nickel \$505



FEATURES AND BENEFITS

The Little Butler® Cold Filtered
 Flow Rate: 0.5
 Spray Type: Stream
 Spout Swivel Range: 360°
 Cartridge: 3/8" Ceramic
 Countertop Hole Diameter: 1 1/4"
 Weight: 3 lbs.

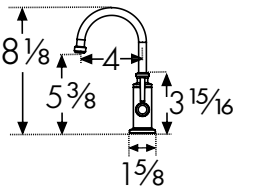

Faucet supply lines are U.S. standard 3/8" O.D. All faucets can accommodate at least 1 3/4" countertop thickness. Several can accommodate up to 3". Call for additional thickness.

LB15100

- LB15100 Polished Chrome \$420
- LB15120 Matte Black \$495
- LB15170 Polished Nickel \$495
- LB15180 Satin Nickel \$495



FEATURES AND BENEFITS

The Little Butler® Hot Filtered
 Flow Rate: 0.5
 Spray Type: Stream
 Spout Swivel Range: 360°
 Cartridge: 3/8" Ceramic
 Countertop Hole Diameter: 1 1/4"
 Weight: 3 lbs.

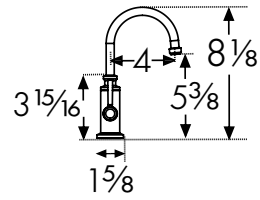

LB15200

- LB15200 Polished Chrome \$525
- LB15220 Matte Black \$635
- LB15270 Polished Nickel \$635
- LB15280 Satin Nickel \$635



FEATURES AND BENEFITS

The Little Butler® Hot/Cold Filtered
 Flow Rate: 0.5
 Spray Type: Stream
 Spout Swivel Range: 360°
 Cartridge: 3/8" Ceramic
 Countertop Hole Diameter: 1 1/4"
 Weight: 3 lbs.

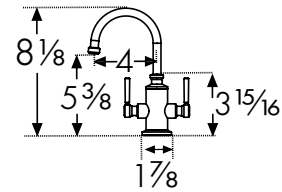

ABSINTHE DISPENSER

SD5200

- SD5200 Polished Chrome \$140
- SD5220 Matte Black \$170
- SD5270 Polished Nickel \$170
- SD5280 Satin Nickel \$170



FEATURES AND BENEFITS

Hole Size: 1 1/8"
 Weight: 1 lb.
 Capacity: 10 oz.

Dispenser Head Detail

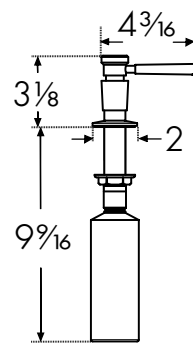
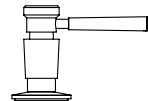

Indicates: Cold Hot Hot/Cold

Faucet supply lines are U.S. standard 3/8" O.D. All faucets can accommodate at least 1 3/4" countertop thickness. Several can accommodate up to 3". Call for additional thickness.

Absinthe Faucets

Absinthe Faucets

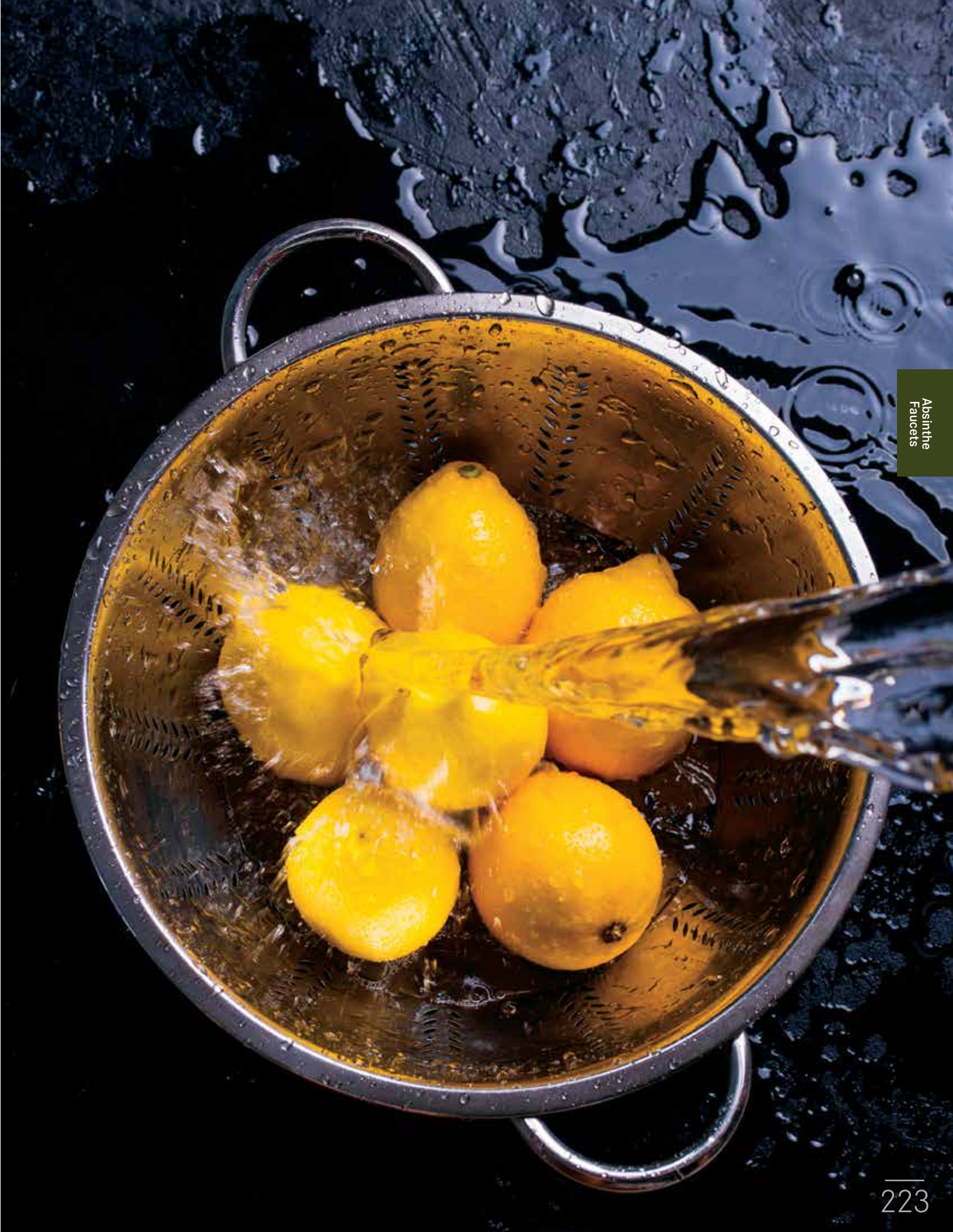



Pescara
Faucets



Pescara
Faucets

PESCARA

Pescara faucets are elegantly designed with an abundance of **functional features**. The innovative **rear-docking spray head** puts Pescara on the “must have” list of so many home chefs.



FFPD4300

- FFPD4300 Polished Chrome \$720
- FFPD4350 Stainless Steel \$850



FEATURES AND BENEFITS

1-Hole Semi-Pro
 Flow Rate: 1.75 gpm
 Spray Function: Toggle
 Spray Type: Full & Needle
 Spout Swivel Range: 360°
 Cartridge: 35mm Ceramic
 Check Valve: Integrated Double
 Countertop Hole Diameter: 1 3/8"
 Weight: 10 lbs.
 Magnetic Spray Dock

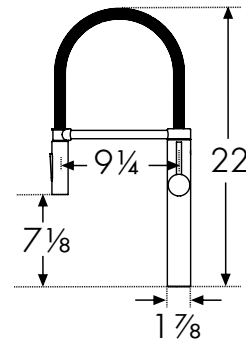

NEW FF4700

Available Spring 2019

- FF4700 Polished Chrome \$560
- FF4720 Matte Black \$660
- FF4780 Satin Nickel \$660



FEATURES AND BENEFITS

1-Hole Pull-Down
 Flow Rate: 1.75 gpm
 Spray Function: Toggle
 Spray Type: Full & Needle
 Spout Swivel Range: 360°
 Cartridge: 35mm Ceramic
 Check Valve: Integrated Double
 Countertop Hole Diameter: 1 3/8"
 Weight: 6 lbs.

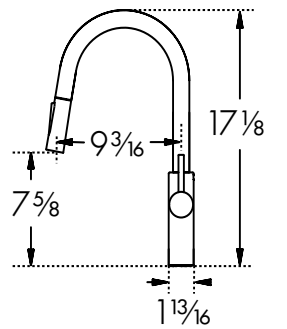

FFPD4400

- FFPD4400 Polished Chrome \$585
- FFPD4450 Stainless Steel \$750



FEATURES AND BENEFITS

1-Hole Semi-Pro
 Flow Rate: 1.75 gpm
 Spray Function: Toggle
 Spray Type: Full & Needle
 Spout Swivel Range: 360°
 Cartridge: 25mm Ceramic (FFPD4450)
 28mm Ceramic (FFPD4400)
 Check Valve: Integrated Double
 Countertop Hole Diameter: 1 3/8"
 Weight: 8 lbs.
 Magnetic Spray Dock

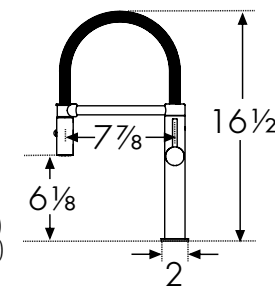

Water Saving Feature (FFPD4400 only)

FFP4400

- FFP4400 Polished Chrome \$410
- FFP4480 Satin Nickel \$510



FEATURES AND BENEFITS

1-Hole Prep
 Flow Rate: 1.75 gpm
 Spray Type: Full
 Spout Swivel Range: 360°
 Cartridge: 28mm Ceramic
 Countertop Hole Diameter: 1 3/8"
 Weight: 7 lbs.

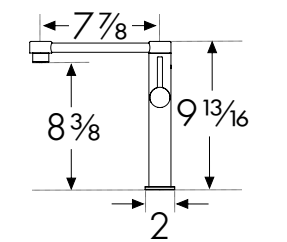

Water Saving Feature

FF4400

- FF4400 Polished Chrome \$565
- FF4480 Satin Nickel \$665
- NEW Available Spring 2019
- FF4420 Matte Black \$665



Extended View

FEATURES AND BENEFITS

1-Hole Semi-Pro
 Flow Rate: 1.75 gpm
 Spray Function: Press & Hold
 Spray Type: Full & Needle
 Spout Swivel Range: 360°
 Cartridge: 28mm Ceramic
 Countertop Hole Diameter: 1 3/8"
 Weight: 8 lbs.
 Magnetic Spray Dock

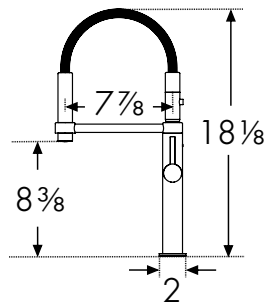

Water Saving Feature

PFD4400

- PFD4400 Polished Chrome \$510
- PFD4480 Satin Nickel \$615



FEATURES AND BENEFITS

Deck Mount Pot Filler
 Flow Rate: 1.75 gpm
 Spray Type: Full
 Spout Swivel Range: 360°
 Cartridge: 28mm Ceramic
 Countertop Hole Diameter: 1 3/8"
 Weight: 8 lbs.

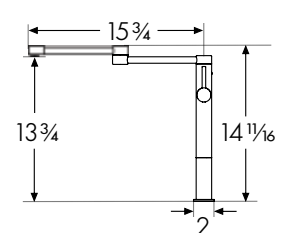

Water Saving Feature

NEW FF4800

Available Spring 2019

- FF4800 Polished Chrome \$590
- FF4880 Satin Nickel \$690



FEATURES AND BENEFITS

1-Hole Pull-Down
 Flow Rate: 1.75 gpm
 Spray Function: Toggle
 Spray Type: Full & Needle
 Spout Swivel Range: 360°
 Cartridge: 35mm Ceramic
 Check Valve: Integrated Double
 Countertop Hole Diameter: 1 3/8"
 Weight: 6 lbs.

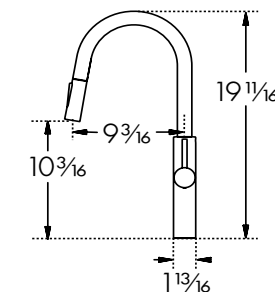

PF4400

- PF4400 Polished Chrome \$510
- PF4480 Satin Nickel \$615



FEATURES AND BENEFITS

Wall Mount Pot Filler
 Flow Rate: 2.2 gpm
 Spray Type: Full
 Spout Swivel Range: 180°
 Cartridge: 1/2" Ceramic
 Weight: 6 lbs.

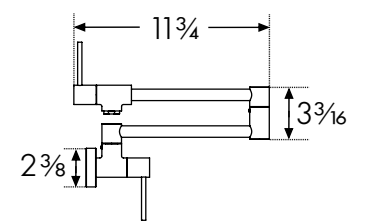

DW16000

- DW16000  Polished Chrome \$420
- DW16080  Satin Nickel \$495
- NEW** Available Spring 2019
- DW16020  Matte Black \$495
- DW16022  Shiny Black \$495
- DW16040  Gun Metal \$495
- DW16061  Copper \$495
- DW16065  Bronze \$495
- DW16070  Polished Nickel \$495
- DW16090  Satin Brass \$495



FEATURES AND BENEFITS

The Little Butler® Cold Filtered
 Flow Rate: 0.5
 Spray Type: Stream
 Spout Swivel Range: 360°
 Cartridge: 3/8" Ceramic
 Countertop Hole Diameter: 1 1/4"
 Weight: 3 lbs.

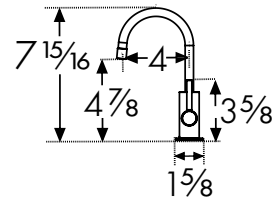

LB16100

- LB16100  Polished Chrome \$430
- LB16180  Satin Nickel \$505
- NEW** Available Spring 2019
- LB16120  Matte Black \$505
- LB16122  Shiny Black \$505
- LB16140  Gun Metal \$505
- LB16161  Copper \$505
- LB16165  Bronze \$505
- LB16170  Polished Nickel \$505
- LB16190  Satin Brass \$505







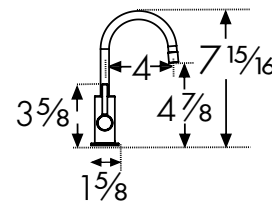



FEATURES AND BENEFITS

The Little Butler® Hot Filtered
 Flow Rate: 0.5
 Spray Type: Stream
 Spout Swivel Range: 360°
 Cartridge: 3/8" Ceramic
 Countertop Hole Diameter: 1 1/4"
 Weight: 3 lbs.



LB16200

- LB16200  Polished Chrome \$525
- LB16280  Satin Nickel \$635
- NEW** Available Spring 2019
- LB16220  Matte Black \$635
- LB16222  Shiny Black \$635
- LB16240  Gun Metal \$635
- LB16261  Copper \$635
- LB16265  Bronze \$635
- LB16270  Polished Nickel \$635
- LB16290  Satin Brass \$635



FEATURES AND BENEFITS

The Little Butler® Hot/Cold Filtered
 Flow Rate: 0.5
 Spray Type: Stream
 Spout Swivel Range: 360°
 Cartridge: 3/8" Ceramic
 Countertop Hole Diameter: 1 1/4"
 Weight: 3 lbs.

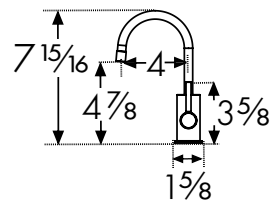

Indicates:  Cold  Hot  Hot/Cold

Faucet supply lines are U.S. standard 3/8" O.D. All faucets can accommodate at least 1 3/4" countertop thickness. Several can accommodate up to 3". Call for additional thickness.



Pictured: FFPD5550 faucet

PEAK

The sleek and chic Peak faucet can complement any sink style. A **pull-down spray** extends this faucet's use in prep, cooking or cleanup then fits back neatly into an intuitive, **angled dock**. You'll love the understated styling of this semi-pro faucet and rave over the simplicity of use.

Peak
Faucets



NEW FFPD5550

Available Spring 2019

FFPD5550  Stainless Steel \$695



FEATURES AND BENEFITS

1-Hole Semi-Pro
 Flow Rate: 1.75 gpm
 Spray Type: Full
 Spout Swivel Range: 360°
 Cartridge: 35mm Ceramic
 Check Valve: Integrated Double
 Countertop Hole Diameter: 1 3/8"
 Weight: 8 lbs.

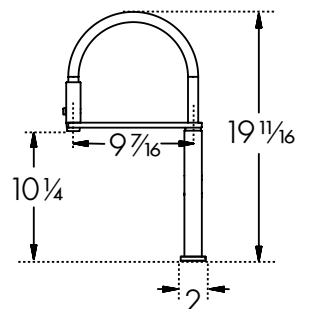

Faucet supply lines are U.S. standard 3/8" O.D. All faucets can accommodate at least 1 3/4" countertop thickness. Several can accommodate up to 3". Call for additional thickness.



Ambient
Faucets



Ambient
Faucets

AMBIENT

Ambient faucets encompass all of your kitchen needs with a **pull-down** and **pull-out** style for ultimate flexibility. Enhance your workspace with the collection's **filtration faucets** and **pot filler** and have all of the functions you need – in a beautifully coordinated style.



FF3100

- FF3100 Polished Chrome \$560
- FF3170 Polished Nickel \$660
- FF3180 Satin Nickel \$660



FEATURES AND BENEFITS

1-Hole Pull-Down
 Flow Rate: 1.75 gpm
 Spray Function: Toggle
 Spray Type: Full & Needle
 Spout Swivel Range: 180°
 Cartridge: 28mm Ceramic
 Check Valve: Integrated Double
 Countertop Hole Diameter: 1 3/8"
 Weight: 6 lbs.
 Magnetic Spray Dock

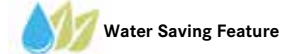
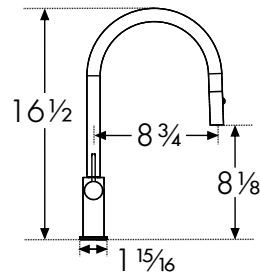

FFPS3600

- FFPS3600 Polished Chrome \$425
- FFPS3680 Satin Nickel \$525



FEATURES AND BENEFITS

1-Hole Pull-Out
 Flow Rate: 1.75 gpm
 Spray Function: Toggle
 Spray Type: Full & Needle
 Spout Swivel Range: 110°
 Cartridge: 35mm Ceramic
 Check Valve: Integrated Double
 Countertop Hole Diameter: 1 3/8"
 Weight: 6 lbs.

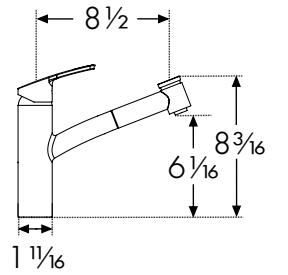

FFP3100

- FFP3100 Polished Chrome \$525
- FFP3170 Polished Nickel \$625
- FFP3180 Satin Nickel \$625



FEATURES AND BENEFITS

1-Hole Pull-Down Prep
 Flow Rate: 1.75 gpm
 Spray Function: Toggle
 Spray Type: Full & Needle
 Spout Swivel Range: 180°
 Cartridge: 28mm Ceramic
 Check Valve: Integrated Double
 Countertop Hole Diameter: 1 3/8"
 Weight: 6 lbs.

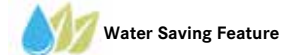
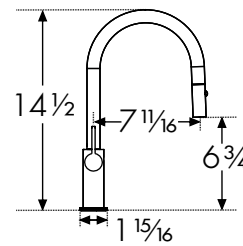

PF3100

- PF3100 Polished Chrome \$645
- PF3170 Polished Nickel \$745
- PF3180 Satin Nickel \$745



FEATURES AND BENEFITS

Wall Mount Pot Filler
 Flow Rate: 2.2 gpm
 Spray Type: Full
 Spout Swivel Range: 180°
 Cartridge: 1/2" Ceramic
 Weight: 5 lbs.

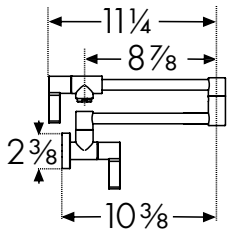

NEW FFPS4300

Available Spring 2019

- FFPS4300 Polished Chrome \$415
- FFPS4320 Matte Black \$495
- FFPS4380 Satin Nickel \$495
- FFPS4395 Brushed Gold \$495



FEATURES AND BENEFITS

1-Hole Pull-Out
 Flow Rate: 1.75 gpm
 Spray Function: Toggle
 Spray Type: Full & Needle
 Spout Swivel Range: 110°
 Cartridge: 35mm Ceramic
 Check Valve: Integrated Double
 Countertop Hole Diameter: 1 3/8"
 Weight: 6 lbs.

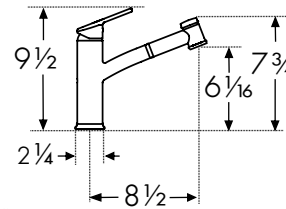

FFT3100

- FFT3100 Polished Chrome \$425
- FFT3170 Polished Nickel \$525
- FFT3180 Satin Nickel \$525



FEATURES AND BENEFITS

3 in 1 Hot/Cold/Filtered Cold
 Flow Rate: 1.75 gpm/0.5 gpm
 Spray Type: Full & Stream
 Spout Swivel Range: 360°
 Cartridge: 28mm Ceramic
 Countertop Hole Diameter: 1 3/8"
 Weight: 6 lbs.

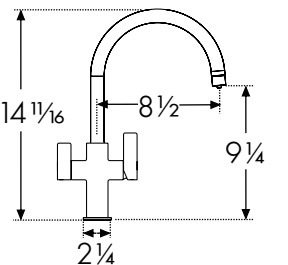

Note: Filter is not included. Please reference pages 274-280 for filtration options.

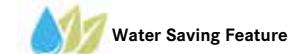

FFB3100

- FFB3100 Polished Chrome \$375
- FFB3170 Polished Nickel \$475
- FFB3180 Satin Nickel \$475



FEATURES AND BENEFITS

1-Hole Bar
 Flow Rate: 1.75 gpm
 Spray Type: Full
 Spout Swivel Range: 360°
 Cartridge: 28mm Ceramic
 Countertop Hole Diameter: 1 3/8"
 Weight: 5 lbs.

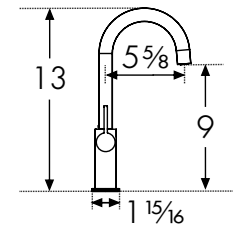

DW7000C

- DW7000C Polished Chrome \$395
- DW7070C Polished Nickel \$480
- DW7080C Satin Nickel \$480



FEATURES AND BENEFITS

The Little Butler® Cold Filtered
 Flow Rate: 0.5 gpm
 Spray Type: Stream
 Spout Swivel Range: 360°
 Cartridge: 3/8" Ceramic
 Countertop Hole Diameter: 1 3/8"
 Weight: 3 lbs.

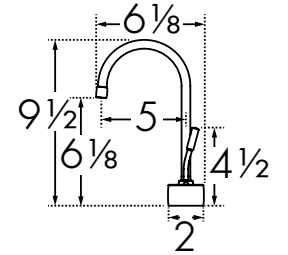

Indicates: Cold Hot Hot/Cold

Faucet supply lines are U.S. standard 3/8" O.D. All faucets can accommodate at least 1 3/4" countertop thickness. Several can accommodate up to 3". Call for additional thickness.

LB7100C

- LB7100C  Polished Chrome \$395
- LB7170C  Polished Nickel \$480
- LB7180C  Satin Nickel \$480



FEATURES AND BENEFITS

The Little Butler® Hot Filtered
 Flow Rate: 0.5 gpm
 Spray Type: Stream
 Spout Swivel Range: 360°
 Cartridge: 3/8" Ceramic
 Countertop Hole Diameter: 1 3/8"
 Weight: 3 lbs.

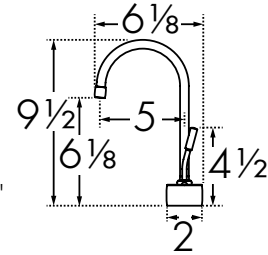

LB10200

- LB10200  Polished Chrome \$525
- LB10270  Polished Nickel \$635
- LB10280  Satin Nickel \$635



FEATURES AND BENEFITS

The Little Butler® Hot/Cold Filtered
 Flow Rate: 0.5 gpm
 Spray Type: Stream
 Spout Swivel Range: 360°
 Cartridge: 3/8" Ceramic
 Countertop Hole Diameter: 1 1/4"
 Weight: 3 lbs.

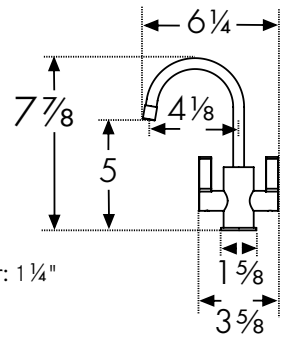

LB7200C

- LB7200C  Polished Chrome \$545
- LB7270C  Polished Nickel \$655
- LB7280C  Satin Nickel \$655



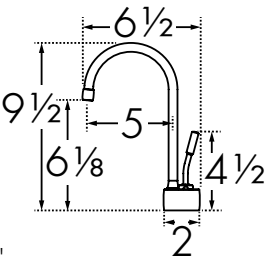

FEATURES AND BENEFITS

The Little Butler® Hot/Cold Filtered
 Flow Rate: 0.5 gpm
 Spray Type: Stream
 Spout Swivel Range: 360°
 Cartridge: 3/8" Ceramic
 Countertop Hole Diameter: 1 3/8"
 Weight: 3 lbs.



SD3100

- SD3100  Polished Chrome \$120
- SD3170  Polished Nickel \$150
- SD3180  Satin Nickel \$150





FEATURES AND BENEFITS

Hole Size: 1 1/8"
 Weight: 1 lb.
 Capacity: 10 oz.

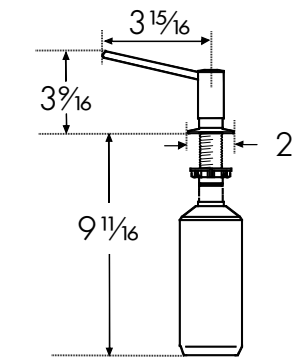
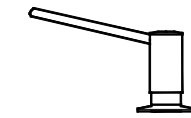
Dispenser Head Detail



DW10000

- DW10000  Polished Chrome \$420
- DW10070  Polished Nickel \$495
- DW10080  Satin Nickel \$495



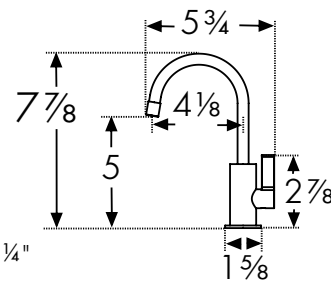

FEATURES AND BENEFITS

The Little Butler® Cold Filtered
 Flow Rate: 0.5 gpm
 Spray Type: Stream
 Spout Swivel Range: 360°
 Cartridge: 3/8" Ceramic
 Countertop Hole Diameter: 1 1/4"
 Weight: 2 lbs.



LB10100

- LB10100  Polished Chrome \$420
- LB10170  Polished Nickel \$505
- LB10180  Satin Nickel \$505



FEATURES AND BENEFITS

The Little Butler® Hot Filtered
 Flow Rate: 0.5 gpm
 Spray Type: Stream
 Spout Swivel Range: 360°
 Cartridge: 3/8" Ceramic
 Countertop Hole Diameter: 1 1/4"
 Weight: 3 lbs.

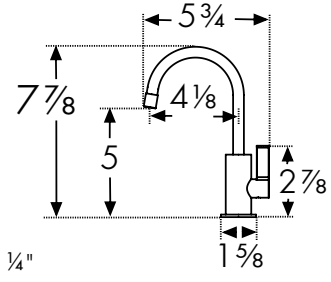

Indicates:  Cold  Hot  Hot/Cold

Indicates:  Cold  Hot  Hot/Cold

Faucet supply lines are U.S. standard 3/8" O.D. All faucets can accommodate at least 1 3/4" countertop thickness. Several can accommodate up to 3". Call for additional thickness.

Faucet supply lines are U.S. standard 3/8" O.D. All faucets can accommodate at least 1 3/4" countertop thickness. Several can accommodate up to 3". Call for additional thickness.

ORCA

This faucet's **graceful lines** and **classic styling** create a perfect complement to your Orca sink – or any sink – and every kitchen design. Add a coordinating **prep** or **bar faucet** or **filtration faucet** to add a wealth of function.



Orca Faucets



FF3550

FF3550 ■ Stainless Steel \$640



FEATURES AND BENEFITS

1-Hole Pull-Down
 Flow Rate: 1.75 gpm
 Spray Function: Toggle
 Spray Type: Full & Needle
 Spout Swivel Range: 360°
 Cartridge: 35mm Ceramic
 Countertop Hole Diameter: 1 3/8"
 Weight: 10 lbs.

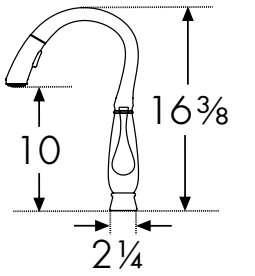

FFP3550

FFP3550 ■ Stainless Steel \$600



FEATURES AND BENEFITS

1-Hole Prep
 Flow Rate: 1.75 gpm
 Spray Function: Toggle
 Spray Type: Full & Needle
 Spout Swivel Range: 360°
 Cartridge: 35mm Ceramic
 Countertop Hole Diameter: 1 3/8"
 Weight: 10 lbs.

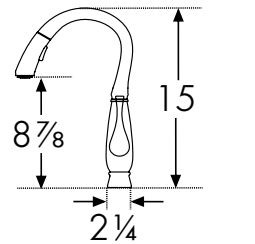

FFB3550

FFB3550 ■ Stainless Steel \$420



FEATURES AND BENEFITS

1-Hole Bar
 Flow Rate: 1.75 gpm
 Spray Type: Full
 Spout Swivel Range: 360°
 Cartridge: 35mm Ceramic
 Countertop Hole Diameter: 1 3/8"
 Weight: 7 lbs.

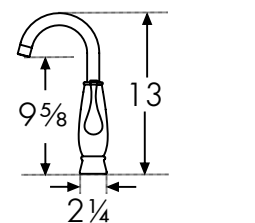

PF3550

PF3550 ■ Stainless Steel \$640



FEATURES AND BENEFITS

Wall Mount Pot Filler
 Flow Rate: 2.2 gpm
 Spray Type: Full
 Spout Swivel Range: 180°
 Cartridge: 1/2" Ceramic
 Weight: 6 lbs.

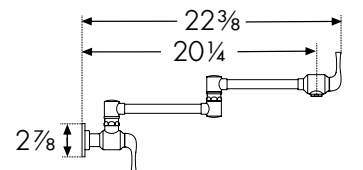

Orca Faucets

Pictured: FF3550 faucet and SD3450 soap dispenser

Faucet supply lines are U.S. standard 3/8" O.D. All faucets can accommodate at least 1 3/4" countertop thickness. Several can accommodate up to 3". Call for additional thickness.

DW14050

DW14050  Stainless Steel \$435



FEATURES AND BENEFITS

The Little Butler® Cold Filtered
 Flow Rate: 0.5 gpm
 Spray Function: Stream
 Spout Swivel Range: 360°
 Cartridge: 3/8" Ceramic
 Countertop Hole Diameter: 1 1/4"
 Weight: 3 lbs.

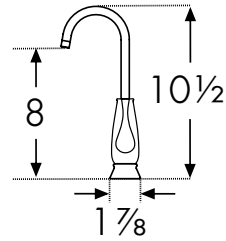

LB14150

LB14150  Stainless Steel \$435



FEATURES AND BENEFITS

The Little Butler® Hot Filtered
 Flow Rate: 0.5 gpm
 Spray Function: Stream
 Spout Swivel Range: 360°
 Cartridge: 3/8" Ceramic
 Countertop Hole Diameter: 1 1/4"
 Weight: 4 lbs.

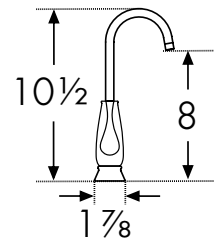

LB14250

LB14250  Stainless Steel \$535



FEATURES AND BENEFITS

The Little Butler® Hot/Cold Filtered
 Flow Rate: 0.5 gpm
 Spray Type: Stream
 Spout Swivel Range: 360°
 Cartridge: 3/8" Ceramic
 Countertop Hole Diameter: 1 1/4"
 Weight: 4 lbs.

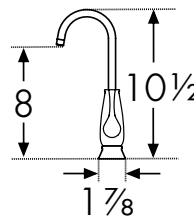

Indicates:  Cold  Hot  Hot/Cold

Faucet supply lines are U.S. standard 3/8" O.D. All faucets can accommodate at least 1 3/4" countertop thickness. Several can accommodate up to 3". Call for additional thickness.

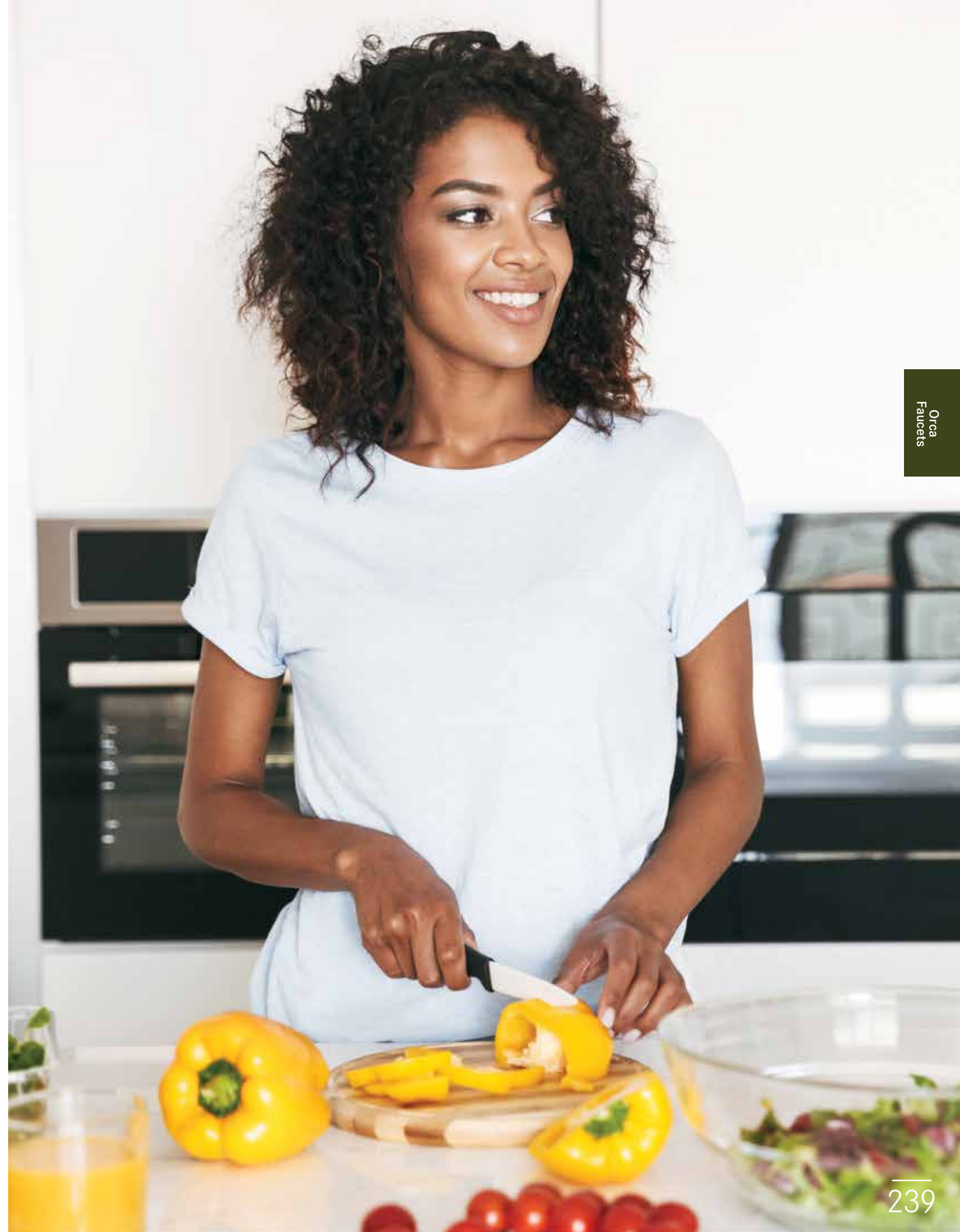

Orca
Faucets

STEEL

The name says it all: Steel collection faucets blend the **modern look** and inherent sturdiness of solid stainless steel. The **pull-down sprayer** and **360-degree spout swivel** range offer maximum utility for today's hard-working kitchen.



Pictured: FFP3450 faucet, LB13150 filtration faucet and SD3450 soap dispenser

FF3450

FF3450 ■ Stainless Steel \$630



FEATURES AND BENEFITS

1-Hole Pull-Down
Flow Rate: 1.75 gpm
Spray Function: Toggle
Spray Type: Full & Needle
Spout Swivel Range: 360°
Cartridge: 35mm Ceramic
Check Valve: Integrated Double
Countertop Hole Diameter: 1 3/8"
Weight: 8 lbs.

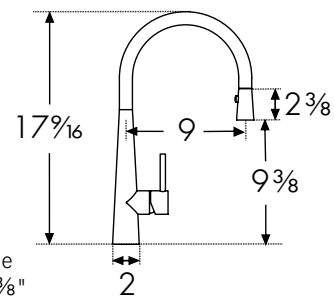

FFP3450

FFP3450 ■ Stainless Steel \$580



FEATURES AND BENEFITS

1-Hole Pull-Down Prep
Flow Rate: 1.75 gpm
Spray Function: Toggle
Spray Type: Full & Needle
Spout Swivel Range: 360°
Cartridge: 35mm Ceramic
Check Valve: Integrated Double
Countertop Hole Diameter: 1 3/8"
Weight: 8 lbs.

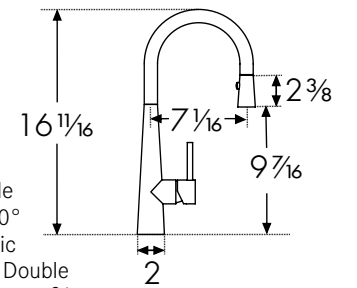

FFB3450

FFB3450 ■ Stainless Steel \$450



FEATURES AND BENEFITS

1-Hole Bar
Flow Rate: 1.75 gpm
Spray Type: Full
Spout Swivel Range: 360°
Cartridge: 35mm Ceramic
Countertop Hole Diameter: 1 3/8"
Weight: 5 lbs.

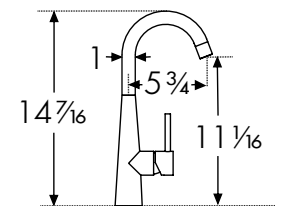

FFPS3450

FFPS3450 ■ Stainless Steel \$580



FEATURES AND BENEFITS

1-Hole Pull-Out
Flow Rate: 1.75 gpm
Spray Function: Toggle
Spray Type: Full & Needle
Spout Swivel Range: 150°
Cartridge: 35mm Ceramic
Check Valve: Integrated Double
Countertop Hole Diameter: 1 3/8"
Weight: 8 lbs.

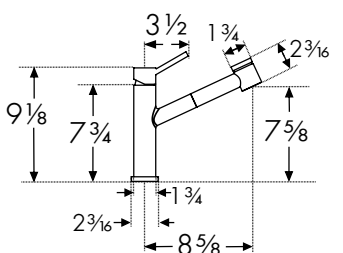

PF3450

PF3450 ■ Stainless Steel \$670



FEATURES AND BENEFITS

Wall Mount Pot Filler
Flow Rate: 2.2 gpm
Spray Type: Full
Spout Swivel Range: 180°
Cartridge: 1/2" Ceramic
Weight: 6 lbs.

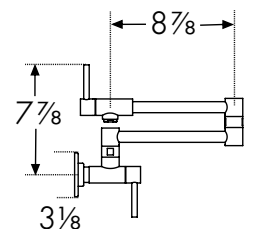

STEEL

FRANKE.US/KS

DW13050

DW13050  Stainless Steel \$435



FEATURES AND BENEFITS

The Little Butler® Cold Filtered
Flow Rate: 0.5 gpm
Spray Function: Stream
Spout Swivel Range: 360°
Cartridge: 3/8" Ceramic
Countertop Hole Diameter: 1 1/4"
Weight: 3 lbs.

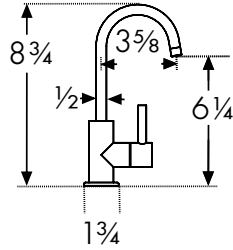

LB13150

LB13150  Stainless Steel \$435



FEATURES AND BENEFITS

The Little Butler® Hot Filtered
Flow Rate: 0.5 gpm
Spray Type: Stream
Spout Swivel Range: 360°
Cartridge: 3/8" Ceramic
Countertop Hole Diameter: 1 1/4"
Weight: 3 lbs.

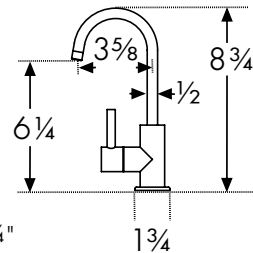

LB13250

LB13250  Stainless Steel \$535



FEATURES AND BENEFITS

The Little Butler® Hot/Cold Filtered
Flow Rate: 0.5 gpm
Spray Type: Stream
Spout Swivel Range: 360°
Cartridge: 3/8" Ceramic
Countertop Hole Diameter: 1 1/4"
Weight: 4 lbs.

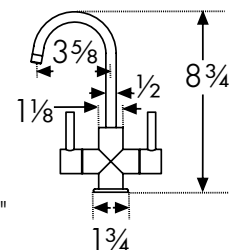

STEEL DISPENSER

SD3450

SD3450  Stainless Steel \$245



FEATURES AND BENEFITS

Hole Size: 1 1/8"
Weight: 1 lb.
Capacity: 10 oz.

Dispenser Head Detail

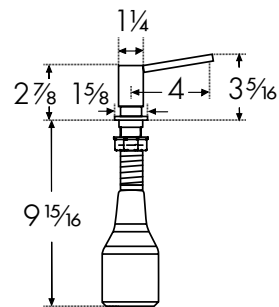
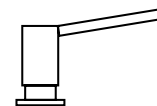

Indicates:  Cold  Hot  Hot/Cold

Faucet supply lines are U.S. standard 3/8" O.D. All faucets can accommodate at least 1 3/4" countertop thickness. Several can accommodate up to 3". Call for additional thickness.





Pictured: FF3200 faucet

FLUENCE

The understated design of this **pull-down** faucet is a stylish addition to any kitchen. Choose between **polished chrome** and **satin nickel** finishes to create the perfect look.



FF3200

FF3200  Polished Chrome \$610
FF3280  Satin Nickel \$710



FEATURES AND BENEFITS

1-Hole Pull-Down
Flow Rate: 1.75 gpm
Spray Function: Toggle
Spray Type: Full & Needle
Spout Swivel Range: 170°
Cartridge: 25mm Ceramic
Check Valve: Integrated Double
Countertop Hole Diameter: 1 3/8"
Weight: 6 lbs.

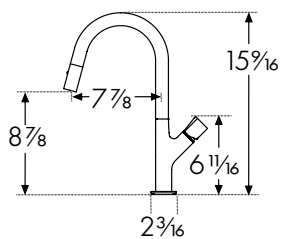

Faucet supply lines are U.S. standard 3/8" O.D. All faucets can accommodate at least 1 3/4" countertop thickness. Several can accommodate up to 3". Call for additional thickness.

MANHATTAN

Features such as the **pull-down spray head**, the **360-degree spout swivel**, the **semi-pro spout** and the **spring hose** make this faucet highly efficient for all of your kitchen tasks. The design adds an urban edginess to any kitchen style.



Pictured: FF2900 faucet

FF2900

- FF2900 Polished Chrome **\$565**
- FF2980 Satin Nickel **\$665**



FEATURES AND BENEFITS

- 1-Hole Semi-Pro
- Flow Rate: 1.75 gpm
- Spray Function: Toggle
- Spray Type: Full & Needle
- Spout Swivel Range: 360°
- Cartridge: 28mm Ceramic
- Check Valve: Integrated Double
- Countertop Hole Diameter: 1 3/8"
- Weight: 5 lbs.

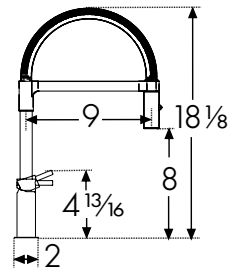
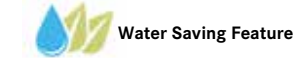

FFP2900

- FFP2900 Polished Chrome **\$475**
- FFP2980 Satin Nickel **\$575**



FEATURES AND BENEFITS

- 1-Hole Prep
- Flow Rate: 1.75 gpm
- Spray Type: Full
- Spout Swivel Range: 360°
- Cartridge: 28mm Ceramic
- Countertop Hole Diameter: 1 3/8"
- Weight: 4 lbs.

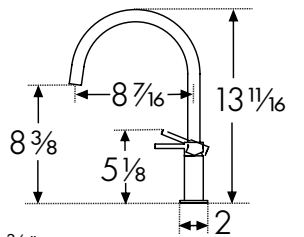

FFB2900

- FFB2900 Polished Chrome **\$390**
- FFB2980 Satin Nickel **\$490**



FEATURES AND BENEFITS

- 1-Hole Bar
- Flow Rate: 1.75 gpm
- Spray Type: Full
- Spout Swivel Range: 360°
- Cartridge: 28mm Ceramic
- Countertop Hole Diameter: 1 3/8"
- Weight: 4 lbs.

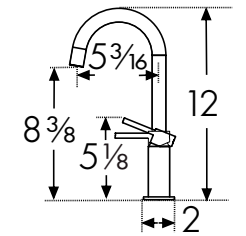

Faucet supply lines are U.S. standard 3/8" O.D. All faucets can accommodate at least 1 3/4" countertop thickness. Several can accommodate up to 3". Call for additional thickness.



Pictured: FF3880 faucet

ACTIVE PLUS
FF3800

FF3800		Polished Chrome	\$555
FF3801		Onyx	\$605
FF3802		Mocha	\$605
FF3803		Storm	\$605
FF3804		Oyster	\$605
FF3805		Champagne	\$605
FF3806		Vanilla	\$605
FF3807		Shadow Grey	\$605
FF3880		Satin Nickel	\$655



FEATURES AND BENEFITS

1-Hole Pull-Out
Flow Rate: 1.75 gpm
Spray Function: Toggle
Spray Type: Full & Needle
Spout Swivel Range: 360°
Cartridge: 35mm Ceramic
Check Valve: Integrated Double
Countertop Hole Diameter: 1 3/8"
Weight: 7 lbs.

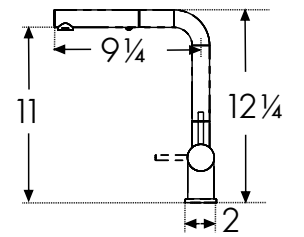

ACTIVE NEO
FF3900

FF3900		Polished Chrome	\$555
FF3980		Satin Nickel	\$655
NEW FF3920		Matte Black	\$655
FF3922		Shiny Black	\$655
FF3940		Gun Metal	\$655
FF3961		Copper	\$655
FF3965		Bronze	\$655
FF3970		Polished Nickel	\$655
FF3990		Satin Brass	\$655

NEW Available Spring 2019



FEATURES AND BENEFITS

1-Hole Pull-Down
Flow Rate: 1.75 gpm
Spray Type: Toggle
Spray Type: Full & Needle
Spout Swivel Range: 360°
Cartridge: 35mm Ceramic
Check Valve: Integrated Double
Countertop Hole Diameter: 1 3/8"
Weight: 8 lbs.

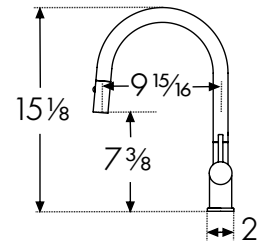

NEW SD3200

Available Spring 2019

SD3200		Polished Chrome	\$115
SD3201		Onyx	\$145
SD3202		Mocha	\$145
SD3203		Storm	\$145
SD3204		Oyster	\$145
SD3205		Champagne	\$145
SD3206		Vanilla	\$145
SD3207		Shadow Grey	\$145
SD3220		Matte Black	\$145
SD3222		Shiny Black	\$145
SD3240		Gun Metal	\$145



FEATURES AND BENEFITS

Hole Size: 1 1/8"
Weight: 1 lb.
Capacity: 10 oz.

ACTIVE DISPENSER

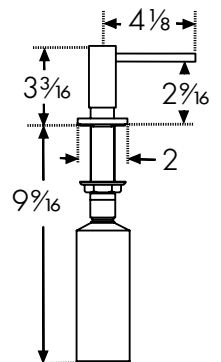

SD3261		Copper	\$145
SD3265		Bronze	\$145
SD3270		Polished Nickel	\$145
SD3280		Satin Nickel	\$145
SD3290		Satin Brass	\$145

ACTIVE

Active Plus faucets are perfect for today's busy kitchens and feature the convenience of a **360-degree swivel spray** and a choice of **nine finishes**. Active Neo offers the same full-circle swivel but with a traditional goose-neck design.



Faucet supply lines are U.S. standard 3/8" O.D. All faucets can accommodate at least 1 3/4" countertop thickness. Several can accommodate up to 3". Call for additional thickness.

Active
Faucets

Active
Faucets



KUBUS

Cleverly designed Kubus is packed with features, such as the **pull-down spray nozzle** that becomes a convenient aid in prep, cooking and cleanup. The hose retracts for **compact storage** in the faucet when not in use.

NEW FF4250

Available Spring 2019

FF4250  Stainless Steel

\$545



FEATURES AND BENEFITS

- 1-Hole Pull-Down
- Flow Rate: 1.75 gpm
- Spray Function: Toggle
- Spray Type: Full & Needle
- Spout Swivel Range: 180°
- Cartridge: 35mm Ceramic
- Check Valve: Integrated Double
- Countertop Hole Diameter: 1 3/8"
- Weight: 7 lbs.

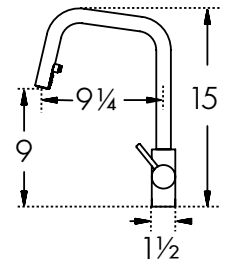

NEW FFP4250

Available Spring 2019

FFP4250  Stainless Steel

\$495



FEATURES AND BENEFITS

- 1-Hole Pull-Down Prep
- Flow Rate: 1.75 gpm
- Spray Function: Toggle
- Spray Type: Full & Needle
- Spout Swivel Range: 180°
- Cartridge: 35mm Ceramic
- Check Valve: Integrated Double
- Countertop Hole Diameter: 1 3/8"
- Weight: 6 lbs.

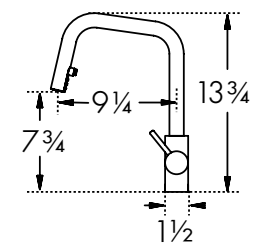

NEW FFB4250

Available Spring 2019

FFB4250  Stainless Steel

\$395



FEATURES AND BENEFITS

- 1-Hole Bar
- Flow Rate: 1.75 gpm
- Spray Type: Full
- Spout Swivel Range: 180°
- Cartridge: 35mm Ceramic
- Check Valve: Integrated Double
- Countertop Hole Diameter: 1 3/8"
- Weight: 4 lbs.

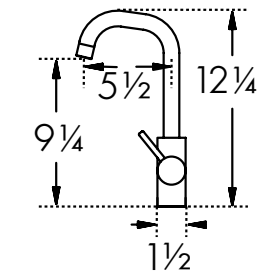

Pictured: FF4250 faucet

Faucet supply lines are U.S. standard 3/8" O.D. All faucets can accommodate at least 1 3/4" countertop thickness. Several can accommodate up to 3". Call for additional thickness.

Kubus
Faucets

Kubus
Faucets



Cube
Faucets



Cube
Faucets

CUBE

The sleek **steel styling** of Cube faucets brings **modern chic** to your kitchen. Complement your kitchen sink with a Cube prep or bar sink for stylish look throughout.



FF3352

FF3352  Stainless Steel

\$580

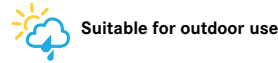

FEATURES AND BENEFITS

1-Hole Pull-Down
Flow Rate: 1.75 gpm
Spray Function: Toggle
Spray Type: Full & Needle
Spout Swivel Range: 360°
Cartridge: 35mm Ceramic
Check Valve: Integrated Double
Countertop Hole Diameter: 1 3/8"
Weight: 10 lbs.
316 Stainless Steel

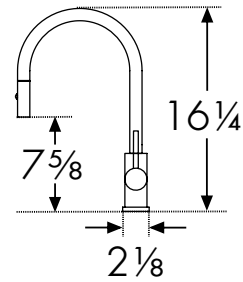

FFB3350

FFB3350  Stainless Steel

\$430



FEATURES AND BENEFITS

1-Hole Bar
Flow Rate: 1.75 gpm
Spray Type: Full
Spout Swivel Range: 360°
Cartridge: 35mm Ceramic
Countertop Hole Diameter: 1 3/8"
Weight: 7 lbs.

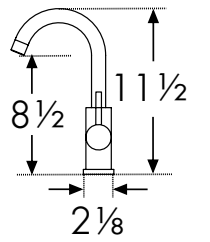

FF3350

FF3350  Stainless Steel

\$560



FEATURES AND BENEFITS

1-Hole Pull-Down
Flow Rate: 1.75 gpm
Spray Function: Toggle
Spray Type: Full & Needle
Spout Swivel Range: 360°
Cartridge: 35mm Ceramic
Check Valve: Integrated Double
Countertop Hole Diameter: 1 3/8"
Weight: 10 lbs.

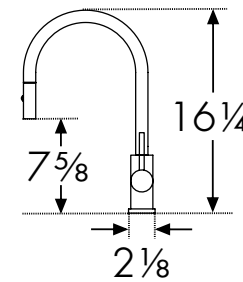

FFT3350

FFT3350  Stainless Steel

\$450



FEATURES AND BENEFITS

3 in 1 Hot/Cold/Filtered Cold
Flow Rate: 1.75 gpm/0.5 gpm
Spray Type: Full & Stream
Spout Swivel Range: 360°
Cartridge: 35mm Ceramic
Countertop Hole Diameter: 1 3/8"
Weight: 7 lbs.

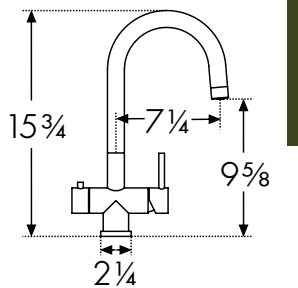

Note: Filter is not included. Please reference pages 274-280 for filtration options.



FFPD3350

Available Spring 2019

FFPD3350  Stainless Steel

\$530



FEATURES AND BENEFITS

1-Hole Pull-Down, 2 Handle
Flow Rate: 1.75 gpm
Spray Function: Toggle
Spray Type: Full & Needle
Spout Swivel Range: 360°
Cartridge: 1/2" Ceramic
Check Valve: Integrated Double
Countertop Hole Diameter: 1 3/8"
Weight: 8 lbs.

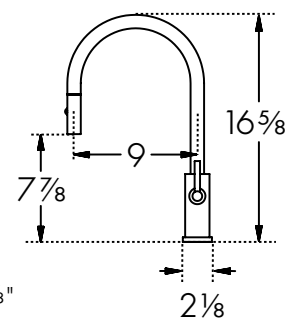

FFP3350

FFP3350  Stainless Steel

\$530



FEATURES AND BENEFITS

1-Hole Prep
Flow Rate: 1.75 gpm
Spray Function: Toggle
Spray Type: Full & Needle
Spout Swivel Range: 360°
Cartridge: 35mm Ceramic
Countertop Hole Diameter: 1 3/8"
Weight: 10 lbs.

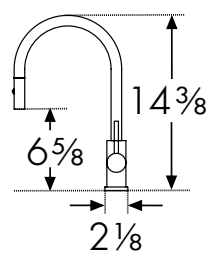

Indicates:  Cold  Hot  Hot/Cold

Faucet supply lines are U.S. standard 3/8" O.D. All faucets can accommodate at least 1 3/4" countertop thickness. Several can accommodate up to 3". Call for additional thickness.

Faucet supply lines are U.S. standard 3/8" O.D. All faucets can accommodate at least 1 3/4" countertop thickness. Several can accommodate up to 3". Call for additional thickness.



Home
Faucets

Pictured: FFPD20400 faucet

HOME FAUCET COLLECTION

The Home Collection brings together a full range of pull-out and pull-down faucet styles and sizes to give your kitchen function and flair. All models include an optional baseplate, offering an added choice for your faucet's look.

DESIGN PLUS PERFORMANCE



Home
Faucets

BEAUTIFUL & DURABLE
The stainless steel faucets in Franke's Fast-In Collection are beautiful and durable, made with the superior quality, craftsmanship and performance you expect from the Franke brand. In addition, **installation is a breeze** - the faucets attach to the sink above the countertop in a few quick steps.



BERN PRO
FFPD20850

FFPD20850 ■ Stainless Steel **\$620**

○ Optional Baseplate Included



FEATURES AND BENEFITS

1-Hole Pull-Down Semi-Pro
Flow Rate: 1.75 gpm
Spray Function: Toggle
Spray Type: Full & Needle
Spout Swivel Range: 360°
Cartridge: 35mm Ceramic
Check Valve: Integrated Double
Countertop Hole Diameter: 1 3/8"
Weight: 8 lbs.

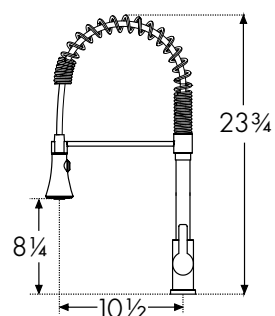

FUJI
FFPD20400

FFPD20400 ■ Polished Chrome **\$465**

FFPD20480 ■ Satin Nickel **\$520**

○ Optional Baseplate Included



FEATURES AND BENEFITS

1-Hole Pull-Down Semi-Pro
Flow Rate: 1.75 gpm
Spray Function: Toggle
Spray Type: Full & Needle
Spout Swivel Range: 360°
Cartridge: 35mm Ceramic
Check Valve: Integrated Double
Countertop Hole Diameter: 1 3/8"
Weight: 8 lbs.

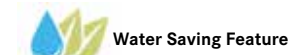
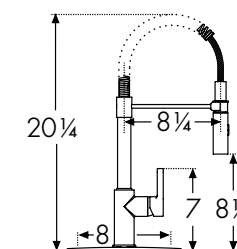

BERN
FF20750

FF20750 ■ Stainless Steel **\$505**

○ Optional Baseplate Included



FEATURES AND BENEFITS

1-Hole Pull-Down
Flow Rate: 1.75 gpm
Spray Function: Toggle
Spray Type: Full & Needle
Spout Swivel Range: 360°
Cartridge: 35mm Ceramic
Check Valve: Integrated Double
Countertop Hole Diameter: 1 3/8"
Weight: 8 lbs.

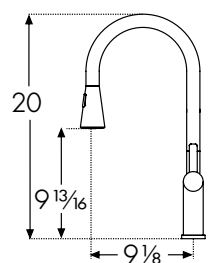

ETHOS
FF5700

Available Spring 2019

FF5700 ■ Polished Chrome **\$495**

FF5720 ■ Matte Black **\$565**

FF5780 ■ Satin Nickel **\$565**

○ Optional Baseplate Included



FEATURES AND BENEFITS

1-Hole Pull-Down
Flow Rate: 1.75 gpm
Spray Function: Toggle
Spray Type: Full & Needle
Spout Swivel Range: 360°
Cartridge: 35mm Ceramic
Check Valve: Integrated Double
Countertop Hole Diameter: 1 3/8"
Weight: 6 lbs.

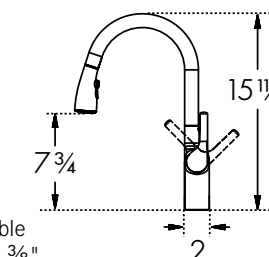

BERNARD
FFPS20550

FFPS20550 ■ Stainless Steel **\$540**

○ Optional Baseplate Included



FEATURES AND BENEFITS

1-Hole Pull-Out
Flow Rate: 1.75 gpm
Spray Function: Toggle
Spray Type: Full & Needle
Spout Swivel Range: 110°
Cartridge: 35mm Ceramic
Check Valve: Integrated Double
Countertop Hole Diameter: 1 3/8"
Weight: 7 lbs.

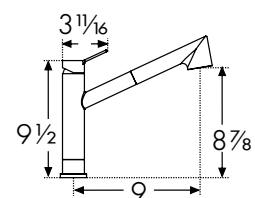

RIGO
FF20300

FF20300 ■ Polished Chrome **\$385**

FF20380 ■ Satin Nickel **\$440**

○ Optional Baseplate Included



FEATURES AND BENEFITS

1-Hole Pull-Down
Flow Rate: 1.75 gpm
Spray Function: Toggle
Spray Type: Full & Needle
Spout Swivel Range: 360°
Cartridge: 35mm Ceramic
Check Valve: Integrated Double
Countertop Hole Diameter: 1 3/8"
Weight: 6 lbs.

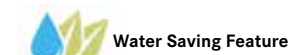
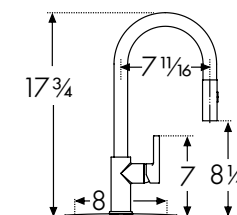

BERNADINE
FF20650

FF20650 ■ Stainless Steel **\$460**

○ Optional Baseplate Included



FEATURES AND BENEFITS

1-Hole Pull-Down
Flow Rate: 1.75 gpm
Spray Function: Toggle
Spray Type: Full & Needle
Spout Swivel Range: 360°
Cartridge: 35mm Ceramic
Check Valve: Integrated Double
Countertop Hole Diameter: 1 3/8"
Weight: 8 lbs.

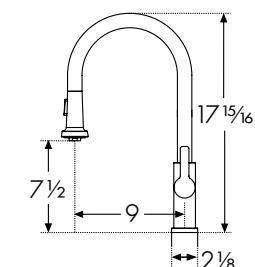

SION
FFPS20200

FFPS20200 ■ Polished Chrome **\$365**

FFPS20280 ■ Satin Nickel **\$415**

○ Optional Baseplate Included



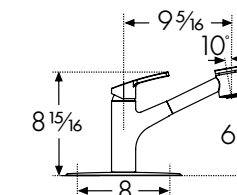

FEATURES AND BENEFITS

1-Hole Pull-Out
Flow Rate: 1.75 gpm
Spray Function: Toggle
Spray Type: Full & Needle
Spout Swivel Range: 110°
Cartridge: 35mm Ceramic
Check Valve: Integrated Double
Countertop Hole Diameter: 1 3/8"
Weight: 7 lbs.



VALAIS
FFPS20100

FFPS20100  Polished Chrome \$325
FFPS20180  Satin Nickel \$375

 Optional Baseplate Included



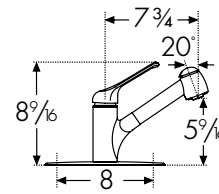

FEATURES
AND BENEFITS

1-Hole Pull-Out
Flow Rate: 1.75 gpm
Spray Function: Toggle
Spray Type: Full & Needle
Spout Swivel Range: 110°
Cartridge: 35mm Ceramic
Check Valve: Integrated Double
Countertop Hole Diameter: 1 3/8"
Weight: 6 lbs.



VESTA
FFPS20000

FFPS20000  Polished Chrome \$270
FFPS20080  Satin Nickel \$310

 Optional Baseplate Included



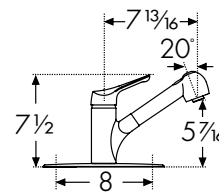

FEATURES
AND BENEFITS

1-Hole Pull-Out
Flow Rate: 1.75 gpm
Spray Function: Toggle
Spray Type: Full & Needle
Spout Swivel Range: 110°
Cartridge: 35mm Ceramic
Check Valve: Integrated Double
Countertop Hole Diameter: 1 3/8"
Weight: 5 lbs.



ANTERO
NEW FF22300

Available Spring 2019

FF22300  Polished Chrome \$295
FF22380  Satin Nickel \$325

 Optional Baseplate Included



FEATURES
AND BENEFITS

1-Hole Pull-Down
Flow Rate: 1.75 gpm
Spray Function: Locking
Spray Type: Full & Needle
Spout Swivel Range: 360°
Cartridge: 35mm Ceramic
Check Valve: Integrated Double
Countertop Hole Diameter: 1 3/8"
Weight: 6 lbs.

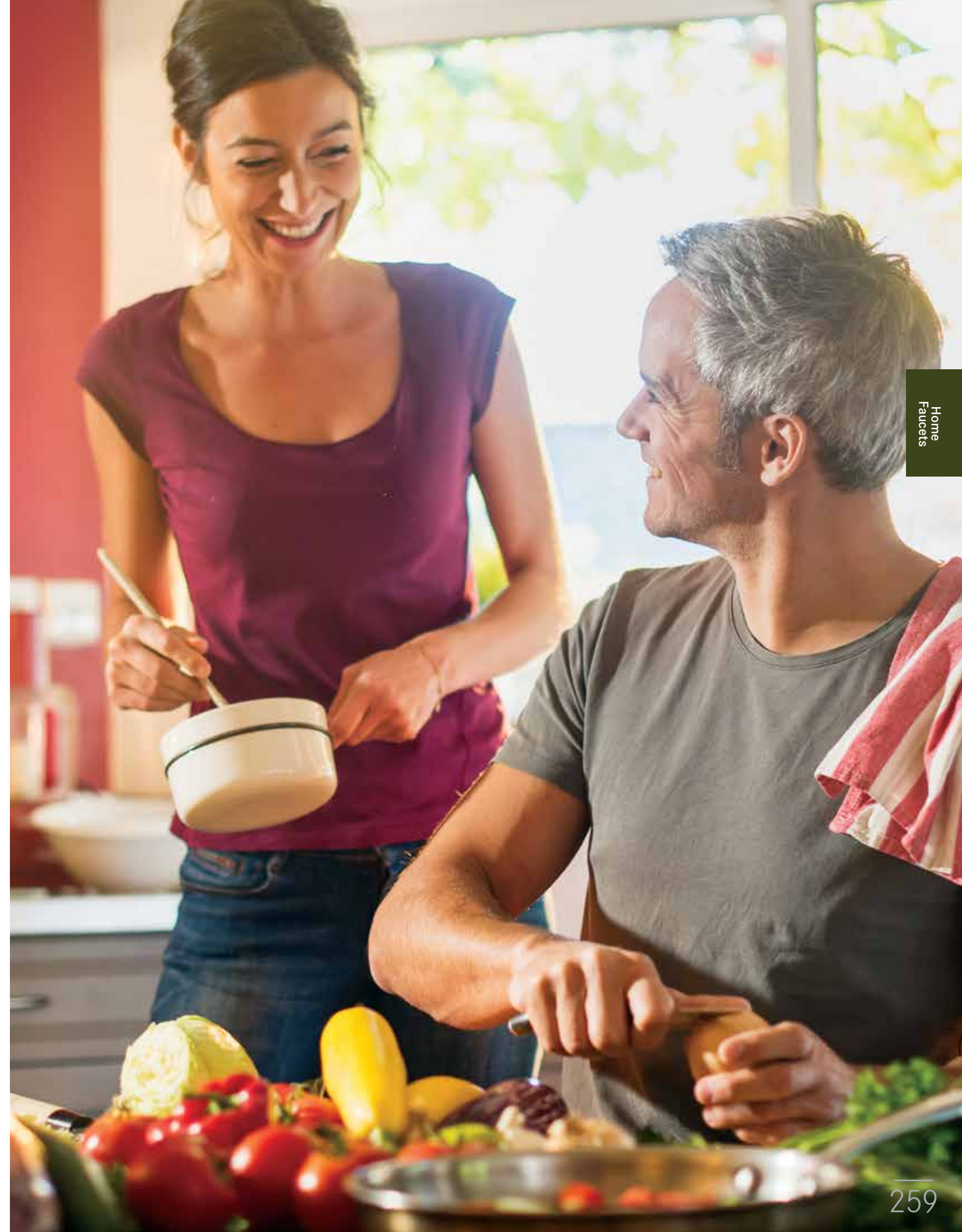
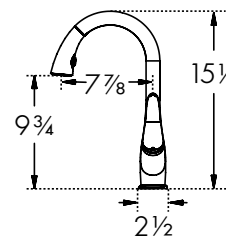

Home
Faucets

EVERY DROP IS WONDERFUL

Franke pioneered multi-tasking kitchen faucets. Today, our beautifully designed range of point-of-use faucets, which dispense hot, cold and filtered water, are considered the blueprint for faucets that go the extra step. By combining the beauty of our most stylish designs and the technologically advanced ceramic water filtration of the Franke StillPure system, we've created the perfect addition to a health-focused kitchen.



PURE WATER, WHERE YOU NEED IT.

Invisible to the eye and even to the tongue, contaminants, lead, toxins, industrial pollutants, pesticides and even diseases are passed through local water systems into our homes. Unfortunately, filtration pitchers don't fully filter out impurities, and bottled water creates waste. Franke StillPure delivers **delicious, pure water right from the tap.**

STYLED FOR CONVENIENCE.

With the Franke **StillPure filtration** system you can choose from a full range of faucet designs to fit your style. If under-sink space is at a premium, the new **Purus filtration faucets** feature patented triple-filter process technology and a modern capsule-style design.

With the new StillPure **Full-Flow filter**, every drop of water from your faucet will be clean and pure for drinking, cooking and cleaning.

CONFIDENCE TO KNOW IT'S PURE.

Using Bluetooth® connectivity, the StillPure **filter-monitoring device** sends usage data, notifications for upcoming filter changes and even one-click ordering so new filters can be delivered directly to your door. All you need to do is download the StillPure app, which is available for Androids and iPhones.



Point-of-Use Filtration Faucet



Undercounter Water Filter



Full Flow Filter



Above Counter Water Filter



Water Chiller



Monitor Usage



Filtration

CUBE
FFT3350

FFT3350 ■ Stainless Steel \$450



FEATURES AND BENEFITS

3 in 1 Hot/Cold/Filtered Cold
Flow Rate: 1.75 gpm/0.5 gpm
Spray Type: Full & Stream
Spout Swivel Range: 360°
Cartridge: 35mm Ceramic
Countertop Hole Diameter: 1 3/8"
Weight: 7 lbs.

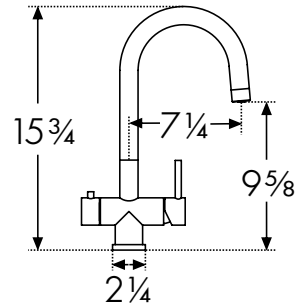

Note: Filter is not included. Please reference pages 274-280 for filtration options.

AMBIENT
FFT3100

FFT3100 ■ Polished Chrome \$425
FFT3170 ■ Polished Nickel \$525
FFT3180 ■ Satin Nickel \$525



FEATURES AND BENEFITS

3 in 1 Hot/Cold/Filtered Cold
Flow Rate: 1.75 gpm/0.5 gpm
Spray Type: Full & Stream
Spout Swivel Range: 360°
Cartridge: 28mm Ceramic
Countertop Hole Diameter: 1 3/8"
Weight: 6 lbs.

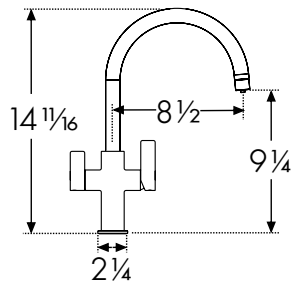

Note: Filter is not included. Please reference pages 274-280 for filtration options.

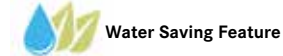

ABSINTHE
FFT5200

FFT5200 ■ Polished Chrome \$515
FFT5220 ■ Matte Black \$615
FFT5270 ■ Polished Nickel \$615
FFT5280 ■ Satin Nickel \$615



FEATURES AND BENEFITS

3 in 1 Hot/Cold/Filtered Cold
Flow Rate: 1.75 gpm/0.5 gpm
Spray Type: Full & Stream
Spout Swivel Range: 360°
Cartridge: 28mm Ceramic
Countertop Hole Diameter: 1 3/8"
Weight: 10 lbs.

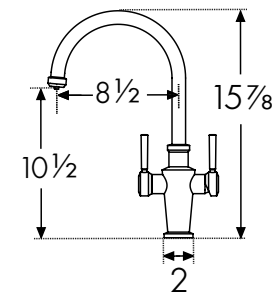

Note: Filter is not included. Please reference pages 274-280 for filtration options.

PURUS
FFPD5600

Available Spring 2019
FFPD5600 ■ Chrome/Gun Metal \$895
FFPD5620 ■ Black/Satin Nickel \$995



FEATURES AND BENEFITS

1-Hole Semi-Pro & Point-of-Use
Flow Rate: 1.75 & .9 gpm
Spray Function: Toggle
Spray Type: Full & Needle
Spout Swivel Range: 360°
Cartridge: 35mm & 1/2" Ceramic
Check Valve: Integrated Double
Countertop Hole Diameter: 1 3/8"
Weight: 11 lbs.

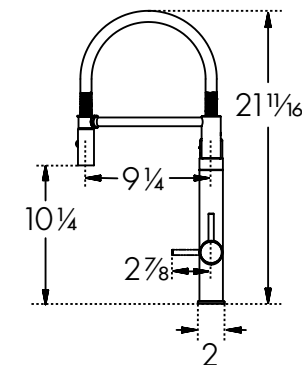

Note: Filter is not included. Please reference pages 274-280 for filtration options.



PURUS
NEW DW5600

Available Spring 2019
DW5600 ■ Chrome/Gun Metal \$375
DW5620 ■ Black/Satin Nickel \$425



FEATURES AND BENEFITS

1-Hole Point-of-Use
Flow Rate: .9 gpm
Spray Type: Full
Spout Swivel Range: 360°
Cartridge: 1/2" Ceramic
Check Valve: Integrated
Countertop Hole Diameter: 1"
Weight: 6 lbs.

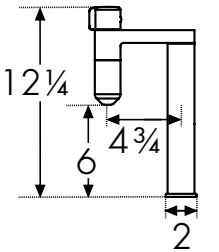

FARM HOUSE
DW6100C

DW6100C ■ Polished Chrome \$395
DW6170C ■ Polished Nickel \$480
DW6180C ■ Satin Nickel \$480



FEATURES AND BENEFITS

The Little Butler® Cold Filtered
Flow Rate: 0.5 gpm
Spray Type: Stream
Spout Swivel Range: 360°
Cartridge: 3/8" Ceramic
Countertop Hole Diameter: 1 3/8"
Weight: 3 lbs.

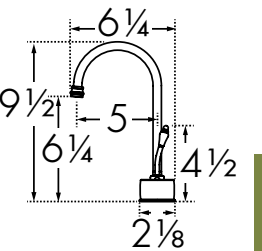

FARM HOUSE
LB6100C

LB6100C ■ Polished Chrome \$395
LB6170C ■ Polished Nickel \$480
LB6180C ■ Satin Nickel \$480



FEATURES AND BENEFITS

The Little Butler® Hot Filtered
Flow Rate: 0.5 gpm
Spray Type: Stream
Spout Swivel Range: 360°
Cartridge: 3/8" Ceramic
Countertop Hole Diameter: 1 3/8"
Weight: 3 lbs.

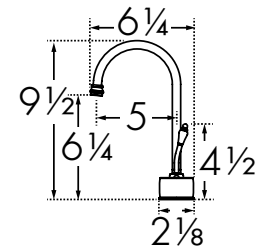

FARM HOUSE
LB6200C

LB6200C ■ Polished Chrome \$545
LB6270C ■ Polished Nickel \$655
LB6280C ■ Satin Nickel \$655



FEATURES AND BENEFITS

The Little Butler® Hot/Cold Filtered
Flow Rate: 0.5 gpm
Spray Type: Stream
Spout Swivel Range: 360°
Cartridge: 3/8" Ceramic
Countertop Hole Diameter: 1 3/8"
Weight: 3 lbs.

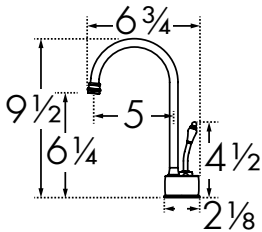

FARM HOUSE
DW12000

- DW12000  Polished Chrome \$420
- DW12080  Satin Nickel \$495



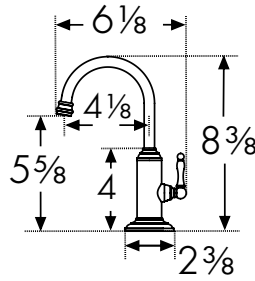

FEATURES
AND BENEFITS

The Little Butler® Cold Filtered
Flow Rate: 0.5 gpm
Spray Type: Stream
Spout Swivel Range: 360°
Cartridge: 3/8" Ceramic
Countertop Hole Diameter: 1 1/4"
Weight: 2 lbs.



FARM HOUSE
LB12100

- LB12100  Polished Chrome \$420
- LB12180  Satin Nickel \$495



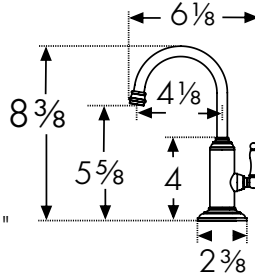

FEATURES
AND BENEFITS

The Little Butler® Hot Filtered
Flow Rate: 0.5 gpm
Spray Type: Stream
Spout Swivel Range: 360°
Cartridge: 3/8" Ceramic
Countertop Hole Diameter: 1 1/4"
Weight: 3 lbs.



FARM HOUSE
LB12200

- LB12200  Polished Chrome \$525
- LB12280  Satin Nickel \$635



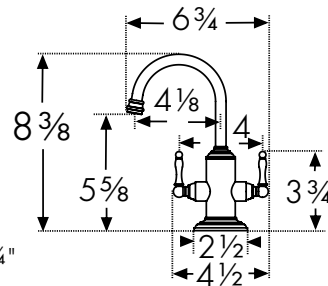

FEATURES
AND BENEFITS

The Little Butler® Hot/Cold Filtered
Flow Rate: 0.5 gpm
Spray Type: Stream
Spout Swivel Range: 360°
Cartridge: 3/8" Ceramic
Countertop Hole Diameter: 1 1/4"
Weight: 4 lbs.



Indicates:  Cold  Hot  Hot/Cold

LOGIK
DW9000C

- DW9000C  Polished Chrome \$385
- DW9070C  Polished Nickel \$470
- DW9080C  Satin Nickel \$470



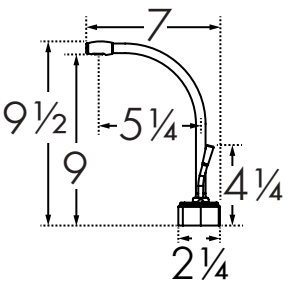

FEATURES
AND BENEFITS

The Little Butler® Cold Filtered
Flow Rate: 0.5 gpm
Spray Function: Stream
Spout Swivel Range: 360°
Cartridge: 3/8" Ceramic
Countertop Hole Diameter: 1 3/8"
Weight: 3 lbs.





LOGIK VALUE OFFER
DW9000C-100

- DW9000C-100  Polished Chrome \$535
- DW9080C-100  Satin Nickel \$615



Includes: DW9000C Little Butler® cold water faucet with FRCNSTR100 filtration canister and FM100 filter monitoring device.
Weight: 7 lbs.

LOGIK
LB9100C

- LB9100C  Polished Chrome \$385
- LB9170C  Polished Nickel \$470
- LB9180C  Satin Nickel \$470



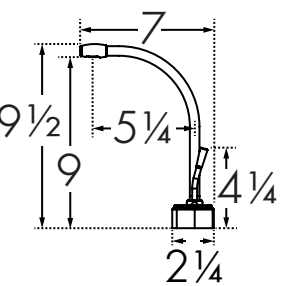

FEATURES
AND BENEFITS

The Little Butler® Hot Filtered
Flow Rate: 0.5 gpm
Spray Type: Stream
Spout Swivel Range: 360°
Cartridge: 3/8" Ceramic
Countertop Hole Diameter: 1 3/8"
Weight: 3 lbs.



LOGIK VALUE OFFER
LB9100C-110-HT

- LB9100C-110-HT  Polished Chrome \$900
- LB9180C-110-HT  Satin Nickel \$975

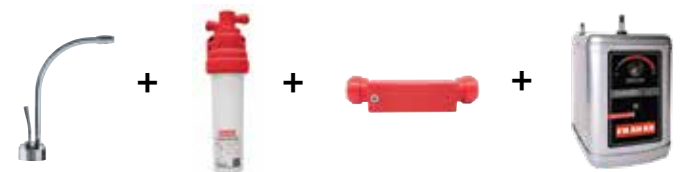

Includes: LB9100C Little Butler® hot water faucet with FRCNSTR110 filtration canister, FM100 filter monitoring device and the HT300 Little Butler Heating Tank.
Weight: 16 lbs.

Indicates:  Cold  Hot  Hot/Cold

All faucets can accommodate at least 1-3/4" countertop thickness. Several can accommodate up to 3". Call for additional thicknesses. Recommended Pressure Range: 15-75 PSI. All Franke filtration faucets have been certified to comply with NSF61 and NSF372 drinking water system component requirements. These requirements meet California Health and Safety Code requirements for low lead (AB1953) as well as the low lead requirements of the US Safe Drinking Water Act. Franke faucets also meet the water efficiency requirements of the California Energy Commission and the US Department of Energy.

All faucets can accommodate at least 1-3/4" countertop thickness. Several can accommodate up to 3". Call for additional thicknesses. Recommended Pressure Range: 15-75 PSI. All Franke filtration faucets have been certified to comply with NSF61 and NSF372 drinking water system component requirements. These requirements meet California Health and Safety Code requirements for low lead (AB1953) as well as the low lead requirements of the US Safe Drinking Water Act. Franke faucets also meet the water efficiency requirements of the California Energy Commission and the US Department of Energy.

LOGIK
LB9200C

- LB9200C Polished Chrome \$ 535
- LB9270C Polished Nickel \$ 635
- LB9280C Satin Nickel \$ 635



FEATURES AND BENEFITS

The Little Butler® Hot/Cold Filtered
Flow Rate: 0.5 gpm
Spray Type: Stream
Spout Swivel Range: 360°
Cartridge: 3/8" Ceramic
Countertop Hole Diameter: 1 3/8"
Weight: 3 lbs.

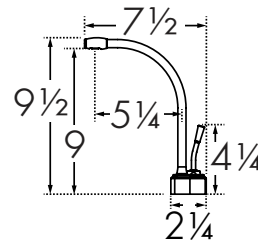

LOGIK VALUE OFFER
LB9200C-100-HT

- LB9200C-100-HT Polished Chrome \$1,025
- LB9280C-100-HT Satin Nickel \$1,125

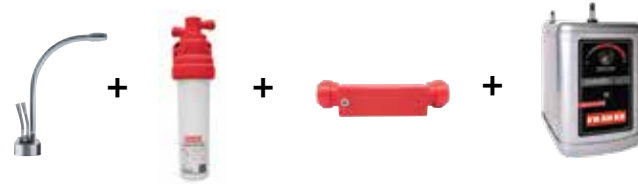

Includes: LB9200C Little Butler® hot/cold water faucet with FRCNSTR100 filtration canister, FM100 filter monitoring device and the HT300 Little Butler Heating Tank.
Weight: 16 lbs.

ABSINTHE
DW15000

- DW15000 Polished Chrome \$ 430
- DW15020 Matte Black \$ 505
- DW15070 Polished Nickel \$ 505
- DW15080 Satin Nickel \$ 505



FEATURES AND BENEFITS

The Little Butler® Cold Filtered
Flow Rate: 0.5
Spray Type: Stream
Spout Swivel Range: 360°
Cartridge: 3/8" Ceramic
Countertop Hole Diameter: 1 1/4"
Weight: 3 lbs.

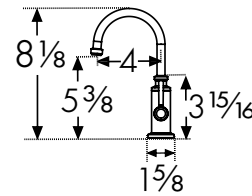

ABSINTHE
LB15100

- LB15100 Polished Chrome \$ 420
- LB15120 Matte Black \$ 495
- LB15170 Polished Nickel \$ 495
- LB15180 Satin Nickel \$ 495



FEATURES AND BENEFITS

The Little Butler® Hot Filtered
Flow Rate: 0.5
Spray Type: Stream
Spout Swivel Range: 360°
Cartridge: 3/8" Ceramic
Countertop Hole Diameter: 1 1/4"
Weight: 3 lbs.

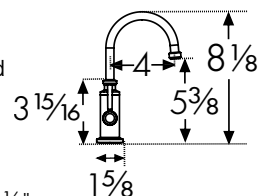

Indicates: Cold Hot Hot/Cold

ABSINTHE
LB15200

- LB15200 Polished Chrome \$525
- LB15220 Matte Black \$635
- LB15270 Polished Nickel \$635
- LB15280 Satin Nickel \$635



FEATURES AND BENEFITS

The Little Butler® Hot/Cold Filtered
Flow Rate: 0.5
Spray Type: Stream
Spout Swivel Range: 360°
Cartridge: 3/8" Ceramic
Countertop Hole Diameter: 1 1/4"
Weight: 3 lbs.

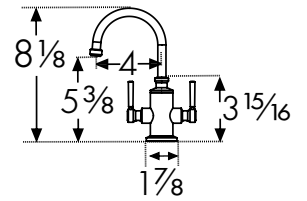

PESCARA
DW16000

- DW16000 Polished Chrome \$420
- DW16080 Satin Nickel \$495
- NEW** Available Spring 2019
- DW16020 Matte Black \$495
- DW16022 Shiny Black \$495
- DW16040 Gun Metal \$495
- DW16061 Copper \$495
- DW16065 Bronze \$495
- DW16070 Polished Nickel \$495
- DW16090 Satin Brass \$495



FEATURES AND BENEFITS

The Little Butler® Cold Filtered
Flow Rate: 0.5
Spray Type: Stream
Spout Swivel Range: 360°
Cartridge: 3/8" Ceramic
Countertop Hole Diameter: 1 1/4"
Weight: 3 lbs.

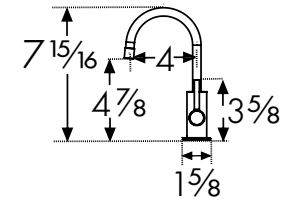

PESCARA
LB16100

- LB16100 Polished Chrome \$430
- LB16180 Satin Nickel \$505
- NEW** Available Spring 2019
- LB16120 Matte Black \$505
- LB16122 Shiny Black \$505
- LB16140 Gun Metal \$505
- LB16161 Copper \$505
- LB16165 Bronze \$505
- LB16170 Polished Nickel \$505
- LB16190 Satin Brass \$505



FEATURES AND BENEFITS

The Little Butler® Hot Filtered
Flow Rate: 0.5
Spray Type: Stream
Spout Swivel Range: 360°
Cartridge: 3/8" Ceramic
Countertop Hole Diameter: 1 1/4"
Weight: 3 lbs.

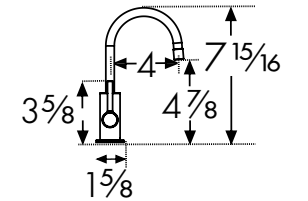

Indicates: Cold Hot Hot/Cold

All faucets can accommodate at least 1-3/4" countertop thickness. Several can accommodate up to 3". Call for additional thicknesses. Recommended Pressure Range: 15-75 PSI. All Franke filtration faucets have been certified to comply with NSF61 and NSF372 drinking water system component requirements. These requirements meet California Health and Safety Code requirements for low lead (AB1953) as well as the low lead requirements of the US Safe Drinking Water Act. Franke faucets also meet the water efficiency requirements of the California Energy Commission and the US Department of Energy.

All faucets can accommodate at least 1-3/4" countertop thickness. Several can accommodate up to 3". Call for additional thicknesses. Recommended Pressure Range: 15-75 PSI. All Franke filtration faucets have been certified to comply with NSF61 and NSF372 drinking water system component requirements. These requirements meet California Health and Safety Code requirements for low lead (AB1953) as well as the low lead requirements of the US Safe Drinking Water Act. Franke faucets also meet the water efficiency requirements of the California Energy Commission and the US Department of Energy.

PESCARA
LB16200

- LB16200  Polished Chrome \$525
- LB16280  Satin Nickel \$635
- NEW** Available Spring 2019
- LB16220  Matte Black \$635
- LB16222  Shiny Black \$635
- LB16240  Gun Metal \$635
- LB16261  Copper \$635
- LB16265  Bronze \$635
- LB16270  Polished Nickel \$635
- LB16290  Satin Brass \$635



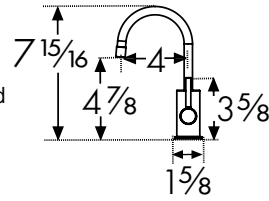

FEATURES AND BENEFITS

The Little Butler® Hot/Cold Filtered
Flow Rate: 0.5
Spray Type: Stream
Spout Swivel Range: 360°
Cartridge: 3/8" Ceramic
Countertop Hole Diameter: 1 1/4"
Weight: 3 lbs.



AMBIENT
LB7100C

- LB7100C  Polished Chrome \$395
- LB7170C  Polished Nickel \$480
- LB7180C  Satin Nickel \$480



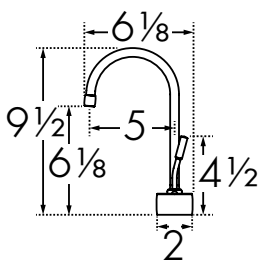

FEATURES AND BENEFITS

The Little Butler® Hot Filtered
Flow Rate: 0.5 gpm
Spray Type: Stream
Spout Swivel Range: 360°
Cartridge: 3/8" Ceramic
Countertop Hole Diameter: 1 3/8"
Weight: 3 lbs.





AMBIENT VALUE OFFER
LB7100C-110-HT

- LB7100C-110-HT  Polished Chrome \$915
- LB7180C-110-HT  Satin Nickel \$980



Includes: LB7100C Little Butler® hot water faucet with FRCNSTR110 filtration canister, FM100 filter monitoring device and the HT300 Little Butler Heating Tank.
Weight: 16 lbs.

AMBIENT
DW7000C

- DW7000C  Polished Chrome \$395
- DW7070C  Polished Nickel \$480
- DW7080C  Satin Nickel \$480



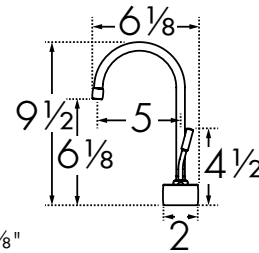

FEATURES AND BENEFITS

The Little Butler® Cold Filtered
Flow Rate: 0.5 gpm
Spray Type: Stream
Spout Swivel Range: 360°
Cartridge: 3/8" Ceramic
Countertop Hole Diameter: 1 3/8"
Weight: 3 lbs.





AMBIENT VALUE OFFER
DW7000C-100

- DW7000C-100  Polished Chrome \$550
- DW7080C-100  Satin Nickel \$615



Includes: DW7000C Little Butler® cold water faucet with FRCNSTR100 filtration canister and FM100 filter monitoring device.
Weight: 7 lbs.

AMBIENT
LB7200C

- LB7200C  Polished Chrome \$545
- LB7270C  Polished Nickel \$655
- LB7280C  Satin Nickel \$655



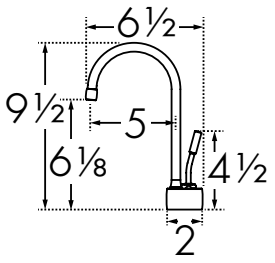

FEATURES AND BENEFITS

The Little Butler® Hot/Cold Filtered
Flow Rate: 0.5 gpm
Spray Type: Stream
Spout Swivel Range: 360°
Cartridge: 3/8" Ceramic
Countertop Hole Diameter: 1 3/8"
Weight: 3 lbs.



AMBIENT VALUE OFFER
LB7200C-100-HT

- LB7200C-100-HT  Polished Chrome \$1,025
- LB7280C-100-HT  Satin Nickel \$1,125

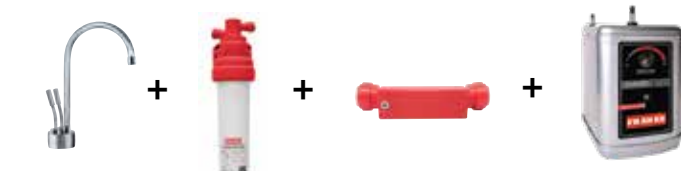

Includes: LB7200C Little Butler® hot/cold water faucet with FRCNSTR100 filtration canister, FM100 filter monitoring device and the HT300 Little Butler Heating Tank.
Weight: 16 lbs.

Indicates:  Cold  Hot  Hot/Cold

Indicates:  Cold  Hot  Hot/Cold

All faucets can accommodate at least 1-3/4" countertop thickness. Several can accommodate up to 3". Call for additional thicknesses. Recommended Pressure Range: 15-75 PSI. All Franke filtration faucets have been certified to comply with NSF61 and NSF372 drinking water system component requirements. These requirements meet California Health and Safety Code requirements for low lead (AB1953) as well as the low lead requirements of the US Safe Drinking Water Act. Franke faucets also meet the water efficiency requirements of the California Energy Commission and the US Department of Energy.

All faucets can accommodate at least 1-3/4" countertop thickness. Several can accommodate up to 3". Call for additional thicknesses. Recommended Pressure Range: 15-75 PSI. All Franke filtration faucets have been certified to comply with NSF61 and NSF372 drinking water system component requirements. These requirements meet California Health and Safety Code requirements for low lead (AB1953) as well as the low lead requirements of the US Safe Drinking Water Act. Franke faucets also meet the water efficiency requirements of the California Energy Commission and the US Department of Energy.

AMBIENT
DW10000

DW10000		Polished Chrome	\$ 420
DW10070		Polished Nickel	\$ 495
DW10080		Satin Nickel	\$ 495



FEATURES AND BENEFITS

The Little Butler®
Cold Filtered
Flow Rate: 0.5 gpm
Spray Type: Stream
Spout Swivel Range: 360°
Cartridge: 3/8" Ceramic
Countertop Hole Diameter: 1 1/4"
Weight: 2 lbs.

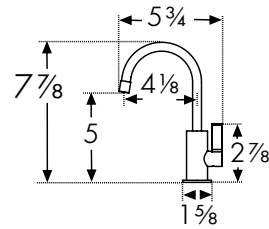

AMBIENT VALUE OFFER
DW10000-100

DW10000-100		Polished Chrome	\$ 565
DW10080-100		Satin Nickel	\$ 630



Includes: DW10000 Little Butler® cold water faucet with FRCNSTR100 filtration canister and FM100 filter monitoring device.
Weight: 6 lbs.

AMBIENT
LB10100

LB10100		Polished Chrome	\$ 420
LB10170		Polished Nickel	\$ 505
LB10180		Satin Nickel	\$ 505



FEATURES AND BENEFITS

The Little Butler®
Hot Filtered
Flow Rate: 0.5 gpm
Spray Type: Stream
Spout Swivel Range: 360°
Cartridge: 3/8" Ceramic
Countertop Hole Diameter: 1 1/4"
Weight: 3 lbs.

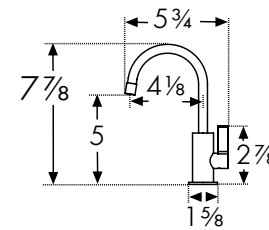

AMBIENT VALUE OFFER
LB10100-110-HT100

LB10100-110-HT100		Polished Chrome	\$ 865
LB10180-110-HT100		Satin Nickel	\$ 935



Includes: LB10100 Little Butler® hot water faucet with FRCNSTR110 filtration canister, FM100 filter monitoring device and the HT100 Little Butler Heating Tank.
Weight: 16 lbs.

AMBIENT VALUE OFFER
LB10100-110-HT

LB10100-110-HT		Polished Chrome	\$ 930
LB10180-110-HT		Satin Nickel	\$1,005



Includes: LB10100 Little Butler® hot water faucet with FRCNSTR110 filtration canister, FM100 filter monitoring device and the HT300 Little Butler Heating Tank.
Weight: 16 lbs.

Indicates: Cold Hot Hot/Cold

All faucets can accommodate at least 1-3/4" countertop thickness. Several can accommodate up to 3". Call for additional thicknesses. Recommended Pressure Range: 15-75 PSI. All Franke filtration faucets have been certified to comply with NSF61 and NSF372 drinking water system component requirements. These requirements meet California Health and Safety Code requirements for low lead (AB1953) as well as the low lead requirements of the US Safe Drinking Water Act. Franke faucets also meet the water efficiency requirements of the California Energy Commission and the US Department of Energy.

AMBIENT
LB10200

LB10200		Polished Chrome	\$ 525
LB10270		Polished Nickel	\$ 635
LB10280		Satin Nickel	\$ 635



FEATURES AND BENEFITS

The Little Butler®
Hot/Cold Filtered
Flow Rate: 0.5 gpm
Spray Type: Stream
Spout Swivel Range: 360°
Cartridge: 3/8" Ceramic
Countertop Hole Diameter: 1 1/4"
Weight: 3 lbs.

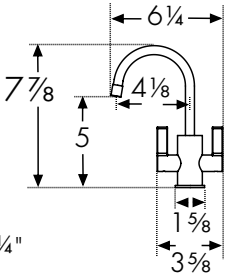

AMBIENT VALUE OFFER
LB10200-100-HT

LB10200-100-HT		Polished Chrome	\$1,020
LB10280-100-HT		Satin Nickel	\$1,115



Includes: LB10200 Little Butler® hot/cold water faucet with FRCNSTR100 filtration canister, FM100 filter monitoring device and the HT300 Little Butler Heating Tank.
Weight: 16 lbs.

STEEL
DW13050

DW13050		Stainless Steel	\$ 435
---------	--	-----------------	--------



FEATURES AND BENEFITS

The Little Butler® Cold Filtered
Flow Rate: 0.5 gpm
Spray Function: Stream
Spout Swivel Range: 360°
Cartridge: 3/8" Ceramic
Countertop Hole Diameter: 1 1/4"
Weight: 3 lbs.

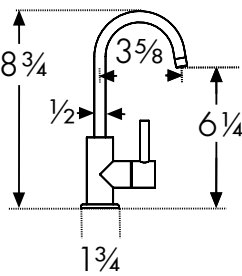

STEEL VALUE OFFER
DW13050-100

DW13050-100		Stainless Steel	\$ 580
-------------	--	-----------------	--------



Includes: DW13050 Little Butler® cold water faucet with FRCNSTR100 filtration canister and FM100 filter monitoring device.
Weight: 7 lbs.

Indicates: Cold Hot Hot/Cold

All faucets can accommodate at least 1-3/4" countertop thickness. Several can accommodate up to 3". Call for additional thicknesses. Recommended Pressure Range: 15-75 PSI. All Franke filtration faucets have been certified to comply with NSF61 and NSF372 drinking water system component requirements. These requirements meet California Health and Safety Code requirements for low lead (AB1953) as well as the low lead requirements of the US Safe Drinking Water Act. Franke faucets also meet the water efficiency requirements of the California Energy Commission and the US Department of Energy.

STEEL
LB13150

DW13150  Stainless Steel \$ 435



FEATURES AND BENEFITS

The Little Butler® Hot Filtered
Flow Rate: 0.5 gpm
Spray Function: Stream
Spout Swivel Range: 360°
Cartridge: 3/8" Ceramic
Countertop Hole Diameter: 1 1/4"
Weight: 3 lbs.

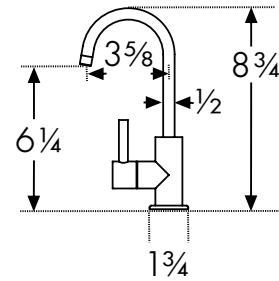

STEEL VALUE OFFER
LB13150-110-HT100

LB13150-110-HT100  Stainless Steel \$ 875



Includes: LB13150 Little Butler® hot water faucet with FRCNSTR110 filtration canister, FM100 filter monitoring device and the HT100 Little Butler Heating Tank.
Weight: 16 lbs.

ORCA
DW14050

DW14050  Stainless Steel \$435



FEATURES AND BENEFITS

The Little Butler® Cold Filtered
Flow Rate: 0.5 gpm
Spray Type: Stream
Spout Swivel Range: 360°
Cartridge: 3/8" Ceramic
Countertop Hole Diameter: 1 1/4"
Weight: 3 lbs.

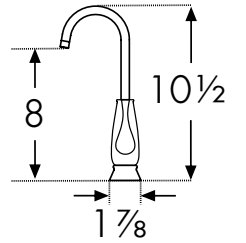

ORCA
LB14150

LB14150  Stainless Steel \$435



FEATURES AND BENEFITS

The Little Butler® Hot Filtered
Flow Rate: 0.5 gpm
Spray Type: Stream
Spout Swivel Range: 360°
Cartridge: 3/8" Ceramic
Countertop Hole Diameter: 1 1/4"
Weight: 4 lbs.

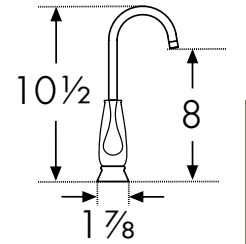

STEEL
LB13250

LB13250  Stainless Steel \$ 535



FEATURES AND BENEFITS

The Little Butler® Hot/Cold Filtered
Flow Rate: 0.5 gpm
Spray Function: Stream
Spout Swivel Range: 360°
Cartridge: 3/8" Ceramic
Countertop Hole Diameter: 1 1/4"
Weight: 4 lbs.

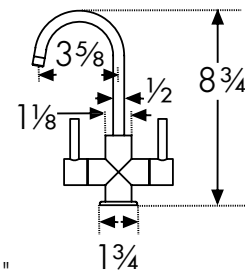

STEEL VALUE OFFER
NEW LB13250-100-HT

LB13250-100-HT  Stainless Steel \$1,025



Includes: LB13250 Little Butler® hot/cold water faucet with FRCNSTR100 filtration canister, FM100 filter monitoring device and the HT300 Little Butler Heating Tank.
Weight: 17 lbs.

ORCA
LB14250

LB14250  Stainless Steel \$535



FEATURES AND BENEFITS

The Little Butler® Hot/Cold Filtered
Flow Rate: 0.5 gpm
Spray Type: Stream
Spout Swivel Range: 360°
Cartridge: 3/8" Ceramic
Countertop Hole Diameter: 1 1/4"
Weight: 4 lbs.

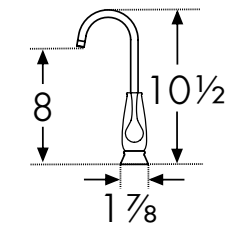

Indicates:  Cold  Hot  Hot/Cold

Indicates:  Cold  Hot  Hot/Cold

All faucets can accommodate at least 1-3/4" countertop thickness. Several can accommodate up to 3". Call for additional thicknesses. Recommended Pressure Range: 15-75 PSI. All Franke filtration faucets have been certified to comply with NSF61 and NSF372 drinking water system component requirements. These requirements meet California Health and Safety Code requirements for low lead (AB1953) as well as the low lead requirements of the US Safe Drinking Water Act. Franke faucets also meet the water efficiency requirements of the California Energy Commission and the US Department of Energy.

All faucets can accommodate at least 1-3/4" countertop thickness. Several can accommodate up to 3". Call for additional thicknesses. Recommended Pressure Range: 15-75 PSI. All Franke filtration faucets have been certified to comply with NSF61 and NSF372 drinking water system component requirements. These requirements meet California Health and Safety Code requirements for low lead (AB1953) as well as the low lead requirements of the US Safe Drinking Water Act. Franke faucets also meet the water efficiency requirements of the California Energy Commission and the US Department of Energy.

HT-100 \$350

The Little Butler® Heating Tank

For use with all Franke hot only and hot/cold filtration faucets.



FEATURES AND BENEFITS

- Heats up to 40 cups per hour close to boiling temperature
- Temperature range with dial, max 190 degrees
- 5/8 gallon stainless steel tank
- 780 Watts
- 1 year warranty
- 9 lbs.
- Compatible with RO water systems

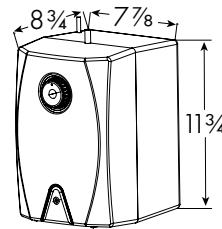

CT-200 \$985

The Little Butler® Chiller

For use with all Franke cold only filtration faucets.



FEATURES AND BENEFITS

- Chills 1 gallon per hour
- Water temperature 40 degrees
- Power: cord, 4 feet, 115 volts, 60 HZ
- 780 Watts
- Stainless steel tank & tubing
- 1 year limited warranty
- 25 lbs.

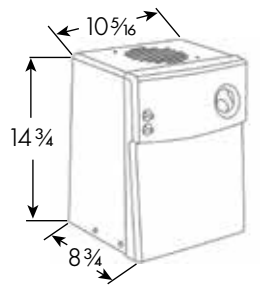

NEW HT-250 \$430

Available Spring 2019

The Little Butler® Heating Tank

For use with all Franke hot only and hot/cold filtration faucets.



FEATURES AND BENEFITS

- Heats up to 40 cups per hour close to boiling temperature
- Temperature range with dial, max 194 degrees
- 5/8 gallon stainless steel tank
- 1300 Watts
- 3 year warranty
- 9 lbs.
- Compatible with RO water systems

NEW CT-400 \$800

Available Summer 2019

The Little Butler® Chiller

For use with all Franke cold only filtration faucets.



FEATURES AND BENEFITS

- Chills 2-3 gallon per hour
- Water temperature 40 degrees
- Power: cord, 4 feet, 115 volts, 60 HZ
- 90 Watts
- Stainless steel tank
- 1 year limited warranty
- 23 lbs.

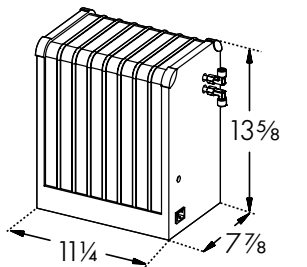

HT-300 \$430

The Little Butler® Heating Tank

For use with all Franke hot only and hot/cold filtration faucets.



FEATURES AND BENEFITS

- Heats up to 60 cups per hour close to boiling temperature
- Temperature range with dial, max 194 degrees
- 5/8 gallon stainless steel tank
- 1300 Watts
- 3 year warranty
- 9 lbs.
- Compatible with RO water systems

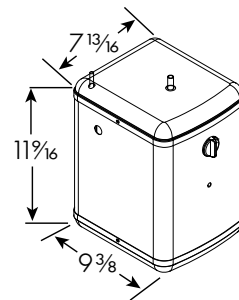

FRCNSTR100 \$199

Filtration Canister

For use with all Franke hot only and hot/cold filtration faucets.



FEATURES AND BENEFITS

- FRC06 filter cartridge included
- Fits FRC06, FRC07, FRC08, FRC09 and FRC10 filters
- Thermoplastic housing
- Built-in shutoff valve
- Integrated installation bracket
- Quick connect 3/8" push fitting
- 10 year warranty
- 3 lbs.

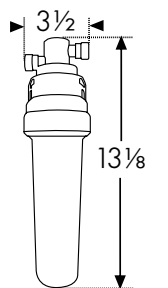

NEW HT-400 \$400

Available Spring 2019

The Little Butler® Heating Tank

For use with all Franke hot only and hot/cold filtration faucets.



FEATURES AND BENEFITS

- Heats up to 60 cups per hour close to boiling temperature
- 8 pre-set temperature settings
- Electronic temperature control, max 208 degrees
- 5/8 gallon stainless steel tank
- 750 Watts
- 3 year warranty
- 8 lbs.
- Compatible with RO water systems

FRCNSTR110 \$209

Filtration Canister

For use with all Franke hot only and hot/cold filtration faucets.



FEATURES AND BENEFITS

- FRC10 filter cartridge included
- Fits FRC06, FRC07, FRC08, FRC09 and FRC10 filters
- Thermoplastic housing
- Built-in shutoff valve
- Integrated installation bracket
- Quick connect 3/8" push fitting
- 10 year warranty
- 3 lbs.

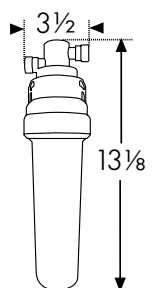

FRCNSTR

\$305

Filtration Canister



FEATURES AND BENEFITS

- FRC06 filter cartridge included
- Fits FRC06, FRC07, FRC08, FRC09 and FRC10 filters
- Solid stainless steel housing
- Easy installation bracket included
- Quick connect 3/8" push fitting
- 5 year warranty
- 4 lbs.



NEW FHFC-100

\$380

Available Spring 2019

Full Flow Filter Canister



FEATURES AND BENEFITS

- FHF-100 1.8 gpm filter cartridge included
- To be used with any kitchen faucet
- Integrated installation bracket
- Quick connect 3/8" push fitting
- 1 year warranty
- 6 lbs.

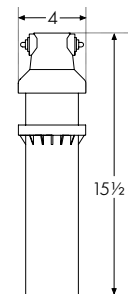

FRCNSTR-DUO-1 \$229

Dual Filtration Canister



FEATURES AND BENEFITS

- FRC06 and FRC09 filters included
- Fits FRC06, FRC07, FRC08, FRC09 and FRC10 filters
- Thermoplastic housing
- Built-in shutoff valve
- Integrated installation bracket
- Quick connect 3/8" push fitting
- 10 year warranty
- 6 lbs.

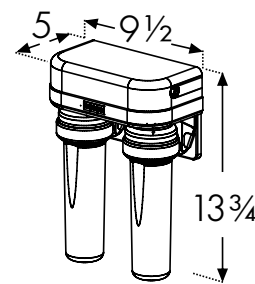

FRCNSTR-DUO-2 \$229

Dual Filtration Canister



FEATURES AND BENEFITS

- FRC07 and FRC09 filters included
- Fits FRC06, FRC07, FRC08, FRC09 and FRC10 filters
- Thermoplastic housing
- Built-in shutoff valve
- Integrated installation bracket
- Quick connect 3/8" push fitting
- 10 year warranty
- 6 lbs.

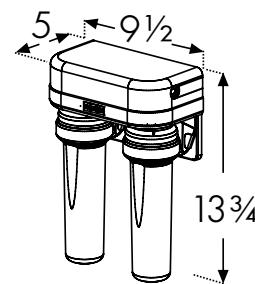

NEW FHF-100

\$280

Available Spring 2019

2.5 gpm Filter



FEATURES AND BENEFITS

- Reduces:
- Chlorine & Chloramine (taste and odor)
 - Particulate & Turbidity
 - Cysts (Cryptosporidium), THMS & VOC's
 - Lead, Rust, Dirt, Sediment & More
 - 10 gal. capacity (1 year)
- See page 277 for performance details

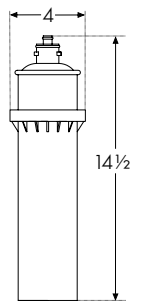

5 lb.

How to determine which filter to order if the replacement filter model number is not identified on the canister:

1. Locate the serial number on your canister
2. If the serial number begins with FR then order the FRX02 filter set
3. If the serial number begins with FRC then order the FRC06, FRC07, FRC08, FRC09, FRC10 filter set

Purification Overview

FILTRATION CRITERIA	PRIMARY FILTERS					PRE-FILTERS		
	FRX02	FRC06	FRC07	FHF-100	SP-FC1	FRC08	FRC09	FRC10
Reduces Chlorine	X	X	X	X	X			
Reduces Chloramine			X	X				
Reduces Particulates and Turbidity*	X	X	X	X	X			
Reduces Cysts (Cryptosporidium)*	X	X	X	X	X			
Reduces Bacteria (E Coli)*	X	X	X					
Reduces Insecticides and Herbicides*	X	X	X					
Reduces Lead	X	X		X				
Reduces Fluoride*						X		
Reduces Sediment*							X	
Reduces Limescale and Hardness*								X

*Claims not verified in California, Iowa or Wisconsin

FRX02 \$ 75
FRX02-2PK \$135

Filter



FEATURES AND BENEFITS

Reduces:
 • Chlorine (taste and odor)
 • Particulate and turbidity
 • Cysts (Cryptosporidium)
 • Lead
 See page 277 for performance details
 1 lb.

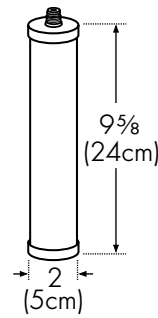

FRC09 \$ 45

Filter



FEATURES AND BENEFITS

Reduces:
 • Sediment
 See page 277 for performance details
 1 lb.

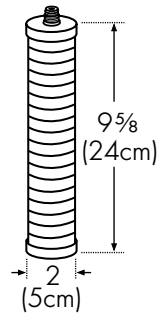

FRC06 \$ 75
FRC06-2PK \$135

Filter



FEATURES AND BENEFITS

Reduces:
 • Chlorine (taste and odor)
 • Particulate and turbidity
 • Cysts (Cryptosporidium)
 • Lead
 See page 277 for performance details
 1 lb.

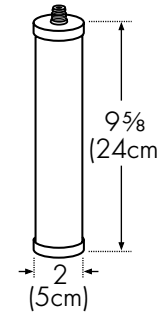

FRC10 \$ 85

Filter



FEATURES AND BENEFITS

• Removes temporary hardness in drinking water
 • Removes Calcium and Magnesium
 • Limescale reduction
 See page 277 for performance details
 1 lb.

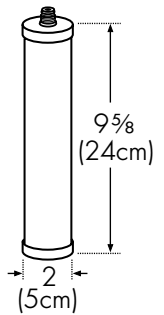

FRC07 \$75

Filter



FEATURES AND BENEFITS

Reduces:
 • Chloramine
 • Chlorine (taste and odor)
 • Particulate and turbidity
 See page 277 for performance details
 1 lb.

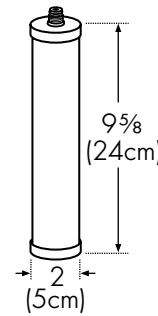

NEW SP-FC1 \$ 59

Available Spring 2019

Purus Filter



FEATURES AND BENEFITS

Reduces:
 • Chlorine & Chloramine (taste and odor)
 • Particulate & Turbidity
 • Cysts (Cryptosporidium), THMS & VOC's
 • Rust, Dirt, Sediment & More
 • Micro plastics
 132 gal. capacity (2 Months)
 See page 277 for performance details
 0.25 lb.

FRC08 \$75

Filter



FEATURES AND BENEFITS

Reduces:
 • Fluoride
 See page 277 for performance details
 1 lb.

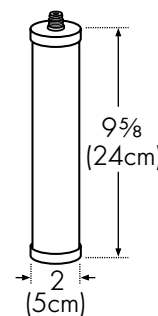

NEW SP-FC3 \$149

Available Spring 2019

3 Pack Purus Filter



FEATURES AND BENEFITS

Reduces:
 • Chlorine & Chloramine (taste and odor)
 • Particulate & Turbidity
 • Cysts (Cryptosporidium), THMS & VOC's
 • Rust, Dirt, Sediment & More
 • Micro plastics
 3 x 132 gal. capacity (6 Months)
 See page 277 for performance details
 0.8 lb.

SB60 \$40

Pressure Protection Valve



FEATURES AND BENEFITS

Flow Rate: 4 gpm @ 100 psi
 Max Pressure: 300 psi
 Max Temperature: 104°F (40°C)
 Type: SB60 limiting valve, 60 psi
 Pipe: ¼" - Inlet/Outlet Quick Connect
 Weight: 1 lb.

FM100 \$45

Filter Monitoring Device



FEATURES AND BENEFITS

- Bluetooth connection to Franke StillPure App on Android or IOS smartphone
- Filter change reminder
- Track dollars saved by not buying bottled water
- Track plastic water bottles saved from landfill
- Ability to reorder filters
- ¾" John Guest connection
- 5 year battery life
- 1 year warranty



For use with all Franke Little Butler® filtration products

Filtration

Filtration





SOAP DISPENSERS



With styles to complement every Franke faucet, our soap dispensers are a must-have for today's busy kitchens. With an easy-to-operate hand pump, cleanliness is always within your reach.



SQUARE
SD-800

SD-800 Polished Chrome \$430
SD-880N Satin Nickel \$530



FEATURES AND BENEFITS

Hole Size: 1 1/8"
Weight: 3 lbs.
Capacity: 16 oz.

Dispenser Head Detail

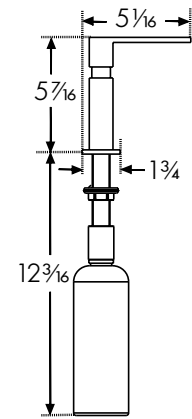
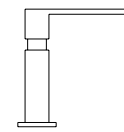

FARM HOUSE
SD6000

SD6000 Polished Chrome \$180
SD6070 Polished Nickel \$210
SD6080 Satin Nickel \$210



FEATURES AND BENEFITS

Hole Size: 1 1/8"
Weight: 1 lb.
Capacity: 12 oz.

Dispenser Head Detail

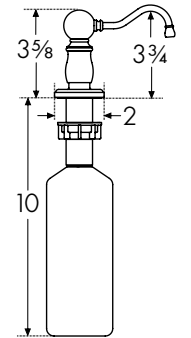
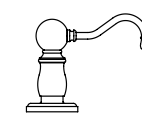

TWIN
SD-500

SD-500 Polished Chrome \$345
SD-580N Satin Nickel \$385



FEATURES AND BENEFITS

Hole Size: 1 1/8"
Weight: 2 lbs.
Capacity: 16 oz.

Dispenser Head Detail

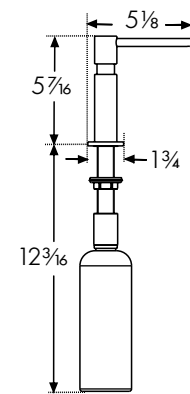
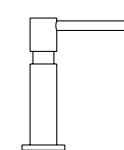

LOGIK
902

902-C Polished Chrome \$180
902-PN Polished Nickel \$240
902-SN Satin Nickel \$215



FEATURES AND BENEFITS

Hole Size: 1 1/8"
Weight: 1 lb.
Capacity: 12 oz.

Dispenser Head Detail

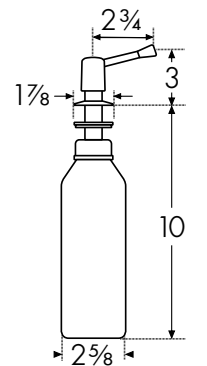
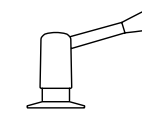

PLANAR 8
SD2600

Available Spring 2019
SD2600 Polished Chrome \$185
SD2680 Satin Nickel \$215



FEATURES AND BENEFITS

Hole Size: 1 1/8"
Weight: 1 lb.
Capacity: 8.5 oz.

Dispenser Head Detail

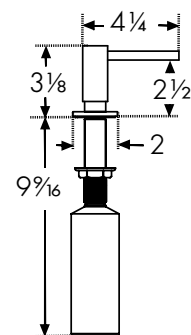
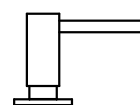

ABSINTHE
SD5200

SD5200 Polished Chrome \$140
SD5220 Matte Black \$170
SD5270 Polished Nickel \$170
SD5280 Satin Nickel \$170



FEATURES AND BENEFITS

Hole Size: 1 1/8"
Weight: 1 lb.
Capacity: 10 oz.

Dispenser Head Detail

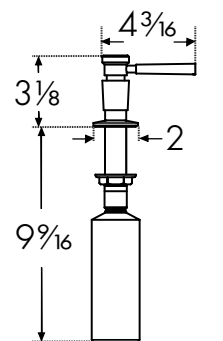
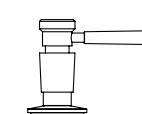

STEEL
SD3450

SD3450 Stainless Steel \$245



FEATURES AND BENEFITS

Hole Size: 1 1/8"
Weight: 1 lb.
Capacity: 10 oz.

Dispenser Head Detail

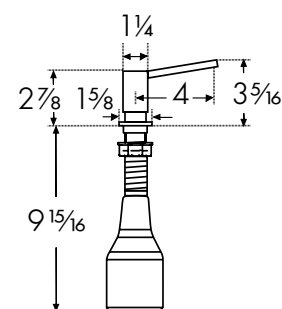
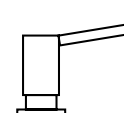

AMBIENT
SD3100

SD3100 Polished Chrome \$120
SD3170 Polished Nickel \$150
SD3180 Satin Nickel \$150



FEATURES AND BENEFITS

Hole Size: 1 1/8"
Weight: 1 lb.
Capacity: 10 oz.

Dispenser Head Detail

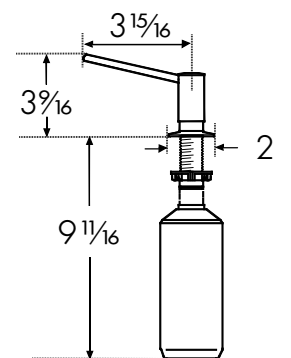
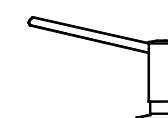

ACTIVE

NEW SD3200

Available Spring 2019

SD3200		Polished Chrome	\$115
SD3201		Onyx	\$145
SD3202		Mocha	\$145
SD3203		Storm	\$145
SD3204		Oyster	\$145
SD3205		Champagne	\$145
SD3206		Vanilla	\$145
SD3207		Shadow Grey	\$145
SD3220		Matte Black	\$145
SD3222		Shiny Black	\$145
SD3240		Gun Metal	\$145
SD3261		Copper	\$145
SD3265		Bronze	\$145
SD3270		Polished Nickel	\$145
SD3280		Satin Nickel	\$145
SD3290		Satin Brass	\$145



FEATURES AND BENEFITS

Hole Size: 1 1/8"
Weight: 1 lb.
Capacity: 10 oz.

Dispenser Head Detail

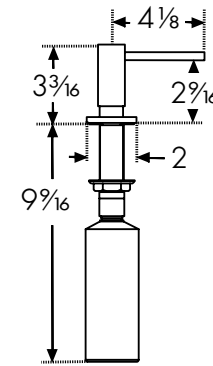
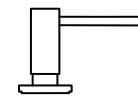

Soap
Dispensers



WASTE DISPOSERS

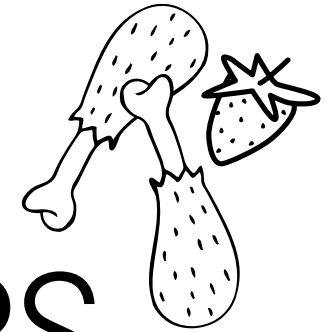

Easily ridding your workspace of organic waste is only one reason waste disposers make good sense for any kitchen. Energy-efficiency, durability and features such as sound bafflers are some of the reasons to make your waste disposer a Franke.

WHAT MAKES FRANKE DISPOSERS DIFFERENT

There's more to keeping your kitchen clean than simply removing waste. Franke integrates the antimicrobial agent Bio Shield® into the disposal's internal components to inhibit the growth of odor-causing bacteria, such as E-coli and salmonella, and mold and mildew. Our Silver Guard®* Magnetic rim prevents metal objects, such as silverware, from falling into the disposer.

*On selected models

SPECIFICATION GUIDE

ITEM	WARRANTY	MOTOR TYPE	POWER CORD	SHREDDER BLADE TYPE	SOUND INSULATED SHELL
FWDJ125 (1 1/4HP)	Limited Lifetime	2800 rpm Jam-Resistant DC motor	Included	Stainless	Yes
FWDJ75B (3/4HP)	10 Years	2700 rpm Jam-Resistant DC motor	Included	Stainless	Yes
FWDJ75 (3/4HP)	10 Years	2700 rpm Jam-Resistant DC motor	Included	Stainless	Yes
FWDJ50 (1/2HP)	5 Years	2600 rpm Jam-Resistant DC motor	Included	Stainless	Yes
WDJ75 (3/4HP)	5 Years	2700 rpm Jam-Resistant DC motor	Included	Galvanized	No
WDJ75NC (3/4HP)	5 Years	2700 rpm Jam-Resistant DC motor	No Cord	Galvanized	No
WDJ50 (1/2HP)	3 Years	2600 rpm Jam-Resistant DC motor	Included	Galvanized	No
WDJ50NC (1/2HP)	3 Years	2600 rpm Jam-Resistant DC motor	No Cord	Galvanized	No
WDJ33 (1/3HP)	2 Years	2400 rpm Jam-Resistant DC motor	Included	Galvanized	No
WDJ33NC (1/3HP)	2 Years	2400 rpm Jam-Resistant DC motor	No Cord	Galvanized	No

Franke waste disposers are  certified Finer grinding for septic system compatibility in ALL models, with no additional chemicals needed.

FWDJ125 \$475

1 1/4 HP Disposer



FEATURES AND BENEFITS

- Horsepower: 1 1/4
- Feed: Continuous
- RPM: 2800
- Silverguard®
- Warranty: Lifetime
- Bio Shield®
- Sound Insulated Shell
- Stainless Steel Grinding Chamber
- Torque Master® Balanced Grinding Systems

19 lbs.

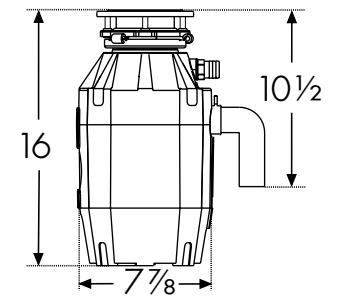

FWDJ75B \$455

3/4 HP Disposer



FEATURES AND BENEFITS

- Horsepower: 3/4
- Feed: Batch
- RPM: 2700
- Warranty: 10 Year
- Bio Shield®
- Sound Insulated Shell
- Stainless Steel Grinding Chamber
- Torque Master® Balanced Grinding Systems

18 lbs.

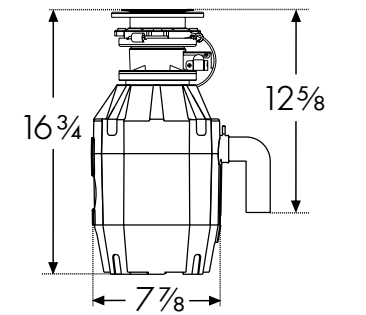

FWDJ75 \$375

3/4 HP Disposer



FEATURES AND BENEFITS

- Horsepower: 3/4
- Feed: Continuous
- RPM: 2700
- Silverguard®
- Warranty: 10 Year
- Bio Shield®
- Sound Insulated Shell
- Stainless Steel Grinding Chamber
- Torque Master® Balanced Grinding Systems

17 lbs.

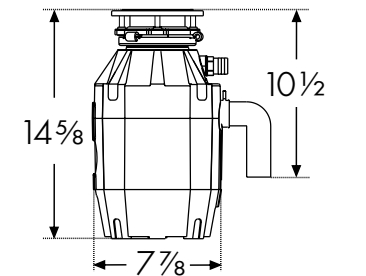

FWDJ50 \$235

1/2 HP Disposer



FEATURES AND BENEFITS

- Horsepower: 1/2
- Feed: Continuous
- RPM: 2600
- Warranty: 5 Year
- Bio Shield®
- Sound Insulated Shell
- Stainless Steel Grinding Chamber
- Torque Master® Balanced Grinding Systems

15 lbs.

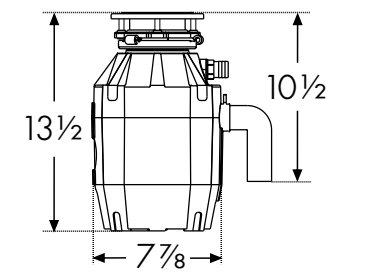

Waste Disposers

Waste Disposers

WDJ75 \$275

¾ HP Disposer



FEATURES AND BENEFITS

- Horsepower: ¾
- Feed: Continuous
- RPM: 2700
- Warranty: 5 Year
- Bio Shield®
- Torque Master® Balanced Grinding Systems

13 lbs.

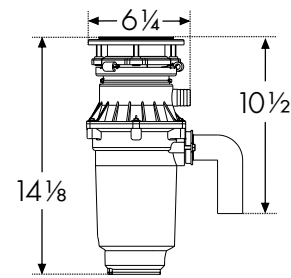

WDJ33 \$165

⅓ HP Disposer



FEATURES AND BENEFITS

- Horsepower: ⅓
- Feed: Continuous
- RPM: 2400
- Warranty: 2 Year
- Bio Shield®
- Torque Master® Balanced Grinding Systems

10 lbs.

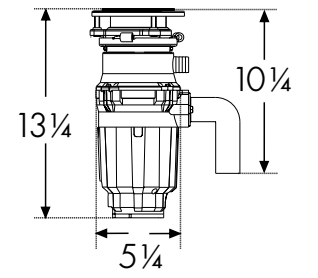

NEW WDJ75NC \$255

Available Spring 2019

¾ HP Disposer

Without Power Cord



FEATURES AND BENEFITS

- Horsepower: ¾
- Feed: Continuous
- RPM: 2700
- Warranty: 5 Year
- Bio Shield®
- Torque Master® Balanced Grinding Systems

13 lbs.

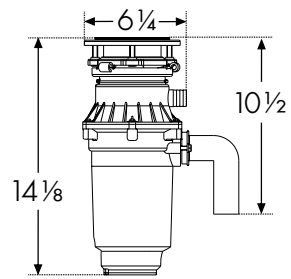

NEW WDJ33NC \$150

Available Spring 2019

⅓ HP Disposer

Without Power Cord



FEATURES AND BENEFITS

- Horsepower: ⅓
- Feed: Continuous
- RPM: 2400
- Warranty: 2 Year
- Bio Shield®
- Torque Master® Balanced Grinding Systems

10 lbs.

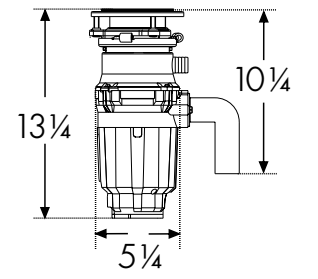

WDJ50 \$195

½ HP Disposer



FEATURES AND BENEFITS

- Horsepower: ½
- Feed: Continuous
- RPM: 2600
- Warranty: 3 Year
- Bio Shield®
- Torque Master® Balanced Grinding Systems

11 lbs.

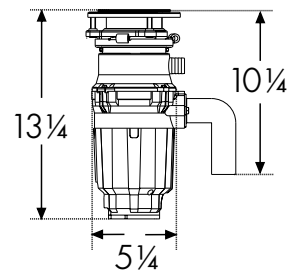

WD9088 \$119

Controller

Requires disposer air switch.



FEATURES AND BENEFITS

For continuous feed models

1 lb.

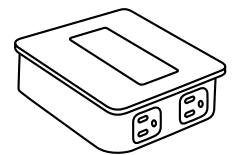

NEW WDJ50NC \$175

Available Spring 2019

½ HP Disposer

Without Power Cord



FEATURES AND BENEFITS

- Horsepower: ½
- Feed: Continuous
- RPM: 2600
- Warranty: 3 Year
- Bio Shield®
- Torque Master® Balanced Grinding Systems

11 lbs.

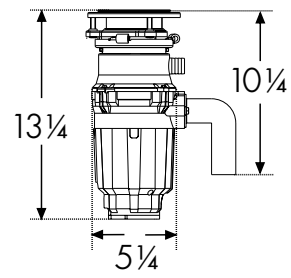

ROUND DISPOSER AIR SWITCH

- WD3428C** Polished Chrome \$31
- WD3428PN** Polished Nickel \$31
- WD3428SN** Satin Nickel \$31
- WD3428BK** Black \$31



FEATURES AND BENEFITS

For continuous feed models
1 ¾" Diameter
2" Shaft (length)
Fits a 1 ¾" hole
1 lb.

Note: Requires controller WD9088.

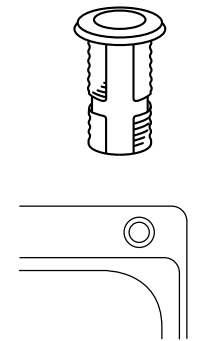

SQUARE DISPOSER AIR SWITCH

- WD930CH
- WD982PN
- WD981SN
- WD907BLK

-  Polished Chrome \$65
-  Polished Nickel \$65
-  Satin Nickel \$65
-  Black \$65

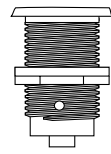

FEATURES AND BENEFITS

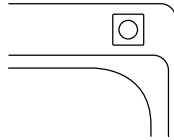

For continuous feed models
 1 13/16" Square
 2" Shaft (length)
 Fits a 1 1/2" hole
 1 lb.
 Note: Requires controller WD9088.



EXTENDED WASTE DISPOSER FLANGE

 Available Spring 2019

- WDFLANGE-EX-SN
- WDFLANGE-EX-WH

-  Satin Nickel \$60
-  White \$60

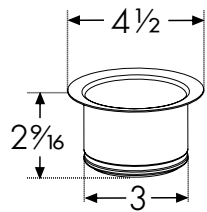



FEATURES AND BENEFITS

Hole Size: 3 1/2"
 4 oz.
 Stopper not Included. Use stopper provided with the waste disposer.

WASTE DISPOSER FLANGE

- WDFLANGE-SS
- WDFLANGE-CH

-  Stainless Steel \$58
-  Polished Chrome \$58

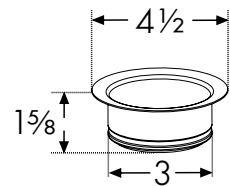

FEATURES AND BENEFITS

Hole Size: 3 1/2"
 3.5 oz.
 Stopper Included



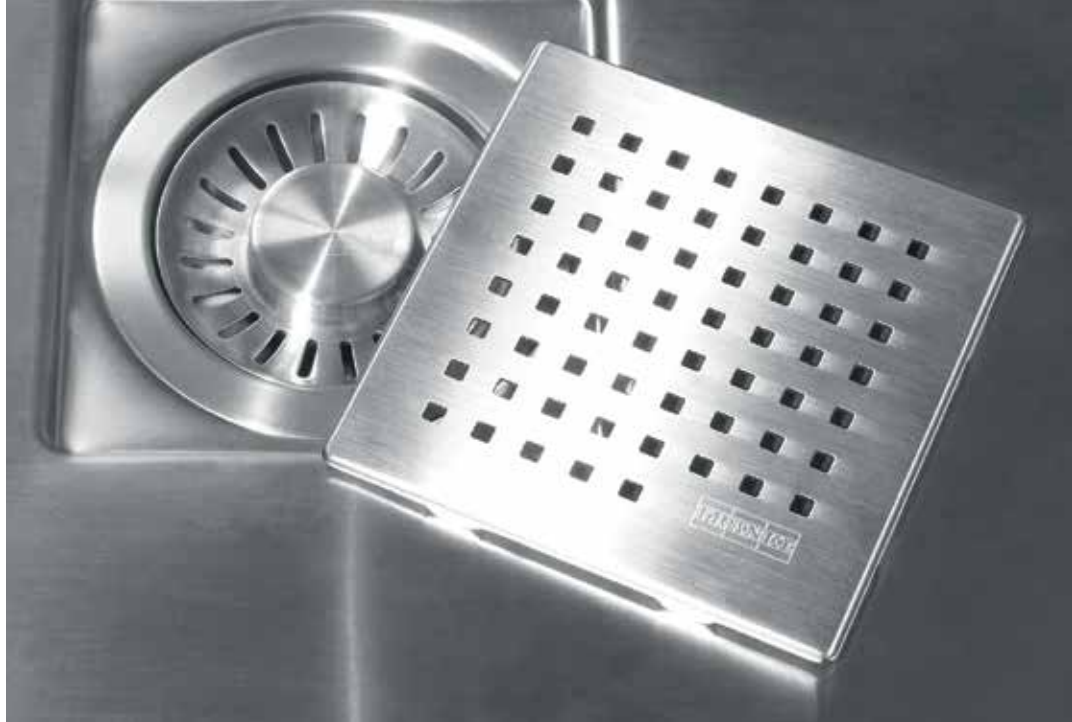

ACCESSORIES

Franke offers everything for the kitchen sink. Customize your work space with our accessories, including strainers, waste kits, drain covers and roller mats.

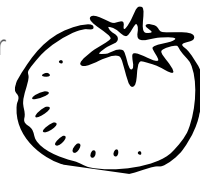

UNIVERSAL ROLLER MAT

UV-36RM

Stainless Steel

\$160

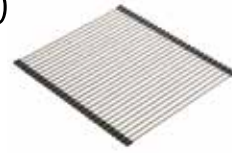

FEATURES AND BENEFITS

- 2 lbs.
- Use over sink or on counter
- Compatible with most sinks
- Holds up to 40 lbs.
- For use as dish drainer or trivet
- 18⁷/₁₆" x 20"
- Dishwasher safe

STRAINER BASKET

906

Polished Chrome

\$ 62



FEATURES AND BENEFITS

1 lb.
Standard 3¹/₂" waste hole

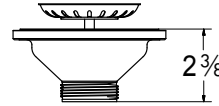

906SN

Satin Nickel

\$ 85

STRAINER BASKET

900W

White

\$ 55



FEATURES AND BENEFITS

1 lb.
Standard 3¹/₂" waste hole

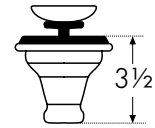

DEEP DRAIN WASTE KIT

906D-SN

Satin Nickel

\$145



FEATURES AND BENEFITS

1 lb.
Includes strainer basket and compost cup

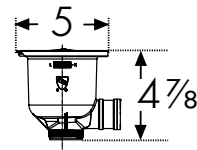

AIR GAP

AG100

Polished Chrome

\$50

AG170

Polished Nickel

\$60

AG180

Satin Nickel

\$60

NEW Available Spring 2019

AG120

Matte Black

\$55

AG122

Shiny Black

\$55

AG140

Gun Metal

\$55

AG150

Stainless Steel

\$55

AG161

Copper

\$55

AG165

Bronze

\$55

AG190

Satin Brass

\$55



FEATURES AND BENEFITS

1 lb.
Hole Size: 1¹/₄"

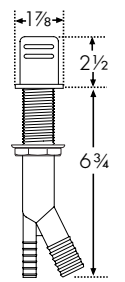

PEAK DRAIN COVER

PKXCVR

Stainless Steel

\$95

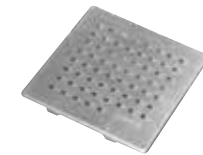

FEATURES AND BENEFITS

1 lb.
4⁷/₈" x 4⁷/₈"
Feet are coated

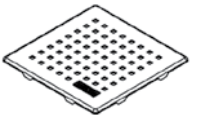

SQUARE DRAIN COVER

PKGCVR

Stainless Steel

\$82



FEATURES AND BENEFITS

1 lb.
4⁷/₈" x 4⁷/₈"
Feet are coated

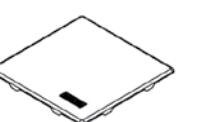

ROUND DRAIN COVER

RNDCVR

Stainless Steel

\$82



FEATURES AND BENEFITS

1 lb.
4¹/₂"
Feet are coated

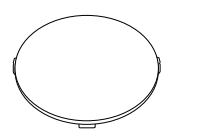

KITCHEN BASEPLATE

BP100

Polished Chrome

\$56

BP180

Satin Nickel

\$72



FEATURES AND BENEFITS

1 lb.
10" Baseplate

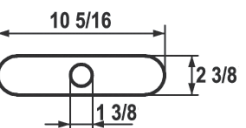

PUSH BUTTON STRAINER KIT

906P-C  Polished Chrome \$124

906P-SN  Satin Nickel \$145



FEATURES AND BENEFITS

1 lb.
Hole size: 1 3/8"
MAX. 2 1/2" countertop thickness
Flange diameter 1 3/4"
Cable length 19"
Standard 3 1/2" waste hole
Only compatible with stainless steel sinks

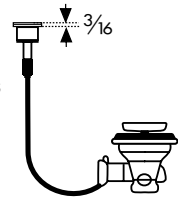

EcO³ SANITIZING SYSTEM

FO3SB  Available Spring 2019 \$695



FEATURES AND BENEFITS

2 lbs.
Sanitizer generated from water
• Produces Ozone (O³) solution when water from the tank passes through the electrolytic cell
• Kills common bacteria and viruses
• 400 ml

POP-UP STRAINER

900P  Polished Chrome \$116

900P-SN27  Satin Nickel \$137



FEATURES AND BENEFITS

1 lb.
Hole size: 1"
MAX. 2 1/2" countertop thickness
Flange diameter 1 1/2"
Cable length 27"
Standard 3 1/2" waste hole
Not compatible with fireclay sinks

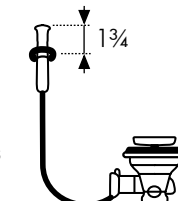

INOX CREAM

903 \$31



FEATURES AND BENEFITS

Stainless steel cleaner
• Restores sheen and brightness
• Easy to use
• 250 ml

REMOTE TWIST WASTE KIT

FRTWIST-SN  Satin Nickel \$155



FEATURES AND BENEFITS

1 lb.
Hole size: 1 3/8"
MAX. 2 1/2" countertop thickness
Flange diameter 1 3/4"
Cable length 19"
Standard 3 1/2" waste hole
Only compatible with stainless steel sinks

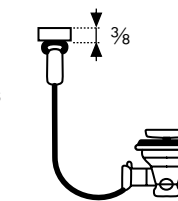

FAUCET HOLE COVER

628  Polished Chrome \$ 7

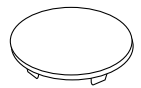

CHANGING THE WAY YOU CLEAN

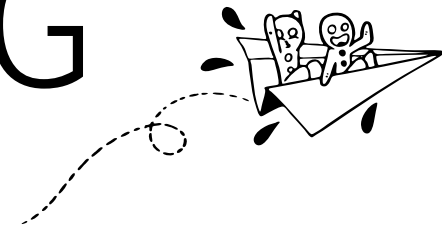

Clean, green and cost-effective. The powerful new Franke EcO³ Sanitizing System kills 99.9 percent of harmful bacteria found on hard, nonporous kitchen surfaces, including E. coli, salmonella and staph using only water and a long-lasting, rechargeable lithium ion battery.

AN ECONOMICAL SOLUTION

One bottle of Franke EcO³ Sanitizing solution has as much cleaning power as 14,800 cans of aerosol spray cleaner making it a positive choice for the environment and your wallet. EcO³ offers these additional advantages:

- One battery can produce about 550 gallons of sanitizing solution.
- The battery can be recharged up to 500 times for approximately 5,000 refills of the 14-ounce reservoir.
- The sanitizer has a limitless shelf life, which means there is never expired solution and no waste.
- An LED indicator lets you know when it's time to recharge the battery.

It's never been easier to achieve a clean, bacteria-free kitchen.

See page 301 for details.

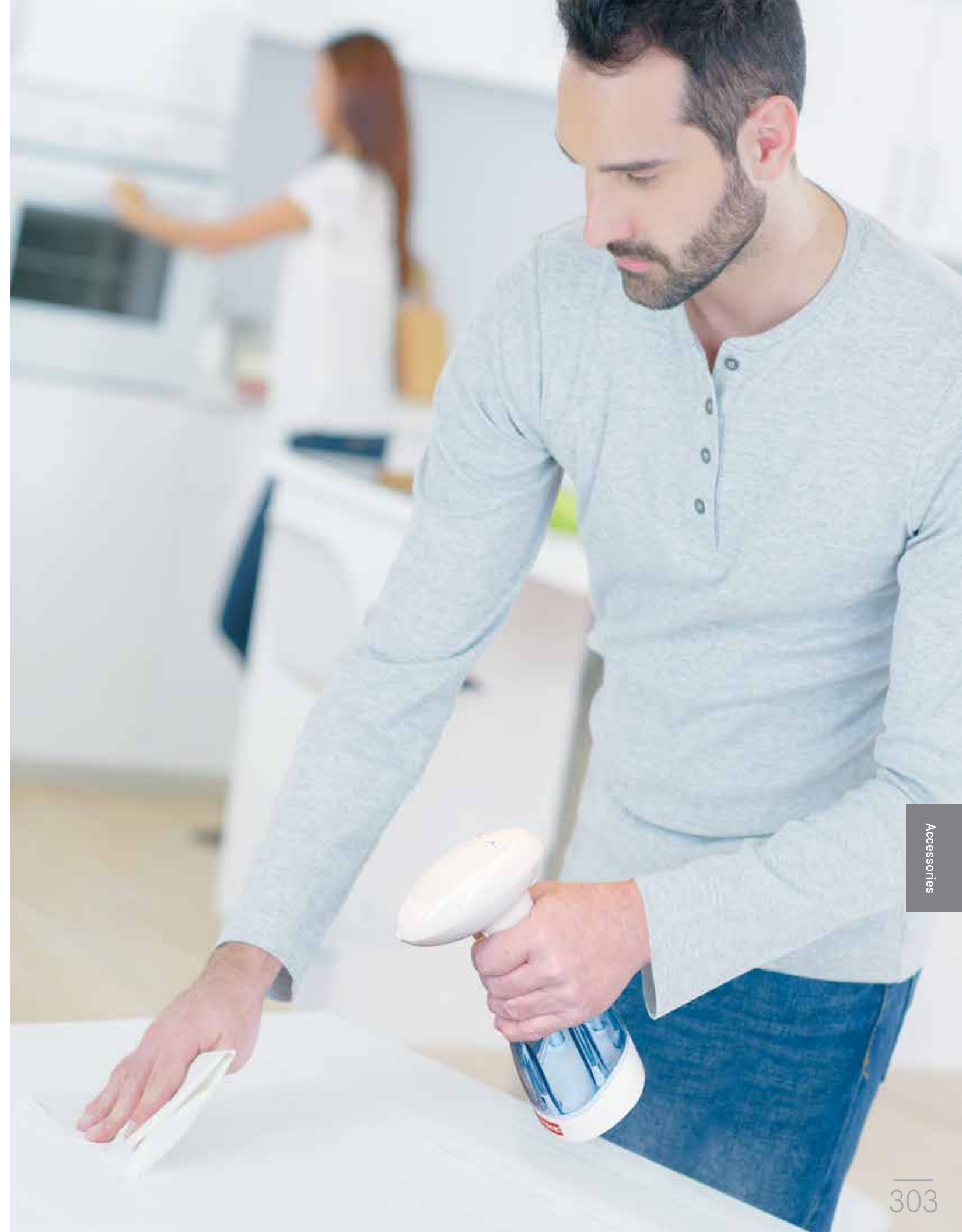

	MODEL NO.	BOTTOM GRID	CUTTING MAT	CUTTING BOARD	CUTTING BOARD	COLANDER	DRAIN BOARD	ROLLER MAT	POP-UP STRAINER	DRAIN COVER	PAGE NO.
CHEF CENTER	CUX11018-W 	CUW18-36S Included	SP-40S Included	CUW-40S Included		CUW-70S Included	CUW-60S Included	CUW-36RM Included	906P-C 906P-SN 	PKGCVR Included	44
	CUX11024-W 	CUW24-36S Included	SP-40S Included	CUW-40S Included		CUW-70S Included	CUW-60S Included	CUW-36RM Included	906P-C 906P-SN 	PKGCVR Included	44
	CUX11031-W 	CUW31-36S Included	SP-40S Included	CUW-40S Included		CUW-70S Included	CUW-60S Included	CUW-36RM Included	906P-C 906P-SN 	PKGCVR Included	44
CRYSTAL	CLV110-24 	CL-24-36S 		PS2-40S 	PS2-45S 	PE-70S 		RM18S 	906P-C 906P-SN 	CL-WGC CL-SSC CL-BGC Included	62
	CLV110-28 	CL-28-36S 		PS2-40S 	PS2-45S 	PE-70S 		RM18S 	906P-C 906P-SN 	CL-WGC CL-SSC CL-BGC Included	62
	CLV110-31 	CL-31-36S 		PS2-40S 	PS2-45S 	PE-70S 		RM18S 	906P-C 906P-SN 	CL-WGC CL-SSC CL-BGC Included	62
	CLV120-33 	CL-14-36S 		PS2-40S 	PS2-45S 	PE-70S 		RM18S 	906P-C 906P-SN 	CL-WGC CL-SSC CL-BGC Included	63
CUBE	CUX11015 	CU15-36S 		CU-40S 	CU-40P 	CUW-70S 		UV-36RM 	906P-C 906P-SN 		96
	CUX11021 	CU21-36S 		CU-40S 	CU-40P 	CUW-70S 		UV-36RM 	906P-C 906P-SN 		96
	CUX11023 	CU23-36S 		CU-40S 	CU-40P 	CUW-70S 		UV-36RM 	906P-C 906P-SN 		96
	CUX11025 & CUX11025-8 	CU25-36S 		CU-40S 	CU-40P 	CUW-70S 		UV-36RM 	906P-C 906P-SN 		97
	CUX11027 & CUX11027-8 	CU27-36S 		CU-40S 	CU-40P 	CUW-70S 		UV-36RM 	906P-C 906P-SN 		98
	CUX11030 & CUX11030-8 	CU30-36S 		CU-40S 	CU-40P 	CUW-70S 		UV-36RM 	906P-C 906P-SN 		98 & 99
	CUX120 	CU15-36S 		CU-40S 	CU-40P 	CUW-70S 		UV-36RM 	906P-C 906P-SN 		99
	CUX160 	CU18-36S CU11-36S 		CU-40S 	CU-40P 	CUW-70S 		UV-36RM 	906P-C 906P-SN 		100
	CUX11021-ADA 	CU21-36S 		CU-40S 	CU-40P 	CUW-70S 		UV-36RM 	906P-C 906P-SN 		100

	MODEL NO.	BOTTOM GRID	SHELF GRID	COUNTER GRID	CUTTING MAT	CUTTING BOARD	CUTTING BOARD	COLANDER	ROLLER MAT	KNIFE SET	WIRE RACK	FRAME COVER	POP-UP STRAINER	PAGE NO.
CUBE	CUX11027-ADA 	CU27-36S 				CU-40S 	CU-40P 	CUW-70S 	UV-36RM 				906P-C 906P-SN 	100
	CUX11010-W 				SP-41S 	CU-40S 	CU-40P 	CUW-70S 		CU-KS 	CU-WR 	CU-FC 		40
CULINARY CENTER	CUX16021-W 					CU-CG 								
	Note: All accessories included for CUX16021-W model only.					CU-40K 								
GRANDE	GDX11012 	GD12-36S 							UV-36RM 				900P 900P-SN27 	104
	GDX11015 	GD15-36S 							UV-36RM 				900P 900P-SN27 	104
	GDX11018 	GD18-36S 											900P 900P-SN27 	104
	GDX11023 	GD23-36S 					GD-40S 		UV-36RM 				900P 900P-SN27 	105
	GDX11028 	GD28-36S 					GD28-40S 		UV-36RM 				900P 900P-SN27 	105
	GDX11031 	GD31-36S 					GD-40S 		UV-36RM 				900P 900P-SN27 	106
KUBUS	GDX12031 	NC15-36S 				GD-40S 		UV-36RM 					900P 900P-SN27 	106
	KBX110-8 							KB-70C 					900P 900P-SN27 	66
	KBX110-13 	KB13-36S 						KB-70C 	KB-36RM 				900P 900P-SN27 	66
KUBUS	KBX110-18 	KB18-36S 	KB18-31S 	KB17-31C 		KB-40S 		KB-70C 	KB-36RM 				900P 900P-SN27 	66
	KBX11021 	KB21-36S 	KB21-31S 	KB17-31C 		KB-40S 		KB-70C 	KB-36RM 				900P 900P-SN27 	67
	KBX11028 	KB28-36S 	KB28-31S 	KB17-31C 		KB-40S 		KB-70C 	KB-36RM 				900P 900P-SN27 	67

Quick Reference

Quick Reference

	MODEL NO.	BOTTOM GRID	SHELF GRID	COUNTER GRID	CUTTING BOARD	COLANDER	WIRE BASKET	ROLLER MAT	TWIST WASTE KIT	POP-UP STRAINER	DRAIN COVER	PAGE NO.
KUBUS	KBX12034	KB18-36S KB13-36S	KB18-31S	KB17-31C	KB-40S	KB-70C		KB-36RM		900P 900P-SN27		68
	KBX12039	KB21-36S KB13-36S	KB21-31S	KB17-31C	KB-40S	KB-70C		KB-36RM		900P 900P-SN27		68
	KBX12043	KB21-36S KB18-36S	KB21-31S KB18-31S	KB17-31C	KB-40S	KB-70C		KB-36RM		900P 900P-SN27		68
	KBX160	KB21-36S	KB21-31S	KB17-31C	KB-40S	KB-70C		KB-36RM		900P 900P-SN27		69
MANOR HOUSE	MHX710-30	MH30-36S			OA-40S				FRTWIST-SN			36
	MHX710-33	MH33-36S			OA-40S				FRTWIST-SN			36
	MHX710-36	MH36-36S			OA-40S				FRTWIST-SN			36
ORCA	ORX110	OC-36S	OC-31S-LH OC-31S-RH		OC-45SP	OC-60S		UV-36RM				83
	OR2X110	OC2-36S	OC2-31S-RH		OC2-45SP	OC2-60S OC2-50C		UV-36RM			RNDVCVR Included	82
PEAK	PKX1108					PX-70S		UV-36RM	FRTWIST-SN		PKXCVR Included	48
	PKX11013	PX-13S	PX-13S			PX-70S		UV-36RM	FRTWIST-SN		PKXCVR Included	48
	PKX11016	PX-16S	PX-16S		PX-40S	PX-70S		UV-36RM	FRTWIST-SN		PKXCVR Included	48
	PKX11018	PX-18S	PX-18S		PX-40S	PX-70S		UV-36RM	FRTWIST-SN		PKXCVR Included	49
	PKX11021	PX-21S	PX-21S		PX-40S	PX-70S		UV-36RM	FRTWIST-SN		PKXCVR Included	49
	PKX11025	PX-25S	PX-25S		PX-40S	PX-70S		UV-36RM	FRTWIST-SN		PKXCVR Included	50

	MODEL NO.	BOTTOM GRID	SHELF GRID	CUTTING MAT	CUTTING BOARD	CUTTING BOARD	COLANDER	ROLLER MAT	POP-UP STRAINER	DRAIN COVER	PAGE NO.
PEAK	PKX11028	PX-28S	PX-28S			PX-40S	PX-70S	UV-36RM	FRTWIST-SN	PKXCVR Included	50
	PKX160	PX-21S	PX-21S			PX-40S	PX-70S	UV-36RM	FRTWIST-SN	PKXCVR Included	50
PESCARA	PTX110-14	PT14-36S		SP-40S	PT-40S	PT-41S	PE-70S	UV-36RM	906P-C 906P-SN	PKGCVR Included	76
	PTX110-17	PT17-36S	PT14-31S	SP-40S	PT-40S	PT-41S	PE-70S	UV-36RM	906P-C 906P-SN	PKGCVR Included	76
	PTX110-20	PT20-36S	PT14-31S	SP-40S	PT-40S	PT-41S	PE-70S	UV-36RM	906P-C 906P-SN	PKGCVR Included	76
	PTX110-22	PT22-36S	PT14-31S	SP-40S	PT-40S	PT-41S	PE-70S	UV-36RM	906P-C 906P-SN	PKGCVR Included	77
	PTX110-25	PT25-36S	PT14-31S	SP-40S	PT-40S	PT-41S	PE-70S	UV-36RM	906P-C 906P-SN	PKGCVR Included	77
	PTX110-28	PT28-36S	PT14-31S	SP-40S	PT-40S	PT-41S	PE-70S	UV-36RM	906P-C 906P-SN	PKGCVR Included	78
	PTX110-31	PT31-36S	PT14-31S	SP-40S	PT-40S	PT-41S	PE-70S	UV-36RM	906P-C 906P-SN	PKGCVR Included	78
	PEX110-14	PE-14S				PE-40S	PE-70S	UV-36RM	906P-C 906P-SN		72
	PEX110-21	PE-21S				PE-40S	PE-70S	UV-36RM	906P-C 906P-SN		72
PLANAR 8	PEX110-28	PE-28S				PE-40S	PE-70S	UV-36RM	906P-C 906P-SN		72
	PEX110-31	PE-31S				PE-40S	PE-70S	UV-36RM	906P-C 906P-SN		73
PRESTIGE	PCX1102109	PR-36S						UV-36RM	900P 900P-SN27		88
	PRX11021	PR-36S	PR-31S					UV-36RM	900P 900P-SN27		88

Quick Reference

Quick Reference

	MODEL NO.	BOTTOM GRID	SHELF GRID	CUTTING BOARD	CUTTING BOARD	COLANDER	ROLLER MAT	DRAIN COVER	PAGE NO.	
PROFESSIONAL 2.0	PS2X110-15	PS2-15-36S		PS2-40S	PS2-45S	PE-70S	RM18S	RNDCVR <small>Included</small>	54	
	PS2X110-18	PS2-18-36S		PS2-40S	PS2-45S	PE-70S	RM18S	RNDCVR <small>Included</small>	54	
	PS2X110-21	PS2-21-36S		PS2-40S	PS2-45S	PE-70S	RM18S	RNDCVR <small>Included</small>	54	
	PS2X110-24	PS2-24-36S		PS2-40S	PS2-45S	PE-70S	RM18S	RNDCVR <small>Included</small>	55	
	PS2X110-24-12	PS2-24-36S		PS2-40S	PS2-45S	PE-70S	RM18S	RNDCVR <small>Included</small>	55	
	PS2X110-27	PS2-27-36S		PS2-40S	PS2-45S	PE-70S	RM18S	RNDCVR <small>Included</small>	56	
	PS2X110-30	PS2-30-36S		PS2-40S	PS2-45S	PE-70S	RM18S	RNDCVR <small>Included</small>	56	
	PS2X110-30-12	PS2-30-36S		PS2-40S	PS2-45S	PE-70S	RM18S	RNDCVR <small>Included</small>	56	
	PS2X110-33	PS2-33-36S		PS2-40S	PS2-45S	PE-70S	RM18S	RNDCVR <small>Included</small>	57	
	PS2X160-18-11	PS2-11-36S PS2-18-36S		PS2-40S	PS2-45S	PE-70S	RM18S	RNDCVR <small>Included</small>	57	
	PS2X120-14-14	PS2-14-36S		PS2-40S	PS2-45S	PE-70S	RM18S	RNDCVR <small>Included</small>	58	
	PS2X120-16-16	PS2-16-36S		PS2-40S	PS2-45S	PE-70S	RM18S	RNDCVR <small>Included</small>	58	
	PROFESSIONAL OUTDOOR	LRX110-2310-316	PS23-36S							59
		LRX110-2312-316	PS23-36S							59

	MODEL NO.	BOTTOM GRID	DRAIN BASKET	ROLLER MAT	POP-UP STRAINER	PAGE NO.
REGATTA	RGX160	RG-36S RG-36S-RH	CP-50C	UV-36RM	900P 900P-SN27	92
	RBX-110	RBG-36S		UV-36RM	900P 900P-SN27	110
ROTONDO	BMSK802 & BMSK803	FBG65S				126
	SL101BX & SL103BX	FBG110S				127
	FBSLD904-18BX	FBG2817				127
EVOLUTION	EVSAS801-20 & EVSAS804-20	EVBG2115				118
	EVSCG801-18 & EVSCG804-18	EVBG2115				119
	EVDAS801-20 & EVDAS804-20	EVBG1315				119
	EVDCG801-18 & EVDCG804-18	EVBG1315				120
	EVDCG901-18 & EVDCG904-18	EVBG1315				120
	EVCAG901-18 & EVCAG904-18	EVBG1315 EVBG1318				121

	MODEL NO.	BOTTOM GRID	PAGE NO.
EVOLUTION	EVDAG901-18 & EVDAG904-18	EVBG1315	121
	EVDCS802KIT	EVBG1315	122
KINETIC	FFS30B-10-18	CU27-36S	124
	FFS33B-10-18	CU30-36S	124
	FFD33B-9-18		124
VECTOR	HTS1722-1	BGHF200	116
	HTS2022-1	BGHF300	116
	HFS2522-1	BGHF101	117
	HFS3322-1 & HFS3322-2	BGHF115	117
	HF3322-1	BGHF210	118
	HF3322-2	FBGH1613	125
	HFO3322-1	BGHF210 BGHF400	126
	HFT4322-2 & HFT4322-4	BGHF200	125

	MODEL NO.	BOTTOM GRID	CUTTING BOARD	ROLLER MAT	PAGE NO.
CISTERNA	CCK110-13	CK13-36C	OA-40S	UV-36RM	152
	CCK110-15	CK15-36C	OA-40S	UV-36RM	152
	CCK110-19	CK19-36C	OA-40S	UV-36RM	152
FARM HOUSE	FH2K110-24	FK2-24-36S			138
	FH2K110-30	FK2-30-36S			138
	FH3K710-30	FK3-30-36S			138
	FH3K710-33	FK3-33-36S			139
	FHK710-30	FK30-36S	OA-40S		139
	FHK710-33	FK33-36S	OA-40S		140
	FHK710-36	FK36-36S	OA-40S		140
	FH2K710-30	FK2-30-36S	OA-40S	UV-36RM	156
	FH2K710-33	FK2-33-36S	OA-40S	UV-36RM	156
	FH2K710-36	FK2-36-36S	OA-40S	UV-36RM	157

	MODEL NO.	BOTTOM GRID	SHELF GRID	CUTTING BOARD	ROLLER MAT	PAGE NO.
MANOR HOUSE	MHK110-20			OA-40S		134
	MHK110-24	MK24-36C		OA-40S		134
	MHK110-28	MK28-36C		OA-40S		134
	MHK720-31	MK31-36C-LH MK31-36C-RH		OA-40S		135
	MHK720-35	MK35-36C-LH MK35-36C-RH		OA-40S		135
ORCA	ORK110	OK-36C	OK-31C-LH OK31C-RH	OA-40S	UV-36RM	144
	PRK11021	PK21-36S	PK21-31S	OA-40S	UV-36RM	148

	MODEL NO.	BOTTOM GRID	SHELF GRID	CUTTING BOARD	ROLLER MAT	PAGE NO.	
ELLIPSE	ELG11022	ELG22-36S			UV-36RM	178	
	ELG120	ELG14-36S			UV-36RM	178	
	ELG160	ELG16-36S ELG13-36S			UV-36RM	179	
	ESOX25229-1 ESDB25229-1 ESCH25229-1	FBGG1914				180	
	EDOX33229-1 EDDB33229-1 EDCH33229-1	FBGG1114				180	
	EOOX33229-1 EODB33229-1 EOCH33229-1	FBGG1014 FBGG1316				181	
	KUBUS	KBG11013	KBG13-36S			UV-36RM	174
		KBG11031	KBG31-36S			UV-36RM	174
	ORCA	ORG110	OC-36S	OC-31S-LH OC-31S-RH	OC-45SP	UV-36RM	170

Quick Reference

Quick Reference

	MODEL NO.	BOTTOM GRID	BOTTOM ROLLER MAT	SHELF ROLLER MAT	CUTTING BOARD	DRAIN COVER	PAGE NO.
PEAK	PKG11014		PKG14-36RM	PKG14-31RM	PG2-40S	PKGCVR Included	164
	PKG11020		PKG20-36RM	PKG14-31RM	PG2-40S	PKGCVR Included	164
	PKG11031	PKG31-36S	PKG31-36RM	PKG18-31RM	PG-40S	PKGCVR Included	165
	PKG160	PKG17-36S PKG12-36S	PKG17-36RM PKG12-36RM	PKG18-31RM	PG-40S	PKGCVR Included	166
GRAVITY	SGR3322-1 SC3322-1 SP3322-1	FBBG2716					188
	DIG62F91	BGDIL150 BGDIS150					188
PRIMO	DIG61091	BGD1110					184
	DIG62D91	BGD1100					184
QUANTUM	SOX1720-1 SZGR1720-1 SZCH1720-1 SZPW1720-1	FBG180S					192

12"  
 KBX110-8 Page 66 PKX1108 Page 48

18"         
 CCK110-13 Page 152 CUX11010-W Page 40 GDX11012 Page 104 KBX110-13 Page 66 PEX110-14 Page 72 PKX11013 Page 48 PTX110-14 Page 76 RBX-110 (Topmount) Page 110 SOX1720-1 SZGR1720-1 SZCH1720-1 SZPW1720-1 Page 192

21"       
 BMSK802 BMSK803 Page 126 CCK110-15 Page 152 CUX11015 Page 96 GDX11015 Page 104 HTS1722-1 Page 116 KBG11013 Page 174 MHK110-20 Page 134

    
 PKG11014 Page 164 PKX11016 Page 48 PS2X110-15 Page 54 PTX110-17 Page 76 RBX-110 (Undermount) Page 110

24"         
 FH2K110-24 Page 138 GDX11018 Page 104 HTS2022-1 Page 116 KBX110-18 Page 66 MHK110-24 Page 134 PKX11018 Page 49 PS2X110-18 Page 54 PTX110-20 Page 76 SL101BX SL103BX Page 127

27"         
 CCK110-19 Page 152 CUX11021 Page 96 CUX11021-ADA Page 100 ELG11022 Page 178 ESOX25229-1 ESDB25229-1 ESCH25229-1 Page 180 EVSAS801-20 EVSAS804-20 Page 118 EVSCG801-18 EVSCG804-18 Page 119 HFS2522-1 Page 117 KBX11021 Page 67

       
 PCX1102109 Page 88 PEX110-21 Page 72 PKG11020 Page 164 PKX11021 Page 49 PRK11021 Page 148 PRX11021 Page 88 PS2X110-21 Page 54 PTX110-22 Page 77

Quick Reference

Quick Reference

30"



33"



36"



36"



39"



42"



45"



48"



Side Spray Faucets



Absinthe FF5200 Page 220
 Farm House FF6000A Page 204
 Farm House FF7000A Page 204
 Farm House FFS100 Page 204
 Farm House FFS400 Page 204

Pull-Down Faucets



Ethos FF5700 Page 257
 Farm House FFPD400 Page 205
 Fluence FF3200 Page 243
 Kubus FF4250 Page 249
 Orca FF3550 Page 237
 Pescara FF4700 Page 227
 Pescara XL FF4800 Page 226
 Rigo FF20300 Page 257
 Steel FF3450 Page 240

Pull-Out Faucets



Absinthe FFPS5200 Page 220
 Active Plus FF3800 Page 247
 Ambient FFPS3600 Page 233
 Ambient FFPS4300 Page 232
 Bernard FFPS20550 Page 256
 Sion FFPS20200 Page 257
 Steel FFPS3450 Page 241
 Valais FFPS20100 Page 258
 Vesta FFPS20000 Page 258

Professional Faucets



Bern Pro FFPD20850 Page 256
 Chillout FF4900 Page 214
 Crystal FFPD4600 Page 210
 Fuji FFPD20400 Page 257
 Manhattan FF2900 Page 245
 MasterChef FFPD2000 Page 211
 Peak FFPD5550 Page 229
 Pescara FF4400 Page 226
 Pescara XL FFPD4300 Page 226
 Purus FFPD5600 Page 213 & 262
 Planar 8 Flex FF2800 Page 217
 Professional FF5300 Page 209
 Professional FFPD5300 Page 209
 Professional FFPD5400 Page 209

Pull-Down Faucets



Absinthe FF5200 Page 220
 Active Neo FF3900 Page 247
 Ambient FF3100 Page 232
 Antero FF22300 Page 258
 Bern FF20750 Page 256
 Bernadine FF20650 Page 256
 Cube FF3350 Page 252
 Cube FF3352 Page 252
 Cube FFPD3350 Page 252

Quick Reference

Quick Reference

Pot Fillers



Absinthe
PF5200
Page 220

Ambient
PF3100
Page 233

Farm House
PF3300
Page 205

Farm House
PF7000A
Page 205

Orca
PF3550
Page 237

Pescara
PF4400
Page 227

Pescara
PFD4400
Page 227

Steel
PF3450
Page 241

Prep Faucets



Absinthe
FFP5200
Page 221

Ambient
FFP3100
Page 232

Cube
FFP3350
Page 252

Kubus
FFP4250
Page 249

Manhattan
FFP2900
Page 245

Orca
FFP3550
Page 237

Pescara
FFP4400
Page 227

Planar 8
FFP2800
Page 217

Steel
FFP3450
Page 241

Bar Faucets



Absinthe
FFB5200
Page 221

Ambient
FFB3100
Page 232

Cube
FFB3350
Page 253

Kubus
FFB4250
Page 249

Manhattan
FFB2900
Page 245

Orca
FFB3550
Page 237

Planar 8
FFB2800
Page 217

Steel
FFB3450
Page 241

3-in-1 Filtration Faucets



Absinthe
FFT5200
Page 221 & 262

Ambient
FFT3100
Page 233 & 262

Cube
FFT3350
Page 253 & 262

Purus
FFPD5600
Page 213 & 262

Professional
FFPD5400
Page 209

Cold Filtration Faucets



Absinthe
DW15000
Page 221 & 266

Ambient
DW10000
Page 234 & 270

Ambient
DW7000C
Page 233 & 268

Farm House
DW12000
Page 206 & 264

Farm House
DW6100C
Page 205 & 263

Logik
DW9000C
Page 265

Orca
DW14050
Page 238 & 273

Pescara
DW16000
Page 228 & 267

Purus
DW5600
Page 213 & 263

Steel
DW13050
Page 242 & 271

Hot Filtration Faucets



Absinthe
LB15100
Page 222 & 266

Ambient
LB10100
Page 234 & 270

Ambient
LB7100C
Page 234 & 269

Farm House
LB12100
Page 206 & 264

Farm House
LB6100C
Page 206 & 263

Logik
LB9100C
Page 265

Orca
LB14150
Page 238 & 273

Pescara
LB16100
Page 228 & 267

Steel
LB13150
Page 242 & 272

Hot/Cold Filtration Faucets



Absinthe
LB15200
Page 222 & 267

Ambient
LB10200
Page 235 & 271

Ambient
LB7200C
Page 234 & 269

Farm House
LB12200
Page 207 & 264

Farm House
LB6200C
Page 206 & 263

Logik
LB9200C
Page 266

Orca
LB14250
Page 238 & 273

Pescara
LB16200
Page 228 & 268

Steel
LB13250
Page 242 & 272

Soap Dispenser Guide

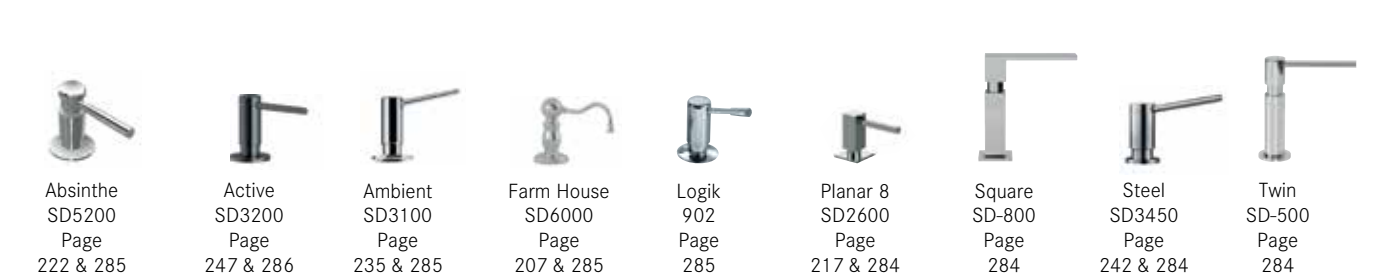

Absinthe
SD5200
Page 222 & 285

Active
SD3200
Page 247 & 286

Ambient
SD3100
Page 235 & 285

Farm House
SD6000
Page 207 & 285

Logik
902
Page 285

Planar 8
SD2600
Page 217 & 284

Square
SD-800
Page 284

Steel
SD3450
Page 242 & 284

Twin
SD-500
Page 284

GENERAL

- Products may only be sold and advertised within the United States of America. Franke hereby expressly prohibits the dealer from soliciting or consummating sales outside of the United States of America without prior written consent.
- Products shall only be sold in their original packaging. Relabeling, repackaging (including the separation of bundled products or the bundling of separate products), and other alterations are not permitted.
- Sale of Franke products on the Internet shall be prohibited unless resellers apply and are approved by Franke, and execute an Authorized Internet Reseller Agreement regulating the manner in which they sell online.

ORDERING

- Once an order has been acknowledged, no changes (including additions or cancellations) will be accepted.
- Order acknowledgments are available via email. An email address must be provided to receive this benefit.
- Standard lead time for shipment is one to five (1-5) business days from receipt of order.

STANDARD PAYMENT TERMS

- Net 30 days.
- Early payment discounts are not applicable for payments via credit card.
- Franke reserves the right to charge interest and an administration fee on late payments.

PRICING

- Please refer to the electronically published price list (EPL). Orders will be priced with the prevailing price at the time the order is placed.
- Prices are subject to change without notice. Franke will attempt to provide reasonable lead time for pricing changes.

CLAIMS / CHARGE BACKS

- Damages/Shortages must be reported within ten (10) days of receipt of merchandise.
- Charge backs will not be accepted without an authorization number (RMA), provided by a Regional Sales Manager, Distributor, or Customer Service.

RETURNS

- No returns will be accepted without a return authorization number (RMA).
- Return authorization requests must be submitted through Rep/Regional Manager.
- A 25% restocking fee will be charged for ALL returns of product that was not damaged or mis-shipped.
- No returns will be accepted more than 180 days from original invoice date.
- No returns will be accepted on discontinued (DWO) or obsolete product.
- Franke reserves the right to refuse returns without reason.

FREIGHT

- Pre-paid freight/Free freight allowance (FFA)
 - USD 2,900 is the minimum order value for FFA
 - All product lines, including parts, can be included in freight qualification calculations.
 - All Display and Literature orders will be shipped with pre-paid freight status.
- Flat Rate Shipping
 - Any order shipping parcel containing standard products will ship for \$25 flat.
 - Orders >150 lbs. are shipping LTL and are charged according to weight/dimension.
 - Orders containing Fireclay sinks are charged USD 150 for up to 2 units and USD 300 for up to 4 units.
 - Other: standard shipping rates apply for Fireclay orders greater than 4 units and any parts only orders.

- Other freights terms
 - Franke will attempt to fulfill requests to expedite shipping. Customers will be responsible for additional freight charges. Contact Customer Service for all expedited shipping requests.
 - Drop shipment of internet orders is not available. All Internet Sales must be shipped from an Authorized Internet Reseller's location. Drop shipment is offered within 100 miles of customer's place of business, or within customer's state or a bordering state.

BACK ORDERS

- Back order shipments will match freight qualifying status of original order.
- Back ordered product will be considered an active order unless customer requests cancellation.

LIMITED WARRANTY**SINKS**

Franke warrants that each Franke sink will be free from manufacturing defects in material and workmanship for the lifetime of the sink.

FAUCETS

Franke warrants that mechanical parts in all faucets purchased after January 1, 2003 will be free of manufacturing defects in material and workmanship for the lifetime of the faucet. Faucets purchased prior to 2003 are subject to the warranty in place at time of purchase. Franke warrants that (1) the chrome finishes on Franke faucets will be free of manufacturing defect for the lifetime of the faucet; and (2) all other finishes on Franke faucets will be free of manufacturing defect for five (5) years from the original date of purchase.

WATER DISPENSING & FILTRATION SYSTEMS

Franke warrants that Franke water dispensing and filtration systems are free from manufacturing defects in material and workmanship for the period set forth in the paperwork included with the product, which is 5 or 10 years from the date of purchase, depending on the model purchased.

HOT WATER TANKS

Franke warrants that Franke hot water tanks are free from manufacturing defects in material and workmanship for the period set forth in the paperwork included with the product, which is 1 or 3 years from the date of purchase, depending on the model purchased.

WASTE DISPOSERS

Franke warrants that Franke 1/2 Horsepower disposer models are free from manufacturing defects in material and workmanship for the period set forth in the paperwork included with the product, which is 3 or 5 years from the date of purchase, depending on the model purchased. Franke warrants that Franke 3/4 horsepower waste disposers are free from manufacturing defects for the period set forth in the paperwork included with the product, which is 5 or 10 years from the date of purchase, depending on the model purchased. Franke warrants that Franke 1-1/4 horsepower models are free from manufacturing defects in material and workmanship for the lifetime of the product.

LOTION/SOAP DISPENSERS

Franke warrants that Franke lotion/soap dispensers are free from manufacturing defects in material and workmanship for a period of five years from the date of purchase. Such warranty does not cover damage caused by the use of aggressive soaps and lotions.

ACCESSORIES

Franke warrants that Franke accessories, including, but not limited to, shelves, colanders, strainers, cutting boards and other accessory items, are free from manufacturing defects in material and workmanship for a period of one (1) year from the date of purchase.

OUTDOOR INSTALLATION

Franke Soap dispensers, waste disposers, water dispensing systems and accessories are NOT warranted for outdoor installations. Certain Franke faucets are warranted to be free from manufacturing defects in material and workmanship for outdoor installations for the period set forth in the paperwork included with the product, which is 5 or 10 years from the date of purchase, depending on the model purchased.

WARRANTY TERMS

Each warranty by Franke Kitchen System, LLC (“Franke”) set forth herein (each, a “Warranty” and collectively the “Warranties”) applies only to the original owner when purchased from Franke or a Franke, authorized reseller. The Warranties only apply if the applicable product has been installed in accordance with our installation instructions, used as recommended and in a normal residential application. To make a warranty claim, the owner must provide proof of purchase, in the form of a sales receipt. Each Warranty covers all components that make the applicable product operational. Franke, at its option, may repair or replace the product or components necessary to restore the product to good working condition. Franke reserves the right to inspect the installation prior to the actual replacement of the product or component part. The Warranties do not cover any product used in combination with a Reverse Osmosis Filtration System.

The Warranties do not cover misuse or abuse, accidental damages, scuffs or scratches, improper installation, abnormal usage, negligence, damage caused by improper maintenance or cleaning or normal wear. Damage caused by impurities or acts beyond Franke’s control are not covered by any Warranty. Further, this warranty does not cover any products purchased from unauthorized dealers. If any product or part has been repaired or altered in any manner outside of Franke’s factory, unless previously authorized in writing by Franke, the applicable Warranty is void with respect to such product or part. Owner of a product will be liable for any transportation and re-installation costs related to any Warranty for such product. The Warranties do not allow recovery of incidental or consequential damages such as loss of use, delay, property damage or other consequential damage, and Franke accepts no liability for such damages.

Each Warranty is limited to the conditions set forth herein and to the applicable warranty period specified herein and is exclusive. EXCEPT FOR THE WARRANTIES SET FORTH HEREIN, FRANKE MAKES NO WARRANTY WHATSOEVER WITH RESPECT TO THE PRODUCTS, INCLUDING, BUT NOT LIMITED TO, (1) ANY WARRANTY OF MERCHANTABILITY, (2) WARRANTY OF FITNESS FOR A PARTICULAR PURPOSE, (3) WARRANTY OF TITLE, OR (4) WARRANTY AGAINST INFRINGEMENT OF INTELLECTUAL PROPERTY RIGHTS OF A THIRD PARTY, WHETHER EXPRESS OR IMPLIED BY LAW, COURSE OF DEALING, COURSE OF PERFORMANCE, USAGE OF TRADE OR OTHERWISE.

LEGAL DISCLAIMER

Please read carefully.

Franke Kitchen Systems provides the above information to you for as a public service to our customers. By accessing and using this information, you agree to the following and to comply with all applicable laws. If you do not agree with these terms and conditions, do not use this information. While we try to keep the information current, changes may have occurred since its creation. Contact your Regional Manager or Customer Service to verify information regarding Franke Kitchen Systems programs and their use by you.

Copyright and Other Intellectual Property Rights. This document and our website are protected by copyright pursuant to U.S. copyright laws, international treaties, and other copyright laws. This document and our website contains copyrighted material, trademarks, and other proprietary information of Franke Consumer Products, Inc. and Franke Kitchen Systems, LLC and others (collectively “Proprietary Material”), which may include, but shall not be limited to: text, software, photos, video, graphics, images, music and sound. You may not modify, publish, copy, transmit, participate in the transfer or sale of, create derivative works of, or in any way exploit, in whole or in part, any Proprietary Material without the prior written authorization of Franke Kitchen Systems or the applicable rights holder.

Changes. We may change these terms and any part (or all) of the information enclosed at any time without notice. Any changes will apply to your future use, so you should contact your Regional Manager or Customer Service periodically. If you use this information after any changes to these terms, then you accept those changes.

Choice of Law. We are a Delaware limited liability company and these Terms and Conditions, and the purchase of products from Franke Kitchen Systems, shall be governed by the substantive laws of the State of Delaware, including the Uniform Commercial Code as adopted in Delaware, and the United Nations Convention on Contracts for the International Sale of Goods shall not apply. Any cause of action must be commenced within one year after the claim or cause of action arises. If a court of competent jurisdiction holds these terms and conditions or any part of them to be invalid, then that part shall be enforced to the maximum extent possible and the remainder of these terms and conditions will remain in full force and effect.

HOW TO CONTACT US**Contact Info**

Customer Service: 800-626-5771

Customer Service: ks-customerservice.us@franke.com

Marketing Services: 800-626-5771

Marketing Services Email: ks-marketing@franke.com

Mailing Address: Franke Kitchen Systems 800 Aviation Parkway Smyrna, TN 37167

Remittance Address: Franke Kitchen Systems 3215 Paysphere Circle, Chicago, IL 60674

Shipping Address: Franke Kitchen Systems 600 Franke Drive, Ruston, LA 71270

SINKS	Page	Price
BMSK802	126	\$268
BMSK803	126	\$268
CCK110-13WH	152	\$825
CCK110-15WH	152	\$845
CGK110-19WH	152	\$910
CLV110-24	62	\$1,545
CLV110-28	62	\$1,645
CLV110-31	62	\$1,745
CLV120-33	63	\$1,845
CUX11010-W	40	\$1,695
CUX11015	96	\$615
CUX11018-W	44	\$2,399
CUX11021	96	\$715
CUX11021-ADA	100	\$715
CUX11023	96	\$745
CUX11024-W	44	\$2,599
CUX11025	97	\$775
CUX11025-8	97	\$775
CUX11027	98	\$825
CUX11027-8	98	\$825
CUX11027-ADA	100	\$825
CUX11030	98	\$925
CUX11030-8	99	\$925
CUX11031-W	44	\$2,799
CUX120	99	\$1,025
CUX160	100	\$1,025
CUX16021-W	40	\$2,295
DIG61091-CHA	184	\$485
DIG61091-GRA	184	\$485
DIG61091-MOC	184	\$485
DIG61091-SHG	184	\$485
DIG61091-WHT	184	\$485
DIG62D91-CHA	184	\$545
DIG62D91-GRA	184	\$545
DIG62D91-MOC	184	\$545
DIG62D91-SHG	184	\$545
DIG62D91-WHT	184	\$545
DIG62F91-CHA	188	\$525
DIG62F91-GRA	188	\$525
DIG62F91-MOC	188	\$525
DIG62F91-SHG	188	\$525
DIG62F91-WHT	188	\$525
EDCH33229-1	180	\$485
EDDB33229-1	180	\$485
EDOX33229-1	180	\$485
ELG11022CHA	178	\$495
ELG11022MOC	178	\$495
ELG11022ONY	178	\$495
ELG11022OYS	178	\$495
ELG11022SHG	178	\$495
ELG11022STO	178	\$495
ELG11022VAN	178	\$495
ELG120CHA	178	\$575
ELG120MOC	178	\$575
ELG120ONY	178	\$575
ELG120OYS	178	\$575
ELG120SHG	178	\$575
ELG120STO	178	\$575
ELG120VAN	178	\$575
ELG160CHA	179	\$575
ELG160MOC	179	\$575
ELG160ONY	179	\$575
ELG160OYS	179	\$575
ELG160SHG	179	\$575
ELG160STO	179	\$575
ELG160VAN	179	\$575
EOCH33229-1	181	\$495
EODB33229-1	181	\$495
EOOX33229-1	181	\$495
ESCH25229-1	180	\$435
ESDB25229-1	180	\$435
ESOX25229-1	180	\$435
EVCAG901-18	121	\$510
EVCAG901-18KIT	121	\$585
EVCAG902-18KIT	121	\$675
EVCAG904-18	121	\$510

SINKS	Page	Price
EVCAG904-18KIT	121	\$585
EVDAG901-18	121	\$465
EVDAG901-18KIT	121	\$535
EVDAG904-18	121	\$465
EVDAG904-18KIT	121	\$535
EVDAS801-20	119	\$375
EVDAS804-20	119	\$375
EVDAG801-18	120	\$430
EVDAG804-18	120	\$430
EVDAG804-18KIT	120	\$490
EVDAG901-18	120	\$480
EVDAG901-18KIT	120	\$555
EVDAG904-18	120	\$480
EVDAG904-18KIT	120	\$555
EVDCC802KIT	122	\$585
EVSAS801-20	118	\$320
EVSAS804-20	118	\$320
EVSCG801-18	119	\$385
EVSCG801-18KIT	119	\$435
EVSCG804-18	119	\$385
EVSCG804-18KIT	119	\$435
FBSLD901-18BXKIT	127	\$495
FBSLD904-18BX	127	\$460
FFD33B-9-18	124	\$995
FFS30B-10-18	124	\$895
FFS30B-10-18KIT	124	\$970
FFS33B-10-18	124	\$925
FFS33B-10-18KIT	124	\$995
FH2K110-24WH	138	\$825
FH2K110-24MB	138	\$925
FH2K110-30WH	138	\$925
FH2K110-30MB	138	\$1,025
FH2K710-30WH	156	\$1,295
FH2K710-30GB	156	\$1,395
FH2K710-30BC	156	\$1,395
FH2K710-33WH	156	\$1,495
FH2K710-33GB	156	\$1,595
FH2K710-33BC	156	\$1,595
FH2K710-36WH	157	\$1,695
FH2K710-36GB	157	\$1,795
FH2K710-36BC	157	\$1,795
FH3K710-30WH	138	\$1,250
FH3K710-30MG	138	\$1,550
FH3K710-30MB	138	\$1,550
FH3K710-33WH	139	\$1,525
FH3K710-33MG	139	\$1,775
FH3K710-33MB	139	\$1,775
FHK710-30WH	139	\$1,550
FHK710-33WH	140	\$1,795
FHK710-36WH	140	\$2,075
GDX11012	104	\$540
GDX11015	104	\$585
GDX11018	104	\$675
GDX11023	105	\$745
GDX11028	105	\$795
GDX11031	106	\$855
GDX12031	106	\$925
HF3322-1	118	\$825
HF3322-1KIT	118	\$880
HF3322-2	125	\$825
HFO3322-1	126	\$820
HFS2522-1	117	\$660
HFS2522-1KIT	117	\$715
HFS3322-1	117	\$805
HFS3322-1KIT	117	\$860
HFS3322-2	117	\$805
HFT4322-2	125	\$995
HFT4322-2KIT	125	\$1,055
HFT4322-4	125	\$995
HFT4322-4KIT	125	\$1,055
HTS1722-1	116	\$475
HTS1722-1KIT	116	\$525
HTS2022-1	116	\$555
HTS2022-1KIT	116	\$575
KBG11013CHA	174	\$475
KBG11013MOC	174	\$475

SINKS	Page	Price
KBG11013ONY	174	\$475
KBG11013OYS	174	\$475
KBG11013SHG	174	\$475
KBG11013STO	174	\$475
KBG11013VAN	174	\$475
KBG11031CHA	174	\$575
KBG11031MOC	174	\$575
KBG11031ONY	174	\$575
KBG11031OYS	174	\$575
KBG11031SHG	174	\$575
KBG11031STO	174	\$575
KBG11031VAN	174	\$575
KBX110-13	66	\$620
KBX110-18	66	\$860
KBX110-8	66	\$620
KBX11021	67	\$960
KBX11028	67	\$1,065
KBX12034	68	\$1,765
KBX12039	68	\$1,810
KBX12043	68	\$1,960
KBX160	69	\$1,760
LRX110-2310-316	59	\$825
LRX110-2312-316	59	\$875
MHK110-20WH	134	\$1,050
MHK110-24WH	134	\$1,390
MHK110-28WH	134	\$1,475
MHK720-31WH	135	\$1,860
MHK720-35WH	135	\$2,485
MHX710-30	36	\$1,995
MHX710-33	36	\$2,395
MHX710-36	36	\$2,895
OR2X110	82	\$995
ORG110CHA	170	\$755
ORG110MOC	170	\$755
ORG110ONY	170	\$755
ORG110OYS	170	\$755
ORG110SHG	170	\$755
ORG110STO	170	\$755
ORG110VAN	170	\$755
ORK110WH	144	\$1,650
ORX110	83	\$1,035
PCX1102109	88	\$675
PEX110-14	72	\$1,115
PEX110-21	72	\$1,375
PEX110-28	72	\$1,475
PEX110-31	73	\$1,575
PKG11014CHA	164	\$495
PKG11014MOC	164	\$495
PKG11014ONY	164	\$495
PKG11014OYS	164	\$495
PKG11014SHG	164	\$495
PKG11014STO	164	\$495
PKG11014VAN	164	\$495
PKG11020CHA	164	\$595
PKG11020MOC	164	\$595
PKG11020ONY	164	\$595
PKG11020OYS	164	\$595
PKG11020SHG	164	\$595
PKG11020STO	164	\$595
PKG11020VAN	164	\$595
PKG11031CHA	165	\$695
PKG11031MOC	165	\$695
PKG11031ONY	165	\$695
PKG11031OYS	165	\$695
PKG11031SHG	165	\$695
PKG11031STO	165	\$695
PKG11031VAN	165	\$695
PKG160CHA	166	\$755
PKG160MOC	166	\$755
PKG160ONY	166	\$755
PKG160OYS	166	\$755
PKG160SHG	166	\$755
PKG160STO	166	\$755
PKG160VAN	166	\$755
PKX11013	48	\$1,870
PKX11016	48	\$2,070

SINKS	Page	Price
PKX11018	49	\$2,230
PKX11021	49	\$2,370
PKX11025	50	\$2,430
PKX11028	50	\$2,530
PKX1108	48	\$1,170
PKX160	50	\$2,870
PKX160LH	50	\$2,870
PRK11021WH	148	\$1,015
PRX11021	88	\$775
PS2X110-15	54	\$1,395
PS2X110-18	54	\$1,445
PS2X110-21	54	\$1,495
PS2X110-24	55	\$1,555
PS2X110-24-12	55	\$1,595
PS2X110-27	56	\$1,655
PS2X110-30	56	\$1,755
PS2X110-30-12	56	\$1,855
PS2X110-33	57	\$1,955
PS2X120-14-14	58	\$2,095
PS2X120-16-16	58	\$2,195
PS2X160-18-11	57	\$2,095
PTX110-14	76	\$595
PTX110-17	76	\$675
PTX110-20	76	\$875
PTX110-22	77	\$975
PTX110-25	77	\$1,025
PTX110-28	78	\$1,095
PTX110-31	78	\$1,195
RBX-110	110	\$535
RGX160	92	\$965
SC3322-1	188	\$485
SGR3322-1	188	\$485
SL101BX	127	\$278
SL103BX	127	\$278
SL103BXKIT	127	\$330
SOX1720-1	192	\$365
SP3322-1	188	\$485
SZCH1720-1	192	\$365
SZGR1720-1	192	\$365
SZPW1720-1	192	\$410

FAUCETS	Page	Price
FF3970	247	\$655
FF3980	247	\$655
FF3990	247	\$655
FF4250	249	\$545
FF4400	226	\$565
FF4420	226	\$665
FF4480	226	\$665
FF4700	227	\$560
FF4720	227	\$660
FF4780	227	\$660
FF4800	226	\$590
FF4880	226	\$690
FF4900	214	\$760
FF4980	214	\$925
FF5200	220	\$615
FF5220	220	\$750
FF5270	220	\$750
FF5280	220	\$750
FF5300	209	\$675
FF5380	209	\$795
FF5700	257	\$495
FF5720	257	\$565
FF5780	257	\$565
FF6000A	204	\$1,598
FF6070A	204	\$1,785
FF6080A	204	\$1,785
FF7000A	204	\$1,598
FF7070A	204	\$1,785
FF7080A	204	\$1,785
FFB2800	217	\$430
FFB2880	217	\$515
FFB2900	245	\$390
FFB2980	245	\$490
FFB3100	232	\$375
FFB3170	232	\$475
FFB3180	232	\$475
FFB3350	253	\$430
FFB3450	241	\$450
FFB3550	237	\$420
FFB4250	249	\$395
FFB5200	221	\$440
FFB5220	221	\$540
FFB5270	221	\$540
FFB5280	217	\$535
FFP2800	217	\$635
FFP2880	217	\$635
FFP2900	245	\$475
FFP2980	245	\$575
FFP3100	232	\$525
FFP3170	232	\$625
FFP3180	232	\$625
FFP3350	252	\$530
FFP3450	241	\$580
FFP3550	237	\$600
FFP4250	249	\$495
FFP4400	227	\$410
FFP4480	227	\$510
FFP5200	221	\$585
FFP5220	221	\$710
FFP5270	221	\$710
FFP5280	221	\$710
FFPD2000	211	\$1,025
FFPD20400	257	\$465
FFPD20480	257	\$520
FFPD2080	211	\$1,225
FFPD20850	256	\$620
FFPD3350	252	\$530
FFPD400	205	\$795
FFPD4300	226	\$720
FFPD4350	226	\$850
FFPD4400	226	\$585
FFPD4450	226	\$750
FFPD4600	210	\$1,125
FFPD4611	210	\$1,225
FFPD4621	210	\$1,225
FFPD4680	210	\$1,325

FAUCETS	Page	Price
FFPD470	205	\$925
FFPD480	205	\$925
FFPD5300	209	\$995
FFPD5380	209	\$1,195
FFPD5400	209	\$1,095
FFPD5480		

FILTRATION	Page	Price	FILTRATION	Page	Price	SOAP DISPENSERS	Page	Price	ACCESSORIES	Page	Price	ACCESSORIES	Page	Price	ACCESSORIES	Page	Price
DW14050	238, 273	\$435	LB12280	207, 264	\$635	SD2680	217, 284	\$215	900W	298	\$55	EVBG1315	119, 121, 122	\$95	PE-21S	73	\$171
DW15000	221, 266	\$430	LB13150	242, 272	\$435	SD3100	235, 285	\$120	906D-SN	298	\$145	EVBG1318	121	\$106	PE-28S	73	\$191
DW15020	221, 266	\$505	LB13150-110-HT100	272	\$875	SD3170	235, 285	\$150	906P-C	45, 63, 73, 77, 78, 97, 99, 101, 300	\$124	EVBG2115	119	\$116	PE-31S	73	\$212
DW15070	221, 266	\$505	LB13250	242, 272	\$535	SD3180	235, 285	\$150	906P-SN	45, 63, 73, 77, 78, 97, 99, 101, 300	\$145	FBBG2716	188	\$137	PE-40S	73	\$243
DW15080	221, 266	\$505	LB13250-100-HT	272	\$1,025	SD3200	247, 286	\$115	906SN	37, 45, 55, 57, 59, 67, 69, 73, 77, 78, 82, 83, 88, 92, 97, 99, 101, 105, 106, 110, 135, 139, 140, 144, 148, 153, 157, 165, 166, 170, 174, 179, 298	\$85	FBG110S	127	\$92	PE-70S	55, 57, 59, 63, 73, 77, 78	\$212
DW16000	228, 267	\$420	LB14150	238, 273	\$435	SD3201	247, 286	\$145	AG100	299	\$50	FBG180S	192	\$85	PG-40S	165, 166	\$212
DW16020	228, 267	\$495	LB14250	238, 273	\$535	SD3202	247, 286	\$145	AG120	299	\$55	FBG2817	127	\$144	PG2-40S	165	\$205
DW16022	228, 267	\$495	LB15100	222, 266	\$420	SD3203	247, 286	\$145	AG122	299	\$55	FBG65S	127	\$67	PK21-31S	148	\$150
DW16040	228, 267	\$495	LB15120	222, 266	\$495	SD3204	247, 286	\$145	AG140	299	\$55	FBGG1014	181	\$95	PK21-36S	148	\$150
DW16061	228, 267	\$495	LB15170	222, 266	\$495	SD3205	247, 286	\$145	AG150	299	\$55	FBGG1114	181	\$95	PKG12-36RM	166	\$127
DW16065	228, 267	\$495	LB15180	222, 266	\$495	SD3206	247, 286	\$145	AG161	299	\$55	FBGG1316	181	\$106	PKG12-36S	166	\$138
DW16070	228, 267	\$495	LB15200	222, 267	\$525	SD3207	247, 286	\$145	AG165	299	\$55	FBGG1914	181	\$116	PKG14-31RM	165	\$125
DW16080	228, 267	\$495	LB15220	222, 267	\$635	SD3220	247, 286	\$145	AG170	299	\$60	FBGH1613	125	\$90	PKG14-36RM	165	\$155
DW16090	228, 267	\$495	LB15270	222, 267	\$635	SD3222	247, 286	\$145	AG180	299	\$60	FK2-24-36S	139	\$175	PKG17-36RM	166	\$159
DW5600	213, 263	\$375	LB15280	222, 267	\$635	SD3240	247, 286	\$145	AG190	299	\$55	FK2-30-36S	139, 157	\$215	PKG17-36S	166	\$159
DW5620	213, 263	\$425	LB16100	228, 267	\$430	SD3261	247, 286	\$145	BGDI100	184	\$116	FK2-33-36S	157	\$245	PKG17-36S	166	\$159
DW6100C	205, 263	\$395	LB16120	228, 267	\$505	SD3265	247, 286	\$145	BGDI110	184	\$126	FK3-30-36S	139	\$243	PKG18-31RM	165, 166	\$149
DW6170C	205, 263	\$480	LB16122	228, 267	\$505	SD3270	247, 286	\$145	BGDI150	188	\$116	FK30-36S	139	\$243	PKG20-36RM	165	\$175
DW6180C	205, 263	\$480	LB16140	228, 267	\$505	SD3280	247, 286	\$145	BGDIS150	188	\$116	FK33-36S	140	\$274	PKG31-36RM	165	\$202
DW7000C	233, 268	\$395	LB16140	228, 267	\$505	SD3280	247, 286	\$145	BGHF101	117	\$105	FK33-36S	140	\$274	PKG31-36S	165	\$212
DW7000C-100	268	\$550	LB16161	228, 267	\$505	SD3290	247, 286	\$145	BGHF115	117	\$116	FK3-33-36S	139	\$245	PKG31-36S	45, 77, 78, 165, 166, 299	\$82
DW7070C	233, 268	\$480	LB16165	228, 267	\$505	SD3450	242, 284	\$245	BGHF200	117, 125	\$95	FK36-36S	140	\$285	PKXCVR	49, 51, 299	\$95
DW7080C	233, 268	\$480	LB16170	228, 267	\$505	SD5200	222, 285	\$170	BGHF210	119, 127	\$92	FQ3SB	301	\$695	PR-31S	88	\$150
DW7080C-100	268	\$615	LB16180	228, 267	\$505	SD5270	222, 285	\$170	BGHF400	117	\$95	FRTWIST-SN	37, 49, 51, 300	\$155	PR-36S	88	\$150
DW9000C	265	\$385	LB16200	228, 268	\$525	SD5280	222, 285	\$170	BP100	299	\$56	GD12-36S	105	\$126	PS2-11-36S	57	\$119
DW9000C-100	265	\$535	LB16220	228, 268	\$635	SD6000	207, 285	\$180	BP180	299	\$72	GD15-36S	105	\$137	PS2-14-36S	59	\$129
DW9070C	265	\$470	LB16222	228, 268	\$635	SD6070	207, 285	\$210	CK13-36C	153	\$202	GD18-36S	105	\$150	PS2-15-36S	55	\$140
DW9080C	265	\$470	LB16240	228, 268	\$635	SD6080	207, 285	\$210	CK15-36C	153	\$212	GD23-36S	105	\$160	PS2-16-36S	59	\$140
DW9080C-100	265	\$615	LB16261	228, 268	\$635				CK19-36C	153	\$223	GD28-36S	105	\$191	PS2-18-36S	55, 57	\$150
FFT3100	233, 262	\$425	LB16265	228, 268	\$635	DISPOSERS			CL-14-36S	63	\$150	GD28-40S	105	\$243	PS2-21-36S	55	\$181
FFT3170	233, 262	\$525	LB16270	228, 268	\$635	FWDJ125	291	\$475	CL-24-36S	63	\$150	GD31-36S	106	\$202	PS2-24-36S	55	\$191
FFT3180	233, 262	\$525	LB16280	228, 268	\$635	FWDJ50	291	\$235	CL-28-36S	63	\$160	GD40S	105, 106	\$243	PS2-27-36S	57	\$212
FFT3350	253, 262	\$450	LB16290	228, 268	\$635	FWDJ75	291	\$375	CL-31-36S	63	\$171	KB-36RM	67, 69	\$150	PS2-30-36S	57	\$243
FFT5200	221, 262	\$515	LB6100C	206, 263	\$395	FWDJ75B	291	\$455	CL-BGC	63	\$137	KB-40S	67, 69	\$202	PS2-33-36S	57	\$264
FFT5220	221, 262	\$615	LB6170C	206, 263	\$480	WD3428BK	293	\$31	CL-SSC	63	\$116	KB-70C	67, 69	\$245	PS2-40S	55, 57, 59, 63	\$212
FFT5270	221, 262	\$615	LB6180C	206, 263	\$480	WD3428C	293	\$31	CP-50C	92	\$254	KB13-36S	67, 69	\$126	PS2-45S	55, 57, 59, 63	\$212
FFT5280	221, 262	\$615	LB6200C	206, 263	\$545	WD3428PN	293	\$31	CU11-36S	101	\$116	KB17-31C	67, 69	\$95	PS23-36S	59	\$245
FHF-100	277	\$280	LB6270C	206, 263	\$655	WD3428SN	293	\$31	CU15-36S	97, 99	\$126	KB18-31S	67, 69	\$126	PT14-31S	77, 78	\$137
FHFC-100	276	\$380	LB6280C	206, 263	\$655	WD907BLK	294	\$65	CU18-36S	101	\$137	KB18-36S	67, 69	\$137	PT14-36S	77	\$137
FM100	280	\$45	LB7100C	234, 269	\$395	WD9088	293	\$119	CU21-36S	97, 101	\$137	KB21-31S	67, 69	\$160	PT17-36S	77	\$137
FRC06	278	\$75	LB7100C-110-HT	269	\$915	WD930CH	294	\$65	CU23-36S	97	\$137	KB21-36S	67, 69	\$160	PT20-36S	77	\$150
FRC06-2PK	278	\$135	LB7170C	234, 269	\$480	WD981SN	294	\$65	CU25-36S	97	\$150	KB28-31S	67	\$160	PT22-36S	77	\$150
FRC07	278	\$75	LB7180C	234, 269	\$480	WD982PN	294	\$65	CU27-36S	99, 101, 125	\$150	KB28-36S	67	\$243	PT25-36S	77	\$150
FRC08	278	\$75	LB7180C-110-HT	269	\$980	WDFLANGE-CH	294	\$58	CU30-36S	99, 125	\$160	KBG13-36S	174	\$126	PT28-36S	78	\$160
FRC09	279	\$45	LB7200C	234, 269	\$545	WDFLANGE-EX-SN	294	\$60	CU40K	40	\$235	KBG31-36S	174	\$202	PT31-36S	78	\$171
FRC10	279	\$85	LB7200C-100-HT	269	\$1,025	WDFLANGE-EX-WH	294	\$60	CU40P	40, 97, 99, 101	\$95	MH30-36S	37	\$212	PT40S	77, 78	\$202
FRCNSTR	276	\$305	LB7270C	234, 269	\$655	WDFLANGE-SS	294	\$58	CU40S	40, 97, 99, 101	\$145	MH33-36S	37	\$233	PT41S	77, 78	\$191
FRCNSTR-DUO-1	276	\$229	LB7280C	234, 269	\$655	WDJ33	293	\$165	CU40S	40, 97, 99, 101	\$145	MH36-36S	37	\$254	PX-13S	49	\$137
FRCNSTR-DUO-2	276	\$229	LB7280C-100-HT	269	\$1,125	WDJ33NC	293	\$150	CU40S	40, 97, 99, 101	\$145	MK24-36C	135	\$212	PX-16S	49	\$137
FRCNSTR100	275	\$199	LB9100C	265	\$385	WDJ50	292	\$195	CU40S	40, 97, 99, 101	\$145	MK28-36C	135	\$233	PX-18S	49	\$150
FRCNSTR110	275	\$209	LB9100C-110-HT	265	\$900	WDJ50NC	292	\$175	CU40S	40, 97, 99, 101	\$145	MK31-36C-LH	135	\$223	PX-21S	49, 51	\$181
FRX02	278	\$75	LB9170C	265	\$470	WDJ75	292	\$275	CU40S	40, 97, 99, 101	\$145	MK31-36C-RH	135	\$223	PX-25S	51	\$191
FRX02-2PK	278	\$135	LB9180C	265	\$470	WDJ75NC	292	\$255	CU40S	40, 97, 99, 101	\$145	MK35-36C-LH	135	\$264	PX-28S	51	\$202
HT-100	274	\$350	LB9180C-110-HT	265	\$975	ACCESSORIES			CU40S	40, 97, 99, 101	\$145	MK35-36C-RH	135	\$264	PX-40S	49, 51	\$212
HT-250	274	\$430	LB9200C	266	\$535	628	301	\$7	CU40S	40, 97, 99, 101	\$145	NC15-36S	106	\$120	PX-70S	49, 51	\$202
HT-300	274	\$430	LB9200C-100-HT	266	\$1,025	903	37, 45, 49, 51, 55, 57, 59, 63, 67, 69, 73, 82, 83, 88, 92, 97, 99, 101, 105, 106, 110, 110, 135, 139, 140, 144, 148, 153, 157, 165, 166, 170, 174, 179, 298	\$31	CU40S	40, 97, 99, 101	\$145	OA-40S	37, 135, 139, 140, 144, 148, 153, 157	\$350	RBG-36S	110	\$150
HT-400	274	\$400	LB9270C	266	\$635				CU40S	40, 97, 99, 101	\$145				RG-36S	92	\$150
LB10100	234, 270	\$420	LB9280C	266	\$635				CU40S	40, 97, 99, 101	\$145				RG-36S-RH	92	\$150
LB10100-110-HT	270	\$930	LB9280C-100-HT	266	\$1,125				CU40S	40, 97, 99, 101	\$145						

PRODUCT NO.	Page	Price	PRODUCT NO.	Page	Price	PRODUCT NO.	Page	Price	PRODUCT NO.	Page	Price	PRODUCT NO.	Page	Price	PRODUCT NO.	Page	Price
628	301	\$7	CL-SSC	63	\$116	DW15020	221, 266	\$505	EVDCG804-18	120	\$430	FF5280	220	\$750	FFPS3450	241	\$580
903	37, 45, 49, 51, 55, 57, 59, 63, 67, 69, 73, 82, 83, 88, 92, 97, 99, 101, 105, 106, 110, 117, 119, 121, 122, 301	\$31	CL-WGC	63	\$137	DW15070	221, 266	\$505	EVDCG804-18KIT	120	\$490	FF5300	209	\$675	FFPS3600	233	\$425
			CLV110-24	62	\$1,545	DW15080	221, 266	\$505	EVDCG901-18	120	\$480	FF5380	209	\$795	FFPS3680	233	\$525
			CLV110-28	62	\$1,645	DW16000	228, 267	\$420	EVDCG901-18KIT	120	\$555	FF5700	257	\$495	FFPS4300	232	\$415
			CLV110-31	62	\$1,745	DW16020	228, 267	\$495	EVDCG904-18	120	\$480	FF5720	257	\$565	FFPS4320	232	\$495
			CLV120-33	63	\$1,845	DW16022	228, 267	\$495	EVDCG904-18KIT	120	\$555	FF5780	257	\$565	FFPS4380	232	\$495
			CP-50C	92	\$254	DW16040	228, 267	\$495	EVDCS802KIT	122	\$585	FF6000A	204	\$1,598	FFPS4395	232	\$495
			CT-200	275	\$985	DW16061	228, 267	\$495	EVSAS801-20	118	\$320	FF6070A	204	\$1,785	FFPS5200	220	\$615
			CT-400	275	\$800	DW16065	228, 267	\$495	EVSAS804-20	118	\$320	FF6080A	204	\$1,785	FFPS5220	220	\$750
			CU-40K	40	\$235	DW16070	228, 267	\$495	EVSCG801-18	119	\$385	FF7000A	204	\$1,598	FFPS5270	220	\$750
			CU-40P	40, 97, 99, 101	\$95	DW16080	228, 267	\$495	EVSCG801-18KIT	119	\$435	FF7070A	204	\$1,785	FFPS5280	220	\$750
			CU-40S	40, 97, 99, 101	\$145	DW16090	228, 267	\$495	EVSCG804-18	119	\$385	FF7080A	204	\$1,785	FFS100	204	\$925
			CU-FC	40	\$195	DW5600	213, 263	\$375	EVSCG804-18KIT	119	\$435	FFB2800	217	\$430	FFS170	204	\$1,030
			CU-GC	40	\$115	DW5620	213, 263	\$425	FBBG2716	188	\$137	FFB2880	217	\$515	FFS180	204	\$1,030
			CU-KS	40	\$95	DW6100C	205, 263	\$395	FBG110S	127	\$92	FFB2900	245	\$390	FFS30B-10-18	124	\$895
			CU-WR	40	\$125	DW6170C	205, 263	\$480	FBG180S	192	\$85	FFB2980	245	\$490	FFS30B-10-18KIT	124	\$970
			CU11-36S	101	\$116	DW6180C	205, 263	\$480	FBG2817	127	\$144	FFB3100	232	\$375	FFS33B-10-18	124	\$925
			CU15-36S	97, 99	\$126	DW7000C	233, 268	\$395	FBG65S	127	\$67	FFB3170	232	\$475	FFS33B-10-18KIT	124	\$995
			CU18-36S	101	\$137	DW7000C-100	268	\$550	FBGG1014	181	\$95	FFB3180	232	\$475	FFS400	204	\$925
			CU21-36S	97, 101	\$137	DW7070C	233, 268	\$480	FBGG1114	181	\$95	FFB3350	253	\$430	FFS470	204	\$1,030
			CU23-36S	97	\$137	DW7080C	233, 268	\$480	FBGG1316	181	\$106	FFB3450	241	\$450	FFS480	204	\$1,030
			CU25-36S	97	\$150	DW7080C-100	268	\$615	FBGG1914	181	\$116	FFB3550	237	\$420	FFS5200	220	\$720
			CU27-36S	99, 101, 125	\$150	DW9000C	265	\$385	FBGH1613	125	\$90	FFB4250	249	\$395	FFS5220	220	\$865
			CU30-36S	99, 125	\$160	DW9000C-100	265	\$535	FBSLD901-18BXXKIT	127	\$495	FFB5200	221	\$440	FFS5270	220	\$865
			CUW-36RM	45	\$137	DW9070C	265	\$470	FBSLD904-18BX	127	\$460	FFB5220	221	\$540	FFS5280	220	\$865
			CUW-40S	45	\$160	DW9080C	265	\$470	FF20300	257	\$385	FFB5270	221	\$540	FFT3100	233, 262	\$425
			CUW-60S	45	\$181	DW9080C-100	265	\$615	FF20380	257	\$440	FFB5280	221	\$540	FFT3170	233, 262	\$525
			CUW-70S	40, 45, 97, 99, 101	\$191	EDCH33229-1	180	\$485	FF20650	256	\$460	FFD33B-9-18	124	\$995	FFT3180	233, 262	\$525
			CUW18-36S	45	\$137	EDDB33229-1	180	\$485	FF20750	256	\$505	FFP2800	217	\$535	FFT3350	253, 262	\$450
			CUW24-36S	45	\$150	EDOX33229-1	180	\$485	FF22300	258	\$295	FFP2880	217	\$635	FFT5200	221, 262	\$515
			CUW31-36S	45	\$160	ELG11022CHA	178	\$495	FF22380	258	\$325	FFP2900	245	\$475	FFT5220	221, 262	\$615
			CUX11010-W	40	\$1,695	ELG11022MOC	178	\$495	FF2800	217	\$745	FFP2980	245	\$575	FFT5270	221, 262	\$615
			CUX11015	96	\$615	ELG11022ONY	178	\$495	FF2880	217	\$950	FFP3100	232	\$525	FFT5280	221, 262	\$615
			CUX11018-W	44	\$2,399	ELG11022OYS	178	\$495	FF2900	245	\$565	FFP3170	232	\$625	FH2K110-24MB	138	\$925
			CUX11021	96	\$715	ELG11022SHG	178	\$495	FF2980	245	\$665	FH2K110-24WH	232	\$625	FH2K110-24WH	138	\$825
			CUX11021-ADA	100	\$715	ELG11022STO	178	\$495	FF3100	232	\$560	FFP3350	252	\$530	FH2K110-30MB	138	\$1,025
			CUX11023	96	\$745	ELG11022VAN	178	\$495	FF3170	232	\$660	FFP3450	241	\$580	FH2K110-30WH	138	\$925
			CUX11024-W	44	\$2,599	ELG120CHA	178	\$575	FF3180	232	\$660	FFP3550	237	\$600	FH2K710-30BC	156	\$1,395
			CUX11025	97	\$775	ELG120MOC	178	\$575	FF3200	243	\$610	FFP4250	249	\$495	FH2K710-30GB	156	\$1,395
			CUX11025-8	97	\$775	ELG120ONY	178	\$575	FF3280	243	\$710	FFP4400	227	\$410	FH2K710-30WH	156	\$1,295
			CUX11027	98	\$825	ELG120OYS	178	\$575	FF3350	252	\$560	FFP4480	227	\$510	FH2K710-33BC	156	\$1,595
			CUX11027-8	98	\$825	ELG120SHG	178	\$575	FF3352	252	\$580	FFP5200	221	\$585	FH2K710-33GB	156	\$1,595
			CUX11027-ADA	100	\$825	ELG120STO	178	\$575	FF3450	240	\$630	FFP5220	221	\$710	FH2K710-33WH	156	\$1,495
			CUX11030	98	\$925	ELG120VAN	178	\$575	FF3550	237	\$640	FFP5270	221	\$710	FH2K710-36BC	157	\$1,795
			CUX11030-8	99	\$925	ELG13-36S	179	\$126	FF3800	247	\$555	FFP5280	221	\$710	FH2K710-36GB	157	\$1,795
			CUX11031-W	44	\$2,799	ELG14-36S	179	\$137	FF3801	247	\$605	FFPD2000	211	\$1,025	FH2K710-36WH	157	\$1,695
			CUX120	99	\$1,025	ELG16-36S	179	\$150	FF3802	247	\$605	FFPD20400	257	\$465	FH3K710-30MB	138	\$1,550
			CUX160	100	\$1,025	ELG160CHA	179	\$575	FF3803	247	\$605	FFPD20480	257	\$520	FH3K710-30MG	138	\$1,550
			CUX16021-W	40	\$2,295	ELG160MOC	179	\$575	FF3804	247	\$605	FFPD2080	211	\$1,225	FH3K710-30WH	138	\$1,250
			DIG61091-CHA	184	\$485	ELG160MOC	179	\$575	FF3805	247	\$605	FFPD20850	256	\$620	FH3K710-33MB	139	\$1,775
			DIG61091-GRA	184	\$485	ELG160ONY	179	\$575	FF3806	247	\$605	FFPD3350	252	\$530	FH3K710-33MG	139	\$1,775
			DIG61091-MOC	184	\$485	ELG160SHG	179	\$575	FF3807	247	\$605	FFPD400	205	\$795	FH3K710-33WH	139	\$1,525
			DIG61091-SHG	184	\$485	ELG160STO	179	\$575	FF3880	247	\$655	FFPD4300	226	\$720	FHF-100	277	\$280
			DIG62D91-CHA	184	\$545	ELG160VAN	179	\$575	FF3900	247	\$555	FFPD4350	226	\$850	FHFC-100	276	\$380
			DIG62D91-GRA	184	\$545	ELG22-36S	179	\$150	FF3920	247	\$655	FFPD4400	226	\$585	FHK710-30WH	139	\$1,550
			DIG62D91-MOC	184	\$545	EOCH33229-1	181	\$495	FF3922	247	\$655	FFPD4450	226	\$750	FHK710-33WH	140	\$1,795
			DIG62D91-SHG	184	\$545	EODB33229-1	181	\$495	FF3940	247	\$655	FFPD4600	210	\$1,125	FHK710-36WH	140	\$2,075
			DIG62D91-WHT	184	\$545	EOOX33229-1	181	\$495	FF3961	247	\$655	FFPD4611	210	\$1,225	FK2-24-36S	139	\$175
			DIG62F91-CHA	188	\$525	ESCH25229-1	180	\$435	FF3965	247	\$655	FFPD4621	210	\$1,225	FK2-30-36S	139, 157	\$215
			DIG62F91-GRA	188	\$525	ESDB25229-1	180	\$435	FF3970	247	\$655	FFPD4680	210	\$1,325	FK2-33-36S	157	\$245
			DIG62F91-MOC	188	\$525	ESOX25229-1	180	\$435	FF3980	247	\$655	FFPD470	205	\$925	FK2-36-36S	157	\$255
			DIG62F91-SHG	188	\$525	EVBG1315	119, 121, 122	\$95	FF3990	247	\$655	FFPD480	205	\$925	FK3-30-36S	139	\$225
			DIG62F91-WHT	188	\$525	EVBG1318	121	\$106	FF4250	249	\$545	FFPD5300	209	\$995	FK3-33-36S	139	\$245
			DW10000	234, 270	\$420	EVBG2115	119	\$116	FF4400	226	\$565	FFPD5380	209	\$1,195	FK30-36S	139	\$243
			DW10000-100	270	\$565	EVCAG901-18	121	\$510	FF4420	226	\$665	FFPD5400	209	\$1,095	FK33-36S	140	\$274
			DW10070	234, 270	\$495	EVCAG901-18KIT	121	\$585	FF4480	226	\$665	FFPD5480	209	\$1,295	FK36-36S	140	\$285
			DW10080	234, 270	\$495	EVCAG902-18KIT	121										

PRODUCT NO.	Page	Price	PRODUCT NO.	Page	Price	PRODUCT NO.	Page	Price	PRODUCT NO.	Page	Price	PRODUCT NO.	Page	Price			
FRCNSTR100	275	\$199	KBX11028	67	\$1,065	LB9270C	266	\$635	PF7080A	205	\$925	PS2X110-21	54	\$1,495	SD6080	207, 285	\$210
FRCNSTR110	275	\$209	KBX12034	68	\$1,765	LB9280C	266	\$635	PFD4400	227	\$510	PS2X110-24	55	\$1,555	SGR3322-1	188	\$485
FRTWIST-SN	37, 49, 51, 300	\$155	KBX12039	68	\$1,810	LB9280C-100-HT	266	\$1,125	PFD4480	227	\$615	PS2X110-24-12	55	\$1,595	SL101BX	127	\$278
FRX02	278	\$75	KBX12043	68	\$1,960	LRX110-2310-316	59	\$825	PG-40S	165, 166	\$212	PS2X110-27	56	\$1,655	SL103BX	127	\$278
FRX02-2PK	278	\$135	KBX160	69	\$1,760	LRX110-2312-316	59	\$875	PG2-40S	165	\$205	PS2X110-30	56	\$1,755	SL103BXXKIT	127	\$330
FWDJ125	291	\$475	LB10100	234, 270	\$420	MH30-36S	37	\$212	PK21-31S	148	\$150	PS2X110-30-12	56	\$1,855	SOX1720-1	192	\$365
FWDJ50	291	\$235	LB10100-110-HT	270	\$930	MH33-36S	37	\$233	PK21-36S	148	\$150	PS2X110-33	57	\$1,955	SP-41S	40	\$29
FWDJ75	291	\$375	LB10100-110-HT100	270	\$865	MH36-36S	37	\$254	PKG11014CHA	164	\$495	PS2X120-14-14	58	\$2,095	SP-40S	45, 77, 78	\$52
FWDJ75B	291	\$455	LB10170	234, 270	\$505	MHK110-20WH	134	\$1,050	PKG11014MOC	164	\$495	PS2X120-16-16	58	\$2,195	SP-FC1	213, 279	\$59
GD-40S	105, 106	\$243	LB10180	234, 270	\$505	MHK110-24WH	134	\$1,390	PKG11014ONY	164	\$495	PS2X160-18-11	57	\$2,095	SP-FC3	213, 279	\$149
GD12-36S	105	\$126	LB10180-110-HT	270	\$1,005	MHK110-28WH	134	\$1,475	PKG11014OYS	164	\$495	PT-40S	77, 78	\$202	SP3322-1	188	\$485
GD15-36S	105	\$137	LB10180-110-HT100	270	\$935	MHK720-31WH	135	\$1,860	PKG11014SHG	164	\$495	PT1-41S	77, 78	\$191	SZCH1720-1	192	\$365
GD18-36S	105	\$150	LB10200	235, 271	\$525	MHK720-35WH	135	\$2,485	PKG11014STO	164	\$495	PT14-31S	77, 78	\$137	SZGR1720-1	192	\$365
GD23-36S	105	\$160	LB10200-100-HT	271	\$1,020	MHX710-30	36	\$1,995	PKG11014VAN	164	\$495	PT14-36S	77	\$137	SZPW1720-1	192	\$410
GD28-36S	105	\$191	LB10270	235, 271	\$635	MHX710-33	36	\$2,395	PKG11020CHA	164	\$595	PT17-36S	77	\$137	UV-36RM	49, 51, 73,	\$160
GD28-40S	105	\$243	LB10280	235, 271	\$635	MHX710-36	36	\$2,895	PKG11020MOC	164	\$595	PT20-36S	77	\$150		77, 78, 82,	
GD31-36S	106	\$202	LB10280-100-HT	271	\$1,115	MK24-36C	135	\$212	PKG11020OY	164	\$595	PT22-36S	77	\$150		83, 88, 92,	
GDX11012	104	\$540	LB12100	206, 264	\$420	MK28-36C	135	\$233	PKG11020OYS	164	\$595	PT25-36S	77	\$150		97, 99, 101,	
GDX11015	104	\$585	LB12180	206, 264	\$495	MK31-36C-LH	135	\$223	PKG11020SHG	164	\$595	PT28-36S	78	\$160		105, 106,	
GDX11018	104	\$675	LB12200	207, 264	\$525	MK31-36C-RH	135	\$223	PKG11020STO	164	\$595	PT31-36S	78	\$171		110, 144,	
GDX11023	105	\$745	LB12280	207, 264	\$635	MK35-36C-LH	135	\$264	PKG11020VAN	164	\$595	PTX110-14	76	\$595		148, 153,	
GDX11028	105	\$795	LB13150	242, 272	\$435	MK35-36C-RH	135	\$264	PKG11031CHA	165	\$695	PTX110-17	76	\$675		157, 170,	
GDX11031	106	\$855	LB13150-110-HT100	272	\$875	NC15-36S	106	\$120	PKG11031MOC	165	\$695	PTX110-20	76	\$875		174, 179, 298	
GDX12031	106	\$925	LB13250	242, 272	\$535	OA-40S	37, 135, 139,	\$350	PKG11031ONY	165	\$695	PTX110-22	77	\$975	WD3428BK	293	\$31
HF3322-1	118	\$825	LB13250-100-HT	272	\$1,025		140, 144, 148,		PKG11031OYS	165	\$695	PTX110-25	77	\$1,025	WD3428C	293	\$31
HF3322-1KIT	118	\$880	LB14150	238, 273	\$435	OC-31S-LH	83, 170	\$160	PKG11031SHG	165	\$695	PTX110-28	78	\$1,095	WD3428PN	293	\$31
HF3322-2	125	\$825	LB14250	238, 273	\$535	OC-31S-RH	83, 170	\$160	PKG11031STO	165	\$695	PTX110-31	78	\$1,195	WD3428SN	293	\$31
HF3322-2	125	\$825	LB15100	222, 266	\$420	OC-36S	83, 170	\$223	PKG11031VAN	165	\$695	PX-13S	49	\$137	WD907BLK	294	\$65
HFO3322-1	126	\$820	LB15120	222, 266	\$495	OC-45SP	83, 170	\$424	PKG12-36RM	166	\$127	PX-16S	49	\$137	WD9088	293	\$119
HFS2522-1	117	\$660	LB15170	222, 266	\$495	OC-60S	83	\$150	PKG12-36S	166	\$138	PX-18S	49	\$150	WD930CH	294	\$65
HFS2522-1KIT	117	\$715	LB15180	222, 266	\$495	OC2-31S-RH	82	\$155	PKG14-31RM	165	\$125	PX-21S	49, 51	\$181	WD981SN	294	\$65
HFS3322-1	117	\$805	LB15200	222, 267	\$525	OC2-36S	82	\$215	PKG14-36RM	165	\$155	PX-25S	51	\$191	WD982PN	294	\$65
HFS3322-1KIT	117	\$860	LB15220	222, 267	\$635	OC2-45SP	82	\$325	PKG160CHA	166	\$755	PX-28S	51	\$202	WDFLANGE-CH	294	\$58
HFS3322-2	117	\$805	LB15270	222, 267	\$635	OC2-50C	82	\$155	PKG160MOC	166	\$755	PX-40S	49, 51	\$212	WDFLANGE-EX-SN	294	\$60
HFT4322-2	125	\$995	LB15280	222, 267	\$635	OC2-60S	82	\$125	PKG160ONY	166	\$755	PX-70S	49, 51	\$202	WDFLANGE-EX-WH	294	\$60
HFT4322-2KIT	125	\$1,055	LB16100	228, 267	\$430	OK-31C-LH	144	\$160	PKG160OYS	166	\$755	RBG-36S	110	\$150	WDFLANGE-SS	294	\$58
HFT4322-4	125	\$995	LB16120	228, 267	\$505	OK-31C-RH	144	\$160	PKG160SHG	166	\$755	RBX-110	110	\$535	WDJ33	293	\$165
HFT4322-4KIT	125	\$1,055	LB16122	228, 267	\$505	OK-36C	144	\$223	PKG160STO	166	\$755	RG-36S	92	\$150	WDJ33NC	293	\$150
HT-100	274	\$350	LB16140	228, 267	\$505	OR2X110	82	\$995	PKG160VAN	166	\$755	RG-36S-RH	92	\$150	WDJ50	292	\$195
HT-250	274	\$430	LB16161	228, 267	\$505	ORG110CHA	170	\$755	PKG17-36RM	166	\$159	RGX160	92	\$965	WDJ50NC	292	\$175
HT-300	274	\$430	LB16165	228, 267	\$505	ORG110MOC	170	\$755	PKG17-36S	166	\$159	RM18S	55, 57, 59, 63	\$147	WDJ75	292	\$275
HT-400	274	\$400	LB16170	228, 267	\$505	ORG110ONY	170	\$755	PKG18-31RM	165, 166	\$149	RNDCVR	55, 57, 59, 82, 299	\$82	WDJ75NC	292	\$255
HTS1722-1	116	\$475	LB16180	228, 267	\$505	ORG110OYS	170	\$755	PKG20-36RM	165	\$175	SB60	280	\$40			
HTS1722-1KIT	116	\$525	LB16190	228, 267	\$505	ORG110SHG	170	\$755	PKG31-36RM	165	\$202	SC3322-1	188	\$485			
HTS2022-1	116	\$555	LB16200	228, 268	\$525	ORG110STO	170	\$755	PKG31-36S	165	\$212	SD-500	284	\$345			
HTS2022-1KIT	116	\$575	LB16220	228, 268	\$635	ORG110VAN	170	\$755	PKGCVR	45, 77, 78, 165,	\$82	SD-580N	284	\$385			
KB-36RM	67, 69	\$150	LB16240	228, 268	\$635	ORX110WH	144	\$1,650		166, 299		SD-800	284	\$430			
KB-40S	67, 69	\$202	LB16261	228, 268	\$635	ORX110	83	\$1,035	PKX11013	48	\$1,870	SD-880N	284	\$530			
KB-70C	67, 69	\$245	LB16265	228, 268	\$635	PCX1102109	88	\$675	PKX11016	48	\$2,070	SD2600	217, 284	\$185			
KB13-36S	67, 69	\$126	LB16270	228, 268	\$635	PE-14S	73	\$137	PKX11018	49	\$2,230	SD2680	217, 284	\$215			
KB17-31C	67, 69	\$95	LB16270	228, 268	\$635	PE-21S	73	\$171	PKX11021	49	\$2,370	SD3100	235, 285	\$120			
KB18-31S	67, 69	\$126	LB16280	228, 268	\$635	PE-28S	73	\$191	PKX11025	50	\$2,430	SD3170	235, 285	\$150			
KB18-36S	67, 69	\$137	LB16290	228, 268	\$635	PE-31S	73	\$212	PKX11028	50	\$2,530	SD3180	235, 285	\$150			
KB21-31S	67, 69	\$160	LB6100C	206, 263	\$395	PE-40S	73	\$243	PKX1108	48	\$1,170	SD3200	247, 286	\$115			
KB21-36S	67, 69	\$160	LB6170C	206, 263	\$480	PE-70S	55, 57, 59, 63,	\$212	PKX160	50	\$2,870	SD3201	247, 286	\$145			
KB28-31S	67	\$160	LB6180C	206, 263	\$480	PEX110-14	72	\$1,115	PKX160LH	50	\$2,870	SD3202	247, 286	\$145			
KB28-36S	67	\$243	LB6200C	206, 263	\$545	PEX110-21	72	\$1,375	PKXCVR	49, 51, 299	\$95	SD3203	247, 286	\$145			
KBG11013CHA	174	\$475	LB6270C	206, 263	\$655	PEX110-28	72	\$1,475	PR-31S	88	\$150	SD3204	247, 286	\$145			
KBG11013MOC	174	\$475	LB6280C	206, 263	\$655	PEX110-31	73	\$1,575	PR-36S	88	\$150	SD3205	247, 286	\$145			
KBG11013ONY	174	\$475	LB7100C	234, 269	\$395	PF3100	233	\$645	PRK11021WH	148	\$1,015	SD3206	247, 286	\$145			
KBG11013OYS	174	\$475	LB7100C-110-HT	269	\$915	PF3170	233	\$745	PRX11021	88	\$775	SD3207	247, 286	\$145			
KBG11013SHG	174	\$475	LB7170C	234, 269	\$480	PF3180	233	\$745	PS2-11-36S	57	\$119	SD3220	247, 286	\$145			
KBG11013STO	174	\$475	LB7180C	234, 269	\$480	PF3300	205	\$645	PS2-14-36S	59	\$129	SD3222	247, 286	\$145			
KBG11031CHA	174	\$575	LB7180C-110-HT	269	\$980	PF3380	205	\$745	PS2-15-36S	55	\$140	SD3240	247, 286	\$145			
KBG11031MOC	174	\$575	LB7200C	234, 269	\$545	PF3450	241	\$670	PS2-16-36S	59	\$140	SD3265	247, 286	\$145			
KBG11031ONY	174	\$575	LB7200C-100-HT	269	\$1,025	PF3550	237	\$640	PS2-18-36S	55, 57	\$150	SD3270	247, 286	\$145			
KBG11031OYS	174	\$575	LB7270C	234, 269	\$655	PF4400	227	\$510	PS2-21-36S	55	\$181	SD3280	247, 286	\$145			
KBG11031SHG	174	\$575	LB7280C	234, 269	\$655	PF4480	227	\$615	PS2-24-36S	55	\$191	SD3290	247, 286	\$145			
KBG11031STO	174	\$575	LB7280C-100-HT	269	\$1,125	PF5200	220	\$615	PS2-27-36S	57	\$212	SD3290	247, 286	\$145			
KBG11031VAN	174	\$575	LB9100C	265	\$385	PF5220	220	\$750	PS2-30-36S	57	\$243	SD3450	242, 284	\$245			
KBG13-36S	174	\$126	LB9100C-110-HT	26													

Make
it
Wonderful

FRANKE

After perfecting the sink,
we now have perfected the faucet.



KWC



2019 KWC Kitchen Collection

www.kwc.com/us-english

KWC

SWISS WATER EXPERIENCE



FAUCETS FOR THE KITCHEN

KWC NEW	KWC ERA	12
	KWC ZOE touch light PRO	20
	KWC ZOE	24
	KWC ONO touch light PRO	28
	KWC ONO	32
	KWC SIN	38
	KWC EVE	44
	KWC SUPRIMO	48
	KWC LIVELLO	54
	KWC AVA	56
	KWC DOMO	62
	KWC LUNA-E	68
	KWC Potfillers	74
ACCESSORIES		
	KWC Soap dispensers	76
	KWC Escutcheons	79

THE PURSUIT OF PERFECTION

Our technology is designed not to be noticed, but to be useful. This is reflected in our kitchen faucets. Every detail is just right, every movement is perfect, every function impresses.

BRILLIANT SOLUTIONS

At KWC, we want to achieve excellence in everything we create. Our destiny is not to invent products, it is to perfect them.

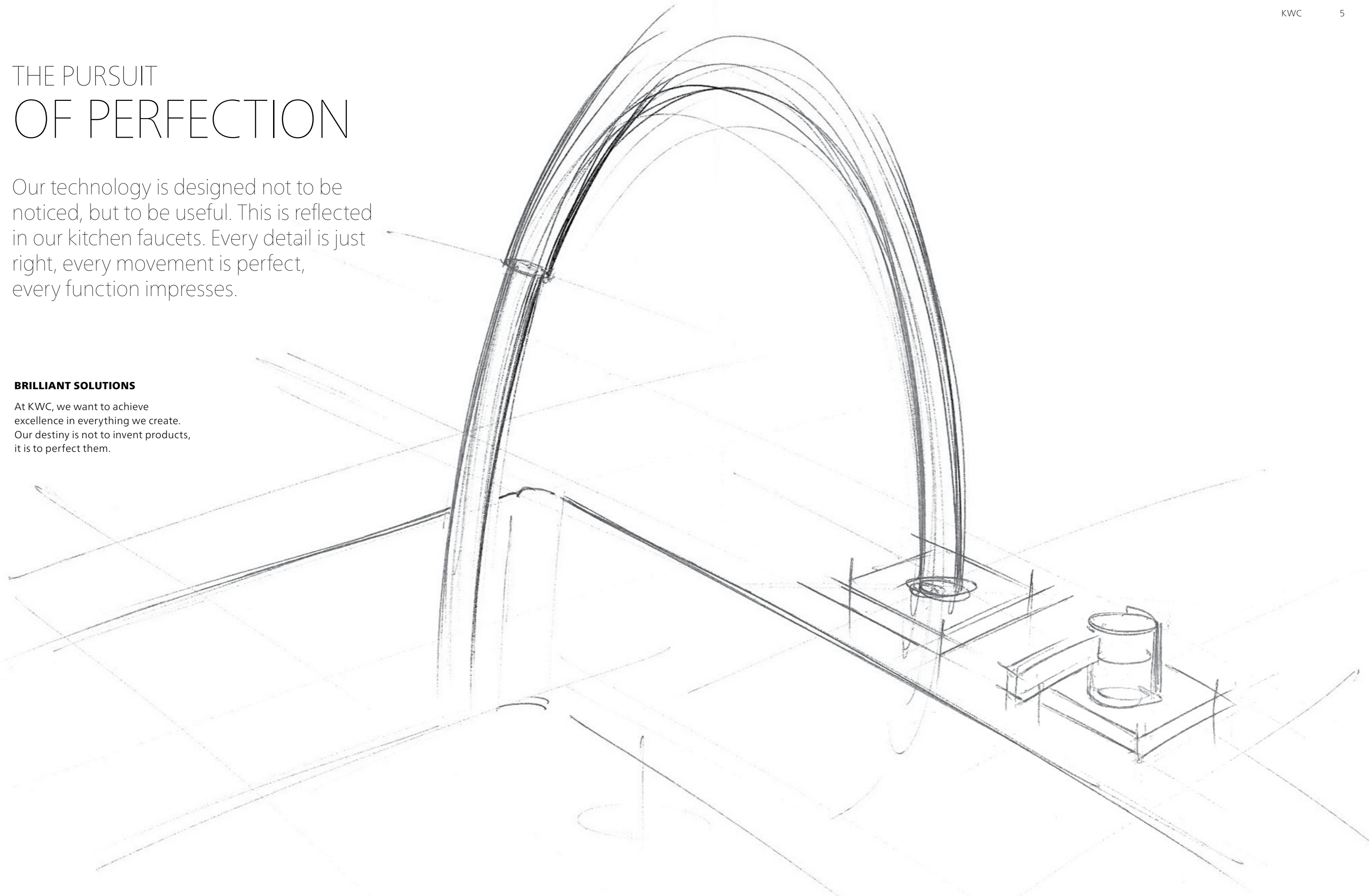

REPRESENTING PERFECTION SINCE 1874



MANUFACTURING EXCELLENCE

KWC has been famous for compelling design, aesthetics and precision for more than 140 years. Originally the company channeled its expertise into the manufacturing of exquisite music boxes, but by the end of the 19th century, those skills were being redirected into the development and production of excellent faucets.



CRAFTED BY KNOWLEDGE & PRECISION

THE SWISS DNA

KWC's Swiss heritage is very important for the manufacturing of faucets. The Swiss have a great love of detail, reliability and functional design. KWC pursues perfection every day and connects people to the natural resource of water. This is what we call the Swiss water experience.

This is what we live.

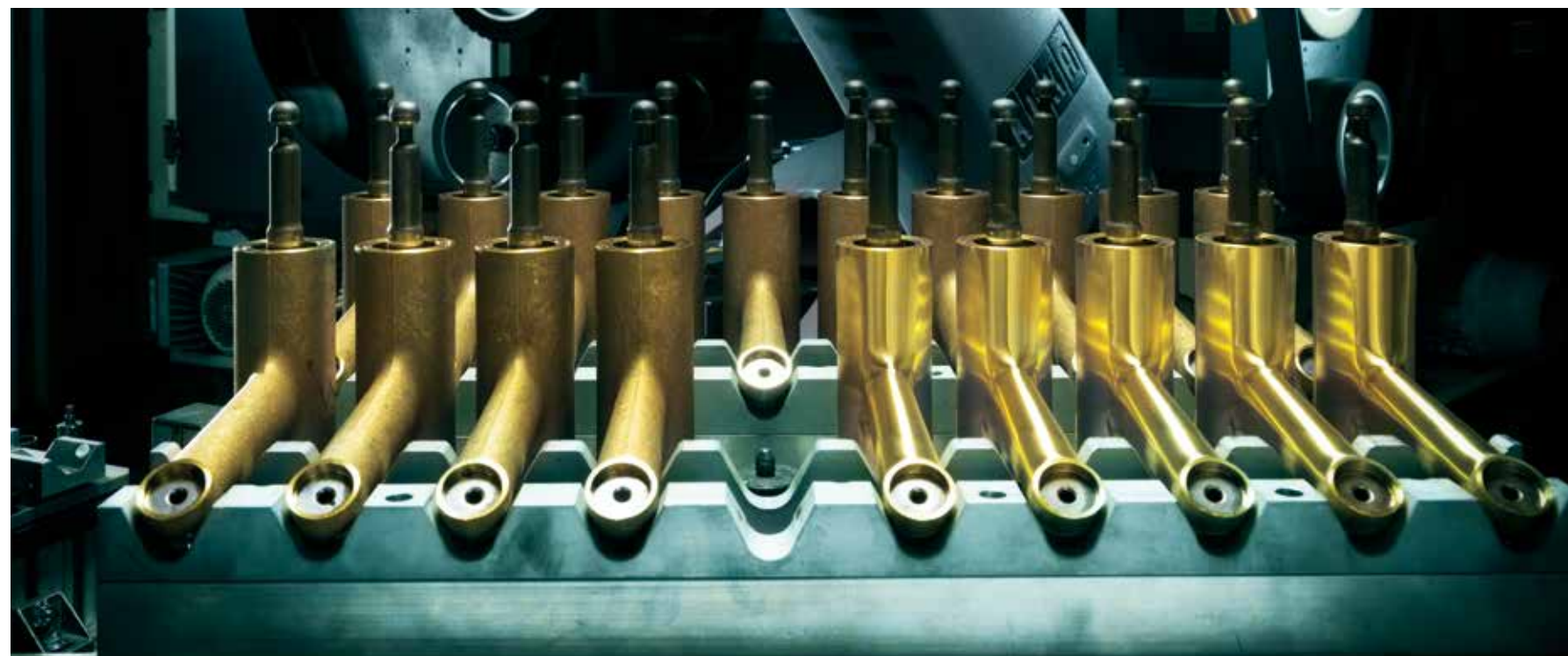

TECHNOLOGY & INNOVATION

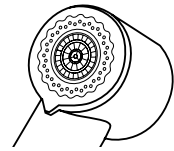

JETCLEAN

The jetclean faceplate prevents limescale deposits in the kitchen spray and makes it easier to clean. The cone-shaped sieve holes expand when water flows to blast off stubborn limescale deposits. The holes return to their normal size once the water is turned off.

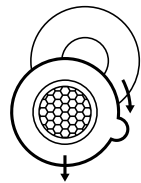

FAST AND CLEAN

If limescale residue becomes stuck in the faceplate of your faucet, the turn and clean fastening mechanism (TAC) provides assistance: turn, clean and you're done.



FAST AND FIXED

The turn and lock fastening mechanism (TAL) keeps things simple. This technology keeps the stream of your kitchen spray in the right position.

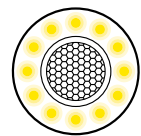

LUMINAQUA

Setting the right mood, luminaqua technology ensures the perfect ambiance in your kitchen. This brilliant technology produces a wonderful interplay of light with the water stream from your faucet at the touch of a button. The light ring is exquisitely integrated into the pull-out aerator, making it practically invisible. The LEDs require minimum power and ensure a maximum service life. The light switches off automatically after 30 to 45 minutes.

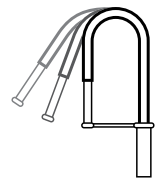

HIGHFLEX

This patented spring hose appreciates good guidance. It can be flexibly moved in every direction, is easy to clean and has a reliably stable spout when not in use.

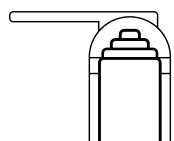

FLEXGUARD

This innovative sealing membrane keeps KWC faucets watertight for a long period of time. It protects the control cartridge from residue left by cleaning agents and dirt. The lever support is reinforced with a metal core and integrated into the membrane, reliably preventing the lever from coming loose.

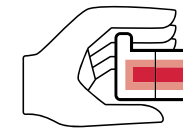

TOUCHCONTROL

The touchcontrol protection solution with dual water guidance system ensures that you never burn your fingers on your faucet. The insulated hot water supply with a "double skin" principle keeps the body of the faucet warm without letting it get too hot.

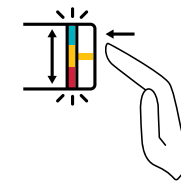

TIPCONTROL

On low-contact faucets with DDSA® sensor technology, you can set the water temperature to suit your personal preference. One tap means cold (blue), two taps means warm (orange) and three means hot (red). Pressing the faucet for five seconds will activate the cleaning function (green).

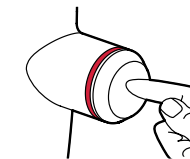

ELECTRONIC CONTROLLED

Our TLP (touch and tip) operation for our electronically controlled faucets is a new and very easy way to change the temperature and flow rate of your KWC TLP faucet. Touch once, twice or three times and you get cold, warm or hot water instantly. Temperature is indicated by a light ring from blue to red.



CONTROL CARTRIDGES

You can rely on KWC control cartridges – after all, they have proven themselves a million times over. At the heart of a KWC faucet, they control the water mixture thanks to two perforated ceramic discs with grease wells. Our faucets are equipped with various additional functions depending on where you use them.



ECOPROTECT

For the highest energy classes and responsible use of resources, EcoProtect represents our commitment to promoting a sustainable lifestyle. For example, the turning handle limits the water flow level. To switch off the water-saving mode, simply turn the handle back past the soft catch point.

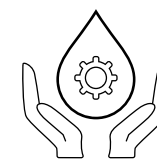

HEALTHPROTECT

Better hygiene and unchanged water quality: HealthProtect highlights the strict standards we set ourselves to ensure that our faucets do not affect the taste and smell of your water – that is why we use high-quality materials (metals, plastics) that are ideally suited for contact with water.

NEW KWC ERA

AWARD-WINNING DESIGN

Elegant, slim and designed with absolute precision, KWC ERA brings a new level of sophistication to the kitchen. A timeless design with enduring beauty, KWC ERA is crafted from stainless steel, a pure material with a flawless finish. Featuring a swivel range that can be adjusted from 150° to 360°, KWC ERA is available with four different spouts – Gravity, J, or L spout, and the J spout with pull-down spray – allowing you to customize this lever mixer faucet to suit your personal style.



reddot design award

KWC ERA PURE & SIMPLE



LUXURY FINISHES

Precision is the main attribute of the KWC ERA faucets. They feature a plain and smooth surface with a precise and sophisticated finish.

ELEGANCE IN EVERY DETAIL

Slim proportions and graceful spouts create the perfect Swiss water experience.



NEW & EXCEPTIONAL
KWC ERA is for people who demand the absolute best products. With KWC ERA, we introduce faucets with a very minimalistic design, sleek proportions, high functionality and a fascinating high precision look.

KWC
NEW

ERA Pull-Down Faucet with jetclean

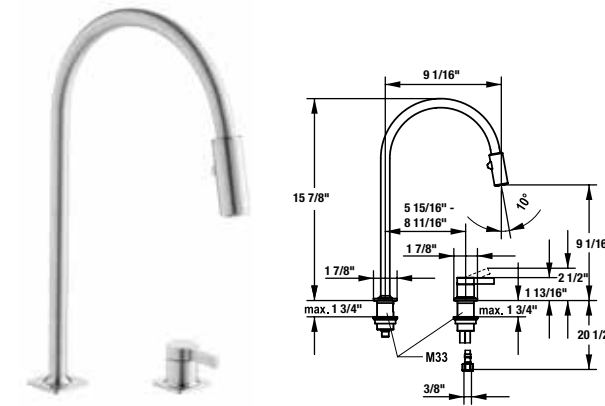
**10.392.323.700**

solid stainless steel

\$1,590

- Single-lever mixer - optional right or left side lever installation
- 2 hole
- jetclean technology prevents limescale deposits
- Touchcontrol anti-scald protection
- Professional 360° pull-down spray head
- Magnetic hose guide secures hose back into place
- Hose pull out length up to 20"
- KWC safety control 25mm ceramic cartridge
- Variable flow rate and temperature control
- Flow rate max 1.75 gpm (60 psi)
- Overall height 15 7/8"
- Spout swivel range 150° - 360°
- Spout reach from deck 9 1/16"
- Mounting hole size \varnothing 1 3/8"

KWC
NEW

ERA Gravity Spout Faucet

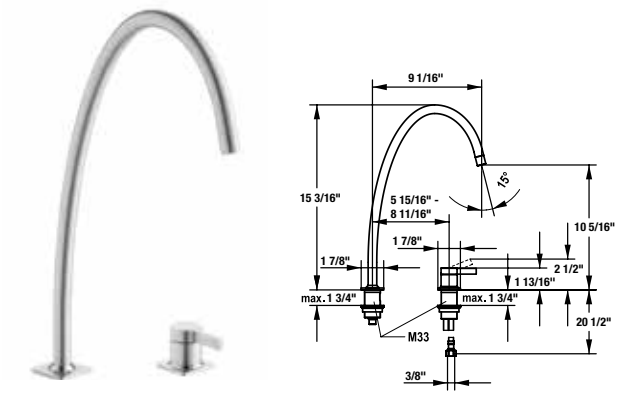
**10.392.024.700**

solid stainless steel

\$1,490

- Single-lever mixer - optional right or left side lever installation
- 2 hole
- Perlator® hidden aerator
- KWC safety control 25mm ceramic cartridge
- Variable flow rate and temperature control
- Flow rate max 1.75 gpm (60 psi)
- Overall height 15 3/16"
- Spout swivel range 150° - 360°
- Spout reach from deck 9 1/16"
- Mounting hole size \varnothing 1 3/8"



ERA J-Spout Faucet

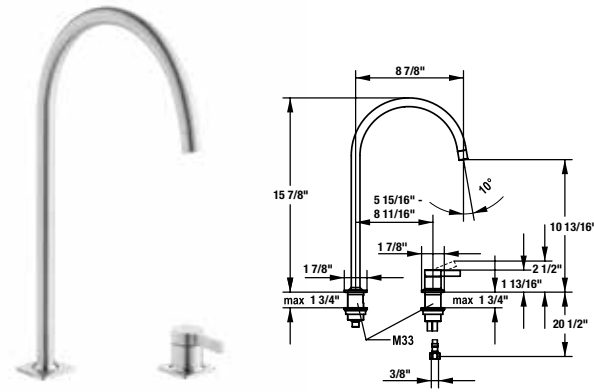

10.392.023.700 **\$1,290**
solid stainless steel

- Single-lever mixer - optional right or left side lever installation
- 2 hole
- Perlator® hidden aerator
- KWC safety control 25mm ceramic cartridge
- Variable flow rate and temperature control
- Flow rate max 1.75 gpm (60 psi)
- Overall height 15 7/8"
- Spout swivel range 150° - 360°
- Spout reach from deck 8 7/8"
- Mounting hole size \varnothing 1 3/8"



ERA L-Spout Faucet

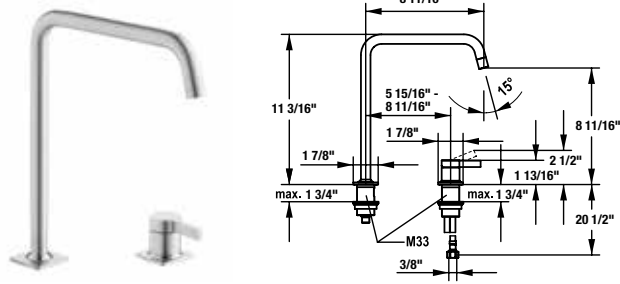

10.392.022.700 **\$1,290**
solid stainless steel

- Single-lever mixer - optional right or left side lever installation
- 2 hole
- Perlator® hidden aerator
- KWC safety control 25mm ceramic cartridge
- Variable flow rate and temperature control
- Flow rate max 1.75 gpm (60 psi)
- Overall height 11 3/16"
- Spout swivel range from 150° - 360°
- Spout reach from deck 8 11/16"
- Mounting hole size \varnothing 1 3/8"



ERA Soap Dispenser

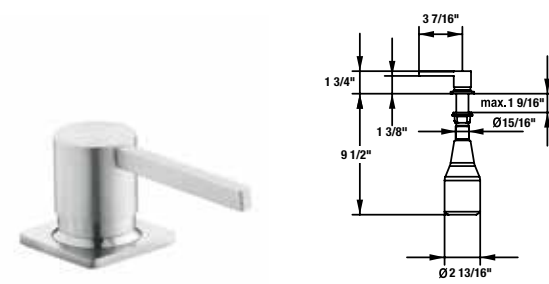

Z.538.038.700 **\$495**
solid stainless steel

- Antimicrobial soap container
- Easy to use, one hand pump operation
- Refillable from surface, no need for removing soap container
- Large capacity bottle 11.8 fl oz. Z.538.053
- Mounting hole size \varnothing 1"



ERA Push Button Kit



133.0504.199 **\$160**
solid stainless steel

- Push button sink waste kit
- Drain your sink without getting your hands messy
- Includes standard 3 1/2" waste kit
- Only compatible with stainless steel sinks
- Max 2 1/2" countertop thickness
- Mounting hole size \varnothing 1 3/8"

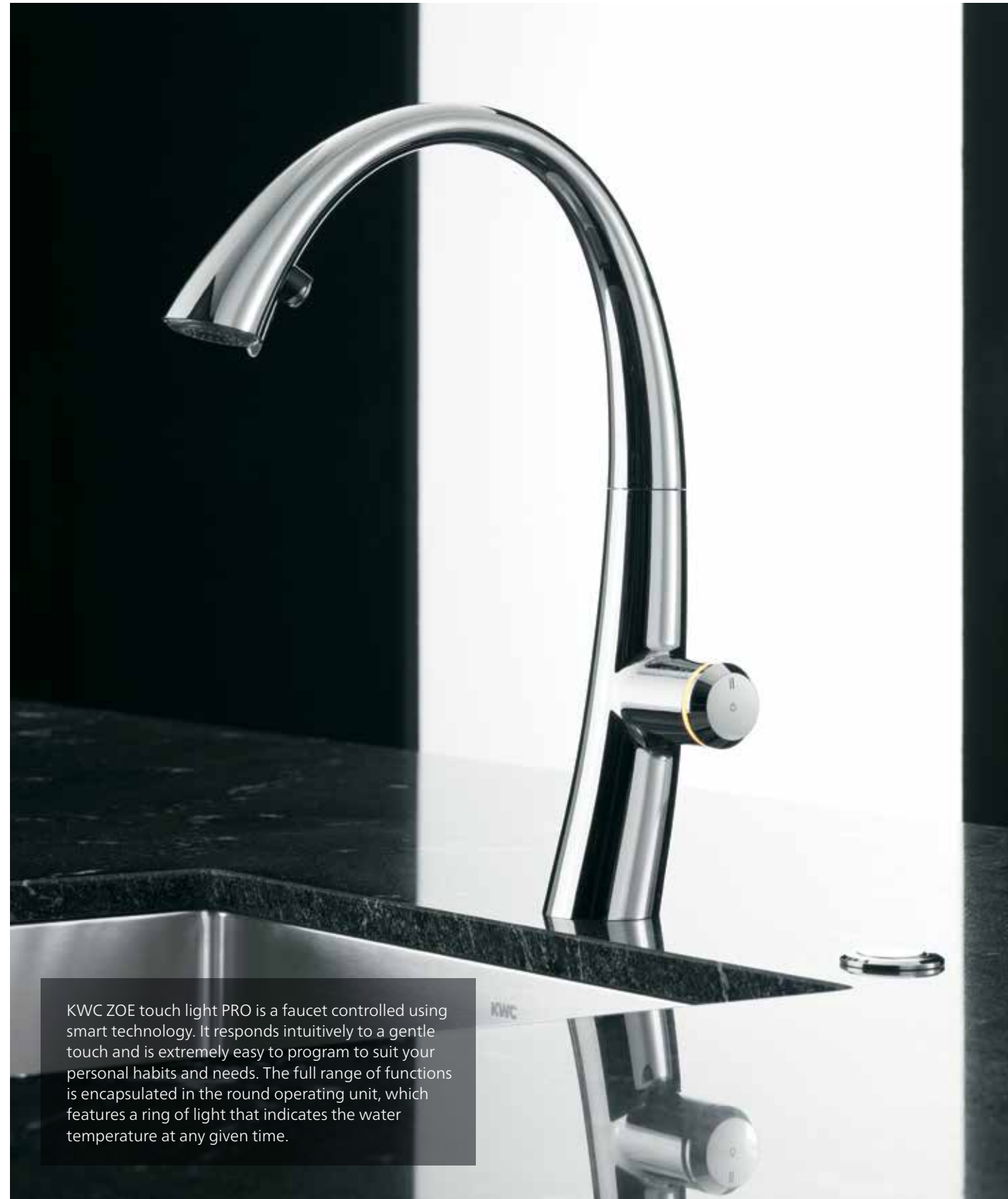

KWC ZOE touch light PRO is a faucet controlled using smart technology. It responds intuitively to a gentle touch and is extremely easy to program to suit your personal habits and needs. The full range of functions is encapsulated in the round operating unit, which features a ring of light that indicates the water temperature at any given time.

KWC **ZOE** touch light PRO ARTISTRY IN MOTION



TOUCH AND REFRESH – 1 x TAP

Cold water = blue. For drinking a quick glass of water, washing fruit or preparing salad.

TOUCH AND CLEAN – 2 x TAP

Warm water = orange. For quickly washing your hands, rinsing off a plate or filling small pans.

TOUCH AND PREPARE – 3 x TAP

Hot water = red. For filling pasta pans and kettles or washing up roasting tins and baking trays.



ZOE touch light PRO Pull-Down Faucet with luminaqua LED-Technology

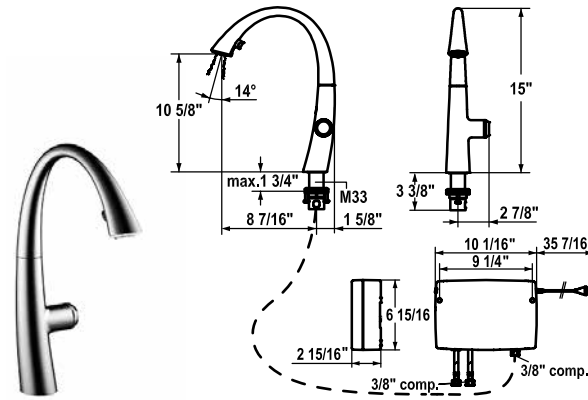

10.201.242.127	\$3,150
splendure™ stainless steel	
10.201.242.000	\$2,650
chrome	
10.201.242.176	\$2,995
matte black	

- Electronically controlled touch light PRO technology
- Easy touch operation for 3 preset temperatures and flow rate; cold, warm, and hot water
- Flow rates can be individually adjusted and saved
- jetclean technology prevents limescale deposits
- cascade® limescale protection aerator
- Concealed pull-down spray head
- Cold water flow positioned towards front for child safety
- luminaqua LED light with integrated on/off switch
- Light switches off automatically after 30 minutes
- Hose pull out length up to 20"
- Hose guide secures hose back into place
- KWC 25mm ceramic cartridge
- Variable flow rate and temperature control
- Flow rate max 1.75 gpm (60 psi)
- Overall height 15"
- Spout swivel range 270°
- Spout reach from deck 8 7/16"
- Mounting hole size ø1 3/8"
- Power supply 100-240 V, operating voltage 6.75 V, power cord 43" in length
- Order separately: Z.536.352 1500mm extension set



KWC ZOE

ICON WITH STYLE



SAFE AND SOUND

KWC ZOE particularly proves its worth in households where small children are around. Cold water flows when the lever is pointing forward and mixed water runs when it is in the central position, keeping guests of all ages safe from scalding in the kitchen.



ON AND OFF

A touch of a button is all it takes for luminaqua to transform the jet of water from your faucet into a wonderful play of light. The light switches off automatically after 30 minutes.

With KWC ZOE, you can channel our 140 years of expertise in working with water into your kitchen in the form of a sculptural masterpiece. This faucet combines clever functions with a captivating interplay of light and water and the distinctive hallmark of a master in unparalleled perfection. In short, KWC ZOE brings a whole new level of luxury to your kitchen.



ZOE Pull-Down Faucet with luminaqua LED-Technology

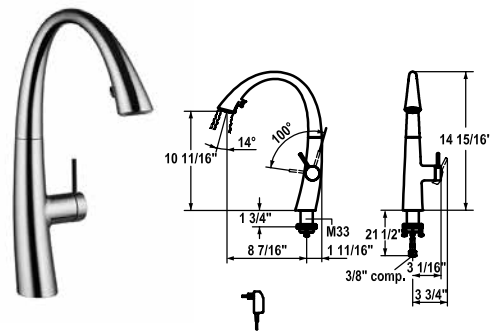

10.201.122.127	\$1,745
splendure™ stainless steel	
10.201.122.000	\$1,395
chrome	
10.201.122.176	\$1,595
matte black	

- Single-lever mixer - right side lever installation only
- jetclean technology prevents limescale deposits
- cascade® limescale protection aerator
- Concealed pull-down spray head
- Cold water flow positioned towards front for child safety
- luminaqua LED light with integrated on/off switch
- Light switches off automatically after 30 minutes
- Hose pull out length up to 20"
- Hose guide secures hose back into place
- KWC 25mm ceramic cartridge
- Variable flow rate and temperature control
- Flow rate max 1.75 gpm (60 psi)
- Overall height 14 15/16"
- Spout swivel range 270°
- Spout reach from deck 8 7/16"
- Mounting hole size $\varnothing 1 \frac{3}{8}$ "
- Power supply 100-240 V, operating voltage 6.75 V, power cord 43" in length

ZOE Pull-Down Faucet with jetclean

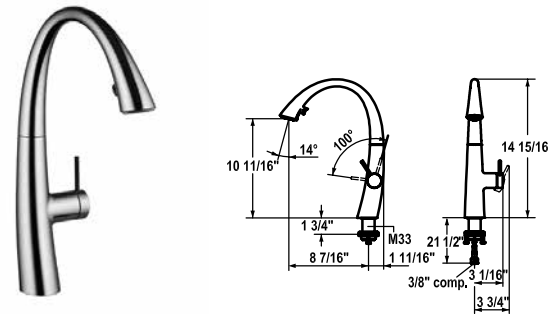

10.201.102.127	\$1,495
splendure™ stainless steel	
10.201.102.000	\$1,165
chrome	
10.201.102.176	\$1,335
matte black	

- Single-lever mixer - right side lever installation only
- jetclean technology prevents limescale deposits
- cascade® limescale protection aerator
- Concealed pull-down spray head
- Cold water flow positioned towards front for child safety
- Hose pull out length up to 20"
- Hose guide secures hose back into place
- KWC 25mm ceramic cartridge
- Variable flow rate and temperature control
- Flow rate max 1.75 gpm (60 psi)
- Overall height 14 15/16"
- Spout swivel range 270°
- Spout reach from deck 8 7/16"
- Mounting hole size $\varnothing 1 \frac{3}{8}$ "

ZOE Soap Dispenser

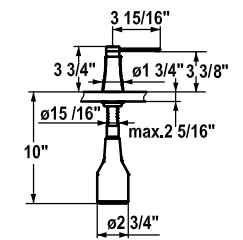

Z.536.586.127	\$550
splendure™ stainless steel	
Z.536.586.000	\$450
chrome	
Z.536.586.176	\$460
matte black	

- Antimicrobial soap container
- Easy to use, one hand pump operation
- Refillable from surface, no need for removing soap container
- Large capacity bottle 11.8 fl oz. Z.635.713
- Mounting hole size $\varnothing 1 \frac{5}{16}$ " - 1 3/8"
- Ordered separately:
Escutcheon Z.536.291.000



KWC ONO touch light PRO makes every important element seem simple, leaving you to focus on the essential issues in the kitchen. This clever faucet takes the benefits offered by KWC ONO and enhances them with a touch of sophistication and an even greater dose of technological intelligence.

KWC **ONO** touch light PRO A TECHNOLOGICAL MASTERPIECE



TIP: JUST TAP

You can call up preset water temperatures and flow rates quickly and conveniently by simply tapping the operating unit: One tap means cold (blue), two taps mean warm (orange) and three means hot (red). Of course, you can also adjust these settings to suit your preferences.

ONO touch light PRO highflex PRO Faucet with LED-Technology

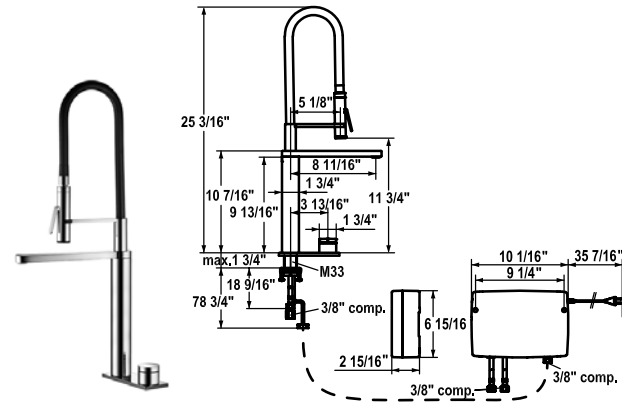
**10.651.122.000**

chrome

\$4,695

- Electronically controlled touch light PRO technology
- Easy touch operation for 3 preset temperatures and flow rate; cold, warm, and hot water
- highflex spring hose technology allows flexibility in any direction
- caché® adjustable, hidden aerator reduces splash and side spray
- Professional 360° turn spray head
- Maintenance free touch light PRO control unit
- Variable flow rate and temperature control
- Flow rate max 1.75 gpm (60 psi)
- Overall height 25 3/16"
- Spout swivel range 360°
- Spout reach from deck 8 11/16"
- Mounting hole size \varnothing 1 3/8"
- Power supply 100-240 V, operating voltage 15 V, power cord 35" in length

ONO touch light PRO Wireless Control

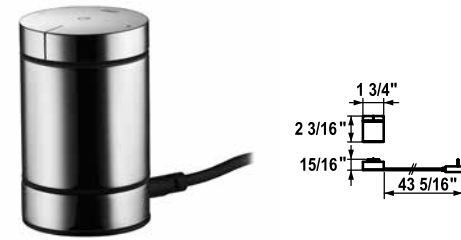
**Z.536.638.000**

chrome

\$1,745

- KWC ONO touch light PRO wireless operating unit with charging station
- Rechargeable battery life 3-4 months
- Power supply 100-240 V / operating voltage 6.75 V / cable length 31"

ONO touch light PRO Extension Hose

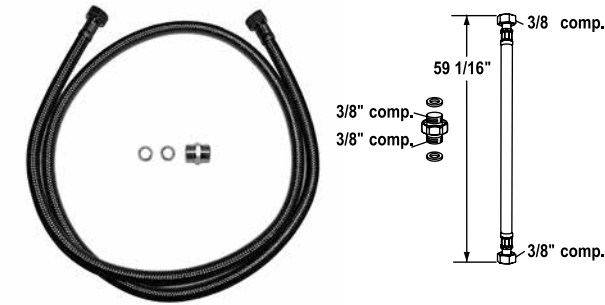
**Z.536.352****\$93**

- Stainless steel hose 1500 mm, 3/8"x 3/8", double nipple, sealing material
- 3/8" thread type

ONO touch light PRO Rough-In

**Z.636.183****\$20**

- Rough-in for touch light PRO operating unit
- Plastic suitable for installation on brickwork or cavity walls

KWC **ONO**

SIMPLY SMART



HIGH TECH AND HIGHLY FLEXIBLE

The innovative highflex spring hose opens your kitchen door to the future. This hose, designed as a sweeping curve, can be moved in any direction, returns to its original position automatically and stays firmly in place when it is not being used – even without the spray holder.

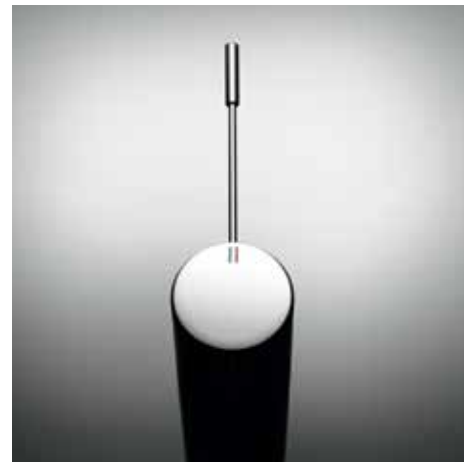

DIRECT AND PRECISE

The KWC ONO operating lever is made of the kind of unbreakable, corrosion-resistant stainless steel you would normally find in medical technology. This means that you can count on perfect precision when you use it.



KWC ONO appeals to your appreciation for all things practical – and to your sophistication. That is why this simple faucet for the kitchen is not only designed to be extra robust, but it also has an exceptionally fine finish. KWC ONO ably assists you with its intelligent functions, yet it is always the perfect picture of elegance.



ONO highflex PRO Faucet

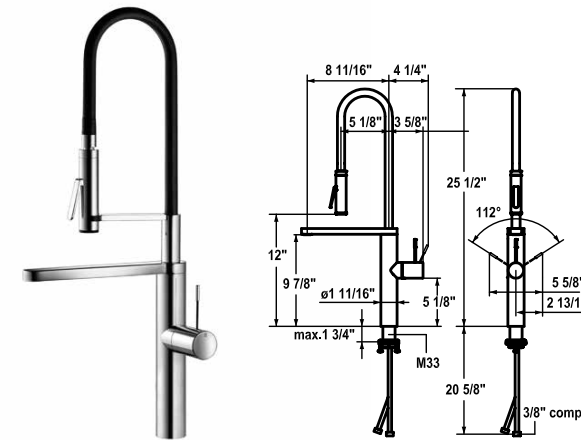

10.151.423.700	\$3,525
solid stainless steel	
10.151.423.000	\$2,695
chrome	

- Single-lever mixer - optional right or left side lever installation
- highflex spring hose technology allows flexibility in any direction
- Surgical-grade hardened stainless steel lever
- Integrated diverter
- caché® adjustable, hidden aerator reduces splash and side spray
- Professional 360° turn spray head
- KWC safety control 35mm ceramic cartridge
- Variable flow rate and temperature control
- Flow rate max 1.75 gpm (60 psi)
- Overall height 25 1/2"
- Spout swivel range 360°
- Spout reach from deck 8 1/16"
- Mounting hole size \varnothing 1 3/8"

ONO Pull-Out Faucet with jetclean

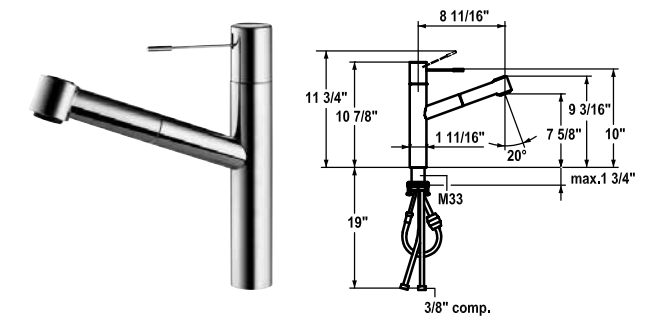

10.151.033.700	\$1,525
solid stainless steel	
10.151.033.000	\$1,055
chrome	

- Single-lever mixer
- jetclean technology prevents limescale deposits
- Surgical-grade hardened stainless steel lever
- Hose pull out length up to 28"
- Hose guide secures hose back into place
- KWC safety control 35mm ceramic cartridge
- Variable flow rate and temperature control
- Flow rate max 1.75 gpm (60 psi)
- Overall height 10 7/8"
- Spout swivel range 105°
- Spout reach from deck 8 1/16"
- Mounting hole size \varnothing 1 3/8"

ONO Pull-Down Faucet

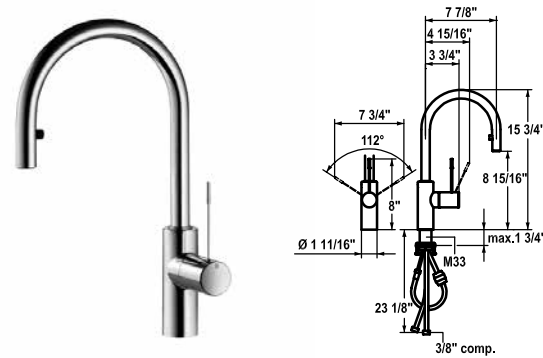

10.151.102.700	\$1,395
solid stainless steel	
10.151.102.000	\$1,085
chrome	

- Single-lever mixer - optional right or left side lever installation
- Surgical-grade hardened stainless steel lever
- caché® adjustable, hidden aerator reduces splash and side spray
- Hose pull out length up to 28"
- Hose guide secures hose back into place
- KWC safety control 35mm ceramic cartridge
- Variable flow rate and temperature control
- Flow rate max 1.75 gpm (60 psi)
- Overall height 15 3/4"
- Spout swivel range 360°
- Spout reach from deck 7 7/8"
- Mounting hole size \varnothing 1 3/8"

ONO Bar Faucet

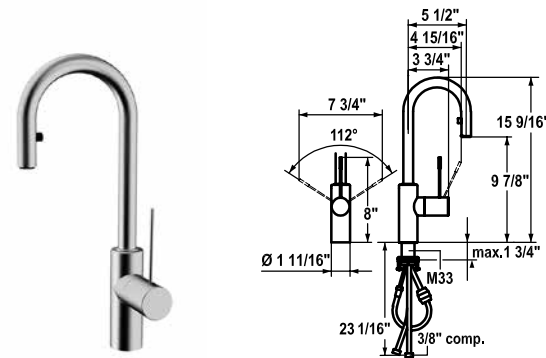

10.151.991.700	\$1,375
solid stainless steel	
10.151.991.000	\$1,055
chrome	

- Single-lever mixer - optional right or left side lever installation
- Surgical-grade hardened stainless steel lever
- caché® adjustable, hidden aerator reduces splash and side spray
- Hose pull out length up to 28"
- Hose guide secures hose back into place
- KWC safety control 35mm ceramic cartridge
- Variable flow rate and temperature control
- Flow rate max 1.75 gpm (60 psi)
- Overall height 15 9/16"
- Spout swivel range 360°
- Spout reach from deck 5 1/2"
- Mounting hole size \varnothing 1 3/8"

ONO Soap Dispenser

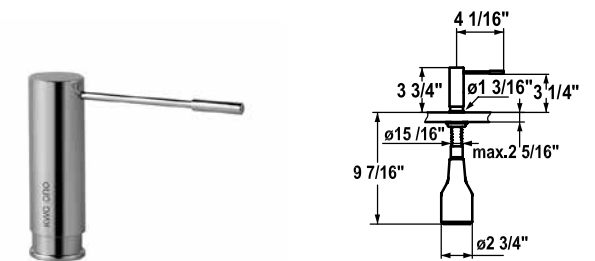

Z.536.060.700	\$525
solid stainless steel	
Z.536.060.000	\$385
chrome	

- Antimicrobial soap container
- Easy to use, one hand pump operation
- Refillable from surface, no need for removing soap container
- Large capacity bottle 11.8 fl oz. Z.635.713
- Mounting hole size \varnothing 1" - 1 3/8"
- Ordered separately:
Escutcheon Z.536.291.000



KWC SIN not only enables you to fulfill your aesthetic ambitions, it says something about your good sense too. After all, it enhances your kitchen with an extra touch of sensuality and intelligent functionality.

KWC SIN

SUBTLE INSPIRATION



HIGH-TECH AND HIGHLY FLEXIBLE

The innovative highflex spring hose from KWC opens your kitchen door to the future. This curved hose can be moved in any direction, returns to its original position automatically and stays firmly in place when it is not being used. If you place the spring hose in the spray holder with the help of a positioning aid, you can use it as a stable swivel spout that can be rotated 360°.



SIN highflex Professional Pull-Down Faucet

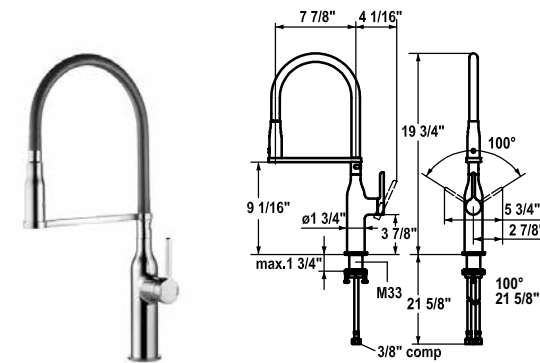

10.261.432.127 splendure™ stainless steel	\$1,675
10.261.432.000 chrome	\$1,275

- Single-lever mixer - optional right or left side lever installation
- highflex spring hose technology allows flexibility in any direction
- caché® adjustable, hidden aerator reduces splash and side spray
- Professional 360° turn toggle spray head
- Hose guide secures hose back into place
- KWC 25mm ceramic cartridge
- Variable flow rate and temperature control
- Flow rate max 1.75 gpm (60 psi)
- Overall height 19 3/4"
- Spout swivel range 360°
- Spout reach from deck 7 7/8"
- Mounting hole size \varnothing 1 3/8"

SIN Pull-Down Faucet with jetclean

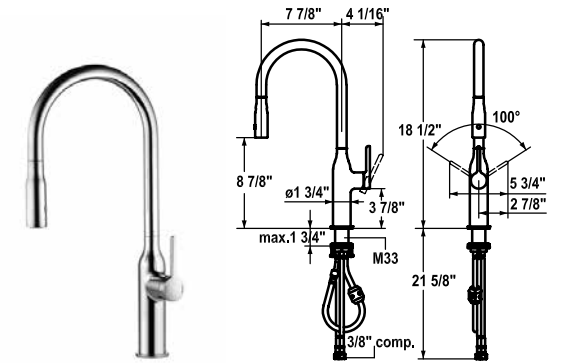

10.261.002.127 splendure™ stainless steel	\$1,340
10.261.002.000 chrome	\$1,055

- Single-lever mixer - optional right or left side lever installation
- jetclean technology prevents limescale deposits
- caché® adjustable, hidden aerator reduces splash and side spray
- Professional 360° pull-down spray head
- Hose pull out length up to 20"
- Hose guide secures hose back into place
- KWC 25mm ceramic cartridge
- Variable flow rate and temperature control
- Flow rate max 1.75 gpm (60 psi)
- Overall height 18 1/2"
- Spout swivel range 360°
- Spout reach from deck 7 7/8"
- Mounting hole size \varnothing 1 3/8"

SIN Prep Pull-Down Faucet

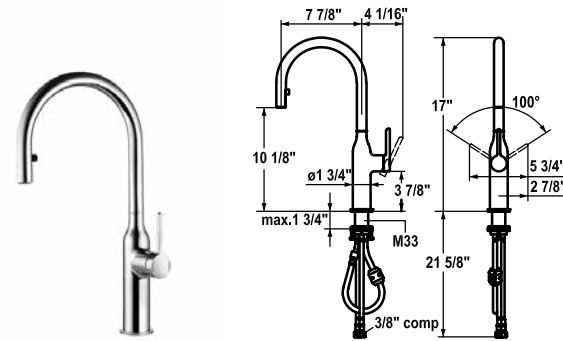

10.261.102.127	\$1,175
splendure™ stainless steel	
10.261.102.000	\$935
chrome	

- Single-lever mixer - optional right or left side lever installation
- caché® adjustable, hidden aerator reduces splash and side spray
- Hose pull out length up to 20"
- Hose guide secures hose back into place
- KWC 25mm ceramic cartridge
- Variable flow rate and temperature control
- Flow rate max 1.75 gpm (60 psi)
- Overall height 17"
- Spout swivel range 360°
- Spout reach from deck 7 7/8"
- Mounting hole size $\varnothing 1 \frac{3}{8}$ "

SIN Bar Faucet

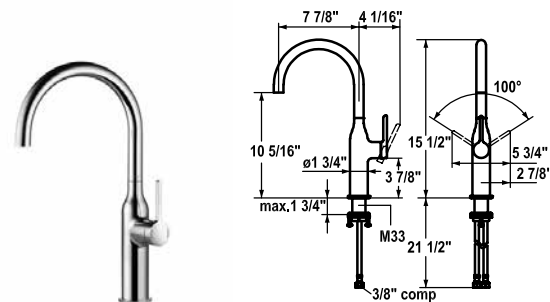

10.261.012.127	\$1,130
splendure™ stainless steel	
10.261.012.000	\$900
chrome	

- Single-lever mixer - optional right or left side lever installation
- caché® adjustable, hidden aerator reduces splash and side spray
- KWC 25mm ceramic cartridge
- Variable flow rate and temperature control
- Flow rate max 1.75 gpm (60 psi)
- Overall height 15 1/2"
- Spout swivel range 160°
- Spout reach from deck 7 7/8"
- Mounting hole size $\varnothing 1 \frac{3}{8}$ "

SIN Soap Dispenser

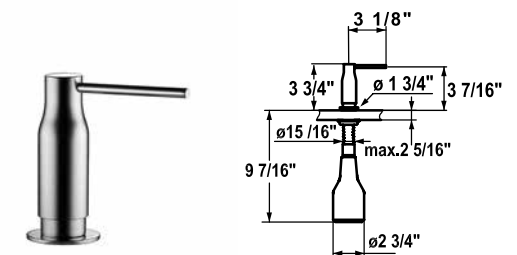

Z.536.332.127	\$515
splendure™ solid stainless steel	
Z.536.332.000	\$415
chrome	

- Antimicrobial soap container
- Easy to use, one hand pump operation
- Refillable from surface, no need for removing soap container
- Large capacity bottle 11.8 fl oz. Z.635.713
- Mounting hole size $\varnothing 1 \frac{3}{8}$ "



KWC **EVE**

SIMPLE & ENERGY SAVING



AESTHETICS WITH FOCUS

Iridescent luminaqua LED lighting embedded into the pull-down aerator brings tranquil beauty to your kitchen. But the beauty transcends aesthetics alone and provides task lighting for your basin.



SLEEK AND FITTED

The pull-down spray with flexible hose is incorporated into the faucet design. Others will admire its beauty. You'll know how practical it really is.



Elegant and stylish yet practical, KWC EVE faucets combine sleek design with a 270-degree swivel spout and a 24-inch pull-down spray head. Integrated LED lights in the faucet head add aesthetics and illuminate your workspace.

EVE Pull-Down Faucet with luminaqua LED-Technology

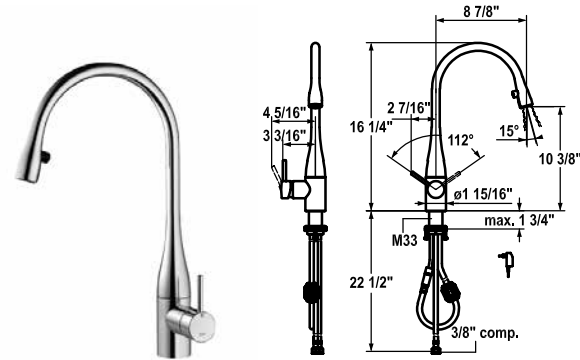

10.121.103.700	\$1,645
solid stainless steel	
10.121.103.000	\$1,395
chrome	

- Single-lever mixer - optional right or left side lever installation
- luminaqua LED light with integrated on/off switch
- Light switches off automatically after 45 minutes
- caché® adjustable aerator reduces splash and side spray
- Hose pull out length up to 24"
- Hose guide secures hose back into place
- KWC safety control 35mm ceramic cartridge
- Variable flow rate and temperature control
- Flow rate max 1.75 gpm (60 psi)
- Overall height 16 1/4"
- Spout swivel range 320°
- Spout reach from deck 8 7/8"
- Mounting hole size ø1 3/8"
- Power supply 100-240 V, operating voltage 6.75 V, power cord 43" in length

EVE Pull-Down Faucet

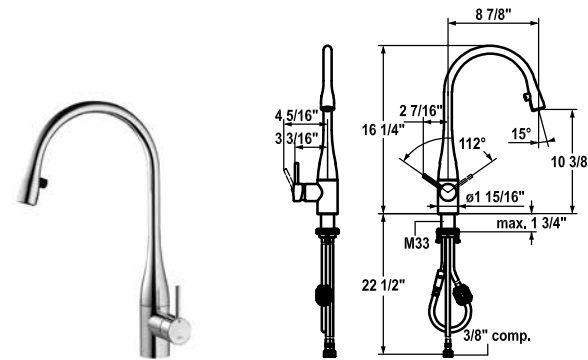

10.111.103.700	\$1,395
solid stainless steel	
10.111.103.000	\$1,170
chrome	

- Single-lever mixer - optional right or left side lever installation
- caché® adjustable aerator reduces splash and side spray
- Concealed pull-down spray head
- Hose pull out length up to 24"
- Hose guide secures hose back into place
- KWC safety control 35mm ceramic cartridge
- Variable flow rate and temperature control
- Flow rate max 1.75 gpm (60 psi)
- Overall height 16 1/4"
- Spout swivel range 320°
- Spout reach from deck 8 7/8"
- Mounting hole size ø1 3/8"

EVE Prep Pull-Down Faucet

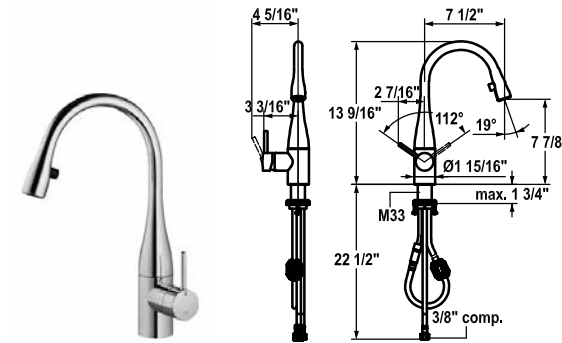

10.111.102.700	\$1,395
solid stainless steel	
10.111.102.000	\$1,130
chrome	

- Single-lever mixer - optional right or left side lever installation
- caché® adjustable aerator reduces splash and side spray
- Concealed pull-down spray head
- Hose pull out length up to 24"
- Hose guide secures hose back into place
- KWC safety control 35mm ceramic cartridge
- Variable flow rate and temperature control
- Flow rate max 1.75 gpm (60 psi)
- Overall height 13 9/16"
- Spout swivel range 320°
- Spout reach from deck 7 1/2"
- Mounting hole size ø1 3/8"

EVE Soap Dispenser

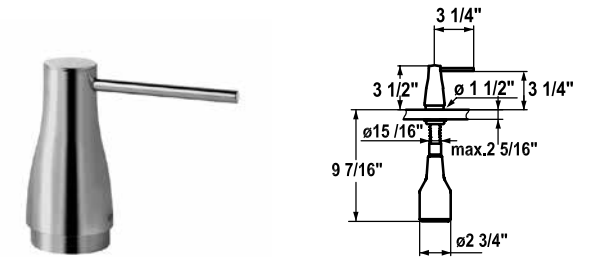

Z.536.063.700	\$525
solid stainless steel	
Z.536.063.000	\$375
chrome	

- Antimicrobial soap container
- Easy to use, one hand pump operation
- Refillable from surface, no need for removing soap container
- Large capacity bottle 11.8 fl oz. Z.635.713
- Mounting hole size ø1" - 1 3/8"
- Ordered separately:
Escutcheon Z.536.291.000

KWC SUPRIMO knows that you appreciate good performance. Made of stainless steel, this faucet is as immaculate and robust as its material suggests and is sure to set plenty of new standards in your kitchen – whether it is in terms of material quality, precision or elegance.



KWC SUPRIMO

A BODY FULL OF STEEL



IN AND OUT

Our pull-out aerator extends 28 inches to add maximum flexibility to your faucet. It retracts automatically when not in use for true hands-free convenience.



TURN AND LOCK (TAL)

While most faucets revert to aerator mode when turned off, our Turn and Lock feature lets you lock-in the spray mode to effortlessly access the flow that's right for the job.

SUPRIMO Tall Pull-Out Faucet with jetclean

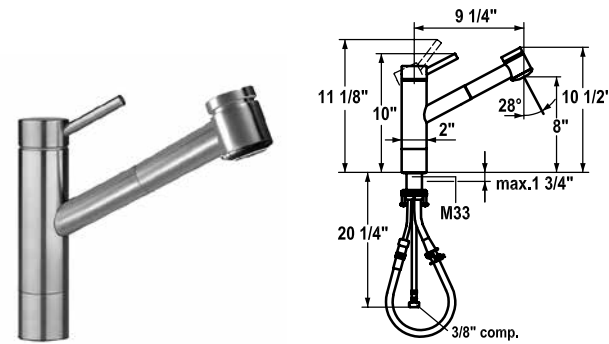

10.271.333.700
solid stainless steel

\$1,465

- Single-lever mixer with extended 1⁵/₈" height
- jetclean technology prevents limescale deposits
- Hose pull out length up to 28"
- Hose guide secures hose back into place
- KWC safety control 39mm ceramic cartridge
- Variable flow rate and temperature control
- Flow rate max 1.75 gpm (60 psi)
- Overall height 10"
- Spout swivel range 130°
- Spout reach from deck 9 1/4"
- Mounting hole size \varnothing 1 3/8"

SUPRIMO Pull-Out Faucet with jetclean

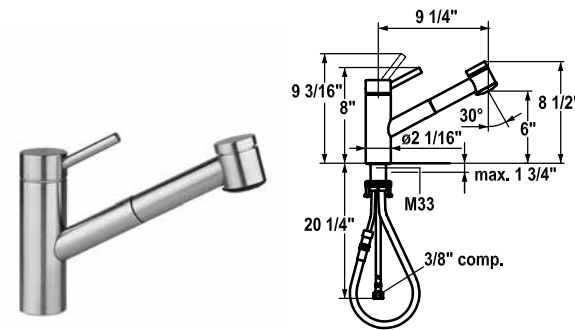

10.271.033.700
solid stainless steel

\$1,395

- Single-lever mixer
- jetclean technology prevents limescale deposits
- Lockable jet spray with automatic diverter reset
- Hose pull out length up to 28"
- Hose guide secures hose back into place
- KWC safety control 39mm ceramic cartridge
- Variable flow rate and temperature control
- Flow rate max 1.75 gpm (60 psi)
- Overall height 8"
- Spout swivel range 130°
- Spout reach from deck 9 1/4"
- Mounting hole size \varnothing 1 3/8"



SUPRIMO Tall Pull-Out Faucet

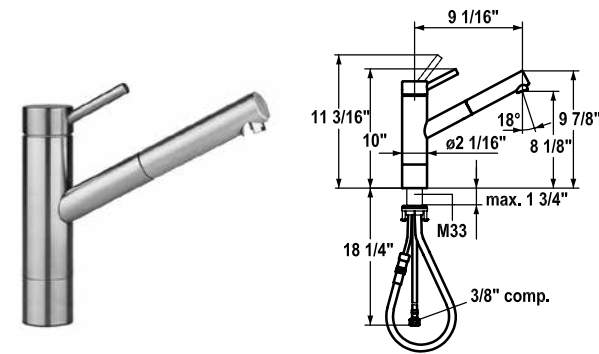

10.271.303.700

solid stainless steel

\$1,340

- Single-lever mixer with extended 1⁵/₁₆" height
- caché® adjustable aerator reduces splash and side spray
- Concealed pull-out spray head
- Hose pull out length up to 28"
- Hose guide secures hose back into place
- KWC safety control 39mm ceramic cartridge
- Variable flow rate and temperature control with limitation
- Flow rate max 1.75 gpm (60 psi)
- Overall height 10"
- Spout swivel range 130°
- Spout reach from deck 9 1/16"
- Mounting hole size \varnothing 1 3/8"

SUPRIMO Pull-Out Faucet

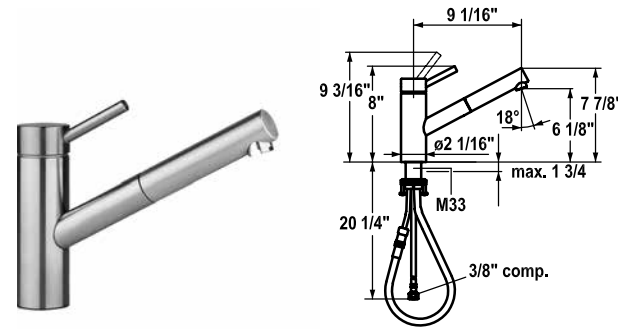

10.271.103.700

solid stainless steel

\$1,275

- Single-lever mixer
- Lockable jet spray with automatic diverter reset
- Hose pull out length up to 28"
- Hose guide secures hose back into place
- KWC safety control 39mm ceramic cartridge
- Variable flow rate and temperature control with limitation
- Flow rate max 1.75 gpm (60 psi)
- Overall height 8"
- Spout swivel range 130°
- Spout reach from deck 9 1/16"
- Mounting hole size \varnothing 1 3/8"

SUPRIMO Soap Dispenser

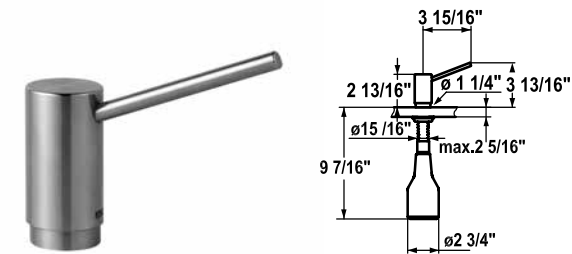

Z.536.062.700

solid stainless steel

\$527

- Antimicrobial soap container
- Easy to use, one hand pump operation
- Refillable from surface, no need for removing soap container
- Large capacity bottle 11.8 fl oz. Z.635.713
- Mounting hole size \varnothing 1" - 1 3/8"

KWC LIVELLO

THE PERFECT SHAPE

Choose right or left side lever installation and chrome or stainless steel finish. Continuously variable flow and temperature allow you to adjust the water to your precise needs. Unlike conventional faucets, LIVELLO is designed so that water flows colder when the handle is pulled forward, so it's child safe too.

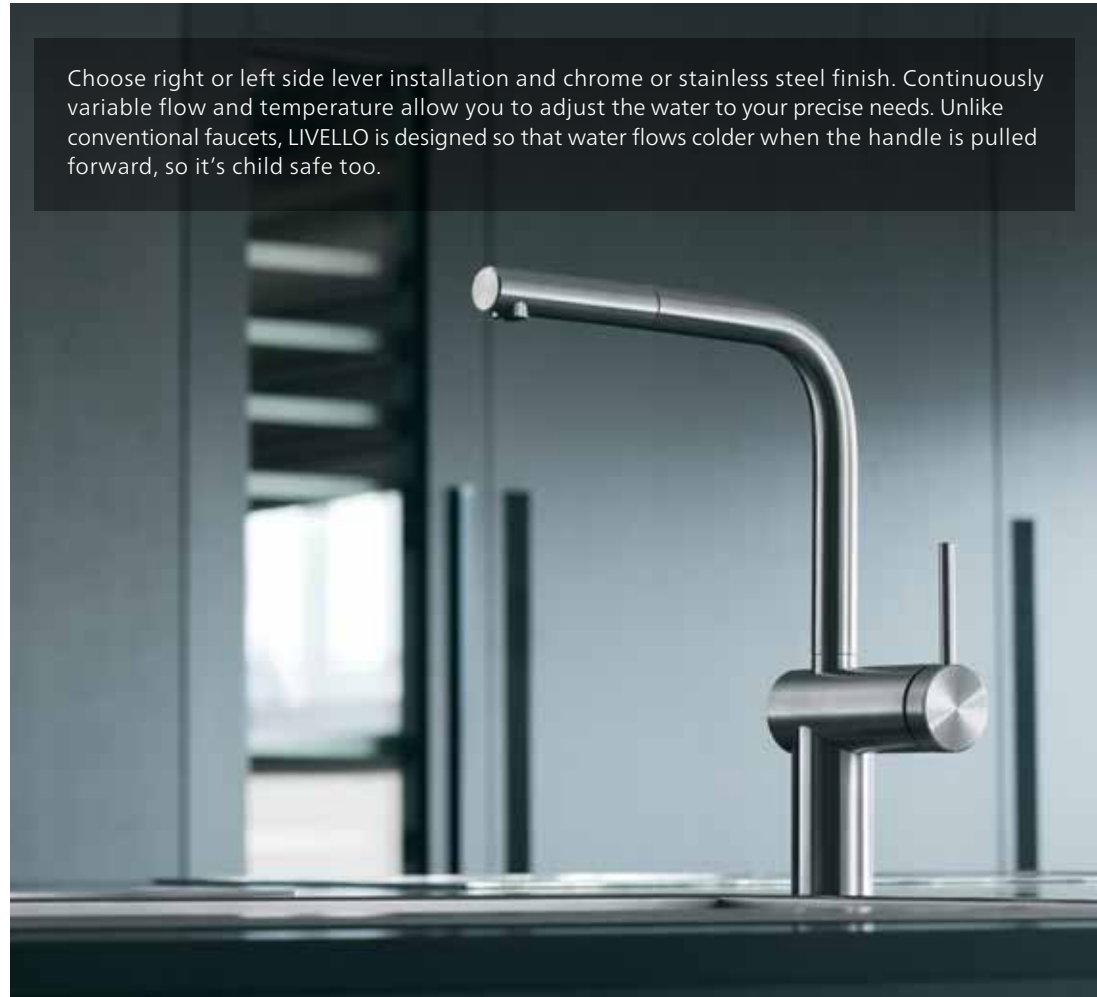

THICK AND THIN

Simple aesthetics, cleverly thought out down to the smallest detail: KWC LIVELLO is available in solid stainless steel or with a chrome finish, with an operating lever that forms a distinctive feature of its design.

LIVELLO Pull-Out Faucet

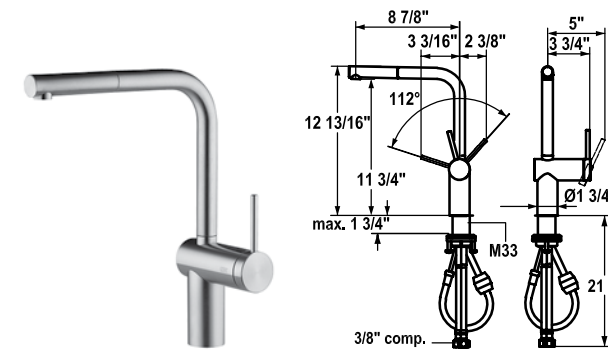

10.231.103.700
solid stainless steel

\$1,275

- Single-lever mixer - right side lever installation only
- Cold water flow positioned towards front for child safety
- caché® adjustable aerator reduces splash and side spray
- Hose pull out length up to 24"
- Hose guide secures hose back into place
- KWC safety control 35mm ceramic cartridge
- Variable flow rate and temperature control
- Flow rate max 1.75 gpm (60 psi)
- Overall height 12 13/16"
- Spout swivel range 360°
- Spout reach from deck 8 7/8"
- Mounting hole size \varnothing 1 3/8"

LIVELLO Pull-Out Faucet

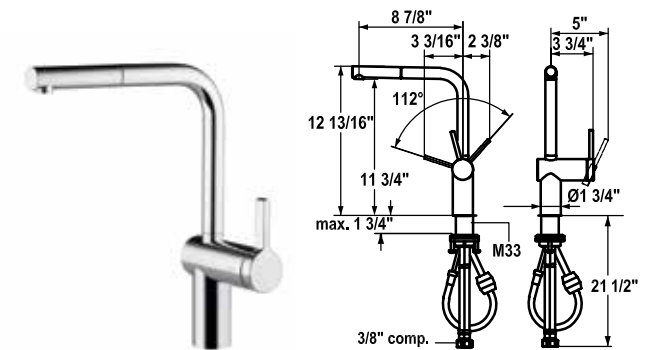

10.231.103.000
chrome

\$1,055

- Single-lever mixer - right side lever installation only
- Cold water flow positioned towards front for child safety
- caché® adjustable aerator reduces splash and side spray
- Hose pull out length up to 24"
- Hose guide secures hose back into place
- KWC safety control 35mm ceramic cartridge
- Variable flow rate and temperature control
- Flow rate max 1.75 gpm (60 psi)
- Overall height 12 13/16"
- Spout swivel range 360°
- Spout reach from deck 8 7/8"
- Mounting hole size \varnothing 1 3/8"



KWC AVA will satisfy both your fine sense of style and your requirement for reliable Swiss quality and state-of-the-art technology. With this faucet, you are sending out a clear message in your kitchen: Whoever lives here knows precisely what he or she wants.

KWC **AVA**

REDUCED TO THE PURE ESSENTIALS



UP AND DOWN

KWC AVA's flat lever has virtually become its trademark feature. It is based on a concealed mechanism that feels completely new, with the lever turning and rising simultaneously when you turn the faucet on.

AVA Pull-Out Faucet with jetclean

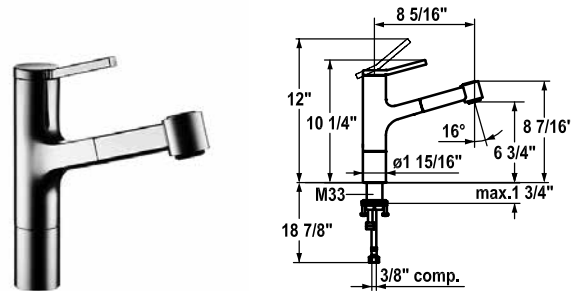

10.191.033.127	\$1,055
splendure™ stainless steel	
10.191.033.000	\$815
chrome	

- Single-lever mixer
- jetclean technology prevents limescale deposits
- Hose pull out length up to 28"
- Hose guide secures hose back into place
- KWC safety control 35mm ceramic cartridge
- Variable flow rate and temperature control
- Flow rate max 1.75 gpm (60 psi)
- Overall height 10 1/4"
- Spout swivel range 160°
- Spout reach from deck 8 5/16"
- Mounting hole size $\varnothing 1 \frac{3}{8}$ "

AVA Pull-Out Faucet with jetclean

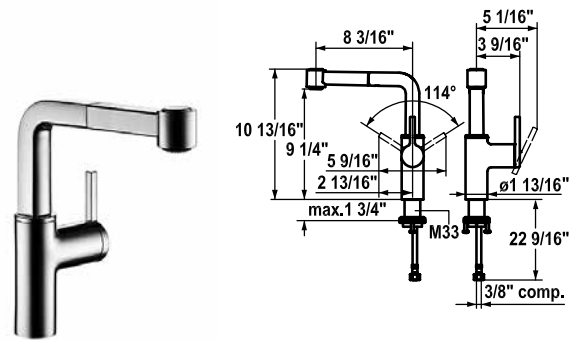

10.191.003.127	\$1,055
splendure™ stainless steel	
10.191.003.000	\$815
chrome	

- Single-lever mixer - optional right or left side lever installation
- jetclean technology prevents limescale deposits
- Hose pull out length up to 24"
- Hose guide secures hose back into place
- KWC safety control 35mm ceramic cartridge
- Variable flow rate and temperature control
- Flow rate max 1.75 gpm (60 psi)
- Overall height 10 13/16"
- Spout swivel range 360°
- Spout reach from deck 8 3/16"
- Mounting hole size $\varnothing 1 \frac{3}{8}$ "



AVA Pull-Out Faucet

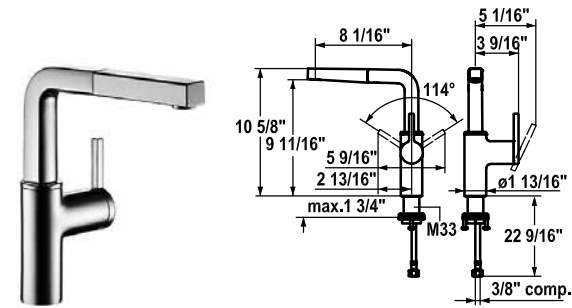

10.191.103.127	\$995
splendure™ stainless steel	
10.191.103.000	\$755
chrome	

- Single-lever mixer - optional right or left side lever installation
- caché® adjustable aerator reduces splash and side spray
- Hose pull out length up to 24"
- Hose guide secures hose back into place
- KWC safety control 35mm ceramic cartridge
- Variable flow rate and temperature control
- Flow rate max 1.75 gpm (60 psi)
- Overall height 10 5/8"
- Spout swivel range 360°
- Spout reach from deck 8 1/16"
- Mounting hole size \varnothing 1 3/8"



AVA Soap Dispenser

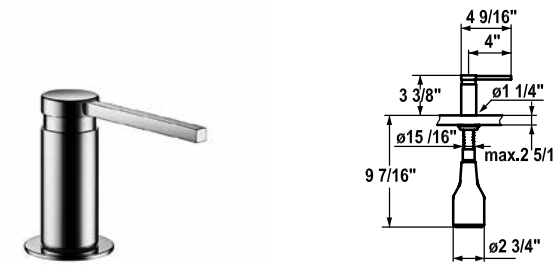

Z.536.159.127	\$355
splendure™ stainless steel	
Z.536.159.000	\$255
chrome	

- Antimicrobial soap container
- Easy to use, one hand pump operation
- Refillable from surface, no need for removing soap container
- Large capacity bottle 11.8 fl oz. Z.635.713
- Mounting hole size \varnothing 1" - 1 3/8"

AVA Potfiller Service Faucet

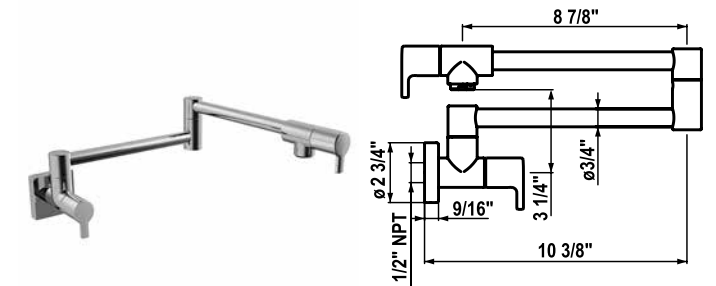

10.001.367.127	\$765
splendure™ stainless steel	
10.001.367.000	\$665
chrome	

- Dual swivel spout
- cascade® limescale protection aerator
- Spout extension 19"
- KWC safety control dual 1/4" turn ceramic cartridges
- Wall and spout shut-off
- Valves must be closed when faucet is left unattended
- Cold water only
- Flow rate max 2.2 gpm (60 psi)
- Connecting thread 1/2" FPT

KWC **DOMO**

A TRUE SYMBOL OF MODERNITY



TIGHTLY SEALED

This innovative sealing membrane keeps your faucets watertight for a long period of time. It protects the control cartridge from residue left by cleaning agents and dirt. The lever support is reinforced with a metal core and integrated into the membrane, reliably preventing the lever from coming loose.



The iconic KWC DOMO has been the faucet of choice in Switzerland for more than 30 years. With a commitment to retaining the original standard of quality, KWC has updated the DOMO series to offer today's consumers a classic faucet design that fits modern lifestyles.

DOMO

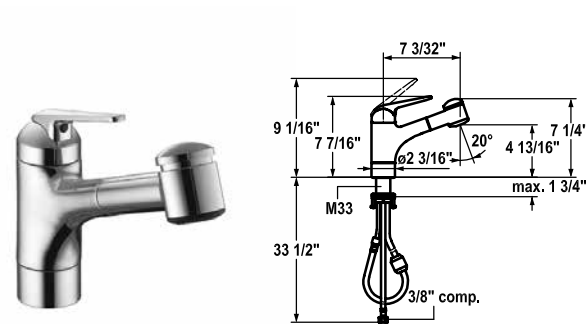
Pull-Out Faucet with flexguard & jetclean

10.061.032.127	\$925
splendure™ stainless steel	
10.061.032.000	\$725
chrome	

- Single-lever mixer
- flexguard sealing membrane protects faucet interior
- jetclean technology prevents limescale deposits
- Hose pull out length up to 28"
- Hose guide secures hose back into place
- Lockable spray
- KWC safety control 39mm ceramic cartridge
- Variable flow rate and temperature control with limitation
- Flow rate max 1.75 gpm (60 psi)
- Overall height 7 7/16"
- Spout swivel range 130°
- Spout reach from deck 7 3/32"
- Mounting hole size $\varnothing 1 \frac{3}{8}$ "

DOMO

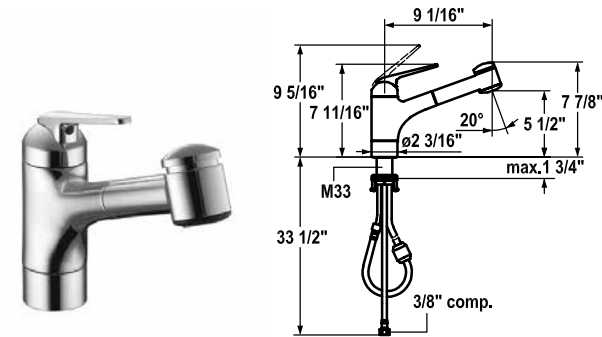
Pull-Out Faucet with flexguard & jetclean

10.061.033.127	\$925
splendure™ stainless steel	
10.061.033.000	\$725
chrome	

- Single-lever mixer
- flexguard sealing membrane protects faucet interior
- jetclean technology prevents limescale deposits
- Hose pull out length up to 28"
- Hose guide secures hose back into place
- Lockable spray
- KWC safety control 39mm ceramic cartridge
- Variable flow rate and temperature control with limitation
- Flow rate max 1.75 gpm (60 psi)
- Overall height 7 11/16"
- Spout swivel range 130°
- Spout reach from deck 9 1/16"
- Mounting hole size $\varnothing 1 \frac{3}{8}$ "

DOMO

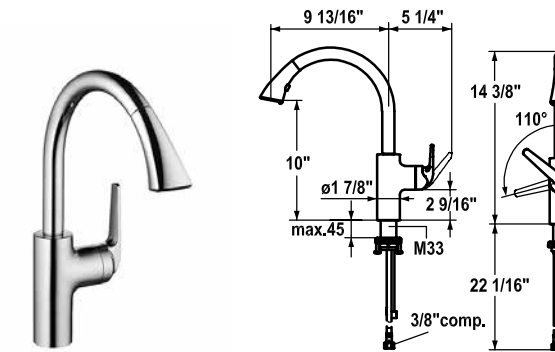
Pull-Down Faucet with flexguard

10.061.004.127	\$925
splendure™ stainless steel	
10.061.004.000	\$725
chrome	

- Single-lever mixer - right side lever installation only
- Cold water flow positioned towards front for child safety
- flexguard sealing membrane protects faucet interior
- jetclean technology prevents limescale deposits
- caché® adjustable aerator reduces splash and side spray
- Pull-down spray head with magnetic holder
- Hose pull out length up to 24"
- Hose guide secures hose back into place
- Acoustic group 1
- KWC safety control 39mm ceramic cartridge
- Variable flow rate and temperature control with limitation
- Flow rate max 1.75 gpm (60 psi)
- Overall height 14 3/8"
- Spout swivel range 360°
- Spout reach from deck 9 13/16"
- Mounting hole size $\varnothing 1 \frac{3}{8}$ "

DOMO

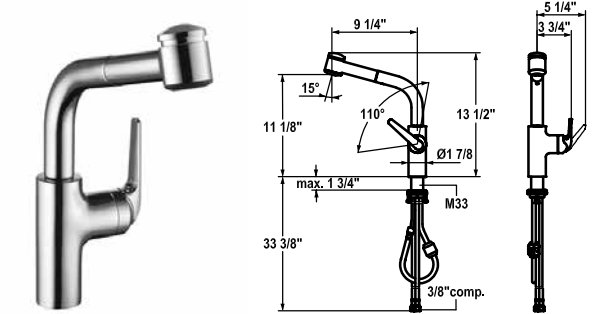
Pull-Out Faucet with flexguard & jetclean

10.061.003.127	\$925
splendure™ stainless steel	
10.061.003.000	\$725
chrome	

- Single-lever mixer - right side lever installation only
- Cold water flow positioned towards front for child safety
- flexguard sealing membrane protects faucet interior
- jetclean technology prevents limescale deposits
- Hose pull out length up to 28"
- Hose guide secures hose back into place
- Lockable spray
- KWC safety control 39mm ceramic cartridge
- Variable flow rate and temperature control with limitation
- Flow rate max 1.75 gpm (60 psi)
- Overall height 13 1/2"
- Spout swivel range 360°
- Spout reach from deck 9 1/4"
- Mounting hole size $\varnothing 1 \frac{3}{8}$ "

DOMO Bar Faucet with flexguard

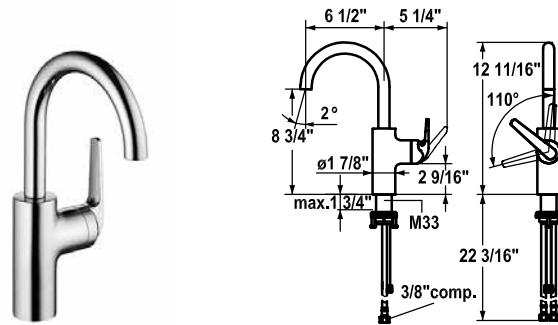

10.061.991.127	\$665
splendure™ stainless steel	
10.061.991.000	\$465
chrome	

- Single-lever mixer - right side lever installation only
- Cold water flow positioned towards front for child safety
- flexguard sealing membrane protects faucet interior
- caché® adjustable aerator reduces splash and side spray
- KWC safety control 39mm ceramic cartridge
- Variable flow rate and temperature control with limitation
- Flow rate max 1.75 gpm (60 psi)
- Overall height 12 11/16"
- Spout swivel range 160°
- Spout reach from deck 6 1/2"
- Mounting hole size \varnothing 1 3/8"



Innovation persists with LUNA-E faucets, which brings new benefits into the family while incorporating the much-loved features of its predecessor. Add in superior luxury and technology, and it emerges as a complementary style that pairs well with both contemporary and classic kitchens.



KWC LUNA-E MAKING EVERYDAY LIFE SPECIAL



JETCLEAN

The jetclean faceplate prevents limescale deposits in the kitchen spray and makes it easier to clean. The cone-shaped sieve holes expand when water flows and blasts off stubborn limescale deposits. The holes return to their normal size once the water is turned off.



MICRO SPRAY

This innovative feature allows you to direct water exactly where it is needed.

LUNA-E Pull-Down Faucet

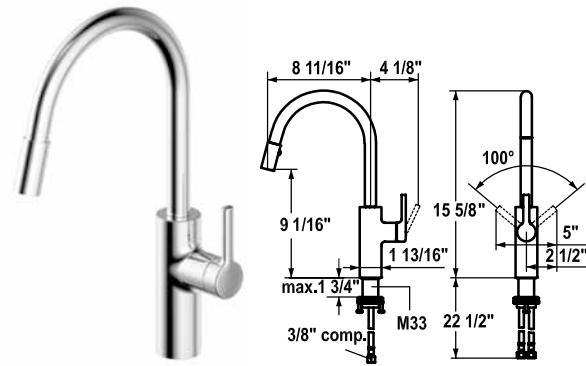

10.441.003.127	\$755
splendure™ stainless steel	
10.441.003.000	\$645
chrome	

- Single-lever mixer - right side lever installation only
- Cold water flow positioned towards front for child safety
- caché® adjustable aerator reduces splash and side spray
- Hose pull out length up to 24"
- Hose guide secures hose back into place
- KWC 25mm ceramic cartridge
- Variable flow rate and temperature control
- Flow rate max 1.75 gpm (60 psi)
- Overall height 15 5/8"
- Spout swivel range 360°
- Spout reach from deck 8 11/16"
- Mounting hole size \varnothing 1 3/8"

LUNA-E Pull-Out Faucet with jetclean

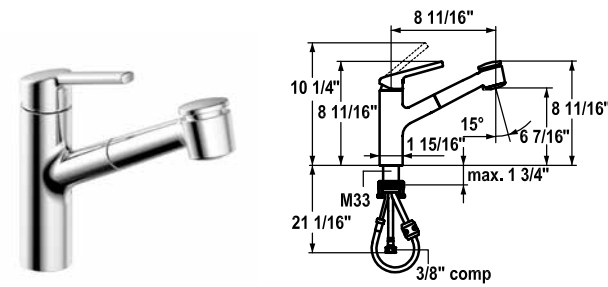

10.441.033.127	\$695
splendure™ stainless steel	
10.441.033.000	\$595
chrome	

- Single-lever mixer
- jetclean technology prevents limescale deposits
- Hose pull out length up to 24"
- Hose guide secures hose back into place
- KWC safety control 35mm ceramic cartridge
- Variable flow rate and temperature control
- Flow rate max 1.75 gpm (60 psi)
- Overall height 8 11/16"
- Spout swivel range 130°
- Spout reach from deck 8 11/16"
- Mounting hole size \varnothing 1 3/8"

LUNA-E Prep Faucet

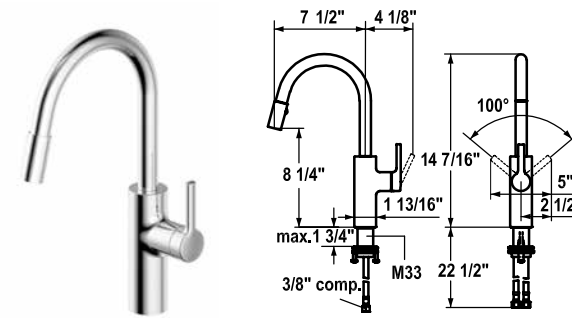

10.441.002.127	\$695
splendure™ stainless steel	
10.441.002.000	\$595
chrome	

- Single-lever mixer - right side lever installation only
- Cold water flow positioned towards front for child safety
- caché® adjustable aerator reduces splash and side spray
- Hose pull out length up to 24"
- Hose guide secures hose back into place
- KWC 25mm ceramic cartridge
- Variable flow rate and temperature control
- Flow rate max 1.75 gpm (60 psi)
- Overall height 14 7/16"
- Spout swivel range 360°
- Spout reach from deck 7 1/2"
- Mounting hole size \varnothing 1 3/8"

LUNA-E Bar Faucet

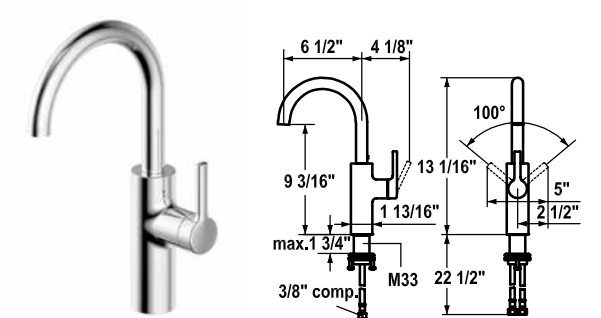

10.441.012.127	\$545
splendure™ stainless steel	
10.441.012.000	\$445
chrome	

- Single-lever mixer - right side lever installation only
- Cold water flow positioned towards front for child safety
- caché® adjustable aerator reduces splash and side spray
- KWC 25mm ceramic cartridge
- Variable flow rate and temperature control
- Flow rate max 1.75 gpm (60 psi)
- Overall height 13 1/16"
- Spout swivel range 160°
- Spout reach from deck 6 1/2"
- Mounting hole size \varnothing 1 3/8"

LUNA-E Cold Filtration Faucet

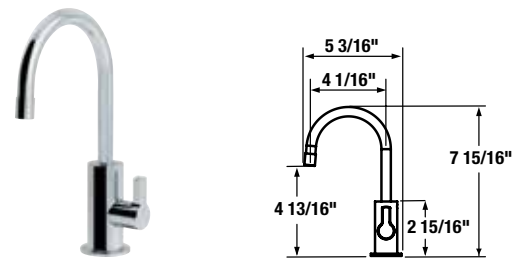

25.441.110.127	\$555
splendure™ stainless steel	
25.441.110.000	\$455
chrome	

- Single-lever mixer
- Cold water filtered only
- KWC 3/8" ceramic cartridge
- Variable flow rate and temperature control
- Flow rate max .5 gpm (60 psi)
- Overall height 7 15/16"
- Spout swivel range 360°
- Spout reach from deck 4 1/16"
- Mounting hole size ø1 1/4"

LUNA-E Hot Filtration Faucet

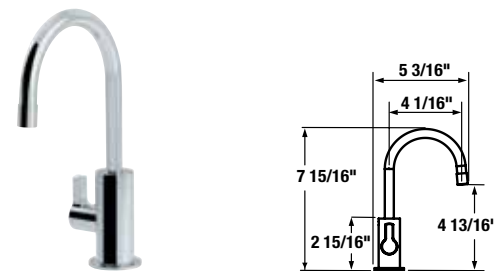

25.441.120.127	\$555
splendure™ stainless steel	
25.441.120.000	\$455
chrome	

- Single-lever mixer
- Hot water filtered only
- KWC 3/8" ceramic cartridge
- Variable flow rate and temperature control
- Flow rate max .5 gpm (60 psi)
- Overall height 7 15/16"
- Spout swivel range 360°
- Spout reach from deck 4 1/16"
- Mounting hole size ø1 1/4"

LUNA-E Hot/Cold Filtration Faucet

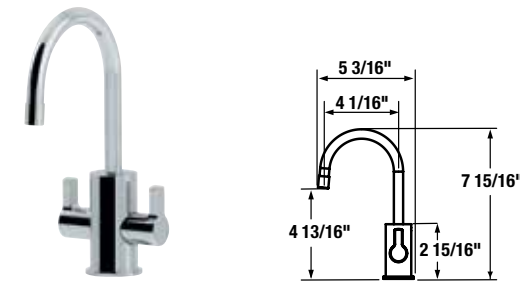

25.441.130.127	\$675
splendure™ stainless steel	
25.441.130.000	\$575
chrome	

- Double-lever mixer
- Hot and cold water filtration
- KWC 3/8" ceramic cartridge
- Variable flow rate and temperature control
- Flow rate max .5 gpm (60 psi)
- Overall height 7 15/16"
- Spout swivel range 360°
- Spout reach from deck 4 1/16"
- Mounting hole size ø1 1/4"

LUNA-E Potfiller Service Faucet

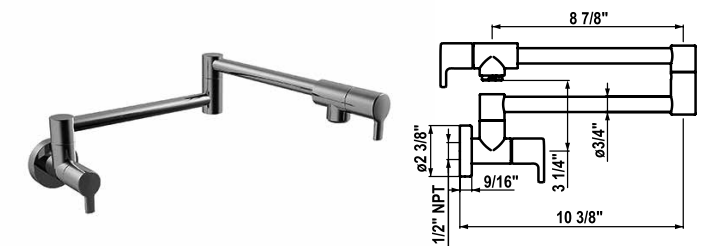

10.001.357.127	\$795
splendure™ stainless steel	
10.001.357.000	\$695
chrome	

- Dual swivel spout
- cascade® limescale protection aerator
- Spout extension 19"
- KWC safety control dual 1/4" turn ceramic cartridges
- Wall and spout shut-off
- Valves must be closed when faucet is left unattended
- Cold water only
- Flow rate max 2.2 gpm (60 psi)
- Connecting thread 1/2" FPT

KWC POTFILLERS



AVA Potfiller Service Faucet

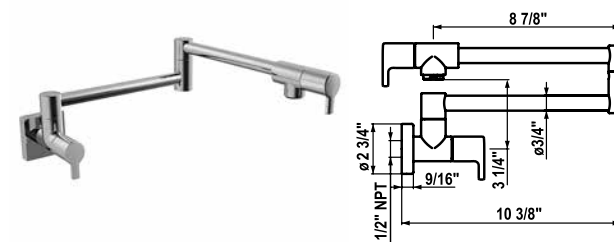

10.001.367.127	\$765
splendure™ stainless steel	
10.001.367.000	\$665
chrome	

- Dual swivel spout
- cascade® limescale protection aerator
- Spout extension 19"
- KWC safety control dual ¼" turn ceramic cartridges
- Wall and spout shut-off
- Valves must be closed when faucet is left unattended
- Cold water only
- Flow rate max 2.2 gpm (60 psi)
- Connecting thread ½" FPT

LUNA-E Potfiller Service Faucet

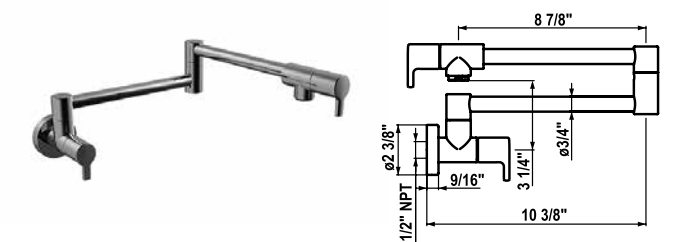

10.001.357.127	\$795
splendure™ stainless steel	
10.001.357.000	\$695
chrome	

- Dual swivel spout
- cascade® limescale protection aerator
- Spout extension 19"
- KWC safety control dual ¼" turn ceramic cartridges
- Wall and spout shut-off
- Valves must be closed when faucet is left unattended
- Cold water only
- Flow rate max 2.2 gpm (60 psi)
- Connecting thread ½" FPT

KWC SOAP DISPENSERS



KWC
NEW

ERA Soap Dispenser

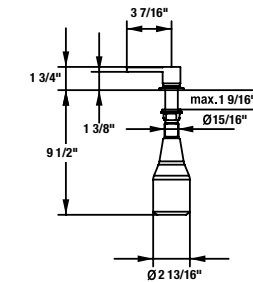

Z.538.038.700

solid stainless steel

\$495

- Antimicrobial soap container
- Easy to use, one hand pump operation
- Refillable from surface, no need for removing soap container
- Large capacity bottle 11.8 fl oz. Z.538.053
- Mounting hole size $\varnothing 1'' - 1 \frac{3}{8}''$

ZOE Soap Dispenser

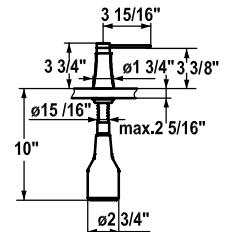

Z.536.586.127

splendure™ stainless steel

\$550

Z.536.586.000

chrome

\$450

Z.536.586.176

matte black

\$460

- Antimicrobial soap container
- Easy to use, one hand pump operation
- Refillable from surface, no need for removing soap container
- Large capacity bottle 11.8 fl oz. Z.635.713
- Mounting hole size $\varnothing 1'' - 1 \frac{3}{8}''$
- Ordered separately:
Escutcheon Z.536.291.000

ONO Soap Dispenser

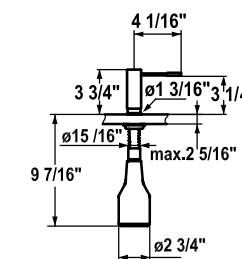

Z.536.060.700

solid stainless steel

\$525

Z.536.060.000

chrome

\$385

- Antimicrobial soap container
- Easy to use, one hand pump operation
- Refillable from surface, no need for removing soap container
- Large capacity bottle 11.8 fl oz. Z.635.713
- Mounting hole size $\varnothing 1'' - 1 \frac{3}{8}''$
- Ordered separately:
Escutcheon Z.536.291.000

EVE Soap Dispenser

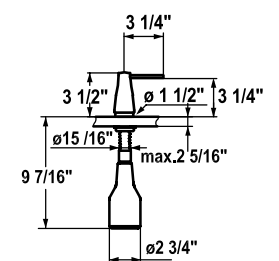

Z.536.063.700

solid stainless steel

\$525

Z.536.063.000

chrome

\$375

- Antimicrobial soap container
- Easy to use, one hand pump operation
- Refillable from surface, no need for removing soap container
- Large capacity bottle 11.8 fl oz. Z.635.713
- Mounting hole size $\varnothing 1'' - 1 \frac{3}{8}''$
- Ordered separately:
Escutcheon Z.536.291.000

AVA Soap Dispenser

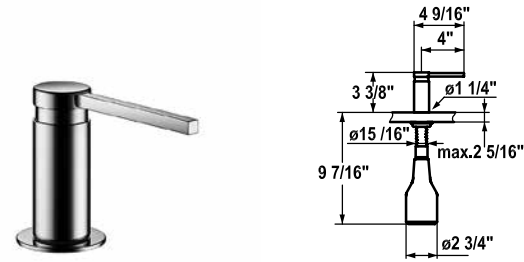

Z.536.159.127	\$355
splendure™ stainless steel	
Z.536.159.000	\$255
chrome	

- Antimicrobial soap container
- Easy to use, one hand pump operation
- Refillable from surface, no need for removing soap container
- Large capacity bottle 11.8 fl oz. Z.635.713
- Mounting hole size $\varnothing 1'' - 1 \frac{3}{8}''$

SUPRIMO Soap Dispenser

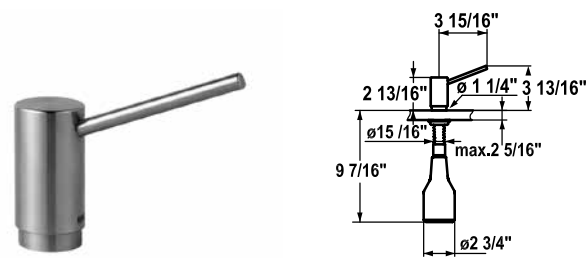

Z.536.062.700	\$527
solid stainless steel	

- Antimicrobial soap container
- Easy to use, one hand pump operation
- Refillable from surface, no need for removing soap container
- Large capacity bottle 11.8 fl oz. Z.635.713
- Mounting hole size $\varnothing 1'' - 1 \frac{3}{8}''$

SIN Soap Dispenser

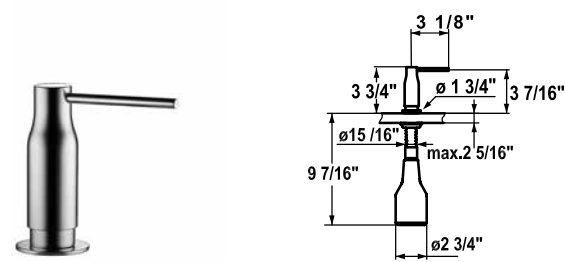

Z.536.332.127	\$515
splendure™ stainless steel	
Z.536.332.000	\$415
chrome	

- Antimicrobial soap container
- Easy to use, one hand pump operation
- Refillable from surface, no need for removing soap container
- Large capacity bottle 11.8 fl oz. Z.635.713
- Mounting hole size $\varnothing 1'' - 1 \frac{3}{8}''$

PRIMO Soap Dispenser

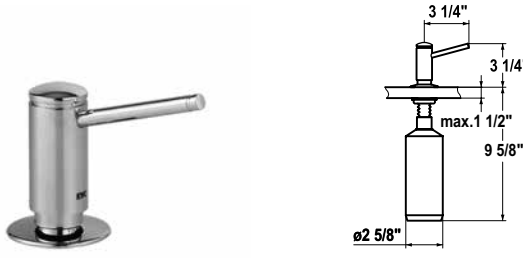

Z.504.938.127	\$315
splendure™ stainless steel	
Z.504.938.700	\$255
solid stainless steel	
Z.504.938.000	\$175
chrome	

- Antimicrobial soap container
- Easy to use, one hand pump operation
- Refillable from surface, no need for removing soap container
- Large capacity bottle 11.8 fl oz. Z.635.713
- Mounting hole size $\varnothing 1'' - 1 \frac{3}{8}''$

BASIC Soap Dispenser

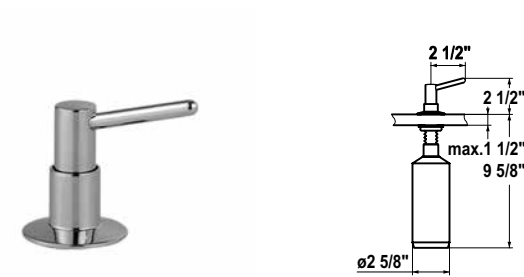

Z.504.937.000	\$105
chrome	

- Antimicrobial soap container
- Easy to use, one hand pump operation
- Refillable from surface, no need for removing soap container
- Large capacity bottle 11.8 fl oz. Z.635.713
- Mounting hole size $\varnothing 1'' - 1 \frac{3}{8}''$

Spare Parts

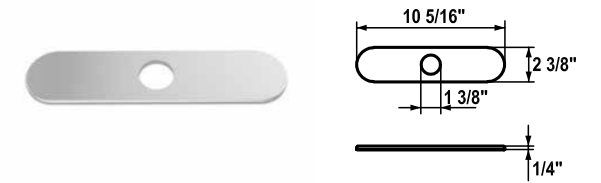

Z.535.307.127	\$90
splendure™ stainless steel	
Z.535.307.000	\$70
chrome	

- Cover plate used with single-hole mixers to cover unused mounting holes
- 3-hole

GENERAL

- Products may only be sold and advertised within the United States of America. Franke/KWC hereby expressly prohibits the dealer from soliciting or consummating sales outside of the United States of America without prior written consent.
- Products shall only be sold in their original packaging. Relabeling, repackaging (including the separation of bundled products or the bundling of separate products), and other alterations are not permitted.
- Sale of Franke/KWC products on the Internet shall be prohibited unless resellers apply and are approved by Franke/KWC, and execute an Authorized Internet Reseller Agreement regulating the manner in which they sell online.

ORDERING

- Once an order has been acknowledged, no changes (including additions or cancellations) will be accepted.
- Order acknowledgments are available via email. An email address must be provided to receive this benefit.
- Standard lead time for shipment is one to five (1-5) business days from receipt of order.

STANDARD PAYMENT TERMS

- Net 30 days.
- Early payment discounts are not applicable for payments via credit card.
- Franke/KWC reserves the right to charge interest and an administration fee on late payments.

PRICING

- Please refer to the electronically published price list (EPL). Orders will be priced with the prevailing price at the time the order is placed.
- Prices are subject to change without notice. Franke/KWC will attempt to provide reasonable lead time for pricing changes.

CLAIMS/CHARGE BACKS

- Damages/Shortages must be reported within ten (10) days of receipt of merchandise.
- Charge backs will not be accepted without an authorization number (RMA), provided by a Regional Sales Manager, Distributor, or Customer Service.

RETURNS

- No returns will be accepted without a return authorization number (RMA).
- Return authorization requests must be submitted through Rep/Regional Manager.
- A 25% restocking fee will be charged for ALL returns of product that was not damaged or mis-shipped.
- No returns will be accepted more than 180 days from original invoice date.
- No returns will be accepted on discontinued (DWO) or obsolete product.
- Franke/KWC reserves the right to refuse returns without reason.

FREIGHT

Pre-paid freight/Free freight allowance (FFA)

- USD 2,900 is the minimum order value for FFA
- All product lines, including parts, can be included in freight qualification calculations.
- All Display and Literature orders will be shipped with pre-paid freight status.

Flat Rate Shipping

- Any order shipping parcel containing standard products will ship for \$25 flat.
- Orders >150 lbs. are shipping LTL and are charged according to weight/dimension.
- Orders containing Fireclay sinks are charged USD 150 for up to 2 units and USD 300 for up to 4 units.
- Other: standard shipping rates apply for Fireclay orders greater than 4 units and any parts only orders.

Other freights terms

- Franke/KWC will attempt to fulfill requests to expedite shipping. Customers will be responsible for additional freight charges. Contact Customer Service for all expedited shipping requests.
- Drop shipment of internet orders is not available. All Internet Sales must be shipped from an Authorized Internet Reseller's location. Drop shipment is offered within 100 miles of customer's place of business, or within customer's state or a bordering state.

BACK ORDERS

- Back order shipments will match freight qualifying status of original order.
- Back ordered product will be considered an active order unless customer requests cancellation.

LIMITED WARRANTY

FAUCETS

Franke/KWC warrants that mechanical parts in all faucets purchased after January 1, 2003, will be free of manufacturing defects in material and workmanship for the lifetime of the faucet. Faucets purchased prior to 2003 are subject to the warranty in place at time of purchase. Franke/KWC warrants that (1) the chrome finishes on Franke/KWC faucets will be free of manufacturing defect for the lifetime of the faucet; and (2) all other finishes on Franke/KWC faucets will be free of manufacturing defect for five (5) years from the original date of purchase.

LOTION/SOAP DISPENSERS

Franke/KWC warrants that Franke/KWC lotion/soap dispensers are free from manufacturing defects in material and workmanship for a period of 5 years from the date of purchase. Such warranty does not cover damage caused by the use of aggressive soaps and lotions.

OUTDOOR INSTALLATION

Certain Franke/KWC faucets are warranted to be free from manufacturing defects in material and workmanship for outdoor installations for the period set forth in the paperwork included with the product, which is 5 or 10 years from the date of purchase, depending on the model purchased.

WARRANTY TERMS

Each warranty by Franke Kitchen System, LLC ("Franke")/KWC set forth herein (each, a "Warranty" and collectively the "Warranties") applies only to the original owner when purchased from Franke/KWC or a Franke/KWC authorized reseller. The Warranties only apply if the applicable product has been installed in accordance with our installation instructions, used as recommended and in a normal residential application. To make a warranty claim, the owner must provide proof of purchase, in the form of a sales receipt. Each Warranty covers all components that make the applicable product operational. Franke/KWC, at its option, may repair or replace the product or components necessary to restore the product to good working condition. Franke/KWC reserves the right to inspect the installation prior to the actual replacement of the product or component part. The Warranties do not cover any product used in combination with a Reverse Osmosis Filtration System.

The Warranties do not cover misuse or abuse, accidental damages, scuffs or scratches, improper installation, abnormal usage, negligence, damage caused by improper maintenance or cleaning or normal wear. Damage caused by impurities or acts beyond Franke's/KWC's control are not covered by any Warranty. Further, this warranty does not cover any products purchased from unauthorized dealers. If any product or part has been repaired or altered in any manner outside of Franke's/KWC's factory, unless previously authorized in writing by Franke/KWC, the applicable Warranty is void with respect to such product or part. Owner of a product will be liable for any transportation and re-installation costs related to any Warranty for such product. The Warranties do not allow recovery of incidental or consequential damages such as loss of use, delay, property damage or other consequential damage, and Franke/KWC accepts no liability for such damages.

Each Warranty is limited to the conditions set forth herein and to the applicable warranty period specified herein and is exclusive. EXCEPT FOR THE WARRANTIES SET FORTH HEREIN, FRANKE/KWC MAKES NO WARRANTY WHATSOEVER WITH RESPECT TO THE PRODUCTS, INCLUDING, BUT NOT LIMITED TO, (1) ANY WARRANTY OF MERCHANTABILITY, (2) WARRANTY OF FITNESS FOR A PARTICULAR PURPOSE, (3) WARRANTY OF TITLE, OR (4) WARRANTY AGAINST INFRINGEMENT OF INTELLECTUAL PROPERTY RIGHTS OF A THIRD PARTY, WHETHER EXPRESS OR IMPLIED BY LAW, COURSE OF DEALING, COURSE OF PERFORMANCE, USAGE OF TRADE OR OTHERWISE.

LEGAL DISCLAIMER

PLEASE READ CAREFULLY.

Franke Kitchen Systems/KWC provides the above information to you as a public service to our customers. By accessing and using this information, you agree to the following and to comply with all applicable laws. If you do not agree with these terms and conditions, do not use this information. While we try to keep the information current, changes may have occurred since its creation. Contact your Regional Manager or Customer Service to verify information regarding Franke Kitchen Systems/KWC programs and their use by you.

Copyright and Other Intellectual Property Rights. This document and our website are protected by copyright pursuant to U.S. copyright laws, international treaties, and other copyright laws. This document and our website contains copyrighted material, trademarks, and other proprietary information of Franke Consumer Products, Inc./KWC and Franke Kitchen Systems, LLC/KWC and others (collectively "Proprietary Material"), which may include, but shall not be limited to: text, software, photos, video, graphics, images, music and sound. You may not modify, publish, copy, transmit, participate in the transfer or sale of, create derivative works of, or in any way exploit, in whole or in part, any Proprietary Material without the prior written authorization of Franke Kitchen Systems/KWC or the applicable rights holder.

Changes. We may change these terms and any part (or all) of the information enclosed at any time without notice. Any changes will apply to your future use, so you should contact your Regional Manager or Customer Service periodically. If you use this information after any changes to these terms, then you accept those changes.

Choice of Law. We are a Delaware limited liability company and these Terms and Conditions, and the purchase of products from Franke Kitchen Systems/KWC, shall be governed by the substantive laws of the State of Delaware, including the Uniform Commercial Code as adopted in Delaware, and the United Nations Convention on Contracts for the International Sale of Goods shall not apply. Any cause of action must be commenced within one year after the claim or cause of action arises. If a court of competent jurisdiction holds these terms and conditions or any part of them to be invalid, then that part shall be enforced to the maximum extent possible and the remainder of these terms and conditions will remain in full force and effect.

HOW TO CONTACT US

CONTACT INFORMATION:

Customer Service: 888-592-3287
 Customer Service FAX: 888-685-0007
 Customer Service Email: kwcsupport@kwcamerica.com
 Marketing Services: 800-626-5771
 Marketing Services Email: ks-marketingservices.us@franke.com

MAILING ADDRESS:

Franke Kitchen Systems
 800 Aviation Parkway
 Smyrna, TN 37167

SHIPPING ADDRESS:

Franke Kitchen Systems
 600 Franke Drive
 Ruston, LA 71270

REMITTANCE ADDRESS:

Franke Kitchen Systems
 3215 Paysphere Circle
 Chicago, IL 60674

INDEX

KITCHEN	PAGE	PRICE	KITCHEN	PAGE	PRICE
10.001.357.000	73, 75	\$695	10.261.102.127	42	\$1,175
10.001.357.127	73, 75	\$795	10.261.432.000	41	\$1,275
10.001.367.000	61, 75	\$665	10.261.432.127	41	\$1,675
10.001.367.127	61, 75	\$765	10.271.033.700	50	\$1,395
10.061.003.000	65	\$725	10.271.103.700	52	\$1,275
10.061.003.127	65	\$925	10.271.303.700	52	\$1,340
10.061.004.000	65	\$725	10.271.333.700	50	\$1,465
10.061.004.127	65	\$925	10.392.022.700	18	\$1,290
10.061.032.000	64	\$725	10.392.023.700	18	\$1,290
10.061.032.127	64	\$925	10.392.024.700	17	\$1,490
10.061.033.000	64	\$725	10.392.323.700	17	\$1,590
10.061.033.127	64	\$925	10.441.002.000	71	\$595
10.061.991.000	66	\$465	10.441.002.127	71	\$695
10.061.991.127	66	\$665	10.441.003.000	70	\$645
10.111.102.000	47	\$1,130	10.441.003.127	70	\$755
10.111.102.700	47	\$1,395	10.441.012.000	71	\$445
10.111.103.000	46	\$1,170	10.441.012.127	71	\$545
10.111.103.700	46	\$1,395	10.441.033.000	70	\$595
10.121.103.000	46	\$1,395	10.441.033.127	70	\$695
10.121.103.700	46	\$1,645	10.651.122.000	30	\$4,695
10.151.033.000	35	\$1,055	25.441.110.000	72	\$455
10.151.033.700	35	\$1,525	25.441.110.127	72	\$555
10.151.102.000	36	\$1,085	25.441.120.000	72	\$455
10.151.102.700	36	\$1,395	25.441.120.127	72	\$555
10.151.423.000	35	\$2,695	25.441.130.000	73	\$575
10.151.423.700	35	\$3,525	25.441.130.127	73	\$675
10.151.991.000	36	\$1,055	133.0504.199	19	\$160
10.151.991.700	36	\$1,375	Z.504.937.000	79	\$105
10.191.003.000	58	\$815	Z.504.938.000	78	\$175
10.191.003.127	58	\$1,055	Z.504.938.127	78	\$315
10.191.033.000	58	\$815	Z.504.938.700	78	\$255
10.191.033.127	58	\$1,055	Z.535.307.000	79	\$70
10.191.103.000	60	\$755	Z.535.307.127	79	\$90
10.191.103.127	60	\$995	Z.536.060.000	37, 77	\$385
10.201.102.000	26	\$1,165	Z.536.060.700	37, 77	\$525
10.201.102.127	26	\$1,495	Z.536.062.700	53, 78	\$527
10.201.102.176	26	\$1,335	Z.536.063.000	47, 77	\$375
10.201.122.000	26	\$1,395	Z.536.063.700	47, 77	\$525
10.201.122.127	26	\$1,745	Z.536.159.000	61, 78	\$255
10.201.122.176	26	\$1,595	Z.536.159.127	61, 78	\$355
10.201.242.000	22	\$2,650	Z.536.332.000	43, 78	\$415
10.201.242.127	22	\$3,150	Z.536.332.127	43, 78	\$515
10.201.242.176	22	\$2,995	Z.536.352	31	\$93
10.231.103.000	55	\$1,055	Z.536.586.000	27, 77	\$450
10.231.103.700	55	\$1,275	Z.536.586.127	27, 77	\$550
10.261.002.000	41	\$1,055	Z.536.586.176	27, 77	\$460
10.261.002.127	41	\$1,340	Z.536.638.000	30	\$1,745
10.261.012.000	42	\$900	Z.538.038.700	19, 77	\$495
10.261.012.127	42	\$1,130	Z.636.183	31	\$20
10.261.102.000	42	\$935			