

TOTO®

18

2018 PRICE BOOK SUPPLEMENT

Life Anew



TOTO[®]

CONTENTS

ICON GUIDE & CHARTS

- 02 Icon Guide
- 05 Showerheads and Handshowers Charts
- 06 Faucets and Tub Fillers Charts
- 07 Trims and Valves Charts

NEOREST®

- 09 NX2
- 09 NX1
- 10 AH
- 11 RH

WASHLET®+

ONE-PIECE TOILETS

- 13 Aquia® IV 1G WASHLET+ S550e - 1.0 GPF / 0.8 GPF
- 13 Aquia IV 1G WASHLET+ S500e - 1.0 GPF / 0.8 GPF
- 14 Aquia IV WASHLET+ S550e - 1.28 GPF / 0.8 GPF
- 14 Aquia IV WASHLET+ S500e - 1.28 GPF / 0.8 GPF

TWO-PIECE TOILETS

- 15 Aquia IV 1G WASHLET+ S550e - 1.0 GPF / 0.8 GPF
- 15 Aquia IV 1G WASHLET+ S500e - 1.0 GPF / 0.8 GPF
- 16 Aquia IV WASHLET+ S550e - 1.28 GPF / 0.8 GPF
- 16 Aquia IV WASHLET+ S500e - 1.28 GPF / 0.8 GPF

TOILETS & SEATS

ONE-PIECE TOILETS

- 17 Aimes® - 1.28 GPF (*Slim D-Shape SoftClose® Seat*)
- 18 Aquia IV - 1.0 GPF / 0.8 GPF
- 19 Aquia IV - 1.28 GPF / 0.8 GPF
- 20 Legato® - 1.28 GPF (*Slim D-Shape SoftClose Seat*)

TWO-PIECE TOILETS

- 21 Aquia IV 1G - 1.0 GPF / 0.8 GPF (*Universal Height*)
- 21 Aquia IV 1G - 1.28 GPF / 0.8 GPF (*Universal Height with SoftClose Seat*)
- 22 Aquia IV 1G - 1.0 GPF / 0.8 GPF (*Universal Height with SoftClose Seat*)
- 23 Aquia IV - 1.28 GPF / 0.8 GPF (*Universal Height with SoftClose Seat*)
- 24 Connolly® - 1.28 GPF / 0.9 GPF (*Slim D-Shape SoftClose Seat*)

WALL-HUNG TOILETS

- 26 SPTM Wall-Hung Toilet & In-Wall Tank System
- 27 SP Wall-Hung Toilet
- 28 RPTM Wall-Hung Toilet In-Wall Tank System
- 29 RP Wall-Hung Toilet

SEATS

- 30 SoftClose® Seat
- 30 Slim Elongated SoftClose Seat
- 30 Slim D-Shape SoftClose Seat
- 31 Slim Square SoftClose Seat
- 31 Slim D-Shape SoftClose Seat

FREESTANDING BATHTUB & TUB FILLERS

- 33 Flotation Tub with ZERO DIMENSION®
- 33 ZN Freestanding Tub Filler
- 33 ZL Freestanding Tub Filler
- 33 GR Freestanding Tub Filler

RESIDENTIAL FAUCETS & SHOWERS

- 35 ZN
- 35 ZL
- 36 GR
- 38 GS
- 40 LF
- 41 Shower Trims
- 45 Valves
- 47 G Series Showerheads
- 48 G Series Handshowers
- 49 L Series Showerheads
- 50 L Series Handshowers

COMMERCIAL FAUCETS

- 52 Axiom® EcoPower® Faucet
- 52 Gooseneck EcoPower Faucet
- 53 Gooseneck Wall-Mount EcoPower Faucet
- 53 Helix® EcoPower Faucet
- 54 Helix M EcoPower Faucet
- 54 Helix Wall-Mount EcoPower Faucet
- 55 Libella™ EcoPower Faucet
- 55 Libella M EcoPower Faucet
- 55 Libella Wall-Mount EcoPower Faucet
- 56 Libella Wall-Mount M EcoPower Faucet
- 56 Standard EcoPower Faucet

ICON GUIDE

TOILET & LAVATORY



1.0 GPF

Using only 1 gallon per flush, 1G toilets provide the most efficient flush in the industry.



DYNAMAX™ TORNADO FLUSH®

Uses 100% of water to clean and rinse the bowl using a smaller amount of water more efficiently with a 2.5" trapway and quieter flush. Available in 1.0/0.9 GPF or 1.28/0.8 GPF.



TORNADO FLUSH®

A state-of-the-art, hole-free rim design that offers dual-nozzle bowl cleansing, creating a centrifugal rinsing action that cleans the bowl more efficiently.



3D TORNADO FLUSH®

Three powerful nozzles create a powerful centrifugal rinsing action and combines it with the conservation of 0.9 or 1.28 GPF.



DUAL-MAX®

A dual flushing system that optimizes conservation by selecting the preferred flush volume.



E-MAX®

High performance, high-efficiency flushing technology using only 1.28 GPF with a 3" wide flush valve, large trapway, and extra-large siphon jet.



G-MAX®

A reliable flushing technology with 3" wide flush valve, large trapway, and extra-large siphon jet.



CEFIONTECT®

Ultra-smooth ceramic glaze leaves nowhere for waste to cling.



UNIVERSAL HEIGHT

Toilet height that allows for a more comfortable height position across a wide range of users.



SKIRTED DESIGN

The trapway is concealed by smooth porcelain, making the toilet easier to clean.



LINEARCERAM™

Material used for lavatories that achieves an extremely thin design yet two times as strong as standard fireclay.



LUMINIST®

An epoxy resin material that combines the translucence of glass with exceptional impact and heat resistance.

WASHLET



TOTO
WASHLET

An electronic bidet seat featuring adjustable warm water cleansing, heated seat, dryer, deodorizer and much more.

WASHLET® +

WASHLET and toilet set with a concealed connection that is specially designed for a seamless installation.



Actilight

Special glaze combined with ultraviolet light work together to break down waste in the toilet bowl.



EWATER+®

Mists the bowl with electrolyzed water, a proven disinfectant, keeping the wand and toilet bowl clean to reduce the need for harsh chemicals.



PREMIST

Using the incoming water supply, a Premist sprays the toilet bowl surface aiding in the elimination of waste approximately 80 percent better than a dry bowl.

FAUCET



COMFORT GLIDE™

Precise and easy flow control of water based on user's touch.



SOFT FLOW

Keeps splashing to a minimum for comfortable use and soft to the touch water.

SHOWER



SAFETY THERMO™

Shape Memory Alloy (SMA) thermostatic valve that prevents a sudden, unwanted increase in water temperature.



MINI UNIT

Unified exterior sizes for concealed shower valves creating a balanced bathroom space.



WARM SPA™

The feeling of a warm bath in a shower with water flow that envelopes and warms the body efficiently with no splash.



COMFORT WAVE™

A mix of large droplets and standard spray creates a shower with moderate intensity and just the right amount of stimulation.



ACTIVE WAVE™

Large droplets of water producing a more vigorous, high intensity shower.

TUB



ZERO DIMENSION®

A zero-gravity bathing experience, letting the body float in a completely tension-free state, creating absolute relaxation for the body and mind.

GENERAL FEATURES



AUTO FUNCTIONS

Product featuring an integrated, automatic, sensor activated function.



ADA

Product complies with Americans with Disabilities Act guidelines.



WATERSENSE

Product that meets EPA standards for water efficiency and performance criteria.



CEC

Product meets California Energy Commission requirements.

CALGreen

Product meets CalGreen Water Regulations for new construction and permitted remodel.

DESIGN AWARDS



reddot award
winner

The Red Dot is the award for high design quality. The international jury only awards this sought-after seal of quality to products that feature an outstanding design.



IF AWARD

The iF DESIGN AWARD has long become a symbol for excellent form, for aesthetic quality, and for user-focused, ergonomic and efficient design in all disciplines, by companies around the world.





























GOOD DESIGN

The Good Design Awards is the world's oldest and most important industrial design program organized annually by the Chicago Athenaeum Museum.

**YOUR IDEAL SHOWER SPACE
BEGINS RIGHT HERE.**



Showerheads and Handshowers



























*SHOWERHEADS SEE PAGES 47 & 49				HANDSHOWERS SEE PAGES 48 & 50				*SHOWER ACCESSORIES				
	1.75 GPM		2.5 GPM			1.75 GPM		2.0 GPM				
	SINGLE MODE	—	 TBW01003U4	 TBW01003U1			 TBW01009U4		—			
—		 TBW02003U4	 TBW02003U1		 TBW02010U4		—			SHOWER WALL MOUNT	 TS101S	
 TBW01012U4		—	—	—	—	 TBW01019U2		—		HANDSHOWER WALL-MOUNT	 TS101V	
MULTI MODE	—	 TBW01004U4	 TBW01004U1		 TBW02016U4		—			SLIDE BAR	 TS100GR	
	—	 TBW02004U4	 TBW02004U1		 TBW01011U4		—					
	 TBW03001U4	—	—	—	 TBW02015U4		—					
	 TBW01013U4	—	—	—	—	 TBW01020U2		—				
SHOWER ARMS	 TBW01012UV1	 TS110MW16			—		—		SHOWER HOSE	 TS101W60		
	—	 TS110MC6			—		 TBW03003U2					

* Shower arms and accessories sold separately

FAUCETS AND TRIMS

FOR THE SPACE YOU DREAM OF.

Faucets and Tub Fillers





















COLLECTIONS	LAVATORY FAUCET						BATHTUB FAUCET			
	SINGLE-HANDLE			SIDE HANDLE	WALL-MOUNT	WIDE-SPREAD	THREE-HOLE	FOUR-HOLE	TUB SPOUT	FREE-STANDING
	REGULAR	SEMI-VESSEL	VESSEL							
ZN	—	PAGE 35  AUTO TLP01701U & TLP01702U	—	—	—	—	—	—	—	PAGE 33  TBP01301U & TBN01105U
	PAGE 35			—	—	—	—	—	—	PAGE 33  TBP02303U & TBN01105U
ZL	 TLP02301U	 TLP02304U	 TLP02307U	—	—	—	—	—	—	PAGE 33  TBP02303U & TBN01105U
	PAGES 36-37									
GR	 TLG02301U	 TLG02304U	 TLG02307U	 TLG02309U	 TLG02311U	 TLG02201U	 TBG02201U & TBN01201U	 TBG02202U & TBN01202U	 TBG02001U	PAGE 33  TBP02306U & TBN01105U
	PAGE 38-39									
GS	 TLG03301U	 TLG03303U	 TLG03305U	—	 TLG03308U	 TLG03201U	 TBG03201U & TBN01201U	 TBG03202U & TBN01202U	 TBG01001U	—
	PAGE 40									
LF	 TLS04301U	—	 TLS04306U	—	—	—	—	—	—	—
	PAGE 40									

* Sold separately

■ Handshower sold separately









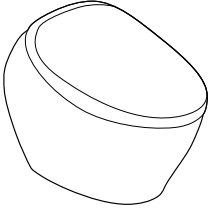
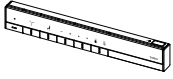

Trims and Valves

	THERMOSTATIC TRIM	THERMOSTATIC WITH VOLUME CONTROL TRIM	THERMOSTATIC WITH TWO-WAY WITH OFF TRIM	VOLUME CONTROL	TWO-WAY	THREE-WAY	THREE-WAY WITH OFF
	PAGES 37-40						
ROUND	 TBV01406U	 TBV01407U	 TBV01408U	 TBV01101U	 TBV01103U	 TBV01104U	 TBV01102U
SQUARE	 TBV02401U	 TBV02403U	 TBV02404U	 TBV02101U	 TBV02103U	 TBV02104U	 TBV02102U
PUSH BUTTON	—	 TBV02405U	 TBV02406U	—	—	—	—
	PAGE 45						
*REQUIRED VAVLE	 TBN01001U			 TBN01104U	 TBN01102U	 TBN01103U	 TBN01101U

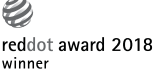

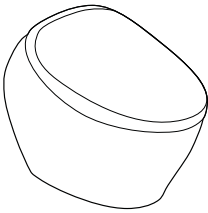
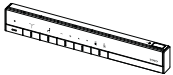

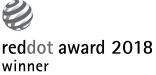

**NEOREST®
TOILETS**

NEOREST NX2, NEOREST AH & NEOREST RH; SEE PAGES 9-11

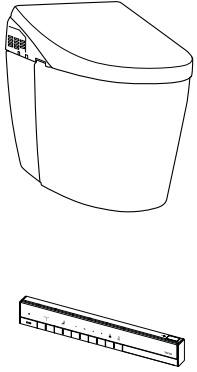
MS901CUMFX	PRODUCT NAME & DESCRIPTION	COLOR	PRODUCT NUMBER	PRICE	CUBES PALLET QTY.	APPROX. SHIP WT.
<p>ULTRA HIGH-EFFICIENCY</p>    	<p>NEOREST NX2 DUAL FLUSH TOILET 1.0 GPF / 0.8 GPF</p>  <p>CALGreen</p> <ul style="list-style-type: none"> • 31-1/2" L x 18-7/16" W x 23-5/8" H • TORNADO FLUSH® system • ACTILIGHT® UV light cleaning system built in lid • CEFIONTECT® ceramic glaze • ADA compliant • Universal Height • Sleek, low profile one-piece skirted toilet with integrated cleaning & comfort function in the seat • EWATER+® on wand and bowl • Remote control operated • Tornado flushing system can be operated by remote or by sensor operation • Front and rear warm water washing with temperature and intermittent pressure controls • Automatic toilet seat can be opened/closed by remote or by sensor operation • Heated seat with temperature control • Air deodorizer • Night light • Dryer function • 12" Rough-in • Mounting and connection hardware included • Remote control and hanger included • Water supply should be 7-1/2" to the left (facing the bowl) from the center line of closet flange 	COTTON	MS901CUMFX#01	\$12,800	14.4 / 2	158.7 lbs.
<p>ULTRA HIGH-EFFICIENCY</p>    	<p>NEOREST NX1 DUAL FLUSH TOILET 1.0 GPF / 0.8 GPF</p>  <p>CALGreen</p> <ul style="list-style-type: none"> • Same as NEOREST NX2 without ACTILIGHT. 	COTTON	MS900CUMFG#01	\$9,800	14.4 / 2	156.5 lbs.
<p>IMPORTANT NEOREST NX2 AND NX1 REQUIREMENTS: Electrical service requirements -120VAC, 15A, 60Hz protected by Class A GFCI.</p>						
<p>YS990</p> 	<p>AVAILABLE PARTS</p> <p>REMOTE CONTROL ASSEMBLY</p> <p>AVAILABLE ACCESSORIES</p> <p>NEOREST REMOTE CONTROL STAND</p> <ul style="list-style-type: none"> • Solid metal construction • Remote control stand compatible with remote control models THU6166, THU6209, THU9726, THU9798 and THU9869 • Holds 2 paper rolls • Remote control not included 	POLISHED CHROME	THU6166 YS990#CP	\$678 \$1,400	0.01 / - 2.97 / 16	0.6 lbs. 30.9 lbs.

NEOREST®
AH

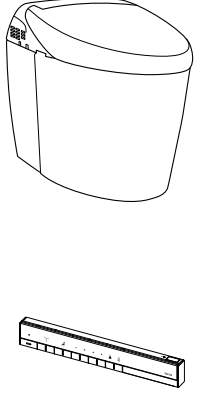
MS989CUMFG	PRODUCT NAME & DESCRIPTION	COLOR	PRODUCT NUMBER	PRICE	CUBES PALLET QTY.	APPROX. SHIP WT.
<p>ULTRA HIGH-EFFICIENCY</p>  <p>NEW</p>	<p>NEOREST AH DUAL FLUSH TOILET 1.0 GPF / 0.8 GPF  CALGreen</p> <ul style="list-style-type: none"> • 27-1/8"L x 15-3/16"W x 21-1/16"H • TORNADO FLUSH® system • CEFIONTECT® ceramic glaze • Sleek, low profile one-piece skirted toilet with integrated cleaning & comfort functions in the seat • EWATER+® on wand and bowl • Remote control operated • TORNADO FLUSH system can be operated by remote or by sensor operation • Universal Height • Front and rear warm water washing with temperature and intermittent pressure controls • Automatic toilet seat can be opened/closed by remote or by sensor operation • Heated seat with temperature control • Air deodorizer • Night light • Dryer function • 12" Rough-in • Mounting and connection hardware included • Remote control and hanger included • Water supply should be 4-1/2" to the left (facing the bowl) from the center line of closet flange for concealed connection, or 10-1/4" to 13-1/2" with extension kit 	COTTON SEDONA BEIGE	MS989CUMFG#01 MS989CUMFG#12	\$5,750 \$6,578	TBD	TBD
	AVAILABLE Q3 2018					
	<p>AVAILABLE COMPONENTS</p> <p>BOWL UNIT</p>	COTTON SEDONA BEIGE	CT989CUMFG#01 CT989CUMFG#12	\$2,200 \$2,530	TBD	TBD
	<p>TOP UNIT</p>	COTTON SEDONA BEIGE	SN989M#01 SN989M#12	\$3,550 \$4,048	TBD	TBD
<p>IMPORTANT NEOREST AH REQUIREMENTS: Electrical service requirements -120VAC, 15A, 60Hz protected by Class A GFCI.</p>						
<p>YS990</p> 	<p>AVAILABLE PARTS</p> <p>REMOTE CONTROL ASSEMBLY</p>		THU6209	\$662	0.01 / -	0.6 lbs.
	<p>AVAILABLE ACCESSORIES</p> <p>NEOREST REMOTE CONTROL STAND</p> <ul style="list-style-type: none"> • Solid metal construction • Remote control stand compatible with remote control models THU6166, THU6209, THU9726, THU9798 and THU9869 • Holds 2 paper rolls • Remote control not included 	POLISHED CHROME	YS990#CP	\$1,400	2.97 / 16	30.9 lbs.





MS988CUMFG	PRODUCT NAME & DESCRIPTION	COLOR	PRODUCT NUMBER	PRICE	CUBES PALLET QTY.	APPROX. SHIP WT.	
<p>ULTRA HIGH-EFFICIENCY</p>  <p>NEW</p>	<p>NEOREST RH DUAL FLUSH TOILET 1.0 GPF / 0.8 GPF</p>  <p>CALGreen</p> <ul style="list-style-type: none"> • 27-3/16" L x 15-3/16" W x 21-5/8" H • TORNADO FLUSH® system • CEFIONTECT® ceramic glaze • Sleek, low profile one-piece skirted toilet with integrated cleaning & comfort functions in the seat • EWATER+® on wand and bowl • Remote control operated • TORNADO FLUSH system can be operated by remote or by sensor operation • Universal Height • ADA Compliant • Front and rear warm water washing with temperature and intermittent pressure controls • Automatic toilet seat can be opened/closed by remote or by sensor operation • Heated seat with temperature control • Air deodorizer • Night light • Dryer function • 12" Rough-in • Mounting and connection hardware included • Remote control and hanger included • Water supply should be 4-1/2" to the left (facing the bowl) from the center line of closet flange for concealed connection, or 10-1/4" to 13-1/2" with extension kit 	COTTON SEDONA BEIGE	MS988CUMFG#01 MS988CUMFG#12	\$4,700 \$5,382	TBD	TBD	
	AVAILABLE Q3 2018						
	<p>AVAILABLE COMPONENTS</p> <p>BOWL UNIT</p>	COTTON SEDONA BEIGE	CT989CUMFG#01 CT989CUMFG#12	\$2,200 \$2,530	TBD	TBD	
	<p>TOP UNIT</p>	COTTON SEDONA BEIGE	SN988M#01 SN988M#12	\$2,500 \$2,852	TBD	TBD	
<p>IMPORTANT NEOREST RH REQUIREMENTS: Electrical service requirements -120VAC, 15A, 60Hz protected by Class A GFCI.</p>							
<p>YS990</p> 	<p>AVAILABLE PARTS</p> <p>REMOTE CONTROL ASSEMBLY</p>		THU6209	\$ 662	0.01 / -	0.6 lbs.	
	<p>AVAILABLE ACCESSORIES</p> <p>NEOREST REMOTE CONTROL STAND</p> <ul style="list-style-type: none"> • Solid metal construction • Remote control stand compatible with remote control models THU6166, THU6209, THU9726, THU9798 and THU9869 • Holds 2 paper rolls • Remote control not included 	POLISHED CHROME	YS990#CP	\$1,400	2.97 / 16	30.9 lbs.	

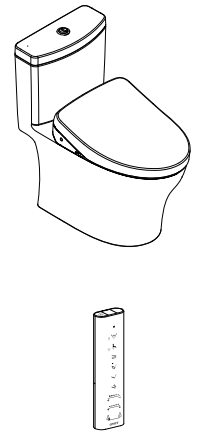

TOILETS

AQUIA® IV / WASHLET+ S550e ONE-PIECE TOILET

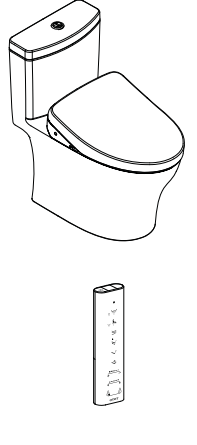









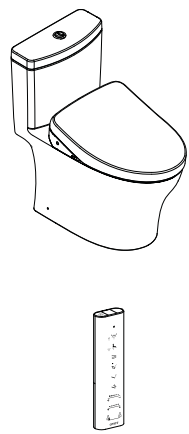

AQUIA® IV 1G® / WASHLET®+ ONE-PIECE TOILET & WASHLET

MW6463056CUMFG	PRODUCT NAME & DESCRIPTION	COLOR	PRODUCT NUMBER	PRICE	CUBES PALLET QTY.	APPROX. SHIP WT.	
ULTRA HIGH-EFFICIENCY  NEW	AQUIA IV 1G / WASHLET+ S550E ONE-PIECE TOILET - 1.0 GPF / 0.8 GPF  CALGreen <ul style="list-style-type: none"> • System includes toilet and WASHLET • 27-9/16" L x 15-1/4" W x 28-1/8" H • Concealed supply connection for seamless installation • DYNAMAX™ TORNADO FLUSH® system • CEFIONTECT® glaze prevents debris from sticking to ceramic surfaces, making them easier to clean • Universal height • One-piece decorative high profile toilet • Contemporary lid design • Elongated front WASHLET toilet seat with cover • Dual flush option • EWATER+® on wand and bowl • Premist of bowl before each use • Auto open/close lid • Remote control operated • Front and rear warm water washing with adjustable temperature and pressure controls • Heated seat with temperature control • Automatic air deodorizer • Night light • Warm air dryer • Illuminated touch pad • 2 user memory • SoftClose® Seat • Quick release feature • Mounting and connection hardware included 	COTTON	MW6463056CUMFG#01	TBD	TBD	TBD	
	AVAILABLE Q3 2018						
	AVAILABLE COMPONENTS ELONGATED FRONT BOWL ONLY <ul style="list-style-type: none"> • CEFIONTECT ceramic glaze • 12" Rough-in 	COTTON	CST646CUMFGT40#01	TBD	TBD	TBD	
	WASHLET+ S550E	COTTON	SW3056T40#01	\$1,650	1.69/28	16.3 lbs.	
	AVAILABLE PARTS 10" UNIFIT ROUGH-IN		TSU08W.10	\$95	0.48/-	2.2 lbs.	
	12" UNIFIT ROUGH-IN (STANDARD)		TSU08W.12	\$95	0.56/-	2.2 lbs.	
	14" UNIFIT ROUGH-IN		TSU08W.14	\$95	0.63/-	2.4 lbs.	
ULTRA HIGH-EFFICIENCY  NEW	AQUIA IV 1G / WASHLET+ S500E ONE-PIECE TOILET & WASHLET - 1.0 GPF / 0.8 GPF  CALGreen <ul style="list-style-type: none"> • System includes toilet and WASHLET • 27-9/16" L x 15-1/4" W x 28-1/8" H • Concealed supply connection for seamless installation • DYNAMAX TORNADO FLUSH system • CEFIONTECT glaze prevents debris from sticking to ceramic surfaces, making them easier to clean • Universal height • One-piece decorative high profile toilet • Contemporary lid design • Elongated front WASHLET toilet seat with cover • Dual flush option • EWATER+ on wand and bowl • Premist of bowl before each use • Remote control operated • Front and rear warm water washing with adjustable temperature and pressure controls • Heated seat with temperature control • Automatic air deodorizer • Warm air dryer • Illuminated touch pad • 2 user memory • SoftClose Seat • Quick release feature • Mounting and connection hardware included 	COTTON	MW6463046CUMFG#01	TBD	TBD	TBD	
	AVAILABLE Q3 2018						
	AVAILABLE COMPONENTS ELONGATED FRONT BOWL ONLY <ul style="list-style-type: none"> • CEFIONTECT ceramic glaze • 12" Rough-in 	COTTON	CST646CUMFGT40#01	TBD	TBD	TBD	
	WASHLET+ S500E	COTTON	SW3046T40#01	\$1,499	1.69/28	16.3 lbs.	
	AVAILABLE PARTS 10" UNIFIT ROUGH-IN		TSU08W.10	\$95	0.48/-	2.2 lbs.	
	12" UNIFIT ROUGH-IN (STANDARD)		TSU08W.12	\$95	0.56/-	2.2 lbs.	
	14" UNIFIT ROUGH-IN		TSU08W.14	\$95	0.63/-	2.4 lbs.	
IMPORTANT WASHLET+ AND WASHLET S550E/S500E REQUIREMENTS: WASHLET+ toilets will only fit WASHLET+. WASHLET S550e and S500e electrical service requirements -120VAC, 10A, 60Hz protected by Class A GFCI.							

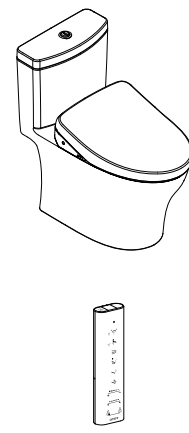
WASHLET+ ONE-PIECE TOILET



AQUIA® IV / WASHLET®+ ONE-PIECE TOILET & WASHLET

**WASHLET+
ONE-PIECE
TOILET**

MW6463056CEMFG	PRODUCT NAME & DESCRIPTION	COLOR	PRODUCT NUMBER	PRICE	CUBES PALLET QTY.	APPROX. SHIP WT.	
<p>ULTRA HIGH-EFFICIENCY</p>  <p>NEW</p>	<p>AQUIA IV / WASHLET+ S550E ONE-PIECE TOILET - 1.28 GPF / 0.8 GPF WASHLET+ +      CALGreen</p> <ul style="list-style-type: none"> • System includes toilet and WASHLET • 27-9/16" L x 15-1/4" W x 28-1/8" H • Concealed supply connection for seamless installation • DYNAMAX™ TORNADO FLUSH® system • CEFIONTECT® glaze prevents debris from sticking to ceramic surfaces, making them easier to clean • Universal height • One-piece decorative high profile toilet • Contemporary lid design • Elongated front WASHLET toilet seat with cover • Dual flush option • EWATER+® on wand and bowl • Premist of bowl before each use • Auto open/close lid • Remote control operated • Front and rear warm water washing with adjustable temperature and pressure controls • Heated seat with temperature control • Automatic air deodorizer • Night light • Warm air dryer • Illuminated touch pad • 2 user memory • SoftClose® Seat • Quick release feature • Mounting and connection hardware included 	COTTON	MW6463056CEMFG#01	TBD	TBD	TBD	
	AVAILABLE Q3 2018						
		<p>AVAILABLE COMPONENTS ELONGATED FRONT BOWL ONLY</p> <ul style="list-style-type: none"> • CEFIONTECT ceramic glaze • 12" Rough-in 	COTTON	CST646CEMFGT40#01	TBD	TBD	TBD
		<p>WASHLET+ S550E</p>	COTTON	SW3056T40#01	\$1,650	1.69/28	16.3 lbs.
		<p>AVAILABLE PARTS 10" UNIFIT ROUGH-IN</p>		TSU08W.10	\$95	0.48/-	2.2 lbs.
		<p>12" UNIFIT ROUGH-IN (STANDARD)</p>		TSU08W.12	\$95	0.56/-	2.2 lbs.
		<p>14" UNIFIT ROUGH-IN</p>		TSU08W.14	\$95	0.63/-	2.4 lbs.
<p>ULTRA HIGH-EFFICIENCY</p>  <p>NEW</p>	<p>AQUIA IV / WASHLET+ S500E ONE-PIECE TOILET & WASHLET - 1.28 GPF / 0.8 GPF WASHLET+ +      CALGreen</p> <ul style="list-style-type: none"> • System includes toilet and WASHLET • 27-9/16" L x 15-1/4" W x 28-1/8" H • Concealed supply connection for seamless installation • DYNAMAX TORNADO FLUSH system • CEFIONTECT glaze prevents debris from sticking to ceramic surfaces, making them easier to clean • Universal height • One-piece decorative high profile toilet • Contemporary lid design • Elongated front WASHLET toilet seat with cover • Dual flush option • EWATER+ on wand and bowl • Premist of bowl before each use • Remote control operated • Front and rear warm water washing with adjustable temperature and pressure controls • Heated seat with temperature control • Automatic air deodorizer • Warm air dryer • Illuminated touch pad • 2 user memory • SoftClose Seat • Quick release feature • Mounting and connection hardware included 	COTTON	MW6463046CEMFG#01	TBD	TBD	TBD	
	AVAILABLE Q3 2018						
		<p>AVAILABLE COMPONENTS ELONGATED FRONT BOWL ONLY</p> <ul style="list-style-type: none"> • CEFIONTECT ceramic glaze • 12" Rough-in 	COTTON	CST646CEMFGT40#01	TBD	TBD	TBD
		<p>WASHLET+ S500E</p>	COTTON	SW3046T40#01	\$1,499	1.69/28	16.3 lbs.
		<p>AVAILABLE PARTS 10" UNIFIT ROUGH-IN</p>		TSU08W.10	\$95	0.48/-	2.2 lbs.
		<p>12" UNIFIT ROUGH-IN (STANDARD)</p>		TSU08W.12	\$95	0.56/-	2.2 lbs.
		<p>14" UNIFIT ROUGH-IN</p>		TSU08W.14	\$95	0.63/-	2.4 lbs.
<p>IMPORTANT WASHLET+ AND WASHLET S550E/S500E REQUIREMENTS: WASHLET+ toilets will only fit WASHLET+. WASHLET S550e and S500e electrical service requirements -120VAC, 10A, 60Hz protected by Class A GFCI.</p>							

AQUIA® IV 1G® / WASHLET®+ TWO-PIECE TOILET & WASHLET



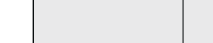







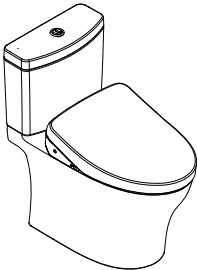

**WASHLET+
TWO-PIECE
TOILET**

MW4463056CUMFG	PRODUCT NAME & DESCRIPTION	COLOR	PRODUCT NUMBER	PRICE	CUBES PALLET QTY.	APPROX. SHIP WT.
<p>ULTRA HIGH-EFFICIENCY</p>  <p>Universal Height</p> <p>NEW</p>	<p>AQUIA IV 1G / WASHLET+ S550E TWO-PIECE TOILET - 1.0 GPF / 0.8 GPF</p> <p>WASHLET+ 1G </p> <p>CALGreen</p> <ul style="list-style-type: none"> System includes toilet and WASHLET 27-3/8"L x 15-9/16"W x 29-7/8"H Concealed supply connection for seamless installation DYNAMAX™ TORNADO FLUSH® system CEFIONTECT® glaze prevents debris from sticking to ceramic surfaces, making them easier to clean Universal height Decorative two-piece design with high-profile tank WASHLET toilet seat with cover Contemporary lid design Dual flush option EWATER+® on wand and bowl Auto open/close lid Premist of bowl before each use Remote control operated Front and rear warm water washing with adjustable temperature and pressure controls Heated seat with temperature control Automatic air deodorizer Night light Warm air dryer Illuminated touch pad 2 user memory SoftClose® Seat Quick release feature Mounting and connection hardware included 	COTTON	MW4463056CUMFG#01	\$2,316	8.70 / -	129 lbs.
	<p>AVAILABLE COMPONENTS ELONGATED FRONT BOWL ONLY</p> <ul style="list-style-type: none"> CEFIONTECT ceramic glaze 12" Rough-in 	COTTON	CT446CUFGT40#01	\$437	5.35 / 8	84 lbs.
	<p>TANK AND COVER ONLY</p> <ul style="list-style-type: none"> Complete with tank trim and coupling components 	COTTON	ST446UM#01	\$220	1.66 / 24	28.9 lbs.
	<p>WASHLET+ S550E</p>	COTTON	SW3056T40#01	\$1,650	1.69/28	16.3 lbs.
	<p>WASHLET ADAPTER</p> <ul style="list-style-type: none"> Necessary to install any WASHLET on Aquia IV 2pc and Connelly 2pc toilets 		9AU321-A	\$9		
	<p>AVAILABLE PARTS 10" UNIFIT ROUGH-IN</p>		TSU08W.10	\$95	0.48 / -	2.2 lbs.
	<p>12" UNIFIT ROUGH-IN (STANDARD)</p>		TSU08W.12	\$95	0.56 / -	2.2 lbs.
	<p>14" UNIFIT ROUGH-IN</p>		TSU08W.14	\$95	0.63 / -	2.4 lbs.
<p>ULTRA HIGH-EFFICIENCY</p>  <p>Universal Height</p> <p>NEW</p>	<p>AQUIA IV 1G / WASHLET+ S500E TWO-PIECE TOILET - 1.0 GPF / 0.8 GPF</p> <p>WASHLET+ 1G </p> <p>CALGreen</p> <ul style="list-style-type: none"> System includes toilet and WASHLET 27-3/8"L x 15-9/16"W x 29-7/8"H Concealed supply connection for seamless installation DYNAMAX TORNADO FLUSH system CEFIONTECT glaze prevents debris from sticking to ceramic surfaces, making them easier to clean Universal height Decorative two-piece design with high-profile tank WASHLET toilet seat with cover Contemporary lid design Dual flush option EWATER+ on wand and bowl Premist of bowl before each use Remote control operated Front and rear warm water washing with adjustable temperature and pressure controls Heated seat with temperature control Automatic air deodorizer Warm air dryer Illuminated touch pad 2 user memory SoftClose Seat Quick release feature Mounting and connection hardware included 	COTTON	MW4463046CUMFG#01	\$2,165	8.70 / -	129 lbs.
	<p>AVAILABLE COMPONENTS ELONGATED FRONT BOWL ONLY</p> <ul style="list-style-type: none"> CEFIONTECT ceramic glaze 12" Rough-in 	COTTON	CT446CUFGT40#01	\$437	5.35 / 8	84 lbs.
	<p>TANK AND COVER ONLY</p> <ul style="list-style-type: none"> Complete with tank trim and coupling components 	COTTON	ST446UM#01	\$220	1.66 / 24	28.9 lbs.
	<p>WASHLET+ S500E</p>	COTTON	SW3046T40#01	\$1,499	1.69/28	16.3 lbs.
	<p>WASHLET ADAPTER</p> <ul style="list-style-type: none"> Necessary to install any WASHLET on Aquia IV 2pc and Connelly 2pc toilets 		9AU321-A	\$9		
	<p>AVAILABLE PARTS 10" UNIFIT ROUGH-IN</p>		TSU08W.10	\$95	0.48 / -	2.2 lbs.
	<p>12" UNIFIT ROUGH-IN (STANDARD)</p>		TSU08W.12	\$95	0.56 / -	2.2 lbs.
	<p>14" UNIFIT ROUGH-IN</p>		TSU08W.14	\$95	0.63 / -	2.4 lbs.

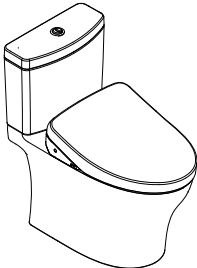









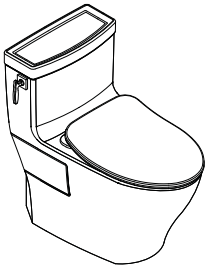





IMPORTANT WASHLET+ AND WASHLET S550E/S500E REQUIREMENTS:
WASHLET+ toilets will only fit WASHLET+.
WASHLET S550e and S500e electrical service requirements -120VAC, 10A, 60Hz protected by Class A GFCI.

AQUIA® IV / WASHLET®+ TWO-PIECE TOILET & WASHLET

**WASHLET+
TWO-PIECE
TOILET**

MW4463056CEMFG	PRODUCT NAME & DESCRIPTION	COLOR	PRODUCT NUMBER	PRICE	CUBES PALLET QTY.	APPROX. SHIP WT.
 <p>Universal Height</p> 	AQUA IV / WASHLET+ S550E TWO-PIECE TOILET - 1.28 GPF / 0.8 GPF WASHLET+      <ul style="list-style-type: none"> • System includes toilet and WASHLET • 27-3/8" L x 15-9/16" W x 29-7/8" H • Concealed supply connection for seamless installation • DYNAMAX™ TORNADO FLUSH® system • CEFIONTECT® glaze prevents debris from sticking to ceramic surfaces, making them easier to clean • Universal height • Decorative two-piece design with high-profile tank • WASHLET toilet seat with cover • Contemporary lid design • Dual flush option • EWATER+® on wand and bowl • Premist of bowl before each use • Auto open/close lid • Remote control operated • Front and rear warm water washing with adjustable temperature and pressure controls • Heated seat with temperature control • Automatic air deodorizer • Night light • Warm air dryer • Illuminated touch pad • 2 user memory • SoftClose® Seat • Quick release feature • Mounting and connection hardware included 	COTTON	MW4463056CEMFG#01	\$2,296	8.70 / -	129 lbs.
	AVAILABLE COMPONENTS ELONGATED FRONT BOWL ONLY <ul style="list-style-type: none"> • CEFIONTECT ceramic glaze • 12" Rough-in 	COTTON	CT446CUFGT40#01	\$437	5.35 / 8	84 lbs.
	TANK AND COVER ONLY <ul style="list-style-type: none"> • Complete with tank trim and coupling components 	COTTON	ST446EM#01	\$200	1.66 / 24	28.9 lbs.
	WASHLET+ S550E	COTTON	SW3056T40#01	\$1,650	1.69/28	16.3 lbs.
	WASHLET ADAPTER <ul style="list-style-type: none"> • Necessary to install any WASHLET on Aquia IV 2pc and Connelly 2pc toilets 		9AU321-A	\$9		
	AVAILABLE PARTS 10" UNIFIT ROUGH-IN		TSU08W.10	\$95	0.48 / -	2.2 lbs.
	12" UNIFIT ROUGH-IN (STANDARD)		TSU08W.12	\$95	0.56 / -	2.2 lbs.
	14" UNIFIT ROUGH-IN		TSU08W.14	\$95	0.63 / -	2.4 lbs.
 <p>Universal Height</p> 	AQUA IV / WASHLET+ S500E TWO-PIECE TOILET - 1.28 GPF / 0.8 GPF WASHLET+      <ul style="list-style-type: none"> • System includes toilet and WASHLET • 27-3/8" L x 15-9/16" W x 29-7/8" H • Concealed supply connection for seamless installation • DYNAMAX™ TORNADO FLUSH® system • CEFIONTECT® glaze prevents debris from sticking to ceramic surfaces, making them easier to clean • Universal height • Decorative two-piece design with high-profile tank • WASHLET toilet seat with cover • Contemporary lid design • Dual flush option • EWATER+® on wand and bowl • Premist of bowl before each use • Remote control operated • Front and rear warm water washing with adjustable temperature and pressure controls • Heated seat with temperature control • Automatic air deodorizer • Warm air dryer • Illuminated touch pad • 2 user memory • SoftClose Seat • Quick release feature • Mounting and connection hardware included 	COTTON	MW4463046CEMFG#01	\$2,145	8.70 / -	129 lbs.
	AVAILABLE COMPONENTS ELONGATED FRONT BOWL ONLY <ul style="list-style-type: none"> • CEFIONTECT ceramic glaze • 12" Rough-in 	COTTON	CT446CUFGT40#01	\$437	5.35 / 8	84 lbs.
	TANK AND COVER ONLY <ul style="list-style-type: none"> • Complete with tank trim and coupling components 	COTTON	ST446EM#01	\$200	1.66 / 24	28.9 lbs.
	WASHLET+ S500E	COTTON	SW3046T40#01	\$1,499	1.69/28	16.3 lbs.
	WASHLET ADAPTER <ul style="list-style-type: none"> • Necessary to install any WASHLET on Aquia IV 2pc and Connelly 2pc toilets 		9AU321-A	\$9		
	AVAILABLE PARTS 10" UNIFIT ROUGH-IN		TSU08W.10	\$95	0.48 / -	2.2 lbs.
	12" UNIFIT ROUGH-IN (STANDARD)		TSU08W.12	\$95	0.56 / -	2.2 lbs.
	14" UNIFIT ROUGH-IN		TSU08W.14	\$95	0.63 / -	2.4 lbs.

IMPORTANT WASHLET+ AND WASHLET S550E/S500E REQUIREMENTS:
WASHLET+ toilets will only fit WASHLET+ WASHLET.
WASHLET S550e and S500e electrical service requirements -120VAC, 10A, 60Hz protected by Class A GFCI.

MS626234CEFG	PRODUCT NAME & DESCRIPTION	COLOR	PRODUCT NUMBER	PRICE	CUBES PALLET QTY.	APPROX. SHIP WT.
<p>HIGH-EFFICIENCY</p>  <p><i>Slim SoftClose Seat included</i></p>	<p>NEW</p> <p>AIMES TOILET - 1.28 GPF      CALGreen</p> <ul style="list-style-type: none"> • 28-7/16" L x 17-5/16" W x 27-15/16" H • Specially designed to accommodate a WASHLET+ • TORNADO FLUSH® system • CEFIONTECT® ceramic glaze • Universal height • One-piece decorative high profile skirted toilet with tank • Elongated front bowl with Slim Urea SoftClose® seat • Chrome trip lever • 12" Unifit rough-in, less supply • Water supply should be approximately 8" to the left (facing the bowl) from the center line of the closet flange 	COTTON	MS626234CEFG#01	\$1,176	8.61 / 6	11.9.7 lbs.
	<p>AIMES TOILET - 1.28 GPF      CALGreen</p> <ul style="list-style-type: none"> • Same as MS626234CEFG except seat is SS124 SoftClose seat • ADA compliant 	COTTON COLONIAL WHITE BONE SEDONA BEIGE	MS626124CEFG#01 MS626124CEFG#11 MS626124CEFG#03 MS626124CEFG#12	\$1,046 \$1,046 \$1,200 \$1,200	8.61 / 6	11.9.7 lbs.
	<p>AIMES TOILET - 1.28 GPF      CALGreen</p> <ul style="list-style-type: none"> • Same as MS626124CEFG less CEFIONTECT 	EBONY	MS626124CEFG#51	\$1,566	8.61 / 6	11.9.7 lbs.
	<p>NEW</p> <p>AVAILABLE COMPONENTS</p> <p>Slim Elongated SoftClose Seat</p> <ul style="list-style-type: none"> • Toilet seat with SoftClose hinge system • Elongated closed front seat and cover made from urea resin • Quick release feature • Mounting hardware included 	COTTON	SS234#01	\$210	0.8 / 48	8.7 lbs.
	<p>Softclose Seat</p> <ul style="list-style-type: none"> • Toilet seat with SoftClose hinge system • Elongated closed front seat and cover • Mounting hardware included 	COTTON COLONIAL WHITE BONE SEDONA BEIGE EBONY	SS124#01 SS124#11 SS124#03 SS124#12 SS124#51	\$80 \$80 \$90 \$90 \$117	0.5 / 72	7 lbs.
	<p>AVAILABLE UPGRADES</p>					
	<p>WASHLET+ S550E - CONTEMPORARY</p>	COTTON	SW3056T40#01	\$1,650	1.69 / 28	16.3 lbs.
	<p>WASHLET+ S550E - CLASSIC</p>	COTTON	SW3054T40#01	\$1,650	1.69 / 28	16.3 lbs.
	<p>WASHLET+ S500E - CONTEMPORARY</p>	COTTON	SW3046T40#01	\$1,499	1.69 / 28	16.3 lbs.
	<p>WASHLET+ S500E - CLASSIC</p>	COTTON	SW3044T40#01	\$1,499	1.69 / 28	16.3 lbs.
	<p>AVAILABLE PARTS</p>					
	<p>10" UNIFIT ROUGH-IN</p>		TSU03W.10R	\$95	0.49 / -	2.4 lbs.
	<p>12" UNIFIT ROUGH-IN (STANDARD)</p>		TSU03W.12R	\$95	0.57 / -	2.2 lbs.
	<p>14" UNIFIT ROUGH-IN</p>		TSU03W.14R	\$95	0.63 / -	2.4 lbs.
	<p>TRIP LEVER</p>	POLISHED CHROME BRUSHED NICKEL POLISHED NICKEL	THU311N#CP THU311R#BN THU311R#PN	\$33 \$65 \$65	0.03 / -	0.3 lbs.
<p>UNIVERSAL FILL VALVE</p>		TSU99A.X	\$32	0.08 / -	0.6 lbs.	
<p>UNIVERSAL FLAPPER</p>		THU500S	\$15			

ONE-PIECE TOILETS

AQUIA® IV ONE-PIECE TOILET

ONE-PIECE
TOILETS

MS646124CUMFG

ULTRA HIGH-EFFICIENCY

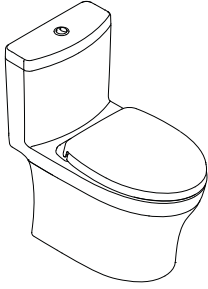





NEW

NEW

PRODUCT NAME & DESCRIPTION	COLOR	PRODUCT NUMBER	PRICE	CUBES PALLET QTY.	APPROX. SHIP WT.
AQUIA IV TOILET - 1.0 GPF / 0.8 GPF <ul style="list-style-type: none"> • 27-9/16"L x 15-1/4"H x 28-1/8"W • Specially designed to accommodate a WASHLET+ • DYNAMAX™ TORNADO FLUSH® system • CEFIONTECT® ceramic glaze prevents debris and mold from sticking to ceramic surfaces • 360° Fully Skirted design • Non-clog 2.5" trapway with clear glaze coating • Quiet flush • Auto flush function when WASHLET® is installed • Elongated front bowl and tank set with toilet seat • Dual flush option • Chrome push-button • 12" Rough-in • Universal Height 	COTTON COLONIAL WHITE BONE SEDONA BEIGE	MS646124CUMFG#01 MS646124CUMFG#11 ● MS646124CUMFG#03 ● MS646124CUMFG#12	TBD TBD TBD TBD	TBD	TBD
	AVAILABLE Q3 2018				
	AQUIA IV TOILET - 1.0 GPF / 0.8 GPF <ul style="list-style-type: none"> • Same as MS646124CUMFG less CeFIONtect 	EBONY	MS646124CUMF#51 ●	TBD	TBD
AQUIA IV TOILET - 1.0 GPF / 0.8 GPF <ul style="list-style-type: none"> • Same as MS646124CUMFG except seat is SS234 SoftClose seat 	COTTON	MS646234CUMFG#01 ●	TBD	TBD	TBD
AVAILABLE COMPONENTS SoftClose® Seat <ul style="list-style-type: none"> • Toilet seat with SoftClose hinge system • Elongated closed front seat and cover • Mounting hardware included 	COTTON COLONIAL WHITE BONE SEDONA BEIGE EBONY	SS124#01 SS124#11 SS124#03 SS124#12 SS124#51	\$ 80 \$ 80 \$ 90 \$ 90 \$ 117	0.53 / 72	7 lbs.
AVAILABLE UPGRADES WASHLET+ S550E - CONTEMPORARY	COTTON	SW3056T40#01	\$1,650	1.69 / 28	16.3 lbs.
WASHLET+ S550E - CLASSIC	COTTON	SW3054T40#01	\$1,650	1.69 / 28	16.3 lbs.
WASHLET+ S500E - CONTEMPORARY	COTTON	SW3046T40#01	\$1,499	1.69 / 28	16.3 lbs.
WASHLET+ S500E - CLASSIC	COTTON	SW3044T40#01	\$1,499	1.69 / 28	16.3 lbs.
Slim Elongated SoftClose Seat <ul style="list-style-type: none"> • Toilet seat with SoftClose hinge system • Elongated closed front seat and cover made from urea resin • Quick release feature • Mounting hardware included 	COTTON	SS234#01	\$ 210	0.8 / 48	8.7 lbs.
AVAILABLE PARTS PUSH BUTTON	POLISHED CHROME COTTON BRUSHED NICKEL POLISHED NICKEL	THU736#CP-A THU736#01-A THU736#BN-A THU736#PN-A	\$ 26 \$ 26 \$ 56 \$ 56		
UNIVERSAL FILL VALVE		TSU99A.X	\$ 32	0.08 / -	0.6 lbs.
FLUSH VALVE		THU740-A	\$ 25	0.02 / -	0.5 lbs.
10" UNIFIT ROUGH-IN		TSU08W.10	\$ 95	0.48 / -	2.2 lbs.
12" UNIFIT ROUGH-IN (STANDARD)		TSU08W.12	\$ 95	0.56 / -	2.2 lbs.
14" UNIFIT ROUGH-IN		TSU08W.14	\$ 95	0.63 / -	2.4 lbs.

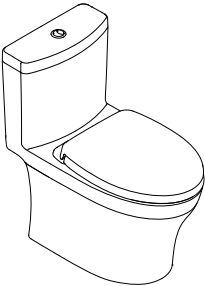
● **Made to order**
Contact Customer Service for lead time

AQUIA® IV ONE-PIECE TOILET

MS646124CEMFG	PRODUCT NAME & DESCRIPTION	COLOR	PRODUCT NUMBER	PRICE	CUBES PALLET QTY.	APPROX. SHIP WT.	
HIGH-EFFICIENCY  NEW	AQUIA IV TOILET - 1.28 GPF / 0.8 GPF  CALGreen <ul style="list-style-type: none"> • 27-9/16" L x 15-1/4" H x 28-1/8" W • Specially designed to accommodate a WASHLET+ DYNAMAX™ TORNADO FLUSH® system • CEFIONTECT® ceramic glaze prevents debris and mold from sticking to ceramic surfaces • 360° Fully Skirted design • Non-clog 2.5" trapway with clear glaze coating • Quiet flush • Auto flush function when WASHLET® is installed • Elongated front bowl and tank set with toilet seat • Dual flush option • Chrome push-button • 12" Rough-in • Universal Height 	COTTON COLONIAL WHITE BONE SEDONA BEIGE	MS646124CEMFG#01 MS646124CEMFG#11 ● MS646124CEMFG#03 ● MS646124CEMFG#12	TBD TBD TBD TBD	TBD TBD TBD TBD	TBD TBD TBD TBD	
	AVAILABLE Q3 2018						
		AQUIA IV TOILET - 1.28 GPF / 0.8 GPF  CALGreen <ul style="list-style-type: none"> • Same as MS646124CEMFG less CEFIONTECT 	EBONY	MS646124CEMFG#51 ●	TBD	TBD	TBD
		AQUIA IV TOILET - 1.28 GPF / 0.8 GPF  CALGreen <ul style="list-style-type: none"> • Same as MS646124CEMFG except seat is SS234 SoftClose seat 	COTTON	MS646234CEMFG#01 ●	TBD	TBD	TBD
		AVAILABLE COMPONENTS SoftClose® Seat <ul style="list-style-type: none"> • Toilet seat with SoftClose hinge system • Elongated closed front seat and cover • Mounting hardware included 	COTTON COLONIAL WHITE BONE SEDONA BEIGE EBONY	SS124#01 SS124#11 SS124#03 SS124#12 SS124#51	\$ 80 \$ 80 \$ 90 \$ 90 \$117	0.53 / 72	7 lbs.
		AVAILABLE UPGRADES WASHLET+ S550E - CONTEMPORARY	COTTON	SW3056T40#01	\$1,650	1.69 / 28	16.3 lbs.
		WASHLET+ S550E - CLASSIC	COTTON	SW3054T40#01	\$1,650	1.69 / 28	16.3 lbs.
		WASHLET+ S500E - CONTEMPORARY	COTTON	SW3046T40#01	\$1,499	1.69 / 28	16.3 lbs.
		WASHLET+ S500E - CLASSIC	COTTON	SW3044T40#01	\$1,499	1.69 / 28	16.3 lbs.
	NEW	Slim Elongated SoftClose Seat <ul style="list-style-type: none"> • Toilet seat with SoftClose hinge system • Elongated closed front seat and cover made from urea resin • Quick release feature • Mounting hardware included 	COTTON	SS234#01	\$210	0.8 / 48	8.7 lbs.
	AVAILABLE PARTS PUSH BUTTON	POLISHED CHROME COTTON BRUSHED NICKEL POLISHED NICKEL	THU736#CP-A THU736#01-A THU736#BN-A THU736#PN-A	\$26 \$26 \$56 \$56			
	UNIVERSAL FILL VALVE		TSU99A.X	\$32	0.08 / -	0.6 lbs.	
	FLUSH VALVE		THU740-A	\$25	0.02 / -	0.5 lbs.	
	10" UNIFIT ROUGH-IN		TSU08W.10	\$95	0.48 / -	2.2 lbs.	
	12" UNIFIT ROUGH-IN (STANDARD)		TSU08W.12	\$95	0.56 / -	2.2 lbs.	
	14" UNIFIT ROUGH-IN		TSU08W.14	\$95	0.63 / -	2.4 lbs.	

ONE-PIECE TOILETS

● **Made to order**
 Contact Customer Service for lead time

LEGATO®
ONE-PIECE TOILET

ONE-PIECE TOILETS

MS624234CEFG

HIGH-EFFICIENCY

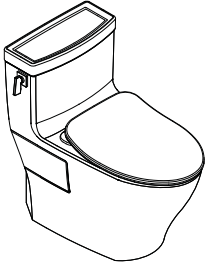

Slim SoftClose Seat included

NEW

NEW

PRODUCT NAME & DESCRIPTION	COLOR	PRODUCT NUMBER	PRICE	CUBES PALLET QTY.	APPROX. SHIP WT.
LEGATO TOILET - 1.28 GPF <ul style="list-style-type: none"> • 28-7/16" L x 17-5/16" W x 27-15/16" H • Specially designed to accommodate a WASHLET+ • TORNADO FLUSH® system • CEFIONTECT® ceramic glaze • Universal height • One-piece decorative high profile skirted toilet with tank • Elongated front bowl with Slim Urea SoftClose® seat • Chrome trip lever • 12" Unifit rough-in, less supply • Water supply should be approximately 8" to the left (facing the bowl) from the center line of the closet flange 	COTTON	MS624234CEFG#01	\$1,176	8.61 / 6	119.2 lbs.
LEGATO TOILET - 1.28 GPF <ul style="list-style-type: none"> • Same as MS624234CEFG except seat is SS124 SoftClose seat • ADA compliant 	COTTON COLONIAL WHITE BONE SEDONA BEIGE	MS624124CEFG#01 MS624124CEFG#11 ● MS624124CEFG#03 ● MS624124CEFG#12	\$1,046 \$1,046 \$1,200 \$1,200	8.61 / 6	119.2 lbs.
LEGATO TOILET - 1.28 GPF <ul style="list-style-type: none"> • Same as MS624124CEFG less CEFIONTECT 	EBONY	MS624124CEFG#51 ●	\$1,566	8.61 / 6	119.2 lbs.
AVAILABLE COMPONENTS					
Softclose Seat <ul style="list-style-type: none"> • Toilet seat with SoftClose hinge system • Elongated closed front seat and cover • Mounting hardware included 	COTTON COLONIAL WHITE BONE SEDONA BEIGE EBONY	SS124#01 SS124#11 SS124#03 SS124#12 SS124#51	\$80 \$80 \$90 \$90 \$117	0.5 / 72	7 lbs.
Slim SoftClose® SEAT <ul style="list-style-type: none"> • Toilet seat with SoftClose hinge system • Quick release feature • Elongated closed front seat and cover made from urea resin • Mounting hardware included 	COTTON	SS234#01	\$210	0.8 / 48	8.7 lbs.
AVAILABLE UPGRADES					
WASHLET+ S550E - CONTEMPORARY	COTTON	SW3056T40#01	\$1,650	1.69 / 28	16.3 lbs.
WASHLET+ S550E - CLASSIC	COTTON	SW3054T40#01	\$1,650	1.69 / 28	16.3 lbs.
WASHLET+ S500E - CONTEMPORARY	COTTON	SW3046T40#01	\$1,499	1.69 / 28	16.3 lbs.
WASHLET+ S500E - CLASSIC	COTTON	SW3044T40#01	\$1,499	1.69 / 28	16.3 lbs.
AVAILABLE PARTS					
10" UNIFIT ROUGH-IN		TSU03W.10R	\$95	0.49 / -	2.4 lbs.
12" UNIFIT ROUGH-IN (STANDARD)		TSU03W.12R	\$95	0.57 / -	2.2 lbs.
14" UNIFIT ROUGH-IN		TSU03W.14R	\$95	0.63 / -	2.4 lbs.
TRIP LEVER	POLISHED CHROME BRUSHED NICKEL POLISHED NICKEL	THU312N#CP THU312N#BN THU312N#PN	\$33 \$65 \$65	0.03 / -	0.5 lbs.
UNIVERSAL FILL VALVE		TSU99A.X	\$32	0.08 / -	0.6 lbs.
UNIVERSAL FLAPPER		THU500S	\$15		

● **Made to order**
Contact Customer Service for lead time

AQUIA® IV 1G®
TWO-PIECE TOILET

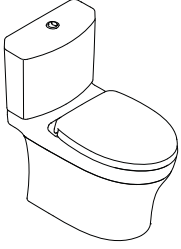
CST446CUMFG	PRODUCT NAME & DESCRIPTION	COLOR	PRODUCT NUMBER	PRICE	CUBES PALLET QTY.	APPROX. SHIP WT.
<p>ULTRA HIGH-EFFICIENCY</p>  <p>Universal Height</p>	<p>AQUIA IV 1G TOILET - 1.0 GPF/0.8 GPF</p> <p>1g CALGreen</p> <ul style="list-style-type: none"> • 27-3/8"L x 15-9/16"H x 29-7/8"W • DYNAMAX™ TORNADO FLUSH® system, high-efficiency • CEFIONTECT® ceramic glaze prevents debris and mold from sticking to ceramic surfaces • Universal Height • Completely skirted design • 2.5" glazed trapway • Quiet flush • Auto flush function when WASHLET® is installed • Elongated front bowl and tank set, less toilet seat • Dual flush option • Chrome push-button • 12" Rough-in 	COTTON	CST446CUMFG#01	\$657	7.01 / -	112.9 lbs.
	<p>AQUIA IV 1G TOILET - 1.28 GPF/0.8 GPF</p> <p> CALGreen</p> <ul style="list-style-type: none"> • Same as CST446CUMFG except 1.28 GPF/0.8 GPF 	COTTON	CST446CEMFG#01	\$637	7.01 / -	112.9 lbs.
	<p>AVAILABLE COMPONENTS ELONGATED FRONT BOWL ONLY</p> <ul style="list-style-type: none"> • CEFIONTECT ceramic glaze 	COTTON	CT446CUFG#01	\$437	5.35 / 8	84 lbs.
	<p>TANK AND COVER ONLY</p> <ul style="list-style-type: none"> • Complete with tank trim and coupling components 	COTTON	ST446UM#01	\$220	1.66 / 24	28.9 lbs.
	<p>TANK AND COVER ONLY</p> <ul style="list-style-type: none"> • Complete with tank trim and coupling components 	COTTON	ST446EM#01	\$200	1.66 / 24	28.9 lbs.
	<p>SoftClose® Seat</p> <ul style="list-style-type: none"> • Toilet seat with SoftClose hinge system • Elongated closed front seat and cover • Mounting hardware included 	COTTON	SS124#01	\$80	0.53 / 72	7 lbs.
	<p>Slim Elongated SoftClose Seat</p> <ul style="list-style-type: none"> • Toilet seat with SoftClose hinge system • Elongated closed front seat and cover made from urea resin • Quick release feature • Mounting hardware included 	COTTON	SS234#01	\$210	0.8 / 48	8.7 lbs.
	<p>AVAILABLE PARTS</p> <p>PUSH BUTTON</p>	<p>POLISHED CHROME COTTON BRUSHED NICKEL POLISHED NICKEL</p>	<p>THU735#CP-A THU735#01-A THU735#BN-A THU735#PN-A</p>	<p>\$26 \$26 \$56 \$56</p>		
	<p>FILL VALVE</p>		TSU83.07-A	\$32	0.08 / -	0.6 lbs.
	<p>FLUSH VALVE</p>		THU737-A	\$25	0.02 / -	0.5 lbs.
	<p>10" UNIFIT ROUGH-IN</p>		TSU08W.10	\$95	0.48 / -	2.2 lbs.
	<p>12" UNIFIT ROUGH-IN (STANDARD)</p>		TSU08W.12	\$95	0.56 / -	2.2 lbs.
	<p>14" UNIFIT ROUGH-IN</p>		TSU08W.14	\$95	0.63 / -	2.4 lbs.

TWO-PIECE TOILETS

AQUIA® IV 1G® TWO-PIECE TOILET

TWO-PIECE TOILETS

MS446124CUMFG

ULTRA HIGH-EFFICIENCY

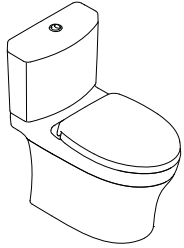

SoftClose seat included
Universal Height

NEW











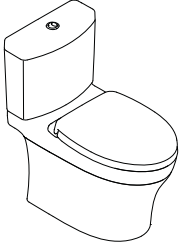









NEW

PRODUCT NAME & DESCRIPTION	COLOR	PRODUCT NUMBER	PRICE	CUBES PALLET QTY.	APPROX. SHIP WT.
AQUIA IV 1G TOILET - 1.0 GPF/ 0.8 GPF <ul style="list-style-type: none"> • 27-3/8"L x 15-9/16"H x 29-7/8"W • Specially designed to accommodate a WASHLET+ • DYNAMAX™ TORNADO FLUSH® system, high-efficiency • CEFIONTECT® ceramic glaze prevents debris and mold from sticking to ceramic surfaces • Universal Height • Completely skirted design • 2.5" glazed trapway • Quiet flush • Elongated front bowl and tank set, with SoftClose seat • Dual flush option • Chrome push-button • 12" Rough-in 	COTTON COLONIAL WHITE BONE SEDONA BEIGE	MS446124CUMFG#01 MS446124CUMFG#11 ● MS446124CUMFG#03 ● MS446124CUMFG#12	\$737 \$737 \$839 \$839	7.54 / -	119.9 lbs.
AQUIA IV 1G TOILET - 1.0 GPF/0.8 GPF <ul style="list-style-type: none"> • Same as MS446124CUMFG less CEFIONTECT 	EBONY	MS446124CUMFG#51 ●	\$1,103	7.54 / -	119.9 lbs.
AQUIA IV 1G TOILET - 1.0 GPF/0.8 GPF <ul style="list-style-type: none"> • Same as MS446124CUMFG except SS234 Slim Elongated SoftClose Seat 	COTTON	MS446234CUMFG#01 ●	\$867	7.81 / -	121.6 lbs.
AQUIA IV 1G TOILET - 1.0 GPF/0.8 GPF <ul style="list-style-type: none"> • Same as MS446234CUMFG without Universal Height 	COTTON	MS446234CUMFG#01 ●	\$829	7.81 / -	121.6 lbs.
AVAILABLE COMPONENTS ELONGATED FRONT BOWL ONLY <ul style="list-style-type: none"> • CEFIONTECT ceramic glaze 	COTTON COLONIAL WHITE BONE SEDONA BEIGE	CT446CUGFT40#01 CT446CUGFT40#11 ● CT446CUGFT40#03 ● CT446CUGFT40#12	\$437 \$437 \$503 \$503	5.35 / 8	84 lbs.
ELONGATED FRONT BOWL ONLY <ul style="list-style-type: none"> • Less CEFIONTECT 	EBONY	CT446CUFT40#51 ●	\$656	5.35 / 8	84 lbs.
TANK AND COVER ONLY <ul style="list-style-type: none"> • Complete with tank trim and coupling components 	COTTON COLONIAL WHITE BONE SEDONA BEIGE EBONY	ST446UM#01 ST446UM#11 ● ST446UM#03 ● ST446UM#12 ● ST446UM#51 ●	\$220 \$220 \$246 \$246 \$330	1.66 / 24	28.9 lbs.
SoftClose® Seat <ul style="list-style-type: none"> • Toilet seat with SoftClose hinge system • Elongated closed front seat and cover • Mounting hardware included 	COTTON COLONIAL WHITE BONE SEDONA BEIGE EBONY	SS124#01 SS124#11 SS124#03 SS124#12 SS124#51	\$80 \$80 \$90 \$90 \$117	0.53 / 72	7 lbs.
Slim Elongated SoftClose Seat <ul style="list-style-type: none"> • Toilet seat with SoftClose hinge system • Elongated closed front seat and cover made from urea resin • Quick release feature • Mounting hardware included 	COTTON	SS234#01	\$210	0.8 / 48	8.7 lbs.
AVAILABLE UPGRADES					
WASHLET+ S550E - CONTEMPORARY	COTTON	SW3056T40#01	\$1,650	1.69 / 28	16.3 lbs.
WASHLET+ S550E - CLASSIC	COTTON	SW3054T40#01	\$1,650	1.69 / 28	16.3 lbs.
WASHLET+ S500E - CONTEMPORARY	COTTON	SW3046T40#01	\$1,499	1.69 / 28	16.3 lbs.
WASHLET+ S500E - CLASSIC	COTTON	SW3044T40#01	\$1,499	1.69 / 28	16.3 lbs.
WASHLET ADAPTER <ul style="list-style-type: none"> • Necessary to install any WASHLET on Aquia IV 1pc, Aquia IV 2pc and Connelly 2pc toilets 		9AU321-A	\$9		
AVAILABLE PARTS					
PUSH BUTTON	POLISHED CHROME COTTON BRUSHED NICKEL POLISHED NICKEL	THU735#CP-A THU735#01-A THU735#BN-A THU735#PN-A	\$26 \$26 \$56 \$56		
FILL VALVE		TSU83.07-A	\$32	0.08 / -	0.6 lbs.
FLUSH VALVE		THU737-A	\$25	0.02 / -	0.5 lbs.
10" UNIFIT ROUGH-IN		TSU08W.10	\$95	0.48 / -	2.2 lbs.
12" UNIFIT ROUGH-IN (STANDARD)		TSU08W.12	\$95	0.56 / -	2.2 lbs.
14" UNIFIT ROUGH-IN		TSU08W.14	\$95	0.63 / -	2.4 lbs.

● **Made to order**
Contact Customer Service for lead time

AQUIA® IV TWO-PIECE TOILET

TWO-PIECE TOILETS

MS446124CEMFG	PRODUCT NAME & DESCRIPTION	COLOR	PRODUCT NUMBER	PRICE	CUBES PALLET QTY.	APPROX. SHIP WT.
 SoftClose seat included Universal Height	AQUIA IV TOILET - 1.28 GPF/0.8 GPF      CALGreen <ul style="list-style-type: none"> • 27-3/8"L x 15-9/16"H x 29-7/8"W • Specially designed to accommodate a WASHLET+ • DYNAMAX™ TORNADO FLUSH® system, high-efficiency (1.0 GPF/3.8 LPF & 0.8 GPF/3.0 LPF) • CEFIONTECT® ceramic glaze prevents debris and mold from sticking to ceramic surfaces • Completely skirted design • 2.5" glazed trapway • Quiet flush • Auto flush function when Washlet® is installed • Elongated front bowl and tank set, with SoftClose seat • Chrome push-button • 12" Rough-in • Universal Height 	COTTON COLONIAL WHITE BONE SEDONA BEIGE	MS446124CEMFG#01 MS446124CEMFG#11 ● MS446124CEMFG#03 ● MS446124CEMFG#12	\$717 \$717 \$823 \$823	7.54 / -	119.9 lbs.
	AQUIA IV TOILET - 1.28 GPF/0.8 GPF      CALGreen <ul style="list-style-type: none"> • Same as MS446124CEMFG less CEFIONTECT 	EBONY	MS446124CEM#51 ●	\$1,073	7.54 / -	119.9 lbs.
	AQUIA IV 1G TOILET - 1.28 GPF/0.8 GPF      CALGreen <ul style="list-style-type: none"> • Same as MS446124CEMFG except SS234 Slim Elongated SoftClose Seat 	COTTON	MS446234CEMFG#01 ●	\$847	7.81 / -	121.6 lbs.
	AQUIA IV 1G TOILET - 1.28 GPF/0.8 GPF     CALGreen <ul style="list-style-type: none"> • Same as MS446234CEMFG without Universal Height 	COTTON	MS446234CEM#01 ●	\$809	7.81 / -	121.6 lbs.
	AVAILABLE COMPONENTS ELONGATED FRONT BOWL ONLY <ul style="list-style-type: none"> • CEFIONTECT ceramic glaze 	COTTON COLONIAL WHITE BONE SEDONA BEIGE	CT446CUFGT40#01 CT446CUFGT40#11 ● CT446CUFGT40#03 ● CT446CUFGT40#12	\$437 \$437 \$503 \$503	5.35 / 8	84 lbs.
	ELONGATED FRONT BOWL ONLY <ul style="list-style-type: none"> • Less CEFIONTECT ceramic glaze 	EBONY	CT446CUFT40#51 ●	\$656		
	TANK AND COVER ONLY <ul style="list-style-type: none"> • Complete with tank trim and coupling components 	COTTON COLONIAL WHITE BONE SEDONA BEIGE EBONY	ST446EM#01 ST446EM#11 ● ST446EM#03 ● ST446EM#12 ST446EM#51 ●	\$200 \$200 \$230 \$230 \$300	1.66 / 24	28.9 lbs.
	SoftClose® Seat <ul style="list-style-type: none"> • Toilet seat with SoftClose hinge system • Elongated closed front seat and cover • Mounting hardware included 	COTTON COLONIAL WHITE BONE SEDONA BEIGE EBONY	SS124#01 SS124#11 SS124#03 SS124#12 SS124#51	\$80 \$80 \$90 \$90 \$117	0.53 / 72	7 lbs.
	Slim Elongated SoftClose Seat <ul style="list-style-type: none"> • Toilet seat with SoftClose hinge system • Elongated closed front seat and cover made from urea resin • Quick release feature • Mounting hardware included 	COTTON	SS234#01	\$210	0.8 / 48	8.7 lbs.
	AVAILABLE UPGRADES					
WASHLET+ S550E - CONTEMPORARY	COTTON	SW3056T40#01	\$1,650	1.69 / 28	16.3 lbs.	
WASHLET+ S550E - CLASSIC	COTTON	SW3054T40#01	\$1,650	1.69 / 28	16.3 lbs.	
WASHLET+ S500E - CONTEMPORARY	COTTON	SW3046T40#01	\$1,499	1.69 / 28	16.3 lbs.	
WASHLET+ S500E - CLASSIC	COTTON	SW3044T40#01	\$1,499	1.69 / 28	16.3 lbs.	
WASHLET ADAPTER <ul style="list-style-type: none"> • Necessary to install any WASHLET on Aquia IV 1pc, Aquia IV 2pc and Connelly 2pc toilets 		9AU321-A	\$9			
AVAILABLE PARTS						
PUSH BUTTON	POLISHED CHROME COTTON BRUSHED NICKEL POLISHED NICKEL	THU735#CP-A THU735#01-A THU735#BN-A THU735#PN-A	\$26 \$26 \$56 \$56			
FILL VALVE		TSU83.07-A	\$32	0.08 / -	0.6 lbs.	
FLUSH VALVE		THU737-A	\$25	0.02 / -	0.5 lbs.	
10" UNIFIT ROUGH-IN		TSU08W.10	\$95	0.48 / -	2.2 lbs.	
12" UNIFIT ROUGH-IN (STANDARD)		TSU08W.12	\$95	0.56 / -	2.2 lbs.	
14" UNIFIT ROUGH-IN		TSU08W.14	\$95	0.63 / -	2.4 lbs.	

● **Made to order**
Contact Customer Service for lead time

CONNELLY®
TWO-PIECE TOILET

TWO-PIECE TOILETS

MS494234CEMFG

ULTRA HIGH-EFFICIENCY

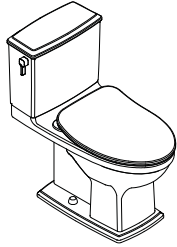

Slim SoftClose Seat included

NEW

NEW

MS494234CEMFG	PRODUCT NAME & DESCRIPTION	COLOR	PRODUCT NUMBER	PRICE	CUBES PALLET QTY.	APPROX. SHIP WT.	
<p>CONNELLY TWO-PIECE TOILET - 1.28 GPF / 0.9 GPF </p> <ul style="list-style-type: none"> • 28-3/4"L x 15-7/8"W x 30-1/4"H • Specially designed to accommodate a WASHLET+ • 3D Tornado™ flushing system, low consumption • Dual flush function • Elongated front bowl with Slim Urea SoftClose® seat • Universal Height • Close coupled bowl, tank set, and toilet seat • CEFIONTECT® ceramic glaze minimizes debris, mold and bacteria from sticking to porous, ceramic surfaces • Chrome trip-lever • 12" Rough-in 	COTTON	MS494234CEMFG#01	\$ 870	6.09 / -	105 lbs.		
	<p>CONNELLY TWO-PIECE TOILET - 1.28 GPF / 0.9 GPF </p> <ul style="list-style-type: none"> • Same as MS494234CEMFG except with RIGHT HAND TRIP LEVER 	COTTON	MS494234CEMFRG#01	\$ 870	6.09 / -	105 lbs.	
	<p>CONNELLY TWO-PIECE TOILET - 1.28 GPF / 0.9 GPF </p> <ul style="list-style-type: none"> • Same as MS494234CEMFG except seat is SS124 SoftClose seat • ADA compliant 	COTTON	MS494124CEMFG#01	\$ 740	6.09 / -	105 lbs.	
	<p>CONNELLY TWO-PIECE TOILET - 1.28 GPF / 0.9 GPF </p> <ul style="list-style-type: none"> • Same as MS494124CEMFG except with RIGHT HAND TRIP LEVER 	COTTON	MS494124CEMFRG#01	\$ 740	6.09 / -	105 lbs.	
	AVAILABLE COMPONENTS						
	<p>ELONGATED FRONT BOWL ONLY</p> <ul style="list-style-type: none"> • Regular Height • Flange outlet adapter • 12" Rough-in 	COTTON	CT494CEFGT40#01	\$ 406	4.83 / 12	75 lbs.	
	<p>TANK AND COVER ONLY</p> <ul style="list-style-type: none"> • Complete with tank trim and coupling components 	COTTON	ST494EM#01	\$ 254	1.26 / 24	30 lbs.	
	<p>RIGHT HAND TANK AND COVER ONLY</p> <ul style="list-style-type: none"> • Complete with tank trim and coupling components 	COTTON	ST494EMR#01	\$ 254	1.26 / 24	30 lbs.	
	<p>SoftClose® SEAT</p> <ul style="list-style-type: none"> • Toilet seat with SoftClose hinge system • Elongated closed front seat and cover • Mounting hardware included 	COTTON	SS124#01	\$ 80	0.53 / 72	7 lbs.	
	<p>Slim SoftClose® SEAT</p> <ul style="list-style-type: none"> • Toilet seat with SoftClose hinge system • Quick release feature • Elongated closed front seat and cover made from urea resin • Mounting hardware included 	COTTON	SS234#01	\$ 210	0.8 / 48	8.7 lbs.	
AVAILABLE UPGRADES							
<p>WASHLET+ S550E - CONTEMPORARY</p>	COTTON	SW3056T40#01	\$1,650	1.69 / 28	16.3 lbs.		
<p>WASHLET+ S550E - CLASSIC</p>	COTTON	SW3054T40#01	\$1,650	1.69 / 28	16.3 lbs.		
<p>WASHLET+ S500E - CONTEMPORARY</p>	COTTON	SW3046T40#01	\$1,499	1.69 / 28	16.3 lbs.		
<p>WASHLET+ S500E - CLASSIC</p>	COTTON	SW3044T40#01	\$1,499	1.69 / 28	16.3 lbs.		
<p>WASHLET ADAPTER</p> <ul style="list-style-type: none"> • Necessary to install any WASHLET on Aquia IV 1pc, Aquia IV 2pc and Connelly 2pc toilets 		9AU321-A	\$ 9				
AVAILABLE PARTS							
<p>TRIP LEVER</p>	COTTON POLISHED CHROME BRUSHED NICKEL POLISHED NICKEL	THU416#01 THU416#CP THU416#BN THU416#PN	\$ 33 \$ 33 \$ 65 \$ 65	0.03 / -	0.3 lbs.		
<p>UNIVERSAL FILL VALVE</p>		TSU99A.X	\$ 32	0.08 / -	0.6 lbs.		
<p>LEFT FLUSH VALVE</p>		THU418	\$ 33	0.02 / -	0.5 lbs.		
<p>RIGHT FLUSH VALVE</p>		THU423	\$ 33	0.02 / -	0.5 lbs.		











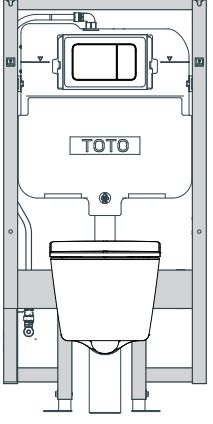









SP™ WALL-HUNG TOILET
BASIC SQUARE PUSH PLATE - DUAL BUTTON; SEE PAGE 27



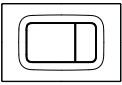

WALL-HUNG TOILETS

SP™
WALL-HUNG TOILET & IN-WALL TANK SYSTEM

WALL-HUNG TOILETS

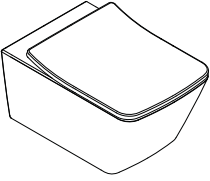
CWT449249CMFG	PRODUCT NAME & DESCRIPTION	COLOR	PRODUCT NUMBER	PRICE	CUBES PALLET QTY.	APPROX. SHIP WT.
 <p style="writing-mode: vertical-rl; transform: rotate(180deg);">NEW</p>	<p>SP™ WALL HUNG TOILET AND IN-WALL TANK SYSTEM - 1.28/0.9 GPF</p> <p>     CALGreen</p> <ul style="list-style-type: none"> • DYNAMAX™ TORNADO FLUSH® system, high-efficiency (1.28GPF/0.9GPF) • CEFIONTECT® ceramic glaze - prevents debris, mold from sticking to ceramic surfaces • Universal Height • Square front bowl • High-efficiency dual flush 1.28 & 0.9 GPF (4.8 & 3.4 LPF) Avg. flush 1.03 GPF • Adjustable 15"-19" mounting height • Saves up to 9" of floor space compared to standard floor-mounted toilet • Supports up to 880 lbs. • Commercial 2" x 6" or optional residential installation with 2" x 4" wall studs with waste outlet kit • Copper supply line • Includes push plate YT920#WH 	COTTON	CWT449249CMFG#WH	\$1,764	5.49 / -	115 lbs.
	<p>SP WALL HUNG TOILET AND IN-WALL TANK SYSTEM - 1.28/0.9 GPF</p> <p>     CALGreen</p> <ul style="list-style-type: none"> • Same as CWT449249CMFG#WH except YT920#MS push plate 	COTTON	CWT449249CMFG#MS	\$1,782	5.49 / -	115 lbs.
	<p>AVAILABLE COMPONENTS</p> <p>SP WALL-HUNG TOILET</p> <p>     CALGreen</p> <ul style="list-style-type: none"> • See page 27 for specifications & requirements 	COTTON	CT449CFG#01	\$720	0.23 / 63	76 lbs.
	<p>Slim Square SoftClose Seat</p> <ul style="list-style-type: none"> • Seat for use with SP wall-hung toilet bowl • Square shaped, closed front toilet seat and cover • SoftClose hinge system • Mounting hardware included • Seat and cover made from Urea resin • Push button release for easy seat removal and cleaning 	COTTON	SS249#01	\$290	0.8/ 60	8.8 lbs.
	<p>DUOFIT IN-WALL TANK SYSTEM - 1.28/0.9 GPF</p> <ul style="list-style-type: none"> • High-efficiency dual flush 1.28 & 0.9 GPF (4.8 & 3.4 LPF) Avg. flush 1.03 GPF • Adjustable 15"-19" mounting height • Saves up to 9" of floor space compared to standard floor-mounted toilet • Supports up to 880 lbs. • Commercial 2" x 6" or optional residential installation with 2" x 4" wall studs with waste outlet kit • Copper supply line 		WT172M	\$662	4.42 / 10	38 lbs.
	<p>BASIC SQUARE PUSH PLATE - DUAL BUTTON</p>	WHITE MATTE MATTE SILVER	YT920#WH YT920#MS	\$92 \$110	0.05 /	0.1 lbs.
	<p>AVAILABLE UPGRADES</p> <p>WALL SQUARE PUSH PLATE -DUAL BUTTON*</p> <ul style="list-style-type: none"> • A hidden mounting screw 	BRUSHED STAINLESS STEEL	YT980#SS	\$401	0.86 /	1.6 lbs.

*Available Q3 2018

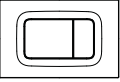
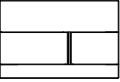









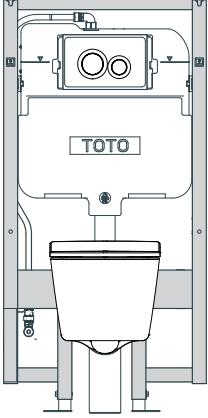



CT449CFG	PRODUCT NAME & DESCRIPTION	COLOR	PRODUCT NUMBER	PRICE	CUBES PALLET QTY.	APPROX. SHIP WT.
<p>ULTRA HIGH-EFFICIENCY</p>  <p>SS249 Slim Square SoftClose Seat Sold separately</p>	<p>NEW</p> <p>SP™ WALL-HUNG TOILET     CALGreen</p> <ul style="list-style-type: none"> • DYNAMAX™ TORNADO FLUSH® system • CEFIONTECT® ceramic glaze prevents debris and mold from sticking to ceramic surfaces • Universal Height • SS249 seat required • For use with WT172M In-wall tank system • Wall-Hung Full Skirted • Rimless design - no bonding line • Unique installation (Guide tubes to locate mounting screws from underneath) • Square shape bowl less toilet seat 	COTTON	CT449CFG#01	\$720	0.23 / 63	76 lbs.
	<p>AVAILABLE COMPONENTS</p> <p>Slim Square SoftClose Seat</p> <ul style="list-style-type: none"> • Seat for use with SP wall-hung toilet bowl • Square shaped, closed front toilet seat and cover • SoftClose hinge system • Mounting hardware included • Seat and cover made from Urea resin • Push button release for easy seat removal and cleaning 	COTTON	SS249#01	\$290	0.8 / 60	8.8 lbs.
	<p>DUOFIT IN-WALL TANK SYSTEM - 1.28/0.9 GPF</p> <ul style="list-style-type: none"> • High-efficiency dual flush 1.28 & 0.9 GPF (4.8 & 3.4 LPF) Avg. flush 1.03 GPF • Adjustable 15"-19" mounting height • Saves up to 9" of floor space compared to standard floor-mounted toilet • Supports up to 880 lbs. • Commercial 2" x 6" or optional residential installation with 2" x 4" wall studs with waste outlet kit • Copper supply line 		WT172M	\$662	4.42 / 10	38 lbs.
	<p>AVAILABLE UPGRADES</p> <p>BASIC SQUARE PUSH PLATE - DUAL BUTTON</p>	WHITE MATTE MATTE SILVER	YT920#WH YT920#MS	\$92 \$110	0.05 /	0.1 lbs.
	<p>WALL SQUARE PUSH PLATE -DUAL BUTTON*</p>	BRUSHED STAINLESS STEEL	YT980#SS	\$401	0.86 /	1.6 lbs.



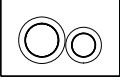

WALL-HUNG TOILETS

*Available Q3 2018

RP™
WALL-HUNG TOILET & IN-WALL TANK SYSTEM

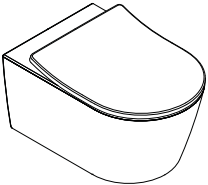
WALL-HUNG TOILETS

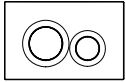
CWT447247CMFG	PRODUCT NAME & DESCRIPTION	COLOR	PRODUCT NUMBER	PRICE	CUBES PALLET QTY.	APPROX. SHIP WT.
 <p style="text-align: center;">TOTO</p>	<p>RP™ WALL-HUNG TOILET & IN-WALL TANK SYSTEM - 1.28/0.9 GPF</p> <p>    CALGreen</p> <ul style="list-style-type: none"> • DYNAMAX™ TORNADO FLUSH® system, high-efficiency (1.28GPF/0.9GPF) • CEFIONTECT® ceramic glaze - prevents debris, mold from sticking to ceramic surfaces • Universal Height • D-shape front bowl • High-efficiency dual flush 1.28 & 0.9 GPF (4.8 & 3.4 LPF) Avg. flush 1.03 GPF • Adjustable 15"-19" mounting height • Saves up to 9" of floor space compared to standard floor-mounted toilet • Supports up to 880 lbs. • Commercial 2" x 6" or optional residential installation with 2" x 4" wall studs with waste outlet kit • Copper supply line • Includes push plate YT930#WH 	COTTON	CWT447247CMFG#WH	\$1,694	5.49 / -	115 lbs.
	<p>RP WALL-HUNG TOILET & IN-WALL TANK SYSTEM - 1.28/0.9 GPF</p> <p>    CALGreen</p> <ul style="list-style-type: none"> • Same as CWT447247CMFG#WH except YT930#MS push plate 	COTTON	CWT447247CMFG#MS	\$1,712	5.49 / -	115 lbs.
	<p>AVAILABLE COMPONENTS</p> <p>RP WALL-HUNG TOILET</p> <p>    CALGreen</p> <ul style="list-style-type: none"> • See page 29 for specifications & requirements 	COTTON	CT447CFG#01	\$ 650	0.23 / 63	76 lbs.
	<p>Slim D-Shape SoftClose Seat</p> <ul style="list-style-type: none"> • Seat for use with RP wall-hung toilet bowl • D-shaped, closed front toilet seat and cover • SoftClose hinge system • Mounting hardware included • Seat and cover made from Urea resin • Push button release for easy seat removal and cleaning 	COTTON	SS247#01	\$290	0.8 / 60	8.8 lbs.
	<p>DUOFIT IN-WALL TANK SYSTEM - 1.28/0.9 GPF</p> <ul style="list-style-type: none"> • High-efficiency dual flush 1.28 & 0.9 GPF (4.8 & 3.4 LPF) Avg. flush 1.03 GPF • Adjustable 15"-19" mounting height • Saves up to 9" of floor space compared to standard floor-mounted toilet • Supports up to 880 lbs. • Commercial 2" x 6" or optional residential installation with 2" x 4" wall studs with waste outlet kit • Copper supply line 		WT172M	\$ 662	4.42 / 10	38 lbs.
	<p>BASIC ROUND PUSH PLATE - DUAL BUTTON</p>	WHITE MATTE MATTE SILVER	YT930#WH YT930#MS	\$ 92 \$ 110	0.05 /	0.1 lbs.
	<p>AVAILABLE UPGRADES</p> <p>WALL ROUND PUSH PLATE - DUAL BUTTON*</p>	BRUSHED STAINLESS STEEL	YT970#SS	\$ 401	0.05 /	0.1 lbs.
<p>*Available Q3 2018</p>						



CT447CFG	PRODUCT NAME & DESCRIPTION	COLOR	PRODUCT NUMBER	PRICE	CUBES PALLET QTY.	APPROX. SHIP WT.
<p>ULTRA HIGH-EFFICIENCY</p>  <p><i>SS247 Slim D-Shape SoftClose Seat Sold separately</i></p>	<p>NEW</p> <p>RP™ WALL-HUNG TOILET</p>  <ul style="list-style-type: none"> • DYNAMAX™ TORNADO FLUSH® system • CEFIONTECT® ceramic glaze prevents debris and mold from sticking to ceramic surfaces • Universal Height • SS247 seat required • For use with WT172M In-wall tank system • Wall-Hung Full Skirted • Rimless design - no bonding line • Unique installation (Guide tubes to locate mounting screws from underneath) • D-shape shape bowl less toilet seat 	COTTON	CT447CFG#01	\$ 650	0.23 / 63	76 lbs.
	<p>AVAILABLE COMPONENTS</p> <p>Slim D-Shape SoftClose Seat</p> <ul style="list-style-type: none"> • Seat for use with RP wall-hung toilet bowl • D-shaped, closed front toilet seat and cover • SoftClose hinge system • Mounting hardware included • Seat and cover made from Urea resin • Push button release for easy seat removal and cleaning 	COTTON	SS247#01	\$ 290	0.8 / 60	8.8 lbs.
	<p>DUOFIT IN-WALL TANK SYSTEM - 1.28/0.9 GPF</p> <ul style="list-style-type: none"> • High-efficiency dual flush 1.28 & 0.9 GPF (4.8 & 3.4 LPF) Avg. flush 1.03 GPF • Adjustable 15"-19" mounting height • Saves up to 9" of floor space compared to standard floor-mounted toilet • Supports up to 880 lbs. • Commercial 2" x 6" or optional residential installation with 2" x 4" wall studs with waste outlet kit • Copper supply line 		WT172M	\$ 662	4.42 / 10	38 lbs.
	<p>AVAILABLE UPGRADES</p> <p>BASIC ROUND PUSH PLATE - DUAL BUTTON</p>	WHITE MATTE MATTE SILVER	YT930#WH YT930#MS	\$ 92 \$ 110	0.05 /	0.1 lbs.
	<p>WALL ROUND PUSH PLATE - DUAL BUTTON*</p>	BRUSHED STAINLESS STEEL	YT970#SS	\$ 401	0.05 /	0.1 lbs.
<p>*Available Q3 2018</p>						

WALL-HUNG TOILETS

SoftClose®
SEATS

SOFT CLOSE SEATS

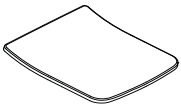
	PRODUCT NAME & DESCRIPTION	COLOR	PRODUCT NUMBER	PRICE	CUBES PALLET QTY.	APPROX. SHIP WT.
SS124	<p>SoftClose® Seat</p> <ul style="list-style-type: none"> • Elongated closed front toilet seat and cover with SoftClose® hinge system • Mounting hardware included 	COTTON COLONIAL WHITE BONE SEDONA BEIGE EBONY	SS124#01 SS124#11* SS124#03* SS124#12 SS124#51*	\$80 \$80 \$90 \$90 \$117	0.5 / 72	7 lbs.
SS234	<p>Slim Elongated SoftClose Seat</p> <ul style="list-style-type: none"> • Elongated SoftClose seat • Mounting hardware included • Seat and cover made from urea-resin • Removal for cleaning 	COTTON	SS234#01	\$210	0.8 / 48	8.7 lbs
SS237	<p>Slim D-Shape SoftClose Seat</p> <ul style="list-style-type: none"> • D-shape closed front toilet seat and cover with SoftClose seat hinge system • Mounting hardware included • Seat and cover made from urea-resin • Push button release for easy seat removal and cleaning • Seat for use with MH wall-hung toilet bowl 	COTTON	SS237#01	\$250	0.85 / 40	9.5 lbs.
<p>*Available Q3 2018</p>						

	PRODUCT NAME & DESCRIPTION	COLOR	PRODUCT NUMBER	PRICE	CUBES PALLET QTY.	APPROX. SHIP WT.
SS249	<p>Slim Square SoftClose Seat</p> <ul style="list-style-type: none"> • Seat for use with SP™ wall-hung toilet bowl • Square shaped, closed front toilet seat and cover • SoftClose hinge system • Mounting hardware included • Seat and cover made from Urea resin • Push button release for easy seat removal and cleaning 	COTTON	SS249#01	\$290	0.8 / 60	8.5 lbs.
						
SS247	<p>Slim D-Shape SoftClose Seat</p> <ul style="list-style-type: none"> • Seat for use with RP™ wall-hung toilet bowl • D-shaped, closed front toilet seat and cover • SoftClose hinge system • Mounting hardware included • Seat and cover made from Urea resin • Push button release for easy seat removal and cleaning 	COTTON	SS247#01	\$290	0.8 / 60	8.5 lbs.
						

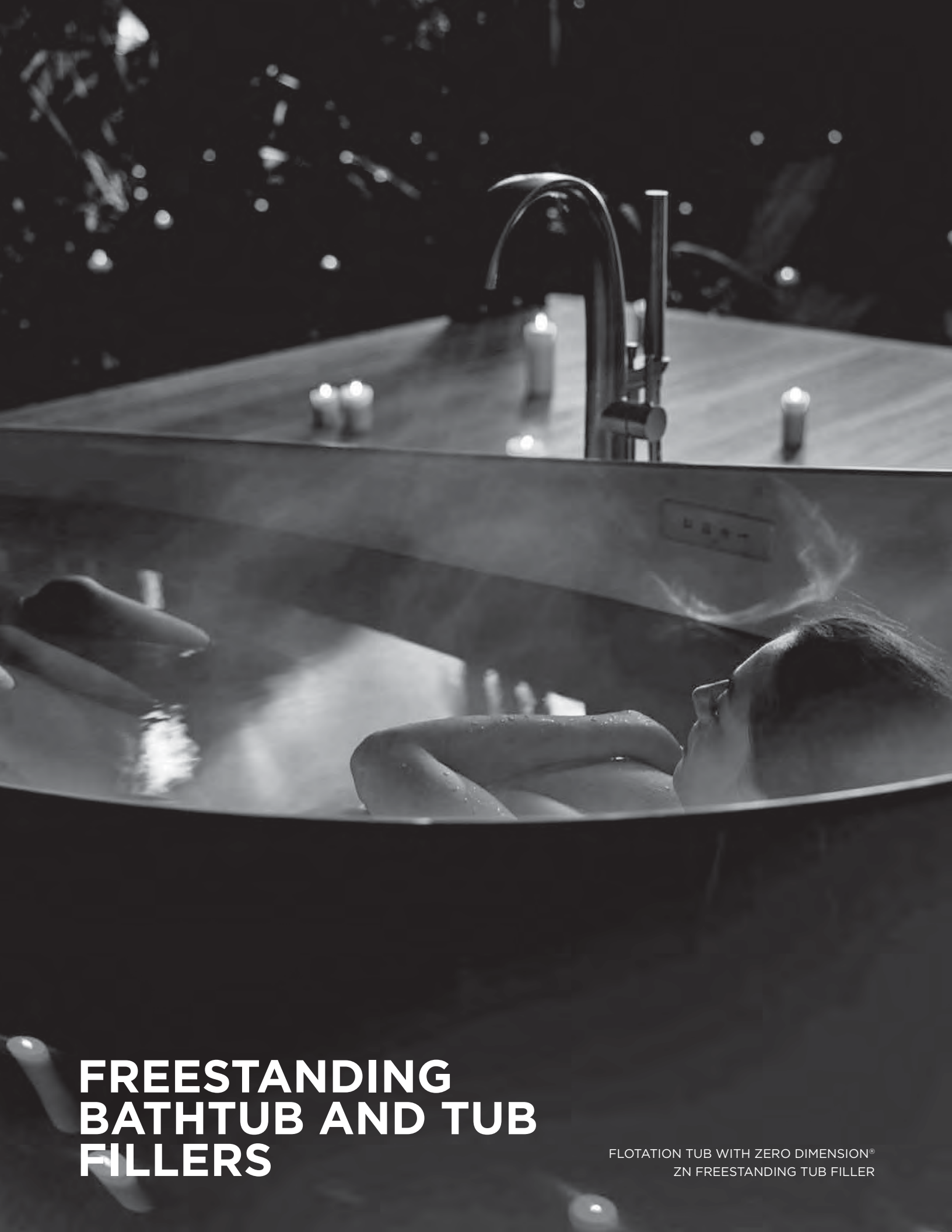

SOFTCLOSE SEATS



FREESTANDING BATHTUB AND TUB FILLERS

FLOTATION TUB WITH ZERO DIMENSION®
ZN FREESTANDING TUB FILLER

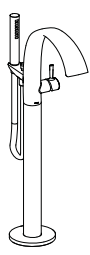
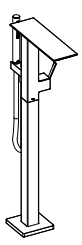
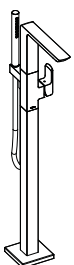
FREESTANDING BATHTUB AND TUB FILLERS







	PRODUCT NAME & DESCRIPTION	COLOR	FINISH	PRODUCT NUMBER	PRICE	CUBES PALLET QTY.	APPROX. SHIP WT.
PJYD2200PWEU	 <p>FLOTATION TUB WITH ZERO DIMENSION®</p> <ul style="list-style-type: none"> • 86-5/8"L x 41-5/16"W x 30-11/16"H • Constructed with solid surface Galaline™ engineered to resist stain, retain heat, and minimize maintenance. • Shaped to simulate a "gravity-less" floating position for ultimate relaxation • Hydrohands® massaging water jets • Slip-resistant surface • Adjustable headrest with cascading shoulder warmer • Mood creating LED Lighting • Capacitive Keypad • Toe touch drain and push-button design for a smooth, one-piece tub appearance • 0.5 hp blower • 77.5 gallon capacity 	GLOSS WHITE	POLISHED CHROME	PJYD2200PWEU#GW	\$18,799	95.72 / 1	686 lbs.
TBP01301U	 <p>ZN FREESTANDING TUB FILLER</p> <ul style="list-style-type: none"> • Lever handles • Brass construction • Smooth handle control Comfort Glide™ technology • Requires Freestanding tub filler base rough-in (TBN01105U) • 1.75 gpm (6.6 lpm) Handshower with 60" metal hose included 		POLISHED CHROME BRUSHED NICKEL	TBP01301U#CP TBP01301U#BN	\$4,890 \$6,846	4.6	27.0 lbs.
TBP02303U	 <p>ZL FREESTANDING TUB FILLER</p> <ul style="list-style-type: none"> • Lever handle TOTO's Thinnest Stainless Steel Freestanding tub filler • Lever handle • Hand-welded, individually polished artisan spouts • Modern minimalist design accent the bathroom • Reflective mirror-like polished chrome finish • Smooth handle control Comfort Glide™ technology • Requires Freestanding tub filler base rough-in (TBN01105U) • 1.75 gpm (6.6 lpm) Handshower with 60" metal hose included 		POLISHED CHROME	TBP02303U#CP	\$5,190	4.6	34 lbs.
TBG02306U	 <p>GR FREESTANDING TUB FILLER</p> <ul style="list-style-type: none"> • Lever handle • Brass construction • Smooth handle control Comfort Glide™ technology • Requires Freestanding tub filler base rough-in (TBN01105U) • 1.75 gpm (6.6 lpm) Handshower with 60" metal hose included 		POLISHED CHROME BRUSHED NICKEL	TBG02306U#CP TBG02306U#BN	\$2,011 \$3,011	4.44	32.6 lbs.
	<p>REQUIRED ROUGH-IN FLOOR MOUNT BATHTUB FILLER BASE</p>			TBN01105U	\$489	0.66	10.35 lbs.

FREESTANDING TUBS

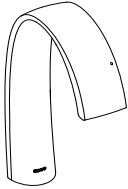
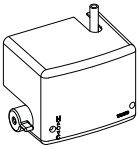
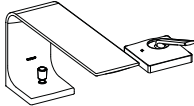

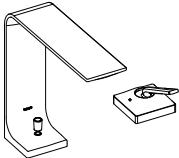

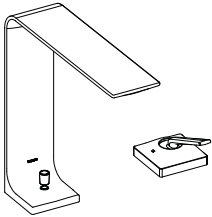





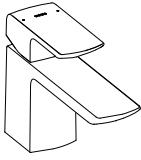

FAUCETS & TRIMS

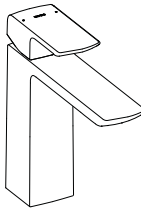
ZN LAVATORY FAUCET

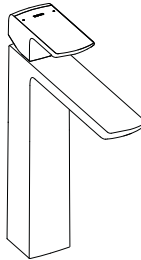

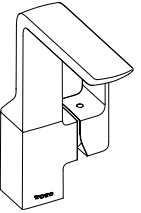

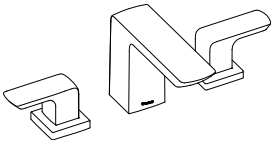
	PRODUCT NAME & DESCRIPTION	FINISH	PRODUCT NUMBER	PRICE	CUBES PALLET QTY.	APPROX. SHIP WT.
TLP01701U	<p>ZN LAVAOTRY FAUCET</p>  <p>NEW</p> <ul style="list-style-type: none"> • Cost saving WaterSense certified 1.1 gpm faucet • Touchless automatic sensor faucet • Soft Flow™ prevents splashing • Safety Thermo™ thermostatic mixing valve for scald prevention • Meets California water efficiency CEC leakage regulations • Temperature indicating LED light • Requires TLP01702U Controller (sold separately) • Does not include drain assembly 	POLISHED CHROME BRUSHED NICKEL	TLP01701U#CP TLP01701U#BN	\$1,539 \$2,155	0.31	5.05 lbs
TLP01702U	<p>REQUIRED CONTROLLER</p> <p>THERMO CONTROLLER FOR ELECTRONIC FAUCET</p>  <p>NEW</p>		TLP01702U	\$950	0.38	7.4 lbs
TLP02301U	<p>ZL SINGLE-HANDLE FAUCET</p>  <p>NEW</p>  <ul style="list-style-type: none"> • WaterSense certified low-flow 1.2 gpm (4.5 lpm) faucet • TOTO's thinnest stainless steel faucet • Smooth handle control with Comfort Glide™ technology • Meets California water efficiency CEC leakage regulations • Diamond-Like Carbon (DLC) coated ceramic cartridge for ultimate durability • Minimalist design accents the modern bathroom • Expertly hand-polished, mirror-like chrome finish • Does not include drain assembly 	POLISHED CHROME	TLP02301U#CP	\$1,799	0.4	6.2lbs
TLP02304U	<p>ZL SINGLE-HANDLE FAUCET - SEMI-VESSEL</p>  <p>NEW</p>  <ul style="list-style-type: none"> • WaterSense certified low-flow 1.2 gpm (4.5 lpm) faucet • TOTO's thinnest stainless steel faucet • Smooth handle control with Comfort Glide technology • Meets California water efficiency CEC leakage regulations • Diamond-Like Carbon (DLC) coated ceramic cartridge for ultimate durability • Minimalist design accents the modern bathroom • Expertly hand-polished, mirror-like chrome finish • Does not include drain assembly 	POLISHED CHROME	TLP02304U#CP	\$1,899	0.4	6.1 lbs
TLP02307U	<p>ZL SINGLE-HANDLE FAUCET - VESSEL</p>  <p>NEW</p>  <ul style="list-style-type: none"> • WaterSense certified low-flow 1.2 gpm (4.5 lpm) faucet • TOTO's thinnest stainless steel faucet • Smooth handle control with Comfort Glide technology • Meets California water efficiency CEC leakage regulations • Diamond-Like Carbon (DLC) coated ceramic cartridge for ultimate durability • Minimalist design accents the modern bathroom • Expertly hand-polished, mirror-like chrome finish • Does not include drain assembly 	POLISHED CHROME	TLP02307U#CP	\$1,999	0.4	6.55 lbs

FAUCETS

GR FAUCETS

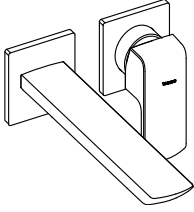

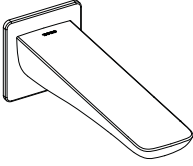
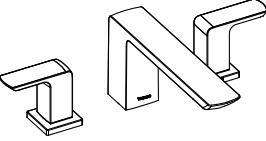

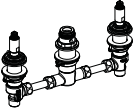
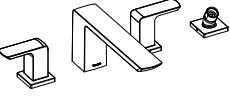
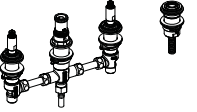



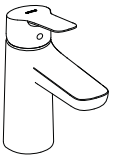

	PRODUCT NAME & DESCRIPTION	FINISH	PRODUCT NUMBER	PRICE	CUBES PALLET QTY.	APPROX. SHIP WT.
<p>TLG02301U</p>  <p>reddot award 2017 winner</p>	<p>GR SINGLE-HANDLE FAUCET</p>  <ul style="list-style-type: none"> • WaterSense certified high-efficiency 1.2 gpm (4.5 lpm) faucet • Smooth handle control with Comfort Glide™ technology • Meets California water efficiency CEC leakage regulations • Diamond-Like Carbon (DLC) coated ceramic cartridge for ultimate durability • Brass construction • Lever handles • Metal pop-up drain assembly included 	POLISHED CHROME BRUSHED NICKEL	TLG02301U#CP TLG02301U#BN	\$550 \$770	1.65	6.2 lbs
<p>TLG02304U</p>  <p>reddot award 2017 winner</p>	<p>GR SINGLE-HANDLE FAUCET - SEMI-VESSEL</p>  <ul style="list-style-type: none"> • WaterSense certified high-efficiency 1.2 gpm (4.5 lpm) faucet • Smooth handle control with Comfort Glide technology • Meets California water efficiency CEC leakage regulations • Diamond-Like Carbon (DLC) coated ceramic cartridge for ultimate durability • Brass construction • Lever handles • Metal pop-up drain assembly included 	POLISHED CHROME BRUSHED NICKEL	TLG02304U#CP TLG02304U#BN	\$690 \$966	2.07	7.6 lbs
<p>TLG02307U</p>  <p>reddot award 2017 winner</p>	<p>GR SINGLE-HANDLE FAUCET - VESSEL</p>  <ul style="list-style-type: none"> • WaterSense certified high-efficiency 1.2 gpm (4.5 lpm) faucet • Smooth handle control with Comfort Glide technology • Meets California water efficiency CEC leakage regulations • Diamond-Like Carbon (DLC) coated ceramic cartridge for ultimate durability • Brass construction • Lever handles • Metal pop-up drain assembly included 	POLISHED CHROME BRUSHED NICKEL	TLG02307U#CP TLG02307U#BN	\$800 \$1,120	2.07	8.1 lbs
<p>TLG02309U</p> 	<p>GR SIDE HANDLE FAUCET</p>  <ul style="list-style-type: none"> • WaterSense certified high-efficiency 1.2 gpm (4.5 lpm) faucet • Smooth handle control with Comfort Glide technology • Meets California water efficiency CEC leakage regulations • Diamond-Like Carbon (DLC) coated ceramic cartridge for ultimate durability • Brass construction • Lever handles • Metal pop-up drain assembly included 	POLISHED CHROME BRUSHED NICKEL	TLG02309U#CP TLG02309U#BN	\$550 \$770	0.96	10 lbs
<p>TLG02201U</p> 	<p>GR WIDESPREAD FAUCET</p>  <ul style="list-style-type: none"> • WaterSense certified high-efficiency 1.2 gpm (4.5 lpm) faucet • Meets California water efficiency CEC leakage regulations • Brass construction • Lever handles • Metal pop-up drain assembly included 	POLISHED CHROME BRUSHED NICKEL	TLG02201U#CP TLG02201U#BN	\$610 \$854	2.3	9.25 lbs

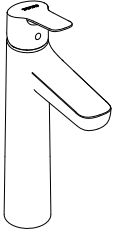
FAUCETS

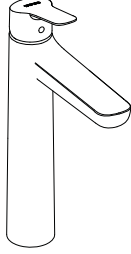
	PRODUCT NAME & DESCRIPTION	FINISH	PRODUCT NUMBER	PRICE	CUBES PALLET QTY.	APPROX. SHIP WT.
 <p>TLG02311U</p> <p>NEW</p>	<p>GR WALL-MOUNT FAUCET</p> <p> </p> <ul style="list-style-type: none"> • WaterSense certified high-efficiency 1.2 gpm (4.5 lpm) faucet • Smooth handle control with Comfort Glide™ technology • Meets California water efficiency CEC leakage regulations • Diamond-Like Carbon (DLC) coated ceramic cartridge for ultimate durability • Brass construction • ADA Compliant 	POLISHED CHROME BRUSHED NICKEL	TLG02311U#CP TLG02311U#BN	\$ 600 \$ 840	2.25	8.15 lbs
 <p>TBG02001U</p> <p>NEW</p>	<p>TUB SPOUT - MODERN S</p> <ul style="list-style-type: none"> • Laminar flow • Solid brass construction • 1/2" NPT connection 	POLISHED CHROME POLISHED NICKEL BRUSHED NICKEL	TBG02001U#CP TBG02001U#PN TBG02001U#BN	\$ 170 \$ 213 \$ 238	1.01	2.7 lbs
 <p>TBG02201U</p> <p>NEW</p>	<p>GR THREE-HOLE ROMAN TUB FILLER TRIM</p> <p></p> <ul style="list-style-type: none"> • Lever handles • Brass construction • For use with three-hole Roman tub filler rough-in (TBN01201U) • ADA Compliant 	POLISHED CHROME BRUSHED NICKEL	TBG02201U#CP TBG02201U#BN	\$ 445 \$ 731	1.54	8.5 lbs
	<p>REQUIRED VALVE</p> <p>THREE-HOLE ROMAN TUB FILLER ROUGH-IN</p> <ul style="list-style-type: none"> • See page 45 for specifications & requirements 		TBN01201U	\$ 270	0.10	3.2 lbs.
 <p>TBG02202U</p> <p>NEW</p>	<p>GR FOUR-HOLE ROMAN TUB FILLER TRIM</p> <ul style="list-style-type: none"> • Lever handles • Brass construction • Includes handshower outlet and shower hose • For use with four-hole roman tub filler rough-in (TBN01202U) • Handshower sold separately 	POLISHED CHROME BRUSHED NICKEL	TBG02202U#CP TBG02202U#BN	\$ 615 \$ 861	1.54	8.65 lbs
	<p>REQUIRED VALVE</p> <p>FOUR-HOLE ROMAN TUB FILLER ROUGH-IN</p> <ul style="list-style-type: none"> • See page 45 for specifications & requirements 	POLISHED CHROME BRUSHED NICKEL	TBN01202U#CP TBN01202U#BN	\$ 489 \$ 685	1.54	6.15 lbs.
	<p>REQUIRED ROUGH-IN TUBES (3H/4H)</p> <p>7-1/2"-8-1/4" ROUGH-IN TUBE, 3H/4H (2PCS)</p> <p>8-1/4"-9-1/16" ROUGH-IN TUBE, 3H/4H (2PCS)</p> <p>9-1/16"-9-13/16" ROUGH-IN TUBE, 3H/4H (2PCS)</p> <p>9-13/16"-10-5/8" ROUGH-IN TUBE, 3H/4H (2PCS)</p> <p>10-5/8"-11-3/8" ROUGH-IN TUBE, 3H/4H (2PCS)</p> <p>11-3/8"-12-3/16" ROUGH-IN TUBE, 3H/4H (2PCS)</p>		TBN01011U TBN01012U TBN01013U TBN01014U TBN01015U TBN01016U	\$ 32 \$ 34 \$ 36 \$ 38 \$ 42 \$ 44	0.1 0.11 0.1 0.1 0.1 0.1	0.65 lbs. 0.7 lbs. 0.75 lbs. 0.8 lbs. 0.85 lbs. 0.85 lbs.
<p>IMPORTANT HANDSHOWER REQUIREMENTS:</p> <ul style="list-style-type: none"> • Please note the handshower for 4H Roman tub filler is sold separately: Recommended Handshowers are Round Handshower (TBW01009U4), Square Handshower (TBW02010U4), and Cylindrical Handshower (TBW02016U4) • Rough-in tube is sold separately and required for 3H/4H Roman tub filler rough-in installation. • See page 45 for specifications & requirements 						

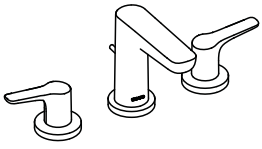
FAUCETS

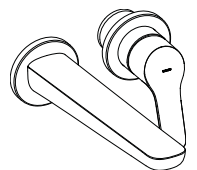
GS FAUCETS



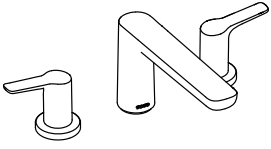
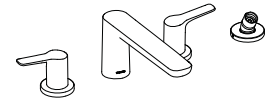
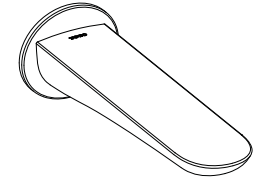

		PRODUCT NAME & DESCRIPTION	FINISH	PRODUCT NUMBER	PRICE	CUBES PALLET QTY.	APPROX. SHIP WT.
TLG03301U	 	GS SINGLE-HANDLE FAUCET  <ul style="list-style-type: none"> • WaterSense certified high-efficiency 1.2 gpm (4.5 lpm) faucet • Smooth handle control with Comfort Glide technology • Diamond-Like Carbon (DLC) coated ceramic cartridge for ultimate durability • Meets California water efficiency CEC leakage regulations • Brass construction • Lever handle • Metal pop-up drain assembly included • ADA compliant 	POLISHED CHROME POLISHED NICKEL BRUSHED NICKEL	TLG03301U#CP TLG03301U#PN TLG03301U#BN	\$300 \$375 \$420	1.65	5.7 lbs
TLG03303U	 	GS SINGLE-HANDLE FAUCET - SEMI-VESSEL  <ul style="list-style-type: none"> • WaterSense certified high-efficiency 1.2 gpm (4.5 lpm) faucet • Smooth handle control with Comfort Glide technology • Diamond-Like Carbon (DLC) coated ceramic cartridge for ultimate durability • Meets California water efficiency CEC leakage regulations • Brass construction • Lever handle • Metal pop-up drain assembly included • ADA compliant 	POLISHED CHROME POLISHED NICKEL BRUSHED NICKEL	TLG03303U#CP TLG03303U#PN TLG03303U#BN	\$375 \$469 \$525	2.07	6.8 lbs
TLG03305U	 	GS SINGLE-HANDLE FAUCET - VESSEL  <ul style="list-style-type: none"> • WaterSense certified high-efficiency 1.2 gpm faucet • Smooth handle control with Comfort Glide technology • Diamond-Like Carbon (DLC) coated ceramic cartridge for ultimate durability • Meets California water efficiency CEC leakage regulations • Brass construction • Lever handle • Metal pop-up drain assembly included • ADA compliant 	POLISHED CHROME POLISHED NICKEL BRUSHED NICKEL	TLG03305U#CP TLG03305U#PN TLG03305U#BN	\$440 \$550 \$616	2.07	7.5 lbs
TLG03201U		GS WIDESPREAD FAUCET  <ul style="list-style-type: none"> • WaterSense certified high-efficiency 1.2 gpm (4.5 lpm) faucet • Brass construction • Meets California water efficiency CEC leakage regulations • Lever handles • Metal pop-up drain assembly included • ADA compliant 	POLISHED CHROME POLISHED NICKEL BRUSHED NICKEL	TLG03201U#CP TLG03201U#PN TLG03201U#BN	\$520 \$650 \$728	2.3	8.55 lbs
TLG03308U		GS WALL-MOUNT FAUCET  <ul style="list-style-type: none"> • WaterSense certified high-efficiency 1.2 gpm (4.5 lpm) faucet • Smooth handle control with Comfort Glide technology • Meets California water efficiency CEC leakage regulations • Diamond-Like Carbon (DLC) coated ceramic cartridge for ultimate durability • Brass construction • Lever handle • ADA compliant 	POLISHED CHROME POLISHED NICKEL BRUSHED NICKEL	TLG03308U#CP TLG03308U#PN TLG03308U#BN	\$450 \$563 \$630	2.25	8.0 lbs

FAUCETS

	PRODUCT NAME & DESCRIPTION	FINISH	PRODUCT NUMBER	PRICE	CUBES PALLET QTY.	APPROX. SHIP WT.
	TBG03201U GS THREE-HOLE ROMAN TUB FILLER TRIM <ul style="list-style-type: none"> Lever handles Brass Construction For use with three-hole Roman tub filler rough-in (TBN01201U) 	POLISHED CHROME POLISHED NICKEL BRUSHED NICKEL	TBG03201U#CP TBG03201U#PN TBG03201U#BN	\$348 \$435 \$487	1.54	7.2 lbs
	REQUIRED VALVE THREE-HOLE ROMAN TUB FILLER ROUGH-IN <ul style="list-style-type: none"> See page 45 for specifications & requirements 					
	TBG03202U GS FOUR-HOLE ROMAN TUB FILLER TRIM <ul style="list-style-type: none"> Lever handles Brass Construction Includes handshower outlet and shower hose For use with four-hole roman tub filler fough-in (TBN01202U) Handshower sold separately 	POLISHED CHROME POLISHED NICKEL BRUSHED NICKEL	TBG03202U#CP TBG03202U#PN TBG03202U#BN	\$398 \$498 \$557	1.54	7.55 lbs
	REQUIRED VALVE FOUR-HOLE ROMAN TUB FILLER ROUGH-IN <ul style="list-style-type: none"> See page 45 for specifications & requirements 					
	REQUIRED ROUGH-IN TUBES (3H/4H) 7-1/2"-8-1/4" ROUGH-IN TUBE, 3H/4H (2PCS)		TBN01011U	\$32	0.1	0.65 lbs.
	8-1/4"-9-1/16" ROUGH-IN TUBE, 3H/4H (2PCS)		TBN01012U	\$34	0.11	0.7 lbs.
	9-1/16"-9-13/16" ROUGH-IN TUBE, 3H/4H (2PCS)		TBN01013U	\$36	0.1	0.75 lbs.
	9-13/16"-10-5/8" ROUGH-IN TUBE, 3H/4H (2PCS)		TBN01014U	\$38	0.1	0.8 lbs.
	10-5/8"-11-3/8" ROUGH-IN TUBE, 3H/4H (2PCS)		TBN01015U	\$42	0.1	0.85 lbs.
	11-3/8"-12-3/16" ROUGH-IN TUBE, 3H/4H (2PCS)		TBN01016U	\$44	0.1	0.85 lbs.
IMPORTANT HANDSHOWER REQUIREMENTS: <ul style="list-style-type: none"> Please note the handshower for 4H Roman tub filler is sold separately: Recommended handshowers are Round Handshower (TBW01009U4), Square Handshower (TBW02010U4), and Cylindrical Handshower (TBW02016U4) Rough-in tube is sold separately and required for 3H/4H Roman tub filler rough-in installation See page 45 for specifications & requirement 						
	TBG01001U TUB SPOUT - MODERN R <ul style="list-style-type: none"> Laminar Flow Solid brass construction 1/2" NPT connection 	POLISHED CHROME POLISHED NICKEL BRUSHED NICKEL	TBG01001U#CP TBG01001U#PN TBG01001U#BN	\$160 \$200 \$224	1.01	2.6 lbs

FAUCETS

LF FAUCETS

	PRODUCT NAME & DESCRIPTION	FINISH	PRODUCT NUMBER	PRICE	CUBES PALLET QTY.	APPROX. SHIP WT.
TLS04301U	LF SINGLE-HANDLE FAUCET   <ul style="list-style-type: none"> • WaterSense certified high-efficiency 1.2 gpm (4.5 lpm) faucet • Ceramic cartridge for long-lasting durability • Meets California water efficiency CEC leakage regulations • Brass construction • Lever handles • Metal pop-up drain assembly included • ADA compliant 	POLISHED CHROME BRUSHED NICKEL	TLS04301U#CP TLS04301U#BN ●	\$150 \$210	1.65	5.0 lbs
TLS04306U	LF SINGLE-HANDLE FAUCET - VESSEL   <ul style="list-style-type: none"> • WaterSense certified high-efficiency 1.2 gpm (4.5 lpm) faucet • Ceramic cartridge for long-lasting durability • Brass construction • Meets California water efficiency CEC leakage regulations • Lever handles • Metal pop-up drain assembly included • ADA compliant 	POLISHED CHROME BRUSHED NICKEL	TLS04306U#CP TLS04306U#BN ●	\$195 \$273	2.07	7.45 lbs
<p>● Made to order Contact Customer Service for lead time</p>						

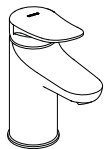

NEW

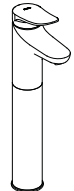





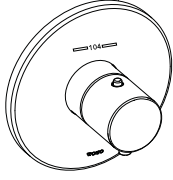

NEW

FAUCETS

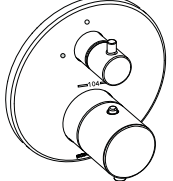
SHOWER TRIMS & VALVES

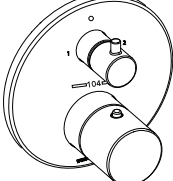







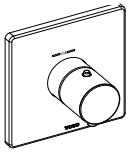

FAUCETS & SHOWERS

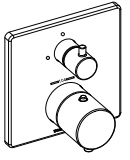
	PRODUCT NAME & DESCRIPTION	FINISH	PRODUCT NUMBER	PRICE	CUBES PALLET QTY.	APPROX. SHIP WT.
 NEW	TB01406U THERMOSTATIC MIXING VALVE TRIM - ROUND  <ul style="list-style-type: none"> • For use with Mini Unit™ (TBN01001U) • Temperature control trim with anti-scald safety top • Unobtrusive twist assist for a clean aesthetic • ASSE certified Safety Thermo™ (SMA) Thermostatic Mixing Valve • Requires volume control valve or positive shut off valve 	POLISHED CHROME POLISHED NICKEL BRUSHED NICKEL	TBV01406U#CP TBV01406U#PN TBV01406U#BN	\$579 \$724 \$811	2.01	4.55 lbs
	 REQUIRED MINI UNIT MINI UNIT ROUGH-IN BOX <ul style="list-style-type: none"> • See page 45 for specifications & requirements 		TBN01001U	\$149	0.36	3.0 lbs
 NEW	TB01407U THERMOSTATIC MIXING VALVE WITH VOLUME CONTROL TRIM - ROUND  <ul style="list-style-type: none"> • For use with Mini Unit (TBN01001U) • Unobtrusive twist assist for a clean aesthetic • Thin escutcheon at approximately 10 mm • Temperature control trim with anti-scald safety top • ASSE certified Safety Thermo (SMA) Thermostatic Mixing Valve 	POLISHED CHROME POLISHED NICKEL BRUSHED NICKEL	TBV01407U#CP TBV01407U#PN TBV01407U#BN	\$725 \$906 \$1,015	2.01	5.85 lbs
	 REQUIRED MINI UNIT MINI UNIT ROUGH-IN BOX <ul style="list-style-type: none"> • See page 45 for specifications & requirements 		TBN01001U	\$149	0.36	3.0 lbs
 NEW	TB01408U THERMOSTATIC MIXING VALVE WITH TWO-WAY DIVERTER TRIM - ROUND  <ul style="list-style-type: none"> • For use with Mini Unit (TBN01001U) Valve • Unobtrusive twist assist for a clean aesthetic • Meets 2018 California water efficiency appliance CEC regulations • Thin escutcheon at approximately 10 mm • Temperature control trim with anti-scald safety top • ASSE certified Safety Thermo (SMA) Thermostatic Mixing Valve 	POLISHED CHROME POLISHED NICKEL BRUSHED NICKEL	TBV01408U#CP TBV01408U#PN TBV01408U#BN	\$788 \$985 \$1,103	2.01	5.9 lbs
	 REQUIRED MINI UNIT MINI UNIT ROUGH-IN BOX <ul style="list-style-type: none"> • See page 45 for specifications & requirements 		TBN01001U	\$149	0.36	3.0 lbs

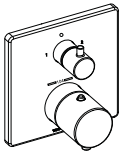
FAUCETS & SHOWERS

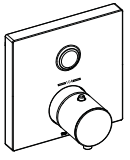
SHOWER TRIMS & VALVES

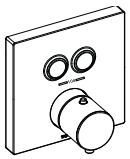

FAUCETS & SHOWERS

	PRODUCT NAME & DESCRIPTION	FINISH	PRODUCT NUMBER	PRICE	CUBES PALLET QTY.	APPROX. SHIP WT.
 TBV02401U	THERMOSTATIC MIXING VALVE TRIM - SQUARE  <ul style="list-style-type: none"> • For use with Mini Unit™ (TBN01001U) • Temperature control trim with anti-scald safety stop • Unobtrusive twist assist for a clean aesthetic • ASSE certified Safety Thermo™ (SMA) Thermostatic Mixing Valve • Require volume control valve or positive shut off valve 	POLISHED CHROME POLISHED NICKEL BRUSHED NICKEL	TBV02401U#CP TBV02401U#PN TBV02401U#BN	\$600 \$750 \$840	2.01	4.7 lbs
	 REQUIRED MINI UNIT MINI UNIT ROUGH-IN BOX <ul style="list-style-type: none"> • See page 45 for specifications & requirements 			TBN01001U	\$149	0.36
 TBV02403U	THERMOSTATIC MIXING VALVE WITH VOLUME CONTROL TRIM - SQUARE  <ul style="list-style-type: none"> • For use with Mini Unit (TBN01001U) • Temperature control trim with anti-scald safety stop • Unobtrusive twist assist for a clean aesthetic • ASSE certified Safety Thermo™ (SMA) Thermostatic Mixing Valve 	POLISHED CHROME POLISHED NICKEL BRUSHED NICKEL	TBV02403U#CP TBV02403U#PN TBV02403U#BN	\$740 \$925 \$1,036	2.01	5.95 lbs
	 REQUIRED MINI UNIT MINI UNIT ROUGH-IN BOX <ul style="list-style-type: none"> • See page 45 for specifications & requirements 			TBN01001U	\$149	0.36
 TBV02404U	THERMOSTATIC MIXING VALVE WITH TWO-WAY DIVERTER TRIM - SQUARE  <ul style="list-style-type: none"> • For use with Mini Unit (TBN01001U) • Unobtrusive twist assist for a clean aesthetic • Meets 2018 California water efficiency CEC leakage regulations • Thin escutcheon at approximately 10mm • ASSE certified Safety Thermo™ (SMA) Thermostatic Mixing Valve 	POLISHED CHROME POLISHED NICKEL BRUSHED NICKEL	TBV02404U#CP TBV02404U#PN TBV02404U#BN	\$804 \$1,005 \$1,126	2.47	5.55 lbs
	 REQUIRED MINI UNIT MINI UNIT ROUGH-IN BOX <ul style="list-style-type: none"> • See page 45 for specifications & requirements 			TBN01001U	\$149	0.36
 TBV02405U	THERMOSTATIC MIXING VALVE 1-FUNCTION TRIM  <ul style="list-style-type: none"> • For use with Mini Unit (TBN01001U) • Temperature control trim with anti-scald safety stop • Unobtrusive twist assist for a clean aesthetic • ASSE certified Safety Thermo™ (SMA) Thermostatic Mixing Valve • One-push button for easy on/off 	POLISHED CHROME POLISHED NICKEL BRUSHED NICKEL	TBV02405U#CP TBV02405U#PN TBV02405U#BN	\$895 \$1,119 \$1,253	2.47	5.5 lbs
	 REQUIRED MINI UNIT MINI UNIT ROUGH-IN BOX <ul style="list-style-type: none"> • See page 45 for specifications & requirements 			TBN01001U	\$149	0.36
 TBV02406U	THERMOSTATIC MIXING VALVE 2-FUNCTION TRIM  <ul style="list-style-type: none"> • For use with Mini Unit (TBN01001U) • Temperature control trim with anti-scald safety stop • Unobtrusive twist assist for a clean aesthetic • ASSE certified Safety Thermo™ (SMA) Thermostatic Mixing Valve • Push button to easily switch between showers 	POLISHED CHROME POLISHED NICKEL BRUSHED NICKEL	TBV02406U#CP TBV02406U#PN TBV02406U#BN	\$1,103 \$1,379 \$1,544	2.47	5.7 lbs
	 REQUIRED MINI UNIT MINI UNIT ROUGH-IN BOX <ul style="list-style-type: none"> • See page 45 for specifications & requirements 			TBN01001U	\$149	0.36

FAUCETS & SHOWERS

SHOWER TRIMS & VALVES

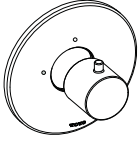
FAUCETS & SHOWERS

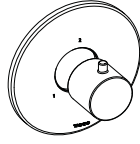
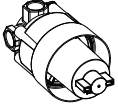
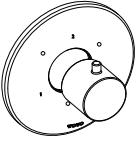
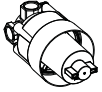
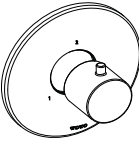
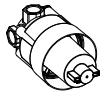
	PRODUCT NAME & DESCRIPTION	FINISH	PRODUCT NUMBER	PRICE	CUBES PALLET QTY.	APPROX. SHIP WT.
TBV01101U	VOLUME CONTROL VALVE TRIM - ROUND	POLISHED CHROME POLISHED NICKEL BRUSHED NICKEL	TBV01101U#CP TBV01101U#PN TBV01101U#BN	\$109 \$137 \$153	1.44	1.35 lbs
	<ul style="list-style-type: none"> • For use with TBN01104U Valve • Unobtrusive twist assist for a clean aesthetic • Thin escutcheon at approximately 10 mm 					
	REQUIRED VALVE VOLUME CONTROL VALVE <ul style="list-style-type: none"> • See page 45 for specifications & requirements 	POLISHED CHROME POLISHED NICKEL BRUSHED NICKEL	TBN01104U#CP TBN01104U#PN TBN01104U#BN	\$175 \$219 \$245	1.44	2.4 lbs
TBV01103U	TWO-WAY DIVERTER TRIM - ROUND	POLISHED CHROME POLISHED NICKEL BRUSHED NICKEL	TBV01103U#CP TBV01103U#PN TBV01103U#BN	\$110 \$138 \$154	1.45	1.35 lbs
	<ul style="list-style-type: none"> • For use with TBN01102U Valve • Unobtrusive twist assist for a clean aesthetic • Thin escutcheon at approximately 10 mm • No positive shut off position 					
	REQUIRED VALVE TWO-WAY DIVERTER VALVE <ul style="list-style-type: none"> • See page 45 for specifications & requirements • No positive shut-off positions 	POLISHED CHROME POLISHED NICKEL BRUSHED NICKEL	TBN01102U#CP TBN01102U#PN TBN01102U#BN	\$249 \$311 \$349	1.45	2.75 lbs
TBV01102U	THREE-WAY DIVERTER TRIM WITH INTEGRATED OFF POSITION - ROUND	POLISHED CHROME POLISHED NICKEL BRUSHED NICKEL	TBV01102U#CP TBV01102U#PN TBV01102U#BN	\$110 \$138 \$154	1.44	1.35 lbs
	<ul style="list-style-type: none"> • For use with TBN01101U Valve • Unobtrusive twist assist for a clean aesthetic • Thin escutcheon at approximately 10 mm • With 3 positive shut-off positions 					
	REQUIRED VALVE THREE-WAY DIVERTER VALVE WITHOUT OFF <ul style="list-style-type: none"> • See page 45 for specifications & requirements • With positive shut-off positions 	POLISHED CHROME POLISHED NICKEL BRUSHED NICKEL	TBN01101U#CP TBN01101U#PN TBN01101U#BN	\$256 \$320 \$359	1.45	2.7 lbs
TBV01104U	THREE-WAY DIVERTER TRIM - ROUND	POLISHED CHROME POLISHED NICKEL BRUSHED NICKEL	TBV01104U#CP TBV01104U#PN TBV01104U#BN	\$110 \$138 \$154	1.45	1.35 lbs
	<ul style="list-style-type: none"> • For use with TBN01103U Valve • Unobtrusive twist assist for a clean aesthetic • Thin escutcheon at approximately 10 mm • No positive shut-off position 					
	REQUIRED VALVE THREE-WAY DIVERTER VALVE <ul style="list-style-type: none"> • See page 45 for specifications & requirements • No positive shut-off positions 	POLISHED CHROME POLISHED NICKEL BRUSHED NICKEL	TBN01103U#CP TBN01103U#PN TBN01103U#BN	\$249 \$311 \$349	1.45	2.7 lbs

FAUCETS & SHOWERS

SHOWER TRIMS & VALVES

FAUCETS & SHOWERS

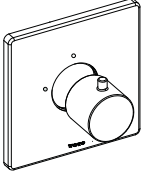
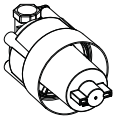
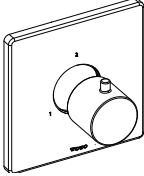
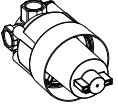
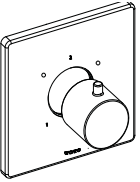
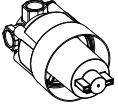
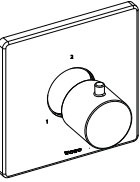
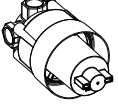
	PRODUCT NAME & DESCRIPTION	FINISH	PRODUCT NUMBER	PRICE	CUBES PALLET QTY.	APPROX. SHIP WT.
 TBV02101U	VOLUME CONTROL VALVE TRIM - SQUARE <ul style="list-style-type: none"> • For use with TBN01104U Valve • Unobtrusive twist assist for a clean aesthetic • Thin escutcheon at approximately 10mm 	POLISHED CHROME POLISHED NICKEL BRUSHED NICKEL	TBV02101U#CP TBV02101U#PN TBV02101U#BN	\$122 \$153 \$171	1.44	1.45 lbs
	 REQUIRED VALVE VOLUME CONTROL VALVE <ul style="list-style-type: none"> • See page 45 for specifications & requirements 	POLISHED CHROME POLISHED NICKEL BRUSHED NICKEL	TBN01104U#CP TBN01104U#PN TBN01104U#BN	\$175 \$219 \$245	1.44	2.4 lbs
 TBV02103U	TWO-WAY DIVERTER TRIM - SQUARE <ul style="list-style-type: none"> • For use with TBN01102U Valve • Unobtrusive twist assist for a clean aesthetic • Thin escutcheon at approximately 10 mm • No positive shut-off position 	POLISHED CHROME POLISHED NICKEL BRUSHED NICKEL	TBV02103U#CP TBV02103U#PN TBV02103U#BN	\$123 \$154 \$172	1.45	1.45 lbs
	 REQUIRED VALVE TWO-WAY DIVERTER VALVE <ul style="list-style-type: none"> • See page 45 for specifications & requirements • No positive shut-off positions 	POLISHED CHROME POLISHED NICKEL BRUSHED NICKEL	TBN01102U#CP TBN01102U#PN TBN01102U#BN	\$249 \$311 \$349	1.45	2.75 lbs
 TBV02102U	THREE-WAY DIVERTER TRIM WITH INTEGRATED SHUT-OFF POSITION- SQUARE <ul style="list-style-type: none"> • For use with TBN01101U Valve • Unobtrusive twist assist for a clean aesthetic • Thin escutcheon at approximately 10mm • With 3 positive shut-off positions 	POLISHED CHROME POLISHED NICKEL BRUSHED NICKEL	TBV02102U#CP TBV02102U#PN TBV02102U#BN	\$123 \$154 \$172	1.44	1.45 lbs
	 REQUIRED VALVE THREE-WAY DIVERTER VALVE WITH OFF <ul style="list-style-type: none"> • See page 45 for specifications & requirements • With positive shut-off positions 	POLISHED CHROME POLISHED NICKEL BRUSHED NICKEL	TBN01101U#CP TBN01101U#PN TBN01101U#BN	\$256 \$320 \$359	1.45	2.7 lbs
 TBV02104U	THREE-WAY DIVERTER TRIM - SQUARE <ul style="list-style-type: none"> • For use with TBN01103U Valve • Unobtrusive twist assist for a clean aesthetic • Thin escutcheon at approximately 10 mm • No positive shut-off position 	POLISHED CHROME POLISHED NICKEL BRUSHED NICKEL	TBV02104U#CP TBV02104U#PN TBV02104U#BN	\$123 \$154 \$172	1.44	1.4 lbs
	 REQUIRED VALVE THREE-WAY DIVERTER VALVE <ul style="list-style-type: none"> • See page 45 for specifications & requirements • No positive shut-off positions 	POLISHED CHROME POLISHED NICKEL BRUSHED NICKEL	TBN01103U#CP TBN01103U#PN TBN01103U#BN	\$249 \$311 \$349	1.45	2.7 lbs

VALVES

FAUCETS & SHOWERS

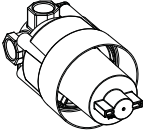
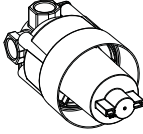
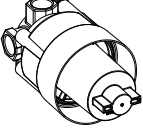
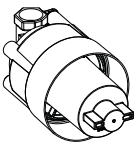
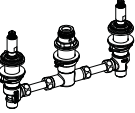
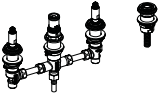







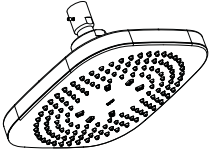

	PRODUCT NAME & DESCRIPTION	FINISH	PRODUCT NUMBER	PRICE	CUBES PALLET QTY.	APPROX. SHIP WT.
TBN01001U	MINI UNIT ROUGH-IN BOX		TBN01001U	\$149	0.36	3.0 lbs
 NEW	<ul style="list-style-type: none"> • Universal rough-in to allow easy customization of valves and trims without removing walls • Corrosion resistant solid brass valve body • Intuitive 360 degree box design to minimize installation error • 1" tolerance adjustable to thinner or thicker walls • Compact body measured at 4.4" diameter and weighted 1.6 lbs for an effortless installation • Requires volume control valve or positive shut-off valve 					
TBN01101U	THREE-WAY DIVERTER VALVE WITH OFF		TBN01101U#CP TBN01101U#PN TBN01101U#BN	\$256 \$320 \$359	1.45	2.7 lbs
 NEW	<ul style="list-style-type: none"> • Corrosion resistant solid brass body • 1/2" NPT connections • Ceramic disk valve cartridge • Meets California water efficiency CEC leakage regulations • 3 independent outlets • 3 positive shut-off positions 					
TBN01102U	TWO-WAY DIVERTER VALVE		TBN01102U#CP TBN01102U#PN TBN01102U#BN	\$249 \$311 \$349	1.45	2.75 lbs
 NEW	<ul style="list-style-type: none"> • Corrosion resistant solid brass body • 1/2" NPT connections • Ceramic disk valve cartridge • Meets California water efficiency CEC leakage regulations • 2 independent outlets • No positive shut-off position 					
TBN01103U	THREE-WAY DIVERTER VALVE		TBN01103U#CP TBN01103U#PN TBN01103U#BN	\$249 \$311 \$349	1.45	2.7 lbs
 NEW	<ul style="list-style-type: none"> • Corrosion resistant solid brass body • 1/2" NPT connections • Ceramic disk valve cartridge • Meets California water efficiency CEC leakage regulations • 3 independent outlets • No positive shut-off position 					
TBN01104U	VOLUME CONTROL VALVE		TBN01104U#CP TBN01104U#PN TBN01104U#BN	\$175 \$219 \$245	1.44	2.4 lbs
 NEW	<ul style="list-style-type: none"> • Corrosion resistant solid brass valve body • 1/2" NPT connections • Ceramic disk valve cartridge 					
TBN01201U	THREE-HOLE ROMAN TUB FILLER ROUGH-IN		TBN01201U	\$270	0.1	3.2 lbs.
 NEW	<ul style="list-style-type: none"> • Solid brass valve body • 1/2" NPT connections 					
TBN01202U	FOUR-HOLE ROMAN TUB FILLER ROUGH-IN		TBN01202U#CP TBN01202U#PN TBN01202U#BN	\$489 \$611 \$685	1.54	6.15 lbs.
 NEW	<ul style="list-style-type: none"> • Solid brass valve body • 1/2" NPT connections • Meets California water efficiency CEC leakage regulations 					
	REQUIRED ROUGH-IN TUBES (3H/4H)					
	7-1/2"-8-1/4" ROUGH-IN TUBE, 3H/4H (2PCS)		TBN01011U	\$32	0.1	0.65 lbs.
	8-1/4"-9-1/16" ROUGH-IN TUBE, 3H/4H (2PCS)		TBN01012U	\$34	0.11	0.7 lbs.
	9-1/16"-9-13/16" ROUGH-IN TUBE, 3H/4H (2PCS)		TBN01013U	\$36	0.1	0.75 lbs.
	9-13/16"-10-5/8" ROUGH-IN TUBE, 3H/4H (2PCS)		TBN01014U	\$38	0.1	0.8 lbs.
	10-5/8"-11-3/8" ROUGH-IN TUBE, 3H/4H (2PCS)		TBN01015U	\$42	0.1	0.85 lbs.
	11-3/8"-12-3/16" ROUGH-IN TUBE, 3H/4H (2PCS)		TBN01016U	\$44	0.1	0.85 lbs.

FAUCETS & SHOWERS



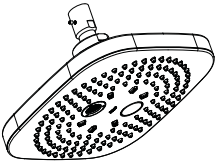

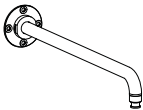

**SHOWERHEADS &
HANDSHOWERS**

G SERIES SHOWERHEADS

	PRODUCT NAME & DESCRIPTION	FINISH	PRODUCT NUMBER	PRICE	CUBES PALLET QTY.	APPROX. SHIP WT.
TBW01003U	ROUND SHOWERHEAD 1 MODE 8.5" - 1.75 GPM  NEW • WaterSense certified high-efficiency 1.75 gpm (6.6 lpm) showerhead • Balanced overlaying rinse and wash Comfort Wave™ Technology • 8.5" (220 mm) diameter spray face • Rubber nozzles to prevent lime scale build up • Includes matching escutcheon • Showerarm sold separately	POLISHED CHROME	TBW01003U4#CP	\$280	0.62	4.2 lbs
	ROUND SHOWERHEAD 1 MODE 8.5" - 2.5 GPM  • Same as TBW01003U4 except maximum flow rate of 2.5 gpm (9.5 lpm)	POLISHED CHROME POLISHED NICKEL BRUSHED NICKEL	TBW01003U1#CP TBW01003U1#PN TBW01003U1#BN	\$280 \$350 \$392	0.62	4.2 lbs
TBW02003U	SQUARE SHOWERHEAD 1 MODE 8.5" - 1.75 GPM  NEW • WaterSense certified high-efficiency 1.75 gpm (6.6 lpm) showerhead • Balanced overlaying rinse and wash Comfort Wave Technology • 8.5" (220 mm) diameter spray face • Meets California water efficiency CEC leakage regulations • Rubber nozzles to prevent lime scale build up • Includes matching escutcheon • Showerarm sold separately	POLISHED CHROME	TBW02003U4#CP	\$280	0.62	4.35 lbs
	SQUARE SHOWERHEAD 1 MODE 8.5" - 2.5 GPM  • Same as TBW02003U4 except maximum flow rate of 2.5 gpm (9.5 lpm)	POLISHED CHROME	TBW02003U1#CP	\$280	0.62	4.4 lbs
TBW01004U	ROUND SHOWERHEAD 2 MODE 8.5" - 1.75 GPM  NEW • WaterSense certified high-efficiency 1.75 gpm (6.6 lpm) showerhead • Balanced overlaying rinse and wash Comfort Wave Technology • Bathing shower Warm Spa™ Technology • 8.5" (220 mm) diameter spray face • Meets California water efficiency CEC leakage regulations • Rubber nozzles to prevent lime scale build up • Includes matching escutcheon • Push button switch to change shower mode effortlessly • Showerarm sold separately	POLISHED CHROME	TBW01004U4#CP	\$320	0.62	4.45 lbs
	ROUND SHOWERHEAD 2 MODE 8.5" - 2.5 GPM  • Same as TBW01004U4 except maximum flow rate of 2.5 gpm (9.5 lpm)	POLISHED CHROME	TBW01004U1#CP	\$320	0.62	4.5 lbs
TBW02004U	SQUARE SHOWERHEAD 2 MODE 8.5" - 1.75 GPM  NEW • WaterSense certified high-efficiency 1.75 gpm (6.6 lpm) showerhead • Balanced overlaying rinse and wash Comfort Wave Technology • Bathing shower Warm Spa Technology • 8.5" (220 mm) diameter spray face • Meets California water efficiency CEC leakage regulations • Rubber nozzles to prevent lime scale build up • Includes matching escutcheon • Showerarm sold separately	POLISHED CHROME	TBW02004U4#CP	\$320	0.62	4.5 lbs
	SQUARE SHOWERHEAD 2 MODE 8.5" - 2.5 GPM  • Same as TBW02004U4 except maximum flow rate of 2.5 gpm (9.5 lpm)	POLISHED CHROME	TBW02004U1#CP	\$320	0.62	4.5 lbs
TS110MW16	RAIN SHOWER ARM  • Wall-mount • 16" length • Solid brass construction • For use with TS111B/TS112B/TBW0100/TBW0200	POLISHED CHROME POLISHED NICKEL BRUSHED NICKEL	TS110MW16#CP TS110MW16#PN TS110MW16#BN	\$123 \$153 \$172	0.21 / 153	2.4 lbs.
TS110MC6	RAIN SHOWER ARM  • Ceiling mount • 6" length • Solid brass construction • For use with TS111B/TS112B/TBW0100/TBW0200	POLISHED CHROME POLISHED NICKEL BRUSHED NICKEL	TS110MC6#CP TS110MC6#PN TS110MC6#BN	\$82 \$102 \$114	0.04 / 378	0.6 lbs.



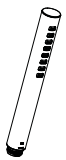

SHOWERS

G SERIES HANDSHOWERS

	PRODUCT NAME & DESCRIPTION	FINISH	PRODUCT NUMBER	PRICE	CUBES PALLET QTY.	APPROX. SHIP WT.
TBW01009U4	ROUND HANDSHOWER 1 MODE - 1.75 GPM  NEW <ul style="list-style-type: none"> WaterSense certified high-efficiency 1.75 gpm (6.6 lpm) ø4-5/16" Single spray handshower Balanced Comfort Wave™ technology with wide coverage rinse & wash Rubber nozzles to prevent limescale build-up Meets 2018 California water efficiency appliance CEC regulations Shower hose sold separately 	POLISHED CHROME POLISHED NICKEL BRUSHED NICKEL	TBW01009U4#CP TBW01009U4#PN TBW01009U4#BN	\$140 \$175 \$196	1.44	1.05 lbs
TBW02010U4	SQUARE HANDSHOWER 1 MODE - 1.75 GPM  NEW <ul style="list-style-type: none"> WaterSense certified high-efficiency 1.75 gpm (6.6 lpm) ø4-5/16" Single spray handshower Balanced Comfort Wave technology with wide coverage rinse & wash Rubber nozzles to prevent limescale build-up Meets 2018 California water efficiency appliance CEC regulations Shower hose sold separately 	POLISHED CHROME POLISHED NICKEL BRUSHED NICKEL	TBW02010U4#CP TBW02010U4#PN TBW02010U4#BN	\$140 \$175 \$196	1.44	1.1 lbs
TBW01011U4	ROUND HANDSHOWER 3 MODE - 1.75 GPM  NEW <ul style="list-style-type: none"> WaterSense high-efficiency low-flow 1.75 gpm (6.6 lpm) ø4-5/16" Multi-function spray handshower Balanced Comfort Wave technology with wide coverage rinse & wash Rejuvenating Active Wave™ technology for a strong, amplified wavy jet spray Bathing shower Warm Spa™ for a soothing, body enveloping rinse One-Hand click button to switch between spray modes effortlessly Rubber nozzles to prevent limescale build up Meets 2018 California water efficiency appliance CEC regulations Shower hose sold separately 	POLISHED CHROME POLISHED NICKEL BRUSHED NICKEL	TBW01011U4#CP TBW01011U4#PN TBW01011U4#BN	\$180 \$225 \$252	1.44	1.15 lbs
TBW02015U4	SQUARE HANDSHOWER 3 MODE - 1.75 GPM  NEW <ul style="list-style-type: none"> WaterSense certified high-efficiency 1.75 gpm (6.6 lpm) ø4-5/16" Multi-function spray handshower Balanced Comfort Wave technology with wide coverage rinse & wash Rejuvenating Active Wave technology for a strong, amplified wavy jet spray Bathing shower Warm Spa for a soothing, body enveloping rinse One-Hand click button to switch between spray modes effortlessly Rubber nozzles to prevent limescale build up Meets 2018 California water efficiency appliance CEC regulations Shower hose sold separately 	POLISHED CHROME POLISHED NICKEL BRUSHED NICKEL	TBW02015U4#CP TBW02015U4#PN TBW02015U4#BN	\$180 \$225 \$252	1.44	1.25 lbs
TBW02016U4	CYLINDRICAL HANDSHOWER 1 MODE - 1.75 GPM  NEW <ul style="list-style-type: none"> WaterSense certified high-efficiency 1.75 gpm (6.6 lpm) Balanced Comfort Wave™ technology with wide coverage rinse & wash Rubber nozzles to prevent limescale build up Meets 2018 California water efficiency appliance CEC regulations 	POLISHED CHROME POLISHED NICKEL BRUSHED NICKEL	TBW02016U4#CP TBW02016U4#PN TBW02016U4#BN	\$175 \$219 \$245	1.44	1.05 lbs
IMPORTANT HANDSHOWER REQUIREMENTS: <ul style="list-style-type: none"> Please note the following handshower components are sold separately: Wall Outlet (TS101R), Shower Arm Mount (TS101S), Handshower Wall-Mount (TS101V), and Shower Hose 60" (TS101W60) 						



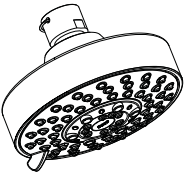



SHOWERS

L SERIES SHOWERHEADS

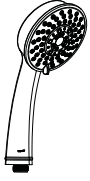
	PRODUCT NAME & DESCRIPTION	FINISH	PRODUCT NUMBER	PRICE	CUBES PALLET QTY.	APPROX. SHIP WT.
TBW03001U4	CLASSIC SHOWERHEAD 5 MODE - 1.75 GPM	POLISHED CHROME	TBW03001U4#CP	\$ 80	1.82	1.0 lb
	NEW <ul style="list-style-type: none"> WaterSense certified high-efficiency 1.75 gpm (6.6 lpm) showerhead Rubber nozzles to prevent limescale build-up G 1/2 thread connection compatible with 1/2 NPT Meets 2018 California water efficiency appliance CEC regulations Showerarm sold separately 					
TBW01012U4	MODERN SHOWERHEAD 1 MODE - 1.75 GPM	POLISHED CHROME	TBW01012U4#CP	\$ 58	1.82	1.0 lb
	NEW <ul style="list-style-type: none"> WaterSense certified high-efficiency 1.75 gpm (6.6 lpm) showerhead Rubber nozzles to prevent limescale build-up G 1/2 thread connection compatible with 1/2 NPT Meets 2018 California water efficiency appliance CEC regulations Showerarm sold separately 					
TBW01013U4	MODERN SHOWERHEAD 5 MODE - 1.75 GPM	POLISHED CHROME	TBW01013U4#CP	\$ 70	1.82	1.05 lbs
	NEW <ul style="list-style-type: none"> WaterSense certified high-efficiency 1.75 gpm (6.6 lpm) showerhead Rubber nozzles to prevent limescale build-up G 1/2 thread connection compatible with 1/2 NPT Meets 2018 California water efficiency appliance CEC regulations Showerarm sold separately 					
TBW01012UV1	MODERN COLLECTION SHOWER ARM 6"	POLISHED CHROME	TBW01012UV1#CP	\$ 35	1.01	0.75 lbs.
	NEW <ul style="list-style-type: none"> 1/2" NPT connection Includes escutcheon 					

SHOWERS

L SERIES HANDSHOWERS

	PRODUCT NAME & DESCRIPTION	FINISH	PRODUCT NUMBER	PRICE	CUBES PALLET QTY.	APPROX. SHIP WT.
TBW03003U2  NEW	CLASSIC HANDSHOWER 5 MODE - 2.0 GPM  <ul style="list-style-type: none"> • WaterSense certified high-efficiency 2.0 gpm (7.6 lpm) • 4-1/16" Multi-function spray with rinse, aerated, and massage sprays • Rubber nozzles to prevent limescale build-up • Shower hose sold separately 	POLISHED CHROME	TBW03003U2#CP	\$ 80	1.94	1.10 lbs
TBW01019U2  NEW	MODERN HANDSHOWER 1 MODE - 2.0 GPM  <ul style="list-style-type: none"> • WaterSense certified high-efficiency 2.0 gpm (7.6 lpm) • 4-1/16" Single-spray handshower • Balanced Comfort Wave technology with wide coverage rinse & wash • Rubber nozzles to prevent limescale build up • Meets 2018 California water efficiency appliance CEC regulations 	POLISHED CHROME	TBW01019U2#CP	\$ 58	1.94	1.0 lb
TBW01020U2  NEW	MODERN HANDSHOWER 5 MODE - 2.0 GPM  <ul style="list-style-type: none"> • WaterSense certified high-efficiency 2.0 gpm (7.6 lpm) • 4-1/16" Multi-function spray with rinse, aerated, and massage sprays • Rubber nozzles to prevent limescale build-up • Shower hose sold separately 	POLISHED CHROME	TBW01020U2#CP	\$ 70	1.94	1.05 lbs
IMPORTANT HANDSHOWER REQUIREMENTS: <ul style="list-style-type: none"> • Please note the following handshower components are sold separately: Wall Outlet (TS101R), Shower Arm Mount (TS101S), Handshower Wall-Mount (TS101V), and Shower Hose 60" (TS101W60) 						



SHOWERS



COMMERICAL FAUCETS



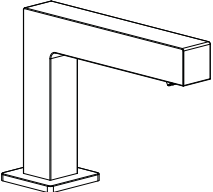

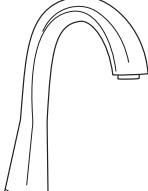
LIBELLA™ WALL-MOUNT M ECOPOWER® FAUCET; SEE PAGE 55

COMMERCIAL
ECOPOWER® FAUCETS

TEL143	PRODUCT NAME & DESCRIPTION	FINISH	PRODUCT NUMBER	PRICE	CUBES PALLET QTY.	APPROX. SHIP WT.
	NEW AXIOM® ECOPOWER® FAUCET  CALGreen <ul style="list-style-type: none"> • Consists of spout and controller • Hydropower self-generating system • Sensor faucet with laminar flow • Self adjusting faucet with control box and mounting hardware, less supply lines • Single-hole mount • Equipped with 0.35 gpm flow control 					
	0.11 GPC, 20 SECS ON-DEMAND	POLISHED CHROME	TEL143-D20E#CP ▲	\$1,067		5.5 lbs.
	0.11 GPC, 20 SECS ON-DEMAND MIXING VALVE	POLISHED CHROME	TEL143-D20EM#CP ▲	\$1,135		6.2 lbs.
	0.11 GPC, 20 SECS ON-DEMAND THERMOSTATIC MIXING VALVE	POLISHED CHROME	TEL143-D20ET#CP ▲	\$1,310		6.5 lbs.
	AVAILABLE COMPONENTS					
	SPOUT					
	AXIOM SPOUT	POLISHED CHROME	TELS143#CP ▲	\$679		2.55 lbs.
	CONTROLLER					
	0.11 GPC, 20 SECS ON-DEMAND		TELC103-D20E ▲	\$388		3.05 lbs.
	AVAILABLE VALVES					
	MIXING VALVE		TLM10	\$68		0.6 lbs.
	NEW THERMOSTATIC MIXING VALVE		TLT20 ▲	\$243		1.2 lbs.
	AVAILABLE ACCESSORIES					
	4" CENTER COVER PLATE	POLISHED CHROME	THP3158#CP	\$47		
8" CENTER COVER PLATE	POLISHED CHROME	THP3159#CP	\$88			
TEL153	NEW GOOSENECK ECOPOWER® FAUCET  CALGreen <ul style="list-style-type: none"> • Consists of spout and controller • Hydropower self-generating system • Sensor faucet with aerated flow • Self adjusting faucet with control box and mounting hardware, less supply lines • Single-hole mount • Equipped with 0.35 gpm flow control 					
	0.11 GPC, 20 SECS ON-DEMAND	POLISHED CHROME	TEL153-D20E#CP ▲	\$873		6.7 lbs.
	0.11 GPC, 20 SECS ON-DEMAND MIXING VALVE	POLISHED CHROME	TEL153-D20EM#CP ▲	\$941		7.3 lbs.
	0.11 GPC, 20 SECS ON-DEMAND THERMOSTATIC MIXING VALVE	POLISHED CHROME	TEL153-D20ET#CP ▲	\$1,116		7.6 lbs.
	AVAILABLE COMPONENTS					
	SPOUT					
	GOOSENECK SPOUT	POLISHED CHROME	TELS153#CP ▲	\$485		3.65 lbs.
	CONTROLLER					
	0.11 GPC, 20 SECS ON-DEMAND		TELC103-D20E ▲	\$388		3.05 lbs.
	AVAILABLE VALVES					
	MIXING VALVE		TLM10	\$68		0.6 lbs.
	NEW THERMOSTATIC MIXING VALVE		TLT20 ▲	\$243		1.2 lbs.
	AVAILABLE ACCESSORIES					
	4" CENTER COVER PLATE	POLISHED CHROME	THP3158#CP	\$47		
	8" CENTER COVER PLATE	POLISHED CHROME	THP3159#CP	\$88		

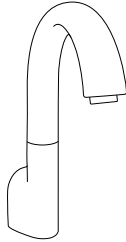
▲ Available Q4 2018





ECOPOWER
FAUCETS

TEL163	PRODUCT NAME & DESCRIPTION	FINISH	PRODUCT NUMBER	PRICE	CUBES PALLET QTY.	APPROX. SHIP WT.	
	NEW GOOSENECK WALL-MOUNT ECOPOWER® FAUCET  CALGreen <ul style="list-style-type: none"> • Consists of spout and controller • Hydropower self-generating system • Sensor faucet with aerated flow • Self adjusting faucet with control box and mounting hardware, less supply lines • Wall-mount • Equipped with 0.35 gpm flow control 						
	0.11 GPC, 10 SECS ON-DEMAND	POLISHED CHROME	TEL163-D20E#CP ▲	\$ 960		7.2 lbs.	
	0.11 GPC, 10 SECS ON-DEMAND MIXING VALVE	POLISHED CHROME	TEL163-D20EM#CP ▲	\$1,028		7.8 lbs.	
	0.11 GPC, 10 SECS ON-DEMAND THERMOSTATIC MIXING VALVE	POLISHED CHROME	TEL163-D20ET#CP ▲	\$1,203		8.1 lbs.	
	AVAILABLE COMPONENTS						
	SPOUT						
	GOOSENECK WALL-MOUNT SPOUT	POLISHED CHROME	TELS163#CP ▲	\$ 572		4.15 lbs.	
	CONTROLLER						
	0.11 GPC, 20 SECS ON-DEMAND		TELC103-D20E ▲	\$ 388		3.05 lbs.	
	AVAILABLE VALVES						
MIXING VALVE		TLM10	\$ 68		0.6 lbs.		
NEW	THERMOSTATIC MIXING VALVE		TLT20 ▲	\$243		1.2 lbs.	
TEL113	NEW HELIX® ECOPOWER® FAUCET  CALGreen <ul style="list-style-type: none"> • Consists of spout and controller • Hydropower self-generating system • Sensor faucet with aerated flow • Self adjusting faucet with control box and mounting hardware, less supply line • Single-hole mount • Equipped with 0.35 gpm flow control 						
	0.11 GPC, 20 SECS ON-DEMAND	POLISHED CHROME	TEL113-D20E#CP ▲	\$ 767		4.8 lbs.	
	0.11 GPC, 20 SECS ON-DEMAND MIXING VALVE	POLISHED CHROME	TEL113-D20EM#CP ▲	\$ 835		5.4 lbs.	
	0.11 GPC, 20 SECS ON-DEMAND THERMOSTATIC MIXING VALVE	POLISHED CHROME	TEL113-D20ET#CP ▲	\$1,010		TBD	
	AVAILABLE COMPONENTS						
	SPOUT						
	HELIX SPOUT	POLISHED CHROME	TELS113#CP ▲	\$ 379		1.8 lbs.	
	CONTROLLER						
	0.11 GPC, 20 SECS ON-DEMAND		TELC103-D20E ▲	\$ 388		3.05 lbs.	
	AVAILABLE VALVES						
	MIXING VALVE		TLM10	\$ 68		0.6 lbs.	
NEW	THERMOSTATIC MIXING VALVE		TLT20 ▲	\$243		1.2 lbs.	
AVAILABLE ACCESSORIES							
4" CENTER COVER PLATE	POLISHED CHROME	THP3158#CP	\$ 47				
8" CENTER COVER PLATE	POLISHED CHROME	THP3159#CP	\$ 88				



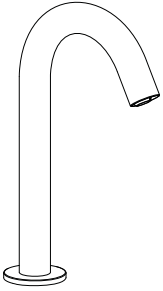

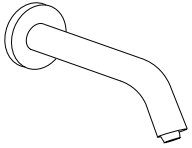

▲ Available Q4 2018

ECOPOWER
FAUCETS

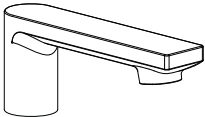
COMMERCIAL ECOPOWER® FAUCETS

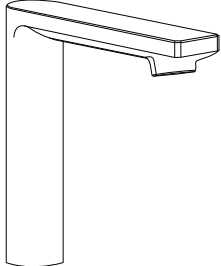
TEL123	PRODUCT NAME & DESCRIPTION	FINISH	PRODUCT NUMBER	PRICE	CUBES PALLET QTY.	APPROX. SHIP WT.		
	NEW HELIX® M ECOPOWER® FAUCET  CALGreen <ul style="list-style-type: none"> • Consists of spout and controller • Hydropower self-generating system • Sensor faucet with aerated flow • Self adjusting faucet with control box and mounting hardware, less supply lines • Single-hole mount • Equipped with 0.35 gpm flow control 							
		0.11 GPC, 20 SECS ON-DEMAND	POLISHED CHROME	TEL123-D20E#CP ▲	\$ 864		5.65 lbs.	
		0.11 GPC, 20 SECS ON-DEMAND MIXING VALVE	POLISHED CHROME	TEL123-D20EM#CP ▲	\$ 932		6.25 lbs.	
		0.11 GPC, 20 SECS ON-DEMAND THERMOSTATIC MIXING VALVE	POLISHED CHROME	TEL123-D20ET#CP ▲	\$ 1,107		6.45 lbs.	
		AVAILABLE COMPONENTS						
		SPOUT						
		HELIX M SPOUT	POLISHED CHROME	TELS123#CP ▲	\$ 476		25 lbs.	
		CONTROLLER						
		0.11 GPC, 20 SECS ON-DEMAND		TELC103-D20E ▲	\$ 388		3.05 lbs.	
		AVAILABLE VALVES						
MIXING VALVE		TLM10	\$ 68		0.6 lbs.			
	THERMOSTATIC MIXING VALVE		TLT20 ▲	\$ 243		1.2 lbs.		
	NEW HELIX WALL-MOUNT ECOPOWER FAUCET  CALGreen <ul style="list-style-type: none"> • Consists of spout and controller • Hydropower self-generating system • Sensor faucet with aerated flow • Self adjusting faucet with control box and mounting hardware, less supply lines • Single-hole mount • Equipped with 0.35 gpm flow control 							
		0.11 GPC, 20 SECS ON-DEMAND	POLISHED CHROME	TEL133-D20E#CP ▲	\$ 903		5.55 lbs.	
		0.11 GPC, 20 SECS ON-DEMAND MIXING VALVE	POLISHED CHROME	TEL133-D20EM#CP ▲	\$ 971		6.15 lbs.	
		0.11 GPC, 20 SECS ON-DEMAND THERMOSTATIC MIXING VALVE	POLISHED CHROME	TEL133-D20ET#CP ▲	\$ 1,146		5.45 lbs.	
		AVAILABLE COMPONENTS						
		SPOUT						
		HELIX M SPOUT	POLISHED CHROME	TELS133#CP ▲	\$ 515		2.5 lbs.	
		CONTROLLER						
		0.11 GPC, 20 SECS ON-DEMAND		TELC103-D20E ▲	\$ 388		3.05 lbs.	
		AVAILABLE VALVES						
MIXING VALVE		TLM10	\$ 68		0.6 lbs.			
	THERMOSTATIC MIXING VALVE		TLT20 ▲	\$ 243		1.2 lbs.		

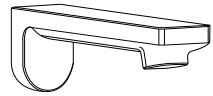



▲ Available Q4 2018

TEL1A3	PRODUCT NAME & DESCRIPTION	FINISH	PRODUCT NUMBER	PRICE	CUBES PALLET QTY.	APPROX. SHIP WT.	
	NEW LIBELLA™ ECOPOWER® FAUCET  CALGreen <ul style="list-style-type: none"> • Consists of spout and controller • Hydropower self-generating system • Sensor faucet with aerated flow • Self adjusting faucet with control box and mounting hardware, less supply lines • Single-hole mount • Equipped with 0.35 gpm flow control 						
		0.11 GPC, 20 SECS ON-DEMAND	POLISHED CHROME	TEL1A3-D20E#CP▲	\$ 854		6.05 lbs.
		0.11 GPC, 20 SECS ON-DEMAND MIXING VALVE	POLISHED CHROME	TEL1A3-D20EM#CP▲	\$ 922		6.65 lbs.
		0.11 GPC, 20 SECS ON-DEMAND THERMOSTATIC MIXING VALVE	POLISHED CHROME	TEL1A3-D20ET#CP▲	\$ 1,097		6.95 lbs.
		AVAILABLE COMPONENTS					
		SPOUT					
		LIBELLA SPOUT	POLISHED CHROME	TEL1A3#CP▲	\$ 466		3.0 lbs.
		CONTROLLER					
		0.11 GPC, 20 SECS ON-DEMAND		TELC103-D20E▲	\$ 388		3.05 lbs.
		AVAILABLE VALVES MIXING VALVE		TLM10	\$ 68		0.6 lbs.
NEW	THERMOSTATIC MIXING VALVE		TLT20▲	\$ 243		1.2 lbs.	
	NEW LIBELLA™ M ECOPOWER® FAUCET  CALGreen <ul style="list-style-type: none"> • Consists of spout and controller • Hydropower self-generating system • Sensor faucet with aerated flow • Self adjusting faucet with control box and mounting hardware, less supply lines • Single-hole mount • Equipped with 0.35 gpm flow control 						
		0.11 GPC, 20 SECS ON-DEMAND	POLISHED CHROME	TEL1B3-D20E#CP▲	\$ 949		7.35 lbs.
		0.11 GPC, 20 SECS ON-DEMAND MIXING VALVE	POLISHED CHROME	TEL1B3-D20EM#CP▲	\$ 1,017		7.95 lbs.
		0.11 GPC, 20 SECS ON-DEMAND THERMOSTATIC MIXING VALVE	POLISHED CHROME	TEL1B3-D20ET#CP▲	\$ 1,192		8.25 lbs.
		AVAILABLE COMPONENTS					
		SPOUT					
		LIBELLA M SPOUT	POLISHED CHROME	TEL1B3#CP▲	\$ 561		4.3 lbs.
		CONTROLLER					
		0.11 GPC, 20 SECS ON-DEMAND		TELC103-D20E▲	\$ 388		3.05 lbs.
		AVAILABLE VALVES MIXING VALVE		TLM10	\$ 68		0.6 lbs.
NEW	THERMOSTATIC MIXING VALVE		TLT20▲	\$ 243		1.2 lbs.	
	NEW LIBELLA™ WALL-MOUNT ECOPOWER® FAUCET  CALGreen <ul style="list-style-type: none"> • Consists of spout and controller • Hydropower self-generating system • Sensor faucet with aerated flow • Self adjusting faucet with control box and mounting hardware, less supply lines • Single-hole mount • Equipped with 0.35 gpm flow control 						
		0.11 GPC, 20 SECS ON-DEMAND	POLISHED CHROME	TEL1C3-D20E#CP▲	\$ 892		5.75 lbs.
		0.11 GPC, 20 SECS ON-DEMAND MIXING VALVE	POLISHED CHROME	TEL1C3-D20EM#CP▲	\$ 960		6.35 lbs.
		0.11 GPC, 20 SECS ON-DEMAND THERMOSTATIC MIXING VALVE	POLISHED CHROME	TEL1C3-D20ET#CP▲	\$ 1,135		6.65 lbs.
		AVAILABLE COMPONENTS					
		SPOUT					
		LIBELLA WALL-MOUNT M SPOUT	POLISHED CHROME	TEL1C3#CP▲	\$ 504		2.7 lbs.
		CONTROLLER					
		0.11 GPC, 20 SECS ON-DEMAND WALL-MOUNT		TELC103-D20E▲	\$ 388		3.05 lbs.
		AVAILABLE VALVES MIXING VALVE		TLM10	\$ 68		0.6 lbs.
NEW	THERMOSTATIC MIXING VALVE		TLT20▲	\$ 243		1.2 lbs.	

▲ Available Q4 2018

ECOPOWER
FAUCETS

COMMERCIAL
ECOPOWER® FAUCETS

TEL1D3	PRODUCT NAME & DESCRIPTION	FINISH	PRODUCT NUMBER	PRICE	CUBES PALLET QTY.	APPROX. SHIP WT.		
	NEW LIBELLA™ WALL-MOUNT M ECOPOWER® FAUCET  CALGreen <ul style="list-style-type: none"> • Consists of spout and controller • Hydropower self-generating system • Sensor faucet with aerated flow • Self adjusting faucet with control box and mounting hardware, less supply lines • Single-hole mount • Equipped with 0.35 gpm flow control 							
		0.11 GPC, 20 SECS ON-DEMAND	POLISHED CHROME	TEL1D3-D20E#CP ▲	\$949		5.95 lbs.	
		0.11 GPC, 20 SECS ON-DEMAND MIXING VALVE	POLISHED CHROME	TEL1D3-D20EM#CP ▲	\$1,017		6.55 lbs.	
		0.11 GPC, 20 SECS ON-DEMAND THERMOSTATIC MIXING VALVE	POLISHED CHROME	TEL1D3-D20ET#CP ▲	\$1,192		7.15 lbs.	
		AVAILABLE COMPONENTS						
		SPOUT						
		LIBELLA WALL-MOUNT M SPOUT	POLISHED CHROME	TELS1D3#CP ▲	\$561		2.9 lbs.	
		CONTROLLER						
		0.11 GPC, 20 SECS ON-DEMAND WALL-MOUNT		TELC103-D20E ▲	\$388		3.05 lbs.	
		AVAILABLE VALVES						
MIXING VALVE		TLM10	\$68		0.6 lbs.			
THERMOSTATIC MIXING VALVE		TLT20 ▲	\$243		1.2 lbs.			
	NEW STANDARD ECOPOWER FAUCET  CALGreen <ul style="list-style-type: none"> • Consists of spout and controller • Hydropower self-generating system • Sensor faucet with aerated flow • Self adjusting faucet with control box and mounting hardware, less supply line • Single-hole mount • Equipped with 0.35 gpm flow control 							
		0.11 GPC, 20 SECS ON-DEMAND	POLISHED CHROME	TEL103-D20E#CP ▲	\$670		5.45 lbs.	
		0.11 GPC, 20 SECS ON-DEMAND MIXING VALVE	POLISHED CHROME	TEL103-D20EM#CP ▲	\$737		6.23 lbs.	
		0.11 GPC, 20 SECS ON-DEMAND THERMOSTATIC MIXING VALVE	POLISHED CHROME	TEL103-D20ET#CP ▲	\$913		6.35 lbs.	
		AVAILABLE COMPONENTS						
		SPOUT						
		STANDARD SPOUT	POLISHED CHROME POLISHED NICKEL	TELS103#CP ▲ TELS103#PN ▲	\$282 \$353		2.4 lbs.	
		CONTROLLER						
		0.11 GPC, 20 SECS ON-DEMAND		TELC103-D20E ▲	\$388		325 lbs.	
		AVAILABLE VALVES						
		MIXING VALVE		TLM10	\$68		0.6 lbs.	
		THERMOSTATIC MIXING VALVE		TLT20 ▲	\$243		1.2 lbs.	
		AVAILABLE ACCESSORIES						
		4" CENTER COVER PLATE	POLISHED CHROME	THP3158#CP	\$47			
		8" CENTER COVER PLATE	POLISHED CHROME	THP3159#CP	\$88			

▲ Available Q4 2018

ECOPOWER
FAUCETS

TOTO PRODUCT NUMBER CHART TOILET, SEAT, URINAL, & LAVATORY

TOILET AND SEAT COMBINATION MODEL NUMBERS

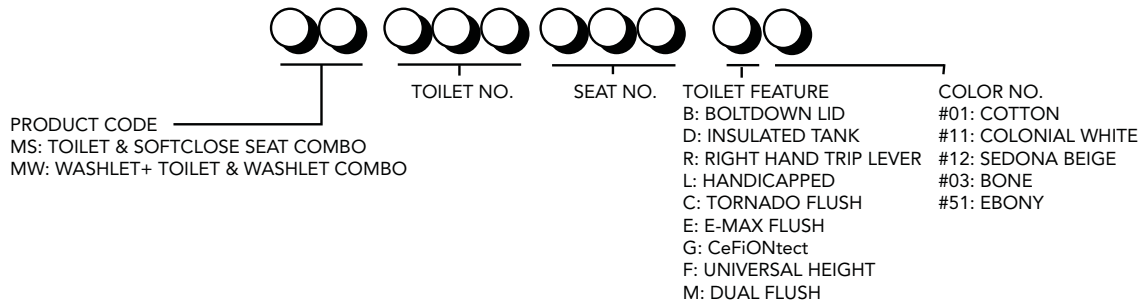

TOILET, URINAL AND LAVATORY MODEL NUMBERS

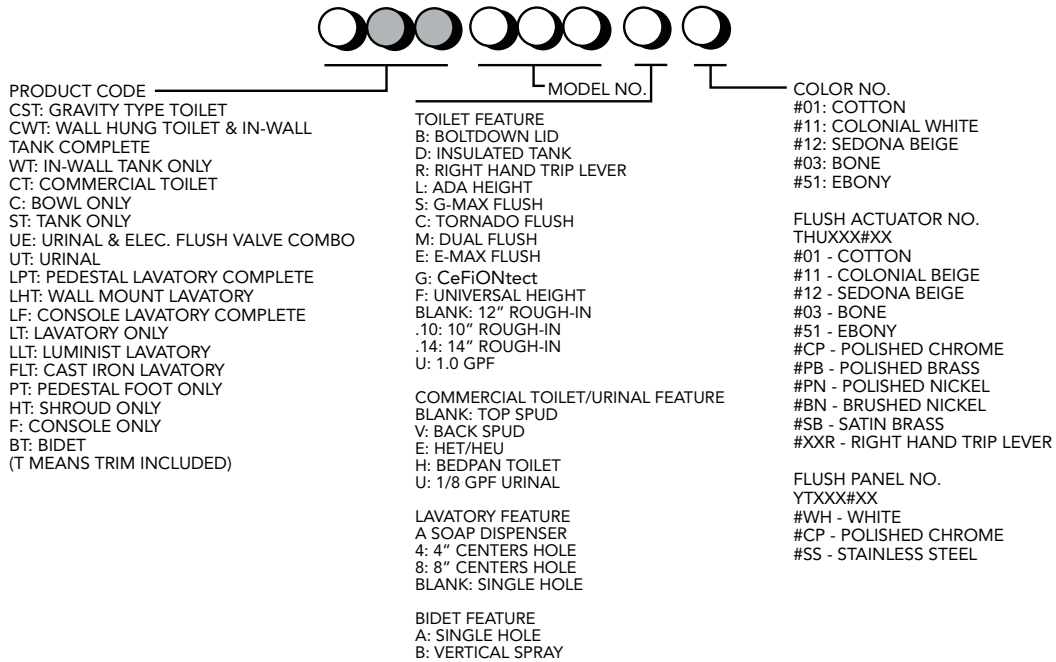

FEATURED SEAT MODEL NUMBERS

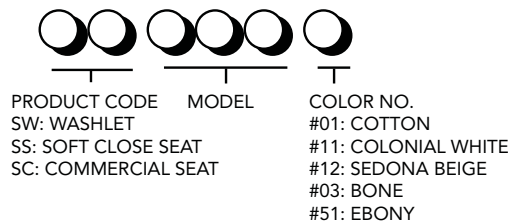

TOTO PRODUCT NUMBER CHART TUB

GLOBAL TUB MODEL NUMBERS

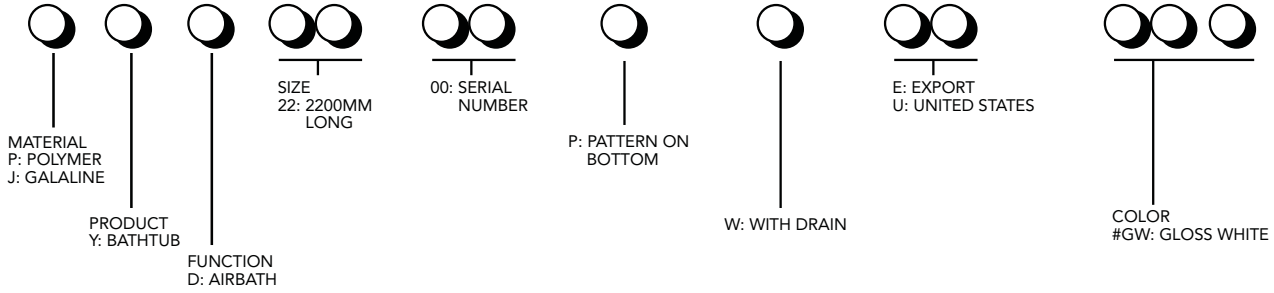

TOTO PRODUCT NUMBER CHART FAUCET, SHOWER & FLUSH VALVE

GLOBAL MODEL NUMBERS

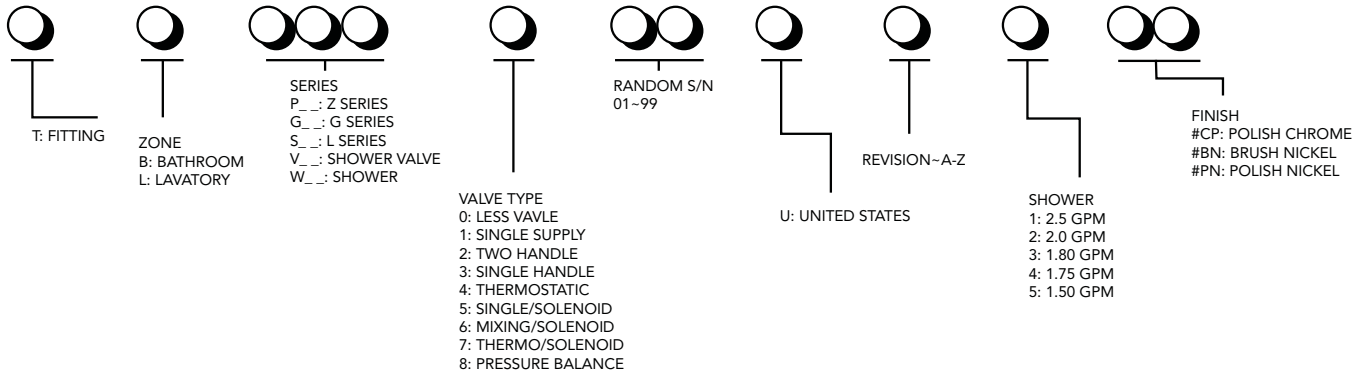

TOTO PRODUCT NUMBER CHART VALVES & ACCESSORIES

COMMERCIAL FLUSH VALVES MODEL NUMBERS

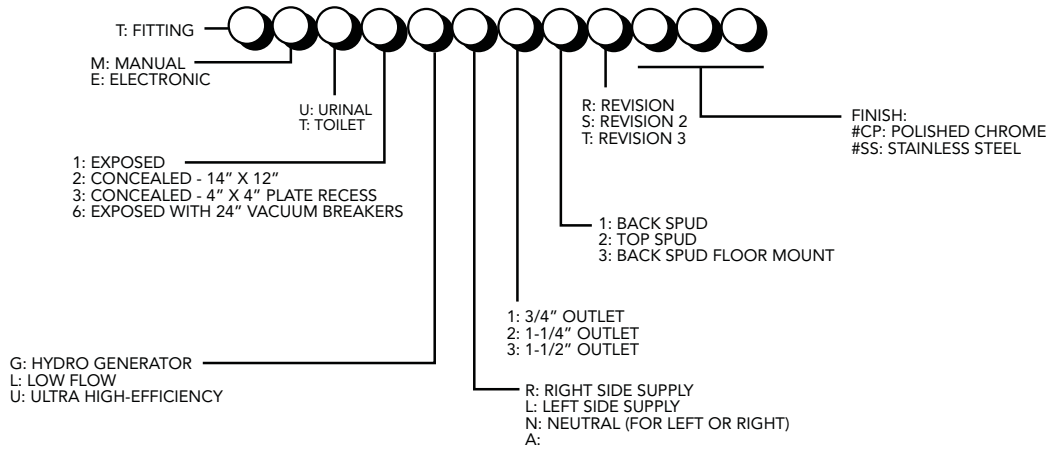

Standard Finish	Premium Finishes	
#CP - Polished Chrome	LifeKoat®	
	#BN - Brushed Nickel	#PN - Polished Nickel

Not all finishes are available on all products. Please refer to the actual product page to view the availability of individual product finishes.

TOTO PRODUCT NUMBER CHART COMMERCIAL FAUCETS & VALVES

COMMERCIAL FAUCETS KIT MODEL NUMBERS

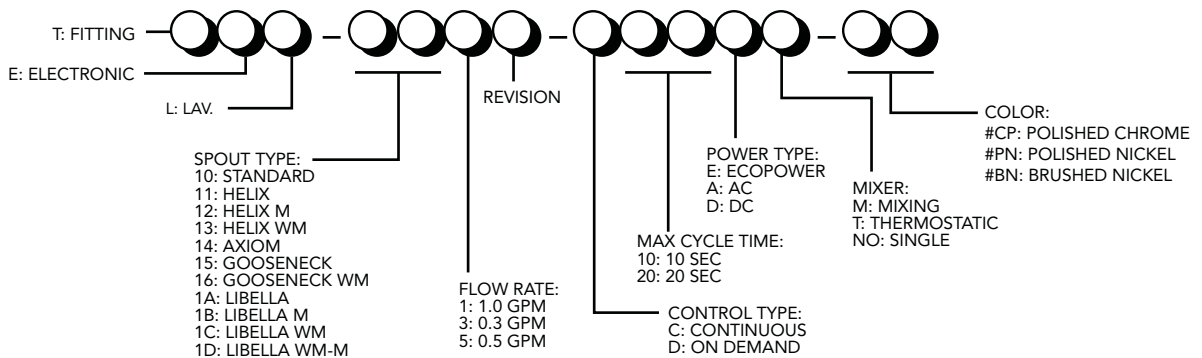

COMMERCIAL SPOUT MODEL NUMBERS

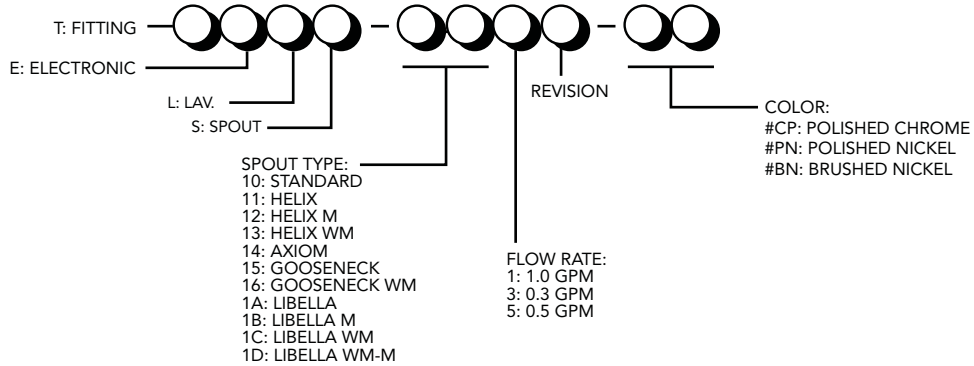

COMMERCIAL CONTROLLER MODEL NUMBERS

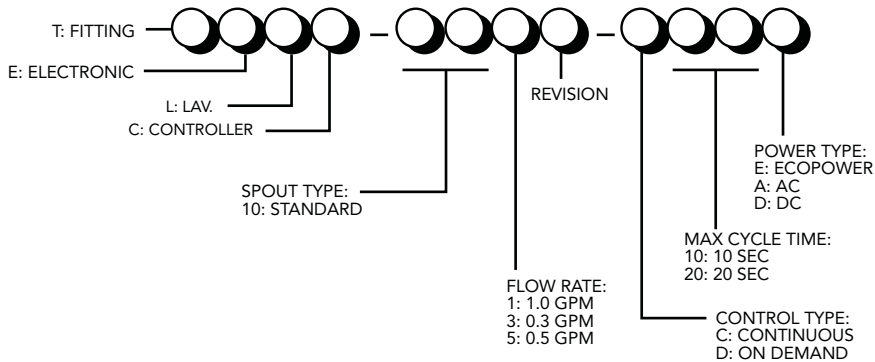

MIXING AND THERMOSTATIC VALVES MODEL NUMBERS

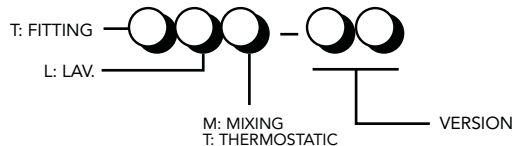

COLOR SELECTION

CROSS REFERENCE CHART

TOTO®			
WHITES	KOHLER® COMPATIBLE KOHLER colors are trademark of the KOHLER company	ELJER® COMPATIBLE ELJER colors are trademark of the ELJER company	AMERICAN STANDARD™ COMPATIBLE AMERICAN STANDARD colors are trademark of the AMERICAN STANDARD CO.
#01 COTTON	WHITE	WHITE	N/A
#11 COLONIAL WHITE	N/A	N/A	WHITE

TOTO®			
BASIC COLORS	KOHLER COMPATIBLE KOHLER colors are trademark of the KOHLER company	ELJER COMPATIBLE ELJER colors are trademark of the ELJER company	AMERICAN STANDARD COMPATIBLE AMERICAN STANDARD colors are trademark of the AMERICAN STANDARD CO.
#12 SEDONA BEIGE	BISCUIT	SILK	LINEN
#03 BONE	ALMOND™	NATURAL	BONE

TOTO®			
PREMIUM COLORS	KOHLER COMPATIBLE KOHLER colors are trademark of the KOHLER company	ELJER COMPATIBLE ELJER colors are trademark of the ELJER company	AMERICAN STANDARD COMPATIBLE AMERICAN STANDARD colors are trademark of the AMERICAN STANDARD CO.
#51 EBONY	BLACK BLACK™	ONYX	BLACK

THESE COLORS ARE TOTO® COLORS THAT ARE COMPATIBLE WITH THE LISTED KOHLER, AMERICAN STANDARD, OR ELJER COLORS. TOTO® DISCLAIMS ANY RIGHTS IN ANY COLOR DESCRIPTION TRADEMARKS THAT ARE OWNED BY KOHLER, AMERICAN STANDARD, OR ELJER.

TERMS & CONDITIONS

Prices: Prices in this price book are subject to change without notice and supersede all previous price books, lists and quotations. Possession of this price book is not to be construed as an offer to sell the products listed herein at the prices stated. Prices do not include installation, freight or taxes.

Payment

Order Minimum: An order for products for which prices aggregate less than \$50 net will be billed at \$50 net.

Terms of Payment: A 2% cash discount, on the amount of the invoice before any freight charges or applicable taxes, is allowed on invoices paid on or before the 30th day following the date of the invoice. All invoices not discounted are due net 60 days following the date of the invoice. All payments shall be made in U.S. Dollars.

Service Fee: If payment is not timely, TOTO® shall be entitled, in addition to other legal rights and to the extent permissible by applicable law, to a service fee of 1-1/2% per month (18% per annum) on any unpaid balances to cover additional administrative costs of collecting such balances.

Taxes: Prices are exclusive of any taxes. BUYER agrees to pay any applicable taxes, duty surcharges, fees or similar charges however imposed.

Acceptance of Orders: All orders are subject to approval and acceptance by TOTO®. Orders will be accepted only upon the understanding that the terms and conditions herein shall be applicable. Unless TOTO® so agrees in writing, any terms and conditions appearing in BUYER's order contrary to those stated herein are deemed waived by BUYER. After an order has been accepted, it may be modified or cancelled only upon the written agreement of TOTO®.

Credit Approval: BUYER's orders will be accepted subject to credit investigation and approval, and delivery may be withheld on accepted orders without any liability on the part of TOTO®, if, in its opinion, the BUYER's ability to pay for the products on these terms and conditions is in doubt. Any remittance received from or for the account of BUYER may be accepted or applied by TOTO® against any indebtedness owing by BUYER, without prejudice to or the discharge of the remainder of such indebtedness, regardless of any condition, provision, or notation appearing on such remittance. After delivery, if TOTO® brings legal action to collect amounts due and owing by BUYER, BUYER agrees to pay for all attorneys' fees and costs incurred by TOTO® in such action.

Shipment

Delivery: All shipment and freight terms are based on shipment within the continental United States, F.O.B. TOTO's® warehouse. Delivery to the carrier shall constitute delivery to the BUYER, all products are shipped at BUYER's risk. When specific shipping instructions are not provided by BUYER, TOTO® will use its discretion as to routing of shipment, based on the lowest rate medium of transportation. No freight allowances will be given on special express shipments without prior written consent of TOTO®.

Partial Shipments: Unless otherwise specified, TOTO® may make partial shipments and each shipment shall be deemed a separate sale. BUYER shall accept and pay for each shipment regardless of any prior or subsequent failure to deliver any other shipment.

Shipping Weights: Shipping weights are approximate, are shown for BUYER's convenience only, and are not guaranteed.

Acceptance: BUYER shall diligently inspect product upon arrival at specified destination and shall within 10 business days notify TOTO® as to any conditions which exist that prevent BUYER's acceptance of product. Failure to notify TOTO® of any such conditions with 10 days of such arrival shall result in acceptance of the products by BUYER.

Damage in Transit: All products are shipped at BUYER's risk. TOTO's® responsibility ceases upon the delivery of the products in good order to the carrier. Claims against the carrier are to be filed by the BUYER.

Substitution: TOTO® reserves the right at any time to replace or substitute products and packaging provided such replacement or substitution will not result in additional cost to BUYER and will not adversely affect operational performance of products.

Excusable Delay: TOTO® is not responsible or liable for any delays or any failure to perform due to unforeseen circumstances or causes beyond TOTO's® control, when such delay or failure is due, directly or indirectly, to acts of God, war (including civil war), riots, embargoes, acts (whether sovereign or contractual) of civil or military authorities, acts of any government, major change in economic conditions, fires, floods, explosions, the elements, epidemics, quarantine restrictions, strikes, lockouts, plant shutdowns, slowdowns, accidents, shortages of energy, materials, component parts, labor, or delays of suppliers or subcontractors. In the event of an excusable delay, TOTO® shall promptly notify the BUYER of such delay and an equitable adjustment shall be made in delivery schedules and any other affected terms and conditions.

Returned Products

Returned Products: Products can not be returned without the prior written approval of TOTO®. If products which are returned with TOTO's® written approval are in TOTO's® opinion salable, credit will be issued at the original net invoice price, less the actual cost of restocking, as determined by TOTO®, but in no event will the restocking fee be less than 25% of the original net invoice price. Returned product which is damaged, used, or otherwise not in salable condition, will not be eligible for credit.

General Terms & Conditions

Limitation of Liability: TOTO's® liability for any and all claims of any kind, including negligence, for any loss or damage arising out of, connected with or resulting from TOTO's® performance or breach of the terms hereof shall, in the aggregate, not exceed the purchase price of the particular product. IN NO EVENT SHALL TOTO® BE LIABLE FOR INDIRECT, SPECIAL, INCIDENTAL OR CONSEQUENTIAL DAMAGES RESULTING FROM OR ARISING OUT OF PERFORMANCE, OF OR FAILURE TO PERFORM ITS OBLIGATIONS HEREUNDER, WHETHER OR NOT TOTO® HAD BEEN ADVISED OF, KNEW, OR SHOULD HAVE KNOWN OF THE POSSIBILITY OF SUCH DAMAGES.

Severability: If any portion or provision of these terms applicable to any situation or circumstance is held invalid, the remainder of these terms or the remainder of such provision (as the case may be), and the application thereof to other situations or circumstances shall not be affected thereby.

Waiver: Waiver by TOTO® of any breach of these provisions shall not be construed as a waiver of any other breach.

Assignment: None of the BUYER's rights under these terms shall be assigned or otherwise transferred by the BUYER to any other person, whether by operation of law or otherwise, without TOTO's® prior written approval.

Law and Arbitration: These terms are governed by the laws of the State of Georgia. Any controversy or claim arising out of or relating to these terms or the breach hereof shall be finally settled by arbitration in Clayton County, Georgia in accordance with the prevailing commercial rules of the American Arbitration Association, and the parties shall have the right to take depositions and obtain discovery regarding the subject matter of the arbitration as if the subject matter of the arbitration were pending in a civil action before a Superior Court of the State of Georgia. Pending decision by the arbitrator(s), the parties shall diligently proceed pursuant to the terms and conditions hereof. The award of the arbitrator(s) shall be final, binding and conclusive on the parties hereto and their successors and assigns. Judgment upon an arbitration award hereunder may be entered in any court having jurisdiction thereof or application may be made to any court for individual acceptance of the award or an order of enforcement, as the case may be.

Entirety of Agreement: These terms are intended as a complete and exclusive statement of the terms and conditions of their agreement. No other terms and conditions, whether contained in BUYER's purchase order, shipping release or elsewhere that are inconsistent with, additional to, or different from the terms and conditions herein shall be binding upon TOTO® unless specifically agreed to by TOTO® in writing.

Assent: Receipt by BUYER of acceptance of the order or receipt of the products without prompt objection to the terms and conditions herein set forth, constitutes acceptance by BUYER of these terms and conditions.

WARRANTY CHART

	RESIDENTIAL - USE	COMMERCIAL - USE
NEOREST®	3 YEARS	1 YEAR
ECOPOWER FAUCETS EFV (EXCLUDE LLOYD EFV) AUTO SOAP DISPENSER	N/A	3 YEARS
CAST IRON TUB RESIDENTIAL FAUCET / SHOWER ACCESSORY	Limited Lifetime	1 YEAR
TOILETS BIDETS URINALS TOILET SEATS LAVATORIES WASHLET ACRYLIC TUBS HAND DRYERS ALL PARTS	1 YEAR	1 YEAR

NOTE: Please refer to the present owners manual and spec sheet for detailed description by product.

One Year Limited Warranty

Warranty applies to select vitreous china, WASHLET, airbaths, and hand dryers.

1. TOTO warrants its plumbing products ("Product") to be free from defects in materials and workmanship during normal use when properly installed and serviced, for a period of one (1) year from date of purchase. This limited warranty is extended only to the ORIGINAL PURCHASER of the Product and is not transferable to any third party, including but not limited to any subsequent purchaser or owner of the Product. This warranty applies only to TOTO Product purchased and installed in North, Central and South America.
2. TOTO's obligations under this warranty are limited to repair, replacement or other appropriate adjustment, at TOTO's option, of the Product or parts found to be defective in normal use, provided that such Product was properly installed, used and serviced in accordance with instructions. TOTO reserves the right to make such inspections as may be necessary in order to determine the cause of the defect. TOTO will not charge for labor or parts in connection with warranty repairs or replacements. TOTO is not responsible for the cost of removal, return and/or reinstallation of the Product.
3. This warranty does not apply to the following items:
 - a. Damage or loss sustained in a natural calamity such as fire, earthquake, flood, thunder, electrical storm, etc.
 - b. Damage or loss resulting from any accident, unreasonable use, misuse, abuse, negligence, or improper care, cleaning, or maintenance of the Product.
 - c. Damage or loss resulting from sediments or foreign matter contained in a water system.
 - d. Damage or loss resulting from improper installation or from installation of the Product in a harsh and/or hazardous environment, or improper removal, repair or modification of the Product. (NOTE: Product model codes allow a maximum of 80 PSI. Check local codes or standards for requirements).
 - e. Damage or loss resulting from electrical surges or lightning strikes or other acts which are not the fault of TOTO or which the Product is not specified to tolerate.
 - f. Damage or loss resulting from normal and customary wear and tear, such as gloss reduction, scratching or fading over time due to use, cleaning practices or water or atmospheric condition, including but not limited to, the use of bleach, alkali, acid cleaners, dry (powder) cleaners or any other abrasive cleaners or the use of metal or nylon scrubbers.
 - g. The use of any Product in a manner inconsistent with the Product instructions / owners manual.
4. In order for this limited warranty to be valid, proof of purchase is required. TOTO encourages warranty registration upon purchase to create a record of Product ownership at <http://www.totousa.com>. Product registration is completely voluntary and failure to register will not diminish your limited warranty rights.
5. THIS WARRANTY GIVES YOU SPECIFIC LEGAL RIGHTS. YOU MAY HAVE OTHER RIGHTS WHICH VARY FROM STATE TO STATE, PROVINCE TO PROVINCE OR COUNTRY TO COUNTRY.
6. To obtain warranty repair service under this warranty, you must take the Product or deliver it prepaid to a TOTO service facility together with proof of purchase (original sales receipt) and a letter stating the problem, or contact a TOTO distributor or products service contractor, or write directly to TOTO U.S.A., INC., 1155 Southern Road, Morrow, GA 30260 (888) 295 8134 or (678) 466-1300, if outside the U.S.A. If, because of the size of the Product or nature of the defect, the Product cannot be returned to TOTO, receipt by TOTO of written notice of the defect together with proof of purchase (original sales receipt) shall constitute delivery. In such case, TOTO may choose to repair the Product at the purchaser's location or pay to transport the Product to a service facility.

WARNING! TOTO shall not be responsible or liable for any failure of, or damage to, this Product caused by either chloramines in the treatment of public water supply or cleaners containing chlorine (calcium hypochlorite). NOTE: The use of a high concentrate chlorine or chlorine related products can seriously damage the fittings. This damage can cause leakage and serious property damage.

THIS WRITTEN WARRANTY IS THE ONLY WARRANTY MADE BY TOTO. REPAIR, REPLACEMENT OR OTHER APPROPRIATE ADJUSTMENT AS PROVIDED UNDER THIS WARRANTY SHALL BE THE EXCLUSIVE REMEDY AVAILABLE TO THE ORIGINAL PURCHASER. TOTO SHALL NOT BE RESPONSIBLE FOR LOSS OF THE PRODUCT OR FOR OTHER INCIDENTAL, SPECIAL OR CONSEQUENTIAL DAMAGES OR EXPENSES INCURRED BY THE ORIGINAL PURCHASER, OR FOR LABOR OR OTHER COSTS DUE TO INSTALLATION OR REMOVAL, OR COSTS OF REPAIRS BY OTHERS, OR FOR ANY OTHER EXPENSE NOT SPECIFICALLY STATED ABOVE. IN NO EVENT WILL TOTO'S RESPONSIBILITY EXCEED THE PURCHASE PRICE OF THE PRODUCT. EXCEPT TO THE EXTENT PROHIBITED BY APPLICABLE LAW, ANY IMPLIED WARRANTIES, INCLUDING THAT OF MERCHANTABILITY OR FITNESS FOR USE OR FOR A PARTICULAR PURPOSE, ARE EXPRESSLY DISCLAIMED. SOME STATES DO NOT ALLOW LIMITATIONS ON HOW LONG AN IMPLIED WARRANTY LASTS, OR THE EXCLUSION OR LIMITATION OF INCIDENTAL OR CONSEQUENTIAL DAMAGES, SO THE ABOVE LIMITATION AND EXCLUSION MAY NOT APPLY TO YOU.

TOTO WARRANTY

Three Year Limited Warranty

Warranty applies to select Electronic Flush Valves, Faucets and Soap Dispenser.

1. TOTO warrants its electronic flush valves, faucets and soap dispensers ("Product") to be free from defects in materials and workmanship during normal use when properly installed and serviced, for a period of three (3) years from date of purchase. This limited warranty is extended only to the ORIGINAL PURCHASER of the Product and is not transferable to any third party, including but not limited to any subsequent purchaser or owner of the Product. This warranty applies only to TOTO Product purchased and installed in North, Central and South America.
2. TOTO's obligations under this warranty are limited to repair, replacement or other appropriate adjustment, at TOTO's option, of the Product or parts found to be defective in normal use, provided that such Product was properly installed, used and serviced in accordance with instructions. TOTO reserves the right to make such inspections as may be necessary in order to determine the cause of the defect. TOTO will not charge for labor or parts in connection with warranty repairs or replacements. TOTO is not responsible for the cost of removal, return and/or reinstallation of the Product.
3. This warranty does not apply to the following items:
 - a. Damage or loss sustained in a natural calamity such as fire, earthquake, flood, thunder, electrical storm, etc.
 - b. Damage or loss resulting from any accident, unreasonable use, misuse, abuse, negligence, or improper care, cleaning, or maintenance of the Product.
 - c. Damage or loss resulting from sediments or foreign matter contained in a water system.
 - d. Damage or loss resulting from improper installation or from installation of the Product in a harsh and/or hazardous environment, or improper removal, repair or modification of the Product.
 - e. Damage or loss resulting from electrical surges or lightning strikes or other acts which are not the fault of TOTO or which the Product is not specified to tolerate.
 - f. Damage or loss resulting from normal and customary wear and tear, such as gloss reduction, scratching or fading over time due to use, cleaning practices or water or atmospheric conditions, including but not limited to, the use of bleach, alkali, acid cleaners, dry (powder) cleaners or any other abrasive cleaners or the use of metal or nylon scrubbers.
4. In order for this limited warranty to be valid, proof of purchase is required. TOTO encourages warranty registration upon purchase to create a record of Product ownership at <http://www.totousa.com>. Product registration is completely voluntary and failure to register will not diminish your limited warranty rights.
5. THIS WARRANTY GIVES YOU SPECIFIC LEGAL RIGHTS. YOU MAY HAVE OTHER RIGHTS WHICH VARY FROM STATE TO STATE, PROVINCE TO PROVINCE OR COUNTRY TO COUNTRY.
6. To obtain warranty repair service under this warranty, you must take the Product or deliver it prepaid to a TOTO service facility together with proof of purchase (original sales receipt) and a letter stating the problem, or contact a TOTO distributor or products service contractor, or write directly to TOTO U.S.A., INC., 1155 Southern Road, Morrow, GA 30260 (888) 295 8134 or (678) 466-1300, if outside the U.S.A. If, because of the size of the Product or nature of the defect, the Product cannot be returned to TOTO, receipt by TOTO of written notice of the defect together with proof of purchase (original sales receipt) shall constitute delivery. In such case, TOTO may choose to repair the Product at the purchaser's location or pay to transport the Product to a service facility.

THIS WRITTEN WARRANTY IS THE ONLY WARRANTY MADE BY TOTO. REPAIR, REPLACEMENT OR OTHER APPROPRIATE ADJUSTMENT AS PROVIDED UNDER THIS WARRANTY SHALL BE THE EXCLUSIVE REMEDY AVAILABLE TO THE ORIGINAL PURCHASER. TOTO SHALL NOT BE RESPONSIBLE FOR LOSS OF THE PRODUCT OR FOR OTHER INCIDENTAL, SPECIAL OR CONSEQUENTIAL DAMAGES OR EXPENSES INCURRED BY THE ORIGINAL PURCHASER, OR FOR LABOR OR OTHER COSTS DUE TO INSTALLATION OR REMOVAL, OR COSTS OF REPAIRS BY OTHERS, OR FOR ANY OTHER EXPENSE NOT SPECIFICALLY STATED ABOVE. IN NO EVENT WILL TOTO'S RESPONSIBILITY EXCEED THE PURCHASE PRICE OF THE PRODUCT. EXCEPT TO THE EXTENT PROHIBITED BY APPLICABLE LAW, ANY IMPLIED WARRANTIES, INCLUDING THAT OF MERCHANTABILITY OR FITNESS FOR USE OR FOR A PARTICULAR PURPOSE, ARE EXPRESSLY DISCLAIMED. SOME STATES DO NOT ALLOW LIMITATIONS ON HOW LONG AN IMPLIED WARRANTY LASTS, OR THE EXCLUSION OR LIMITATION OF INCIDENTAL OR CONSEQUENTIAL DAMAGES, SO THE ABOVE LIMITATION AND EXCLUSION MAY NOT APPLY TO YOU.

Three Year Limited Warranty

1. TOTO warrants its Neorest brand products ("Product") to be free from defects in materials and workmanship during normal use when properly installed and serviced, for a period of three (3) years from date of purchase. This limited warranty is extended only to the ORIGINAL PURCHASER of the Product and is not transferable to any third party, including but not limited to any subsequent purchaser or owner of the Product. This warranty applies only to TOTO Product purchased and installed in North, Central and South America.
2. TOTO's obligations under this warranty are limited to repair, replacement or other appropriate adjustment, at TOTO's option, of the Product or parts found to be defective in normal use, provided that such Product was properly installed, used and serviced in accordance with instructions. TOTO reserves the right to make such inspections as may be necessary in order to determine the cause of the defect. TOTO will not charge for labor or parts in connection with warranty repairs or replacements. TOTO is not responsible for the cost of removal, return and/or re-installation of the Product.
3. This warranty does not apply to the following items:
 - a. Damage or loss sustained in a natural calamity such as fire, earthquake, flood, thunder, electrical storm, etc.
 - b. Damage or loss resulting from any accident, unreasonable use, misuse, abuse, negligence, or improper care, cleaning, or maintenance of the Product.
 - c. Damage or loss resulting from sediments or foreign matter contained in a water system.
 - d. Damage or loss resulting from improper installation or from installation of the Product in a harsh and/or hazardous environment, or improper removal, repair or modification of the Product. This includes locations where the water pressure is above local codes or standards. (NOTE: Product model codes allow a maximum of 80 PSI. Check local codes or standards for requirements).
 - e. Damage or loss resulting from electrical surges or lightning strikes or other acts which are not the fault of TOTO or which the Product is not specified to tolerate, including failure to use the factory equipped cord and plug or use of a loose or faulty electrical outlet or use of a current or socket other than a 120V, 60Hz electrical current from a GFI (ground, fused) socket.
 - f. Damage or loss resulting from normal and customary wear and tear, such as gloss reduction, scratching or fading over time due to use, cleaning practices or water or atmospheric conditions, including but not limited to, the use of bleach, alkali, acid cleaners, dry (powder) cleaners or any other abrasive cleaners or the use of metal or nylon scrubbers.
4. If the Danger Label which has been placed over the seams on the back of the Product's top unit is broken or otherwise not intact, this limited warranty is void.
5. In order for this limited warranty to be valid, proof of purchase is required. TOTO encourages warranty registration upon purchase to create a record of Product ownership at <http://www.totousa.com>. Product registration is completely voluntary and failure to register will not diminish your limited warranty rights.
6. If the Product is used commercially or is installed outside of North, Central or South America, TOTO warrants the Product to be free from defects in materials and workmanship during normal use for one (1) year from the date of installation of the Product, and all other terms of this warranty shall be applicable except the duration of the warranty.
7. THIS WARRANTY GIVES YOU SPECIFIC LEGAL RIGHTS. YOU MAY HAVE OTHER RIGHTS WHICH VARY FROM STATE TO STATE, PROVINCE TO PROVINCE OR COUNTRY TO COUNTRY.
8. To obtain warranty repair service under this warranty, you must take the Product or deliver it prepaid to a TOTO service facility together with proof of purchase (original sales receipt) and a letter stating the problem, or contact a TOTO distributor or products service contractor, or write directly to TOTO U.S.A., INC., 1155 Southern Road, Morrow, GA 30260 (888) 295 8134 or (678) 466-1300, if outside the U.S.A. If, because of the size of the Product or nature of the defect, the Product cannot be returned to TOTO, receipt by TOTO of written notice of the defect together with proof of purchase (original sales receipt) shall constitute delivery. In such case, TOTO may choose to repair the Product at the purchaser's location or pay to transport the Product to a service facility.

WARNING! TOTO shall not be responsible or liable for any failure of, or damage to, this Product caused by either chloramines in the treatment of public water supply or cleaners containing chlorine (calcium hypochlorite). NOTE: The use of a high concentrate chlorine or chlorine related products can seriously damage the fittings. This damage can cause leakage and serious property damage.

THIS WRITTEN WARRANTY IS THE ONLY WARRANTY MADE BY TOTO. REPAIR, REPLACEMENT OR OTHER APPROPRIATE ADJUSTMENT AS PROVIDED UNDER THIS WARRANTY SHALL BE THE EXCLUSIVE REMEDY AVAILABLE TO THE ORIGINAL PURCHASER. TOTO SHALL NOT BE RESPONSIBLE FOR LOSS OF THE PRODUCT OR FOR OTHER INCIDENTAL, SPECIAL OR CONSEQUENTIAL DAMAGES OR EXPENSES INCURRED BY THE ORIGINAL PURCHASER, OR FOR LABOR OR OTHER COSTS DUE TO INSTALLATION OR REMOVAL, OR COSTS OF REPAIRS BY OTHERS, OR FOR ANY OTHER EXPENSE NOT SPECIFICALLY STATED ABOVE. IN NO EVENT WILL TOTO'S RESPONSIBILITY EXCEED THE PURCHASE PRICE OF THE PRODUCT. EXCEPT TO THE EXTENT PROHIBITED BY APPLICABLE LAW, ANY IMPLIED WARRANTIES, INCLUDING THAT OF MERCHANTABILITY OR FITNESS FOR USE OR FOR A PARTICULAR PURPOSE, ARE EXPRESSLY DISCLAIMED. SOME STATES DO NOT ALLOW LIMITATIONS ON HOW LONG AN IMPLIED WARRANTY LASTS, OR THE EXCLUSION OR LIMITATION OF INCIDENTAL OR CONSEQUENTIAL DAMAGES, SO THE ABOVE LIMITATION AND EXCLUSION MAY NOT APPLY TO YOU.

Limited Lifetime Warranty

Warranty applies to select decorative faucets, cast iron tubs and accessories only.

1. TOTO warrants its residential faucets, cast iron tubs and bathroom accessories ("Product") to be free from defects in materials and workmanship during normal use when properly installed and serviced, for the lifetime of the Product from date of purchase. This limited warranty is extended only to the ORIGINAL PURCHASER of the Product and is not transferable to any third party, including but not limited to any subsequent purchaser or owner of the Product. This warranty applies only to TOTO Product purchased and installed in North, Central and South America.
2. TOTO's obligations under this warranty are limited to repair, replacement or other appropriate adjustment, at TOTO's option, of the Product or parts found to be defective in normal use, provided that such Product was properly installed, used and serviced in accordance with instructions. TOTO reserves the right to make such inspections as may be necessary in order to determine the cause of the defect. TOTO will not charge for labor or parts in connection with warranty repairs or replacements. TOTO is not responsible for the cost of removal, return and/or re-installation of the Product.
3. This warranty does not apply to the following items:
 - a. Damage or loss sustained in a natural calamity such as fire, earthquake, flood, thunder, electrical storm, etc.
 - b. Damage or loss resulting from any accident, unreasonable use, misuse, abuse, negligence, or improper care, cleaning, or maintenance of the Product.
 - c. Damage or loss resulting from sediments or foreign matter contained in a water system.
 - d. Damage or loss resulting from improper installation or from installation of the Product in a harsh and/or hazardous environment, or improper removal, repair or modification of the Product.
 - e. Damage or loss resulting from electrical surges or lightning strikes or other acts which are not the fault of TOTO or which the Product is not specified to tolerate.
 - f. Damage or loss resulting from normal and customary wear and tear, such as gloss reduction, scratching or fading over time due to use, cleaning practices or water or atmospheric conditions, including but not limited to, the use of bleach, alkali, acid cleaners, dry (powder) cleaners or any other abrasive cleaners or the use of metal or nylon scrubbers.
4. In order for this limited warranty to be valid, proof of purchase is required. TOTO encourages warranty registration upon purchase to create a record of Product ownership at <http://www.totousa.com>. Product registration is completely voluntary and failure to register will not diminish your limited warranty rights.
5. If the Product is used commercially or is installed outside of North, Central or South America, TOTO warrants the Product to be free from defects in materials and workmanship during normal use for one (1) year from the date of installation of the Product, and all other terms of this warranty shall be applicable except the duration of the warranty.
6. All Products which consist of a powder-coated finish are warranted, with respect to finish only, for one (1) year from the date of installation of the Product. All other terms of this warranty and any limitations thereof, except as to finish, shall be applicable.
7. THIS WARRANTY GIVES YOU SPECIFIC LEGAL RIGHTS. YOU MAY HAVE OTHER RIGHTS WHICH VARY FROM STATE TO STATE, PROVINCE TO PROVINCE OR COUNTRY TO COUNTRY.
8. To obtain warranty repair service under this warranty, you must take the Product or deliver it prepaid to a TOTO service facility together with proof of purchase (original sales receipt) and a letter stating the problem, or contact a TOTO distributor or products service contractor, or write directly to TOTO U.S.A., INC., 1155 Southern Road, Morrow, GA 30260 (888) 295 8134 or (678) 466-1300, if outside the U.S.A. If, because of the size of the Product or nature of the defect, the Product cannot be returned to TOTO, receipt by TOTO of written notice of the defect together with proof of purchase (original sales receipt) shall constitute delivery. In such case, TOTO may choose to repair the Product at the purchaser's location or pay to transport the Product to a service facility.

THIS WRITTEN WARRANTY IS THE ONLY WARRANTY MADE BY TOTO. REPAIR, REPLACEMENT OR OTHER APPROPRIATE ADJUSTMENT AS PROVIDED UNDER THIS WARRANTY SHALL BE THE EXCLUSIVE REMEDY AVAILABLE TO THE ORIGINAL PURCHASER. TOTO SHALL NOT BE RESPONSIBLE FOR LOSS OF THE PRODUCT OR FOR OTHER INCIDENTAL, SPECIAL OR CONSEQUENTIAL DAMAGES OR EXPENSES INCURRED BY THE ORIGINAL PURCHASER, OR FOR LABOR OR OTHER COSTS DUE TO INSTALLATION OR REMOVAL, OR COSTS OF REPAIRS BY OTHERS, OR FOR ANY OTHER EXPENSE NOT SPECIFICALLY STATED ABOVE. IN NO EVENT WILL TOTO'S RESPONSIBILITY EXCEED THE PURCHASE PRICE OF THE PRODUCT, EXCEPT TO THE EXTENT PROHIBITED BY APPLICABLE LAW. ANY IMPLIED WARRANTIES, INCLUDING THAT OF MERCHANTABILITY OR FITNESS FOR USE OR FOR A PARTICULAR PURPOSE, ARE EXPRESSLY DISCLAIMED. SOME STATES DO NOT ALLOW LIMITATIONS ON HOW LONG AN IMPLIED WARRANTY LASTS, OR THE EXCLUSION OR LIMITATION OF INCIDENTAL OR CONSEQUENTIAL DAMAGES, SO THE ABOVE LIMITATION AND EXCLUSION MAY NOT APPLY TO YOU.

TOTO®

TOTO USA, INC.

1155 SOUTHERN ROAD
MORROW, GA 30260

Tel. 888-295-8134 Fax. 800-699-4889

www.totousa.com

www.washlet.com

#L072018-PB

Printed in the U.S.A. 07/18