



HAND FORGED IRON PRICE LIST EFFECTIVE MAY 1, 2018

TABLE OF CONTENTS

	<u>Page</u>
<u>IMPORTANT INFORMATION</u>	3
<u>UPCHARGES (THICK DOOR & OTHERS)</u>	4
<u>EXTERIOR HARDWARE:</u>	
THUMBLATCH x STRIKE-BAR LATCH ENTRY SETS	5
THUMBLATCH x LEVER OR KNOB ENTRY SETS	8
THUMBLATCH x THUMBLATCH ENTRY SETS	11
FIXED GRIP + DEADBOLT ENTRY SETS	15
LEVER OR KNOB ENTRY SETS (MORTISE AND TUBULAR)	18
SECTIONAL LEVER OR KNOB DEADBOLT ENTRY SETS	21
DEADBOLTS ONLY	24
STRIKE-BAR LATCH ENTRY SETS	26
MULTIPOINT HARDWARE	29
SLIDING DOOR HARDWARE	31
<u>INTERIOR HARDWARE:</u>	
PASSAGE/ PRIVACY/ DUMMY SETS	33
PETITE SERIES PASSAGE/ PRIVACY/ DUMMY SETS	38
PRIVACY MORTISE BOLTS	39
STRIKE-BAR LATCH PASSAGE/ PRIVACY/ DUMMY SETS	41
POCKET DOOR HARDWARE	43
SCREEN DOOR HARDWARE	44
DOOR/ APPLIANCE PULLS	45
PUSH PLATES	50
<u>ACCESSORIES:</u>	
DUMMY STRAPS & BRACES	51
STRAP HINGES	52
PINTLE (GRAVITY) HINGES - DOOR & CABINET	53
SURFACE & CANE BOLTS	54
DOOR KNOCKERS	56
SPEAKEASY GRILLES & LATCHES	57
CLAVOS	58
DOOR STOPS & HOOKS-AND-EYE	59
DOOR BELL BUTTONS	60
SWITCH-PLATE COVERS	61
WINDOW HARDWARE	63
LIGHT SCONCE COVERS	64
<u>KITCHEN & BATH:</u>	
CABINET KNOBS & PULLS	65
DECORATIVE RING PULLS	71
BATH HARDWARE	72
HOSPITALITY HARDWARE	74

THIS

PAGE

BLANK



HAND FORGED IRON PRICE LIST EFFECTIVE MAY 1, 2018

NOTE:

- 1) **ALL PRICES LIST**
- 2) **ALL PRICES INCLUDE ALL NECESSARY LOCKS AND COMPONENTS**
- 3) **ALL SETS ARE PRICED BY CHOICE OF ESCUTCHEON**
- 4) **ALL LEVERS & KNOBS ARE PRICED THE SAME**
- 5) **ALL PATINAS (FINISHES) ARE PRICED THE SAME**
- 6) UPCHARGES FOR DOORS THICKER THAN 1.75": SEE UPCHARGES ON PAGE 2
- 7) DOORS LESS THAN 1.75" THICK? IRON ESCUTCHEONS WILL NOT WORK! CONTACT US
- 8) WE DO NOT KEY ALIKE BY DEFAULT. SEE UPCHARGES ON PAGE 2 FOR KEYED ALIKE
- 9) SEE GLOSSARY ON THIS PAGE FOR CODES
- 10) PRICES SUBJECT TO CHANGE AT ANY TIME
- 11) HR IS NOT RESPONSIBLE FOR TYPOGRAPHICAL ERRORS

SUMMARY TERMS OF SALE:

- 1) There is no minimum order. Hardware Renaissance reserves the right to refuse any order in whole or part.
- 2) Orders once placed and confirmed by Hardware Renaissance may not be changed or cancelled without the approval of Hardware Renaissance. Cancellations are subject to a 35% restocking fee.
- 3) LEAD TIMES are 6-8 weeks for standard products, and up to 12 weeks for custom.
We offer a Rush option on some standard products for an upcharge. Contact us for details.
- 4) All sales are FOB Santa Fe NM USA. All orders will be shipped prepaid and added to the invoice.
- 5) Drop-shipment requests are subject to Hardware Renaissance's DROP SHIPMENT POLICY.
- 6) Returns are acceptable only for defects or errors for which Hardware Renaissance is responsible, and must be accompanied by an RGA requested in advance. All RGA's expire 60 days after issuance.
- 7) Returns of standard hardware, requested within 30 days of invoice date, are at the discretion of Hardware Renaissance and subject to a 35% restocking fee.
- 8) There are NO RETURNS on Multipoint & Sliding Door Hardware.
- 9) There are NO RETURNS on custom products.

GLOSSARY OF FUNCTIONS & LOCK TYPES:

FUNCTIONS:

EN	Entry (Keyed)
PT	Patio
FD	Full Dummy
SD	Single Dummy
AD	Active Dummy
PP	Passage
PR	Privacy

LOCK TYPES:

ML	Mortise Lock
MD	Mortise Deadbolt
DB	Tubular Deadbolt
SC	Single Cylinder
DC	Double Cylinder
TL	Tubular Latch
PMB	Privacy Mortise Bolt

UPCHARGES (ALL UPCHARGES ARE NET)

THICK DOOR UPCHARGES:

(If your door is in between, choose the next higher door thickness)

Door Thickness	Mortise Lock Sets	Mortise Deadbolt Sets (Strike-bar latch)	Tubular Deadbolt Sets
1.75"	NONE	NONE	NONE
2"	\$ 20.00	NONE	NONE
2.25"	\$ 26.00	\$ 10.00	\$ 6.00
2.5"	\$ 46.00	\$ 32.00	\$ 6.00
2.75"	\$ 50.00	\$ 32.00	\$ 6.00
3"	\$ 56.00	\$ 38.00	\$ 6.00
3.25"	\$ 56.00	\$ 38.00	\$ 6.00
3.5"	\$ 60.00	\$ 42.00	\$ 6.00
3.75"	\$ 60.00	\$ 42.00	\$ 8.00
4"	\$ 64.00	\$ 46.00	\$ 8.00
4.25"	\$ 64.00	\$ 46.00	\$ 8.00

UPCHARGES FOR EXTENDED T-STRIKES AND FOR FULL LIP STRIKES

(NOTE: WE SUPPLY T-STRIKES STANDARD)

UPCHARGES FOR EXTENDED T-STRIKES

(If your door is in between, choose the next higher thickness)

Door Thickness	T-Strike Size	NET per set
1.75"	1 1/4"	NONE
2"	1 1/4"	NONE
2.25"	1 1/2"	\$ 9.00
2.5"	1 1/2"	\$ 9.00
2.75"	1 3/4"	\$ 10.00
3"	1 3/4"	\$ 10.00
3.25"	2"	\$ 10.50
3.5"	2"	\$ 10.50
3.75"	2.5"	\$ 11.00
4"	2.5"	\$ 11.00

UPCHARGES FOR FULL LIP STRIKES

Door Thickness	FLS Size	NET per set
1.75"	1 3/16"	\$ 4.50
2"	1 3/16"	\$ 4.50
2.25"	1 1/2"	\$ 8.50
2.5"	1 1/2"	\$ 8.50
2.75"	1 3/4"	\$ 10.00
3"	1 3/4"	\$ 10.00
3.25"	2"	\$ 11.00
3.5"	2"	\$ 11.00

(Not available for doors over 3.5" thick)

UPCHARGES FOR KEYED ALIKE



(NOTE: WE DO NOT KEY ALIKE UNLESS SPECIFIED)

No. of Cylinders	Key Alike charge TOTAL NET	No. of Keys provided	Extra keys NET per key
2	\$ 8.00	4	\$ 4.00
3	\$ 12.00	4	
4	\$ 15.00	4	
5	\$ 16.00	4	
6	\$ 20.00	4	
7	\$ 24.00	4	
8	\$ 28.00	4	
9	\$ 32.00	4	
10	\$ 36.00	4	
11	\$ 40.00	4	



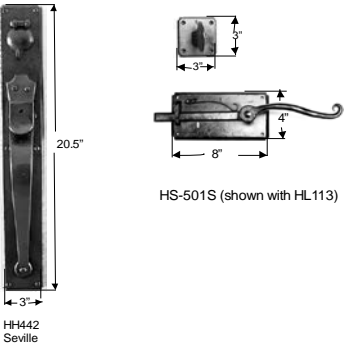
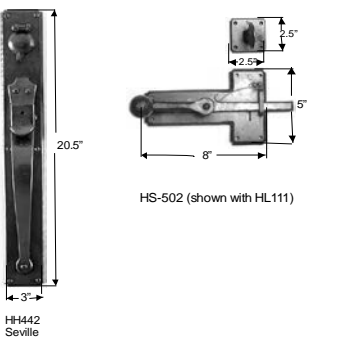
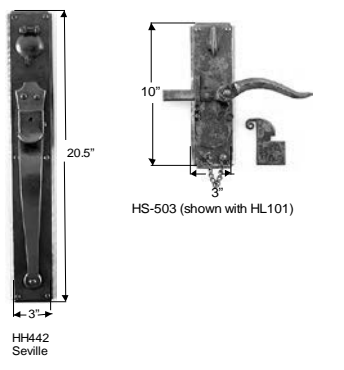
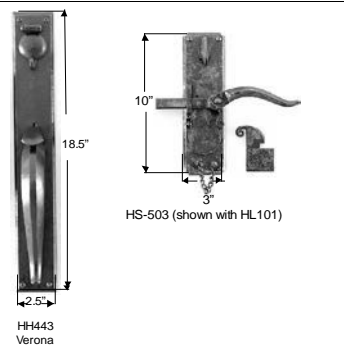

**HARDWARE RENAISSANCE
PRICE LIST EFFECTIVE MAY 1, 2018**

CODE EXTERIOR	CODE INTERIOR		FUNCTION	LIST PRICE
IRON THUMBLATCH X STRIKE-BAR LATCH ENTRY SETS:				
HH441 NORMANDY	HS501 Horizontal S-Latch	<p>HH441 Normandy</p> <p>HS-501 (shown with HL113)</p>	EN-MD FD	2,290 1,866
HH441 NORMANDY	HS501-S Horizontal (short) S-Latch	<p>HH441 Normandy</p> <p>HS-501S (shown with HL113)</p>	EN-MD FD	2,290 1,866
HH441 NORMANDY	HS502 T-shaped S-Latch	<p>HH441 Normandy</p> <p>HS-502 (shown with HL111)</p>	EN-MD FD	2,290 1,866
HH441 NORMANDY	HS503 Vertical S-Latch	<p>HH441 Normandy</p> <p>HS-503 (shown with HL101)</p> <p>HS503-EN-DB (shown w/HL101); AVAILABLE WITH ANY LEVER</p>	EN-MD EN-DB FD	2,290 2,278 1,866
HH442 SEVILLE	HS501 Horizontal S-Latch	<p>HH442 Seville</p> <p>HS-501 (shown with HL113)</p>	EN-MD FD	2,290 1,866



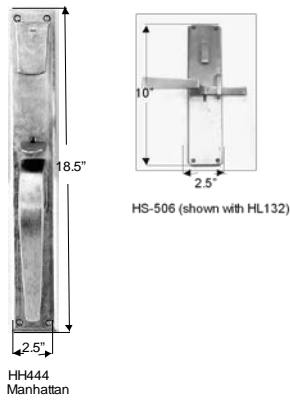

**HARDWARE RENAISSANCE
PRICE LIST EFFECTIVE MAY 1, 2018**



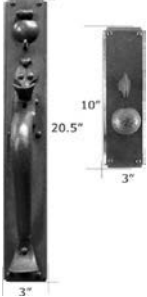

CODE EXTERIOR	CODE INTERIOR	FUNCTION	LIST PRICE
HH442 SEVILLE	HS501-S Horizontal (short) S-Latch 	EN-MD FD	2,290 1,866
HH442 SEVILLE	HS502 T-shaped S-Latch 	EN-MD FD	2,290 1,866
HH442 SEVILLE	HS503 Vertical S-Latch 	EN-MD FD	2,290 1,866
HH443 VERONA	HS503 Vertical S-Latch 	EN-MD FD	2,088 1,678
HH443 VERONA	HS506 Vertical S-Latch (w/concealed spring) 	EN-MD FD	2,088 1,678

**HARDWARE RENAISSANCE
PRICE LIST EFFECTIVE MAY 1, 2018**

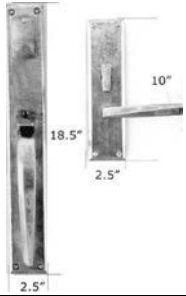

CODE EXTERIOR	CODE INTERIOR	FUNCTION	LIST PRICE
HH444 MANHATTAN	HS506 Vertical S-Latch (w/ concealed spring)	EN-MD FD	2,088 1,678
			
HH454NC ORLEANS	HS503 Vertical S-Latch	EN-MD FD	2,290 1,866
			
HH454NC ORLEANS	HS506NC Vertical S-Latch (w/ concealed spring)	EN-MD FD	2,290 1,866
			
HH456 SIERRA	HS514 Sierra S-Latch	EN-MD FD	2,290 1,866
			

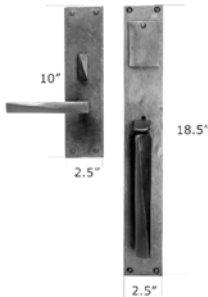
**HARDWARE RENAISSANCE
PRICE LIST EFFECTIVE MAY 1, 2018**

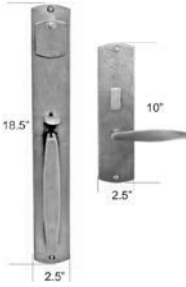

CODE EXTERIOR	CODE INTERIOR	FUNCTION	LIST PRICE
IRON THUMBLATCH x LEVER OR KNOB MORTISE LOCK SETS:			
HH441 NORMANDY	HE601 (shown w/HK751)  The image shows two views of the HH441 lock set. On the left is the exterior thumblatch, which is 3 inches wide and 20.5 inches high. On the right is the interior lever, which is 3 inches wide and 10 inches high.	EN-ML FD	2,396 1,706
HH442 SEVILLE	HE601 (shown w/HK751)  The image shows two views of the HH442 lock set. On the left is the exterior thumblatch, which is 3 inches wide and 20.5 inches high. On the right is the interior lever, which is 3 inches wide and 10 inches high.	EN-ML FD	2,396 1,706
HH443 VERONA	HE607 (shown w/HL101)  The image shows two views of the HH443 lock set. On the left is the exterior thumblatch, which is 2.5 inches wide and 18.5 inches high. On the right is the interior lever, which is 2.5 inches wide and 10 inches high.	EN-ML FD	2,202 1,534
HH444 MANHATTAN	HE607 (shown w/HL132)  The image shows two views of the HH444 lock set. On the left is the exterior thumblatch, which is 2.5 inches wide and 18.5 inches high. On the right is the interior lever, which is 2.5 inches wide and 10 inches high.	EN-ML FD	2,202 1,534
HH445 LOUVRE	HL106 (no lever option)  The image shows two views of the HL106 lock set. On the left is the exterior thumblatch, which is 3 inches wide and 19 inches high. On the right is the interior lever, which is 3.25 inches wide and 42 inches high.	EN-ML FD	4,160 3,680

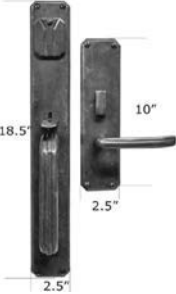
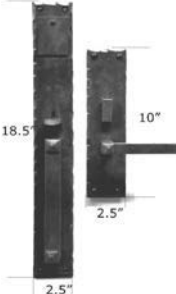
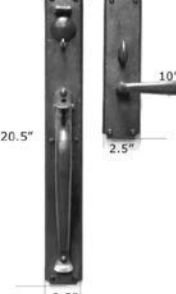
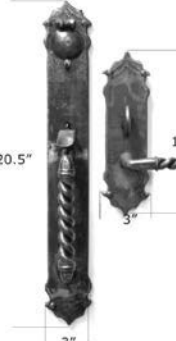
HARDWARE RENAISSANCE PRICE LIST EFFECTIVE MAY 1, 2018			
CODE EXTERIOR	CODE INTERIOR	FUNCTION	LIST PRICE
HH446 MILAN	HE607 (shown w/HL109)	EN-ML FD	2,202 1,534
			
HH447 FLEUR DE LIS	HE484 (shown w/HL144)	EN-ML FD	2,464 1,754
			
HH448 MILAN II	HE621 (shown w/HL109)	EN-ML FD	2,202 1,534
			
HH449 CHATEAU	HE481 (shown w/HL101)	EN-ML FD	2,820 2,098
			
HH451 EL SECRETO	HE646 (shown w/HL155)	EN-ML FD	2,202 1,534
			

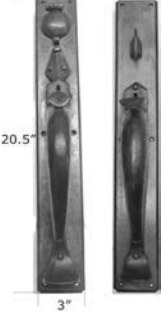

**HARDWARE RENAISSANCE
PRICE LIST EFFECTIVE MAY 1, 2018**

CODE EXTERIOR	CODE INTERIOR	FUNCTION	LIST PRICE
HH452 MONTE VISTA	HE642 (shown w/HL156) 	EN-ML FD	2,202 1,534
HH453 CODY	HE648 (shown w/HL157) 	EN-ML FD	2,202 1,534
HH454NC ORLEANS	HE601N (shown w/HL138) 	EN-ML FD	2,202 1,534
HH455 AVILA	HE664 (shown w/HL158) 	EN-ML FD	2,820 2,098
HH456 SIERRA	HE668 (shown w/HL159) 	EN-ML FD	2,396 1,706

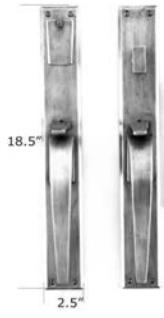

**HARDWARE RENAISSANCE
PRICE LIST EFFECTIVE MAY 1, 2018**

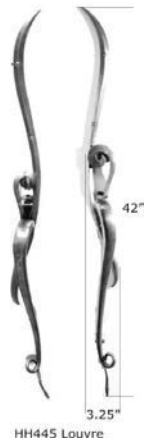
CODE EXTERIOR	CODE INTERIOR	FUNCTION	LIST PRICE
IRON THUMBLATCH MORTISE LOCK SETS:			
HH441 NORMANDY	HH441  HH441 Normandy	EN-ML FD	2,932 2,220
HH442 SEVILLE	HH442  HH442 Seville	EN-ML FD	2,932 2,220
HH443 VERONA	HH443  HH443 Verona	EN-ML FD	2,720 1,994
HH444 MANHATTAN	HH444  HH444 Manhattan	EN-ML FD	2,720 1,994

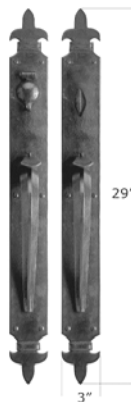
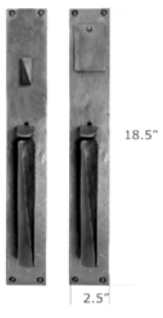

**HARDWARE RENAISSANCE
PRICE LIST EFFECTIVE MAY 1, 2018**

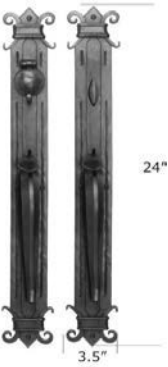
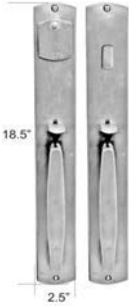

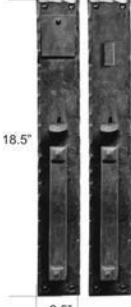

CODE EXTERIOR	CODE INTERIOR	FUNCTION	LIST PRICE
HH445 LOUVRE	 <p>HH445 Louvre</p> <p>42" 3.25"</p>	EN-ML FD	4,956 4,476
HH446 MILAN	 <p>HH446 Milan</p> <p>18.5" 2.5"</p>	EN-ML FD	2,720 1,994
HH447 FLEUR DE LIS	 <p>HH447 Fleur de Lis</p> <p>29" 3"</p>	EN-ML FD	3,014 2,266
HH448 MILAN II	 <p>HH448 Milan II</p> <p>18.5" 2.5"</p>	EN-ML FD	2,720 1,994

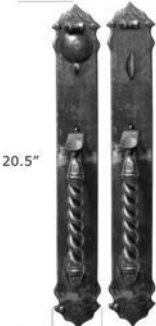
**HARDWARE RENAISSANCE
PRICE LIST EFFECTIVE MAY 1, 2018**

CODE EXTERIOR	CODE INTERIOR	FUNCTION	LIST PRICE
HH449 CHATEAU	 <p data-bbox="634 625 748 642">HH449 Chateau</p>	EN-ML FD	3,286 2,546
HH451 EL SECRETO	 <p data-bbox="634 1041 748 1058">HH451 El Secreto</p>	EN-ML FD	2,720 1,994
HH452 MONTE VISTA	 <p data-bbox="643 1478 764 1495">HH452 Monte Vista</p>	EN-ML FD	2,720 1,994
HH453 CODY	 <p data-bbox="654 1940 740 1957">HH453 Cody</p>	EN-ML FD	2,720 1,994

**HARDWARE RENAISSANCE
PRICE LIST EFFECTIVE MAY 1, 2018**

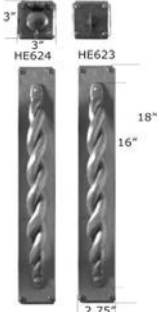

CODE EXTERIOR	CODE INTERIOR	FUNCTION	LIST PRICE
HH454NC ORLEANS	 <p data-bbox="617 373 657 394">20.5"</p> <p data-bbox="665 535 706 556">2.5"</p> <p data-bbox="630 569 800 600">HH454NC Orleans (OR HH454 w/square corners)</p>	EN-ML FD	2,720 1,994
HH455 AVILA	 <p data-bbox="617 856 657 877">20.5"</p> <p data-bbox="682 1039 706 1060">3"</p> <p data-bbox="665 1073 738 1083">HH455 Avila</p>	EN-ML FD	3,286 2,546
HH456 SIERRA	 <p data-bbox="617 1308 657 1329">22"</p> <p data-bbox="665 1501 706 1522">2.5"</p> <p data-bbox="646 1528 735 1539">HH456 Sierra</p>	EN-ML FD	2,932 2,220

HARDWARE RENAISSANCE PRICE LIST EFFECTIVE MAY 1, 2018			
CODE EXTERIOR	CODE INTERIOR	FUNCTION	LIST PRICE
FIXED GRIP DEADBOLT ENTRY SETS:			
HP113L SCROLLED 25" PULL with HE631N-HE632N deadbolt	HP113L SCROLLED 25" PULL with HE631N-HE632N deadbolt	 <p>HP113L Scrolled Pull (4" projection)</p>	EN-MD 1,724 EN-DB-SC 1,566 EN-DB-DC 1,638 FD 1,252
HP701L FISHTAIL 21" PULL with HE637-HE638 deadbolt	HP701L FISHTAIL 21" PULL with HE637-HE638 deadbolt	 <p>HP701L Fishtail Pul (4" projection)</p>	EN-MD 1,548 EN-DB-SC 1,390 EN-DB-DC 1,462 FD 1,076
HP702 ROPE 18" PULL with HE623-HE624 deadbolt	HP702 ROPE 18" PULL with HE623-HE624 deadbolt	 <p>HP702 Rope Pull (3.25" projection)</p>	EN-MD 1,664 EN-DB-SC 1,506 EN-DB-DC 1,578 FD 1,192
HP706 TRIO 14" PULL with HE631N-HE632N deadbolt	HP706 TRIO 14" PULL with HE631N-HE632N deadbolt	 <p>HP706 Trio Pull (3.5" projection)</p>	EN-MD 1,384 EN-DB-SC 1,226 EN-DB-DC 1,298 FD 912

HARDWARE RENAISSANCE PRICE LIST EFFECTIVE MAY 1, 2018			
CODE EXTERIOR	CODE INTERIOR	FUNCTION	LIST PRICE
HP707L EL SECRETO 20" PULL with HE631N-HE632N deadbolt	HP707L 20" PULL with HE631N-HE632N deadbolt	EN-MD EN-DB-SC EN-DB-DC FD	1,548 1,390 1,462 1,076
<p>HP707L El Secreto Pul (2.5" projection)</p>			
HP709 GALISTEO 16" PULL with HE631N-HE632N deadbolt	HP709 16" PULL with HE631N-HE632N deadbolt	EN-MD EN-DB-SC EN-DB-DC FD	1,664 1,506 1,578 1,192
<p>HP709 Galisteo Pull (3.5" projection)</p>			
HP725L MILAN 20" PULL with HE631-HE632 deadbolt	HP725L 20" PULL with HE631-HE632 deadbolt	EN-MD EN-DB-SC EN-DB-DC FD	1,508 1,350 1,422 1,036
<p>HP725L Milan Pull (2" projection)</p>			
HP726L STOCKHOLM 28" PULL with HE631-HE632 deadbolt	HP726L 28" PULL with HE631-HE632 deadbolt	EN-MD EN-DB-SC EN-DB-DC FD	1,508 1,350 1,422 1,036
<p>HP726L-28 Stockholm (2.5" projection)</p>			

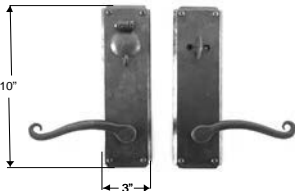
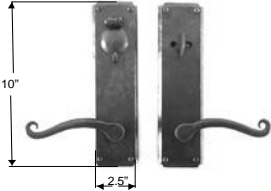
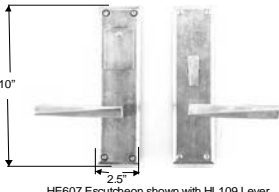
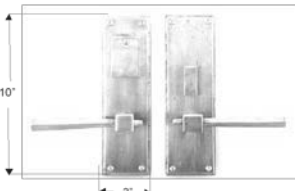
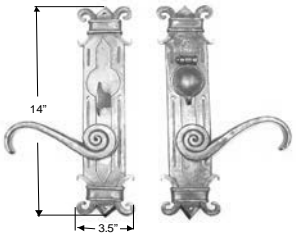
**HARDWARE RENAISSANCE
PRICE LIST EFFECTIVE MAY 1, 2018**

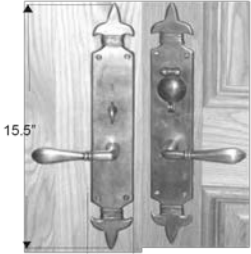
CODE EXTERIOR	CODE INTERIOR		FUNCTION	LIST PRICE
IRON LEVER OR KNOB MORTISE LOCK & DEADBOLT/TUBULAR LATCH SETS:				
HE601 3" x 10" NOTCHED CORNER	HE601	 <p>HE601 Escutcheon shown with HL113 Lever</p>	EN-ML 1,468 PT-ML 1,347 EN-DB-SC 1,048 EN-DB-DC 1,107 PT-DB 987 FD 571	
HE601N 2.5" x 10" NOTCHED CORNER	HE601N	 <p>HE601N Escutcheon shown with HL113 Lever</p>	EN-ML 1,468 PT-ML 1,347 EN-DB-SC 1,048 EN-DB-DC 1,107 PT-DB 987 FD 571	
HE607 2.5" x 10" BEVELED	HE607	 <p>HE607 Escutcheon shown with HL109 Lever</p>	EN-ML 1,468 PT-ML 1,347 EN-DB-SC 1,048 EN-DB-DC 1,107 PT-DB 987 FD 571	
HE614 3" x 10" STEP	HE614	 <p>HE614 Escutcheon shown with HL105 Lever</p>	EN-ML 1,468 PT-ML 1,347 EN-DB-SC 1,048 EN-DB-DC 1,107 PT-DB 987 FD 571	
HE621 2.5" x 10" STRAIGHT EDGE	HE621	 <p>HE621 Straight Edge (shown w/HK756 Knob)</p>	EN-ML 1,468 PT-ML 1,347 EN-DB-SC 1,048 EN-DB-DC 1,107 PT-DB 987 FD 571	
HE481 3.5" x 14" CHATEAU	HE481	 <p>HE481 Mortise Lock Entry shown with HL103 Lever</p>	EN-ML 2,192 PT-ML 2,118 EN-DB-SC 1,832 EN-DB-DC 1,888 PT-DB 1,774 FD 1,522	

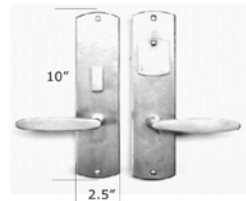
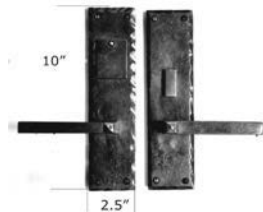
HARDWARE RENAISSANCE PRICE LIST EFFECTIVE MAY 1, 2018			
CODE EXTERIOR	CODE INTERIOR	FUNCTION	LIST PRICE
HE484 3" x 15.5" FLEUR DE LIS	HE484 3" x 15.5" FLEUR DE LIS	 <p>HE484 Escutcheon w/HL144 Lever</p>	EN-ML 1,541 PT-ML 1,463 EN-DB-SC 1,163 EN-DB-DC 1,222 PT-DB 1,103 FD 601
HL106 3" x 19" LOUVRE	HL106 3" x 19" LOUVRE	 <p>HL106 Louvre Lever Mortise Entry (No lever or tubular deadbolt option)</p>	EN-ML 2,822 PT-ML 2,746 FD 2,090
HE642 2.5" x 10" MONTE VISTA	HE642 2.5" x 10" MONTE VISTA	 <p>HE642 Monte Vista with HL156 Lever</p>	EN-ML 1,468 PT-ML 1,347 EN-DB-SC 1,048 EN-DB-DC 1,107 PT-DB 987 FD 571
HE646 2.5" x 10" EL SECRETO	HE646 2.5" x 10" EL SECRETO	 <p>HE646 El Secreto with HL155 Lever</p>	EN-ML 1,468 PT-ML 1,347 EN-DB-SC 1,048 EN-DB-DC 1,107 PT-DB 987 FD 571
HE648 2.5" x 10" CODY	HE648 2.5" x 10" CODY	 <p>HE648 Cody with HL157 Lever</p>	EN-ML 1,468 PT-ML 1,347 EN-DB-SC 1,048 EN-DB-DC 1,107 PT-DB 987 FD 571

**HARDWARE RENAISSANCE
PRICE LIST EFFECTIVE MAY 1, 2018**

CODE EXTERIOR	CODE INTERIOR	FUNCTION	LIST PRICE
HE664 3" x 10" AVILA	<div data-bbox="607 254 906 478" data-label="Image"> </div> <p data-bbox="607 491 834 512">HE664 Avila with HL158 Lever</p>	EN-ML PT-ML EN-DB-SC EN-DB-DC PT-DB FD	1,541 1,463 1,163 1,222 1,103 628
HE668 2.5" x 10" SIERRA	<div data-bbox="630 632 912 835" data-label="Image"> </div> <p data-bbox="646 856 867 877">HE668 Sierra with HL159 Lever</p>	EN-ML PT-ML EN-DB-SC EN-DB-DC PT-DB FD	1,468 1,347 1,048 1,107 987 571









**HARDWARE RENAISSANCE
PRICE LIST EFFECTIVE MAY 1, 2018**



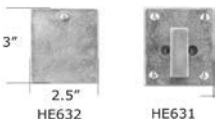

CODE EXTERIOR	CODE INTERIOR		FUNCTION	LIST PRICE
IRON SECTIONAL LEVER/ KNOB DEADBOLT ENTRY SETS:				
HE602 3" x 6" NOTCHED with HE623-HE624 deadbolt	HE602	<p>HE623 HE624 3" 6" 3" HE602 Notched Corner</p>	EN-DB-SC EN-DB-DC EN-MD PT-DB FD	889 961 1,047 759 485
HE603 3" x 3" NOTCHED with HE623-HE624 deadbolt	HE603	<p>HE623 HE624 3" 3" 3" HE603 Notched Corner</p>	EN-DB-SC EN-DB-DC EN-MD PT-DB FD	802 874 960 672 399
HE604 2.5" x 4.5" BEVELED with HE637-HE638 deadbolt	HE604	<p>HE637 HE638 3" 2.5" 4.5" 2.5" HE604 Beveled (Or HE604NC Notched Corner)</p>	EN-DB-SC EN-DB-DC EN-MD PT-DB FD	802 874 960 672 399
HE604NC 2.5" x 4.5" NOTCHED with HE623N-HE624N deadbolt	HE604NC	<p>HE624N HE623N 3" 2.5" 4.5" 2.5" HE604NC Notched Corner</p>	EN-DB-SC EN-DB-DC EN-MD PT-DB FD	802 874 960 672 399
HE612 3" x 3" STRAIGHT EDGE with HE691-HE692 deadbolt	HE612	<p>HE692 HE691 3" 3" 3" HE612 Straight Edge</p>	EN-DB-SC EN-DB-DC EN-MD PT-DB FD	802 874 960 672 399
HE613 4" x 2.25" HORIZONTAL STEP with HE633-HE634 deadbolt	HE613	<p>HE634 HE633 2.25" 4" 4" 2.25" HE613 Horizontal Step</p>	EN-DB-SC EN-DB-DC EN-MD PT-DB FD	802 874 960 672 399

**HARDWARE RENAISSANCE
PRICE LIST EFFECTIVE MAY 1, 2018**

CODE EXTERIOR	CODE INTERIOR		FUNCTION	LIST PRICE
HE615 3" x 3" STEP with HE657-HE658 deadbolt	HE615	<p>HE658 HE657 3" 3" 3" 3" HE615 Step</p>	EN-DB-SC EN-DB-DC EN-MD PT-DB FD	802 874 960 672 399
HE617 2.75" ROUND with HE635-HE636 deadbolt	HE617	<p>HE636 HE635 2.75" 2.75" 2.75" HE617 Round</p>	EN-DB-SC EN-DB-DC EN-MD PT-DB FD	802 874 960 672 399
HE620 2.5" x 4.5" STRAIGHT EDGE with HE631-HE632 deadbolt	HE620	<p>HE632 HE631 3" 4.5" 2.5" HE620 Straight Edge</p>	EN-DB-SC EN-DB-DC EN-MD PT-DB FD	802 874 960 672 399
HE643 2.5" x 4.5" SKEWED CORNER with HE625-HE626 deadbolt	HE643	<p>HE625 HE626 4.5" 4.5" 2.5" HE643 Skewed Corner</p>	EN-DB-SC EN-DB-DC EN-MD PT-DB FD	802 874 960 672 399
HE643M 2.5" x 4.5" MONTE VISTA with HE625M-HE626M deadbolt	HE643M	<p>HE625M HE626M 4.5" 4.5" 2.5" HE643 Monte Vista</p>	EN-DB-SC EN-DB-DC EN-MD PT-DB FD	802 874 960 672 399
HE645 2.5" x 4.5" EL SECRETO with HE681-HE682 deadbolt	HE645	<p>HE682 HE681 2.75" 2.5" 4.5" HE645 El Secreto</p>	EN-DB-SC EN-DB-DC EN-MD PT-DB FD	802 874 960 672 399

**HARDWARE RENAISSANCE
PRICE LIST EFFECTIVE MAY 1, 2018**

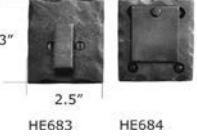
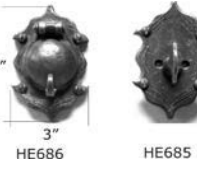
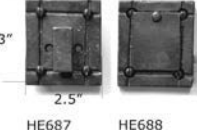
CODE EXTERIOR	CODE INTERIOR			FUNCTION	LIST PRICE
IRON DEADBOLTS ONLY:					
HE624 HE624 HE624	HE623 HE624 HE623 HE623	3" x 3" Notched Corner		EN-DB-SC EN-DB-DC PT-DB EN-MD	314 386 184 472
HE624N HE624N HE624N	HE623N HE624N HE623N HE623N	2.5" x 3" Notched Corner		EN-DB-SC EN-DB-DC PT-DB EN-MD	314 386 184 472
HE626 HE626 HE626	HE625 HE626 HE625 HE625	2.5" x 4.5" Skewed Corner		EN-DB-SC EN-DB-DC PT-DB EN-MD	314 386 184 472
HE626M HE626M HE626M	HE625M HE626M HE625M HE625M	2.5" x 4.5" Monte Vista		EN-DB-SC EN-DB-DC PT-DB EN-MD	314 386 184 472
HE628 HE628 HE628	HE627 HE628 HE627 HE627	2 5/8" diam Art Nouveau		EN-DB-SC EN-DB-DC PT-DB EN-MD	376 414 236 524
HE632 HE632 HE632	HE631 HE632 HE631 HE631	2.5" x 3" Straight Edge		EN-DB-SC EN-DB-DC PT-DB EN-MD	314 386 184 472
HE634 HE634 HE634	HE633 HE634 HE633 HE633	4" x 2.25" Horizontal Step		EN-DB-SC EN-DB-DC PT-DB EN-MD	314 386 184 472
HE636 HE636 HE636	HE635 HE636 HE635 HE635	2.75" diam. Round		EN-DB-SC EN-DB-DC PT-DB EN-MD	314 386 184 472
HE638 HE638 HE638	HE637 HE638 HE637 HE637	2.5" x 3" Beveled		EN-DB-SC EN-DB-DC PT-DB EN-MD	314 386 184 472



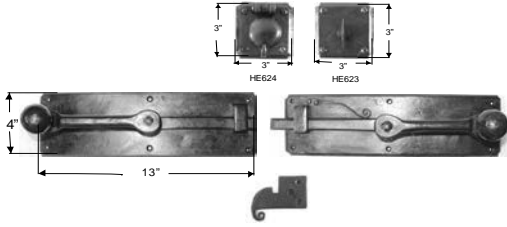
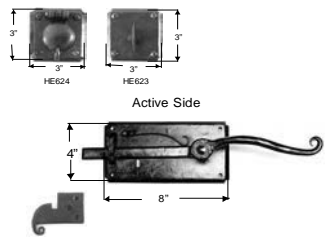
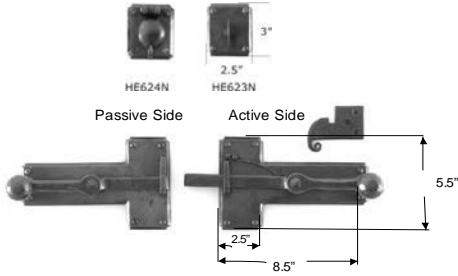
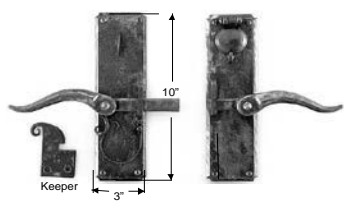
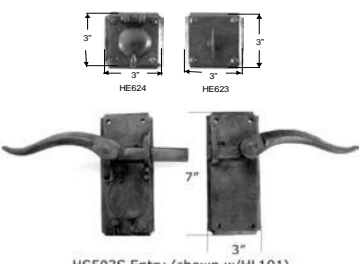

HARDWARE RENAISSANCE PRICE LIST EFFECTIVE MAY 1, 2018					
CODE EXTERIOR	CODE INTERIOR			FUNCTION	LIST PRICE
HE658 HE658 HE658	HE657 HE658 HE657 HE657	3" x 3" Step		EN-DB-SC EN-DB-DC PT-DB EN-MD	314 386 184 472
HE682 HE682 HE682	HE681 HE682 HE681 HE681	2.5" x 2.75" El Secreto		EN-DB-SC EN-DB-DC PT-DB EN-MD	314 386 184 472
HE684 HE684 HE684	HE683 HE684 HE683 HE683	2.5" x 3" Cody		EN-DB-SC EN-DB-DC PT-DB EN-MD	314 386 184 472
HE686 HE686 HE686	HE685 HE686 HE685 HE685	3" x 4.5" Avila		EN-DB-SC EN-DB-DC PT-DB EN-MD	376 414 236 524
HE688 HE688 HE688	HE687 HE688 HE687 HE687	2.5" x 3" Sierra		EN-DB-SC EN-DB-DC PT-DB EN-MD	314 386 184 472
HE692 HE692 HE692	HE691 HE692 HE691 HE691	3" x 3" Straight Edge		EN-DB-SC EN-DB-DC PT-DB EN-MD	314 386 184 472
HE488 HE488 HE488	HE487 HE488 HE487 HE487	2.5" x 6" Fleur de Lis		EN-DB-SC EN-DB-DC PT-DB EN-MD	376 414 236 524

**HARDWARE RENAISSANCE
PRICE LIST EFFECTIVE MAY 1, 2018**

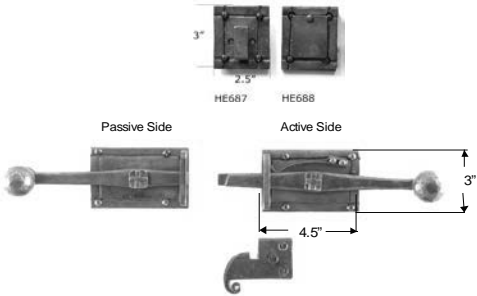
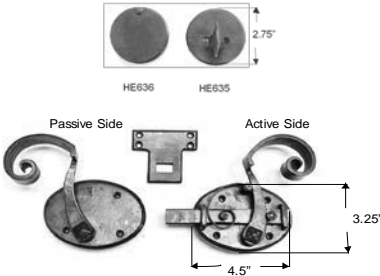
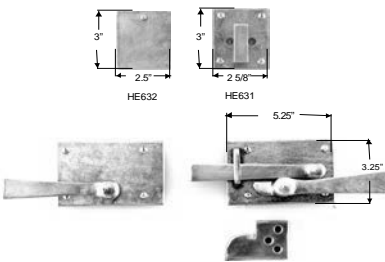
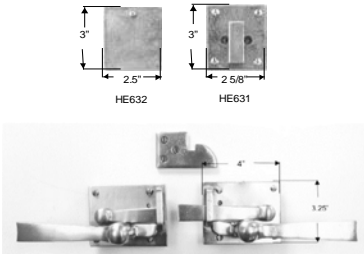
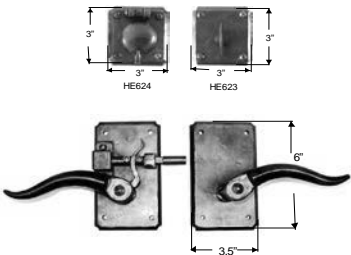

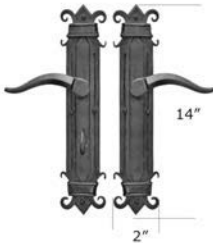

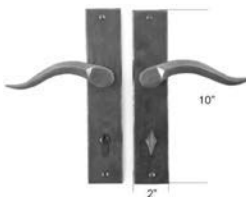
CODE EXTERIOR	CODE INTERIOR	FUNCTION	LIST PRICE
IRON STRIKE-BAR LATCH ENTRY SETS:			
<p>These unique sets are available with tubular deadbolt (DB) or heavier duty Mortise Deadlock (Accurate 9503) With mortise strike as shown. Contact us for surface strike or other custom strike requirements</p>			
<p>HS501 HORIZONTAL 4" x 13" with HE623-HE624 deadbolt</p> <p>With any lever. Must specify lever (HL111-R shown)</p>	<p>HS501</p> 	<p>EN-MD 1,194 EN-DB-SC 1,036 EN-DB-DC 1,108 PT-DB 906 FD 660 SD 330</p>	
<p>HS501S HORIZONTAL SHORT 4" x 8" with HE623-HE624 deadbolt</p> <p>With any lever. Must specify lever (HL113-R shown)</p>	<p>HS501S</p> 	<p>EN-MD 1,144 EN-DB-SC 986 EN-DB-DC 1,058 PT-DB 856 FD 626 SD 313</p>	
<p>HS502 T-SHAPED with HE623-HE624 deadbolt</p> <p>With any lever. Must specify lever (HL111-R shown)</p>	<p>HS502</p> 	<p>EN-MD 1,144 EN-DB-SC 986 EN-DB-DC 1,058 PT-DB 856 FD 626 SD 313</p>	
<p>HS503 VERTICAL with any lever. Must specify lever (HL101-R shown)</p>	<p>HS503</p>  <p>HS503 Cylindrical Deadbolt Entry shown with HL101</p>	<p>EN-MD 1,240 EN-DB-SC 1,078 EN-DB-DC 1,132 PT-DB 944 FD 660 SD 330</p>	
<p>HS503S VERTICAL SHORT with HE623-HE624 deadbolt</p> <p>With any lever. Must specify lever (HL101-R shown)</p>	<p>HS503S</p>  <p>HS503S Entry (shown w/HL101)</p>	<p>EN-MD 1,144 EN-DB-SC 986 EN-DB-DC 1,058 PT-DB 856 FD 626 SD 313</p>	

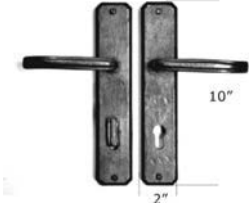

**HARDWARE RENAISSANCE
PRICE LIST EFFECTIVE MAY 1, 2018**

CODE EXTERIOR	CODE INTERIOR	FUNCTION	LIST PRICE
<p>HS504 TWEEZER with HE687-HE688 deadbolt No lever options</p>	<p>HS504</p> 	<p>EN-MD EN-DB-SC EN-DB-DC PT-DB FD SD</p>	<p>1,144 986 1,058 856 626 313</p>
<p>HS505 STOKER with HE635-HE636 deadbolt No lever options</p>	<p>HS505</p> 	<p>EN-MD EN-DB-SC EN-DB-DC PT-DB FD SD</p>	<p>1,194 1,036 1,108 906 660 330</p>
<p>HS507 BERMUDA with HE631-HE632 deadbolt No lever options</p>	<p>HS507</p> 	<p>EN-MD EN-DB-SC EN-DB-DC PT-DB FD SD</p>	<p>1,144 986 1,058 856 626 313</p>
<p>HS507S PETITE BERMUDA with HE631-HE632 deadbolt No lever options</p>	<p>HS507S</p> 	<p>EN-MD EN-DB-SC EN-DB-DC PT-DB FD SD</p>	<p>1,144 986 1,058 856 626 313</p>
<p>HS508 SANTA BARBARA with HE623-HE624 deadbolt With any lever. Must specify lever (HL101-R shown)</p>	<p>HS508</p> 	<p>EN-MD EN-DB-SC EN-DB-DC PT-DB FD SD</p>	<p>1,144 986 1,058 856 626 313</p>

HARDWARE RENAISSANCE PRICE LIST EFFECTIVE MAY 1, 2018				
CODE EXTERIOR	CODE INTERIOR		FUNCTION	LIST PRICE
IRON MULTIPOINT HARDWARE:				
Available for most door makes (except Andersen) See Multipoint Specs and order form in Product binder				
HE480	HE480	2" x 14" Chateau		EN-US CYL 1,755 PT-US CYL 1,675 EN-EURO 1,856 PT-EURO 1,813 PP 1,619 AD 1,619 FD 1,522
HE489	HE489	1.5" x 15" Fleur de Lis NO SPRING ASSIST		EN-US CYL 786 PT-US CYL 702 EN-EURO 892 PT-EURO 846 PP 642 AD 642 FD 622
HE605 HE605NC HE605B	HE605 HE605NC HE605B	1 3/8" x 10" Straight Edge OR 1 3/8" x 10" Notched OR 1 3/8" x 10" Beveled (square corners) NO SPRING ASSIST		EN-US CYL 720 PT-US CYL 628 EN-EURO 826 PT-EURO 782 PP 578 AD 578 FD 550
HE606 HE606NC HE606B	HE606 HE606NC HE606B	2" x 10" Straight Edge OR 2" x 10" Notched OR 2" x 10" Beveled (square corners)		EN-US CYL 730 PT-US CYL 648 EN-EURO 836 PT-EURO 792 PP 588 AD 588 FD 560
HE616	HE616	2"x10" Step		EN-US CYL 730 PT-US CYL 648 EN-EURO 836 PT-EURO 792 PP 588 AD 588 FD 560

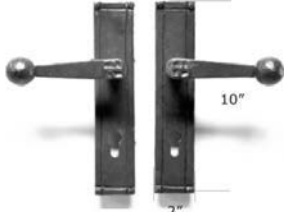
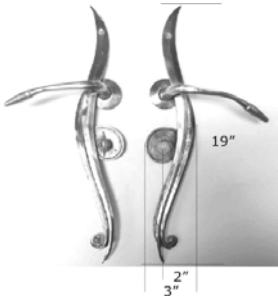

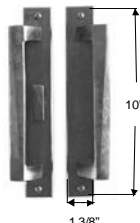
**HARDWARE RENAISSANCE
PRICE LIST EFFECTIVE MAY 1, 2018**



CODE EXTERIOR	CODE INTERIOR			FUNCTION	LIST PRICE
HE644	HE644	2" x 10" Monte Vista (Skewed Corner)		EN-US CYL PT-US CYL EN-EURO PT-EURO PP AD FD	730 648 836 792 588 588 560
HE649	HE649	2" x 10" El Secreto		EN-US CYL PT-US CYL EN-EURO PT-EURO PP AD FD	730 648 836 792 588 588 560
HE650	HE650	2" x 10" Cody		EN-US CYL PT-US CYL EN-EURO PT-EURO PP AD FD	730 648 836 792 588 588 560
HE665	HE665	2" x 10" Avila		EN-US CYL PT-US CYL EN-EURO PT-EURO PP AD FD	786 702 892 846 642 642 614
HE669	HE669	2" x 10" Sierra		EN-US CYL PT-US CYL EN-EURO PT-EURO PP AD FD	730 648 836 792 588 588 560
HL106MP	HL106MP	3" x 19" Louvre		PT-US CYL PT-EURO PP AD FD	2,182 2,248 2,150 2,150 1,990

HARDWARE RENAISSANCE PRICE LIST EFFECTIVE MAY 1, 2018				
CODE EXTERIOR	CODE INTERIOR		FUNCTION	LIST PRICE
IRON SLIDING DOOR HARDWARE:				
SLIDING DOOR:				
Available for most door makes. See Sliding door order form for required information NOTE: We do NOT match existing screw hole locations. We provide thru-bolts for install				
AVAILABLE WITH THE FOLLOWING GRIPS: HP444 Manhattan HP656 Milan HP657 El Secreto				
HE605 HE605NC HE605B	HE605 HE605NC HE605B	1 3/8" x 10" Straight Edge OR 1 3/8" x 10" Notched OR 1 3/8" x 10" Beveled (square corners)	 HE605 Escutcheon Patio set shown w/ HP656 Offset Milan 8" Grip	PT FD 716 668
HE605L HE605LNC HE605LB	HE605L HE605LNC HE605LB	1 3/8" x 13" Straight Edge OR 1 3/8" x 13" Notched OR 1 3/8" x 13" Beveled (square corners)	 HE605L Escutcheon Patic set shown w/ HP444 Offset Manhattan 8" Grip	EN-US PT FD 838 728 680
MULTIPOINT SLIDING:				
Available for most door makes. See product binder for required information NOTE: We do NOT match existing screw hole locations. We provide thru-bolts for install				
HE605L HE605LNC HE605LB	HE605L HE605LNC HE605LB	1 3/8" x 13" Straight Edge OR 1 3/8" x 13" Notched OR 1 3/8" x 13" Beveled (square corners)	 HE605L Escutcheon Entry American Cylinder set shown w/HL109-OS Offset Milan Lever	EN-US CYL PT-US CYL EN-EURO PT-EURO FD 806 698 906 864 658

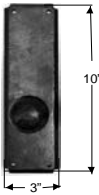
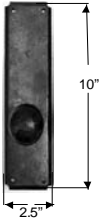
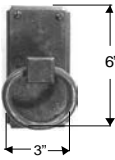
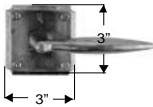

**HARDWARE RENAISSANCE
PRICE LIST EFFECTIVE MAY 1, 2018**

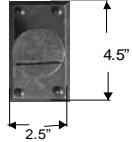

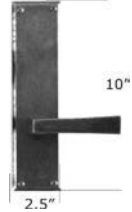
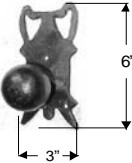
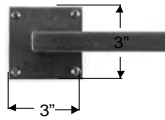
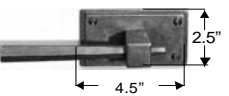
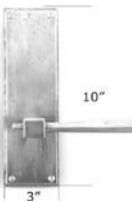
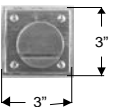
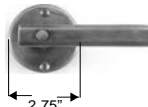
CODE EXTERIOR	CODE INTERIOR	FUNCTION	LIST PRICE
LIFT & SLIDE:			
Lift & Slide sets are typically a long lever on the inside, and flush pull outside. The locking mechanism is inside the door. Standard spindle (hub) is 10mm square			
AVAILABLE WITH THE FOLLOWING LONG LEVERS:			
HL105L East-West HL109L Milan HL132L Manhattan			
HP712	HE605 HE605B	PP PP	648 648
<p>1 3/8" x 10" Straight Edge OR 1 3/8" x 10" Beveled</p>			
<p>HE605 Escutcheon set shown w/ HL105L East-West 9" Lever & HP712 Flush Pull HE605 Escutcheon set shown w/ HL109L Milan 9" Lever & HP712 Flush Pull HE605 Escutcheon set shown w/ HL132L Manhattan 7" Lever & HP712 Flush Pull</p>			

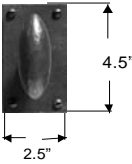
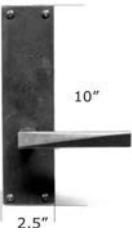
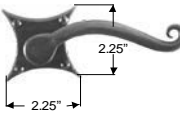
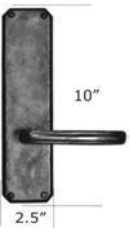
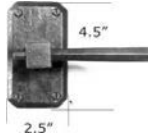

HARDWARE RENAISSANCE PRICE LIST EFFECTIVE MAY 1, 2018				
CODE EXTERIOR	CODE INTERIOR		FUNCTION	LIST PRICE
IRON PASSAGE, PRIVACY & DUMMY SETS: TUBULAR OR MORTISE (where shown)				
NOTE: IRON ESCUTCHEONS DO NOT WORK WITH DOORS THINNER THAN 1.75"! Call us for custom thin door upcharges				
HE481	HE481	3.5" x 14" Chateau		PP-TL 1,671 PR-TL 1,691 PR- PMB 1,851 PP-ML 1,912 PR-ML 2,145 FD 1,522 SD 761
HE484	HE484	3" x 15.5" Fleur de Lis		PP-TL 693 PR-TL 714 PR- PMB 884 PP-ML 946 PR-ML 1,193 FD 601 SD 300
HE485	HE485	2.5" x 9" Fleur de Lis		PP-TL 668 PR-TL 689 PP-ML 920 FD 571 SD 286
HE601	HE601	3" x 10" Notched		PP-TL 668 PR-TL 689 PR- PMB 857 PP-ML 920 PR-ML 1,153 FD 571 SD 286
HE601N	HE601N	2.5" x 10" Notched		PP-TL 668 PR-TL 689 PR- PMB 857 PP-ML 920 PR-ML 1,153 FD 571 SD 286
HE602	HE602	3" x 6" Notched		PP-TL 575 PR-TL 596 PR- PMB 775 FD 485 SD 243
HE603	HE603	3"x3" Notched		PP-TL 488 PR-TL 509 FD 400 SD 200

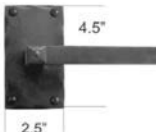
HARDWARE RENAISSANCE PRICE LIST EFFECTIVE MAY 1, 2018					
CODE EXTERIOR	CODE INTERIOR			FUNCTION	LIST PRICE
HE604	HE604	2.5" x 4.5" Beveled		PP-TL PR-TL FD SD	488 509 400 200
HE604NC	HE604NC	2.5" x 4.5" Notched		PP-TL PR-TL FD SD	488 509 400 200
HE607	HE607	2.5" x 10" Beveled		PP-TL PR-TL PR- PMB PP-ML PR-ML FD SD	668 689 857 920 1,153 571 286
HE611	HE611	3" x 6" Gothic Will not work with pre-bored doors		PP-TL PR-TL FD SD	596 617 508 254
HE612	HE612	3" x 3" Straight Edge		PP-TL PR-TL FD SD	488 509 400 200
HE613	HE613	4.5" x 2.5" Horizontal Step		PP-TL PR-TL FD SD	488 509 400 200
HE614	HE614	3" x 10" Step		PP-TL PR-TL PR- PMB PP-ML PR-ML FD SD	668 689 857 920 1,153 571 286
HE615	HE615	3" x 3" Step		PP-TL PR-TL FD SD	488 509 400 200
HE617	HE617	2.75" diam Round		PP-TL PR-TL FD SD	488 509 399 200

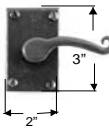
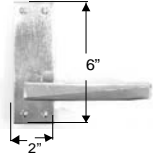
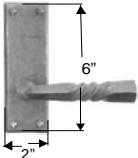
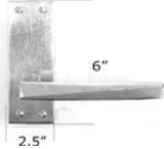
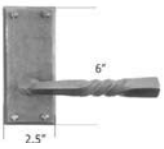
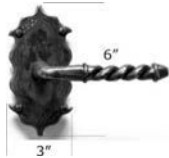

**HARDWARE RENAISSANCE
PRICE LIST EFFECTIVE MAY 1, 2018**

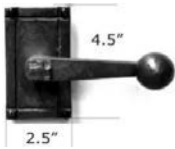
CODE EXTERIOR	CODE INTERIOR			FUNCTION	LIST PRICE
HE620	HE620	2.5" x 4.5" Straight Edge		PP-TL PR-TL FD SD	488 509 400 200
HE621	HE621	2.5" x 10" Straight Edge		PP-TL PR-TL PR- PMB PP-ML PR-ML FD SD	668 689 857 920 1,153 571 286
HE641	HE641	2.25" x 2.25" Scallop Will not work with pre-bored doors		PP-TL PR-TL FD SD	488 509 400 200
HE642	HE642	2.5" x 10" Monte Vista (Skewed Corner)		PP-TL PR-TL PR- PMB PP-ML PR-ML FD SD	668 689 857 920 1,153 571 286
HE643	HE643	2.5" x 4.5" Monte Vista (Skewed Corner)		PP-TL PR-TL FD SD	488 509 400 200
HE645	HE645	2.5" x 4.5" El Secreto		PP-TL PR-TL FD SD	488 509 400 200
HE646	HE646	2.5" x 10" El Secreto		PP-TL PR-TL PR- PMB PP-ML PR-ML FD SD	668 689 857 920 1,153 571 286
HE647	HE647	2.5" x 4.5" Cody		PP-TL PR-TL FD SD	488 509 400 200

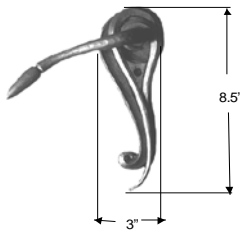





HARDWARE RENAISSANCE PRICE LIST EFFECTIVE MAY 1, 2018			FUNCTION	LIST PRICE
CODE EXTERIOR	CODE INTERIOR			
HE648	HE648	2.5" x 10" Cody		PP-TL 668 PR-TL 689 PR- PMB 857 PP-ML 920 PR-ML 1,153 FD 571 SD 286
HE651	HE651	2" x 3" Straight Edge Will not work with pre-bored doors		PP-TL 488 PR-TL N/A FD 400 SD 200
HE652	HE652	2" x 6" Straight Edge Will not work with pre-bored doors		PP-TL 520 PR-TL N/A FD 431 SD 215
HE652B	HE652B	2" x 6" Beveled Will not work with pre-bored doors		PP-TL 520 PR-TL N/A FD 431 SD 215
HE652W	HE652W	2.5" x 6" Straight Edge		PP-TL 575 PR-TL 596 PR- PMB 775 FD 485 SD 243
HE652WB	HE652WB	2.5" x 6" Beveled		PP-TL 575 PR-TL 596 PR- PMB 775 FD 485 SD 243
HE663	HE663	3" x 6" Avila		PP-TL 628 PR-TL 649 FD 523 SD 261
HE664	HE664	3" x 10" Avila		PP-TL 729 PR-TL 750 PR- PMB 918 PP-ML 981 PR-ML 1,214 FD 628 SD 314

HARDWARE RENAISSANCE PRICE LIST EFFECTIVE MAY 1, 2018				
CODE EXTERIOR	CODE INTERIOR		FUNCTION	LIST PRICE
HE667	HE667	2.5" x 4.5" Sierra 	PP-TL PR-TL FD SD	488 509 400 200
HE668	HE668	2.5" x 10" Sierra 	PP-TL PR-TL PR- PMB PP-ML PR-ML FD SD	668 689 857 920 1,153 571 286
HL104	HL104	3" x 8.5" Art Nouveau Will not work with pre-bored doors 	PP-TL PR-TL FD SD	838 N/A 733 366

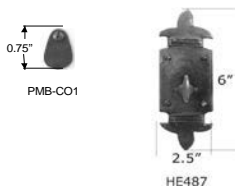
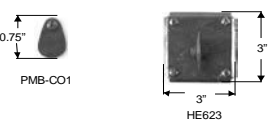

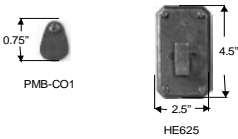
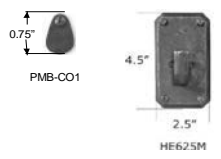
**HARDWARE RENAISSANCE
PRICE LIST EFFECTIVE MAY 1, 2018**

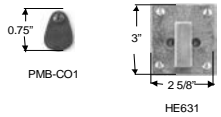
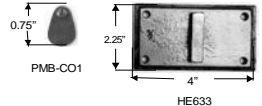
CODE EXTERIOR	CODE INTERIOR			FUNCTION	LIST PRICE
IRON PETITE SERIES PASSAGE, PRIVACY & DUMMY SETS (lower priced interior sets):					
(with the FOLLOWING LEVERS/KNOBS & Escutcheons listed ONLY). IN HOT WAX OR ANTIQUE ROSE PATINA ONLY HL121, HL122, HL123, HL124, HL125, HL126, HL127, HL128, HL141, HK757					
NOTE: IRON ESCUTCHEONS DO NOT WORK WITH DOORS THINNER THAN 1.75"! Call us for custom thin door upcharges					
HE603	HE603	3" x 3" Notched Corner		PP-TL PR-TL FD SD	387 408 290 145
HE604	HE604	2.5" x 4" Beveled		PP-TL PR-TL FD SD	387 408 290 145
HE617	HE617	2.75" diam Round		PP-TL PR-TL FD SD	387 408 290 145

**HARDWARE RENAISSANCE
PRICE LIST EFFECTIVE MAY 1, 2018**

CODE EXTERIOR	CODE INTERIOR			FUNCTION	LIST PRICE
IRON PRIVACY MORTISE BOLTS:					
PMB-CO1	HE487	2.5" x 6" Fleur de Lis		PMB	234
PMB-CO1	HE623	3" x 3" Notched Corner		PMB	214
PMB-CO1	HE623N	2.5" x 3" Notched Corner		PMB	214
PMB-CO1	HE625	2.5" x 3.5" Skewed Corner		PMB	214
PMB-CO1	HE625M	2.5" x 3.5" Monte Vista		PMB	214
PMB-CO1	HE627	2 5/8" diam Art Nouveau		PMB	214
PMB-CO1	HE631	2.5" x 3" Manhattan		PMB	214
PMB-CO1	HE633	4" x 2.25" Step		PMB	214
PMB-CO1	HE635	2.75" diam Round		PMB	214



**HARDWARE RENAISSANCE
PRICE LIST EFFECTIVE MAY 1, 2018**

CODE EXTERIOR	CODE INTERIOR	FUNCTION	LIST PRICE
PMB-CO1	HE637 2.5" x 3" Beveled 	PMB	214
PMB-CO1	HE657 3" x 3" Step 	PMB	214
PMB-CO1	HE681 2.5" x 2.75" El Secreto 	PMB	214
PMB-CO1	HE683 2.5" x 3" Cody 	PMB	214
PMB-CO1	HE685 3" x 4.5" Avila 	PMB	234
PMB-CO1	HE687 2.5" x 4" Sierra 	PMB	214
PMB-CO1	HE691 3" x 3" Straight Edge 	PMB	214

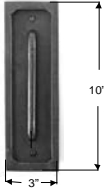
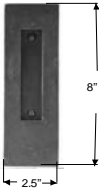
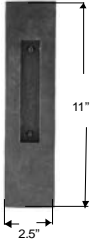
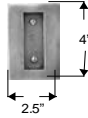

**HARDWARE RENAISSANCE
PRICE LIST EFFECTIVE MAY 1, 2018**

CODE EXTERIOR	CODE INTERIOR		FUNCTION	LIST PRICE
IRON STRIKE-BAR LATCH PASSAGE, PRIVACY, DUMMY SETS:				
<p>These unique sets have no internal components except for a spindle. Can be ordered for door thicknesses from 1" - 4". Sets are HANDED.</p> <p>Privacy function is with privacy chain on active side (long bar side), and emergency egress on other side. With mortise strike as shown. Contact us for surface strike or other custom strike requirements.</p>				
HS501	HS501	Horizontal (13" w)	PP PR FD SD	722 752 660 330
<p>Available with any lever. MUST SPECIFY LEVER (shown with HL111-R)</p>				
HS501S	HS501S	Horizontal (8" w)	PP PR FD SD	672 702 626 313
<p>Available with any lever. MUST SPECIFY LEVER (shown with HL113-R)</p>				
HS502	HS502	T-shaped	PP PR FD SD	672 702 626 313
<p>Available with any lever. MUST SPECIFY LEVER (shown with HL111-R)</p>				
HS503	HS503	Vertical 3" x 10"	PP PR FD SD	688 718 660 330
<p>Available with any lever. MUST SPECIFY LEVER (shown with HL101-R)</p>				
HS503S	HS503S	Vertical 3" x 7"	PP PR FD SD	672 702 626 313
<p>Available with any lever. MUST SPECIFY LEVER (shown with HL101-R)</p>		<p>(privacy set shown)</p>		
HS504	HS504	Tweezer	PP PR FD SD	672 702 626 313
<p>No lever options</p>				

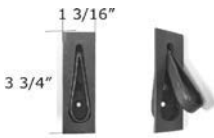
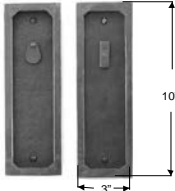
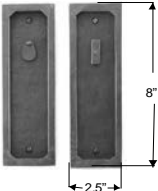

HARDWARE RENAISSANCE PRICE LIST EFFECTIVE MAY 1, 2018				
CODE EXTERIOR	CODE INTERIOR		FUNCTION	LIST PRICE
HS505	HS505	Stoker		
No lever options				PP 722 PR 752 FD 660 SD 330
HS507	HS507	Bermuda Gate Latch		
No lever options				PP 672 PR 702 FD 626 SD 313
HS507S	HS507S	Petite Bermuda Gate Latch		
No lever options				PP 672 PR 702 FD 626 SD 313
HS508	HS508	Santa Barbara		
Available with any lever. MUST SPECIFY LEVER (shown with HL101-R)				PP 672 PR 702 FD 626 SD 313
HS509	HS509	Scottsdale		
No lever options				PP 672 PR 702 FD 626 SD 313
HS510	HS510	Petite Latch		
No lever options				PP 520 PR 550 FD 486 SD 243
HS514	HS514	Sierra		
				PP 688 PR 718 FD 660 SD 330
HS522	-	BARN DOOR LATCH (Single-sided)		
				PP 450

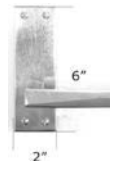
HARDWARE RENAISSANCE PRICE LIST EFFECTIVE MAY 1, 2018			
CODE EXTERIOR	CODE INTERIOR		FUNCTION LIST PRICE
IRON POCKET DOOR HARDWARE:			
HP711	3" x 10" Flush Pull		188
HP712	2.5" x 8" Flush Pull		176
HP713	2.5" x 11" Flush Pull		188
HP714	2.5" x 4" Flush Pull		104
HP710	5" Edge Pull		90
HP804	Tear drop Edge Pull		148
HP711-PR HP711-EN HP711-FD	3" x 10" Pocket Mortise Privacy Set 3" x 10" Pocket Mortise Keyed Set 3" x 10" Pocket Full Dummy (w/ Pocket Mortise strike/pull) (for double pocket/ sliding doors)	 HP711 Pocket Privacy Set	912 942 730
HP712-PR HP712-EN HP712-FD	2.5" x 8" Pocket Mortise Privacy Set 2.5" x 8" Pocket Mortise Keyed Set 2.5" x 8" Pocket Full Dummy (w/ Pocket Mortise strike/pull) (for double pocket/ sliding doors)	 HP712 Pocket Privacy Set	898 928 722

**HARDWARE RENAISSANCE
PRICE LIST EFFECTIVE MAY 1, 2018**

CODE EXTERIOR	CODE INTERIOR			FUNCTION	LIST PRICE
IRON SCREEN DOOR HARDWARE:					
HE651	HE651	2" x 3" Straight Edge (w/ tubular latch)		PP-TL FD SD	488 399 200
HE652	HE652	2" x 6" Straight Edge (w/ Screen Door Mortise Lock)		PP PR PT FD SD	652 811 798 431 215
HE652B	HE652B	2" x 6" Beveled (w/ Screen Door Mortise Lock)		PP PR PT FD SD	652 811 798 431 215

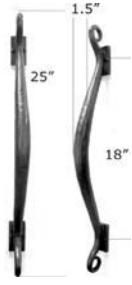

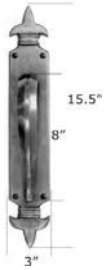
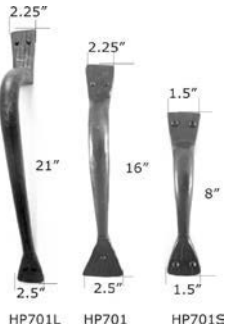
**HARDWARE RENAISSANCE
PRICE LIST EFFECTIVE MAY 1, 2018**

CODE EXTERIOR	CODE INTERIOR	FUNCTION	LIST PRICE
IRON DOOR/ APPLIANCE PULLS:			
HP113L	25" Scrolled Pull 		598
HP441	15" Normandy Pull 		482
HP442	14.5" Seville Pull 		482
HP484	8" Fleur de Lis Pull 		428
HP701S HP701 HP701L	8" Fishtail Pull 16" Fishtail Pull 21" Fishtail Pull 		235 442 538

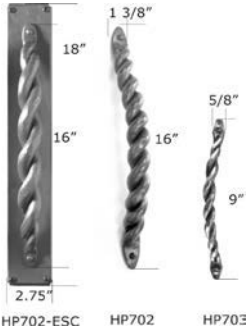
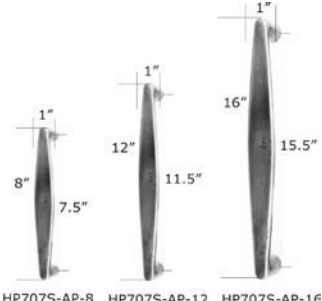

**HARDWARE RENAISSANCE
PRICE LIST EFFECTIVE MAY 1, 2018**

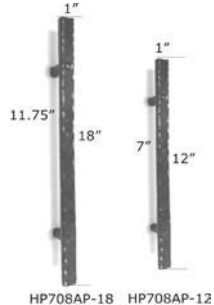
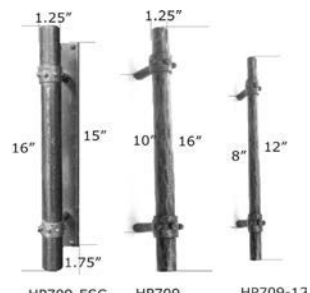
CODE EXTERIOR	CODE INTERIOR	FUNCTION	LIST PRICE
HP702-ESC HP702 HP703	16" Rope Pull w/ 18" Escutcheon 16" Rope Pull 9" Rope Pull		596 415 190
	 <p>HP702-ESC HP702 HP703</p>		
HP705S HP705	6" East-West Pull 12" East-West Pull		235 430
HP706S HP706 HP706-ESC	8" Trio Pull 14" Trio Pull 14" Trio Pull w/ 13" Escutcheon	5" c-to-c 10" c-to-c	190 350 456
HP707 HP707L	12.25" El Secreto Pull 20" El Secreto Pull		430 538
HP707S-AP-8 HP707S-AP-12 HP707S-AP-16	8" El Secreto Appliance Pull 12" El Secreto Appliance Pull 16" El Secreto Appliance Pull	7.5" c-to-c 11.5" c-to-c 15.5" c-to-c	190 268 318
	 <p>HP707S-AP-8 HP707S-AP-12 HP707S-AP-16</p>		

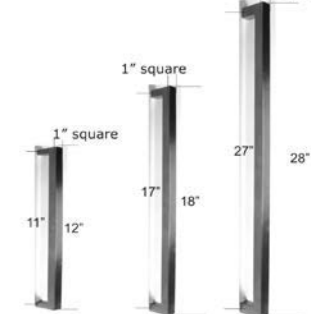

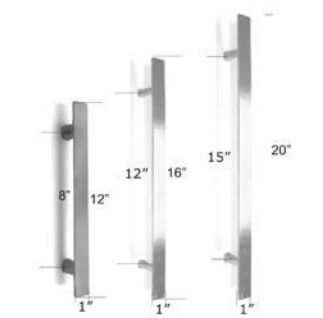
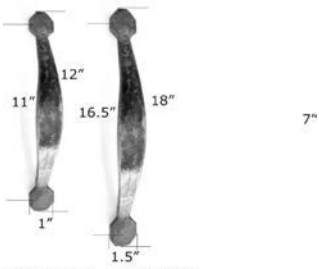

**HARDWARE RENAISSANCE
PRICE LIST EFFECTIVE MAY 1, 2018**

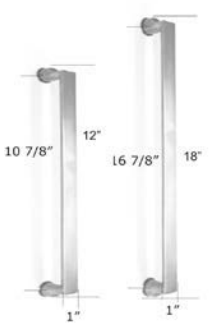
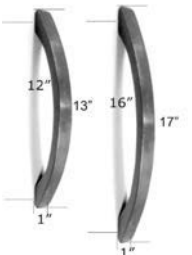
CODE EXTERIOR	CODE INTERIOR	FUNCTION	LIST PRICE
HP708AP-12 HP708AP-18	<p>12" Rectangular Appliance Pull 18" Rectangular Appliance Pull</p>  <p>HP708AP-18 HP708AP-12</p>	7" c-to-c 11.75" c-to-c	289 419
HP709-12 HP709 HP709-ESC	<p>12" Galisteo Pull 16" Galisteo Pull 16" Galisteo Pull w/ 15" Escutcheon</p>  <p>HP709-ESC HP709 HP709-12</p>	8" c-to-c 10" c-to-c	305 497 596
HP724-8 HP724-ESC	<p>8" Verona Pull 8" Verona Pull w/ 12" Escutcheon</p>  <p>HP724-ESC HP724-8</p>	6 7/8" c-to-c	222 382
HP725-8 HP725-12 HP725-16 HP725-20	<p>8" Milan Pull 12" Milan Pull 16" Milan Pull 20" Milan Pull</p>  <p>HP725-8 HP725-12 HP725-16 HP725-20</p>	7.5" c-to-c 11.5" c-to-c 15.25" c-to-c 19.25" c-to-c	222 305 432 518
HP726AP-12 HP726AP-18 HP726AP-28	<p>12" Stockholm Pull 18" Stockholm Pull 28" Stockholm Pull</p>  <p>HP726AP-12 HP726AP-18 HP726AP-28</p>	11" c-to-c 17" c-to-c 27" c-to-c	205 324 518

**HARDWARE RENAISSANCE
PRICE LIST EFFECTIVE MAY 1, 2018**

CODE EXTERIOR	CODE INTERIOR	FUNCTION	LIST PRICE
HP754AP-12 HP754AP-16 HP754AP-20	<p>12" Scottsdale Pull 16" Scottsdale Pull 20" Scottsdale Pull</p>  <p>HP754L-AP-12 HP754L-AP-16 HP754L-AP-20</p>	8" c-to-c 12" c-to-c 15" c-to-c	268 318 448
HP767AP-12 HP767AP-18	<p>12" Hampton Pull 18" Hampton Pull</p>  <p>HP767AP-12 HP767AP-18</p>	11" c-to-c 16.5" c-to-c	246 365
HP771	<p>14" Casa California Pull</p> 	7" c-to-c	430
HP772AP-12 HP772AP-18	<p>12" Prescott Pull 18" Prescott Pull</p>  <p>HP772AP-12 HP772AP-18</p>	10 7/8" c-to-c 16 7/8" c-to-c	268 365
HP773AP-12 HP773AP-16	<p>13" Arc Pull 17" Arc Pull</p>  <p>HP773AP-12 HP773AP-16</p>	12" c-to-c 16" c-to-c	246 311

**HARDWARE RENAISSANCE
PRICE LIST EFFECTIVE MAY 1, 2018**







CODE EXTERIOR	CODE INTERIOR	FUNCTION	LIST PRICE
HP783	19" Balboa Pull 		488
HP785	20" Avila Pull 	16" c-to-c	536
HP791AP-12 HP791AP-16	12.5" Monte Vista Pull 16.5" Monte Vista Pull 	12" c-to-c 16" c-to-c	268 318
HP793AP-12 HP793AP-16	12.5" Cody Pull 16.5" Cody Pull 	12" c-to-c 16" c-to-c	268 318

**HARDWARE RENAISSANCE
PRICE LIST EFFECTIVE MAY 1, 2018**

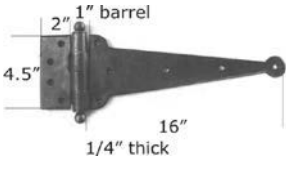
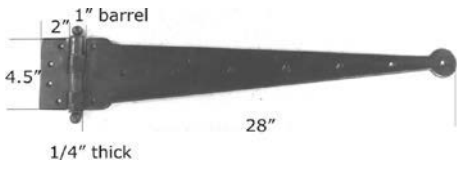

CODE EXTERIOR	CODE INTERIOR	FUNCTION	LIST PRICE
HP797AP-12 HP797AP-16	12.5" Sierra Pull 16.5" Sierra Pull	12" c-to-c 16" c-to-c	268 318
HP798AP-12 HP798AP-16	12.5" Dixon Pull 16.5" Dixon Pull	12" c-to-c 16" c-to-c	268 318
IRON PUSH PLATES:			
HE700 HE700B HE700NC	2.5" x 10" Straight Edge 2.5" x 10" Beveled 2.5" x 10" Notched		162 162 162
HE701 HE701B HE701NC	3" x 12" Straight Edge 3" x 12" Beveled 3" x 12" Notched		188 188 188
HE702 HE702B HE702NC	3" x 18" Straight Edge 3" x 18" Beveled 3" x 18" Notched		254 254 254

**HARDWARE RENAISSANCE
PRICE LIST EFFECTIVE MAY 1, 2018**





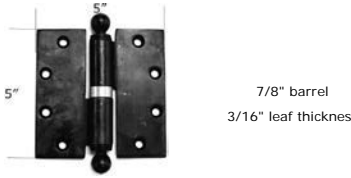
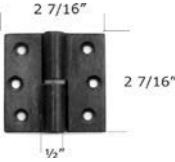

CODE EXTERIOR	CODE INTERIOR	FUNCTION	LIST PRICE
IRON DUMMY STRAPS & BRACES:			
HB351	Single Arm Brace		74
HB355	8" Corner Brace		118
HB356	Scrolled Strap		228
HB357	Arrow-head Strap		302
HB358	Chateau Strap		302
HB358L	Chateau Long Strap		348
HB359	Pistoria Brace		364
HB365-28 HB365-18	28" Straight Strap 18" Straight Strap		358 236
HB367	T-Brace		168



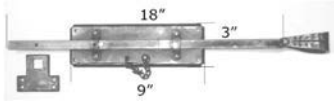

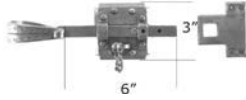
HARDWARE RENAISSANCE PRICE LIST EFFECTIVE MAY 1, 2018		FUNCTION	LIST PRICE
CODE EXTERIOR	CODE INTERIOR		
HB361-D	16" Dummy Strap		246
HB363-D	28" Dummy Strap		386
IRON STRAP HINGES:			
Specify if strap hinges are going to be installed half-mortise or full-flat surface			
HB361	16" Heavy Duty Strap Hinge		396
HB363	28" Heavy Duty Strap Hinge		542
HB369	4" x 3.5" Fleur de Lis Strap Hinge		378
HB371 MUST SPECIFY HANDING!	33" Pintle Strap Hinge		584
HB372 MUST SPECIFY HANDING!	30" Bud Tip Pintle Strap Hinge		564
HB451 HB452 HB453	12" Bean Strap Hinge 18" Bean Strap Hinge 21" Bean Strap Hinge		398 460 498

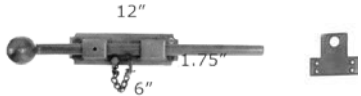
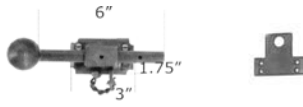



**HARDWARE RENAISSANCE
PRICE LIST EFFECTIVE MAY 1, 2018**

CODE EXTERIOR	CODE INTERIOR	FUNCTION	LIST PRICE
IRON PINTLE (GRAVITY) HINGES:			
These hinges are handed. Must specify handing!			
HN405 HN406 HN408 HN404	5" X 5" 4.5" X 4" 4.5" x 4.5" 6" X 6"	 <p>7/8" barrel 3/16" leaf thickness</p>	185 172 172 233
MUST SPECIFY HANDING!			
HNC110 MUST SPECIFY HANDING!	2 7/16" x 2 7/16" Cabinet Pintle Hinge	 <p>2 7/16" 2 7/16" 1/2"</p>	124
HNC150 MUST SPECIFY HANDING!	2"x6" Cabinet Pintle Hinge	 <p>2" 6" 1/2"</p>	143

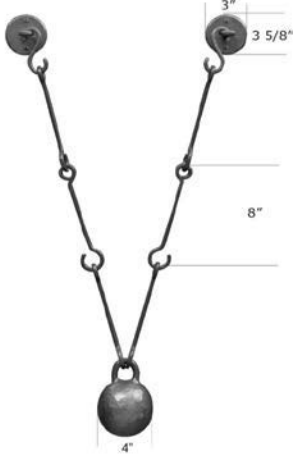

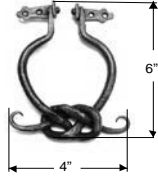
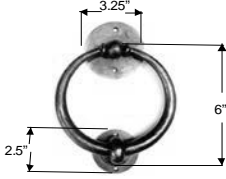
**HARDWARE RENAISSANCE
PRICE LIST EFFECTIVE MAY 1, 2018**

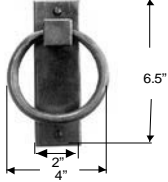
CODE EXTERIOR	CODE INTERIOR		FUNCTION	LIST PRICE
IRON SURFACE & CANE BOLTS:				
With Mortise Strike standard. Specify surface strike if required				
HB280	24"	Surface Bolt		554
HB281	18"	Surface Bolt		448
HB283	12"	Surface Bolt		376
HB285	6"	Surface Bolt		292
HB286	24"	Dunn Surface Bolt		554
HB287	18"	Dunn Surface Bolt		448
HB288	12"	Dunn Surface Bolt		376
HB289	6"	Dunn Surface Bolt		292
HB274	24"	Narrow Guide Surface Bolt		512
HB273	18"	Narrow Guide Surface Bolt		416

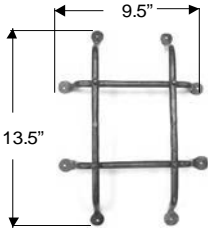
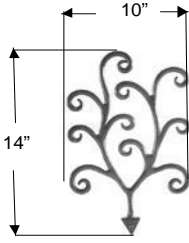
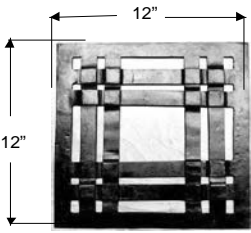

HARDWARE RENAISSANCE PRICE LIST EFFECTIVE MAY 1, 2018			FUNCTION	LIST PRICE
CODE EXTERIOR	CODE INTERIOR			
HB272	12"	Narrow Guide Surface Bolt		352
HB271	6"	Narrow Guide Surface Bolt		270
HB233	18" custom lengths & available	Cane bolt		418
HB520		Slide Bolt		316
HGC600		Cannonball Gate Closer		1,468

HARDWARE RENAISSANCE PRICE LIST EFFECTIVE MAY 1, 2018			
CODE EXTERIOR	CODE INTERIOR		FUNCTION LIST PRICE
IRON DOOR KNOCKERS:			
HD252	Knot		344
HD254	Ring		344
HD255	Twist		344
HD256	East-West		344
HD257	East-West II		334
IRON KICK PLATES:			
HKP810	34" x 8" x 1/8"	 HKP810: 34" x 8" x 1/8" Specify Straight Edge, Beveled (square corners), or Notched.	478

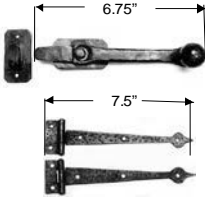
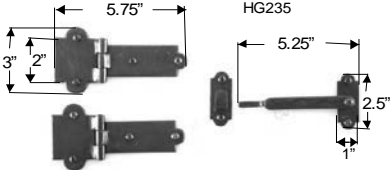

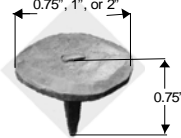
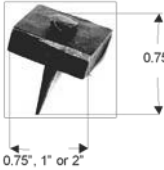
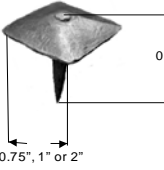
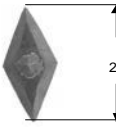

**HARDWARE RENAISSANCE
PRICE LIST EFFECTIVE MAY 1, 2018**

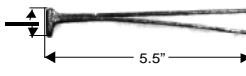
CODE EXTERIOR	CODE INTERIOR	FUNCTION	LIST PRICE
IRON SPEAKEASY GRILLES & LATCHES:			
HG285	Speakeasy Grille		292
			
HG287	Chateau Grille		360
			
HG288	Craftsman Grille		360
			
HG290	Quarterfoil grille		626
			
HG233 HG233-L HG233-S	Speakeasy Latch & Hinge Straps (pair) Speakeasy Latch ONLY Speakeasy Hinge Straps (pair)		270 172 98
			
HG235 HG235-L HG235-S	Arch Latch & Hinge straps (pair) Arch Latch ONLY Arch Hinge Straps (pair)		388 228 160
			



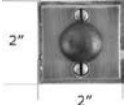

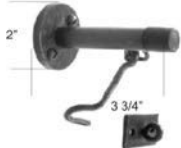
**HARDWARE RENAISSANCE
PRICE LIST EFFECTIVE MAY 1, 2018**

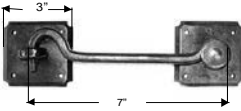
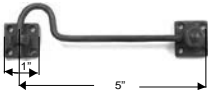
CODE EXTERIOR	CODE INTERIOR	FUNCTION	LIST PRICE
IRON CLAVOS:			
HC331 HC332 HC333	Round 0.75" Round 1" Round 2"		18 20 24
			
HC341 HC342 HC343	Square 0.75" Square 1" Square 2"		18 20 24
			
HC351 HC352 HC353	Pyramid 0.75" Pyramid 1" Pyramid 2"		18 20 24
			
HC323	Diamond 2"		24
			
HC362 HC363	Dome 1" Dome 2"		24 36
			
HN390	Split Nail		18
			





**HARDWARE RENAISSANCE
PRICE LIST EFFECTIVE MAY 1, 2018**

CODE EXTERIOR	CODE INTERIOR	FUNCTION	LIST PRICE
IRON DOOR STOPS & HOOK-AND-EYE:			
HD258	Contemporary Floor stop		106
HD259	Wall door stop		94
HD261	Base stop 3 3/4"		64
HD261W	Base stop with hook		78
HD262	Floor door stop		82
HD262W	Floor door stop with hook		96
HB370L	Hook & Eye 7"	 <p>Hook & Eye - Large HB370L</p>	208
HB370S	Hook & Eye 5"	 <p>Hook & Eye - Small HB370S</p>	118

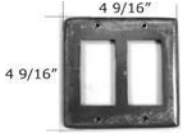
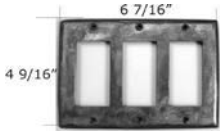
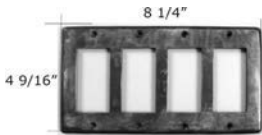

**HARDWARE RENAISSANCE
PRICE LIST EFFECTIVE MAY 1, 2018**

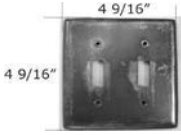
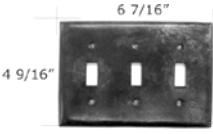

CODE EXTERIOR	CODE INTERIOR	FUNCTION	LIST PRICE
IRON DOOR BELL BUTTONS:			
Any escutcheon can be ordered as door bell button. Contact us for pricing.			
HE603-BB	3" x 3" Notched Corner		120
			
HE651-BB	2" x 3" Straight Edge		120
			
HE651NC-BB	2" x 3" Notched		120
			
HE627-BB	2 5/8" Round Art Nouveau		120
			

**HARDWARE RENAISSANCE
PRICE LIST EFFECTIVE MAY 1, 2018**

CODE EXTERIOR	CODE INTERIOR		FUNCTION	LIST PRICE
IRON SWITCH PLATE & OUTLET COVERS:				
HSP1	2 3/4" x 4 9/16"	Single Decora Switch		72
HSP2	4 9/16" x 4 9/16"	Double Decora Switch		96
HSP3	6 7/16" x 4 9/16"	Triple Decora Switch		138
HSP4	8 1/4" x 4 9/16"	Quad Decora Switch		186
HSPS1	2 3/4" x 4 9/16"	Single Switch Cover		72
HSPS2	4 9/16" x 4 9/16"	Double Switch Cover		96
HSPS3	6 7/16" x 4 9/16"	Triple Switch Cover		138
HSPC-cable	2 3/4" x 4 9/16"	Single Cable Cover		72

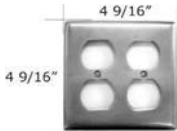
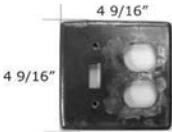
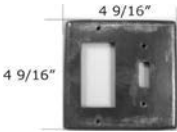
**HARDWARE RENAISSANCE
PRICE LIST EFFECTIVE MAY 1, 2018**

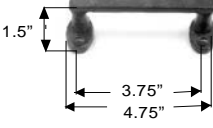
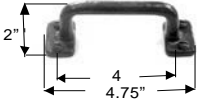
CODE EXTERIOR	CODE INTERIOR	FUNCTION	LIST PRICE
HSPP	2 3/4" x 4 9/16" Single Cover Plate 		72
HOP1	2 3/4" x 4 9/16" Double Outlet Cover 		72
HOP2	4 9/16" x 4 9/16" Quad Outlet Cover 		96
HSOP2	4 9/16" x 4 9/16" Combo Switch & Outlet 		96
HSOP3	4 9/16" x 4 9/16" Combo Switch & Decora 		96

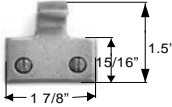
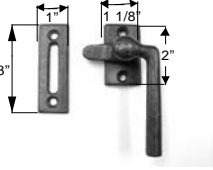
HARDWARE RENAISSANCE PRICE LIST EFFECTIVE MAY 1, 2018			
CODE EXTERIOR	CODE INTERIOR		FUNCTION LIST PRICE
IRON WINDOW HARDWARE:			
European Push & Tilt HE500	1.5"x3" Push & Tilt Esc (w/ mini levers) Available with 90 degree turn mechanism Available with other mini levers - contact us	 HE500-HL138M	288
Double Hung HW111	Scottsdale Sash Pull		58
HW112	Classic Sash Pull		56
HW114	Sash Lock Specify handing - RH shown		106
HW117	Sash Lift		46
Casement HW115	Casement Latch (mortise or universal strike) Specify handing - RH shown		258

CODE
 EXTERIOR

CODE
 INTERIOR

FUNCTION

LIST
 PRICE

IRON LIGHT SCONCE COVERS:









HLT801





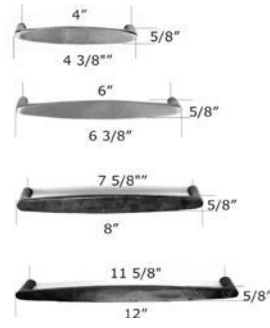

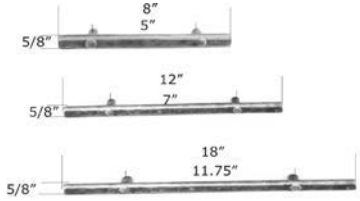

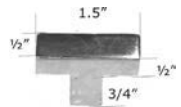
Louvre Light Sconce Cover
 With Amber Mica shade

NOTE: COVER ONLY - DOES NOT INCLUDE ELECTRICAL FIXTURE

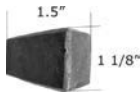
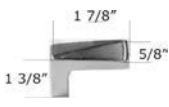





1,218

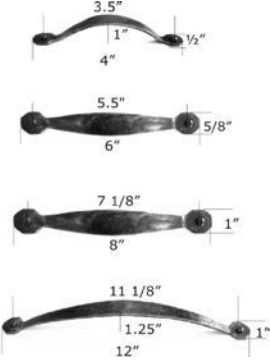

HARDWARE RENAISSANCE PRICE LIST EFFECTIVE MAY 1, 2018			FUNCTION	LIST PRICE
CODE EXTERIOR	CODE INTERIOR			
IRON CABINET KNOBS & PULLS:				
HP703		9" Rope 		190
HP704		4.5" Rope 		72
HP706S		8" Trio 	5" c-to-c	190
HP765		4" Trio 	2.5" c-to-c	72
HP707SC-4 HP707SC-6 HP707SC-8 HP707SC-12		4.25" El Secreto 6.25" El Secreto 8" El Secreto 12" El Secreto 	4" c-to-c 6" c-to-c 7 5/8" c-to-c 11 5/8" c-to-c	62 82 124 145
HP731		5" Rectangular 	3" c-to-c	62
HP708-8 HP708-12 HP708-18		8" Rectangular 12" Rectangular 18" Rectangular 	5" c-to-c 7" c-to-c 11.75" c-to-c	124 142 202
HP720		Notched Ring Pull 		82
HP726-4 HP726-6 HP726-9 HP726-12 HP726-15 HP726-24		Stockholm 4 3/8" Stockholm 6 3/8" Stockholm 9 3/8" Stockholm 12 3/8" Stockholm 15 3/8" Stockholm 24 3/8" 	4" c-to-c 6" c-to-c 9" c-to-c 12" c-to-c 15" c-to-c 24" c-to-c	50 62 88 104 122 164
HP727		Stockholm T- Knob 		52

HARDWARE RENAISSANCE PRICE LIST EFFECTIVE MAY 1, 2018			
CODE EXTERIOR	CODE INTERIOR		FUNCTION LIST PRICE
HP731	5" Rectangular		3" c-to-c 62
HP732	Bungalow Pull		62
HP733 HP734	1" Round 2" Round		30 38
HP735	East-West		52
HP737	L-shaped Milan		56
HP738	Melon		56
HP741	Forged		56
HP743 HP744	1" Pyramid 2" Pyramid		30 38
HP751	Aegean		56
HP753	Oblong		56
HP754	Scottsdale T- Knob		56

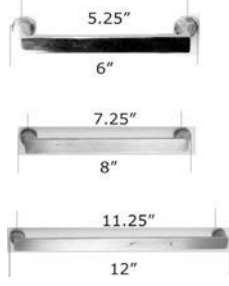
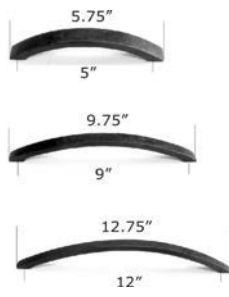
HARDWARE RENAISSANCE PRICE LIST EFFECTIVE MAY 1, 2018					
CODE EXTERIOR	CODE INTERIOR		FUNCTION	LIST PRICE	
HP754M HP754L-8 HP754DL-8 HP754DL-12		Scottsdale 5" double-post Scottsdale 8" single-post Scottsdale 8" double-post Scottsdale 12" double-post		3.75" c-to-c 6" c-to-c 10" c-to-c	62 124 124 145
HP758		Sunrise			52
HP760		Tokyo Ring Pull			62
HP761		Bin Pull			62
HP762		Casa California			52
HP763		Mushroom			48
HP764		Martini			48
HP766-4 HP766-6 HP766-8 HP766-12		4" Milan 6.5" Milan 8.5" Milan 12.5" Milan		3.5" c-to-c 6" c-to-c 8" c-to-c 12" c-to-c	62 86 124 148

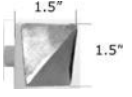
**HARDWARE RENAISSANCE
PRICE LIST EFFECTIVE MAY 1, 2018**

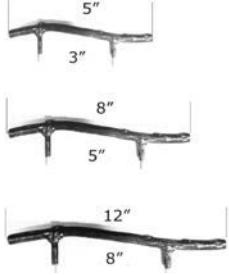

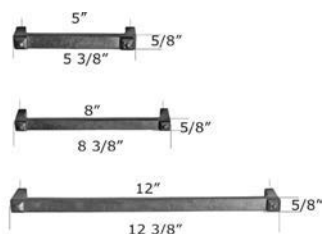
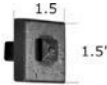
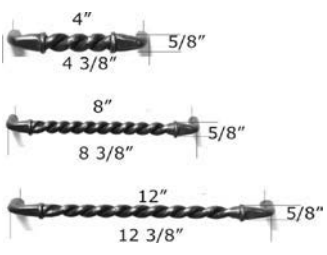

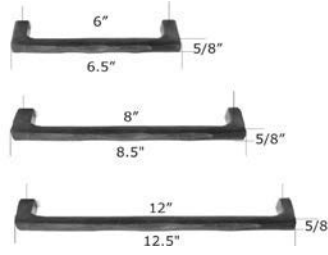
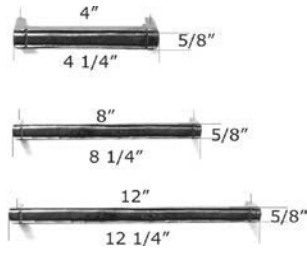

CODE EXTERIOR	CODE INTERIOR	FUNCTION	LIST PRICE
HP767-4 HP767-6 HP767-8 HP767-12	4" Hampton 6" Hampton 8" Hampton 12" Hampton		3.5" c-to-c 62 5.5" c-to-c 82 7 1/8" c-to-c 104 11 1/8" c-to-c 134
HP768 HP768L	6" Casa Cal II Casa Cal II 13.25"	 <p>HP768 Casa California II HP768L: 12" c-to-c, 13.25" total length</p>	5" c-to-c 82 12" c-to-c 234
HP769	7" Casa Cal III		6" c-to-c 94
HP772-6 HP772-8 HP772-12	6" Prescott 8" Prescott 12" Prescott		5.25" c-to-c 72 7.25" c-to-c 106 11.25" c-to-c 145
HP773-5 HP773-9 HP773-12	5.75" Arc 9.75" Arc 12.75" Arc		5" c-to-c 62 9" c-to-c 104 12" c-to-c 145
HP774	Milan Rectangular		52
HP775	Milan Square		60

HARDWARE RENAISSANCE PRICE LIST EFFECTIVE MAY 1, 2018				
CODE EXTERIOR	CODE INTERIOR		FUNCTION	LIST PRICE
HP778		Trio T- Knob 		60
HP788-5 HP788-8 HP788-12		5" Twig 8" Twig 12" Twig 	3" c-to-c 5" c-to-c 8" c-to-c	62 104 148
HP791-4 HP791-6 HP791-8 HP791-12		4 3/8" Monte Vista 6 3/8" Monte Vista 8 3/8" Monte Vista 12 3/8" Monte Vista 	4" c-to-c 6" c-to-c 8" c-to-c 12" c-to-c	62 82 104 148
HP793-5 HP793-8 HP793-12		5 3/8" Cody 8 3/8" Cody 12 3/8" Cody 	5" c-to-c 8" c-to-c 12" c-to-c	62 104 148
HP794		Cody Square 		62
HP795-4 HP795-6 HP795-8 HP795-12		4 3/8" Avila 6 3/8" Avila 8 3/8" Avila 12 3/8" Avila 	4" c-to-c 6" c-to-c 8" c-to-c 12" c-to-c	66 90 124 164

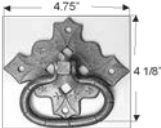

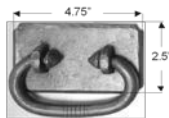

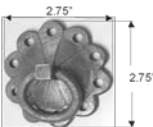
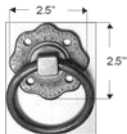

**HARDWARE RENAISSANCE
PRICE LIST EFFECTIVE MAY 1, 2018**

CODE EXTERIOR	CODE INTERIOR	FUNCTION	LIST PRICE
HP797-4 HP797-8 HP797-12	4 3/8" Sierra 8 3/8" Sierra 12 3/8" Sierra	4" c-to-c 8" c-to-c 12" c-to-c	62 104 148
HP798-6 HP798-8 HP798-12	6.5" Dixon 8.5" Dixon 12.5" Dixon	6" c-to-c 8" c-to-c 12" c-to-c	70 104 148
HP799	Dixon Round		54



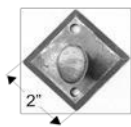

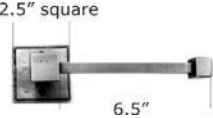
HARDWARE RENAISSANCE PRICE LIST EFFECTIVE MAY 1, 2018			
CODE EXTERIOR	CODE INTERIOR		FUNCTION LIST PRICE
IRON DECORATIVE RING PULLS:			
HP716	Catalonia		216
HP717	Seville		188
HP718P	Merida		188
HP719	Guadalupe		188
HP736	Veracruz		188
HP739	Baja		156
HP740	Monterey		156
HP715	Ring Pull w/ twist		254

**HARDWARE RENAISSANCE
PRICE LIST EFFECTIVE MAY 1, 2018**

CODE EXTERIOR	CODE INTERIOR	FUNCTION	LIST PRICE
IRON BATH HARDWARE:			
ROBE HOOKS:			
HT702	Scroll Robe Hook		118
			
HT703	East-West		118
			
HT704	Casa California		118
			
HT709	Diamond Specify for escutcheon on SQUARE		118
			
TOILET PAPER HOLDERS:			
HT701	Diamond		134
			
HT705	East-West		160
			
HT706	Casa California		208
			
HT801	Art Nouveau		348
			

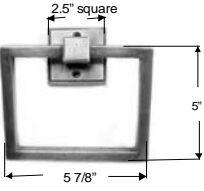
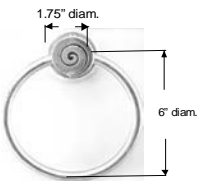
**HARDWARE RENAISSANCE
PRICE LIST EFFECTIVE MAY 1, 2018**

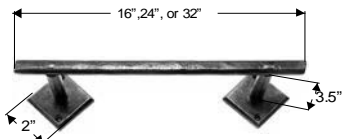
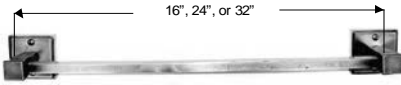
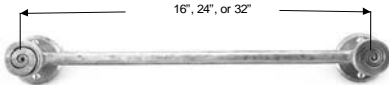
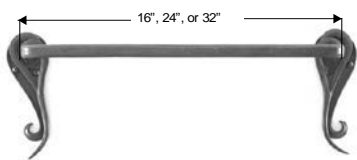
CODE EXTERIOR	CODE INTERIOR	FUNCTION	LIST PRICE
TOWEL RINGS:			
HT712	Diamond Specify for escutcheon on SQUARE		246
			
HT746	East-West		248
			
HT747	Casa California		298
			
HT812	Art Nouveau		488
			
TOWEL BARS:			
HT716 HT724 HT732	Diamond 16" Diamond 24" Diamond 32" Specify for escutcheons on SQUARE		232 264 320
			
HT736 HT737 HT738	East-West 16" East-West 24" East-West 32"		236 276 334
			
HT756 HT757 HT758	Casa California 16" Casa California 24" Casa California 32"		298 358 478
			
HT816 HT824 HT832	Art Nouveau 16" Art Nouveau 24" Art Nouveau 32"		698 786 890
			

HARDWARE RENAISSANCE PRICE LIST EFFECTIVE MAY 1, 2018			FUNCTION	LIST PRICE
CODE EXTERIOR	CODE INTERIOR			
IRON KEYLESS ENTRIES FOR HOSPITALITY				
Available for Ving Card or Saflok Systems. Contact us for information!				
HE401	MT-SELECT	4.5"x10" Oval Esc	ENTRY	CALL FOR PRICING
HE403	MT	3 3/8" x 10" Rectangular	ENTRY	