

Shower Doors

Price List National USA | Effective July 3, 2017



MOVING / forward

A better experience means always moving forward

We're inspired by you. You're constantly in motion, and never stop looking ahead. And your style is constantly evolving, helping refine the trends of tomorrow. That is why we believe to best serve you, we must always be moving forward — never complacent — finding new ways to enhance your success and enjoyment. We never stop asking questions or exploring innovative new opportunities to make business easier, products better and results more inspiring, no matter what the project. We are driven to continuously push the bounds, creating the best possible bathware experience.

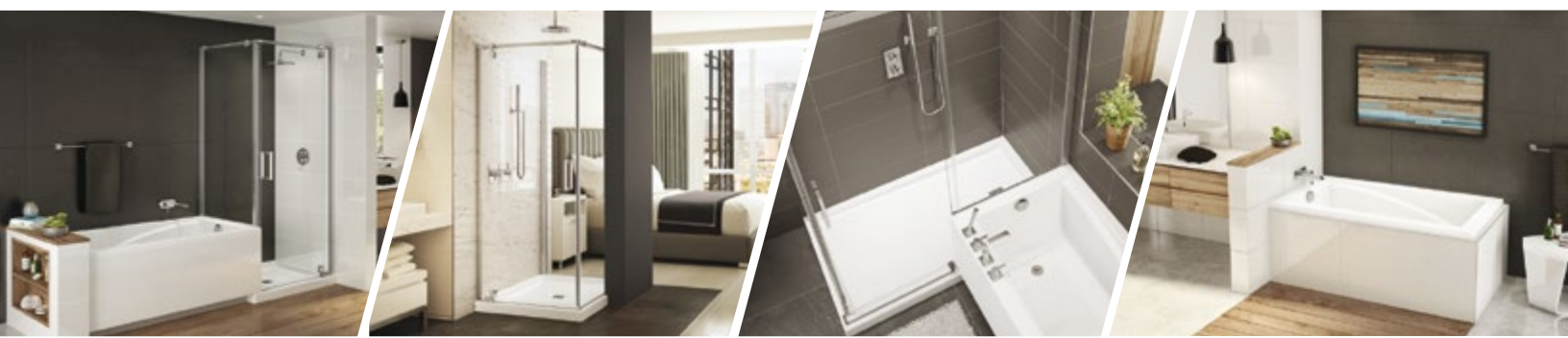

Table of Contents

Moving forward.....	6
---------------------	---

DOORS 7

Reference Guide: Doors.....	9
-----------------------------	---

MODULR DOORS

Recommended MAAx

Shower Bases for ModulR Doors	16
-------------------------------------	----

ModulR Shower Doors for bases 3636 137835/137856.....	18
--	----

ModulR Shower Doors for bases 4832 137833/137831/137859/137862/137837/ 137865/137868/137932/137933	19
--	----

ModulR Shower Doors for bases 4834 137833/137831/137858/137861/137836/ 137864/137867/137934/137935	20
--	----

ModulR Shower Doors for bases 4836 137833/137831/137857/137860/137835/ 137863/137866/137936/137937	21
--	----

ModulR Shower Doors for bases 6030	22
137832/137830.....	

ModulR Shower Doors for bases 6032 137832/137830/137870/137872/137837/ 137874/137876//137932/137933	23
---	----

ModulR Shower Doors for bases 6036 137832/137830/137869/137871/137835/ 137873/137875/137936/137937	24
--	----

ModulR Shower Doors for bathtubs 6032 137846/137878.....	25
---	----

DUEL DOORS

Recommended MAAx

Shower Bases for Duel Doors	28
-----------------------------------	----

Duel Shower Doors	29
136271/136272	

Duel Tub Door.....	30
136270.....	

Duel Return Panels.....	31
137310/137311	

EDGE SHIELDS

Recommended MAAx

Shower Bases for Edge Shields.....	34
------------------------------------	----

Edge Tub Shield	35
137500.....	

Edge Square Tub Shield.....	36
137501.....	

Edge Duo Tub Shield.....	37
137502.....	

Edge Duo Shower Shield	38
137504.....	

HALO DOORS

Recommended MAAx

Shower Bases for Halo Doors.....	40
----------------------------------	----

Halo Shower Doors	41
138996/138997	

Halo Return Panels 138998/139395/139396.....	42
---	----

Halo Tub Door	43
139398.....	

Halo Round	44
139399.....	

KAMELEON DOORS

Recommended MAAx

Shower Bases for Kameleon Doors	46
---------------------------------------	----

Kameleon Shower Doors - 6 mm.... 134562/134563/134564/134565	47
---	----

DIGITAL VERSION ONLY

Click on the product name or code to go directly to the selected page.

Click on the arrow  at the top right of every page in order to get back to the Table of Contents.

Kameleon SC Shower Doors - 6 mm 134662/134663/134664/134665	50
Kameleon Tub Doors - 6 mm	53
134560/134561	
Kameleon SC Tub Doors - 6 mm	55
134660/134661	
Kameleon Shower Doors - 8 mm	57
134571/134572	
Kameleon SC Shower Doors - 8 mm 134674/134675.....	59
Kameleon Tub Door - 8 mm	61
134573.....	
Kameleon SC Tub Door - 8 mm	63
134670.....	

LUMINESCENCE DOORS

Recommended MAAx

Shower Bases for Luminescence Doors.....	66
--	----

Luminescence Shower Doors	67
138992/138993	

Luminescence Tub Door	68
138994.....	

REVEAL DOORS

Recommended MAAx

Shower Bases for Reveal Doors	70
-------------------------------------	----

Reveal 71 Shower Doors 136676/136679/136677/136671/136883/136672	72
---	----

Reveal 71 Return Panels 136673/136674/136675.....	74
--	----

Reveal 75 Shower Doors 136678/136682/136880/136881	75
---	----

Reveal 75 Return Panels 136700/136701/136702.....	76
--	----

FRAMELESS SHOWER DOORS

Recommended MAAx

Shower Bases for Frameless Doors.....	78
---------------------------------------	----

Kleara 1-Panel Shower Doors 136445/136446/136447/136448/136449	81
---	----

Kleara 2-Panel Shower Doors 136450/136451/136452/136453/136454/ 136455/136456/136457/136458	83
---	----

Madono Shower Doors 105420/105416/105417/105418	86
--	----

Radia Neo-angle 137440/137441/137442.....	87
--	----

Radia Neo-round 137443/137444/137445.....	89
--	----

Radia Round.....	91
137446.....	

Radia Square.....	92
137447/137448	

BUILDER DOORS

Recommended MAAx

Shower Bases for Builder Doors.....	96
-------------------------------------	----

Decor Plus Shower Doors 135276/135280/135277.....	99
--	----

Decor Plus Tub Doors	100
136302/136300	

Mika Tub Door	101
105409.....	

Pivolok Shower Doors 136605/136615/136625/136626/136635/ 136645/136655/136656.....	102
--	-----

Pivolok Deluxe Shower Doors.....	104
136425/136435	

Polar Shower Doors	105
105413/105412	

Polar Tub Door	106
105410.....	

Triple Plus Shower Doors
 138299/138293/138294/138290/138296/138297/
 138291/138313/138314/138315/138311 107

Triple Plus Tub Doors
 138301/138308/138400..... 110

Silhouette Neo-angle Shower Doors 137904/137901 111

Silhouette Plus Neo-angle Shower Doors.....
 137700/137720/137710/137730/137750 112

PRODUCT SELECTOR 115

Alcove Shower Doors..... 116

Corner Shower Doors..... 118

Tub Doors..... 119

RECOMMENDED BASES 121



Alcove-Recommended MAAX Shower Bases 122

Corner-Recommended MAAX Shower Bases 125

GENERAL INFORMATION 127

Colors Patterns and Finishes 128

Terms, Conditions and Warranties..... 129

CONSULT, PRINT AND SHARE EASILY!

PDF versions of **all our up to date product technical drawings** are available on MAAX's website.

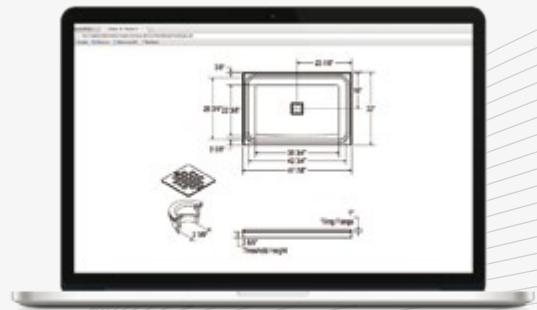

www.maax.com



We are always
**moving forward to
help you succeed**



Creating a positive experience drives every decision

Our top priority is making all aspects of working with MAAX as enjoyable and easy as possible. From simplifying the selection process, to fast, reliable deliveries and innovative features that make our bathware easy to install and enjoy. Our culture is focused on you and fuelled by passionate employees committed to quickly and completely addressing your needs, so that every point of interaction reinforces a great MAAX experience.



We never stop innovating to serve you

Our innovation is driven by you, with significant customer involvement throughout our development process. With three robust R&D centres and one of the category's only dedicated research and development teams, we are the industry leader in innovation — passionate about finding creative new ways to make the bathware experience easier, more productive, more successful and more enjoyable for you and your customers.

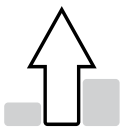

On-trend and complete bathware solutions

We are your single source for complete bathware solutions. We keep our finger on the pulse of the industry to continually refine our product offering with the fresh, in-demand styles and features you're looking for.

Everything we do is focused on helping you
Enjoy the Experience.



Doors



Duel door with B3Square 6032 shower base



Shower Doors

Unique Features



Soft Close System

This feature keeps ears and fingers safe by easing the door shut no matter how hard you slam it. This graceful, gradual closing – a great child-friendly feature for families – also helps minimize door-to-frame impact to extend product life.



Lotus Glass Protection

This protection increases resistance to wear and tear and has a non-stick surface that repels soap and water stains.



Lifting Hinge

This high quality hinge rises when the glass panel is pivoted, reducing the friction between the tub or base and the bottom gasket and prolonging the life of your products.



Clip and Push

Easy to unclip bottom door rollers to simplify maintenance. Simply unclip, slightly push the door panel and clean away!



Reversible Header

Some of MAAX shower doors feature a reversible header. It's up to you to select the side that suits your needs or the look you desire.



EZ Kleen

Keep your door sliding easily with this system that lets you clean the rail in a single swipe.



Sure-Glide

Sure-Glide track keeps panels in place for smooth and quiet operation. Innovative design eliminates soap and dirt buildup to make cleanup easy.

MAAX[®] MODULR

Shower Doors

The **ModulR** shower doors are so customizable that they can easily be added to any bathroom design. They bring a touch of sophistication to your projects, while being easy to maintain for the end consumers.



DISCOVER THE
ModulR products



maaxmodulr.com

Reference Guide: Doors

MODULR DOORS

MODULR SHOWER DOORS

p. 18



36 x 36 x 78
48 x 32 x 78
48 x 34 x 78
48 x 36 x 78
60 x 30 x 78
60 x 32 x 78
60 x 36 x 78



SOFT CLOSE™
MAAX



MANY CONFIGURATIONS*

MODULR TUB DOORS

p. 25



60 x 58
60 x 32 x 58



SOFT CLOSE™
MAAX



ALCOVE / CORNER

DUEL DOORS

DUEL SHOWER DOORS

p. 29



44-47 x 70 ½
56-59 x 70 ½



ALCOVE / CORNER



DUEL TUB DOOR

p. 30



56-59 x 55 ½



ALCOVE



DUEL RETURN PANELS

p. 31



32 x 74
36 x 74



CORNER



EDGE SHIELDS

EDGE - TUB SHIELD

p. 35



30 x 55 ½



ALCOVE



EDGE SQUARE - TUB SHIELD

p. 36



34 x 58



ALCOVE



EDGE DUO - TUB SHIELD

p. 37



42 x 58

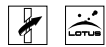

ALCOVE



EDGE DUO - SHOWER SHIELD

p. 38



42 x 75



ALCOVE



* ModulR shower doors are available in many configurations. Discover the complete product line and build a personalized ModulR shower on maaxmodulr.com/configurator

FRAME FINISHES



Chrome (084)



Dark Bronze (172 & 173)



Brushed Nickel (305)

Reference Guide: Doors

HALO DOORS

HALO SHOWER DOORS

p. 41



44½ - 47 x 78¾
56½ - 59 x 78¾

ALCOVE/CORNER



HALO RETURN PANELS

p. 42



32 x 78¾
34 x 78¾
36 x 78¾

CORNER



HALO TUB DOOR

p. 43



56½ - 59 x 59

ALCOVE



HALO ROUND

p. 44



36 x 36 x 76

CORNER



FRAME FINISHES



Chrome (084)



Dark Bronze (172 & 173)



Brushed Nickel (305)



All ModulR sliding doors are equipped with the Soft Close.
Optional Soft Close System also available on Kameleon doors.

SOFT CLOSE™
BY MAAAX

No More Slamming Doors

You'll love the "No Bang" effect with the **SOFT CLOSE system**. This feature keeps ears and fingers safe by easing the door shut no matter how hard you slam it. This **graceful, gradual closing**—a great child-friendly feature for families — also helps minimize door-to-frame impact to extend product life.

Reference Guide: Doors

KAMELEON DOORS

KAMELEON SHOWER DOORS 6 MM p. 47



40-44 x 71
43-47 x 71
51-55 x 71
55-59 x 71



SOFT CLOSE™
MAAX



ALCOVE

KAMELEON TUB DOORS 6 MM p. 53



51-55 x 57
55-59 x 57



SOFT CLOSE™
MAAX



ALCOVE

KAMELEON SHOWER DOORS 8 MM p. 57



43-47 x 71
55-59 x 71



SOFT CLOSE™
MAAX



ALCOVE

KAMELEON TUB DOOR 8 MM p. 61



55-59 x 57



SOFT CLOSE™
MAAX



ALCOVE

LUMINESCENCE DOORS

LUMINESCENCE SHOWER DOORS p. 67



44½-47 x 70½
56½-59 x 70½



ALCOVE

LUMINESCENCE TUB DOOR p. 68



56½ - 59 x 55½



ALCOVE

REVEAL DOORS

REVEAL 71 SHOWER DOORS p. 72



32½ - 35½ x 71½
38-41 x 71½
41½ - 44½ x 71½
44-47 x 71½
51½ - 54½ x 71½
56-59 x 71½



ALCOVE/CORNER

REVEAL 71 RETURN PANELS p. 74



32 x 71½
34 x 71½
36 x 71½



CORNER

FRAME FINISHES



Chrome (084)



Dark Bronze (172 & 173)



Brushed Nickel (305)

Reference Guide: Doors

REVEAL DOORS (cont'd)

REVEAL 75 SHOWER DOORS

p. 75

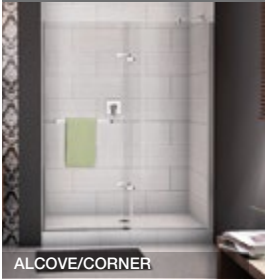

32½ - 35½ x 75
38-41 x 75
44-47 x 75
56-59 x 75



ALCOVE/CORNER

REVEAL 75 RETURN PANELS

p. 76



32 x 75
34 x 75
36 x 75

CORNER

FRAMELESS DOORS

KLEARA 1-PANEL - SHOWER DOORS

p. 81

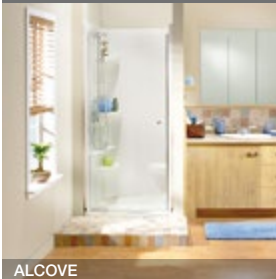

23½ - 25½ x 69
25½ - 27½ x 69
27½ - 29½ x 69
29½ - 31½ x 69
31½ - 33½ x 69

ALCOVE

KLEARA 2-PANEL - SHOWER DOORS

p. 83

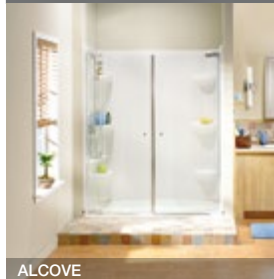

33½ x 36½ x 69
36½ x 39½ x 69
39½ x 42½ x 69
42½ x 45½ x 69
45½ x 48½ x 69
48½ x 51½ x 69
51½ x 54½ x 69
54½ x 57½ x 69
57½ x 60½ x 69

ALCOVE

MADONO - SHOWER DOORS

p. 86

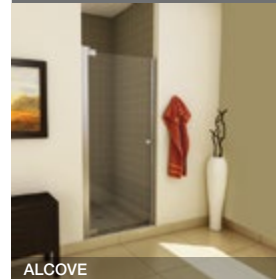

24½ - 26½ x 67
28½ - 30½ x 67
31½ - 33½ x 67
34½ - 36½ x 67

ALCOVE

RADIA NEO-ANGLE

p. 87



36 x 36 x 71½
38 x 38 x 71½
40 x 40 x 71½



CORNER

RADIA NEO-ROUND

p. 89



32 x 32 x 71½
36 x 36 x 71½
40 x 40 x 71½



CORNER

RADIA ROUND

p. 91



36 x 36 x 71½



CORNER

RADIA SQUARE

p. 92

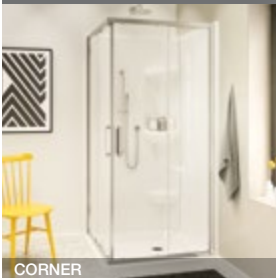

32 x 32 x 71½
36 x 36 x 71½



CORNER

FRAME FINISHES



Chrome (084)



Nickel (105)



Brushed Nickel (305)

Reference Guide: Doors

BUILDER DOORS

DECOR PLUS SHOWER DOORS p. 99

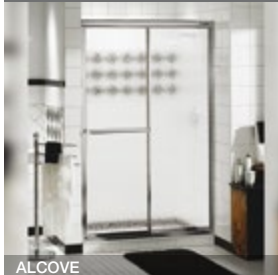

43 x 69
44 x 66
44 x 69

ALCOVE

DECOR PLUS TUB DOORS p. 100



56 1/2 x 56
59 1/2 x 56

ALCOVE

MIKA TUB DOOR p. 101

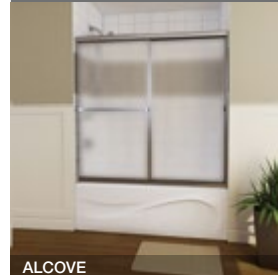

54 - 59 1/2 x 55 1/2

ALCOVE

PIVOLOK - SHOWER DOORS p. 102



19 - 20 1/4 x 64 1/2
21 - 22 3/4 x 64 1/2
23 - 24 3/4 x 64 1/2
25 - 26 3/4 x 64 1/2
27 - 28 3/4 x 64 1/2
29 - 30 3/4 x 64 1/2
31 - 32 3/4 x 64 1/2
33 - 34 3/4 x 64 1/2

ALCOVE

PIVOLOK DELUXE - SHOWER DOORS p. 104

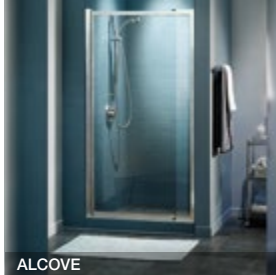

28 - 32 1/2 x 64 1/2
32 1/2 - 37 x 64 1/2

ALCOVE

POLAR SHOWER DOORS p. 105



42 - 47 1/2 x 68
54 - 59 1/2 x 68

ALCOVE

POLAR TUB DOOR p. 106



54 - 59 1/2 x 57 3/4

ALCOVE

TRIPLE PLUS SHOWER DOORS p. 107



36 x 69
40 x 66
42 1/2 x 66
43 x 69
44 1/2 x 66
48 x 66
48 x 69
52 1/2 x 66
54 1/2 x 66
58 x 66
59 1/2 x 71

ALCOVE



TRIPLE PLUS TUB DOORS p. 110

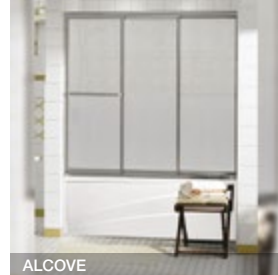

52 1/2 x 56
55 x 56
59 1/2 x 56

ALCOVE



SILHOUETTE NEO-ANGLE p. 111

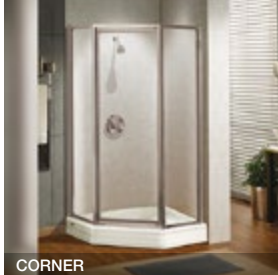

36 x 36 x 70
38 x 38 x 70

CORNER

SILHOUETTE PLUS NEO-ANGLE p. 112



36 x 36 x 70
38 x 38 x 70
40 x 40 x 70

CORNER

FRAME FINISHES

	Chrome (084)		Mat Silver (170)
---	--------------	---	------------------



More than 1000 + possibilities ONLINE!
maaxmodulr.com/configurator

MODULR



MAAX[®]
Enjoy the experience



ModulR Doors

ModulR corner sliding door with B3Square 6036

Recommended MAAX Shower Bases for ModulR Doors

Dimension	Configuration ▶	ModulR doors								
		Alcove		Corner		Alcove Deep	Wall-mounted		Tunnel	
Base (L x W) ¹ ▼	Model No ▼	Pivot	Sliding	Pivot	Sliding	Pivot	Pivot	Sliding	1 pivot	2 pivots
B3Square/ Round 3636	420000/410000	137835		137856						
B3Square/ Round 4832	420001/410001	137833	137831	137859	137862	137837	137865	137868	137932	137933
B3Square/ Round 4834	420002/410002	137833	137831	137858	137861	137836	137864	137867	137934	137935
B3Square/ Round 4836	420003/410003	137833	137831	137857	137860	137835	137863	137866	137936	137937
B3Square/ Round 6030	420004/410004	137832	137830							
B3Square/ Round 6032	420005/410005	137832	137830	137870	137872	137837	137874	137876	137932	137933
B3Square/ Round 6036	420006/410006	137832	137830	137869	137871	137835	137873	137875	137936	137937

1. L: Length, W: Width

Did you know?

You are not limited to B3 bases to create your dream ModulR shower! Whether you prefer **ceramic tile or a different base**, ModulR doors offer the solution. **By combining a ModulR alcove door with a glass panel** (see list below), you get the perfect fit for the space and materials you like.

No	Description	Chrome (084)	Brushed Nickel (305)
137845-900-XXX-000	ModulR Tub Return Panel 32 in.	\$ 413	\$ 446
137852-900-XXX-000	ModulR Shower Half Return Panel 16 in.	\$ 468	\$ 506
137851-900-XXX-000	ModulR Shower Half Return Panel 17 in.	\$ 473	\$ 512
137850-900-XXX-000	ModulR Shower Half Return Panel 18 in.	\$ 479	\$ 517
137854-900-XXX-000	ModulR Shower Window special 24 in.	\$ 535	\$ 578
137853-900-XXX-000	ModulR Shower Window special 30 in.	\$ 554	\$ 594
137849-900-XXX-000	ModulR Shower Window 32 in.	\$ 561	\$ 605
137848-900-XXX-000	ModulR Shower Window 34 in.	\$ 568	\$ 611
137847-900-XXX-000	ModulR Shower Window 36 in.	\$ 574	\$ 616
137841-900-XXX-000	ModulR Shower Return Panel 32 in.	\$ 413	\$ 446
137840-900-XXX-000	ModulR Shower Return Panel 34 in.	\$ 418	\$ 451
137839-900-XXX-000	ModulR Shower Return Panel 36 in.	\$ 424	\$ 457
137842-900-XXX-000	ModulR Shower Half Return Panel 30 in.	\$ 554	\$ 594
137843-900-XXX-000	ModulR Shower Half Return Panel 24 in.	\$ 535	\$ 578

Contact your MAAX representative for any details.



Corner shower (2 walls)



Corner tub shower (2 walls)

ModulR Shower Doors

The **ModulR** shower doors are so **customizable** that they can easily be added to any bathroom design. They **bring a touch of sophistication to your projects**, while being **easy to maintain** for the end consumers.



Versatility



DIMENSIONS



- Shower door: 78" (H)
- Tub shower door: 58" (H)

INSTALLATION OPTIONS

- With the B3 shower base
- With a ceramic shower base
- With a ModulR bathtub

CHOICE OF OPENING MECHANISMS

- Sliding door (with the Soft Close by MAAX system)
- Pivot door (with gradual closing)

ACCESSORIES

- 9 x 9 inch corner glass shelf
- Standard handle (included)
- 45-inch designer handle that can be used as a towel hook (available in accessory)

FRAME AND GLASS FINISHES



Chrome
(084)



Brushed
Nickel
(305)



Clear glass
with Lotus
(900)



ModulR

Shower Doors for Bases 3636

FEATURES & BENEFITS

- Pivot door
- 8 mm tempered glass with Lotus glass protection
- Magnetic closure for increased watertightness
- Reversible doors for left or right opening

ALCOVE

No	Description	Glass Pattern	Finish	Pkg	Approx. weight	List Price
137835-900-084-000	ModulR Pivot Shower Door Alcove 36 x 78 in, 8 mm	Clear	Chrome	5.74 ft ³ (0.16 m ³)	90 lb (41 kg)	\$ 1,085
137835-900-305-000			Brushed Nickel			\$ 1,172

CORNER

137856-900-084-000	ModulR Pivot Shower Door Corner 36 x 36 x 78 in, 8 mm	Clear	Chrome	12.27 ft ³ (0.34 m ³)	182 lb (83 kg)	\$ 1,508
137856-900-305-000			Brushed Nickel			\$ 1,628

ACCESSORIES – AVAILABLE ON EACH CONFIGURATION

No	Description	List Price
10068586-084-603	Designer Handle: 2 in 1 handle and towel hook (sold separately) Available color: Chrome (084), Brushed Nickel (305)	\$ 129
10068586-305-603		\$ 140
10060311	Corner Glass Shelf (9 3/8" X 9 3/8") (sold separately)	\$ 94

What are the benefits of the **Lotus glass protection by MAAX?**

ModulR shower doors 8 mm tempered clear glass is enhanced with the Lotus glass protection. This protection increases resistance to wear & tear and has a non-stick surface that repels soap and water stains providing optimal glass transparency and care-free maintenance.



ModulR corner pivot door 3636

ModulR

Shower Doors

for Bases 4832

FEATURES & BENEFITS

- Sliding and pivot door available
- 8 mm tempered glass with Lotus glass protection
- Sliding door with the Soft Close by MAAX system
- Magnetic closure for increased watertightness
- Reversible doors for left or right opening

ALCOVE

No	Description	Glass Pattern	Finish	Pkg	Approx. weight	List Price
137833-900-084-000	ModulR Pivot Shower Door Alcove 48 x 78 in, 8 mm	Clear	Chrome	10.11 ft ³ (0.28 m ³)	136 lb (62 kg)	\$ 1,271
137833-900-305-000			Brushed Nickel			\$ 1,364
137831-900-084-000	ModulR Sliding Shower Door Alcove 48 x 78 in, 8 mm		Chrome	9.51 ft ³ (0.27 m ³)	122 lb (55 kg)	\$ 1,271
137831-900-305-000			Brushed Nickel			\$ 1,364

CORNER

137859-900-084-000	ModulR Pivot Shower Door Corner 48 x 32 x 78 in, 8 mm	Clear	Chrome	16.14 ft ³ (0.45 m ³)	216 lb (98 kg)	\$ 1,683
137859-900-305-000			Brushed Nickel			\$ 1,810
137862-900-084-000	ModulR Sliding Shower Door Corner 48 x 32 x 78 in, 8 mm		Chrome	15.55 ft ³ (0.44 m ³)	202 lb (92 kg)	\$ 1,683
137862-900-305-000			Brushed Nickel			\$ 1,810

ALCOVE DEEP

137837-900-084-000	ModulR Pivot Shower Door Alcove 32 x 78 in, 8 mm	Clear	Chrome	5.74 ft ³ (0.16 m ³)	92 lb (42 kg)	\$ 1,067
137837-900-305-000			Brushed Nickel			\$ 1,150

WALL-MOUNTED

137865-900-084-000	ModulR Pivot Shower Door Wall-mounted 48 x 32 x 78 in, 8 mm	Clear	Chrome	22.18 ft ³ (0.62 m ³)	296 lb (134 kg)	\$ 2,096
137865-900-305-000			Brushed Nickel			\$ 2,255
137868-900-084-000	ModulR Sliding Shower Door Wall-mounted 48 x 32 x 78 in, 8 mm		Chrome	21.58 ft ³ (0.60 m ³)	282 lb (128 kg)	\$ 2,096
137868-900-305-000			Brushed Nickel			\$ 2,255

TUNNEL

137932-900-084-000	ModulR 1 Pivot Shower Door Tunnel 32 x 78 in, 8 mm	Clear	Chrome	11.25 ft ³ (0.31 m ³)	166 lb (75 kg)	\$ 1,628
137932-900-305-000			Brushed Nickel			\$ 1,755
137933-900-084-000	ModulR 2 Pivot Shower Doors Tunnel 32 x 78 in, 8 mm		Chrome	11.47 ft ³ (0.32 m ³)	184 lb (84 kg)	\$ 2,134
137933-900-305-000			Brushed Nickel			\$ 2,299

ACCESSORIES — AVAILABLE ON EACH CONFIGURATION

No	Description	List Price
10068586-084-603	Designer Handle: 2 in 1 handle and towel hook (sold separately) Available colors: Chrome (084), Brushed Nickel (305)	\$ 129
10068586-305-603		\$ 140
10060311	Corner Glass Shelf (9 5/8" X 9 5/8") (sold separately)	\$ 94

ModuR

Shower Doors

for Bases 4834

FEATURES & BENEFITS

- Sliding and pivot door available
- 8 mm tempered glass with Lotus glass protection
- Sliding door with the Soft Close by MAAX system
- Magnetic closure for increased watertightness
- Reversible doors for left or right opening

ALCOVE

No	Description	Glass Pattern	Finish	Pkg	Approx. weight	List Price
137833-900-084-000	ModuR Pivot Shower Door Alcove 48 x 78 in, 8 mm	Clear	Chrome	10.11 ft ³ (0.28 m ³)	136 lb (62 kg)	\$ 1,271
137833-900-305-000			Brushed Nickel			\$ 1,364
137831-900-084-000	ModuR Sliding Shower Door Alcove 48 x 78 in, 8 mm		Chrome	9.51 ft ³ (0.27 m ³)	122 lb (55 kg)	\$ 1,271
137831-900-305-000			Brushed Nickel			\$ 1,364

CORNER

137858-900-084-000	ModuR Pivot Shower Door Corner 48 x 34 x 78 in, 8 mm	Clear	Chrome	16.62 ft ³ (0.47 m ³)	222 lb (101 kg)	\$ 1,689
137858-900-305-000			Brushed Nickel			\$ 1,815
137861-900-084-000	ModuR Sliding Shower Door Corner 48 x 34 x 78 in, 8 mm		Chrome	16.03 ft ³ (0.45 m ³)	208 lb (94 kg)	\$ 1,689
137861-900-305-000			Brushed Nickel			\$ 1,815

ALCOVE DEEP

137836-900-084-000	ModuR Pivot Shower Door Alcove 34 x 78 in, 8 mm	Clear	Chrome	5.74 ft ³ (0.16 m ³)	92 lb (42 kg)	\$ 1,078
137836-900-305-000			Brushed Nickel			\$ 1,161

WALL-MOUNTED

137864-900-084-000	ModuR Pivot Shower Door Wall-mounted 48 x 34 x 78 in, 8 mm	Clear	Chrome	23.14 ft ³ (0.65 m ³)	308 lb (140 kg)	\$ 2,107
137864-900-305-000			Brushed Nickel			\$ 2,266
137867-900-084-000	ModuR Sliding Shower Door Wall-mounted 48 x 34 x 78 in, 8 mm		Chrome	22.54 ft ³ (0.63 m ³)	294 lb (133 kg)	\$ 2,107
137867-900-305-000			Brushed Nickel			\$ 2,266

TUNNEL

137934-900-084-000	ModuR 1 Pivot Shower Door Tunnel 34 x 78 in, 8 mm	Clear	Chrome	11.77 ft ³ (0.33 m ³)	172 lb (78 kg)	\$ 1,646
137934-900-305-000			Brushed Nickel			\$ 1,771
137935-900-084-000	ModuR 2 Pivot Shower Doors Tunnel 34 x 78 in, 8 mm		Chrome	11.47 ft ³ (0.32 m ³)	184 lb (84 kg)	\$ 2,156
137935-900-305-000			Brushed Nickel			\$ 2,321

ACCESSORIES — AVAILABLE ON EACH CONFIGURATION

No	Description	List Price
10068586-084-603	Designer Handle: 2 in 1 handle and towel hook (sold separately) Available colors: Chrome (084), Brushed Nickel (305)	\$ 129
10068586-305-603		\$ 140
10060311	Corner Glass Shelf (9 3/8" X 9 3/8") (sold separately)	\$ 94

ModulR

Shower Doors

for Bases 4836

FEATURES & BENEFITS

- Sliding and pivot door available
- 8 mm tempered glass with Lotus glass protection
- Sliding door with the Soft Close by MAAX system
- Magnetic closure for increased watertightness
- Reversible doors for left or right opening

ALCOVE

No	Description	Glass Pattern	Finish	Pkg	Approx. weight	List Price
137833-900-084-000	ModulR Pivot Shower Door Alcove 48 x 78 in, 8 mm	Clear	Chrome	10.11 ft ³ (0.28 m ³)	136 lb (62 kg)	\$ 1,271
137833-900-305-000			Brushed Nickel			\$ 1,364
137831-900-084-000	ModulR Sliding Shower Door Alcove 48 x 78 in, 8 mm		Chrome	9.51 ft ³ (0.27 m ³)	122 lb (55 kg)	\$ 1,271
137831-900-305-000			Brushed Nickel			\$ 1,364

CORNER

137857-900-084-000	ModulR Pivot Shower Door Corner 48 x 36 x 78, 8 mm	Clear	Chrome	16.65 ft ³ (0.47 m ³)	228 lb (104 kg)	\$ 1,694
137857-900-305-000			Brushed Nickel			\$ 1,821
137860-900-084-000	ModulR Sliding Shower Door Corner 48 x 36 x 78, 8 mm		Chrome	16.05 ft ³ (0.45 m ³)	214 lb (97 kg)	\$ 1,694
137860-900-305-000			Brushed Nickel			\$ 1,821

ALCOVE DEEP

137835-900-084-000	ModulR Pivot Shower Door Alcove 36 x 78 in, 8 mm	Clear	Chrome	5.74 ft ³ (0.16 m ³)	90 lb (41 kg)	\$ 1,085
137835-900-305-000			Brushed Nickel			\$ 1,172

WALL-MOUNTED

137863-900-084-000	ModulR Pivot Shower Door Wall-mounted 48 x 36 x 78, 8 mm	Clear	Chrome	23.18 ft ³ (0.65 m ³)	320 lb (145 kg)	\$ 2,118
137863-900-305-000			Brushed Nickel			\$ 2,277
137866-900-084-000	ModulR Sliding Shower Door Wall-mounted 48 x 36 x 78, 8 mm		Chrome	22.58 ft ³ (0.63 m ³)	306 lb (139 kg)	\$ 2,118
137866-900-305-000			Brushed Nickel			\$ 2,277

TUNNEL

137936-900-084-000	ModulR 1 Pivot Shower Door Tunnel 36 x 78 in, 8 mm	Clear	Chrome	11.77 ft ³ (0.33 m ³)	174 lb (79 kg)	\$ 1,659
137936-900-305-000			Brushed Nickel			\$ 1,788
137937-900-084-000	ModulR 2 Pivot Shower Doors Tunnel 36 x 78 in, 8 mm		Chrome	11.47 ft ³ (0.32 m ³)	180 lb (82 kg)	\$ 2,169
137937-900-305-000			Brushed Nickel			\$ 2,343

ACCESSORIES — AVAILABLE ON EACH CONFIGURATION

No	Description	List Price
10068586-084-603	Designer Handle: 2 in 1 handle and towel hook (sold separately) Available colors: Chrome (084), Brushed Nickel (305)	\$ 129
10068586-305-603		\$ 140
10060311	Corner Glass Shelf (9 3/8" X 9 3/8") (sold separately)	\$ 94

ModuR

Shower Doors

for Bases 6030

FEATURES & BENEFITS

- Sliding and pivot door available
- 8 mm tempered glass with Lotus glass protection
- Sliding door with the Soft Close by MAAX system
- Magnetic closure for increased watertightness
- Reversible doors for left or right opening

ALCOVE

No	Description	Glass Pattern	Finish	Pkg	Approx. weight	List Price
137832-900-084-000	ModuR Pivot Shower Door Alcove 60 x 78 in, 8 mm	Clear	Chrome	12.09 ft ³ (0.34 m ³)	167 lb (76 kg)	\$ 1,452
137832-900-305-000			Brushed Nickel			\$ 1,562
137830-900-084-000	ModuR Sliding Shower Door Alcove 60 x 78 in, 8 mm		Chrome	12.31 ft ³ (0.34 m ³)	154 lb (70 kg)	\$ 1,452
137830-900-305-000			Brushed Nickel			\$ 1,562

ACCESSORIES — AVAILABLE ON EACH CONFIGURATION

No	Description	List Price
10068586-084-603	Designer Handle: 2 in 1 handle and towel hook (sold separately) Available colors: Chrome (084), Brushed Nickel (305)	\$ 129
10068586-305-603		\$ 140
10060311	Corner Glass Shelf (9 7/8" X 9 7/8") (sold separately)	\$ 94



DISCOVER THE **ModuR** PRODUCT LINE
with our online configuration tool

maaxmodulr.com/configurator

ModuR

Shower Doors for Bases 6032

FEATURES & BENEFITS

- Sliding and pivot door available
- 8 mm tempered glass with Lotus glass protection
- Sliding door with the Soft Close by MAAX system
- Magnetic closure for increased watertightness
- Reversible doors for left or right opening

ALCOVE

No	Description	Glass Pattern	Finish	Pkg	Approx. weight	List Price
137832-900-084-000	ModuR Pivot Shower Door Alcove 60 x 78 in, 8 mm	Clear	Chrome	12.09 ft ³ (0.34 m ³)	167 lb (76 kg)	\$ 1,452
137832-900-305-000			Brushed Nickel			\$ 1,562
137830-900-084-000	ModuR Sliding Shower Door Alcove 60 x 78 in, 8 mm		Chrome	12.31 ft ³ (0.34 m ³)	154 lb (70 kg)	\$ 1,452
137830-900-305-000			Brushed Nickel			\$ 1,562

CORNER

137870-900-084-000	ModuR Pivot Shower Door Corner 60 x 32 x 78 in, 8 mm	Clear	Chrome	18.12 ft ³ (0.51 m ³)	247 lb (112 kg)	\$ 1,865
137870-900-305-000			Brushed Nickel			\$ 2,008
137872-900-084-000	ModuR Sliding Shower Door Corner 60 x 32 x 78 in, 8 mm		Chrome	18.34 ft ³ (0.51 m ³)	234 lb (106 kg)	\$ 1,865
137872-900-305-000			Brushed Nickel			\$ 2,008

ALCOVE DEEP

137837-900-084-000	ModuR Pivot Shower Door Alcove 32 x 78 in, 8 mm	Clear	Chrome	5.74 ft ³ (0.16 m ³)	92 lb (42 kg)	\$ 1,067
137837-900-305-000			Brushed Nickel			\$ 1,150

WALL-MOUNTED

137874-900-084-000	ModuR Pivot Shower Door Wall-mounted 60 x 32 x 78 in, 8 mm	Clear	Chrome	24.15 ft ³ (0.68 m ³)	327 lb (148 kg)	\$ 2,277
137874-900-305-000			Brushed Nickel			\$ 2,453
137876-900-084-000	ModuR Sliding Shower Door Wall-mounted 60 x 32 x 78 in, 8 mm		Chrome	24.38 ft ³ (0.68 m ³)	314 lb (143 kg)	\$ 2,277
137876-900-305-000			Brushed Nickel			\$ 2,453

TUNNEL

137932-900-084-000	ModuR 1 Pivot Shower Door Tunnel 32 x 78 in, 8 mm	Clear	Chrome	11.25 ft ³ (0.31 m ³)	166 lb (75 kg)	\$ 1,628
137932-900-305-000			Brushed Nickel			\$ 1,755
137933-900-084-000	ModuR 2 Pivot Shower Doors Tunnel 32 x 78 in, 8 mm	Clear	Chrome	11.47 ft ³ (0.32 m ³)	184 lb (84 kg)	\$ 2,134
137933-900-305-000			Brushed Nickel			\$ 2,299

ACCESSORIES — AVAILABLE ON EACH CONFIGURATION

No	Description	List Price
10068586-084-603	Designer Handle: 2 in 1 handle and towel hook (sold separately) Available colors: Chrome (084), Brushed Nickel (305)	\$ 129
10068586-305-603		\$ 140
10060311	Corner Glass Shelf (9 3/8" X 9 3/8") (sold separately)	\$ 94

ModulR

Shower Doors

for Bases 6036

FEATURES & BENEFITS

- Sliding and pivot door available
- 8 mm tempered glass with Lotus glass protection
- Sliding door with the Soft Close by MAAX system
- Magnetic closure for increased watertightness
- Reversible doors for left or right opening

ALCOVE

No	Description	Glass Pattern	Finish	Pkg	Approx. weight	List Price
137832-900-084-000	ModulR Pivot Shower Door Alcove 60 x 78 in, 8 mm	Clear	Chrome	12.09 ft ³ (0.34 m ³)	167 lb (76 kg)	\$ 1,452
137832-900-305-000			Brushed Nickel			\$ 1,562
137830-900-084-000	ModulR Sliding Shower Door Alcove 60 x 78 in, 8 mm		Chrome	12.31 ft ³ (0.34 m ³)	154 lb (70 kg)	\$ 1,452
137830-900-305-000			Brushed Nickel			\$ 1,562

CORNER

137869-900-084-000	ModulR Pivot Shower Door Corner 60 x 36 x 78 in, 8 mm	Clear	Chrome	18.62 ft ³ (0.52 m ³)	259 lb (118 kg)	\$ 1,876
137869-900-305-000			Brushed Nickel			\$ 2,019
137871-900-084-000	ModulR Sliding Shower Door Corner 60 x 36 x 78 in, 8 mm		Chrome	18.84 ft ³ (0.53 m ³)	246 lb (112 kg)	\$ 1,876
137871-900-305-000			Brushed Nickel			\$ 2,019

ALCOVE DEEP

137835-900-084-000	ModulR Pivot Shower Door Alcove 36 x 78 in, 8 mm	Clear	Chrome	5.74 ft ³ (0.16 m ³)	90 lb (41 kg)	\$ 1,085
137835-900-305-000			Brushed Nickel			\$ 1,172

WALL-MOUNTED

137873-900-084-000	ModulR Pivot Shower Door Wall-mounted 60 x 36 x 78 in, 8 mm	Clear	Chrome	25.15 ft ³ (0.70 m ³)	351 lb (159 kg)	\$ 2,299
137873-900-305-000			Brushed Nickel			\$ 2,475
137875-900-084-000	ModulR Sliding Shower Door Wall-mounted 60 x 36 x 78 in, 8 mm		Chrome	25.38 ft ³ (0.71 m ³)	338 lb (153 kg)	\$ 2,299
137875-900-305-000			Brushed Nickel			\$ 2,475

TUNNEL

137936-900-084-000	ModulR 1 Pivot Shower Door Tunnel 36 x 78 in, 8 mm	Clear	Chrome	11.77 ft ³ (0.33 m ³)	174 lb (79 kg)	\$ 1,659
137936-900-305-000			Brushed Nickel			\$ 1,788
137937-900-084-000	ModulR 2 Pivot Shower Doors Tunnel 36 x 78 in, 8 mm	Clear	Chrome	11.47 ft ³ (0.32 m ³)	180 lb (82 kg)	\$ 2,169
137937-900-305-000			Brushed Nickel			\$ 2,343

ModulR

Shower Doors

for Bathtubs 6032

FEATURES & BENEFITS

- Tub sliding doors for corner and alcove bathtubs
- 8 mm tempered glass with Lotus glass protection
- Soft Close by MAAX system
- Magnetic closure for increased watertightness
- Reversible door for left or right opening

ALCOVE

No	Description	Glass Pattern	Finish	Pkg	Approx. weight	List Price
137846-900-084-000	ModulR Sliding Tub Door Alcove 60 x 58 in, 8 mm	Clear	Chrome	8.99 ft ³ (0.25 m ³)	116 lb (53 kg)	\$ 1,243
137846-900-305-000			Brushed Nickel			\$ 1,342

CORNER

No	Description	Glass Pattern	Finish	Pkg	Approx. weight	List Price
137878-900-084-000	ModulR Sliding Tub Door Corner 60 x 32 x 58 in, 8 mm	Clear	Chrome	13.88 ft ³ (0.39 m ³)	174 lb (79 kg)	\$ 1,656
137878-900-305-000			Brushed Nickel			\$ 1,788

MODULR DOORS

B3 Shower Bases

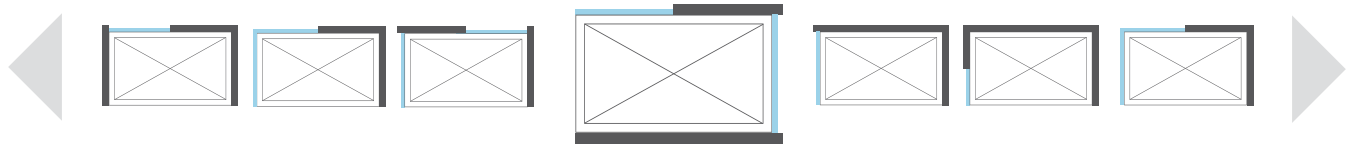

Configurable in many ways, **B3 shower bases** allow you to create a unique and custom decor. Combine your **shower base** with a **ModulR** door and position your shower against multiple walls or half-walls — the possibilities are endless!

1000 + possibilities
ONLINE!



maaxmodulr.com/configurator



IT'S NOT TILE. IT'S Utile.

utilebymaax.com

Utile

by **MAAX**

A close-up photograph of the shower door's sliding mechanism. It shows a chrome-finished metal track mounted on a wall of large, light-brown rectangular tiles. A glass door panel is partially visible, held in place by a chrome roller. Above the track, a chrome showerhead is mounted on a horizontal bar.

Duel Doors



Duel shower door with B3Square 4834 shower base

Recommended MAAX Shower Bases for Duel Doors

DUEL DOORS

		Duel doors			
		Alcove doors		Return panels (corner)	
Dimension	Doors (W x H) ¹	44 ½ - 47 x 70 ½	56 ½ - 59 x 70 ½	30 ½ x 74	34 ½ x 74
Base (L x W) ¹	Model No	136271	136272	135310	135311
48" Alcove	B3Square/ Round 4832	420001/ 410001	X		
	B3Square/ Round 4834	420002/ 410002	X		
	B3Square/ Round 4836	420003/ 410003	X		
	B3X base 4836	420030	X		
	Rectangular base 4832	105060/ 101433	X		
	Rectangular base 4834	105534/ 102002	X		
	Rectangular base 4836	105059/ 105717	X		
48" Corner	B3Square/ Round 4832	420001/ 410001	X	X	
	B3Square/ Round 4834	420002/ 410002	X		
	B3Square/ Round 4836	420003/ 410003	X		X
	B3X base 4836	420028/ 420029	X		X
60" Alcove	B3Square/ Round 6030	420004/ 410004		X	
	B3Square/ Round 6032	420005/ 410005		X	
	B3Square/ Round 6036	420006/ 410006		X	
	B3X base 6036	420031		X	
	Rectangular base 6030	105055/ 105707		X	
	Rectangular base 6032	105056/ 105706		X	
	Rectangular base 6034	105533/ 102003		X	
	Rectangular base 6036	105666		X	
		105057/ 105664		X	
	Rectangular base 6042	105058/ 105716		X	
60" Corner	B3Square/ Round 6032	420005/ 410005	X	X	
	B3Square/ Round 6036	420006/ 410006	X		X
	B3X base 6036	420032/ 420033		X	X
	Rectangular base 6036	105594		X	X

- Tub doors fit on the majority of MAAX tubs. Please refer to the tubs section for more information.
- Fit may vary depending on wall thickness (acrylic or tile). Validate the height of the product if installing with acrylic walls.

1. L: Length, W: Width, H: Height

Duel - Shower Doors

NEW FINISHES
AVAILABLE FALL 2017



- Glass panels 5/16 in. (8 mm) with Lotus glass protection
- Fits showers with 70 1/2 in. wall clearance, glass extends to 74 in.
- Two sliding glass panels for flexible entryway or plumbing access on the left or on the right
- Sleek and square elements for a modern look
- Combined with a return panel for a corner shower

Regional Availability

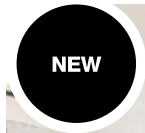

DUEL DOORS

DUEL FRAMELESS SLIDING DOOR 44-47 X 70 1/2 IN. 8 MM

No	Door Opening	Glass Pattern	Finish	Pkg	Approx. weight	List Price
136271-900-084	Lateral	Clear (900)	Chrome (084)	3.96 ft ³	121 lb	\$ 1,115
136271-900-305	Lateral	Clear (900)	Brushed Nickel (305)	3.96 ft ³	121 lb	\$ 1,199
136271-900-173	Lateral	Clear (900)	Dark Bronze (173)	3.96 ft ³	121 lb	\$ 1,289

Radius: N/A
 Standard Height: 70 1/2 - 74 in.
 Adjustment: For out of plumb walls

Width maximum: 47 in.
 Access: N/A

Width minimum: 44 in.
 Door Opening: Lateral

DUEL FRAMELESS SLIDING DOOR 56-59 X 70 1/2 IN. 8 MM

No	Door Opening	Glass Pattern	Finish	Pkg	Approx. weight	List Price
136272-900-084	Lateral	Clear (900)	Chrome (084)	4.85 ft ³	138 lb	\$ 1,134
136272-900-305	Lateral	Clear (900)	Brushed Nickel (305)	4.85 ft ³	138 lb	\$ 1,219
136272-900-173	Lateral	Clear (900)	Dark Bronze (173)	4.85 ft ³	138 lb	\$ 1,310

Radius: N/A
 Standard Height: 70 1/2 - 74 in.
 Adjustment: For out of plumb walls

Width maximum: 59 in.
 Access: N/A

Width minimum: 56 in.
 Door Opening: Lateral

Duel - Tub Door

NEW FINISHES
AVAILABLE FALL 2017



- 8 mm clear tempered glass with Lotus glass protection
- Fits tub showers with 55 1/2 in. wall clearance, glass extends to 59 in.
- Two sliding glass panels for flexible entryway or plumbing access
- Available in 3 finishes; Chrome, Brushed Nickel and Dark Bronze

Regional Availability



DUEL DOORS

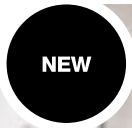

DUEL FRAMELESS SLIDING DOOR 56-59 X 55 1/2 IN. 8 MM

No	Door Opening	Glass Pattern	Finish	Pkg	Approx. weight	List Price
136270-900-084	Lateral	Clear (900)	Chrome (084)	3.91 ft ³	121 lb	\$ 1,115
136270-900-305	Lateral	Clear (900)	Brushed Nickel (305)	3.91 ft ³	121 lb	\$ 1,199
136270-900-173	Lateral	Clear (900)	Dark Bronze (173)	3.91 ft ³	121 lb	\$ 1,289

Radius: N/A
Standard Height: 55 1/2 - 59 in.
Adjustment: For out of plumb walls

Width maximum: 59 in.
Access: 27 1/2 in.

Width minimum: 56 in.
Door Opening: Lateral



Duel Corner – Dark Bronze

Duel Corner – Brushed Nickel

Duel Return Panels

AVAILABLE FALL 2017

- Glass panels 5/16 in. (8 mm) with Lotus glass protection
- 32 in. and 36 in. wide by 74 in. high panels
- Add 1 return panel to a Duel sliding alcove door for a corner unit
- Available in 3 finishes: Chrome, Brushed Nickel and Dark Bronze

Regional Availability

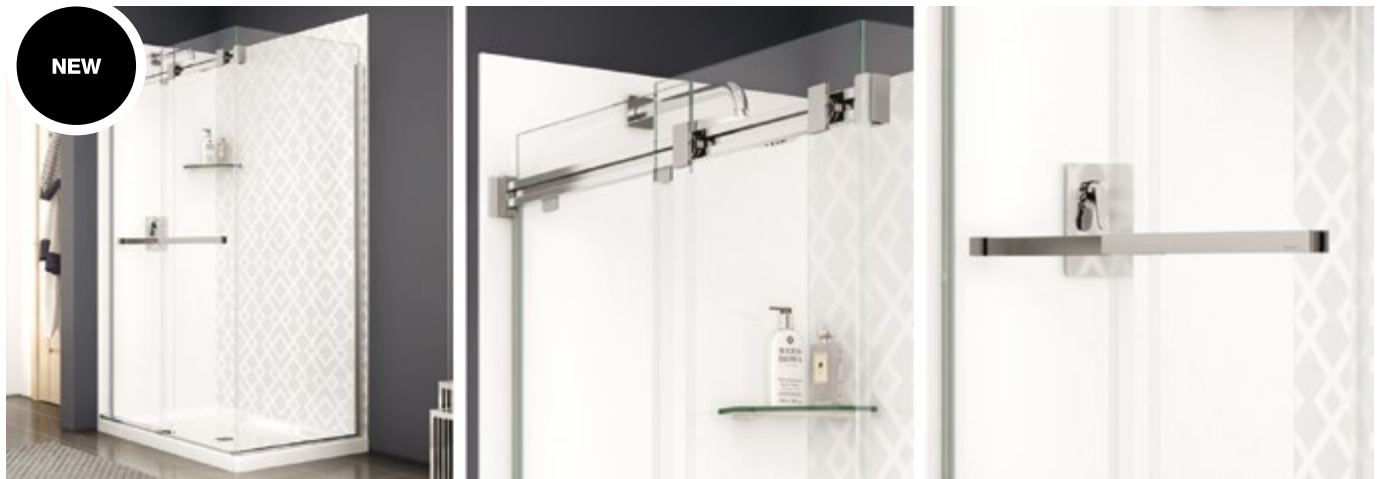

NEW

DUEL DOORS

DUEL RETURN PANEL FOR 32 IN. BASE

No	Door Opening	Glass Pattern	Finish	Pkg	Approx. weight	List Price
137310-900-084	N/A	Clear (900)	Chrome (084)	3.7 ft ³	72 lb	\$ 350
137310-900-305	N/A	Clear (900)	Brushed Nickel (305)	3.7 ft ³	72 lb	\$ 376
137310-900-173	N/A	Clear (900)	Dark Bronze (173)	3.7 ft ³	72 lb	\$ 404

Radius: N/A
 Standard Height: 74 in.
 Adjustment: For out of plumb walls (approx 3/4 in. (20 mm))

Width maximum: 29 3/4 in.
 Access: N/A

Width minimum: 29 in.
 Door Opening:

DUEL RETURN PANEL FOR 36 IN. BASE

No	Door Opening	Glass Pattern	Finish	Pkg	Approx. weight	List Price
137311-900-084	N/A	Clear (900)	Chrome (084)	4.2 ft ³	81 lb	\$ 400
137311-900-305	N/A	Clear (900)	Brushed Nickel (305)	4.2 ft ³	81 lb	\$ 430
137311-900-173	N/A	Clear (900)	Dark Bronze (173)	4.2 ft ³	81 lb	\$ 462

Radius: N/A
 Standard Height: 74 in.
 Adjustment: For out of plumb walls (approx 3/4 in. (20 mm))

Width maximum: 33 3/4 in.
 Access: N/A

Width minimum: 33 in.
 Door Opening:



NEW

ARIOSA

Comfortable. Beautiful.
Versatile.



Edge Shields

Edge Tub Shield with Allia 6032 Tub Shower

Recommended MAAX Shower Bases for Edge Shields

		Edge Shield	
Dimension	Doors (W x H) ¹	42 x 75	
Base (L x W) ¹	Model No	137504	
48" Alcove	B3Square/ Round 4832	420001/ 410001	X
	B3Square/ Round 4834	420002/ 410002	X
	B3Square/ Round 4836	420003/ 410003	X
	B3X base 4836	420030	X
	Rectangular base 4832	105060/ 101433	X
	Rectangular base 4834	105534/ 102002	X
	Rectangular base 4836	105059/ 105717	X
60" Alcove	B3Square/ Round 6030	420004/ 410004	X
	B3Square/ Round 6032	420005/ 410005	X
	B3Square/ Round 6036	420006/ 410006	X
	B3X base 6036	420031	X
	Rectangular base 6030	105055/ 105707	X
	Rectangular base 6032	105056/ 105706	X
	Rectangular base 6034	105533/ 102003	X
	Rectangular base 6036	105666	X
		105057/ 105664	X
	Rectangular base 6042	105058/ 105716	X

- Tub doors fit on the majority of MAAX tubs. Please refer to the tubs section for more information.
- Fit may vary depending on wall thickness (acrylic or tile). Validate the height of the product if installing with acrylic walls.

1. L: Length, W: Width, H: Height

Edge - Tub Shield

AVAILABLE SUMMER 2017

- 6 mm tempered glass with Lotus glass protection
- Lifting pivot single panel: nothing on the tub, makes it easy to clean the panel and the tub
- Easy access to faucets
- Pivots inward and outward, maximizes the tub access to provide care

Regional Availability



EDGE SHIELDS

EDGE TUB SHIELD 30 X 55 1/2 IN., 6 MM

No	Door Opening	Glass Pattern	Finish	Pkg	Approx. weight	List Price
137500-900-084	1-Panel	Clear (900)	Chrome (084)	2.65 ft ³	26 lb	\$ 475

Radius: N/A

Standard Height: 55 1/2 in.

Adjustment: For out-of-plumb walls (approx 3/8 (10 mm))

Width maximum: 30 in.

Access: N/A

Width minimum:

Door Opening: 1-Panel

CONSULT, PRINT AND SHARE EASILY!

PDF versions of **all our up to date product technical drawings** are available on MAAX's website.



www.maax.com

Edge Square - Tub Shield

AVAILABLE SUMMER 2017

- 8 mm tempered glass with Lotus glass protection with a Square pivot
- Lifting pivot single panel: nothing on the tub, makes it easy to clean the panel and the tub
- Easy access to faucets

Regional Availability



NEW

EDGE SHIELDS

EDGE SQUARE TUB SHIELD 34 X 58 IN., 8 MM

No	Door Opening	Glass Pattern	Finish	Pkg	Approx. weight	List Price
137501-900-084	1-Panel	Clear (900)	Chrome (084)	2.82 ft ³	40 lb	\$ 525
137501-900-305	1-Panel	Clear (900)	Brushed Nickel (305)	2.82 ft ³	40 lb	\$ 564

Radius: N/A
Standard Height: 58 in.
Adjustment: For out-of-plumb walls (approx 3/8 (10 mm))

Width maximum: 34 in.
Access: N/A

Width minimum:
Door Opening: 1-Panel

Edge Duo - Tub Shield

AVAILABLE SUMMER 2017

- 8 mm tempered glass with Lotus glass protection
- Double glass; one fix 24in and one pivot 18in; This gives you a wide access to get in and out while making the corner watertight
- Easy access to faucets
- The moving panel can tilt slightly inside the tub to prevent water spill
- Fixed panel clears most toilets or vanities

Regional Availability



EDGE SHIELDS

EDGE DUO TUB SHIELD 42 X 58 IN., 8 MM

No	Door Opening	Glass Pattern	Finish	Pkg	Approx. weight	List Price
137502-900-084	1-Panel	Clear (900)	Chrome (084)	2.7 ft ³	48 lb	\$ 700
137502-900-305	1-Panel	Clear (900)	Brushed Nickel (305)	2.7 ft ³	48 lb	\$ 753

Radius: N/A

Standard Height: 58 in.

Adjustment: For out-of-plumb walls (approx 3/8 (10 mm))

Width maximum: 42 in.

Access: N/A

Width minimum:

Door Opening: 1-Panel

Edge Duo - Shower Shield

AVAILABLE SUMMER 2017

- 8 mm tempered glass with Lotus glass protection
- Double glass; one fix 24in and one pivot 18in; This gives you a wide access to get in and out while making the corner watertight
- Easy access to faucets
- The moving panel can tilt slightly inside the tub to prevent water spill
- Fixed panel clears most toilets or vanities

Regional Availability



EDGE SHIELDS



EDGE DUO SHOWER SHIELD 42 X 75 IN., 8 MM

No	Door Opening	Glass Pattern	Finish	Pkg	Approx. weight	List Price
137504-900-084	1-Panel	Clear (900)	Chrome (084)	3.5 ft ³	77 lb	\$ 875
137504-900-305	1-Panel	Clear (900)	Brushed Nickel (305)	3.5 ft ³	77 lb	\$ 941

Radius: N/A
 Standard Height: 75 in.
 Adjustment: For out-of-plumb walls (approx 3/8 (10 mm))

Width maximum: 42 in.
 Access: N/A

Width minimum:
 Door Opening: 1-Panel

Halo Doors



Halo shower door with B3Square 6032 shower base

Recommended MAAAX Shower Bases

for Halo Doors

HALO DOORS

		Halo doors						
		Alcove doors		Return panels (corner)			Halo Round	
Dimension	Doors (W x H) ¹ ▶	44 ½ - 47 X 78 ¾	56 ½ - 59 X 78 ¾	29 ¾ X 78 ¾	31 ¾ X 78 ¾	33 ¾ X 78 ¾	36 - 36 x 75 ½	
Base (L x W) ¹ ▼	Model No	138996	138997	138998	139395	139396	139399	
48" Alcove	B3Square/ Round 4832	420001/ 410001	X					
	B3Square/ Round 4834	420002/ 410002	X					
	B3Square/ Round 4836	420003/ 410003	X					
	B3X base 4836	420030	X					
	Rectangular base 4832	105060/ 101433	X					
	Rectangular base 4834	105534/ 102002	X					
	Rectangular base 4836	105059/ 105717	X					
48" Corner	B3Square/ Round 4832	420001/ 410001	X		X			
	B3Square/ Round 4834	420002/ 410002	X		X			
	B3Square/Round 4836	420003/ 410003	X			X		
	B3X base 4836	420028/ 420029	X			X		
60" Alcove	B3Square/ Round 6030	420004/ 410004		X				
	B3Square/ Round 6032	420005/ 410005		X				
	B3Square/ Round 6036	420006/ 410006		X				
	B3X base 6036	420031		X				
	Rectangular base 6030	105055/ 105707		X				
	Rectangular base 6032	105056/ 105706		X				
	Rectangular base 6034	105533/ 102003		X				
	Rectangular base 6036	105666		X				
		105057/ 105664		X				
Rectangular base 6042	105058/ 105716		X					
60" Corner	B3Square/ Round 6032	420005/ 410005		X	X			
	B3Square/ Round 6036	420006/ 410006		X		X		
	B3X base 6036	420032/ 420033		X		X		
	Rectangular base 6036	105594		X		X		
36" Corner	Round Base 36	105049/ 101429					X	

- Tub doors fit on the majority of MAAAX tubs. Please refer to the tubs section for more information.
- Fit may vary depending on wall thickness (acrylic or tile). Validate the height of the product if installing with acrylic walls.

1. L: Length, W: Width, H: Height

Halo - Shower Doors

- 78 3/4 in. high clear tempered glass panel 5/16 in. (8 mm)
- Ball bearing roller technology for smooth and quiet opening
- 48 in. & 60 in. reversible shower door for left or right opening
- Also available in a corner configuration
- Available in 3 finishes: Chrome, Brushed Nickel and Dark Bronze

Regional Availability



HALO DOORS

HALO SLIDING DOOR 44 1/2-47 X 78 3/4 IN. 8 MM

No	Door Opening	Glass Pattern	Finish	Pkg	Approx. weight	List Price
138996-900-084	Left or right	Clear (900)	Chrome (084)	6 ft ³	132 lb	\$ 1,213
138996-900-305	Left or right	Clear (900)	Brushed Nickel (305)	6 ft ³	132 lb	\$ 1,245
138996-900-173	Left or right	Clear (900)	Dark Bronze (173)	6 ft ³	132 lb	\$ 1,329

Radius: N/A
 Standard Height: 78 3/4 in.
 Adjustment: For out of plumb walls (approx 1 in. (25mm)) and 1/4 in. (6mm) vertical adjustment on rollers

Width maximum: 47 in.
 Access: 18 3/8 in.

Width minimum: 44 1/2 in.
 Door Opening: Left or right

HALO SLIDING DOOR 56 1/2-59 X 78 3/4 IN. 8 MM

No	Door Opening	Glass Pattern	Finish	Pkg	Approx. weight	List Price
138997-900-084	Left or right	Clear (900)	Chrome (084)	7.2 ft ³	162 lb	\$ 1,323
138997-900-305	Left or right	Clear (900)	Brushed Nickel (305)	7.2 ft ³	162 lb	\$ 1,355
138997-900-173	Left or right	Clear (900)	Dark Bronze (173)	7.2 ft ³	162 lb	\$ 1,449

Radius: N/A
 Standard Height: 78 3/4 in.
 Adjustment: For out of plumb walls (approx 1 in. (25mm)) and 1/4 in. (6mm) vertical adjustment on rollers

Width maximum: 59 in.
 Access: 24 1/2 in.

Width minimum: 56 1/2 in.
 Door Opening: Left or right

Halo Return Panels

- Glass panels 5/16 in. (8 mm)
- 32 in., 34 in. and 36 in. wide by 78 3/4 in. high panels
- Add 1 return panel to a Halo sliding alcove door for a corner unit
- Available in 3 finishes: Chrome, Brushed Nickel and Dark Bronze

Regional Availability



HALO DOORS

HALO RETURN PANEL FOR 32 IN. BASE

No	Door Opening	Glass Pattern	Finish	Pkg	Approx. weight	List Price
138998-900-084	N/A	Clear (900)	Chrome (084)	5.7 ft ³	70 lb	\$ 535
138998-900-305	N/A	Clear (900)	Brushed Nickel (305)	5.7 ft ³	70 lb	\$ 546
138998-900-173	N/A	Clear (900)	Dark Bronze (173)	5.7 ft ³	70 lb	\$ 588

Radius: N/A
 Standard Height: 78 3/4 in.
 Adjustment: For out of plumb walls (approx 1 in. (25 mm)) and 1/4 in. (6 mm) vertical adjustment on rollers

Width maximum: 29 7/8 in.
 Access: N/A

Width minimum: 28 3/4 in.
 Door Opening:

HALO RETURN PANEL FOR 34 IN. BASE

No	Door Opening	Glass Pattern	Finish	Pkg	Approx. weight	List Price
139395-900-084	N/A	Clear (900)	Chrome (084)	6 ft ³	77 lb	\$ 552
139395-900-305	N/A	Clear (900)	Brushed Nickel (305)	6 ft ³	77 lb	\$ 567
139395-900-173	N/A	Clear (900)	Dark Bronze (173)	6 ft ³	77 lb	\$ 609

Radius: N/A
 Standard Height: 78 3/4 in.
 Adjustment: For out of plumb walls (approx 1 in. (25 mm)) and 1/4 in. (6 mm) vertical adjustment on rollers

Width maximum: 31 7/8 in.
 Access: N/A

Width minimum: 28 3/4 in.
 Door Opening:

HALO RETURN PANEL FOR 36 IN. BASE

No	Door Opening	Glass Pattern	Finish	Pkg	Approx. weight	List Price
139396-900-084	N/A	Clear (900)	Chrome (084)	6.5 ft ³	82 lb	\$ 596
139396-900-305	N/A	Clear (900)	Brushed Nickel (305)	6.5 ft ³	82 lb	\$ 583
139396-900-173	N/A	Clear (900)	Dark Bronze (173)	6.5 ft ³	82 lb	\$ 625

Radius: N/A
 Standard Height: 78 3/4 in.
 Adjustment: For out of plumb walls (approx 1 in. (25 mm)) and 1/4 in. (6 mm) vertical adjustment on rollers

Width maximum: 33 7/8 in.
 Access: N/A

Width minimum: 32 3/4 in.
 Door Opening:

Halo - Tub Door

- Silent big roller mechanism with integrated ball bearing technology
- Frameless, clear 5/16 in. (8 mm) tempered glass
- Offers an easy access to plumbing, versatile left right opening
- Sliding glass door for tub and tub shower, 56 1/2 in.
- Available in 3 finishes: Chrome, Brushed Nickel and Dark Bronze

Regional Availability



HALO DOORS

HALO SLIDING TUB DOOR 56 1/2-59 X 59 IN. 8 MM

No	Door Opening	Glass Pattern	Finish	Pkg	Approx. weight	List Price
139398-900-084	Left or right	Clear (900)	Chrome (084)	7.7 ft ³	118 lb	\$ 1,269
139398-900-305	Left or right	Clear (900)	Brushed Nickel (305)	7.7 ft ³	118 lb	\$ 1,297
139398-900-173	Left or right	Clear (900)	Dark Bronze (173)	7.7 ft ³	118 lb	\$ 1,402

Radius: N/A

Standard Height: 59 in.

Adjustment: For out of plumb walls (approx 1 in. (25mm)) and 1/4 in. (6mm) vertical adjustment on rollers

Width maximum: 59 in.

Access: 24 1/2 in.

Width minimum: 56 1/2 in.

Door Opening: Left or right

Halo Round

- 75 5/8 in. high luxury clear glass panel
- 5/16 in. (8mm) tempered glass with chrome hardware
- Ball bearing roller technology allowing for 1/4 in. adjustment
- For installation with round shower base and ceramic walls
- Left or right opening available

Regional Availability



HALO DOORS



HALO ROUND - LEFT OPENING 36 X 36 X 75 5/8 IN.

No	Door Opening	Glass Pattern	Finish	Pkg	Approx. weight	List Price
139399-L-900-084	Lateral	Clear (900)	Chrome (084)	21.4 ft ³	185 lb	\$ 1,323

Radius: N/A
 Standard Height: 75 5/8 in.
 Adjustment: For out of plumb walls (approx 1 in. (25mm)) and 1/4 in. (6mm) vertical adjustment on rollers

Width maximum: 36 in.
 Access: N/A

Width minimum: 36 in.
 Door Opening: Lateral

HALO ROUND - RIGHT OPENING 36 X 36 X 75 5/8 IN.

No	Door Opening	Glass Pattern	Finish	Pkg	Approx. weight	List Price
139399-R-900-084	Lateral	Clear (900)	Chrome (084)	21.4 ft ³	185 lb	\$ 1,323

Radius: N/A
 Standard Height: 75 5/8 in.
 Adjustment: For out of plumb walls (approx 1 in. (25mm)) and 1/4 in. (6mm) vertical adjustment on rollers

Width maximum: 36 in.
 Access: N/A

Width minimum: 36 in.
 Door Opening: Lateral

Did you know?

When choosing your Halo Round shower door, be sure to pick the right direction for your bathroom! As shown in the images below, **if the handle is on the right, the shower door is right opening. If the handle is on the left, the shower door is left opening.**

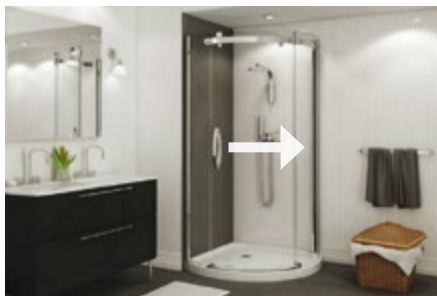

▶ Halo Round shower door
 Left opening
 139399-L

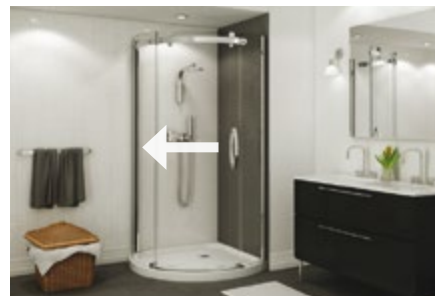

◀ Halo Round shower door
 Right opening
 139399-R

Kameleon Doors



Kameleon Soft Close (SC) alcove door in dark bronze frame finish

Recommended MAAX Shower Bases for Kameleon Doors

		Kameleon doors	
Dimension	Doors (W x H) ¹ ▶	43 - 47 X 71	55 - 59 X 71
Base (L x W) ¹ ▼	Model No	6 mm with Soft Close: 134663	6 mm with Soft Close: 134665
		8 mm with Soft Close: 134674	8 mm with Soft Close: 134675
		6 mm without Soft Close: 134563	6 mm without Soft Close: 134565
		8 mm without Soft Close: 134571	8 mm without Soft Close: 134572
48" Alcove	B3Square/ Round 4832	420001/ 410001	X
	B3Square/ Round 4834	420002/ 410002	X
	B3Square/ Round 4836	420003/ 410003	X
	B3X base 4836	420030	X
	Rectangular base 4832	105060/ 101433	X
	Rectangular base 4834	105534/ 102002	X
	Rectangular base 4836	105059/ 105717	X
60" Alcove	B3Square/ Round 6030	420004/ 410004	X
	B3Square/ Round 6032	420005/ 410005	X
	B3Square/ Round 6036	420006/ 410006	X
	B3X base 6036	420031	X
	Rectangular base 6030	105055/ 105707	X
	Rectangular base 6032	105056/ 105706	X
	Rectangular base 6034	105533/ 102003	X
	Rectangular base 6036	105666	X
		105057/ 105664	X
Rectangular base 6042	105058/ 105716	X	

- Tub doors fit on the majority of MAAX tubs. Please refer to the tubs section for more information.
- Fit may vary depending on wall thickness (acrylic or tile). Validate the height of the product if installing with acrylic walls.

1. L: Length, W: Width, H: Height

Kameleon 6 mm - Shower Doors

- Silent guide eliminates the rattling noise
- High quality rollers for smooth glide
- Safety features: header lock and panel anti-jump
- 8 mm tempered glass and frame color choice
- Modern towel bar
- Reversible header: one side round and one side flat

Regional Availability



KAMELEON DOORS

KAMELEON SEMI-FRAMELESS SLIDING DOOR 40-44 X 71 IN. 6 MM

No	Door Opening	Glass Pattern	Finish	Pkg	Approx. weight	List Price
134562-900-084	Lateral	Clear (900)	Chrome (084)	4.40 ft ³	84 lb	\$ 682
134562-900-305	Lateral	Clear (900)	Brushed Nickel (305)	4.40 ft ³	84 lb	\$ 717
134562-900-172	Lateral	Clear (900)	Dark Bronze (172)	4.40 ft ³	84 lb	\$ 729
134562-981-084	Lateral	Mistelite (981)	Chrome (084)	4.40 ft ³	84 lb	\$ 717
134562-981-305	Lateral	Mistelite (981)	Brushed Nickel (305)	4.40 ft ³	84 lb	\$ 751
134562-981-172	Lateral	Mistelite (981)	Dark Bronze (172)	4.40 ft ³	84 lb	\$ 766

Radius: N/A
 Standard Height: 71 in.
 Adjustment: For out of plumb walls

Width maximum: 44 in.
 Access: N/A

Width minimum: 40 in.
 Door Opening: Lateral

KAMELEON SEMI-FRAMELESS SLIDING DOOR 43-47 X 71 IN. 6 MM

No	Door Opening	Glass Pattern	Finish	Pkg	Approx. weight	List Price
134563-900-084	Lateral	Clear (900)	Chrome (084)	4.69 ft ³	90 lb	\$ 711
134563-900-305	Lateral	Clear (900)	Brushed Nickel (305)	4.69 ft ³	90 lb	\$ 747
134563-900-172	Lateral	Clear (900)	Dark Bronze (172)	4.69 ft ³	90 lb	\$ 761
134563-981-084	Lateral	Mistelite (981)	Chrome (084)	4.69 ft ³	90 lb	\$ 747
134563-981-305	Lateral	Mistelite (981)	Brushed Nickel (305)	4.69 ft ³	90 lb	\$ 784
134563-981-172	Lateral	Mistelite (981)	Dark Bronze (172)	4.69 ft ³	90 lb	\$ 798
134563-988-084	Lateral	Linen (988)	Chrome (084)	4.69 ft ³	90 lb	\$ 747
134563-988-305	Lateral	Linen (988)	Brushed Nickel (305)	4.69 ft ³	90 lb	\$ 784
134563-988-172	Lateral	Linen (988)	Dark Bronze (172)	4.69 ft ³	90 lb	\$ 798

Kameleon 6 mm - Shower Doors (cont'd)

No	Door Opening	Glass Pattern	Finish	Pkg	Approx. weight	List Price
134563-989-084	Lateral	Effervescence (989)	Chrome (084)	4.69 ft³	90 lb	\$ 747
134563-989-305	Lateral	Effervescence (989)	Brushed Nickel (305)	4.69 ft³	90 lb	\$ 784
134563-989-172	Lateral	Effervescence (989)	Dark Bronze (172)	4.69 ft³	90 lb	\$ 798

Radius: N/A
Standard Height: 71 in.
Adjustment: For out of plumb walls

Width maximum: 47 in.
Access: N/A

Width minimum: 43 in.
Door Opening: Lateral

KAMELEON SEMI-FRAMELESS SLIDING DOOR 51-55 X 71 IN. 6 MM

No	Door Opening	Glass Pattern	Finish	Pkg	Approx. weight	List Price
134564-900-084	Lateral	Clear (900)	Chrome (084)	5.27 ft³	98 lb	\$ 734
134564-900-305	Lateral	Clear (900)	Brushed Nickel (305)	5.27 ft³	98 lb	\$ 771
134564-900-172	Lateral	Clear (900)	Dark Bronze (172)	5.27 ft³	98 lb	\$ 785
134564-981-084	Lateral	Mistelite (981)	Chrome (084)	5.27 ft³	98 lb	\$ 771
134564-981-305	Lateral	Mistelite (981)	Brushed Nickel (305)	5.27 ft³	98 lb	\$ 809
134564-981-172	Lateral	Mistelite (981)	Dark Bronze (172)	5.27 ft³	98 lb	\$ 824

Radius: N/A
Standard Height: 71 in.
Adjustment: For out of plumb walls

Width maximum: 55 in.
Access: N/A

Width minimum: 51 in.
Door Opening: Lateral

KAMELEON SEMI-FRAMELESS SLIDING DOOR 55-59 X 71 IN. 6 MM

No	Door Opening	Glass Pattern	Finish	Pkg	Approx. weight	List Price
134565-900-084	Lateral	Clear (900)	Chrome (084)	5.56 ft³	106 lb	\$ 740
134565-900-305	Lateral	Clear (900)	Brushed Nickel (305)	5.56 ft³	106 lb	\$ 776
134565-900-172	Lateral	Clear (900)	Dark Bronze (172)	5.56 ft³	106 lb	\$ 792
134565-981-084	Lateral	Mistelite (981)	Chrome (084)	5.56 ft³	106 lb	\$ 776
134565-981-305	Lateral	Mistelite (981)	Brushed Nickel (305)	5.56 ft³	106 lb	\$ 816
134565-981-172	Lateral	Mistelite (981)	Dark Bronze (172)	5.56 ft³	106 lb	\$ 831
134565-989-084	Lateral	Effervescence (989)	Chrome (084)	5.56 ft³	106 lb	\$ 776
134565-989-305	Lateral	Effervescence (989)	Brushed Nickel (305)	5.56 ft³	106 lb	\$ 816
134565-989-172	Lateral	Effervescence (989)	Dark Bronze (172)	5.56 ft³	106 lb	\$ 831
134565-988-084	Lateral	Linen (988)	Chrome (084)	5.56 ft³	106 lb	\$ 776
134565-988-305	Lateral	Linen (988)	Brushed Nickel (305)	5.56 ft³	106 lb	\$ 816
134565-988-172	Lateral	Linen (988)	Dark Bronze (172)	5.56 ft³	106 lb	\$ 831

Radius: N/A
Standard Height: 71 in.
Adjustment: For out of plumb walls

Width maximum: 59 in.
Access: N/A

Width minimum: 55 in.
Door Opening: Lateral

Kameleon 6 mm - Shower Doors

COMMON OPTIONS

No	Model	Approx. weight	List Price
OPT 20245-084	18 in. T-round towel bar Available color: Chrome (084)	N/A	Add \$ 53
OPT 20245-172	18 in. T-round towel bar Available color: Dark Bronze (172)	N/A	Add \$ 60
OPT 20245-305	18 in. T-round towel bar Available color: Brushed Nickel (305)	N/A	Add \$ 58
OPT 20247-084	18 in. Square towel bar Available color: Chrome (084)	N/A	Add \$ 53
OPT 20247-172	18 in. Square towel bar Available color: Dark Bronze (172)	N/A	Add \$ 60
OPT 20247-305	18 in. Square towel bar Available color: Brushed Nickel (305)	N/A	Add \$ 58

ACCESSORIES

No	Model	Approx. weight	List Price
10068355-084-602	18 in. T-round towel bar Available color: Chrome (084)	N/A	\$ 132
10068355-172-602	18 in. T-round towel bar Available color: Dark Bronze (172)	N/A	\$ 144
10068355-305-602	18 in. T-round towel bar Available color: Brushed Nickel (305)	N/A	\$ 137
10068376-084-602	18 in. Square towel bar Available color: Chrome (084)	N/A	\$ 132
10068376-172-602	18 in. Square towel bar Available color: Dark Bronze (172)	N/A	\$ 144
10068376-305-602	18 in Square towel bar Available color: Brushed Nickel (305)	N/A	\$ 137
10068410-005-601	Soft Close by MAAX for Kameleon doors only	N/A	\$ 105

Kameleon SC 6 mm - Shower Doors

- Innovative SOFT CLOSE by MAAx prevents slamming
- Silent guide eliminates the rattling noise
- High quality rollers for smooth glide
- Safety features: header lock and panel anti-jump
- 6mm tempered glass and frame color choice
- Modern towel bar

Regional Availability



KAMELEON DOORS

KAMELEON SC SEMI-FRAMELESS SLIDING DOOR 40-44 X 71 IN. 6 MM

No	Door Opening	Glass Pattern	Finish	Pkg	Approx. weight	List Price
134662-900-084	Lateral	Clear (900)	Chrome (084)	4.40 ft ³	84 lb	\$ 781
134662-900-305	Lateral	Clear (900)	Brushed Nickel (305)	4.40 ft ³	84 lb	\$ 815
134662-900-172	Lateral	Clear (900)	Dark Bronze (172)	4.40 ft ³	84 lb	\$ 828
134662-981-084	Lateral	Mistelite (981)	Chrome (084)	4.40 ft ³	84 lb	\$ 815
134662-981-305	Lateral	Mistelite (981)	Brushed Nickel (305)	4.40 ft ³	84 lb	\$ 850
134662-981-172	Lateral	Mistelite (981)	Dark Bronze (172)	4.40 ft ³	84 lb	\$ 865

Radius: N/A
Standard Height: 71 in.
Adjustment: for out of plumb walls

Width maximum: 44 in.
Access: N/A

Width minimum: 40 in.
Door Opening: Lateral

KAMELEON SC SEMI-FRAMELESS SLIDING DOOR 43-47 X 71 IN. 6 MM

No	Door Opening	Glass Pattern	Finish	Pkg	Approx. weight	List Price
134663-900-084	Lateral	Clear (900)	Chrome (084)	4.69 ft ³	90 lb	\$ 809
134663-900-305	Lateral	Clear (900)	Brushed Nickel (305)	4.69 ft ³	90 lb	\$ 845
134663-900-172	Lateral	Clear (900)	Dark Bronze (172)	4.69 ft ³	90 lb	\$ 858
134663-981-084	Lateral	Mistelite (981)	Chrome (084)	4.69 ft ³	90 lb	\$ 845
134663-981-305	Lateral	Mistelite (981)	Brushed Nickel (305)	4.69 ft ³	90 lb	\$ 881
134663-981-172	Lateral	Mistelite (981)	Dark Bronze (172)	4.69 ft ³	90 lb	\$ 897
134663-988-084	Lateral	Linen (988)	Chrome (084)	4.69 ft ³	90 lb	\$ 845
134663-988-305	Lateral	Linen (988)	Brushed Nickel (305)	4.69 ft ³	90 lb	\$ 881
134663-988-172	Lateral	Linen (988)	Dark Bronze (172)	4.69 ft ³	90 lb	\$ 897

Kameleon SC 6 mm - Shower Doors (cont'd)

No	Door Opening	Glass Pattern	Finish	Pkg	Approx. weight	List Price
134663-989-084	Lateral	Effervescence (989)	Chrome (084)	4.69 ft ³	90 lb	\$ 845
134663-989-305	Lateral	Effervescence (989)	Brushed Nickel (305)	4.69 ft ³	90 lb	\$ 881
134663-989-172	Lateral	Effervescence (989)	Dark Bronze (172)	4.69 ft ³	90 lb	\$ 897

Radius: N/A

Standard Height: 71 in.

Adjustment: For out of plumb walls

Width maximum: 47 in.

Access: N/A

Width minimum: 43 in.

Door Opening: Lateral

KAMELEON SC SEMI-FRAMELESS SLIDING DOOR 51-55 X 71 IN. 6 MM

No	Door Opening	Glass Pattern	Finish	Pkg	Approx. weight	List Price
134664-900-084	Lateral	Clear (900)	Chrome (084)	5.27 ft ³	98 lb	\$ 832
134664-900-305	Lateral	Clear (900)	Brushed Nickel (305)	5.27 ft ³	98 lb	\$ 869
134664-900-172	Lateral	Clear (900)	Dark Bronze (172)	5.27 ft ³	98 lb	\$ 882
134664-981-084	Lateral	Mistelite (981)	Chrome (084)	5.27 ft ³	98 lb	\$ 869
134664-981-305	Lateral	Mistelite (981)	Brushed Nickel (305)	5.27 ft ³	98 lb	\$ 908
134664-981-172	Lateral	Mistelite (981)	Dark Bronze (172)	5.27 ft ³	98 lb	\$ 922

Radius: N/A

Standard Height: 71 in.

Adjustment: For out of plumb walls

Width maximum: 55 in.

Access: N/A

Width minimum: 51 in.

Door Opening: Lateral

KAMELEON SC SEMI-FRAMELESS SLIDING DOOR 55-59 X 71 IN. 6 MM

No	Door Opening	Glass Pattern	Finish	Pkg	Approx. weight	List Price
134665-900-084	Lateral	Clear (900)	Chrome (084)	5.56 ft ³	106 lb	\$ 838
134665-900-305	Lateral	Clear (900)	Brushed Nickel (305)	5.56 ft ³	106 lb	\$ 875
134665-900-172	Lateral	Clear (900)	Dark Bronze (172)	5.56 ft ³	106 lb	\$ 890
134665-981-084	Lateral	Mistelite (981)	Chrome (084)	5.56 ft ³	106 lb	\$ 875
134665-981-305	Lateral	Mistelite (981)	Brushed Nickel (305)	5.56 ft ³	106 lb	\$ 914
134665-981-172	Lateral	Mistelite (981)	Dark Bronze (172)	5.56 ft ³	106 lb	\$ 929
134665-989-084	Lateral	Effervescence (989)	Chrome (084)	5.56 ft ³	106 lb	\$ 875
134665-989-305	Lateral	Effervescence (989)	Brushed Nickel (305)	5.56 ft ³	106 lb	\$ 914
134665-989-172	Lateral	Effervescence (989)	Dark Bronze (172)	5.56 ft ³	106 lb	\$ 929
134665-988-084	Lateral	Linen (988)	Chrome (084)	5.56 ft ³	106 lb	\$ 875
134665-988-305	Lateral	Linen (988)	Brushed Nickel (305)	5.56 ft ³	106 lb	\$ 914
134665-988-172	Lateral	Linen (988)	Dark Bronze (172)	5.56 ft ³	106 lb	\$ 929

Radius: N/A

Standard Height: 71 in.

Adjustment: For out of plumb walls

Width maximum: 59 in.

Access: N/A

Width minimum: 55 in.

Door Opening: Lateral

KAMELEON DOORS

Kameleon SC 6 mm - Shower Doors (cont'd)

COMMON OPTIONS

No	Model	Approx. weight	List Price
OPT 20245-084	18 in. T-round towel bar Available color: Chrome (084)	N/A	Add \$ 53
OPT 20245-172	18 in. T-round towel bar Available color: Dark Bronze (172)	N/A	Add \$ 60
OPT 20245-305	18 in. T-round towel bar Available color: Brushed Nickel (305)	N/A	Add \$ 58
OPT 20247-084	18 in. Square towel bar Available color: Chrome (084)	N/A	Add \$ 53
OPT 20247-172	18 in. Square towel bar Available color: Dark Bronze (172)	N/A	Add \$ 60
OPT 20247-305	18 in. Square towel bar Available color: Brushed Nickel (305)	N/A	Add \$ 58

ACCESSORIES

No	Model	Approx. weight	List Price
10068355-084-602	18 in. T-round towel bar Available color: Chrome (084)	N/A	\$ 132
10068355-172-602	18 in. T-round towel bar Available color: Dark Bronze (172)	N/A	\$ 144
10068355-305-602	18 in. T-round towel bar Available color: Brushed Nickel (305)	N/A	\$ 137
10068376-084-602	18 in. Square towel bar Available color: Chrome (084)	N/A	\$ 132
10068376-172-602	18 in. Square towel bar Available color: Dark Bronze (172)	N/A	\$ 144
10068376-305-602	18 in Square towel bar Available color: Brushed Nickel (305)	N/A	\$ 137
10068410-005-601	Soft Close by MAAX for Kameleon doors only	N/A	\$ 105

Kameleon 6 mm - Tub Doors

- Silent guide eliminates the rattling noise
- High quality rollers for smooth glide
- Safety features: header lock and panel anti-jump
- Multiple glass options: clear, semi-private and private with frame color choice
- Rounded towel bar for a clean and versatile look

Regional Availability



KAMELEON DOORS

KAMELEON SEMI-FRAMELESS SLIDING DOOR 51-55 X 57 IN. 6 MM

No	Door Opening	Glass Pattern	Finish	Pkg	Approx. weight	List Price
134560-900-084	Lateral	Clear (900)	Chrome (084)	4.11 ft ³	85 lb	\$ 682
134560-900-305	Lateral	Clear (900)	Brushed Nickel (305)	4.11 ft ³	85 lb	\$ 717
134560-900-172	Lateral	Clear (900)	Dark Bronze (172)	4.11 ft ³	85 lb	\$ 729
134560-981-084	Lateral	Mistelite (981)	Chrome (084)	4.11 ft ³	85 lb	\$ 717
134560-981-305	Lateral	Mistelite (981)	Brushed Nickel (305)	4.11 ft ³	85 lb	\$ 751
134560-981-172	Lateral	Mistelite (981)	Dark Bronze (172)	4.11 ft ³	85 lb	\$ 766

Radius: N/A
Standard Height: 57 in.
Adjustment:

Width maximum: 55 in.
Access: N/A

Width minimum: 51 in.
Door Opening: Lateral

KAMELEON SEMI-FRAMELESS SLIDING DOOR 55-59 X 57 IN. 6 MM

No	Door Opening	Glass Pattern	Finish	Pkg	Approx. weight	List Price
134561-900-084	Lateral	Clear (900)	Chrome (084)	4.58 ft ³	85 lb	\$ 711
134561-900-305	Lateral	Clear (900)	Brushed Nickel (305)	4.58 ft ³	85 lb	\$ 747
134561-900-172	Lateral	Clear (900)	Dark Bronze (172)	4.58 ft ³	85 lb	\$ 761
134561-981-084	Lateral	Mistelite (981)	Chrome (084)	4.58 ft ³	85 lb	\$ 805
134561-981-305	Lateral	Mistelite (981)	Brushed Nickel (305)	4.58 ft ³	85 lb	\$ 845
134561-981-172	Lateral	Mistelite (981)	Dark Bronze (172)	4.58 ft ³	85 lb	\$ 861
134561-989-084	Lateral	Effervescence (989)	Chrome (084)	4.58 ft ³	85 lb	\$ 805
134561-989-305	Lateral	Effervescence (989)	Brushed Nickel (305)	4.58 ft ³	85 lb	\$ 845
134561-989-172	Lateral	Effervescence (989)	Dark Bronze (172)	4.58 ft ³	85 lb	\$ 861

Kameleon 6 mm - Tub Doors (cont'd)

No	Door Opening	Glass Pattern	Finish	Pkg	Approx. weight	List Price
134561-988-084	Lateral	Linen (988)	Chrome (084)	4.58 ft³	85 lb	\$ 805
134561-988-305	Lateral	Linen (988)	Brushed Nickel (305)	4.58 ft³	85 lb	\$ 845
134561-988-172	Lateral	Linen (988)	Dark Bronze (172)	4.58 ft³	85 lb	\$ 861

Radius: N/A
Standard Height: 57 in.
Adjustment:

Width maximum: 59 in.
Access: N/A

Width minimum: 55 in.
Door Opening: Lateral

COMMON OPTIONS

No	Model	Approx. weight	List Price
OPT 20246-084	24 in. T-round towel bar Available color: Chrome (084)	N/A	Add \$ 63
OPT 20246-172	24 in. T-round towel bar Available color: Dark Bronze (172)	N/A	Add \$ 71
OPT 20246-305	24 in. T-round towel bar Available color: Brushed Nickel (305)	N/A	Add \$ 69
OPT 20248-084	24 in. Square towel bar Available color: Chrome (084)	N/A	Add \$ 63
OPT 20248-172	24 in. Square towel bar Available color: Dark Bronze (172)	N/A	Add \$ 71
OPT 20248-305	24 in. Square towel bar Available color: Brushed Nickel (305)	N/A	Add \$ 69

ACCESSORIES

No	Model	Approx. weight	List Price
10068355-084-603	24 in. T-round towel bar Available color: Chrome (084)	N/A	\$ 142
10068355-172-603	24 in. T-round towel bar Available color: Dark Bronze (172)	N/A	\$ 155
10068355-305-603	24 in. T-round towel bar Available color: Brushed Nickel (305)	N/A	\$ 147
10068376-084-603	24 in. Square towel bar Available color: Chrome (084)	N/A	\$ 142
10068376-172-603	24 in. Square towel bar Available color: Dark Bronze (172)	N/A	\$ 155
10068376-305-603	24 in. Square towel bar Available color: Brushed Nickel (305)	N/A	\$ 147
10068410-005-601	Soft Close by MAAX for Kameleon doors only	N/A	\$ 105

Kameleon SC 6 mm - Tub Doors

- Innovative SOFT CLOSE by MAAX prevents slamming
- Silent guide eliminates the rattling noise
- High quality rollers for smooth glide
- Safety features: header lock and panel anti-jump
- 6 mm tempered glass and frame color choice
- Modern towel bar

Regional Availability



KAMELEON DOORS

KAMELEON SC SEMI-FRAMELESS SLIDING DOOR 51-55 X 57 IN. 6 MM

No	Door Opening	Glass Pattern	Finish	Pkg	Approx. weight	List Price
134660-900-084	Lateral	Clear (900)	Chrome (084)	4.11 ft ³	85 lb	\$ 781
134660-900-305	Lateral	Clear (900)	Brushed Nickel (305)	4.11 ft ³	85 lb	\$ 815
134660-900-172	Lateral	Clear (900)	Dark Bronze (172)	4.11 ft ³	85 lb	\$ 830
134660-981-084	Lateral	Mistelite (981)	Chrome (084)	4.11 ft ³	85 lb	\$ 815
134660-981-305	Lateral	Mistelite (981)	Brushed Nickel (305)	4.11 ft ³	85 lb	\$ 850
134660-981-172	Lateral	Mistelite (981)	Dark Bronze (172)	4.11 ft ³	85 lb	\$ 865

Radius: N/A
Standard Height: 57 in.
Adjustment:

Width maximum: 55 in.
Access: N/A

Width minimum: 51 in.
Door Opening: Lateral

KAMELEON SC SEMI-FRAMELESS SLIDING DOOR 55-59 X 57 IN. 6 MM

No	Door Opening	Glass Pattern	Finish	Pkg	Approx. weight	List Price
134661-900-084	Lateral	Clear (900)	Chrome (084)	4.58 ft ³	85 lb	\$ 809
134661-900-305	Lateral	Clear (900)	Brushed Nickel (305)	4.58 ft ³	85 lb	\$ 845
134661-900-172	Lateral	Clear (900)	Dark Bronze (172)	4.58 ft ³	85 lb	\$ 858
134661-981-084	Lateral	Mistelite (981)	Chrome (084)	4.58 ft ³	85 lb	\$ 902
134661-981-305	Lateral	Mistelite (981)	Brushed Nickel (305)	4.58 ft ³	85 lb	\$ 943
134661-981-172	Lateral	Mistelite (981)	Dark Bronze (172)	4.58 ft ³	85 lb	\$ 959
134661-989-084	Lateral	Effervescence (989)	Chrome (084)	4.58 ft ³	85 lb	\$ 902
134661-989-305	Lateral	Effervescence (989)	Brushed Nickel (305)	4.58 ft ³	85 lb	\$ 943
134661-989-172	Lateral	Effervescence (989)	Dark Bronze (172)	4.58 ft ³	85 lb	\$ 959

Kameleon SC 6 mm - Tub Doors (cont'd)

No	Door Opening	Glass Pattern	Finish	Pkg	Approx. weight	List Price
134661-988-084	Lateral	Linen (988)	Chrome (084)	4.58 ft³	85 lb	\$ 902
134661-988-305	Lateral	Linen (988)	Brushed Nickel (305)	4.58 ft³	85 lb	\$ 943
134661-988-172	Lateral	Linen (988)	Dark Bronze (172)	4.58 ft³	85 lb	\$ 959

Radius: N/A
Standard Height: 57 in.
Adjustment:

Width maximum: 59 in.
Access: N/A

Width minimum: 55 in.
Door Opening: Lateral

COMMON OPTIONS

No	Model	Approx. weight	List Price
OPT 20246-084	24 in. T-round towel bar Available color: Chrome (084)	N/A	Add \$ 63
OPT 20246-172	24 in. T-round towel bar Available color: Dark Bronze (172)	N/A	Add \$ 71
OPT 20246-305	24 in. T-round towel bar Available color: Brushed Nickel (305)	N/A	Add \$ 69
OPT 20248-084	24 in. Square towel bar Available color: Chrome (084)	N/A	Add \$ 63
OPT 20248-172	24 in. Square towel bar Available color: Dark Bronze (172)	N/A	Add \$ 71
OPT 20248-305	24 in. Square towel bar Available color: Brushed Nickel (305)	N/A	Add \$ 69

ACCESSORIES

No	Model	Approx. weight	List Price
10068355-084-603	24 in. T-round towel bar Available color: Chrome (084)	N/A	\$ 142
10068355-172-603	24 in. T-round towel bar Available color: Dark Bronze (172)	N/A	\$ 155
10068355-305-603	24 in. T-round towel bar Available color: Brushed Nickel (305)	N/A	\$ 147
10068376-084-603	24 in. Square towel bar Available color: Chrome (084)	N/A	\$ 142
10068376-172-603	24 in. Square towel bar Available color: Dark Bronze (172)	N/A	\$ 155
10068376-305-603	24 in. Square towel bar Available color: Brushed Nickel (305)	N/A	\$ 147
10068410-005-601	Soft Close by MAAX for Kameleon doors only	N/A	\$ 105

Kameleon 8 mm - Shower Doors

- Silent guide eliminates the rattling noise
- High quality rollers for smooth glide
- Safety features: header lock and panel anti-jump
- 8 mm tempered glass and frame color choice
- Modern towel bar
- Reversible header: one side round and one side flat

Regional Availability



KAMELEON DOORS

KAMELEON SEMI-FRAMELESS SLIDING DOOR 43-47 X 71 IN. 8 MM

No	Door Opening	Glass Pattern	Finish	Pkg	Approx. weight	List Price
134571-900-084	Lateral	Clear (900)	Chrome (084)	4.69 ft ³	116 lb	\$ 827
134571-900-305	Lateral	Clear (900)	Brushed Nickel (305)	4.69 ft ³	116 lb	\$ 868
134571-900-172	Lateral	Clear (900)	Dark Bronze (172)	4.69 ft ³	116 lb	\$ 885

Radius: N/A
Standard Height: 71 in.
Adjustment: For out of plumb walls

Width maximum: 47 in.
Access: N/A

Width minimum: 43 in.
Door Opening: Lateral

KAMELEON SEMI-FRAMELESS SLIDING DOOR 55-59 X 71 IN. 8 MM

No	Door Opening	Glass Pattern	Finish	Pkg	Approx. weight	List Price
134572-900-084	Lateral	Clear (900)	Chrome (084)	5.56 ft ³	137 lb	\$ 855
134572-900-305	Lateral	Clear (900)	Brushed Nickel (305)	5.56 ft ³	137 lb	\$ 898
134572-900-172	Lateral	Clear (900)	Dark Bronze (172)	5.56 ft ³	137 lb	\$ 915

Radius: N/A
Standard Height: 71 in.
Adjustment: For out of plumb walls

Width maximum: 59 in.
Access: N/A

Width minimum: 55 in.
Door Opening: Lateral

COMMON OPTIONS

No	Model	Approx. weight	List Price
OPT 20245-084	18 in. T-round towel bar Available color: Chrome (084)	N/A	Add \$ 53
OPT 20245-172	18 in. T-round towel bar Available color: Dark Bronze (172)	N/A	Add \$ 60
OPT 20245-305	18 in. T-round towel bar Available color: Brushed Nickel (305)	N/A	Add \$ 58
OPT 20247-084	18 in. Square towel bar Available color: Chrome (084)	N/A	Add \$ 53

Kameleon 8 mm - Shower Doors (cont'd)

No	Model	Approx. weight	List Price
OPT 20247-172	18 in. Square towel bar Available color: Dark Bronze (172)	N/A	Add \$ 60
OPT 20247-305	18 in. Square towel bar Available color: Brushed Nickel (305)	N/A	Add \$ 58

ACCESSORIES

No	Model	Approx. weight	List Price
10068376-084-602	18 in. Square towel bar Available color: Chrome (084)	N/A	\$ 132
10068376-172-602	18 in. Square towel bar Available color: Dark Bronze (172)	N/A	\$ 144
10068376-305-602	18 in Square towel bar Available color: Brushed Nickel (305)	N/A	\$ 137
10068355-084-602	18 in. T-round towel bar Available color: Chrome (084)	N/A	\$ 132
10068355-172-602	18 in. T-round towel bar Available color: Dark Bronze (172)	N/A	\$ 144
10068355-305-602	18 in. T-round towel bar Available color: Brushed Nickel (305)	N/A	\$ 137
10068410-005-601	Soft Close by MAAX for Kameleon doors only	N/A	\$ 105

Kameleon SC 8 mm - Shower Doors

- Innovative SOFT CLOSE by MAAx prevents slamming
- Silent guide eliminates the rattling noise
- High quality rollers for smooth glide
- Safety features: header lock and panel anti-jump
- 8 mm tempered glass and frame color choice
- Modern towel bar

Regional Availability



KAMELEON DOORS

KAMELEON SC SEMI-FRAMELESS SLIDING DOOR 43-47 X 71 IN. 8 MM

No	Door Opening	Glass Pattern	Finish	Pkg	Approx. weight	List Price
134674-900-084	Lateral	Clear (900)	Chrome (084)	4.69 ft ³	116 lb	\$ 924
134674-900-305	Lateral	Clear (900)	Brushed Nickel (305)	4.69 ft ³	116 lb	\$ 966
134674-900-172	Lateral	Clear (900)	Dark Bronze (172)	4.69 ft ³	116 lb	\$ 982

Radius: N/A
Standard Height: 71 in.
Adjustment: For out of plumb walls

Width maximum: 47 in.
Access: N/A

Width minimum: 43 in.
Door Opening: Lateral

KAMELEON SC SEMI-FRAMELESS SLIDING DOOR 55-59 X 71 IN. 8 MM

No	Door Opening	Glass Pattern	Finish	Pkg	Approx. weight	List Price
134675-900-084	Lateral	Clear (900)	Chrome (084)	5.56 ft ³	137 lb	\$ 954
134675-900-305	Lateral	Clear (900)	Brushed Nickel (305)	5.56 ft ³	137 lb	\$ 996
134675-900-172	Lateral	Clear (900)	Dark Bronze (172)	5.56 ft ³	137 lb	\$ 1,014

Radius: N/A
Standard Height: 71 in.
Adjustment: For out of plumb walls

Width maximum: 59 in.
Access: N/A

Width minimum: 55 in.
Door Opening: Lateral

COMMON OPTIONS

No	Model	Approx. weight	List Price
OPT 20245-084	18 in. T-round towel bar Available color: Chrome (084)	N/A	Add \$ 53
OPT 20245-172	18 in. T-round towel bar Available color: Dark Bronze (172)	N/A	Add \$ 60
OPT 20245-305	18 in. T-round towel bar Available color: Brushed Nickel (305)	N/A	Add \$ 58
OPT 20247-084	18 in. Square towel bar Available color: Chrome (084)	N/A	Add \$ 53

Kameleon SC 8 mm - Shower Doors (cont'd)

No	Model	Approx. weight	List Price
OPT 20247-172	18 in. Square towel bar Available color: Dark Bronze (172)	N/A	Add \$ 60
OPT 20247-305	18 in. Square towel bar Available color: Brushed Nickel (305)	N/A	Add \$ 58

ACCESSORIES

No	Model	Approx. weight	List Price
10068355-084-602	18 in. T-round towel bar Available color: Chrome (084)	N/A	\$ 132
10068355-172-602	18 in. T-round towel bar Available color: Dark Bronze (172)	N/A	\$ 144
10068355-305-602	18 in. T-round towel bar Available color: Brushed Nickel (305)	N/A	\$ 137
10068376-084-602	18 in. Square towel bar Available color: Chrome (084)	N/A	\$ 132
10068376-172-602	18 in. Square towel bar Available color: Dark Bronze (172)	N/A	\$ 144
10068376-305-602	18 in Square towel bar Available color: Brushed Nickel (305)	N/A	\$ 137
10068410-005-601	Soft Close by MAAX for Kameleon doors only	N/A	\$ 105

Kameleon 8 mm - Tub Door

- Silent guide eliminates the rattling noise
- High quality rollers for smooth glide
- Safety features: header lock and panel anti-jump
- 8 mm tempered glass and frame color choice
- Modern towel bar
- Reversible header: one side round and one side flat

Regional Availability



KAMELEON DOORS

KAMELEON SEMI-FRAMELESS SLIDING DOOR 55-59 X 57 IN. 8 MM

No	Door Opening	Glass Pattern	Finish	Pkg	Approx. weight	List Price
134573-900-084	Lateral	Clear (900)	Chrome (084)	4.58 ft ³	110 lb	\$ 827
134573-900-305	Lateral	Clear (900)	Brushed Nickel (305)	4.58 ft ³	110 lb	\$ 868
134573-900-172	Lateral	Clear (900)	Dark Bronze (172)	4.58 ft ³	110 lb	\$ 885
134573-963-084	Lateral	French door (963)	Chrome (084)	4.58 ft ³	110 lb	\$ 924
134573-963-305	Lateral	French door (963)	Brushed Nickel (305)	4.58 ft ³	110 lb	\$ 971
134573-963-172	Lateral	French door (963)	Dark Bronze (172)	4.58 ft ³	110 lb	\$ 990

Radius: N/A
Standard Height: 57 in.
Adjustment:

Width maximum: 59 in.
Access: N/A

Width minimum: 55 in.
Door Opening: Lateral

COMMON OPTIONS

No	Model	Approx. weight	List Price
OPT 20246-084	24 in. T-round towel bar Available color: Chrome (084)	N/A	Add \$ 63
OPT 20246-172	24 in. T-round towel bar Available color: Dark Bronze (172)	N/A	Add \$ 71
OPT 20246-305	24 in. T-round towel bar Available color: Brushed Nickel (305)	N/A	Add \$ 69
OPT 20248-084	24 in. Square towel bar Available color: Chrome (084)	N/A	Add \$ 63
OPT 20248-172	24 in. Square towel bar Available color: Dark Bronze (172)	N/A	Add \$ 71
OPT 20248-305	24 in. Square towel bar Available color: Brushed Nickel (305)	N/A	Add \$ 69

Kameleon 8 mm - Tub Door (cont'd)

ACCESSORIES

No	Model	Approx. weight	List Price
10068355-084-603	24 in. T-round towel bar Available color: Chrome (084)	N/A	\$ 142
10068355-172-603	24 in. T-round towel bar Available color: Dark Bronze (172)	N/A	\$ 155
10068355-305-603	24 in. T-round towel bar Available color: Brushed Nickel (305)	N/A	\$ 147
10068376-084-603	24 in. Square towel bar Available color: Chrome (084)	N/A	\$ 142
10068376-172-603	24 in. Square towel bar Available color: Dark Bronze (172)	N/A	\$ 155
10068376-305-603	24 in. Square towel bar Available color: Brushed Nickel (305)	N/A	\$ 147
10068410-005-601	Soft Close by MAAX for Kameleon doors only	N/A	\$ 105



Kameleon SC tub door in brushed nickel

Kameleon Doors

Make your perfect match in **5** easy steps

- 1** Choose the **style** (tub or shower door) and determine door opening
- 2** Select **glass thickness**
- 3** Decide **glass pattern**
- 4** Determine the **frame & towel bar finish**
- 5** Choose the **towel bar**

See video of installation



Kameleon SC 8 mm - Tub Door

- Innovative SOFT CLOSE by MAAX prevents slamming
- Silent guide eliminates the rattling noise
- High quality rollers for smooth glide
- Safety features: header lock and panel anti-jump
- 8 mm tempered glass and frame color choice
- Modern towel bar

Regional Availability



SOFT CLOSE™
MAAX

KAMELEON DOORS

KAMELEON SC SEMI-FRAMELESS SLIDING DOOR 55-59 X 57 IN. 8 MM

No	Door Opening	Glass Pattern	Finish	Pkg	Approx. weight	List Price
134670-900-084	Lateral	Clear (900)	Chrome (084)	4.58 ft ³	110 lb	\$ 924
134670-900-305	Lateral	Clear (900)	Brushed Nickel (305)	4.58 ft ³	110 lb	\$ 966
134670-900-172	Lateral	Clear (900)	Dark Bronze (172)	4.58 ft ³	110 lb	\$ 982
134670-963-084	Lateral	French door (963)	Chrome (084)	4.58 ft ³	110 lb	\$ 1,023
134670-963-305	Lateral	French door (963)	Brushed Nickel (305)	4.58 ft ³	110 lb	\$ 1,069
134670-963-172	Lateral	French door (963)	Dark Bronze (172)	4.58 ft ³	110 lb	\$ 1,087

Radius: N/A
Standard Height: 57 in.
Adjustment:

Width maximum: 59 in.
Access: N/A

Width minimum: 55 in.
Door Opening: Lateral

COMMON OPTIONS

No	Model	Approx. weight	List Price
OPT 20246-084	24 in. T-round towel bar Available color: Chrome (084)	N/A	Add \$ 63
OPT 20246-172	24 in. T-round towel bar Available color: Dark Bronze (172)	N/A	Add \$ 71
OPT 20246-305	24 in. T-round towel bar Available color: Brushed Nickel (305)	N/A	Add \$ 69
OPT 20248-084	24 in. Square towel bar Available color: Chrome (084)	N/A	Add \$ 63
OPT 20248-172	24 in. Square towel bar Available color: Dark Bronze (172)	N/A	Add \$ 71
OPT 20248-305	24 in. Square towel bar Available color: Brushed Nickel (305)	N/A	Add \$ 69

Kameleon SC 8 mm - Tub Door (cont'd)

ACCESSORIES

No	Model	Approx. weight	List Price
10068355-084-603	24 in. T-round towel bar Available color: Chrome (084)	N/A	\$ 142
10068355-172-603	24 in. T-round towel bar Available color: Dark Bronze (172)	N/A	\$ 155
10068355-305-603	24 in. T-round towel bar Available color: Brushed Nickel (305)	N/A	\$ 147
10068376-084-603	24 in. Square towel bar Available color: Chrome (084)	N/A	\$ 142
10068376-172-603	24 in. Square towel bar Available color: Dark Bronze (172)	N/A	\$ 155
10068376-305-603	24 in. Square towel bar Available color: Brushed Nickel (305)	N/A	\$ 147
10068410-005-601	Soft Close by MAAX for Kameleon doors only	N/A	\$ 105



All ModulR sliding doors are equipped with the Soft Close.
Optional Soft Close System also available on Kameleon doors.



No More Slamming Doors

You'll love the "No Bang" effect with the **SOFT CLOSE system**. This feature keeps ears and fingers safe by easing the door shut no matter how hard you slam it.

This **graceful, gradual closing**—a great child-friendly feature for families—also helps minimize door-to-frame impact to extend product life.



Luminescence Doors



Luminescence shower door with B3X 6032 shower base

Recommended MAAX Shower Bases for Luminescence Doors

		Luminescence doors	
Dimension	Doors (W x H) ¹ ▶	44½ - 47 X 70½	56½ - 59 X 70½
Base (L x W) ¹ ▼	Model No	138992	138993
48" Alcove	B3Square/ Round 4832	420001/ 410001	X
	B3Square/ Round 4834	420002/ 410002	X
	B3Square/ Round 4836	420003/ 410003	X
	B3X base 4836	420030	X
	Rectangular base 4832	105060/ 101433	X
	Rectangular base 4834	105534/ 102002	X
	Rectangular base 4836	105059/ 105717	X
60" Alcove	B3Square/ Round 6030	420004/ 410004	X
	B3Square/ Round 6032	420005/ 410005	X
	B3Square/ Round 6036	420006/ 410006	X
	B3X base 6036	420031	X
	Rectangular base 6030	105055/ 105707	X
	Rectangular base 6032	105056/ 105706	X
	Rectangular base 6034	105533/ 102003	X
	Rectangular base 6036	105666	X
		105057/ 105664	X
	Rectangular base 6042	105058/ 105716	X

- Tub doors fit on the majority of MAAX tubs. Please refer to the tubs section for more information.
- Fit may vary depending on wall thickness (acrylic or tile). Validate the height of the product if installing with acrylic walls.

1. L: Length, W: Width, H: Height

Luminescence - Shower Doors

- Elegant 1/4 in. (6 mm) clear tempered glass with minimalist hardware
- Fits showers with 70 1/2 in. wall clearance, glass extends to 72 in.
- Ball bearing roller system - door closes gently & quietly
- Door is reversible - provides a right or left opening
- Available in 3 finishes Chrome, Brushed Nickel and Dark Bronze

Regional Availability

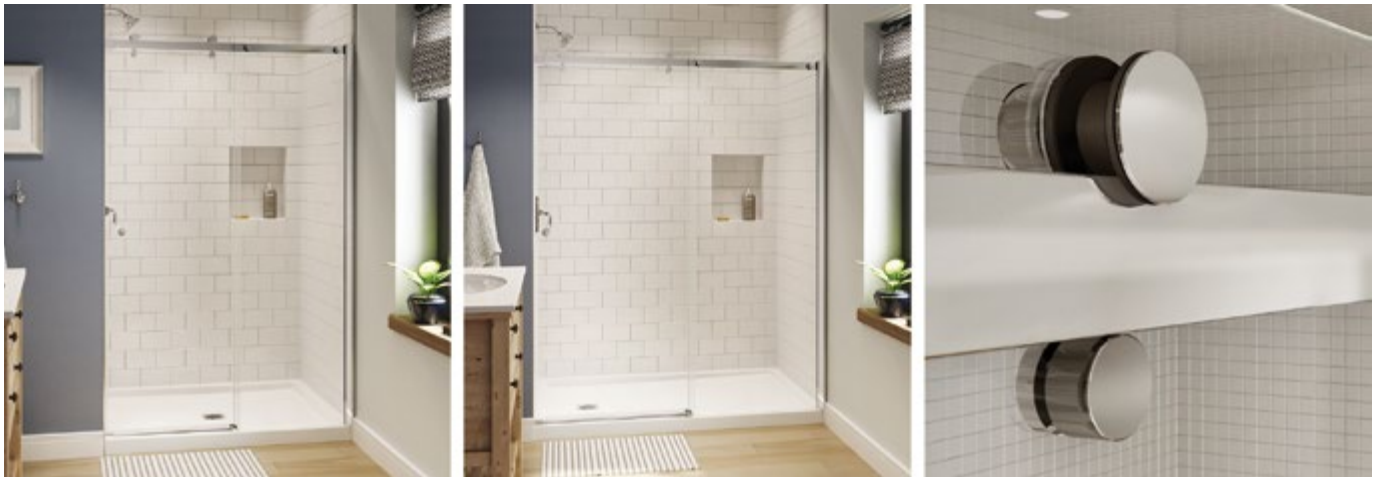

LUMINESCENCE DOORS

LUMINESCENCE FRAMELESS SLIDING DOOR 44 1/2-47 X 70 1/2 IN. 6 MM

No	Door Opening	Glass Pattern	Finish	Pkg	Approx. weight	List Price
138992-900-084	Lateral	Clear (900)	Chrome (084)	4.04 ft ³	84 lb	\$ 910
138992-900-305	Lateral	Clear (900)	Brushed Nickel (305)	4.04 ft ³	84 lb	\$ 938
138992-900-173	Lateral	Clear (900)	Dark Bronze (173)	4.04 ft ³	84 lb	\$ 954

Radius: N/A
 Standard Height: 70 1/2 - 72 in.
 Adjustment: For out-of-plumb walls

Width maximum: 47 in.
 Access: N/A

Width minimum: 44 1/2 in.
 Door Opening: Lateral

LUMINESCENCE FRAMELESS SLIDING DOOR 56 1/2-59 X 70 1/2 IN. 6 MM

No	Door Opening	Glass Pattern	Finish	Pkg	Approx. weight	List Price
138993-900-084	Lateral	Clear (900)	Chrome (084)	5 ft ³	106 lb	\$ 960
138993-900-305	Lateral	Clear (900)	Brushed Nickel (305)	5 ft ³	106 lb	\$ 987
138993-900-173	Lateral	Clear (900)	Dark Bronze (173)	5 ft ³	106 lb	\$ 1,004

Radius: N/A
 Standard Height: 70 1/2 - 72 in.
 Adjustment: For out-of-plumb walls

Width maximum: 59 in.
 Access: N/A

Width minimum: 56 1/2 in.
 Door Opening: Lateral

Luminescence - Tub Door

LUMINESCENCE DOORS

- Elegant 1/4 in. (6 mm) clear tempered glass with minimalist hardware
- Fits showers with 55 1/2 in. wall clearance, glass extends to 57 1/2 in.
- Ball bearing roller system - door closes gently & quietly
- Door is reversible - provides a right or left opening

Regional Availability

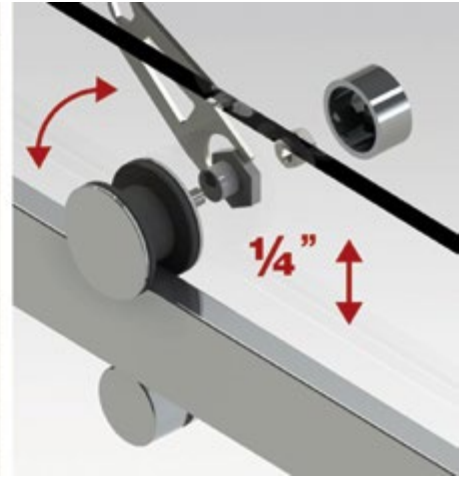

LUMINESCENCE FRAMELESS SLIDING DOOR 56 1/2-59 X 55 1/2 IN. 6 MM

No	Door Opening	Glass Pattern	Finish	Pkg	Approx. weight	List Price
138994-900-084	Lateral	Clear (900)	Chrome (084)	4.02 ft ³	86 lb	\$ 910
138994-900-305	Lateral	Clear (900)	Brushed Nickel (305)	4.02 ft ³	86 lb	\$ 938
138994-900-173	Lateral	Clear (900)	Dark Bronze (173)	4.02 ft ³	86 lb	\$ 954

Radius: N/A
 Standard Height: 55 1/2 - 57 1/2 in.
 Adjustment: For out of plumb walls

Width maximum: 59 in.
 Access: N/A

Width minimum: 56 1/2 in.
 Door Opening: Lateral

MAAX[®]
 DIGITAL

Introducing the new
MAAX Partner Portal

The power is in your hands!

This new tool gives you access to all the order information you need, when you need it:

- Order history • Order status • Delivery dates • Ship dates • Shipment tracking

www.maax.com/partnerportal



Reveal Doors



Reveal shower door in dark bronze frame finish



Recommended MAA^X Shower Bases for Reveal Doors

REVEAL DOORS

Dimension	Doors (W) ¹ ▶	Reveal 71 and 75 doors								Return Panels Reveal 71 and Reveal 75					
		32½ - 35½		38 - 41		44 - 47		56 - 59		29⅞		31⅞		33⅞	
		71"	75"	71"	75"	71"	75"	71"	75"	71"	75"	71"	75"	71"	75"
Base (L x W) ¹ ▼	Model No	136676	136678	136679	136682	136671	136880	136672	136881	136673	136700	136674	136701	136675	136702
36" Alcove	B3Square/ Round 3636	420000/ 410000	X	X											
	Square Base 36	105051/ 101430	X	X											
36" Corner	B3Square/ Round 3636	420000/ 410000	X	X										X	X
	Square Base 36	105054/ 101432	X	X										X	X
42" Alcove	Rectangular base 4234	105535/ 102001			X	X									
	Rectangular base 4236	105061/ 105718			X	X									
	Square Base 42	105052/ 105714			X	X									
48" Alcove	B3Square/ Round 4832	420001/ 410001					X	X							
	B3Square/ Round 4834	420002/ 410002					X	X							
	B3Square/ Round 4836	420003/ 410003					X	X							
	B3X base 4836	420030					X	X							
	Rectangular base 4832	105060/ 101433					X	X							
	Rectangular base 4834	105534/ 102002					X	X							
	Rectangular base 4836	105059/ 105717					X	X							
48" Corner	B3Square/ Round 4832	420001/ 410001					X	X		X	X				
	B3Square/ Round 4834	420002/ 410002					X	X				X	X		
	B3Square/ Round 4836	420003/ 410003					X	X						X	X
	B3X base 4836	420032/ 420033					X	X						X	X
48" Alcove deep	B3Square/ Round 4836	420003/ 4100z03	X	X											

Fit may vary depending on wall thickness (acrylic or tile). Validate the height of the product if installing with acrylic walls.

1. L: Length, W: Width, H: Height

Recommended MAAX Shower Bases for Reveal Doors

REVEAL DOORS

Dimension	Doors (W) ¹ ▶ Doors (H) ¹ ▶	Reveal 71 and 75 doors								Return Panels Reveal 71 and Reveal 75						
		32½ - 35½		38 - 41		44 - 47		56 - 59		29⅞		31⅞		33⅞		
		71"	75"	71"	75"	71"	75"	71"	75"	71"	75"	71"	75"	71"	75"	
Base (L x W) ¹ ▼	Model No	136676	136678	136679	136682	136671	136880	136672	136881	136673	136700	136674	136701	136675	136702	
60" Alcove	B3Square/ Round 6030	420004/ 410004							X	X						
	B3Square/ Round 6032	420005/ 410005							X	X						
	B3Square/ Round 6036	420006/ 410006							X	X						
	B3X base 6036	420031							X	X						
	Rectangular base 6030	105055/ 105707							X	X						
	Rectangular base 6032	105056/ 105706							X	X						
	Rectangular base 6034	105533/ 102003							X	X						
	Rectangular base 6036	105666							X	X						
		105057/ 105664							X	X						
Rectangular base 6042	105058/ 105716							X	X							
60" Corner	B3Square/ Round 6032	420005/ 410005							X	X	X	X				
	B3Square/ Round 6036	420006/ 410006							X	X				X	X	
	B3X base 6036	420032/ 420033							X	X				X	X	
	Rectangular base 6036	105594							X	X				X	X	
60" Alcove deep	B3Square/ Round 6036	420006/ 410006	X	X												

Fit may vary depending on wall thickness (acrylic or tile). Validate the height of the product if installing with acrylic walls.

1. L: Length, W: Width, H: Height

Reveal 71

- 71 1/2 in. high luxury clear tempered glass, 5/16 in. (8 mm)
- Unique MAAX Patented hinge - allows for 3 in. lateral adjustment
- Reversible door for left or right opening
- For installation on acrylic walls, ceramic and U tile
- For a corner shower: combine a return panel and an alcove door
- Available in 3 finishes: Chrome, Brushed Nickel and Dark Bronze

Regional Availability



REVEAL 71 PIVOT DOOR 32 1/2-35 1/2 X 71 1/2 IN. 8 MM

No	Door Opening	Glass Pattern	Finish	Pkg	Approx. weight	List Price
136676-900-084	Left or right	Clear (900)	Chrome (084)	5.2 ft ³	100 lb	\$ 938
136676-900-305	Left or right	Clear (900)	Brushed Nickel (305)	5.2 ft ³	100 lb	\$ 961
136676-900-173	Left or right	Clear (900)	Dark Bronze (173)	5.2 ft ³	100 lb	\$ 1,029

Radius: N/A
 Standard Height: 71 1/2 in.
 Adjustment: For out of plumb walls (approx. 3/4 in. (19mm))

Width maximum: 35 1/2 in.
 Access: 25 in.

Width minimum: 32 1/2 in.
 Door Opening: Left or right

REVEAL 71 PIVOT DOOR 38-41 X 71 1/2 IN. 8 MM

No	Door Opening	Glass Pattern	Finish	Pkg	Approx. weight	List Price
136679-900-084	Left or right	Clear (900)	Chrome (084)	5.2 ft ³	104 lb	\$ 993
136679-900-305	Left or right	Clear (900)	Brushed Nickel (305)	5.2 ft ³	104 lb	\$ 1,014
136679-900-173	Left or right	Clear (900)	Dark Bronze (173)	5.2 ft ³	104 lb	\$ 1,087

Radius: N/A
 Standard Height: 71 1/2 in.
 Adjustment: For out of plumb walls (approx. 3/4 in. (19mm))

Width maximum: 41 in.
 Access: 25 in.

Width minimum: 38 in.
 Door Opening: Left or right

REVEAL 71 PIVOT DOOR 41 1/2-44 1/2 X 71 1/2 IN. 8 MM

No	Door Opening	Glass Pattern	Finish	Pkg	Approx. weight	List Price
136677-900-084	Left or right	Clear (900)	Chrome (084)	5.2 ft ³	111 lb	\$ 1,020
136677-900-305	Left or right	Clear (900)	Brushed Nickel (305)	5.2 ft ³	111 lb	\$ 1,045
136677-900-173	Left or right	Clear (900)	Dark Bronze (173)	5.2 ft ³	111 lb	\$ 1,119

Radius: N/A
 Standard Height: 71 1/2 in.
 Adjustment: For out of plumb walls (approx. 3/4 in. (19mm))

Width maximum: 44 1/2 in.
 Access: 25 in.

Width minimum: 41 1/2 in.
 Door Opening: Left or right

Reveal 71 (cont'd)

REVEAL 71 PIVOT DOOR 44-47 X 71 1/2 IN. 8 MM

No	Door Opening	Glass Pattern	Finish	Pkg	Approx. weight	List Price
136671-900-084	Left or right	Clear (900)	Chrome (084)	5.2 ft ³	115 lb	\$ 1,048
136671-900-305	Left or right	Clear (900)	Brushed Nickel (305)	5.2 ft ³	115 lb	\$ 1,071
136671-900-173	Left or right	Clear (900)	Dark Bronze (173)	5.2 ft ³	115 lb	\$ 1,150

Radius: N/A

Standard Height: 71 1/2 in.

Adjustment: For out of plumb walls (approx 3/4 in. (19mm))

Width maximum: 47 in.

Access: 25 in.

Width minimum: 44 in.

Door Opening: Left or right

REVEAL 71 PIVOT DOOR 51 1/2-54 1/2 X 71 1/2 IN. 8 MM

No	Door Opening	Glass Pattern	Finish	Pkg	Approx. weight	List Price
136883-900-084	Left or right	Clear (900)	Chrome (084)	5.2 ft ³	132 lb	\$ 1,048
136883-900-305	Left or right	Clear (900)	Brushed Nickel (305)	5.2 ft ³	132 lb	\$ 1,071
136883-900-173	Left or right	Clear (900)	Dark Bronze (173)	5.2 ft ³	132 lb	\$ 1,150

Radius: N/A

Standard Height: 71 1/2 in.

Adjustment: For out of plumb walls (approx. 3/4 in. (19mm))

Width maximum: 54 1/2 in.

Access: 25 in.

Width minimum: 51 1/2 in.

Door Opening: Left or right

REVEAL 71 PIVOT DOOR 56-59 X 71 1/2 IN. 8 MM

No	Door Opening	Glass Pattern	Finish	Pkg	Approx. weight	List Price
136672-900-084	Left or right	Clear (900)	Chrome (084)	5.2 ft ³	140 lb	\$ 1,159
136672-900-305	Left or right	Clear (900)	Brushed Nickel (305)	5.2 ft ³	140 lb	\$ 1,187
136672-900-173	Left or right	Clear (900)	Dark Bronze (173)	5.2 ft ³	140 lb	\$ 1,271

Radius: N/A

Standard Height: 71 1/2 in.

Adjustment: For out of plumb walls (approx. 3/4 in. (19mm))

Width maximum: 59 in.

Access: 25 in.

Width minimum: 56 in.

Door Opening: Left or right

REVEAL DOORS

Reveal 71 Return Panels

- Glass panels 5/16 in. (8 mm)
- 32 in., 34 in. and 36 in. wide x 71 1/2 in. high panels
- Add 1 return panel to a Reveal 71 alcove door for a corner unit
- Available in 3 finishes: Chrome, Brushed Nickel and Dark Bronze

Regional Availability



REVEAL DOORS



REVEAL 71 RETURN PANEL FOR 32 IN. BASE

No	Door Opening	Glass Pattern	Finish	Pkg	Approx. weight	List Price
136673-900-084	N/A	Clear (900)	Chrome (084)	5.3 ft ³	70 lb	\$ 563
136673-900-305	N/A	Clear (900)	Brushed Nickel (305)	5.3 ft ³	70 lb	\$ 578
136673-900-173	N/A	Clear (900)	Dark Bronze (173)	5.3 ft ³	70 lb	\$ 620

Radius: N/A
 Standard Height: 71 1/2 in.
 Adjustment: For out of plumb walls (approx 3/4 in. (19 mm))

Width maximum: 29 7/8 in.
 Access: N/A

Width minimum: 28 3/4 in.
 Door Opening:

REVEAL 71 RETURN PANEL FOR 34 IN. BASE

No	Door Opening	Glass Pattern	Finish	Pkg	Approx. weight	List Price
136674-900-084	N/A	Clear (900)	Chrome (084)	5.3 ft ³	75 lb	\$ 579
136674-900-305	N/A	Clear (900)	Brushed Nickel (305)	5.3 ft ³	75 lb	\$ 594
136674-900-173	N/A	Clear (900)	Dark Bronze (173)	5.3 ft ³	75 lb	\$ 636

Radius: N/A
 Standard Height: 71 1/2 in.
 Adjustment: For out of plumb walls (approx 3/4 in. (19 mm))

Width maximum: 31 7/8 in.
 Access: N/A

Width minimum: 30 3/4 in.
 Door Opening:

REVEAL 71 RETURN PANEL FOR 36 IN. BASE

No	Door Opening	Glass Pattern	Finish	Pkg	Approx. weight	List Price
136675-900-084	N/A	Clear (900)	Chrome (084)	5.3 ft ³	80 lb	\$ 596
136675-900-305	N/A	Clear (900)	Brushed Nickel (305)	5.3 ft ³	80 lb	\$ 609
136675-900-173	N/A	Clear (900)	Dark Bronze (173)	5.3 ft ³	80 lb	\$ 651

Radius: N/A
 Standard Height: 71 1/2 in.
 Adjustment: For out of plumb walls (approx 3/4 in. (19mm))

Width maximum: 33 7/8 in.
 Access: N/A

Width minimum: 32 3/4 in.
 Door Opening:

Reveal 75

- 75 in. high luxury clear tempered glass, 5/16 in. (8 mm)
- Unique MAAX Patented hinge - allows for 3 in. lateral adjustment
- Reversible door for left or right opening
- For installation on ceramic walls and U tile
- For a corner shower: combine a return panel and an alcove door

Regional Availability



REVEAL DOORS

REVEAL 75 PIVOT DOOR 32 1/2-35 1/2 X 75 IN. 8 MM

No	Door Opening	Glass Pattern	Finish	Pkg	Approx. weight	List Price
136678-900-084	Left or right	Clear (900)	Chrome (084)	6.7 ft ³	101 lb	\$ 1,048

Radius: N/A
 Standard Height: 75 in.
 Adjustment: For out of plumb walls (approx. 3/4 in. (19mm))

Width maximum: 35 1/2 in.
 Access: 25 in.

Width minimum: 32 1/2 in.
 Door Opening: Left or right

REVEAL 75 PIVOT DOOR 38-41 X 75 IN. 8 MM

No	Door Opening	Glass Pattern	Finish	Pkg	Approx. weight	List Price
136682-900-084	Left or right	Clear (900)	Chrome (084)	6.7 ft ³	112 lb	\$ 1,103

Radius: N/A
 Standard Height: 75 in.
 Adjustment: For out of plumb walls (approx. 3/4 in. (19mm))

Width maximum: 41 in.
 Access: 25 in.

Width minimum: 38 in.
 Door Opening: Left or right

REVEAL 75 PIVOT DOOR 44-47 X 75 IN. 8 MM

No	Door Opening	Glass Pattern	Finish	Pkg	Approx. weight	List Price
136880-900-084	Left or right	Clear (900)	Chrome (084)	6.7 ft ³	115 lb	\$ 1,159

Radius: N/A
 Standard Height: 75 in.
 Adjustment: For out of plumb walls (approx. 3/4 in. (19mm))

Width maximum: 47 in.
 Access: 25 in.

Width minimum: 44 in.
 Door Opening: Left or right

REVEAL 75 PIVOT DOOR 56-59 X 75 IN. 8 MM

No	Door Opening	Glass Pattern	Finish	Pkg	Approx. weight	List Price
136881-900-084	Left or right	Clear (900)	Chrome (084)	6.7 ft ³	140 lb	\$ 1,269

Radius: N/A
 Standard Height: 75 in.
 Adjustment: For out of plumb walls (approx. 3/4 in. (19mm))

Width maximum: 59 in.
 Access: 25 in.

Width minimum: 56 in.
 Door Opening: Left or right

Reveal 75 Return Panels

- Glass panels 5/16 in. (8 mm)
- 32 in., 34 in. and 36 in. wide x 75 in. high panels
- Add 1 return panel to a Reveal 75 alcove door for a corner unit

Regional Availability



REVEAL 75 RETURN PANEL FOR 32 IN. BASE

No	Door Opening	Glass Pattern	Finish	Pkg	Approx. weight	List Price
136700-900-084	N/A	Clear (900)	Chrome (084)	5.3 ft ³	72 lb	\$ 587

Radius: N/A
 Standard Height: 75 in.
 Adjustment: For out of plumb walls (approx 3/4 in. (19 mm))

Width maximum: 29 7/8 in.
 Access: N/A

Width minimum: 28 3/4 in.
 Door Opening:

REVEAL 75 RETURN PANEL FOR 34 IN. BASE

No	Door Opening	Glass Pattern	Finish	Pkg	Approx. weight	List Price
136701-900-084	N/A	Clear (900)	Chrome (084)	5.3 ft ³	78 lb	\$ 607

Radius: N/A
 Standard Height: 75 in.
 Adjustment: For out of plumb walls (approx 3/4 in. (19 mm))

Width maximum: 31 7/8 in.
 Access: N/A

Width minimum: 30 3/4 in.
 Door Opening:

REVEAL 75 RETURN PANEL FOR 36 IN. BASE

No	Door Opening	Glass Pattern	Finish	Pkg	Approx. weight	List Price
136702-900-084	N/A	Clear (900)	Chrome (084)	5.3 ft ³	82 lb	\$ 623

Radius: N/A
 Standard Height: 75 in.
 Adjustment: For out of plumb walls (approx 3/4 in. (19 mm))

Width maximum: 33 7/8 in.
 Access: N/A

Width minimum: 32 3/4 in.
 Door Opening:

Frameless Doors



Madono shower door

Recommended MAAX Shower Bases for Frameless Doors

		Kleara doors								
Dimension	Doors (W x H) ¹	27½ - 29½ X 69	29½ - 31½ X 69	31½ - 33½ X 69	33½ - 36½ X 69	36½ - 39½ X 69	39½ - 42½ X 69	45.5 - 48½ X 69	54½ - 57½ X 69	57½ - 60½ X 69
Base (L x W) ¹	Model No	136447	136448	136449	136450	136451	136452	136454	136457	136458
32" Alcove	Square Base 32	105050/ 105663	X	X						
	B3Square/ Round 3636	420000/ 410000			X	X				
36" Alcove	Square Base 36	105051/ 101430			X	X				
	Rectangular base 4234	105535/ 102001					X	X		
42" Alcove	Rectangular base 4236	105061/ 105718					X	X		
	Square Base 42	105052/ 105714					X	X		
	B3Square/ Round 4832	420001/ 410001							X	
48" Alcove	B3Square/ Round 4834	420002/ 410002							X	
	B3Square/ Round 4836	420003/ 410003							X	
	B3X base 4836	420030							X	
	Rectangular base 4832	105060/ 101433							X	
	Rectangular base 4834	105534/ 102002							X	
	Rectangular base 4836	105059/ 105717							X	
48" Alcove deep	B3Square/ Round 4832	420001/ 410001		X						
	B3Square/ Round 4834	420002/ 410002			X					
	B3Square/ Round 4836	420003/ 410003				X				

Fit may vary depending on wall thickness (acrylic or tile). Validate the height of the product if installing with acrylic walls.

1. L: Length, W: Width, H: Height

Recommended MAA^X Shower Bases for Frameless Doors

FRAMELESS SHOWER DOORS

		Kleara doors (cont'd)									
Dimension	Doors (W x H) ¹	27 ½ - 29 ½ X 69	29 ½ - 31 ½ X 69	31 ½ - 33 ½ X 69	33 ½ - 36 ½ X 69	36 ½ - 39 ½ X 69	39 ½ - 42 ½ X 69	45 ½ - 48 ½ X 69	54 ½ - 57 ½ X 69	57 ½ - 60 ½ X 69	
Base (L x W) ¹	Model No	136447	136448	136449	136450	136451	136452	136454	136457	136458	
60" Alcove	B3Square/ Round 6030	420004/ 410004							X	X	
	B3Square/ Round 6032	420005/ 410005							X	X	
	B3Square/ Round 6036	420006/ 410006							X	X	
	B3X base 6036	420031							X	X	
	Rectangular base 6030	105055/ 105707							X	X	
	Rectangular base 6032	105056/ 105706							X	X	
	Rectangular base 6034	105533/ 102003							X	X	
	Rectangular base 6036	105666								X	X
		105057/ 105664								X	X
Rectangular base 6042	105058/ 105716								X	X	
60" Alcove deep	B3Square/ Round 6030	420004/ 410004	X								
	B3Square/ Round 6032	420005/ 410005		X							
	B3Square/ Round 6036	420006/ 410006				X					

		Madono doors	
Dimension	Doors (W x H) ¹	28 ½ - 30 ½ X 67	31 ½ - 33 ½ X 67
Base (L x W) ¹	Model No	105416	105417
32" Alcove	Square Base 32	105050/ 105663	X
36" Alcove	Square Base 36	105051/ 101430	X
48" Alcove deep	B3Square/ Round 4832	420001/ 410001	X
	B3Square/ Round 4834	420002/ 410002	X
60" Alcove deep	B3Square/ Round 6032	420005/ 410005	X

Fit may vary depending on wall thickness (acrylic or tile). Validate the height of the product if installing with acrylic walls.

1. L: Length, W: Width, H: Height

Recommended MAA^X Shower Bases for Frameless Doors

		Radia Neo-angle doors			
Dimension		Doors (W x H) ¹	36 x 36 x 70	38 x 38 x 70	40 x 40 x 70
Base (L x W) ¹		Model No	137440	137441	137442
36" Corner	Neo-angle 36	105042/ 101422	X		
38" Corner	Neo-angle 38	105043/ 101423		X	
40" Corner	Neo-angle 40	105044/ 101424			X

		Radia Neo-round doors			
Dimension		Doors (W x H) ¹	32 x 32 x 70	36 x 36 x 70	40 x 40 x 70
Base (L x W) ¹		Model No	137443	137444	137445
32" Corner	Neo-Round 32	105046/ 101426	X		
36" Corner	Neo-Round 36	105047/ 101427		X	
40" Corner	Neo-Round 40	105048/ 101428			X

		Radia Round doors		
Dimension		Doors (W x H) ¹	36 x 36 x 70	
Base (L x W) ¹		Model No	137446	
36" Corner	Round Base 36	105049/ 101429	X	

		Radia Square doors		
Dimension		Doors (W x H) ¹	32 x 32 x 70	36 x 36 x 70
Base (L x W) ¹		Model No	137447	137448
32" Corner	Square Base 32	105053/ 101431	X	
36" Corner	B3Square/ Round 3636	420000/ 410001		X
	Square Base 36	105054/ 101422		X

Fit may vary depending on wall thickness (acrylic or tile). Validate the height of the product if installing with acrylic walls.

1. L: Length, W: Width, H: Height

Kleara 1-Panel

- 1-panel, 1/4 in. (6 mm), frameless pivot door for alcove shower
- Exclusive pivot hinge 2 in. (51 mm) lateral adjustment
- Clear seals keep the door watertight
- Clear sealing joint around the door, preventing water leak

Regional Availability



FRAMELESS SHOWER DOORS

KLEARA 1-PANEL 23 1/2-25 1/2 X 69 IN. 6 MM

No	Door Opening	Glass Pattern	Finish	Pkg	Approx. weight	List Price
136445-900-084	Left or right	Clear (900)	Chrome (084)	2.5 ft ³	42 lb	\$ 413
136445-900-105	Left or right	Clear (900)	Nickel (105)	2.5 ft ³	42 lb	\$ 436
136445-981-084	Left or right	Mistelite (981)	Chrome (084)	2.5 ft ³	42 lb	\$ 443
136445-981-105	Left or right	Mistelite (981)	Nickel (105)	2.5 ft ³	42 lb	\$ 466

Radius: N/A
Standard Height: 69 in.
Adjustment: 2 in.

Width maximum: 25 1/2 in.
Access: 20 in.

Width minimum: 23 1/2 in.
Door Opening: Left or right

KLEARA 1-PANEL 25 1/2-27 1/2 X 69 IN. 6 MM

No	Door Opening	Glass Pattern	Finish	Pkg	Approx. weight	List Price
136446-900-084	Left or right	Clear (900)	Chrome (084)	3 ft ³	45 lb	\$ 436
136446-900-105	Left or right	Clear (900)	Nickel (105)	3 ft ³	45 lb	\$ 460
136446-981-084	Left or right	Mistelite (981)	Chrome (084)	3 ft ³	45 lb	\$ 477
136446-981-105	Left or right	Mistelite (981)	Nickel (105)	3 ft ³	45 lb	\$ 501

Radius: N/A
Standard Height: 69 in.

Width maximum: 27 1/2 in.
Access: 22 in.

Width minimum: 25 1/2 in.
Door Opening: Left or right

Kleara 1-Panel (cont'd)

Adjustment: 2 in.

KLEARA 1-PANEL 27 1/2-29 1/2 X 69 IN. 6 MM

No	Door Opening	Glass Pattern	Finish	Pkg	Approx. weight	List Price
136447-900-084	Left or right	Clear (900)	Chrome (084)	3 ft ³	48 lb	\$ 460
136447-900-105	Left or right	Clear (900)	Nickel (105)	3 ft ³	48 lb	\$ 483
136447-981-084	Left or right	Mistelite (981)	Chrome (084)	3 ft ³	48 lb	\$ 489
136447-981-105	Left or right	Mistelite (981)	Nickel (105)	3 ft ³	48 lb	\$ 513

Radius: N/A
Standard Height: 69 in.
Adjustment: 2 in.

Width maximum: 29 1/2 in.
Access: 24 in.

Width minimum: 27 1/2 in.
Door Opening: Left or right

KLEARA 1-PANEL 29 1/2-31 1/2 X 69 IN. 6 MM

No	Door Opening	Glass Pattern	Finish	Pkg	Approx. weight	List Price
136448-900-084	Left or right	Clear (900)	Chrome (084)	3 ft ³	51 lb	\$ 483
136448-900-105	Left or right	Clear (900)	Nickel (105)	3 ft ³	51 lb	\$ 508
136448-981-084	Left or right	Mistelite (981)	Chrome (084)	3 ft ³	51 lb	\$ 513
136448-981-105	Left or right	Mistelite (981)	Nickel (105)	3 ft ³	51 lb	\$ 536

Radius: N/A
Standard Height: 69 in.
Adjustment: 2 in.

Width maximum: 31 1/2 in.
Access: 26 in.

Width minimum: 29 1/2 in.
Door Opening: Left or right

KLEARA 1-PANEL 31 1/2-33 1/2 X 69 IN. 6 MM

No	Door Opening	Glass Pattern	Finish	Pkg	Approx. weight	List Price
136449-900-084	Left or right	Clear (900)	Chrome (084)	3 ft ³	54 lb	\$ 508
136449-900-105	Left or right	Clear (900)	Nickel (105)	3 ft ³	54 lb	\$ 531
136449-981-084	Left or right	Mistelite (981)	Chrome (084)	3 ft ³	54 lb	\$ 536
136449-981-105	Left or right	Mistelite (981)	Nickel (105)	3 ft ³	54 lb	\$ 561

Radius: N/A
Standard Height: 69 in.
Adjustment: 2 in.

Width maximum: 33 1/2 in.
Access: 28 in.

Width minimum: 31 1/2 in.
Door Opening: Left or right

Kleara 2-Panel

- 2-panel, 1/4 in. (6 mm), frameless pivot door for alcove shower
- Exclusive pivot hinge 3 in. (76 mm) lateral adjustment
- Clear sealing joint around the door, preventing water leak
- Central pressure closing
- Full-length aluminium magnetic profile

Regional Availability



FRAMELESS SHOWER DOORS

KLEARA 2-PANEL 33 1/2-36 1/2 X 69 IN. 6 MM

No	Door Opening	Glass Pattern	Finish	Pkg	Approx. weight	List Price
136450-900-084	Central	Clear (900)	Chrome (084)	2 ft ³	65 lb	\$ 620
136450-900-105	Central	Clear (900)	Nickel (105)	2 ft ³	65 lb	\$ 648
136450-981-084	Central	Mistelite (981)	Chrome (084)	2 ft ³	65 lb	\$ 648
136450-981-105	Central	Mistelite (981)	Nickel (105)	2 ft ³	65 lb	\$ 707

Radius: N/A
Standard Height: 69 in.
Adjustment: 3 in.

Width maximum: 36 1/2 in.
Access: 28 1/2 in.

Width minimum: 33 1/2 in.
Door Opening: Central

KLEARA 2-PANEL 36 1/2-39 1/2 X 69 IN. 6 MM

No	Door Opening	Glass Pattern	Finish	Pkg	Approx. weight	List Price
136451-900-084	Central	Clear (900)	Chrome (084)	2 ft ³	70 lb	\$ 648
136451-900-105	Central	Clear (900)	Nickel (105)	2 ft ³	70 lb	\$ 671
136451-981-084	Central	Mistelite (981)	Chrome (084)	2 ft ³	70 lb	\$ 679
136451-981-105	Central	Mistelite (981)	Nickel (105)	2 ft ³	70 lb	\$ 702

Radius: N/A
Standard Height: 69 in.
Adjustment: 3 in.

Width maximum: 39 1/2 in.
Access: 31 1/2 in.

Width minimum: 36 1/2 in.
Door Opening: Central

Kleara 2-Panel

FRAMELESS SHOWER DOORS

KLEARA 2-PANEL 39 1/2-42 1/2 X 69 IN. 6 MM

No	Door Opening	Glass Pattern	Finish	Pkg	Approx. weight	List Price
136452-900-084	Central	Clear (900)	Chrome (084)	2 ft ³	74 lb	\$ 679
136452-900-105	Central	Clear (900)	Nickel (105)	2 ft ³	74 lb	\$ 702
136452-981-084	Central	Mistelite (981)	Chrome (084)	2 ft ³	74 lb	\$ 707
136452-981-105	Central	Mistelite (981)	Nickel (105)	2 ft ³	74 lb	\$ 725

Radius: N/A
Standard Height: 69 in.
Adjustment: 3 in.

Width maximum: 42 1/2 in.
Access: 34 1/2 in.

Width minimum: 39 1/2 in.
Door Opening: Central

KLEARA 2-PANEL 42 1/2-45 1/2 X 69 IN. 6 MM

No	Door Opening	Glass Pattern	Finish	Pkg	Approx. weight	List Price
136453-900-084	Central	Clear (900)	Chrome (084)	2 ft ³	79 lb	\$ 738
136453-900-105	Central	Clear (900)	Nickel (105)	2 ft ³	79 lb	\$ 761
136453-981-084	Central	Mistelite (981)	Chrome (084)	2 ft ³	79 lb	\$ 766
136453-981-105	Central	Mistelite (981)	Nickel (105)	2 ft ³	79 lb	\$ 784

Radius: N/A
Standard Height: 69 in.
Adjustment: 3 in.

Width maximum: 45 1/2 in.
Access: 37 1/2 in.

Width minimum: 42 1/2 in.
Door Opening: Central

KLEARA 2-PANEL 45 1/2-48 1/2 X 69 IN. 6 MM

No	Door Opening	Glass Pattern	Finish	Pkg	Approx. weight	List Price
136454-900-084	Central	Clear (900)	Chrome (084)	2 ft ³	83 lb	\$ 766
136454-900-105	Central	Clear (900)	Nickel (105)	2 ft ³	83 lb	\$ 789
136454-981-084	Central	Mistelite (981)	Chrome (084)	2 ft ³	83 lb	\$ 796
136454-981-105	Central	Mistelite (981)	Nickel (105)	2 ft ³	83 lb	\$ 819

Radius: N/A
Standard Height: 69 in.
Adjustment: 3 in.

Width maximum: 48 1/2 in.
Access: 40 1/2 in.

Width minimum: 45 1/2 in.
Door Opening: Central

KLEARA 2-PANEL 48 1/2-51 1/2 X 69 IN. 6 MM

No	Door Opening	Glass Pattern	Finish	Pkg	Approx. weight	List Price
136455-900-084	Central	Clear (900)	Chrome (084)	3 ft ³	88 lb	\$ 796
136455-900-105	Central	Clear (900)	Nickel (105)	3 ft ³	88 lb	\$ 819
136455-981-084	Central	Mistelite (981)	Chrome (084)	3 ft ³	88 lb	\$ 825
136455-981-105	Central	Mistelite (981)	Nickel (105)	3 ft ³	88 lb	\$ 848

Radius: N/A
Standard Height: 69 in.
Adjustment: 3 in.

Width maximum: 51 1/2 in.
Access: 43 1/2 in.

Width minimum: 48 1/2 in.
Door Opening: Central

Kleara 2-Panel (cont'd)

KLEARA 2-PANEL 51 1/2-54 1/2 X 69 IN. 6 MM

No	Door Opening	Glass Pattern	Finish	Pkg	Approx. weight	List Price
136456-900-084	Central	Clear (900)	Chrome (084)	3 ft ³	92 lb	\$ 825
136456-900-105	Central	Clear (900)	Nickel (105)	3 ft ³	92 lb	\$ 848
136456-981-084	Central	Mistelite (981)	Chrome (084)	3 ft ³	92 lb	\$ 855
136456-981-105	Central	Mistelite (981)	Nickel (105)	3 ft ³	92 lb	\$ 878

Radius: N/A
Standard Height: 69 in.
Adjustment: 3 in.

Width maximum: 54 1/2 in.
Access: 46 1/2 in.

Width minimum: 51 1/2 in.
Door Opening: Central

KLEARA 2-PANEL 54 1/2-57 1/2 X 69 IN. 6 MM

No	Door Opening	Glass Pattern	Finish	Pkg	Approx. weight	List Price
136457-900-084	Central	Clear (900)	Chrome (084)	3 ft ³	96 lb	\$ 855
136457-900-105	Central	Clear (900)	Nickel (105)	3 ft ³	96 lb	\$ 885
136457-981-084	Central	Mistelite (981)	Chrome (084)	3 ft ³	96 lb	\$ 914
136457-981-105	Central	Mistelite (981)	Nickel (105)	3 ft ³	96 lb	\$ 908

Radius: N/A
Standard Height: 69 in.
Adjustment: 3 in.

Width maximum: 57 1/2 in.
Access: 49 1/2 in.

Width minimum: 54 1/2 in.
Door Opening: Central

KLEARA 2-PANEL 57 1/2-60 1/2 X 69 IN. 6 MM

No	Door Opening	Glass Pattern	Finish	Pkg	Approx. weight	List Price
136458-900-084	Central	Clear (900)	Chrome (084)	3 ft ³	101 lb	\$ 885
136458-900-105	Central	Clear (900)	Nickel (105)	3 ft ³	101 lb	\$ 908
136458-981-084	Central	Mistelite (981)	Chrome (084)	3 ft ³	101 lb	\$ 914
136458-981-105	Central	Mistelite (981)	Nickel (105)	3 ft ³	101 lb	\$ 937

Radius: N/A
Standard Height: 69 in.
Adjustment: 3 in.

Width maximum: 60 1/2 in.
Access: 52 1/2 in.

Width minimum: 57 1/2 in.
Door Opening: Central

FRAMELESS SHOWER DOORS

Madono

- 1-panel 1/4 in. (6 mm) frameless pivot door for alcove shower
- Chrome knob for a clean simple look
- Reversible door for left or right opening
- No header

Regional Availability



FRAMELESS SHOWER DOORS



MADONO 1-PANEL 24 1/2-26 1/2 X 67 IN. 6 MM

No	Door Opening	Glass Pattern	Finish	Pkg	Approx. weight	List Price
105420-900-084	Left or right	Clear (900)	Chrome (084)	3.62 ft ³	30 lb	\$ 395

Radius: N/A
Standard Height: 67 in.
Adjustment: For out of plumb walls

Width maximum: 26 1/2 in.
Access: N/A

Width minimum: 24 1/2 in.
Door Opening: Left or right

MADONO 1-PANEL 28 1/2-30 1/2 X 67 IN. 6 MM

No	Door Opening	Glass Pattern	Finish	Pkg	Approx. weight	List Price
105416-900-084	Left or right	Clear (900)	Chrome (084)	3.62 ft ³	32 lb	\$ 426

Radius: N/A
Standard Height: 67 in.
Adjustment: For out of plumb walls

Width maximum: 30 1/2 in.
Access: N/A

Width minimum: 28 1/2 in.
Door Opening: Left or right

MADONO 1-PANEL 31 1/2-33 1/2 X 67 IN. 6 MM

No	Door Opening	Glass Pattern	Finish	Pkg	Approx. weight	List Price
105417-900-084	Left or right	Clear (900)	Chrome (084)	3.99 ft ³	34 lb	\$ 455

Radius: N/A
Standard Height: 67 in.
Adjustment: For out of plumb walls

Width maximum: 33 1/2 in.
Access: N/A

Width minimum: 31 1/2 in.
Door Opening: Left or right

MADONO 1-PANEL 34 1/2-36 1/2 X 67 IN. 6 MM

No	Door Opening	Glass Pattern	Finish	Pkg	Approx. weight	List Price
105418-900-084	Left or right	Clear (900)	Chrome (084)	3.99 ft ³	36 lb	\$ 486

Radius: N/A
Standard Height: 67 in.
Adjustment: For out of plumb walls

Width maximum: 36 1/2 in.
Access: N/A

Width minimum: 34 1/2 in.
Door Opening: Left or right

Radia Neo-Angle

AVAILABLE SUMMER 2017

- 6 mm tempered glass with Lotus glass protection
- Magnetic and aluminium extrusion for a better watertight closure and provides panel rigidity
- Easy to detach the bottom wheels to clean the track (Clip and Push)
- Panels are pre-assembled with hardware and side jambs

Regional Availability



FRAMELESS SHOWER DOORS

RADIA NEO-ANGLE 36 X 36 X 71 1/2 IN. 6 MM

No	Door Opening	Glass Pattern	Finish	Pkg	Approx. weight	List Price
137440-900-084	Central	Clear (900)	Chrome (084)	5.54 ft ³	108 lb	\$ 770
137440-900-305	Central	Clear (900)	Brushed Nickel (305)	5.54 ft ³	108 lb	\$ 828
137440-981-084	Central	Mistelite (981)	Chrome (084)	5.54 ft ³	108 lb	\$ 809
137440-981-305	Central	Mistelite (981)	Brushed Nickel (305)	5.54 ft ³	108 lb	\$ 870

Radius: N/A
Standard Height: 71 1/2 in.
Adjustment: 3/4 in.

Width maximum: 36 in.
Access: 19 5/8 in.

Width minimum: 36 in.
Door Opening: Central

RADIA NEO-ANGLE 38 X 38 X 71 1/2 IN. 6 MM

No	Door Opening	Glass Pattern	Finish	Pkg	Approx. weight	List Price
137441-900-084	Central	Clear (900)	Chrome (084)	5.62 ft ³	114 lb	\$ 800
137441-900-305	Central	Clear (900)	Brushed Nickel (305)	5.62 ft ³	114 lb	\$ 860
137441-981-084	Central	Mistelite (981)	Chrome (084)	5.62 ft ³	114 lb	\$ 840
137441-981-305	Central	Mistelite (981)	Brushed Nickel (305)	5.62 ft ³	114 lb	\$ 903

Radius: N/A
Standard Height: 71 1/2 in.

Width maximum: 38 in.
Access: 21 1/4 in.

Width minimum: 38 in.
Door Opening: Central

Radia Neo-Angle (cont'd)

Adjustment: 3/4 in.

RADIA NEO-ANGLE 40 X 40 X 71 1/2 IN. 6 MM

No	Door Opening	Glass Pattern	Finish	Pkg	Approx. weight	List Price
137442-900-084	Central	Clear (900)	Chrome (084)	5.97 ft ³	121 lb	\$ 830
137442-900-305	Central	Clear (900)	Brushed Nickel (305)	5.97 ft ³	121 lb	\$ 893
137442-981-084	Central	Mistelite (981)	Chrome (084)	5.97 ft ³	121 lb	\$ 872
137442-981-305	Central	Mistelite (981)	Brushed Nickel (305)	5.97 ft ³	121 lb	\$ 938

Radius: N/A
Standard Height: 71 1/2 in.
Adjustment: 3/4 in.

Width maximum: 40 in.
Access: 22 5/8 in.

Width minimum: 40 in.
Door Opening: Central

FRAMELESS SHOWER DOORS

CONSULT, PRINT AND SHARE EASILY!

PDF versions of **all our up to date product technical drawings** are available on MAAX's website.

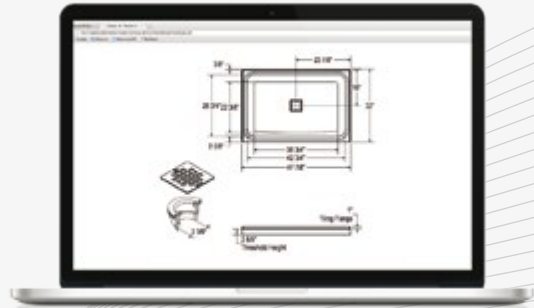

www.maax.com

Radia Neo-Round

AVAILABLE SUMMER 2017

- 6 mm tempered glass with Lotus glass protection
- Magnetic and PVC extrusion for a better watertight closure
- Easy to detach the bottom wheels to clean the track (Clip and Push)
- Panels are pre-assembled with hardware and side jambs
- 3/4 in. of out of plumb adjustment for those not so perfect walls

Regional Availability



FRAMELESS SHOWER DOORS

RADIA NEO-ROUND 32 X 32 X 71 1/2 IN. 6 MM

No	Door Opening	Glass Pattern	Finish	Pkg	Approx. weight	List Price
137443-900-084	Central	Clear (900)	Chrome (084)	5.3 ft ³	99 lb	\$ 790
137443-900-305	Central	Clear (900)	Brushed Nickel (305)	5.3 ft ³	99 lb	\$ 850
137443-981-084	Central	Mistelite (981)	Chrome (084)	5.3 ft ³	99 lb	\$ 830
137443-981-305	Central	Mistelite (981)	Brushed Nickel (305)	5.3 ft ³	99 lb	\$ 893

Radius: N/A
Standard Height: 71 1/2 in.
Adjustment: 3/4 in.

Width maximum: 32 in.
Access: 17 1/2 in.

Width minimum: 32 in.
Door Opening: Central

RADIA NEO-ROUND 36 X 36 X 71 1/2 IN. 6 MM

No	Door Opening	Glass Pattern	Finish	Pkg	Approx. weight	List Price
137444-900-084	Central	Clear (900)	Chrome (084)	6 ft ³	105 lb	\$ 820
137444-900-305	Central	Clear (900)	Brushed Nickel (305)	6 ft ³	105 lb	\$ 882
137444-981-084	Central	Mistelite (981)	Chrome (084)	6 ft ³	105 lb	\$ 861
137444-981-305	Central	Mistelite (981)	Brushed Nickel (305)	6 ft ³	105 lb	\$ 927

Radius: N/A
Standard Height: 71 1/2 in.
Adjustment: 3/4 in.

Width maximum: 36 in.
Access: 20 1/2 in.

Width minimum: 36 in.
Door Opening: Central

Radia Neo-Round (cont'd)

RADIA NEO-ROUND 40 X 40 X 71 1/2 IN. 6 MM

No	Door Opening	Glass Pattern	Finish	Pkg	Approx. weight	List Price
137445-900-084	Central	Clear (900)	Chrome (084)	6.25 ft ³	112 lb	\$ 850
137445-900-305	Central	Clear (900)	Brushed Nickel (305)	6.25 ft ³	112 lb	\$ 914
137445-981-084	Central	Mistelite (981)	Chrome (084)	6.25 ft ³	112 lb	\$ 893
137445-981-305	Central	Mistelite (981)	Brushed Nickel (305)	6.25 ft ³	112 lb	\$ 960

Radius: N/A
 Standard Height: 71 1/2 in.
 Adjustment: 3/4 in.

Width maximum: 40 in.
 Access: 22 5/8 in.

Width minimum: 40 in.
 Door Opening: Central

Radia Round

AVAILABLE SUMMER 2017

- 6 mm tempered glass with Lotus glass protection
- Magnetic and PVC extrusion for a better watertight closure
- Easy to detach the bottom wheels to clean the track (Clip and Push)
- Product is reversible for a opening on the left and on the right
- 3/4 in. of out of plumb adjustment for those not so perfect walls

Regional Availability



FRAMELESS SHOWER DOORS

RADIA ROUND 36 X 36 X 71 1/2 IN. 6 MM

No	Door Opening	Glass Pattern	Finish	Pkg	Approx. weight	List Price
137446-900-084	Lateral	Clear (900)	Chrome (084)	8.48 ft ³	108 lb	\$ 950
137446-900-305	Lateral	Clear (900)	Brushed Nickel (305)	8.48 ft ³	108 lb	\$ 1,022

Radius: N/A
 Standard Height: 71 1/2 in.
 Adjustment: 3/4 in.

Width maximum: 36 in.
 Access: 21 5/8 in.

Width minimum: 36 in.
 Door Opening: Lateral

Radia Square

AVAILABLE SUMMER 2017

- 6 mm tempered glass with Lotus glass protection
- Magnetic and aluminum extrusion for a better watertight closure and provides panel rigidity
- Easy to detach the bottom wheels to clean the track (Clip and Push)
- Panels are pre-assembled with hardware and side jambs

Regional Availability



FRAMELESS SHOWER DOORS



RADIA SQUARE 32 X 32 X 71 1/2 IN. 6 MM

No	Door Opening	Glass Pattern	Finish	Pkg	Approx. weight	List Price
137447-900-084	Central	Clear (900)	Chrome (084)	4.73 ft ³	101 lb	\$ 850
137447-900-305	Central	Clear (900)	Brushed Nickel (305)	4.73 ft ³	101 lb	\$ 914
137447-981-084	Central	Mistelite (981)	Chrome (084)	4.73 ft ³	101 lb	\$ 893
137447-981-305	Central	Mistelite (981)	Brushed Nickel (305)	4.73 ft ³	101 lb	\$ 960

Radius: N/A
Standard Height: 71 1/2 in.
Adjustment: 3/4 in.

Width maximum: 32 in.
Access: 15 3/8 in.

Width minimum: 32 in.
Door Opening: Central

RADIA SQUARE 36 X 36 X 71 1/2 IN. 6 MM

No	Door Opening	Glass Pattern	Finish	Pkg	Approx. weight	List Price
137448-900-084	Central	Clear (900)	Chrome (084)	5.26 ft ³	108 lb	\$ 880
137448-900-305	Central	Clear (900)	Brushed Nickel (305)	5.26 ft ³	108 lb	\$ 946
137448-981-084	Central	Mistelite (981)	Chrome (084)	5.26 ft ³	108 lb	\$ 924
137448-981-305	Central	Mistelite (981)	Brushed Nickel (305)	5.26 ft ³	108 lb	\$ 994

Radius: N/A
Standard Height: 71 1/2 in.
Adjustment: 3/4 in.

Width maximum: 36 in.
Access: 18 5/16 in.

Width minimum: 36 in.
Door Opening: Central



Utile Factory Sleek—Smoke

IT'S NOT TILE. IT'S Utile.

utilebymaax.com

Utile

by MAAX



B3

Shower Bases

Multiple Configurations
and Dimensions



Builder Doors

Polar shower door

Recommended MAA^X Shower Bases for Builder Doors

		Pivlok doors				
Dimension		Doors (W x H) ¹ ▶	27 - 28¾ X 64½	29 - 30¾ X 64½	31 - 32¾ X 64½	33 - 34¾ X 64½
Base (L x W) ▼		Model No	136635	136645	136655	136656
32" Alcove	Square Base 32	105050/ 105663		X		
	B3Square/ Round 3636	420000/ 410000				X
36" Alcove	Square Base 36	105051/ 101430				X
	B3Square/ Round 4832	420001/ 410001		X		
48" Alcove deep	B3Square/ Round 4834	420002/ 410002			X	
	B3Square/ Round 4836	420003/ 410003				X
	B3Square/ Round 6030	420004/ 410004	X			
60" Alcove deep	B3Square/ Round 6032	420005/ 410005		X		
	B3Square/ Round 6036	420006/ 410006				X

		Pivlok Deluxe doors		
Dimension		Doors (W x H) ¹ ▶	28 - 32½ X 64½	32½ - 37 X 64½
Base (L x W) ▼		Model No	136425	136435
32" Alcove	Square Base 32	105050/ 105663	X	
	B3Square/ Round 3636	420000/ 410000		X
36" Alcove	Square Base 36	105051/ 101430		X
	B3Square/ Round 4832	420001/ 410001	X	
48" Alcove deep	B3Square/ Round 4834	420002/ 410002	X	
	B3Square/ Round 4836	420003/ 410003		X
	B3Square/ Round 6030	420004/ 410004	X	
60" Alcove deep	B3Square/ Round 6032	420005/ 410005	X	
	B3Square/ Round 6036	420006/ 410006		X

Fit may vary depending on wall thickness (acrylic or tile). Validate the height of the product if installing with acrylic walls.

1. L: Length, W: Width, H: Height

Recommended MAAX Shower Bases for Builder Doors

BUILDER DOORS

		Polar doors		
Dimension	Doors (W x H) ¹ ▶	42 - 47 ½ X 68	54 - 59 X 68	
Base (L x W) ¹ ▼	Model No	105413	105412	
48" Alcove	B3Square/ Round 4832	420001/ 410001	X	
	B3Square/ Round 4834	420002/ 410002	X	
	B3Square/ Round 4836	420003/ 410003	X	
	B3X base 4836	420030	X	
	Rectangular base 4832	105060/ 101433	X	
	Rectangular base 4834	105534/ 102002	X	
	Rectangular base 4836	105059/ 105717	X	
60" Alcove	B3Square/ Round 6030	420004/ 410004		X
	B3Square/ Round 6032	420005/ 410005		X
	B3Square/ Round 6036	420006/ 410006		X
	B3X base 6036	420031		X
	Rectangular base 6030	105055/ 105707		X
	Rectangular base 6032	105056/ 105706		X
	Rectangular base 6034	105533/ 102003		X
	Rectangular base 6036	105666		X
		105057/ 105664		X
	Rectangular base 6042	105058/ 105716		X

- Tub doors fit on the majority of MAAX tubs. Please refer to the tubs section for more information.
- Fit may vary depending on wall thickness (acrylic or tile). Validate the height of the product if installing with acrylic walls.

1. L: Length, W: Width, H: Height

Recommended MAA^X Shower Bases for Builder Doors

BUILDER DOORS

		Triple Plus doors			
Dimension	Doors (W x H) ¹ ▶	48 X 66	48 X 69	58 X 66	59½ X 71
Base (L x W) ¹ ▼	Model No	138297	138291	138315	138311
48" Alcove	B3Square/ Round 4832	420001/ 410001	X	X	
	B3Square/ Round 4834	420002/ 410002	X	X	
	B3Square/ Round 4836	420003/ 410003	X	X	
	B3X base 4836	420030	X	X	
60" Alcove	B3Square/ Round 6030	420004/ 410004			X
	B3Square/ Round 6032	420005/ 410005			X
	B3Square/ Round 6036	420006/ 410006			X
	Rectangular base 6030	105055/ 105707			X
	B3X base 6036	420031			X
	Rectangular base 6032	105056/ 105706			X
	Rectangular base 6034	105533/ 102003			X
	Rectangular base 6036	105666			X
105057				X	
105664				X	
Rectangular base 6042	105058/ 105716			X	

		Silhouette Plus and Silhouette Neo-Angle doors				
Dimension	Doors (W x H) ¹ ▶	36 X 36 X 70	38 X 38 X 70	38 X 38/40 X 40 X 70	36 X 36 X 70	38 X 38 X 70
Base (L x W) ¹ ▼	Model No	137720	137710	137730	137904	137901
36" Corner	Neo-angle 36	105042/ 101422	X		X	
38" Corner	Neo-angle 38	105043/ 101423	X	X		X
40" Corner	Neo-angle 40	105044/ 101424		X		

- Tub doors fit on the majority of MAA^X tubs. Please refer to the tubs section for more information.
- Fit may vary depending on wall thickness (acrylic or tile). Validate the height of the product if installing with acrylic walls.

1. L: Length, W: Width, H: Height

Decor Plus - Shower Doors

- 2-panel sliding door for shower
- Bottom door guide provides smooth opening
- Additional lateral jamb seal assure watertight closing
- Sure-Glide bottom track prevents residue build-up for ease
- Resistant ball bearing rollers for smooth handling of panels

Regional Availability



BUILDER DOORS

DECOR PLUS 2-PANEL 43 X 69 IN.

No	Door Opening	Glass Pattern	Finish	Pkg	Approx. weight	List Price
135276-970-084	Lateral	Raindrop tempered glass (970)	Chrome (084)	3.24 ft ³	60 lb	\$ 483

Radius: N/A
Standard Height: 69 in.
Adjustment: for out of plumb walls

Width maximum: 43 in.
Access: N/A

Width minimum: 43 in.
Door Opening: Lateral

DECOR PLUS 2-PANEL 44 X 66 IN.

No	Door Opening	Glass Pattern	Finish	Pkg	Approx. weight	List Price
135280-970-084	Lateral	Raindrop tempered glass (970)	Chrome (084)	2.86 ft ³	54 lb	\$ 553

Radius: N/A
Standard Height: 66 in.
Adjustment: for out of plumb walls

Width maximum: 44 in.
Access: N/A

Width minimum: 44 in.
Door Opening: Lateral

DECOR PLUS 2-PANEL 44 X 69 IN.

No	Door Opening	Glass Pattern	Finish	Pkg	Approx. weight	List Price
135277-970-084	Lateral	Raindrop tempered glass (970)	Chrome (084)	3.24 ft ³	60 lb	\$ 483

Radius: N/A
Standard Height: 69 in.
Adjustment: for out of plumb walls

Width maximum: 44 in.
Access: N/A

Width minimum: 44 in.
Door Opening: Lateral

Decor Plus - Tub Doors

- 2-panel sliding door for tub and tub shower
- Bottom door guide provides smooth opening
- Additional lateral jamb seal assure watertight closing
- Sure-Glide bottom track prevents residue build-up for ease of cleaning
- Resistant ball bearing rollers for smooth handling of panels

Regional Availability



BUILDER DOORS

DECOR PLUS 2-PANEL 56 3/4 X 56 IN.

No	Door Opening	Glass Pattern	Finish	Pkg	Approx. weight	List Price
136302-970-084	Lateral	Raindrop tempered glass (970)	Chrome (084)	2.44 ft ³	54 lb	\$ 391

Radius: N/A
Standard Height: 56 in.
Adjustment: For out of plumb walls

Width maximum: 56 3/4 in.
Access: N/A

Width minimum: 56 3/4 in.
Door Opening: Lateral

DECOR PLUS 2-PANEL 59 1/2 X 56 IN.

No	Door Opening	Glass Pattern	Finish	Pkg	Approx. weight	List Price
136300-900-084	Lateral	Clear (900)	Chrome (084)	3.32 ft ³	55 lb	\$ 415
136300-970-084	Lateral	Raindrop tempered glass (970)	Chrome (084)	3.32 ft ³	55 lb	\$ 415

Radius: N/A
Standard Height: 56 in.
Adjustment: For out of plumb walls

Width maximum: 59 1/2 in.
Access: N/A

Width minimum: 59 1/2 in.
Door Opening: Lateral

Mika

- 2-panel framed sliding door for alcove tub or tub showers
- EZ Kleen track system
- Aluminum single towel bar

Regional Availability



BUILDER DOORS

MIKA 2-PANEL 54 - 59 1/2 X 55 IN.

No	Door Opening	Glass Pattern	Finish	Pkg	Approx. weight	List Price
105409-965-170	Lateral	Hammer (965)	Mat Silver	3.32 ft ³	45 lb	\$ 273

Radius: N/A
 Standard Height: 55 1/2 in.
 Adjustment: for out-of-square walls

Width maximum: 59 1/2 in.
 Access: N/A

Width minimum: 54 in.
 Door Opening: Lateral

PivoloK

- 1-panel framed pivot door for alcove shower
- Full-length magnetic catch allows the door to close tightly
- Reversible door for left or right installation
- Integrated channel redirects water toward the inside of the shower
- Full-length aluminum pull reinforces door and doubles as a handle

Regional Availability



BUILDER DOORS



PIVOLOK 1-PANEL 19-20 3/4 X 64 1/2 IN.

No	Door Opening	Glass Pattern	Finish	Pkg	Approx. weight	List Price
136605-900-084	Left or right	Clear (900)	Chrome (084)	2.25 ft ³	25 lb	\$ 327
136605-970-084	Left or right	Raindrop tempered glass (970)	Chrome (084)	2.25 ft ³	25 lb	\$ 327

Radius: N/A
Standard Height: 64 1/2 in.
Adjustment: 1 3/4 in.

Width maximum: 20 3/4 in.
Access: N/A

Width minimum: 19 in.
Door Opening: Left or right

PIVOLOK 1-PANEL 21-22 3/4 X 64 1/2 IN.

No	Door Opening	Glass Pattern	Finish	Pkg	Approx. weight	List Price
136615-900-084	Left or right	Clear (900)	Chrome (084)	2.41 ft ³	28 lb	\$ 327
136615-970-084	Left or right	Raindrop tempered glass (970)	Chrome (084)	2.41 ft ³	28 lb	\$ 327

Radius: N/A
Standard Height: 64 1/2 in.
Adjustment: 1 3/4 in.

Width maximum: 22 3/4 in.
Access: N/A

Width minimum: 21 in.
Door Opening: Left or right

PIVOLOK 1-PANEL 23-24 3/4 X 64 1/2 IN.

No	Door Opening	Glass Pattern	Finish	Pkg	Approx. weight	List Price
136625-900-084	Left or right	Clear (900)	Chrome (084)	2.69 ft ³	30 lb	\$ 333
136625-970-084	Left or right	Raindrop tempered glass (970)	Chrome (084)	2.69 ft ³	30 lb	\$ 333

Radius: N/A
Standard Height: 64 1/2 in.
Adjustment: 1 3/4 in.

Width maximum: 24 3/4 in.
Access: N/A

Width minimum: 23 in.
Door Opening: Left or right

PivoloK (cont'd)

PIVOLOK 1-PANEL 25-26 3/4 X 64 1/2 IN.

No	Door Opening	Glass Pattern	Finish	Pkg	Approx. weight	List Price
136626-900-084	Left or right	Clear (900)	Chrome (084)	2.53 ft ³	31 lb	\$ 333
136626-970-084	Left or right	Raindrop tempered glass (970)	Chrome (084)	2.53 ft ³	31 lb	\$ 333

Radius: N/A
Standard Height: 64 1/2 in.
Adjustment: 1 3/4 in.

Width maximum: 26 3/4 in.
Access: N/A

Width minimum: 25 in.
Door Opening: Left or right

PIVOLOK 1-PANEL 27-28 3/4 X 64 1/2 IN.

No	Door Opening	Glass Pattern	Finish	Pkg	Approx. weight	List Price
136635-900-084	Left or right	Clear (900)	Chrome (084)	2.97 ft ³	32 lb	\$ 347
136635-970-084	Left or right	Raindrop tempered glass (970)	Chrome (084)	2.97 ft ³	32 lb	\$ 347

Radius: N/A
Standard Height: 64 1/2 in.
Adjustment: 1 3/4 in.

Width maximum: 28 3/4 in.
Access: N/A

Width minimum: 27 in.
Door Opening: Left or right

PIVOLOK 1-PANEL 29-30 3/4 X 64 1/2 IN.

No	Door Opening	Glass Pattern	Finish	Pkg	Approx. weight	List Price
136645-900-084	Left or right	Clear (900)	Chrome (084)	3.23 ft ³	35 lb	\$ 359
136645-970-084	Left or right	Raindrop tempered glass (970)	Chrome (084)	3.23 ft ³	35 lb	\$ 359

Radius: N/A
Standard Height: 64 1/2 in.
Adjustment: 1 3/4 in.

Width maximum: 30 3/4 in.
Access: N/A

Width minimum: 29 in.
Door Opening: Left or right

PIVOLOK 1-PANEL 31-32 3/4 X 64 1/2 IN.

No	Door Opening	Glass Pattern	Finish	Pkg	Approx. weight	List Price
136655-900-084	Left or right	Clear (900)	Chrome (084)	3.24 ft ³	37 lb	\$ 359
136655-970-084	Left or right	Raindrop tempered glass (970)	Chrome (084)	3.24 ft ³	37 lb	\$ 359

Radius: N/A
Standard Height: 64 1/2 in.
Adjustment: 1 3/4 in.

Width maximum: 32 3/4 in.
Access: N/A

Width minimum: 31 in.
Door Opening: Left or right

PIVOLOK 1-PANEL 33-34 3/4 X 64 1/2 IN.

No	Door Opening	Glass Pattern	Finish	Pkg	Approx. weight	List Price
136656-900-084	Left or right	Clear (900)	Chrome (084)	3.35 ft ³	38 lb	\$ 370
136656-970-084	Left or right	Raindrop tempered glass (970)	Chrome (084)	3.35 ft ³	38 lb	\$ 370

Radius: N/A
Standard Height: 64 1/2 in.
Adjustment: 1 3/4 in.

Width maximum: 34 3/4 in.
Access: N/A

Width minimum: 33 in.
Door Opening: Left or right

Pivolok Deluxe

- 1-panel framed pivot door for alcove shower
- Full-length magnetic catch allows the door to close tightly
- Reversible door for left or right installation
- Integrated channel redirects water toward the inside of the shower
- Fixed panel allows for 4 in. of lateral adjustment

Regional Availability



BUILDER DOORS

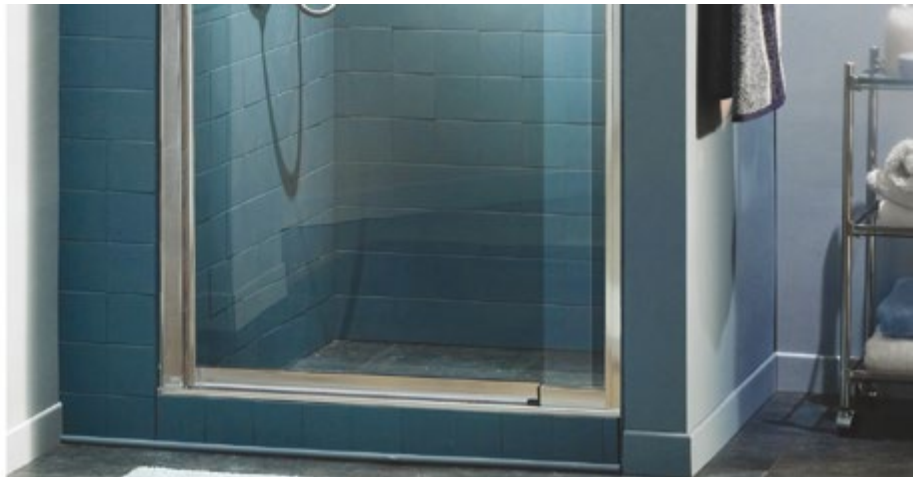

PIVOLOK DELUXE 1-PANEL 28-32 1/2 X 64 1/2 IN.

No	Door Opening	Glass Pattern	Finish	Pkg	Approx. weight	List Price
136425-965-084	Left or right	Hammer tempered glass (965)	Chrome (084)	3.26 ft ³	39 lb	\$ 434

Radius: N/A
Standard Height: 64 1/2 in.
Adjustment: 4 1/2 in.

Width maximum: 32 1/2 in.
Access: N/A

Width minimum: 28 in.
Door Opening: Left or right

PIVOLOK DELUXE 1-PANEL 32 1/2-37 X 64 1/2 IN.

No	Door Opening	Glass Pattern	Finish	Pkg	Approx. weight	List Price
136435-900-084	Left or right	Clear (900)	Chrome (084)	3.48 ft ³	43 lb	\$ 472
136435-965-084	Left or right	Hammer tempered glass (965)	Chrome (084)	3.48 ft ³	43 lb	\$ 472

Radius: N/A
Standard Height: 64 1/2 in.
Adjustment: 4 1/2 in.

Width maximum: 37 in.
Access: N/A

Width minimum: 32 1/2 in.
Door Opening: Left or right

Polar - Shower Doors

- 2-panel framed sliding door for alcove showers
- EZ Kleen track system
- Aluminum double towel bars

Regional Availability



BUILDER DOORS

POLAR 2-PANEL 42-47 1/2 X 68 IN.

No	Door Opening	Glass Pattern	Finish	Pkg	Approx. weight	List Price
105413-970-084	Lateral	Raindrop tempered glass (970)	Chrome (084)	3.62 ft ³	53 lb	\$ 539

Radius: N/A
 Standard Height: 68 in.
 Adjustment: for out of plumb walls

Width maximum: 47 1/2 in.
 Access: 49 1/2 in.

Width minimum: 42 in.
 Door Opening: Lateral

POLAR 2-PANEL 54-59 1/2 X 68 IN.

No	Door Opening	Glass Pattern	Finish	Pkg	Approx. weight	List Price
105412-970-084	Lateral	Raindrop tempered glass (970)	Chrome (084)	3.99 ft ³	68 lb	\$ 605

Radius: N/A
 Standard Height: 68 in.
 Adjustment: for out of plumb walls

Width maximum: 59 1/2 in.
 Access: 52 1/2 in.

Width minimum: 54 in.
 Door Opening: Lateral

Polar - Tub Door

- 2-panel framed sliding door for alcove tub or tub shower
- EZ Kleen track system
- Aluminum double towel bars

Regional Availability



POLAR 2-PANEL 54-59 1/2 X 57 3/8 IN.

No	Door Opening	Glass Pattern	Finish	Pkg	Approx. weight	List Price
105410-970-084	Lateral	Raindrop tempered glass (970)	Chrome (084)	3.50 ft ³	64 lb	\$ 458

Radius: N/A
 Standard Height: 57 3/8 in.
 Adjustment: For out of plumb walls

Width maximum: 59 1/2 in.
 Access: N/A

Width minimum: 54 in.
 Door Opening: Lateral

Triple Plus - Shower Doors

- 3-panel framed sliding door for tub and tub shower
- Bottom guide rail to hold the panels and provide smooth and quiet opening
- Additional lateral jamb seal assures watertight closing
- Sure-Glide bottom track prevents residue build-up for easy cleaning
- 3-panel door offers a wider opening (2/3 of wall opening)

Regional Availability



BUILDER DOORS

TRIPLE PLUS 3-PANEL 36 X 69 IN.

No	Door Opening	Glass Pattern	Finish	Pkg	Approx. weight	List Price
138299-970-084	Lateral	Raindrop tempered glass (970)	Chrome (084)	3.05 ft ³	49 lb	\$ 459

Radius: N/A
Standard Height: 69 in.
Adjustment: For out of plumb walls

Width maximum: 36 in.
Access: N/A

Width minimum: 36 in.
Door Opening: Lateral

TRIPLE PLUS 3-PANEL 40 X 66 IN.

No	Door Opening	Glass Pattern	Finish	Pkg	Approx. weight	List Price
138293-970-084	Lateral	Raindrop tempered glass (970)	Chrome (084)	2.86 ft ³	50 lb	\$ 553

Radius: N/A
Standard Height: 66 in.
Adjustment: For out of plumb walls

Width maximum: 40 in.
Access: N/A

Width minimum: 40 in.
Door Opening: Lateral

TRIPLE PLUS 3-PANEL 42 1/2 X 66 IN.

No	Door Opening	Glass Pattern	Finish	Pkg	Approx. weight	List Price
138294-970-084	Lateral	Raindrop tempered glass (970)	Chrome (084)	2.86 ft ³	53 lb	\$ 553

Radius: N/A
Standard Height: 66 in.
Adjustment: For out of plumb walls

Width maximum: 42 1/2 in.
Access: N/A

Width minimum: 42 1/2 in.
Door Opening: Lateral

TRIPLE PLUS 3-PANEL 43 X 69 IN.

No	Door Opening	Glass Pattern	Finish	Pkg	Approx. weight	List Price
138290-900-084	Lateral	Clear (900)	Chrome (084)	3.24 ft ³	72 lb	\$ 534
138290-965-084	Lateral	Hammer tempered glass (965)	Chrome (084)	3.24 ft ³	72 lb	\$ 534

Radius: N/A
Standard Height: 69 in.
Adjustment: For out of plumb walls

Width maximum: 43 in.
Access: N/A

Width minimum: 43 in.
Door Opening: Lateral

Triple Plus - Shower Doors

TRIPLE PLUS 3-PANEL 44 1/2 X 66 IN.

No	Door Opening	Glass Pattern	Finish	Pkg	Approx. weight	List Price
138296-970-084	Lateral	Raindrop tempered glass (970)	Chrome (084)	2.86 ft ³	54 lb	\$ 591

Radius: N/A
Standard Height: 66 in.
Adjustment: For out of plumb walls

Width maximum: 44 1/2 in.
Access: N/A

Width minimum: 44 1/2 in.
Door Opening: Lateral

TRIPLE PLUS 3-PANEL 48 X 66 IN.

No	Door Opening	Glass Pattern	Finish	Pkg	Approx. weight	List Price
138297-970-084	Lateral	Raindrop tempered glass (970)	Chrome (084)	2.86 ft ³	62.55 lb	\$ 630

Radius: N/A
Standard Height: 66 in.
Adjustment: For out of plumb walls

Width maximum: 48 in.
Access: N/A

Width minimum: 48 in.
Door Opening: Lateral

TRIPLE PLUS 3-PANEL 48 X 69 IN.

No	Door Opening	Glass Pattern	Finish	Pkg	Approx. weight	List Price
138291-900-084	Lateral	Clear (900)	Chrome (084)	3.23 ft ³	63 lb	\$ 540
138291-965-084	Lateral	Hammer tempered glass (965)	Chrome (084)	3.23 ft ³	63 lb	\$ 540

Radius: N/A
Standard Height: 69 in.
Adjustment: For out of plumb walls

Width maximum: 48 in.
Access: N/A

Width minimum: 48 in.
Door Opening: Lateral

TRIPLE PLUS 3-PANEL 52 1/2 X 66 IN.

No	Door Opening	Glass Pattern	Finish	Pkg	Approx. weight	List Price
138313-900-084	Lateral	Clear (900)	Chrome (084)	2.85 ft ³	65 lb	\$ 654
138313-970-084	Lateral	Raindrop tempered glass (970)	Chrome (084)	2.85 ft ³	65 lb	\$ 654

Radius: N/A
Standard Height: 66 in.
Adjustment: For out of plumb walls

Width maximum: 52 1/2 in.
Access: N/A

Width minimum: 52 1/2 in.
Door Opening: Lateral

TRIPLE PLUS 3-PANEL 54 1/2 X 66 IN.

No	Door Opening	Glass Pattern	Finish	Pkg	Approx. weight	List Price
138314-970-084	Lateral	Raindrop tempered glass (970)	Chrome (084)	2.85 ft ³	65 lb	\$ 659

Radius: N/A
Standard Height: 66 in.
Adjustment: For out of plumb walls

Width maximum: 54 1/2 in.
Access: N/A

Width minimum: 54 1/2 in.
Door Opening: Lateral

TRIPLE PLUS 3-PANEL 58 X 66 IN.

No	Door Opening	Glass Pattern	Finish	Pkg	Approx. weight	List Price
138315-970-084	Lateral	Raindrop tempered glass (970)	Chrome (084)	2.85 ft ³	65 lb	\$ 672

Radius: N/A
Standard Height: 66 in.
Adjustment: For out of plumb walls

Width maximum: 58 in.
Access: N/A

Width minimum: 58 in.
Door Opening: Lateral

Triple Plus - Shower Doors (cont'd)

TRIPLE PLUS 3-PANEL 59 1/2 X 71 IN.

No	Door Opening	Glass Pattern	Finish	Pkg	Approx. weight	List Price
138311-900-084	Lateral	Clear (900)	Chrome (084)	3.6 ft ³	78 lb	\$ 691
138311-970-084	Lateral	Raindrop tempered glass (970)	Chrome (084)	3.6 ft ³	78 lb	\$ 691

Radius: N/A

Standard Height: 71 in.

Adjustment: For out of plumb walls

Width maximum: 59 1/2 in.

Access: N/A

Width minimum: 59 1/2 in.

Door Opening: Lateral

Triple Plus - Tub Doors

- 3-panel framed sliding door for alcove tub shower
- Bottom guide rail to hold the panels and provide smooth and quiet opening
- Clear seals keep the door watertight
- Sure-glide bottom track prevents residue build-up for easy cleaning

Regional Availability



BUILDER DOORS

TRIPLE PLUS 3-PANEL 52 1/2 X 56 IN.

No	Door Opening	Glass Pattern	Finish	Pkg	Approx. weight	List Price
138301-970-084	Lateral	Raindrop tempered glass (970)	Chrome (084)	2.9 ft ³	57 lb	\$ 529

Radius: N/A
Standard Height: 56 in.
Adjustment: For out of plumb walls

Width maximum: 52 1/2 in.
Access: N/A

Width minimum:
Door Opening: Lateral

TRIPLE PLUS 3-PANEL 55 X 56 IN.

No	Door Opening	Glass Pattern	Finish	Pkg	Approx. weight	List Price
138308-970-084	Lateral	Raindrop tempered glass (970)	Chrome (084)	2.87 ft ³	59 lb	\$ 540

Radius: N/A
Standard Height: 56 in.
Adjustment: For out of plumb walls

Width maximum: 55 in.
Access: N/A

Width minimum:
Door Opening: Lateral

TRIPLE PLUS 3-PANEL 59 1/2 X 56 IN.

No	Door Opening	Glass Pattern	Finish	Pkg	Approx. weight	List Price
138400-900-084	Lateral	Clear (900)	Chrome (084)	2.9 ft ³	62 lb	\$ 566
138400-970-084	Lateral	Raindrop tempered glass (970)	Chrome (084)	2.9 ft ³	62 lb	\$ 566

Radius: N/A
Standard Height: 56 in.
Adjustment: For out of plumb walls

Width maximum: 59 1/2 in.
Access: N/A

Width minimum:
Door Opening: Lateral

Silhouette

- Neo-angle framed pivot door for corner shower
- Full-length aluminium pull adds reinforcement and doubles as a handle
- Reversible door for left or right opening
- Gutter is integrated in the inside of the door
- Adjustable pivot mechanism

Regional Availability



BUILDER DOORS

SILHOUETTE NEO-ANGLE 36 X 36 X 70 IN.

No	Door Opening	Glass Pattern	Finish	Pkg	Approx. weight	List Price
137904-900-084	Left or right	Clear (900)	Chrome (084)	5.44 ft ³	74 lb	\$ 764
137904-970-084	Left or right	Raindrop tempered glass (970)	Chrome (084)	5.44 ft ³	74 lb	\$ 764

Radius: N/A
Standard Height: 70 in.
Adjustment: 1 in.

Width maximum: 36 in.
Access: 25 1/4 in.

Width minimum: 36 in.
Door Opening: Left or right

SILHOUETTE NEO-ANGLE 38 X 38 X 70 IN.

No	Door Opening	Glass Pattern	Finish	Pkg	Approx. weight	List Price
137901-900-084	Left or right	Clear (900)	Chrome (084)	5.76 ft ³	77 lb	\$ 754
137901-970-084	Left or right	Raindrop tempered glass (970)	Chrome (084)	5.76 ft ³	77 lb	\$ 754

Radius: N/A
Standard Height: 70 in.
Adjustment: 1 in.

Width maximum: 38 in.
Access: 25 1/4 in.

Width minimum: 38 in.
Door Opening: Left or right

Silhouette Plus

- Neo-angle framed pivot door for corner shower
- Full-length aluminium pull reinforces doors and doubles as a handle
- Reversible door for left or right opening
- Gutter is integrated in the inside of the door
- 6 ways to adjust door to irregular base

Regional Availability



SILHOUETTE PLUS NEO-ANGLE 36 X 36 X 70 IN.

No	Door Opening	Glass Pattern	Finish	Pkg	Approx. weight	List Price
137700-965-084	Left or right	Hammer tempered glass (965)	Chrome (084)	5.39 ft ³	65 lb	\$ 666

Radius: N/A
Standard Height: 70 in.
Adjustment: 1 1/2 in.

Width maximum: 36 in.
Access: 24 1/2 in.

Width minimum: 36 in.
Door Opening: Left or right

SILHOUETTE PLUS NEO-ANGLE 36 X 36 X 70 IN.

No	Door Opening	Glass Pattern	Finish	Pkg	Approx. weight	List Price
137720-900-084	Left or right	Clear (900)	Chrome (084)	5.55 ft ³	72 lb	\$ 666
137720-965-084	Left or right	Hammer tempered glass (965)	Chrome (084)	5.55 ft ³	72 lb	\$ 666

Radius: N/A
Standard Height: 70 in.
Adjustment: 1 1/2 in.

Width maximum: 36 in.
Access: 25 1/2 in.

Width minimum: 36 in.
Door Opening: Left or right

SILHOUETTE PLUS NEO-ANGLE 38 X 38 X 70 IN.

No	Door Opening	Glass Pattern	Finish	Pkg	Approx. weight	List Price
137710-900-084	Left or right	Clear (900)	Chrome (084)	5.39 ft ³	73 lb	\$ 666
137710-965-084	Left or right	Hammer tempered glass (965)	Chrome (084)	5.39 ft ³	73 lb	\$ 666

Radius: N/A
Standard Height: 70 in.
Adjustment: 1 1/2 in.

Width maximum: 38 in.
Access: 24 3/4 in.

Width minimum: 38 in.
Door Opening: Left or right

Silhouette Plus (cont'd)

SILHOUETTE PLUS NEO-ANGLE 38 X 38 / 40 X 40 X 70 IN.

No	Door Opening	Glass Pattern	Finish	Pkg	Approx. weight	List Price
137730-900-084	Left or right	Clear (900)	Chrome (084)	5.42 ft ³	71 lb	\$ 680
137730-965-084	Left or right	Hammer tempered glass (965)	Chrome (084)	5.42 ft ³	71 lb	\$ 680
137730-970-084	Left or right	Raindrop tempered glass (970)	Chrome (084)	5.42 ft ³	71 lb	\$ 680

Radius: N/A
Standard Height: 70 in.
Adjustment: 1 1/2 in.

Width maximum: 40 in.
Access: 25 1/2 in.

Width minimum: 38 in.
Door Opening: Left or right

SILHOUETTE PLUS NEO-ANGLE 38 X 38 / 40 X 40 X 70 IN.

No	Door Opening	Glass Pattern	Finish	Pkg	Approx. weight	List Price
137750-965-084	Left or right	Hammer tempered glass (965)	Chrome (084)	6.19 ft ³	78 lb	\$ 691

Radius: N/A
Standard Height: 70 in.
Adjustment: 1 1/2 in.

Width maximum: 40 in.
Access: 29 1/4 in.

Width minimum: 38 in.
Door Opening: Left or right



SOFT CLOSE™
BY MAAX

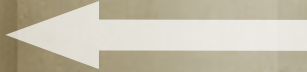

SOFT CLOSE

No More
Slamming Doors



Product Selector





Product Selector

Looking for a specific size?

Your customer dream bathroom begins with a good plan. Bathrooms may be the smallest rooms in most homes but they are among the most important to many people's everyday sense of being.



Alcove Shower Doors

Shower opening W	Products	Opening mechanism		Page
		Sliding	Pivot	
19" - <24"	Kleara 1-panel		X	p. 81
	Pivolok		X	p. 102
≥24" - <30"	Kleara 1-panel		X	p. 81
	Madono		X	p. 86
	Pivolok		X	p. 102
≥30" - <36"	Pivolok Deluxe		X	p. 104
	Kleara 1-panel		X	p. 82
	Kleara 2-panel		X	p. 83
	Madono		X	p. 86
	Pivolok		X	p. 103
	Pivolok Deluxe		X	p. 104
	Reveal 71		X	p. 72
Reveal 75		X	p. 75	
≥36" - <42"	Kameleon 6 mm (with or without SC)	X		p. 47
	Kleara 2-panel		X	p. 84
	Madono		X	p. 86
	• ModulR		X	p. 18
	Pivolok Deluxe		X	p. 104
	Reveal 71		X	p. 72
	Reveal 75		X	p. 75
Triple Plus	X		p. 107	

Alcove Shower Doors (cont'd)



Shower opening W	Products	Opening mechanism		Page
		Sliding	Pivot	
≥42" - <48"	Decor Plus	X		p. 99
	Duel	X		p. 29
	Edge Duo Shower Shield		X	p. 38
	Halo	X		p. 41
	Kameleon 6 mm (with or without SC)	X		p. 47
	Kameleon 8 mm (with or without SC)	X		p. 57
	Kleara 2-panel		X	p. 84
	Luminescence	X		p. 67
	Polar	X		p. 105
	Reveal 71		X	p. 72
	Reveal 75		X	p. 75
	Triple Plus	X		p. 107
≥48" - <56"	Kameleon 6 mm (with or without SC)	X		p. 48
	Kameleon 8 mm (with or without SC)	X		p. 57
	Kleara 2-panel		X	p. 84
	• ModulR	X	X	p. 19
	Polar	X		p. 105
	Reveal 71		X	p. 73
	Triple Plus	X		p. 108
≥56" - <60"	Duel	X		p. 29
	Halo	X		p. 41
	Kameleon 6 mm (with or without SC)	X		p. 48
	Kameleon 8 mm (with or without SC)	X		p. 57
	Kleara 2-panel		X	p. 85
	Luminescence	X		p. 67
	• ModulR	X	X	p. 22
	Polar	X		p. 105
	Reveal 71		X	p. 73
	Reveal 75		X	p. 75
Triple Plus	X		p. 108	

Discover the
MODULR products online



maaxmodulr.com



Corner Shower Doors

Shower opening	Products	Shape					Opening mechanism		Page
		Square	Rectangular	Neo-angle	Neo-round	Round	Sliding	Pivot	
32" x 32"	Radia Neo-round				X		X		p. 89
	Radia Square	X					X		p. 92
36" x 36"	Halo Round					X	X		p. 44
	• ModulR	X						X	p. 18
	Radia Neo-angle			X			X		p. 87
	Radia Neo-round				X		X		p. 89
	Radia Round					X	X		p. 91
	Radia Square	X					X		p. 92
	Reveal 71 (with return panel)	X						X	p. 74
	Reveal 75 (with return panel)	X						X	p. 76
	Silhouette Neo-angle			X				X	p. 111
	Silhouette Plus Neo-angle			X				X	p. 112
38" x 38"	Radia Neo-angle			X			X		p. 87
	Silhouette Neo-angle			X				X	p. 111
	Silhouette Plus Neo-angle			X				X	p. 112
40" x 40"	Radia Neo-angle			X			X		p. 88
	Radia Neo-round				X		X		p. 90
	Silhouette Plus Neo-angle			X				X	p. 113
48" x 32"	Duel (with return panel)		X				X		p. 31
	Halo (with return panel)		X				X		p. 42
	• ModulR		X				X	X	p. 19
	Reveal 71 (with return panel)		X					X	p. 74
	Reveal 75 (with return panel)		X					X	p. 76
48" x 34"	Halo (with return panel)		X				X		p. 42
	• ModulR		X				X	X	p. 20
	Reveal 71 (with return panel)		X					X	p. 74
	Reveal 75 (with return panel)		X					X	p. 76
48" x 36"	Duel (with return panel)		X				X		p. 31
	Halo (with return panel)		X				X		p. 42
	• ModulR		X				X	X	p. 21
	Reveal 71 (with return panel)		X					X	p. 74
	Reveal 75 (with return panel)		X					X	p. 76
60" x 30"	• ModulR		X					X	p. 22



Corner Shower Doors (cont'd)

Shower opening	Products	Shape					Opening mechanism		Page
		Square	Rectangular	Neo-angle	Neo-round	Round	Sliding	Pivot	
60" x 32"	Duel (with return panel)		X				X		p. 31
	Halo (with return panel)		X				X		p. 42
	• ModulR		X				X	X	p. 23
	Reveal 71 (with return panel)		X					X	p. 74
	Reveal 75 (with return panel)		X					X	p. 76
60" x 34"	Halo (with return panel)		X				X		p. 42
	Reveal 71 (with return panel)		X					X	p. 74
	Reveal 75 (with return panel)		X					X	p. 76
60" x 36"	Duel (with return panel)		X				X		p. 31
	Halo (with return panel)		X				X		p. 42
	• ModulR		X				X	X	p. 24
	Reveal 71 (with return panel)		X					X	p. 74
	Reveal 75 (with return panel)		X					X	p. 76



Tub Doors

Tub shower opening	Products	Installation		Opening mechanism		Page
		Alcove	Corner	Sliding	Pivot	
30" - 34"	Edge Tub Shield	X			X	p. 35
	Edge Square Tub Shield	X			X	p. 36
34" - 42"	Edge Duo Tub Shield	X			X	p. 37
51" - 54"	Kameleon 6 mm (with or without SC)	X		X		p. 53
	Triple Plus	X		X		p. 110
54" - 60"	Decor Plus	X		X		p. 100
	Duel	X		X		p. 30
	Halo Tub Door	X		X		p. 43
	Kameleon 6 mm (with or without SC)	X		X		p. 53
	Kameleon 8 mm (with or without SC)	X		X		p. 61
	Luminescence	X		X		p. 68
	Mika	X		X		p. 101
	• ModulR	X	X	X		p. 25
	Polar	X		X		p. 106
Triple Plus	X		X		p. 110	

New **MAAX** Shower Doors & Tub Doors



Radia: New corner doors

- 6 mm tempered glass with Lotus glass protection
- Easy to detach the bottom wheels to clean the track (Clip and Push)
- Clear & privacy glass (mistelite)
- 4 models to fit on most corner configurations: Neo-angle, Neo-round, Round and Square



Shower Shield

Duo Shower model with 2 panels, designed to fit on all 60 in. shower bases

Edge: Our new family of tub shields

- 6 mm and 8 mm tempered glass with Lotus glass protection
- Easy access to faucets



Tub Shields

- Three models designed to fit on most alcove tubs:
 - Tub & Square Tub: 1 pivoting panel
 - Duo Tub: 2 panels with hinges



Recommended Bases

Radia Neo-Angle 36

A close-up photograph of a hand being washed under a stream of water. The water is splashing, creating many small droplets and bubbles. A dark grey banner is overlaid on the top left of the image, containing the text "General Information" in white. The background is white.

General Information



Colors

Patterns and Finishes

Shower door glass patterns

Choose from a wide range of styles available



Clear (900)



French Door (963)

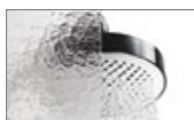

Hammer (965)



Raindrop (970)



Mistelite (981)



Linen (988)



Effervescence (989)

Shower door frame finishes

Select the frame and towel bar finish



Chrome (084)



Nickel (105)



Mat Silver (170)



Dark Bronze (172/173)



Brushed Nickel (305)

Note: Color icons for reference only. Colors may vary depending on the finish.

Terms, Conditions and Warranties

Price

Orders are accepted subject to prices in effect at the time of shipment of this price list and prices are subject to change without notice. The published pricing schedule shows suggested list prices and is subject to a trade discount as determined by MAAX Bath Inc. (hereafter "MAAX"). Orders will be invoiced at the price in effect at the time the orders are placed. Selling prices may be readjusted without notice during the year, for instance if transportation costs increase due to fuel surcharges.

Conditions of acceptance

The acceptance, shipment or delivery of any order is conditional upon approval of MAAX's credit department and upon these sales terms and conditions applying to the order and not any others, unless specifically agreed to in writing by MAAX. MAAX reserves the right to require satisfactory security for performance of the purchaser obligations prior to making shipment on any order. Any sold merchandise remains the property of MAAX until full payment is received, in accordance with applicable laws, such as the Uniform Commercial Code – Sales in the United States.

Terms of payment

General payment terms are net 30 days. A rate of 2% monthly (26.82% per annum, compounded monthly) will apply on overdue accounts. No goods will be delivered to customers not complying with our sales and payment conditions.

Taxes

All prices published are exclusive of applicable taxes.

Lost merchandise

If, upon receipt, the recipient notices that certain products are missing, he must immediately notify our customer service department. The recipient must then indicate which products are missing on the delivery slip and countersign it. The enclosed bill of lading allows you to verify shipped and received merchandise.

Shipping damage

Damage occurring in transit is the responsibility of the carrier. MAAX will not be held responsible for shipping damage. The product should be carefully examined by the user or installer at time of receipt to ensure it is damage free. If any damage is discovered, it should be noted on the freight bill, and a claim should be filed against the carrier as soon as possible. Inspection of the unit prior to installation is the responsibility of the installer or building contractor who acts on behalf of the user, or the user himself. They are responsible for ensuring that the unit is free of defect or damage. In the event of a problem, the unit must not be installed. MAAX is not responsible for failures, costs, damages or claims that could have been discovered, repaired or avoided by proper inspection and testing prior to installation.

Return Policy (other than doors)

MAAX provides a selective and conditional merchandise return program. Product may be returned to MAAX under the following conditions:

- Product is in original, new condition – not previously installed or used as display;
- Product has been in the customer's possession for less than 6 months;
- Product is still available in the most current price list (not discontinued) or has not been announced for discontinuation;
- Product is in a standard color or finish, as indicated in the most current price list;
- Any stock product may be returned. To know if a product is a stock unit, please contact the customer care department; and
- Product was received in error, does not represent what the customer ordered or has a manufacturing defect.

Products are not eligible for return to MAAX under the following conditions:

- Product has been previously installed, drilled, permanently marked, spray painted, or in any other way altered from its original condition. Product is "weathered" degraded due to storage outside or exposure to the elements resulting in discoloration;

- Product is defective due to negligent storage; or
- Product is equipped with any accessories or options.

Prior to returning merchandise a MAAX customer must complete and submit the RGA Request Form supplying general and specific information about the unit(s) for return. MAAX must then authorize and approve the return in writing by issuing an RGA number.

All products are subject to inspection prior to credit reimbursement, and MAAX reserves its right to reduce such reimbursement as follows:

- MAAX will apply a 25% restocking fee against the reimbursement credit for all returns for any reason other than manufacturing defect or MAAX error.
- A repair cost will be applied against the credit reimbursement for any repair required to bring a product back to 100% resalable condition. In these circumstances the customer will be notified.
- Any unit returned via common carrier must have the freight prepaid by the customer.
- For any product returned that does not qualify for return as specified above or does not match the RGA form, MAAX will charge a \$25 per unit handling fee. MAAX will notify customers in such instances and the customer will be requested to either take the unit back with freight prepaid and charged or notify MAAX in writing of their desire that it be scrapped.

Door Return policy

MAAX provides a selective and conditional merchandise return program. Product may be returned to MAAX under the following conditions:

- Product is in original, new condition – not previously installed or used as display;
- Product has been in the customer's possession for less than 12 months;
- Product is still available in the most current price list (not discontinued) or has not been announced for discontinuation;
- Product is in a standard color or finish, as indicated in the most current price list;
- Any stock product may be returned. To know if a product is a stock unit, please contact the customer care department; and
- Product was received in error, does not represent what the customer ordered or has a manufacturing defect.

Products are not eligible for return to MAAX under the following conditions:

- Product has been previously installed, drilled, permanently marked, spray painted, or in any other way altered from its original condition;
- Product is "weathered"; degraded due to storage outside or exposure to the elements resulting in discoloration;
- Product is defective due to negligent storage; or
- Product is equipped with any accessories or options.

Prior to returning merchandise a MAAX customer must complete and submit the RGA Request Form supplying general and specific information about the unit(s) for return.

MAAX must then authorize and approve the return in writing by issuing an RGA number.

All products are subject to inspection prior to credit reimbursement and MAAX reserves the right to reduce such reimbursement as follows:

- MAAX will apply a 25% restocking fee against the reimbursement credit for all returns for any reason other than manufacturing defect or MAAX error.
- A repair cost will be applied against the credit reimbursement for any repair required to bring a product back to 100% resalable condition. In these circumstances the customer will be notified.
- Any unit returned via common carrier must have the freight prepaid by the customer to the closest participating plant. Contact customer service to locate closest participating plant.

Terms, Conditions and Warranties

Cancellation

Orders must be cancelled within 24 hours of receipt of MAAX's confirmation. All cancellation requests must be made by fax and be confirmed by MAAX.

Design and dimensions

MAAX reserves the right to discontinue products at any time or change specifications and/or design without notice and without incurring obligation. All dimensions are approximate and subject to change without notice.

CLIENT SHALL INFORM OWNER/END-USER ABOUT THE FOLLOWING CONDITIONS AND WARRANTIES

Color variations

MAAX shall not be responsible for variations in granite color, wood grain, or color shades in the natural wood used; or for slight differences in color or texture of the material delivered in relation to the sample shown or provided to the purchaser. The purchaser may not use such differences to obtain a price discount or to cancel the order.

Maintenance

Regular disinfection provides an effective defence against various types of bacteria that can develop in the deposits building up over time in all bathtubs and showers. For daily maintenance cleaning, use a moist cloth and gentle liquid detergent. For acrylic surfaces, occasional use of a special acrylic surface cleaner such as Lumashine or Lumacream will add lustre and protect the finish.

Certain types of therapeutic products when added to bath water, or if applied non-diluted directly in the bath, may damage the unit finish. Test the product on a small inconspicuous surface prior to use.

Do not use abrasive cleaners, scrapers, metal brushes, or any items or products that could scratch or dull the surface. Mirror should be cleaned with non-ammonia based cleaner only.

Limited warranty

MAAX offers the following express limited warranties on its products. These warranties extend only to the original owner/end-user for personal household use and start from the manufacturing date of the unit. For commercial uses, additional limitations apply.

MAAX warrants **acrylic units** to be free from defects in workmanship and materials under normal use and service for a period of twenty five (25) years from the initial date of purchase by the owner/end-user, contractor or builder from an authorized dealer.

MAAX warrants **acrylic** shower kits to be free from defects in workmanship and materials under normal use and service for a period of ten (10) years from the initial date of purchase by the owner/end-user, contractor or builder from an authorized dealer.

MAAX warrants **Utile wall units** to be free of all material or workmanship defects under normal use and service for a period of ten (10) years from the initial date of purchase by the owner/end-user, contractor or builder from an authorized dealer.

MAAX warrants **fiberglass units** to be free from defects in workmanship and materials under normal use and service for a period of five (5) years from the initial date of purchase by the owner/end-user, contractor or builder from an authorized dealer.

MAAX warrants **ABS** to be free from defects in workmanship and materials under normal use and service for a period of three (3) years from the initial date of purchase by the owner/end-user, contractor or builder from an authorized dealer.

MAAX warrants **polystyrene** shower kits, tub wall kits, utility tubs and accessories to be free from defects in workmanship and materials under normal use and service for a period of one (1) year from the initial date of purchase by the owner/end-user, contractor or builder from an authorized dealer.

MAAX warrants **whirlpool motors/pumps** to be free from defects in workmanship and materials under normal use and service for a period of five (5) years from the initial date of purchase by the owner/end-user, contractor or builder from an authorized dealer.

MAAX warrants **blowers** to be free from defects in workmanship and materials

under normal use and service for a period of five (5) years from the initial date of purchase by the owner/end-user, contractor or builder from an authorized dealer.

MAAX warrants **whirlpool and air systems** (except perimeter air system check valves that have a 25-year warranty – see below) to be free from defects in workmanship and materials under normal use and service for a period of two (2) years from the initial date of purchase by the owner/end-user, contractor or builder from an authorized dealer.

MAAX warrants **perimeter air system check valves** to be free from defects in workmanship and materials under normal use and service for a period of twenty five (25) years from the initial date of purchase by the owner/end-user, contractor or builder from an authorized dealer.

MAAX warrants **shower doors** to be free from defects in workmanship and materials under normal use and service for a period of ten (10) years* from the initial date of purchase by the owner/end-user, contractor or builder from an authorized dealer. Shower door sealing materials, gaskets, and the Lotus glass protection by MAAX are not covered by this warranty.

*Mika door has a limited 1 year warranty.

MAAX warrants **grab bars** to be free from defects in workmanship and materials under normal use and service for a period of one (1) year from the initial date of purchase by the owner/end-user, contractor or builder from an authorized dealer.

MAAX warrants **ceramic cartridges** for faucets against any leaks resulting from normal use by the owner/end-user, contractor or builder for a limited lifetime period.

MAAX warrants **thermostatic polysulfone cartridges** to be free from defects in workmanship and materials under normal use and service for a lifetime warranty from the initial date of purchase by the owner/end-user, contractor or builder from an authorized dealer.

MAAX warrants **shower massage systems** to be free from defects in workmanship and materials under normal use and service for a period of five (5) years from the initial date of purchase by the owner/end-user, contractor or builder from an authorized dealer.

MAAX warrants **steam systems** to be free from defects in workmanship and materials under normal use and service for a period of five (5) years, and **steam nozzles** for two (2) years, from the initial date of purchase by the owner/end-user, contractor or builder from an authorized dealer.

MAAX warrants **Chrome, Polished Brass and Brushed Nickel faucet finishes** to be free from defects in workmanship and materials under normal use and service by the owner/end-user, contractor or builder for lifetime warranty from the initial date of purchase.

MAAX warrants **medicine cabinets** to be free from defects in workmanship and materials under normal use and service for a period of five (5) years from the initial date of purchase by the owner/end-user, contractor or builder from an authorized dealer.

MAAX warrants **storage modules** and vanities to be free from defects in workmanship and materials under normal use and service for a period of five (5) years from the initial date of purchase by the owner/end-user, contractor or builder from an authorized dealer.

MAAX warrants **glass mirrors** to be free from defects in workmanship and materials under normal use and service for a period of two (2) years from the initial date of purchase by the owner/end-user, contractor or builder from an authorized dealer.

MAAX warrants **electrical components**, including chromatherapy systems, to be free from defects in workmanship and materials under normal use and service for a period of two (2) years from the initial date of purchase by the owner/end-user, contractor or builder from an authorized dealer.

MAAX warrants the **factory treated wood parts** to be free from defects in workmanship and materials under normal use and service for a period of two (2) years from the initial date of purchase by the owner/end-user, contractor or builder from an authorized dealer.

Any product reported to the authorized dealer or to MAAX as being defective within the warranty period will be repaired or replaced (with a product of equal value) at the option of MAAX. Costs for freight associated with shipping of replacement product/parts might be charged

Terms, Conditions and Warranties

to customer. In no event will MAAX be liable for the cost of repair or replacement of any installation materials, including but not limited to, tiles, marble, etc. This warranty extends to the original owner/end-user and is not transferable to a subsequent owner.

Neither the distributor, authorized MAAX dealer nor any other person has been authorized to make any affirmation, representation or warranty other than those contained in this warranty shall not be enforceable against MAAX or any other person.

MAAX reserves the right to modify this warranty at any time, it being understood that such modification will not alter the warranty conditions applicable at the time of the sale of the products in question.

Limitations

This warranty shall not apply following incorrect operating procedures, breakage or damages caused by normal wear and tear, fault, carelessness, abuse, misuse, misapplication, improper maintenance, alteration or modification of the unit, as well as chemical or natural corrosion, accident, fire, flood, act of God or any other casualty. This warranty shall not apply to stain or malfunction caused by ferrous water, hard water or salty water.

The owner/end-user of the product covered by this warranty is entirely responsible for its proper installation and electrical wiring. This warranty is void if unit is not tested prior to final enclosure as per the installation instructions. MAAX neither installs nor supervises the installation, nor hires a contractor for this purpose, and consequently cannot be held responsible for any defect, breakage or damage caused thereby or resulting thereof, either directly or indirectly. The owner/end-user must provide access to the components of the product as described in the installation guide, so that MAAX can execute the warranty specified herein.

If such access is not available, all expenses to provide said access will be the responsibility of the owner/end-user.

This warranty does not apply to products or equipment not installed or operated in accordance with instructions supplied by MAAX and all applicable rules, regulations and legislation pertaining to such installations.

MAAX strongly recommends that its products—for example, but without limitation, shower doors and other items—be installed by professionals with experience in bathroom products. Installation of shower doors by an inexperienced person may result in glass breakage and, consequently, cause personal injury or death.

MAAX is not liable for any costs, damages or claims resulting from the purchase of products that do not fit through openings or existing structures. MAAX is not liable for any costs, damages or claims resulting from defects that could have been discovered, repaired or avoided by inspection and testing prior to installation.

MAAX is not liable for personal injuries or death to any person or for any direct, special, incidental or consequential damage, loss of use, loss of time, loss of profits, inconvenience, incidental expenses, labour or material charges, or any other costs resulting from the use of its products or pertaining to the application of the present warranty, or resulting from the removal or replacement of any product or element or part covered by this warranty.

EXCEPT AS OTHERWISE PROVIDED ABOVE, MAAX MAKES NO WARRANTIES, EXPRESS OR IMPLIED, INCLUDING WARRANTIES OF MERCHANTABILITY AND FITNESS FOR A PARTICULAR PURPOSE OR COMPLIANCE WITH ANY CODE.

In any case, MAAX cannot be liable for any amount over and above the purchase price paid for the product by the owner/end-user, contractor or builder.

All options that are not sold separately as accessories must be factory installed. Otherwise, warranty does not apply.

This warranty gives the owner/end-user specific legal rights. The owner/end-user may also have other rights which vary from one state and/or province to another.

Commercial Limitations

In addition to the above conditions and limitations, the warranty period for products installed for commercial applications or used in commercial ventures is of one (1) year from the initial date of purchase by the owner/end-user, contractor or builder from an authorized dealer. If the product is sold by MAAX as a display, MAAX standard warranty applies.

Warranty Service

In order to obtain service provided under this warranty during regular business hours, contact the dealer or distributor who sold the unit, or MAAX directly. MAAX will provide the warranty service described above when the following conditions have been met:

- (1) the failure is of the nature or type covered by the warranty;
- (2) the user has informed an authorized MAAX Agent or Warranty Service Department representative, of the nature of the problem during the warranty period;
- (3) conclusive evidence (e.g., serial number or proof of purchase) is provided to the foregoing by the user proving that the failure occurred or was discovered within the warranty period; and
- (4) an authorized independent service person or company representative has been permitted to inspect the product during regular business hours within a reasonable time after the problem was reported by the user.

MAAX's warranty obligation shall be discharged upon tender of replacement or repair. The purchaser refusal to accept the tender terminates MAAX's warranty obligation. Any product replaced or repaired during the warranty period will be covered during the remaining period of the original warranty.

MAAX products and/or components are certified by one or more of the following certification agencies: UL, IAPMO, INTERTEK (ETL) and WARNOCK HERSEY. Certain models are pending certification approval. Certification may be ended by MAAX or certification agencies without notice.



The symbol ®/R indicates a registered trademark of MAAX Bath Inc. or an affiliated company. The symbol TM indicates a trademark of MAAX Bath Inc. or an affiliated company.

© MAAX Bath Inc., 2015

MAAX[®]

Enjoy the experience

For any questions or comments, please contact info@maax.com

1-877-GET-MAAX
(1-877-438-6229)

Order processing

Eastern U.S.A.
customercare.minneapolis@maax.com

Western U.S.A.
customercare.bellingham@maax.com

Technical Services

Doors, Door enclosures, Shower Kits and Medicine Cabinets
lsav@maax.com

www.maax.com

