

HOME
REFINEMENTS

JULIEN

Exclusive distinction

PRICE LIST
USA

Sinks · Faucets · Accessories

Effective June 1st, 2017

Table of contents

Introduction

70 years strong	3
Exclusive distinction	5
Product offering	7
Resources	10
Warranty	11
Shipping costs	13

Stainless steel – 16 ga

UrbanEdge®	15
Kitchen sinks	16
Bar and Utility sinks	22
J7®	25
Kitchen sinks	26
Bar and Utility sinks	32
Classic	35
Kitchen sinks	36
Bar sinks	42
À la Carte	43
Installation type	45
Hole(s) for faucet and accessories	46
ADA	47
Divider	48
Built-in drainboard	49
Built-in drawer	50
Position of the drain(s)	51
Signature	53
Sinks	54
Countertops	55
Modules	56
Full kitchens	57
Other items	58
SmartStation	59
Kitchen sinks	60

Special collections

SocialCorner	65
Vintage	67
Classic +	69

Accessories 75

Grids	76
Colanders	79
Trays	80
Bins	81
Drying racks	82
Cutting boards	83
Drains	84
Care products and replacement parts	85

Fireclay

Fira 87

Kitchen sinks with ledge	88
Bar sinks with ledge	89
Kitchen sinks	90

Accessories 91

Grids	92
Colanders	93
Trays	94
Bins	95
Drying racks	96
Cutting boards	97
Drains	98
Care products and replacement parts	99

Faucets

Professional	102
Pull-out	106
Pull-down	110
Accessories	115

Index

Product index	117
---------------------	-----



Café Gray, New York (NY)



Vidéotron Centre, Quebec (QC)



Robert's Maine Grill, Kittery (ME)



Ericsson, Montreal (QC)

70 years strong

Julien has been perfecting the art of stainless steel for 70 years.

Established in Quebec City in 1946, the company quickly earned a solid regional reputation in stainless steel manufacturing. In the decades that followed, international clients joined the fold, calling for Julien's quality products on increasingly complex applications.

At Julien, we're dedicated to delivering impeccable products and

incomparable service, with a focus on three main sectors: residential kitchens (sinks, faucets, etc.), commercial kitchens, and industrial mass production.

Because for us, perfection has gone from an inspiring challenge to a way of being.



520 W 28th St. by Zaha Hadid, New York (NY)



Porsche Tower, Miami (FL)



280 Saint Marks, Brooklyn (NY)



One Vandam, New York (NY)

Exclusive distinction

Home Refinements by Julien takes each client's typical movements and uses them to design their key kitchen features.

Give your clients a kitchen where they can work with the utmost speed and efficiency in a comfortable, inspiring environment. Show them a world where they're in perfect synergy with their surroundings. Do it all with Julien's Home Refinements collection of over 300 standard stainless steel sinks, that can be customized with 25 options and over 200 accessories. For creative projects

that require even greater flexibility, we custom manufacture sinks, counters, and other stainless steel items to your specifications.

Since every customer has a unique personality, and every décor has its own authenticity, we offer exclusive distinction.



SmartStation sink 005404(M)



SocialCorner sink 005304







Fira sink 093319

Product offering

Stainless steel – 16 ga

Sixteen gauge stainless steel is thicker and more resistant than normal industry standards. Thanks to its antibacterial and non-corrosive properties, it is a restaurant industry staple. It just makes sense that we chose this commercial quality material to manufacture all of our stainless steel sinks. Folded, welded and polished by hand, our products offer the same performance as those of the greatest chefs. What's more, our brushed finish is a perfect match for most major brands of kitchen appliances.

Thickness chart		
16 ga		1.5 mm (0.0595")
18 ga		1.2 mm (0.0480")
20 ga		0.9 mm (0.0355")
22 ga		0.7 mm (0.0291")

Standard collections

Our standard UrbanEdge®, J7® and Classic collections all share a specific feature: each one of them contains 50 kitchen sink models, which can all be customized with our unique À la Carte options. But behind this common characteristic, each one owns its unique urban, contemporary or classic style.

À la Carte

This exclusive concept lets you personalize a sink with 25 options designed to enhance functionality in the kitchen. Simply select a kitchen sink model from one of our standard collections, modify it with one or more options, and transform any ordinary bowl into a one-of-a-kind, ultra-functional workstation. You can access our À la Carte configurator online and discover millions of possibilities at homerefinelements.ca/configurator

SmartStation

The SmartStation sink with accessory ledge lets you slide your colander, cutting board, and drying rack from side to side along two levels, giving cooks the chance to flex their creative muscles. Available in black walnut or maple, the station comes with a sturdy stainless steel grid that protects the bottom surface.

Special collections

Our SocialCorner, Vintage, and Classic+ special collections are a whole new take on kitchen sinks. With unexpected functionalities, inventive shapes, and stylish farmhouse and undermount designs, each sink is a unique piece.

Signature

Through our Signature concept, everyone can set their imagination free. We can handcraft in our workshops a wide range of custom stainless steel items that will perfectly match your customer's styles and needs. From a simple specific sink dimension to a full kitchen project, if it can be made of stainless steel, we can make it.

Fireclay

Fira

Our multifaceted fireclay sink has a reversible apron front that's flat on one side and Shaker style on the other. Add up to ten different accessories to the Fira with accessory ledge and discover a whole new way to work at the sink.



SmartStation sink 005404(M), Cutting board 210068, Colander 205325, Drying rack 215307, Grids 200929 et 200927

Product offering

Accessories

We offer a wide selection of accessories for both stainless steel and fireclay sinks. Most of them hang over the bowl, which creates additional workspace and improves efficiency in the kitchen. Chopping, thawing, draining, rinsing, presenting... it's all easier than ever.

Faucets

A good kitchen faucet must be functional, durable and elegant. All our models are designed with these three characteristics in mind and are available in three collections: professional, pull-out or pull-down. With their clean lines, our faucets are highly versatile and make a stunning statement when combined with one of our sinks.

Resources

Customer Service

Our Customer Service Department is totally committed to providing support before, during, and after purchase. If you have a question or would like to place an order, a member of our team will be happy to provide advice and assistance. Contact us Monday to Friday, 8 a.m. to 5 p.m. EST.

1 866 901-5624

customerservice@homerefinements.ca

Extranet

Whether it's to look at our inventory of products, place an order outside of business hours, or check your order history or status, we provide a user-friendly extranet. You will also find a host of valuable tools such as electronic versions of brochures and price lists.

extranet.julien.ca

Website

For more information about our products or to download their technical specifications, visit our website.

homerefinements.ca

Warranty

Generalities

Home Refinements may at its sole option, repair, replace or make appropriate adjustments to the Product or components proven to be defective in order to restore to good working condition.

In no event, even if Product or components are found to be defective, shall Home Refinements' liability exceed the price paid for the Product. Home Refinements reserves the right to inspect the installation prior to the replacement or repair of the Product or its component parts. Home Refinements may at its discretion require pictures prior to analyzing a claim. This limited warranty is null and void if the Product or components have been repaired, altered or modified other than by Home Refinements or under its supervision.

This limited warranty replaces any and all other warranty, expressed or implied, including implied warranties of merchantability or fitness for a particular purpose. Laws governing product warranties may vary from one state or province to another. This warranty is not intended to contravene to the public order and shall not be so interpreted. This limited warranty extends only to the original owner/end user in residential applications and is not transferable to any subsequent purchaser. In the event of a warranty claim, original proof of purchase (sales receipt) will be required. Shipping and handling costs (for returning the product or components for repairs or to replace product or components) are not covered under this limited warranty. Also excluded from this limited warranty is any labor, workmanship or other costs incurred in connection with the Product or components removal, repairs, replacement, adjustment or installation and any incidental or consequential damages.

ATTENTION > Warranty will be null and void for any damage resulting from installation not respecting the instructions and Home Refinements will not be held responsible for any costs incurred. In the event of a limited warranty claim, original proof of purchase will be required – save original sales receipt.

Stainless steel sinks

Home Refinements offers a limited LIFETIME warranty on the fixed components of its stainless steel sinks, ensuring them against defects of material and workmanship. This warranty is limited to defects or damages resulting from a normal residential use. Home Refinements will not be held responsible for defects or damages caused by improper installation.

This warranty does not cover the following points:

- Surface corrosion (chemical or natural)
- Scuffs or scratches
- Misuse, abnormal, negligent or abusive use
- Dents, deformations caused by the impact of any object
- Common signs of wear and tear
- Improper installation, care and/or maintenance
- Commercial use
- Environmental factors causing damages
- Shipping or freight damages

Fireclay sinks

Home Refinements offers a limited 1-YEAR warranty following the purchase date against manufacturing defects and a limited 10-YEARS warranty following the purchase date against fading/staining on its fireclay sinks. This warranty is limited to defects or damages resulting from a normal residential use. Home Refinements will not be held responsible for defects or damages caused by improper installation.

ATTENTION > Due to manufacturing process, a fireclay sink is subject to dimensional variations of $\pm 3/16''$. No cut out template is provided, we recommend cutting the countertop only after measuring the sink. A custom cabinet with reinforced support is required for installing a fireclay sink.

(Continued on the next page)

Warranty

Fireclay sinks (continued)

This warranty does not cover the following points:

- Misuse, abnormal, negligent or abusive use
- Scratches, chips or dents (reported following installation) – Please inspect sink carefully prior to installation
- Use of abrasives and/or chemicals (such as undiluted bleach)
- Common signs of wear and tear
- Improper installation, care and/or maintenance
- Commercial use
- Environmental factors causing damages
- Shipping or freight damage

Accessories for sinks and faucets

Home Refinements offers a limited 1-YEAR warranty following the purchase date for all mobile parts, options and accessories against defects of material and workmanship. This warranty is limited to defects or damages resulting from a normal residential use. Home Refinements will not be held responsible for defects or damages caused by improper installation.

This warranty does not cover the following points:

- Surface corrosion (chemical or natural)
- Scuffs or scratches
- Misuse, abnormal, negligent or abusive use
- Dents, deformations caused by the impact of any object
- Common signs of wear and tear
- Improper installation, care and/or maintenance
- Commercial use
- Environmental factors causing damages
- Shipping or freight damage

Faucets

Home Refinements offers a limited 1-YEAR warranty on its faucets following the purchase date against manufacturing defects. A limited LIFETIME warranty is offered on the ceramic cartridge as well as for flexible hoses. This warranty is limited to defects or damages resulting from a normal residential use. Home Refinements will not be held responsible for defects or damages caused by improper installation.

This warranty does not cover the following points:

- Misuse, abnormal, negligent or abusive use
- Dents, deformations caused by the impact of any object
- Use of chemicals that alter the aspect of the faucet
- Common signs of wear and tear (reported after installation) – Please inspect the faucet carefully before installation
- Improper installation, care and/or maintenance
- Commercial use
- Environmental factors causing damages
- Shipping or freight damage

If you believe you have a warranty claim or for more information on the warranty of our products, please contact our customer service.

Customer service

1 866 901-5624
customerservice@homerefinements.ca

Shipping costs

Most of our products are shipped via standard small parcel service, unless indicated otherwise on the purchase order. If you want to receive your order faster or if the delivery address is located outside the continental United States or Canada, please contact our Customer Service to check shipping charges.

1 866 901-5624

customerservice@homerefinements.ca

Standard shipping service – Continental United States and Canada

Stainless steel sinks

\$ 40 / sink

UrbanEdge®
J7®
Classic
SocialCorner
Vintage
Classic+

Fireclay sinks

\$ 60 / sink

Fira

Accessories for sinks and faucets⁽¹⁾

\$ 20 / shipment (3 items max.)

Drains
Grids
Cutting boards
Colanders
Trays
Bins
Drying racks
Soap dispensers
Air activated switch buttons

Faucets⁽¹⁾

\$ 30 / shipment (3 items max.)

Professional
Pull-out
Pull-down

Care products and replacement parts

\$ 10 / shipment (3 items max.)

SmartStation and À la Carte sinks, Signature items

Shipping charges vary. Please contact our customer service

¹ When accessories or faucets are shipped with a sink, no additional shipping charges apply. However, if they must be shipped later than the sink, shipping charges will apply.

URBANEDGE®



URBANEDGE®

Urban Style

These square cornered sinks are designed to look right at home in a pared down, minimalist décor. The clean, precise lines help maximize available bowl space. The kitchen sinks in this collection can be configured with the À la Carte options.

Features

Handcrafted in Canada

Commercial quality stainless steel - 16 ga thickness

Corrosion resistant material - 304 series (18/10)

Environmentally friendly product, 100% recyclable

Elegant no. 4 brushed finish that matches the appliances

Highly efficient sound deadening pads

Practical flat sink bottom and straight bowl sides that maximize available space in the bowl

Stylish and functional bowl bottom grooves that facilitate water drainage

Rear 3½" drain placement -
For bar sinks, please refer to the specsheets for drain sizes and placement

Mounting hardware and cutout template included

Certifications: ASME A112.19.3, CSA B45.0, CSA B45.4

Kitchen sinks

Undermount installation

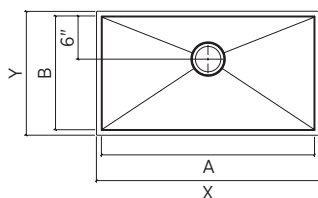
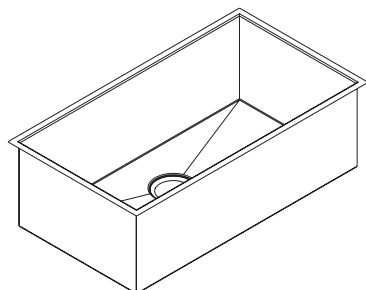

Cabinet 15"	Cabinet 18"	Cabinet 21"	Cabinet 24"
Overall (X × Y) 10½" × 17½"	Overall (X × Y) 13½" × 17½"	Overall (X × Y) 16½" × 17½"	Overall (X × Y) 19½" × 17½"
Sink 003601 Bowl (A × B × C) 9" × 16" × 8" \$ 1,050	Sink 003602 Bowl (A × B × C) 12" × 16" × 8" \$ 1,080	Sink 003603 Bowl (A × B × C) 15" × 16" × 8" \$ 1,129	Sink 003604 Bowl (A × B × C) 18" × 16" × 8" \$ 1,165
—	—	—	Sink 003647 Bowl (A × B × C) 18" × 16" × 10" \$ 1,201
Grid 200902 \$ 190	Grid 200903 \$ 200	Grid 200904 \$ 210	Grid 200905 \$ 220



ADD SOME À LA CARTE OPTIONS

Visit homerefinements.ca/configurator
or unfold the **À la Carte** chart at the back of this document.



FIND USEFUL ACCESSORIES

Enhance the functionality of these sinks by taking a look at the **"ACCESSORIES - INOX"** tab.

Overall (X × Y) 16½" × 19½"	Overall (X × Y) 19½" × 19½"
Sink 003626 Bowl (A × B × C) 15" × 18" × 10" \$ 1,195	Sink 003627 Bowl (A × B × C) 18" × 18" × 10" \$ 1,237
Grid 200916 \$ 215	Grid 200917 \$ 230

Cabinet 27"	Cabinet 30"	Cabinet 33"	Cabinet 36"	Cabinet 39"	Cabinet 42"
					
Overall (X × Y) 22½" × 17½"	Overall (X × Y) 25½" × 17½"	Overall (X × Y) 28½" × 17½"	Overall (X × Y) 31½" × 17½"	Overall (X × Y) 34½" × 17½"	Overall (X × Y) 37½" × 17½"
Sink 003606 Bowl (A × B × C) 21" × 16" × 8" \$ 1,201	Sink 003610 Bowl (A × B × C) 24" × 16" × 8" \$ 1,231	Sink 003611 Bowl (A × B × C) 27" × 16" × 8" \$ 1,267	Sink 003615 Bowl (A × B × C) 30" × 16" × 8" \$ 1,297	Sink 003670 Bowl (A × B × C) 33" × 16" × 8" \$ 1,370	—
Sink 003607 Bowl (A × B × C) 21" × 16" × 10" \$ 1,255	Sink 003680 Bowl (A × B × C) 24" × 16" × 10" \$ 1,291	Sink 003612 Bowl (A × B × C) 27" × 16" × 10" \$ 1,327	Sink 003685 Bowl (A × B × C) 30" × 16" × 10" \$ 1,363	Sink 003690 Bowl (A × B × C) 33" × 16" × 10" \$ 1,441	Sink 003695 Bowl (A × B × C) 36" × 16" × 10" \$ 1,525
Grid 200906 \$ 230	Grid 200907 \$ 250	Grid 200908 \$ 265	Grid 200909 \$ 280	Grid 200910 \$ 290	Grid 200911 \$ 300
					
Overall (X × Y) 22½" × 18½"	Overall (X × Y) 25½" × 18½"	Overall (X × Y) 28½" × 18½"	Overall (X × Y) 31½" × 18½"		
Sink 003618 Bowl (A × B × C) 21" × 17" × 10" \$ 1,267	Sink 003666 Bowl (A × B × C) 24" × 17" × 10" \$ 1,303	Sink 003621 Bowl (A × B × C) 27" × 17" × 10" \$ 1,345	Sink 003667 Bowl (A × B × C) 30" × 17" × 10" \$ 1,381		
Grid 200912 \$ 235	Grid 200913 \$ 250	Grid 200914 \$ 270	Grid 200915 \$ 285		
					
Overall (X × Y) 22½" × 19½"	Overall (X × Y) 25½" × 19½"	Overall (X × Y) 28½" × 19½"	Overall (X × Y) 31½" × 19½"	Overall (X × Y) 34½" × 19½"	Overall (X × Y) 37½" × 19½"
Sink 003628 Bowl (A × B × C) 21" × 18" × 10" \$ 1,279	Sink 003629 Bowl (A × B × C) 24" × 18" × 10" \$ 1,321	Sink 003631 Bowl (A × B × C) 27" × 18" × 10" \$ 1,357	Sink 003672 Bowl (A × B × C) 30" × 18" × 10" \$ 1,399	Sink 003633 Bowl (A × B × C) 33" × 18" × 10" \$ 1,477	Sink 003634 Bowl (A × B × C) 36" × 18" × 10" \$ 1,519
Grid 200918 \$ 245	Grid 200919 \$ 255	Grid 200920 \$ 275	Grid 200921 \$ 290	Grid 200922 \$ 300	Grid 200923 \$ 310

Kitchen sinks

Undermount installation

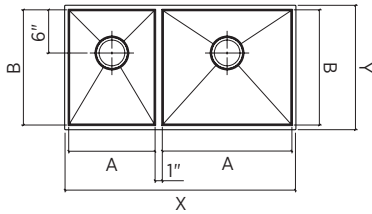
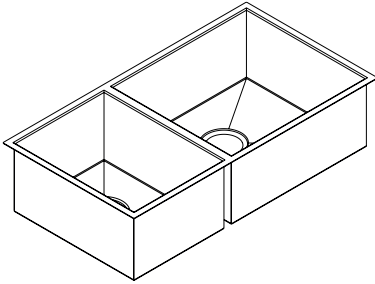

Cabinet 33"

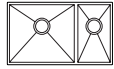

Overall (X × Y)
29½" × 17½"

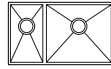

Overall (X × Y)
29½" × 17½"

Cabinet 36"

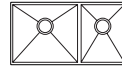

Overall (X × Y)
32½" × 17½"

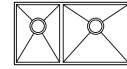

Overall (X × Y)
32½" × 17½"

Sink 003659

Bowl (A × B × C)
L 18" × 16" × 10"
R 9" × 16" × 8"
\$ 1,669

Sink 003648

Bowl (A × B × C)
L 9" × 16" × 8"
R 18" × 16" × 10"
\$ 1,669

Sink 003658

Bowl (A × B × C)
L 18" × 16" × 10"
R 12" × 16" × 8"
\$ 1,693

Sink 003649

Bowl (A × B × C)
L 12" × 16" × 8"
R 18" × 16" × 10"
\$ 1,693

Grid 200905 (L)
\$ 220

Grid 200902 (L)
\$ 190

Grid 200905 (L)
\$ 220

Grid 200903 (L)
\$ 200

Grid 200902 (R)
\$ 190

Grid 200905 (R)
\$ 220

Grid 200903 (R)
\$ 200

Grid 200905 (R)
\$ 220



ADD SOME À LA CARTE OPTIONS

Visit homerefinements.ca/configurator

or **unfold the À la Carte chart at the back of this document.**

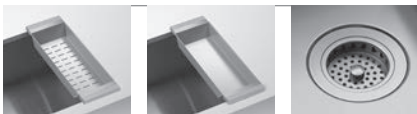

Colanders

Trays and Bins

Drains

FIND USEFUL ACCESSORIES

Enhance the functionality of these sinks by taking a look at the **"ACCESSORIES - INOX"** tab.

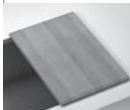

Cutting boards

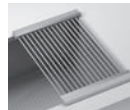

Drying racks

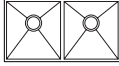
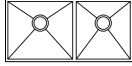
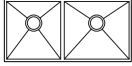
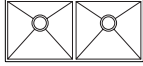

Faucets

Cabinet 36"	Cabinet 39"	Cabinet 42"	Cabinet 42"
			
Overall (X × Y) 32½" × 17½"	Overall (X × Y) 35½" × 17½"	Overall (X × Y) 35½" × 17½"	Overall (X × Y) 38½" × 17½"
Sink 003653 Bowl (A × B × C) L 15" × 16" × 8" R 15" × 16" × 8" \$ 1,657	Sink 003679 Bowl (A × B × C) L 18" × 16" × 8" R 15" × 16" × 8" \$ 1,709	Sink 003681 Bowl (A × B × C) L 15" × 16" × 8" R 18" × 16" × 8" \$ 1,709	Sink 003682 Bowl (A × B × C) L 18" × 16" × 8" R 18" × 16" × 8" \$ 1,790
—	Sink 003657 Bowl (A × B × C) L 18" × 16" × 10" R 15" × 16" × 8" \$ 1,729	Sink 003654 Bowl (A × B × C) L 15" × 16" × 8" R 18" × 16" × 10" \$ 1,729	—
Grid 200904 (L) \$ 210	Grid 200905 (L) \$ 220	Grid 200904 (L) \$ 210	Grid 200905 (L) \$ 220
Grid 200904 (R) \$ 210	Grid 200904 (R) \$ 210	Grid 200905 (R) \$ 220	Grid 200905 (R) \$ 220

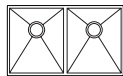

Overall (X × Y)
32½" × 19½"

Sink 003637
Bowl (A × B × C)
L 15" × 18" × 10"
R 15" × 18" × 10"
\$ 1,765

Grid 200916 (L)
\$ 215

Grid 200916 (R)
\$ 215

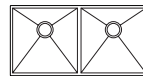

Overall (X × Y)
38½" × 19½"

Sink 003642
Bowl (A × B × C)
L 18" × 18" × 10"
R 18" × 18" × 10"
\$ 1,849

Grid 200917 (L)
\$ 230

Grid 200917 (R)
\$ 230

Kitchen sinks

Undermount installation

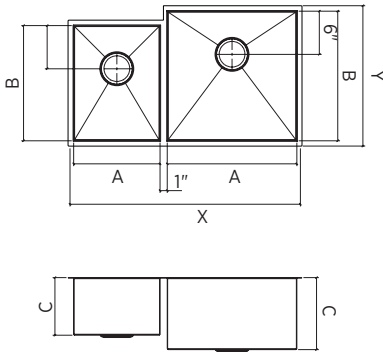
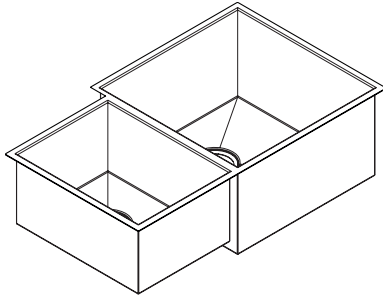

Cabinet 33"

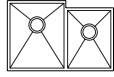

Overall (X × Y)
29½" × 19½"

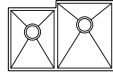

Overall (X × Y)
29½" × 19½"

Cabinet 36"

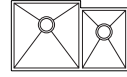

Overall (X × Y)
32½" × 19½"

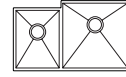

Overall (X × Y)
32½" × 19½"

Sink 003652

Bowl (A × B × C)
L 15" × 18" × 10"
R 12" × 16" × 8"
\$ 1,681

Sink 003651

Bowl (A × B × C)
L 12" × 16" × 8"
R 15" × 18" × 10"
\$ 1,681

Sink 003638

Bowl (A × B × C)
L 18" × 18" × 10"
R 12" × 16" × 8"
\$ 1,729

Sink 003639

Bowl (A × B × C)
L 12" × 16" × 8"
R 18" × 18" × 10"
\$ 1,729

Grid 200916 (L)

\$ 215

Grid 200903 (L)

\$ 200

Grid 200917 (L)

\$ 230

Grid 200903 (L)

\$ 200

Grid 200903 (R)

\$ 200

Grid 200916 (R)

\$ 215

Grid 200903 (R)

\$ 200

Grid 200917 (R)

\$ 230



ADD SOME À LA CARTE OPTIONS

Visit homerefinements.ca/configurator

or **unfold the À la Carte chart at the back of this document.**

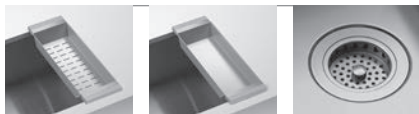

Colanders Trays and Bins Drains

FIND USEFUL ACCESSORIES

Enhance the functionality of these sinks by taking a look at the **"ACCESSORIES - INOX"** tab.



Cutting boards Drying racks Faucets

Cabinet 39"

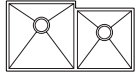

Overall (X × Y)
35½" × 19½"

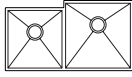

Overall (X × Y)
35½" × 19½"

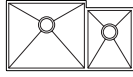

Overall (X × Y)
35½" × 19½"

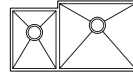

Overall (X × Y)
35½" × 19½"

Sink 003640

Bowl (A × B × C)
L 18" × 18" × 10"
R 15" × 16" × 8"
\$ 1,753

Sink 003641

Bowl (A × B × C)
L 15" × 16" × 8"
R 18" × 18" × 10"
\$ 1,753

Sink 003643

Bowl (A × B × C)
L 21" × 18" × 10"
R 12" × 16" × 8"
\$ 1,753

Sink 003644

Bowl (A × B × C)
L 12" × 16" × 8"
R 21" × 18" × 10"
\$ 1,753

Grid 200917 (L)
\$ 230

Grid 200904 (L)
\$ 210

Grid 200918 (L)
\$ 245

Grid 200903 (L)
\$ 200

Grid 200904 (R)
\$ 210

Grid 200917 (R)
\$ 230

Grid 200903 (R)
\$ 200

Grid 200918 (R)
\$ 245

Bar sinks

Undermount installation

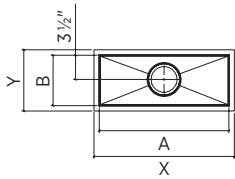
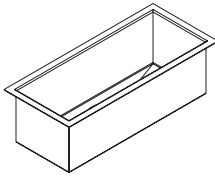
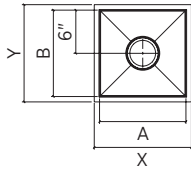
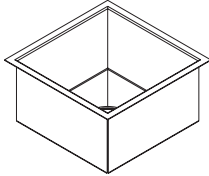

Cabinet 18"



Overall (X × Y)
13½" × 13½"

Sink 003608
Bowl (A × B × C)
12" × 12" × 7"
\$ 912

Sink 003668
Bowl (A × B × C)
12" × 12" × 7"
Drain Ø 2"
\$ 912

Grid 200924
\$ 190



Overall (X × Y)
13½" × 16½"

Sink 003614
Bowl (A × B × C)
12" × 15" × 7"
\$ 936

Sink 003616
Bowl (A × B × C)
12" × 15" × 7"
Drain Ø 2"
\$ 936

Grid 200925
\$ 195

Cabinet 21"



Overall (X × Y)
16½" × 16½"

Sink 003609
Bowl (A × B × C)
15" × 15" × 7"
\$ 960

Sink 003613
Bowl (A × B × C)
15" × 15" × 7"
Drain Ø 2"
\$ 960

Grid 200926
\$ 205

Cabinet 24"



Overall (X × Y)
19½" × 8½"

Sink 003617
Bowl (A × B × C)
18" × 7" × 6"
\$ 780

Grid
N/A

Cabinet 36"

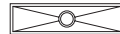

Overall (X × Y)
31½" × 8½"

Sink 003619
Bowl (A × B × C)
30" × 7" × 6"
\$ 930

Grid
N/A

Cabinet 48"

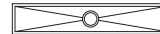

Overall (X × Y)
43½" × 8½"

Sink 003622
Bowl (A × B × C)
42" × 7" × 6"
\$ 1,080

Grid
N/A

Utility sinks

Undermount installation

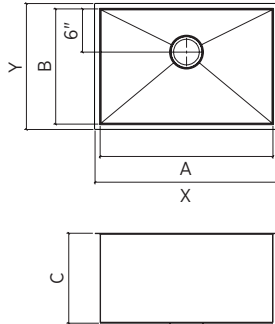
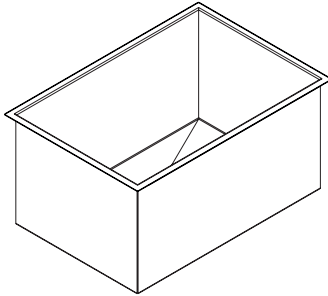

Cabinet 27"



Overall (X × Y)
22½" × 17½"

Sink 003673

Bowl (A × B × C)
21" × 16" × 12"
\$ 1,423

Grid 200906

\$ 230

Cabinet 30"



Overall (X × Y)
25½" × 17½"

Sink 003674

Bowl (A × B × C)
24" × 16" × 12"
\$ 1,465

Grid 200907

\$ 250

Cabinet 36"

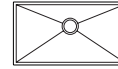

Overall (X × Y)
31½" × 17½"

Sink 003676

Bowl (A × B × C)
30" × 16" × 12"
\$ 1,555

Grid 200909

\$ 280

Utility sinks

Pedestal

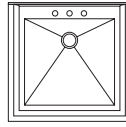
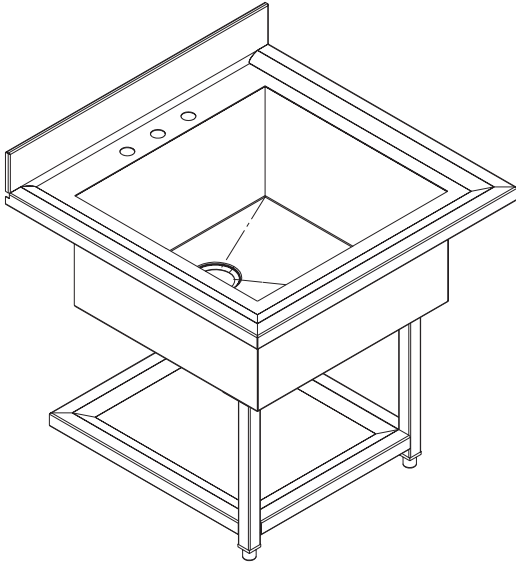

Overall (X × Y)
34" × 33"

Sink 003865
Bowl (A × B × C)
25" × 24" × 12"
\$ 4,462

Grid
N/A

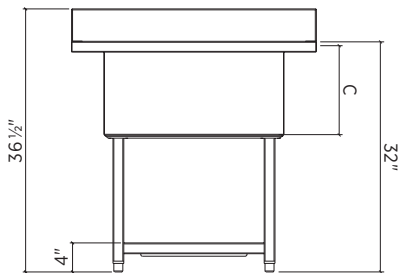
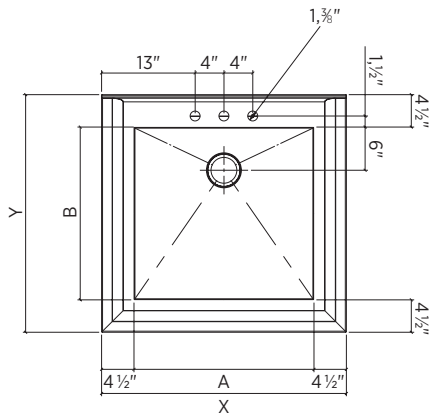

J7[®]



J7[®]

Contemporary style

These sinks have slightly rounded 7 mm radius corners, giving them a resolutely contemporary style that is especially easy to clean. The kitchen sinks in this collection can be configured with the À la Carte options.

Features

Handcrafted in Canada

Commercial quality stainless steel - 16 ga thickness

Corrosion resistant material - 304 series (18/10)

Environmentally friendly product, 100% recyclable

Elegant no. 4 brushed finish that matches the appliances

Highly efficient sound deadening pads

Practical flat sink bottom and straight bowl sides that maximize available space in the bowl

Stylish and functional bowl bottom grooves that facilitate water drainage

Rear 3½" drain placement -
For bar sinks, please refer to the specsheets for drain sizes and placement

Mounting hardware and cutout template included

Certifications: ASME A112.19.3, CSA B45.0, CSA B45.4

Kitchen sinks

Undermount installation

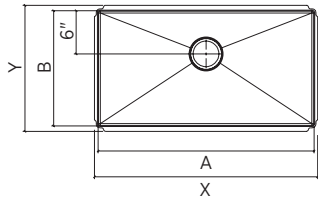
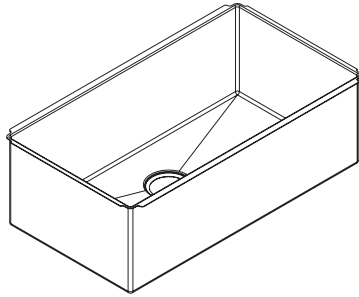

Cabinet 15"



Overall (X × Y)
10½" × 17½"

Sink 003903
Bowl (A × B × C)
9" × 16" × 8"
\$ 1,420

Cabinet 18"



Overall (X × Y)
13½" × 17½"

Sink 003907
Bowl (A × B × C)
12" × 16" × 8"
\$ 1,445

Cabinet 21"



Overall (X × Y)
16½" × 17½"

Sink 003909
Bowl (A × B × C)
15" × 16" × 8"
\$ 1,490

Cabinet 24"



Overall (X × Y)
19½" × 17½"

Sink 003912
Bowl (A × B × C)
18" × 16" × 8"
\$ 1,520

Sink 003981
Bowl (A × B × C)
18" × 16" × 10"
\$ 1,560

Grid 200902
\$ 190

Grid 200903
\$ 200

Grid 200904
\$ 210

Grid 200905
\$ 220



ADD SOME À LA CARTE OPTIONS

Visit homerefinements.ca/configurator

or unfold the **À la Carte** chart at the back of this document.

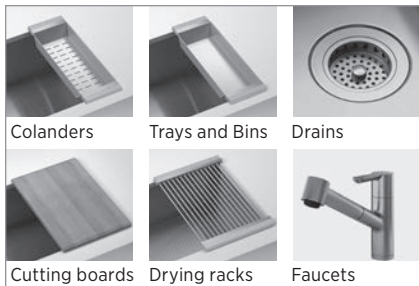

FIND USEFUL ACCESSORIES

Enhance the functionality of these sinks by taking a look at the **"ACCESSORIES - INOX"** tab.



Overall (X × Y)
16½" × 19½"

Sink 003937
Bowl (A × B × C)
15" × 18" × 10"
\$ 1,550

Grid 200916
\$ 215



Overall (X × Y)
19½" × 19½"

Sink 003938
Bowl (A × B × C)
18" × 18" × 10"
\$ 1,590

Grid 200917
\$ 230

Cabinet 27"	Cabinet 30"	Cabinet 33"	Cabinet 36"	Cabinet 39"	Cabinet 42"
					
Overall (X × Y) 22½" × 17½"	Overall (X × Y) 25½" × 17½"	Overall (X × Y) 28½" × 17½"	Overall (X × Y) 31½" × 17½"	Overall (X × Y) 34½" × 17½"	Overall (X × Y) 37½" × 17½"
Sink 003913 Bowl (A × B × C) 21" × 16" × 8" \$ 1,560	Sink 003910 Bowl (A × B × C) 24" × 16" × 8" \$ 1,590	Sink 003919 Bowl (A × B × C) 27" × 16" × 8" \$ 1,615	Sink 003915 Bowl (A × B × C) 30" × 16" × 8" \$ 1,645	Sink 003995 Bowl (A × B × C) 33" × 16" × 8" \$ 1,650	—
Sink 003914 Bowl (A × B × C) 21" × 16" × 10" \$ 1,605	Sink 003918 Bowl (A × B × C) 24" × 16" × 10" \$ 1,640	Sink 003922 Bowl (A × B × C) 27" × 16" × 10" \$ 1,675	Sink 003908 Bowl (A × B × C) 30" × 16" × 10" \$ 1,710	Sink 003927 Bowl (A × B × C) 33" × 16" × 10" \$ 1,780	Sink 003928 Bowl (A × B × C) 36" × 16" × 10" \$ 1,820
Grid 200906 \$ 230	Grid 200907 \$ 250	Grid 200908 \$ 265	Grid 200909 \$ 280	Grid 200910 \$ 290	Grid 200911 \$ 300
					
Overall (X × Y) 22½" × 18½"	Overall (X × Y) 25½" × 18½"	Overall (X × Y) 28½" × 18½"	Overall (X × Y) 31½" × 18½"		
Sink 003929 Bowl (A × B × C) 21" × 17" × 10" \$ 1,620	Sink 003920 Bowl (A × B × C) 24" × 17" × 10" \$ 1,655	Sink 003932 Bowl (A × B × C) 27" × 17" × 10" \$ 1,690	Sink 003925 Bowl (A × B × C) 30" × 17" × 10" \$ 1,725		
Grid 200912 \$ 235	Grid 200913 \$ 250	Grid 200914 \$ 270	Grid 200915 \$ 285		
					
Overall (X × Y) 22½" × 19½"	Overall (X × Y) 25½" × 19½"	Overall (X × Y) 28½" × 19½"	Overall (X × Y) 31½" × 19½"	Overall (X × Y) 34½" × 19½"	Overall (X × Y) 37½" × 19½"
Sink 003939 Bowl (A × B × C) 21" × 18" × 10" \$ 1,635	Sink 003941 Bowl (A × B × C) 24" × 18" × 10" \$ 1,675	Sink 003942 Bowl (A × B × C) 27" × 18" × 10" \$ 1,705	Sink 003935 Bowl (A × B × C) 30" × 18" × 10" \$ 1,745	Sink 003944 Bowl (A × B × C) 33" × 18" × 10" \$ 1,820	Sink 003946 Bowl (A × B × C) 36" × 18" × 10" \$ 1,850
Grid 200918 \$ 245	Grid 200919 \$ 255	Grid 200920 \$ 275	Grid 200921 \$ 290	Grid 200922 \$ 300	Grid 200923 \$ 310

Kitchen sinks

Undermount installation

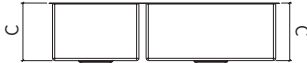
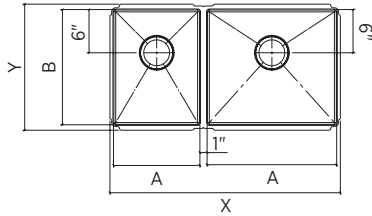
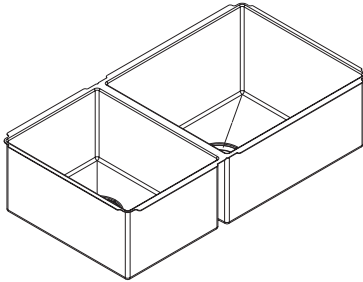

Cabinet 33"

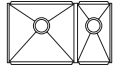

Overall (X × Y)
29½" × 17½"

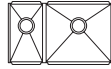

Overall (X × Y)
29½" × 17½"

Cabinet 36"

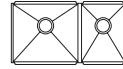

Overall (X × Y)
32½" × 17½"

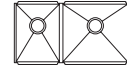

Overall (X × Y)
32½" × 17½"

Sink 003989

Bowl (A × B × C)
L 18" × 16" × 10"
R 9" × 16" × 8"
\$ 2,100

Sink 003982

Bowl (A × B × C)
L 9" × 16" × 8"
R 18" × 16" × 10"
\$ 2,100

Sink 003934

Bowl (A × B × C)
L 18" × 16" × 8"
R 12" × 16" × 8"
\$ 2,085

Sink 003936

Bowl (A × B × C)
L 12" × 16" × 8"
R 18" × 16" × 8"
\$ 2,085

Sink 003991

Bowl (A × B × C)
L 18" × 16" × 10"
R 12" × 16" × 8"
\$ 2,110

Sink 003983

Bowl (A × B × C)
L 12" × 16" × 8"
R 18" × 16" × 10"
\$ 2,110

Grid 200905 (L)

\$ 220

Grid 200902 (L)

\$ 190

Grid 200905 (L)

\$ 220

Grid 200903 (L)

\$ 200

Grid 200902 (R)

\$ 190

Grid 200905 (R)

\$ 220

Grid 200903 (R)

\$ 200

Grid 200905 (R)

\$ 220



ADD SOME À LA CARTE OPTIONS

Visit homerefinements.ca/configurator

or **unfold the À la Carte chart at the back of this document.**



Colanders

Trays and Bins

Drains

FIND USEFUL ACCESSORIES

Enhance the functionality of these sinks by taking a look at the **"ACCESSORIES - INOX"** tab.

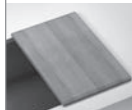

Cutting boards

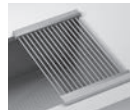

Drying racks

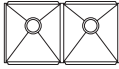
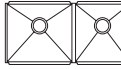
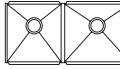
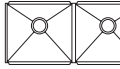

Faucets

Cabinet 36"	Cabinet 39"	Cabinet 42"	Cabinet 42"
			
Overall (X × Y) 32½" × 17½"	Overall (X × Y) 35½" × 17½"	Overall (X × Y) 35½" × 17½"	Overall (X × Y) 38½" × 17½"
Sink 003987 Bowl (A × B × C) L 15" × 16" × 8" R 15" × 16" × 8" \$ 2,085	Sink 003947 Bowl (A × B × C) L 18" × 16" × 8" R 15" × 16" × 8" \$ 2,100	Sink 003948 Bowl (A × B × C) L 15" × 16" × 8" R 18" × 16" × 8" \$ 2,100	Sink 003963 Bowl (A × B × C) L 18" × 16" × 8" R 18" × 16" × 8" \$ 2,145
—	Sink 003992 Bowl (A × B × C) L 18" × 16" × 10" R 15" × 16" × 8" \$ 2,150	Sink 003986 Bowl (A × B × C) L 15" × 16" × 8" R 18" × 16" × 10" \$ 2,150	—
Grid 200904 (L) \$ 210	Grid 200905 (L) \$ 220	Grid 200904 (L) \$ 210	Grid 200905 (L) \$ 220
Grid 200904 (R) \$ 210	Grid 200904 (R) \$ 210	Grid 200905 (R) \$ 220	Grid 200905 (R) \$ 220

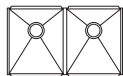

Overall (X × Y)
32½" × 19½"

Sink 003949
Bowl (A × B × C)
L 15" × 18" × 10"
R 15" × 18" × 10"
\$ 2,175

Grid 200916 (L)
\$ 215

Grid 200916 (R)
\$ 215

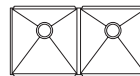

Overall (X × Y)
38½" × 19½"

Sink 003958
Bowl (A × B × C)
L 18" × 18" × 10"
R 18" × 18" × 10"
\$ 2,250

Grid 200917 (L)
\$ 230

Grid 200917 (R)
\$ 230

Kitchen sinks

Undermount installation

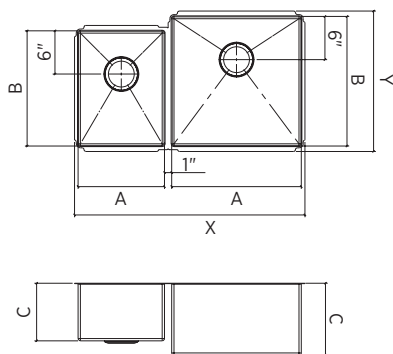
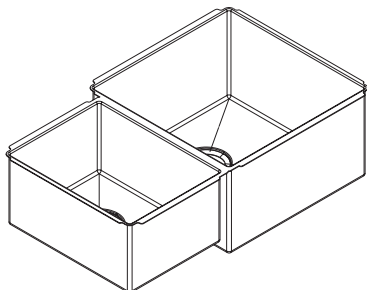

Cabinet 33"

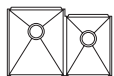

Overall (X × Y)
29½" × 19½"

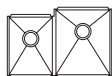

Overall (X × Y)
29½" × 19½"

Cabinet 36"

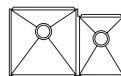

Overall (X × Y)
32½" × 19½"

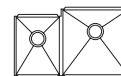

Overall (X × Y)
32½" × 19½"

Sink 003988

Bowl (A × B × C)
L 15" × 18" × 10"
R 12" × 16" × 8"
\$ 2,100

Sink 003984

Bowl (A × B × C)
L 12" × 16" × 8"
R 15" × 18" × 10"
\$ 2,100

Sink 003952

Bowl (A × B × C)
L 18" × 18" × 10"
R 12" × 16" × 8"
\$ 2,150

Sink 003953

Bowl (A × B × C)
L 12" × 16" × 8"
R 18" × 18" × 10"
\$ 2,150

Grid 200916 (L)
\$ 215

Grid 200903 (L)
\$ 200

Grid 200917 (L)
\$ 230

Grid 200903 (L)
\$ 200

Grid 200903 (R)
\$ 200

Grid 200916 (R)
\$ 215

Grid 200903 (R)
\$ 200

Grid 200917 (R)
\$ 230



ADD SOME À LA CARTE OPTIONS

Visit homerefinements.ca/configurator
or **unfold the À la Carte chart at the back of this document.**



FIND USEFUL ACCESSORIES

Enhance the functionality of these sinks by taking a look at the **"ACCESSORIES - INOX"** tab.

Cabinet 39"

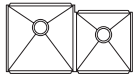

Overall (X × Y)
35½" × 19½"

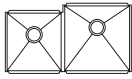

Overall (X × Y)
35½" × 19½"

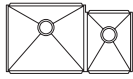

Overall (X × Y)
35½" × 19½"

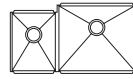

Overall (X × Y)
35½" × 19½"

Sink 003954

Bowl (A × B × C)
L 18" × 18" × 10"
R 15" × 16" × 8"
\$ 2,165

Sink 003957

Bowl (A × B × C)
L 15" × 16" × 8"
R 18" × 18" × 10"
\$ 2,165

Sink 003959

Bowl (A × B × C)
L 21" × 18" × 10"
R 12" × 16" × 8"
\$ 2,165

Sink 003962

Bowl (A × B × C)
L 12" × 16" × 8"
R 21" × 18" × 10"
\$ 2,165

Grid 200917 (L)
\$ 230

Grid 200904 (L)
\$ 210

Grid 200918 (L)
\$ 245

Grid 200903 (L)
\$ 200

Grid 200904 (R)
\$ 210

Grid 200917 (R)
\$ 230

Grid 200903 (R)
\$ 200

Grid 200918 (R)
\$ 245

Bar sinks

Undermount installation

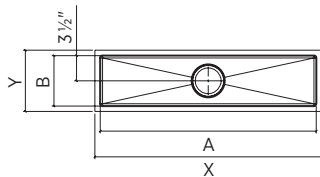
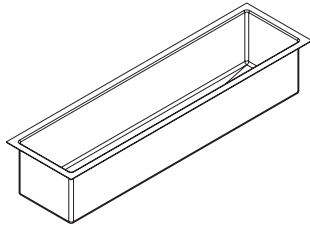
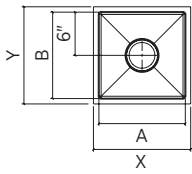
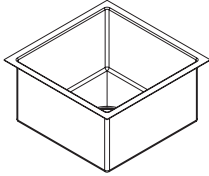

Cabinet 18"



Overall (X × Y)
13½" × 13½"

Sink 003917

Bowl (A × B × C)
12" × 12" × 7"
\$ 1,210

Sink 003923

Bowl (A × B × C)
12" × 12" × 7"
Drain Ø 2"
\$ 1,210

Grid 200924

\$ 190



Overall (X × Y)
13½" × 16½"

Sink 003933

Bowl (A × B × C)
12" × 15" × 7"
\$ 1,220

Sink 003943

Bowl (A × B × C)
12" × 15" × 7"
Drain Ø 2"
\$ 1,220

Grid 200925

\$ 195

Cabinet 21"



Overall (X × Y)
16½" × 16½"

Sink 003924

Bowl (A × B × C)
15" × 15" × 7"
\$ 1,245

Sink 003931

Bowl (A × B × C)
15" × 15" × 7"
Drain Ø 2"
\$ 1,245

Grid 200926

\$ 205

Cabinet 24"



Overall (X × Y)
19½" × 8½"

Sink 003967

Bowl (A × B × C)
18" × 7" × 6"
\$ 1,135

Grid

N/A

Cabinet 36"

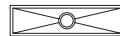

Overall (X × Y)
31½" × 8½"

Sink 003968

Bowl (A × B × C)
30" × 7" × 6"
\$ 1,195

Grid

N/A

Cabinet 48"

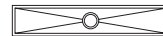

Overall (X × Y)
43½" × 8½"

Sink 003969

Bowl (A × B × C)
42" × 7" × 6"
\$ 1,245

Grid

N/A

Utility sinks

Undermount installation

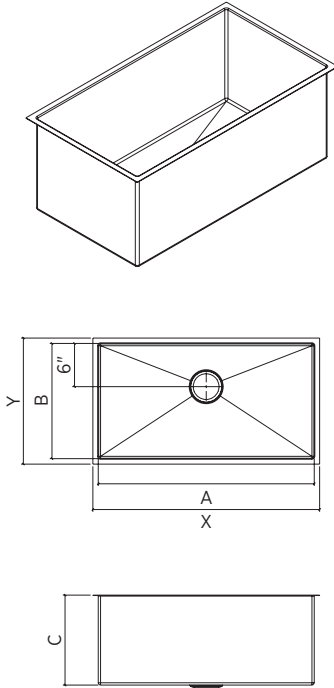

Cabinet 27"



Overall (X × Y)
22½" × 17½"

Sink 003972

Bowl (A × B × C)
21" × 16" × 12"
\$ 1,730

Grid 200906

\$ 230

Cabinet 30"



Overall (X × Y)
25½" × 17½"

Sink 003973

Bowl (A × B × C)
24" × 16" × 12"
\$ 1,775

Grid 200907

\$ 250

Cabinet 36"

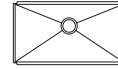

Overall (X × Y)
31½" × 17½"

Sink 003974

Bowl (A × B × C)
30" × 16" × 12"
\$ 1,855

Grid 200909

\$ 280

CLASSIC



CLASSIC

Classic style

With their roomy 29 mm radius corners, the Classic sinks blend seamlessly into almost any kitchen. The easy to clean basin makes this model the sink of choice for commercial kitchens. All kitchen sinks in this collection can be customized with the À la Carte options.

Features

Handcrafted in Canada

Commercial quality stainless steel - 16 ga thickness

Corrosion resistant material - 304 series (18/10)

Environmentally friendly product, 100% recyclable

Elegant no. 4 brushed finish that matches the appliances

Highly efficient sound deadening pads

Practical flat sink bottom and straight bowl sides that maximize available space in the bowl

Stylish and functional bowl bottom grooves that facilitate water drainage

Rear 3½" drain placement -
For bar sinks, please refer to the specsheets for drain sizes and placement

Mounting hardware and cutout template included

Certifications: ASME A112.19.3, CSA B45.0, CSA B45.4

Kitchen sinks

Undermount installation

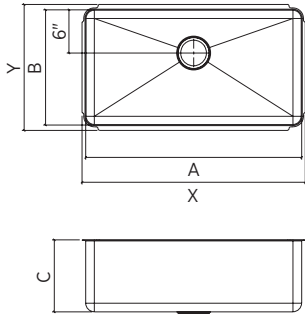
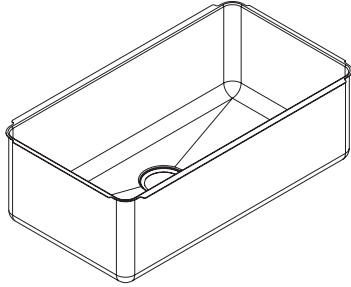

Cabinet 15"



Overall (X × Y)
10½" × 17½"

Sink 003202

Bowl (A × B × C)
9" × 16" × 8"
\$ 1,605

Cabinet 18"



Overall (X × Y)
13½" × 17½"

Sink 003203

Bowl (A × B × C)
12" × 16" × 8"
\$ 1,635

Cabinet 21"



Overall (X × Y)
16½" × 17½"

Sink 003204

Bowl (A × B × C)
15" × 16" × 8"
\$ 1,680

Cabinet 24"



Overall (X × Y)
19½" × 17½"

Sink 003205

Bowl (A × B × C)
18" × 16" × 8"
\$ 1,705

Sink 003244

Bowl (A × B × C)
18" × 16" × 10"
\$ 1,735

Grid 200902

\$ 190

Grid 200903

\$ 200

Grid 200904

\$ 210

Grid 200905

\$ 220



ADD SOME À LA CARTE OPTIONS

Visit homerefinements.ca/configurator

or unfold the **À la Carte** chart at the back of this document.

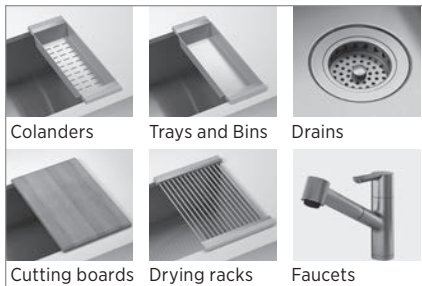

Colanders

Trays and Bins

Drains

Cutting boards

Drying racks

Faucets

FIND USEFUL ACCESSORIES

Enhance the functionality of these sinks by taking a look at the **"ACCESSORIES - INOX"** tab.



Overall (X × Y)
16½" × 19½"

Sink 003222

Bowl (A × B × C)
15" × 18" × 10"
\$ 1,735

Grid 200916

\$ 215









Overall (X × Y)
19½" × 19½"





Sink 003258







Bowl (A × B × C)
18" × 18" × 10"
\$ 1,775

Grid 200917

\$ 230

Cabinet 27"	Cabinet 30"	Cabinet 33"	Cabinet 36"	Cabinet 39"	Cabinet 42"
					
Overall (X × Y) 22½" × 17½"	Overall (X × Y) 25½" × 17½"	Overall (X × Y) 28½" × 17½"	Overall (X × Y) 31½" × 17½"	Overall (X × Y) 34½" × 17½"	Overall (X × Y) 37½" × 17½"
Sink 003206 Bowl (A × B × C) 21" × 16" × 8" \$ 1,745	Sink 003285 Bowl (A × B × C) 24" × 16" × 8" \$ 1,770	Sink 003210 Bowl (A × B × C) 27" × 16" × 8" \$ 1,800	Sink 003240 Bowl (A × B × C) 30" × 16" × 8" \$ 1,825	Sink 003284 Bowl (A × B × C) 33" × 16" × 8" \$ 1,845	—
Sink 003207 Bowl (A × B × C) 21" × 16" × 10" \$ 1,790	Sink 003209 Bowl (A × B × C) 24" × 16" × 10" \$ 1,820	Sink 003211 Bowl (A × B × C) 27" × 16" × 10" \$ 1,855	Sink 003213 Bowl (A × B × C) 30" × 16" × 10" \$ 1,890	Sink 003214 Bowl (A × B × C) 33" × 16" × 10" \$ 1,955	Sink 003215 Bowl (A × B × C) 36" × 16" × 10" \$ 1,995
Grid 200906 \$ 230	Grid 200907 \$ 250	Grid 200908 \$ 265	Grid 200909 \$ 280	Grid 200910 \$ 290	Grid 200911 \$ 300

			
Overall (X × Y) 22½" × 18½"	Overall (X × Y) 25½" × 18½"	Overall (X × Y) 28½" × 18½"	Overall (X × Y) 31½" × 18½"
Sink 003216 Bowl (A × B × C) 21" × 17" × 10" \$ 1,800	Sink 003217 Bowl (A × B × C) 24" × 17" × 10" \$ 1,840	Sink 003218 Bowl (A × B × C) 27" × 17" × 10" \$ 1,870	Sink 003235 Bowl (A × B × C) 30" × 17" × 10" \$ 1,905
Grid 200912 \$ 235	Grid 200913 \$ 250	Grid 200914 \$ 270	Grid 200915 \$ 285

					
Overall (X × Y) 22½" × 19½"	Overall (X × Y) 25½" × 19½"	Overall (X × Y) 28½" × 19½"	Overall (X × Y) 31½" × 19½"	Overall (X × Y) 34½" × 19½"	Overall (X × Y) 37½" × 19½"
Sink 003224 Bowl (A × B × C) 21" × 18" × 10" \$ 1,815	Sink 003280 Bowl (A × B × C) 24" × 18" × 10" \$ 1,855	Sink 003226 Bowl (A × B × C) 27" × 18" × 10" \$ 1,885	Sink 003290 Bowl (A × B × C) 30" × 18" × 10" \$ 1,925	Sink 003259 Bowl (A × B × C) 33" × 18" × 10" \$ 1,995	Sink 003257 Bowl (A × B × C) 36" × 18" × 10" \$ 2,025
Grid 200918 \$ 245	Grid 200919 \$ 255	Grid 200920 \$ 275	Grid 200921 \$ 290	Grid 200922 \$ 300	Grid 200923 \$ 310

Kitchen sinks

Undermount installation

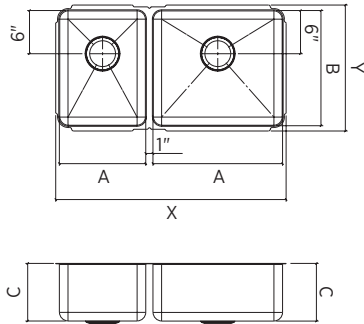
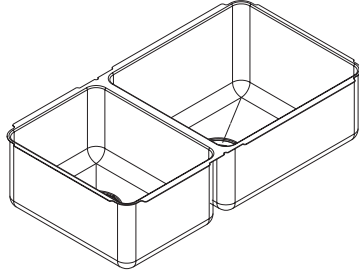

Cabinet 33"

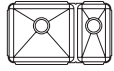

Overall (X × Y)
29½" × 17½"

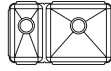

Overall (X × Y)
29½" × 17½"

Cabinet 36"

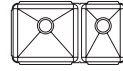

Overall (X × Y)
32½" × 17½"

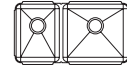

Overall (X × Y)
32½" × 17½"

Sink 003256

Bowl (A × B × C)
L 18" × 16" × 10"
R 9" × 16" × 8"
\$ 2,300

Sink 003246

Bowl (A × B × C)
L 9" × 16" × 8"
R 18" × 16" × 10"
\$ 2,300

Sink 003254

Bowl (A × B × C)
L 18" × 16" × 10"
R 12" × 16" × 8"
\$ 2,310

Sink 003248

Bowl (A × B × C)
L 12" × 16" × 8"
R 18" × 16" × 10"
\$ 2,310

Grid 200905 (L)
\$ 220

Grid 200902 (L)
\$ 190

Grid 200905 (L)
\$ 220

Grid 200903 (L)
\$ 200

Grid 200902 (R)
\$ 190

Grid 200905 (R)
\$ 220

Grid 200903 (R)
\$ 200

Grid 200905 (R)
\$ 220



ADD SOME À LA CARTE OPTIONS

Visit homerefinements.ca/configurator

or **unfold the À la Carte chart at the back of this document.**



Colanders Trays and Bins Drains

FIND USEFUL ACCESSORIES

Enhance the functionality of these sinks by taking a look at the **"ACCESSORIES - INOX"** tab.

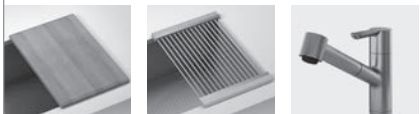

Cutting boards Drying racks Faucets

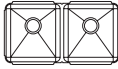
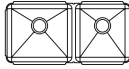
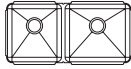
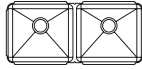
Cabinet 36"	Cabinet 39"	Cabinet 42"	Cabinet 42"
			
Overall (X × Y) 32½" × 17½"	Overall (X × Y) 35½" × 17½"	Overall (X × Y) 35½" × 17½"	Overall (X × Y) 38½" × 17½"
Sink 003251 Bowl (A × B × C) L 15" × 16" × 8" R 15" × 16" × 8" \$ 2,285	Sink 003281 Bowl (A × B × C) L 18" × 16" × 8" R 15" × 16" × 8" \$ 2,315	Sink 003282 Bowl (A × B × C) L 15" × 16" × 8" R 18" × 16" × 8" \$ 2,315	Sink 003283 Bowl (A × B × C) L 18" × 16" × 8" R 18" × 16" × 8" \$ 2,345
—	Sink 003253 Bowl (A × B × C) L 18" × 16" × 10" R 15" × 16" × 8" \$ 2,350	Sink 003249 Bowl (A × B × C) L 15" × 16" × 8" R 18" × 16" × 10" \$ 2,350	—
Grid 200904 (L) \$ 210	Grid 200905 (L) \$ 220	Grid 200904 (L) \$ 210	Grid 200905 (L) \$ 220
Grid 200904 (R) \$ 210	Grid 200904 (R) \$ 210	Grid 200905 (R) \$ 220	Grid 200905 (R) \$ 220

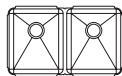

Overall (X × Y)
32½" × 19½"

Sink 003232
Bowl (A × B × C)
L 15" × 18" × 10"
R 15" × 18" × 10"
\$ 2,375

Grid 200916 (L)
\$ 215

Grid 200916 (R)
\$ 215

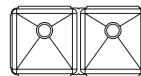

Overall (X × Y)
38½" × 19½"

Sink 003238
Bowl (A × B × C)
L 18" × 18" × 10"
R 18" × 18" × 10"
\$ 2,455

Grid 200917 (L)
\$ 230

Grid 200917 (R)
\$ 230

Kitchen sinks

Undermount installation

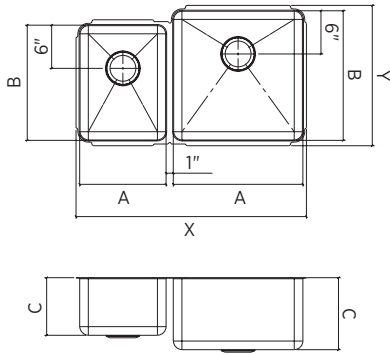
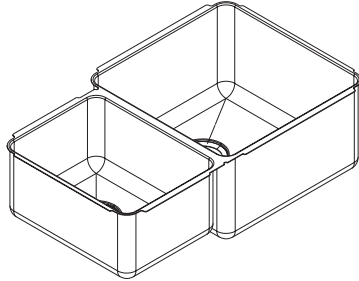

Cabinet 33"

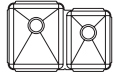

Overall (X × Y)
29½" × 19½"

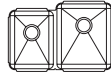

Overall (X × Y)
29½" × 19½"

Cabinet 36"

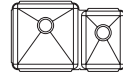

Overall (X × Y)
32½" × 19½"

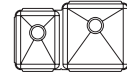

Overall (X × Y)
32½" × 19½"

Sink 003252

Bowl (A × B × C)
L 15" × 18" × 10"
R 12" × 16" × 8"
\$ 2,310

Sink 003247

Bowl (A × B × C)
L 12" × 16" × 8"
R 15" × 18" × 10"
\$ 2,310

Sink 003233

Bowl (A × B × C)
L 18" × 18" × 10"
R 12" × 16" × 8"
\$ 2,350

Sink 003234

Bowl (A × B × C)
L 12" × 16" × 8"
R 18" × 18" × 10"
\$ 2,350

Grid 200916 (L)

\$ 215

Grid 200903 (L)

\$ 200

Grid 200917 (L)

\$ 230

Grid 200903 (L)

\$ 200

Grid 200903 (R)

\$ 200

Grid 200916 (R)

\$ 215

Grid 200903 (R)

\$ 200

Grid 200917 (R)

\$ 230



ADD SOME À LA CARTE OPTIONS

Visit homerefinements.ca/configurator

or **unfold the À la Carte chart at the back of this document.**



Colanders

Trays and Bins

Drains

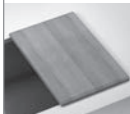

Cutting boards

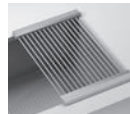

Drying racks



Faucets

FIND USEFUL ACCESSORIES

Enhance the functionality of these sinks by taking a look at the **"ACCESSORIES - INOX"** tab.

Cabinet 39"

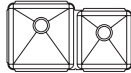
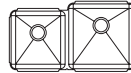
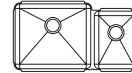
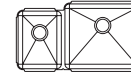
			
Overall (X × Y) 35½" × 19½"	Overall (X × Y) 35½" × 19½"	Overall (X × Y) 35½" × 19½"	Overall (X × Y) 35½" × 19½"
—	—	—	—

Sink 003236 Bowl (A × B × C) L 18" × 18" × 10" R 15" × 16" × 8" \$ 2,365	Sink 003237 Bowl (A × B × C) L 15" × 16" × 8" R 18" × 18" × 10" \$ 2,365	Sink 003239 Bowl (A × B × C) L 21" × 18" × 10" R 12" × 16" × 8" \$ 2,375	Sink 003241 Bowl (A × B × C) L 12" × 16" × 8" R 21" × 18" × 10" \$ 2,375
Grid 200917 (L) \$ 230	Grid 200904 (L) \$ 210	Grid 200918 (L) \$ 245	Grid 200903 (L) \$ 200
Grid 200904 (R) \$ 210	Grid 200917 (R) \$ 230	Grid 200903 (R) \$ 200	Grid 200918 (R) \$ 245

Bar sinks

Undermount installation

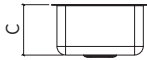
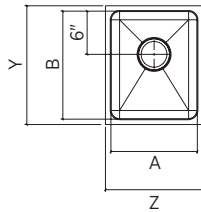
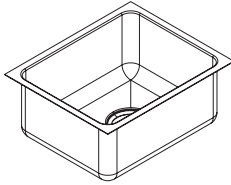

Cabinet 18"



Overall (Z × Y)
13½" × 13½"

Sink 003212

Bowl (A × B × C)
12" × 12" × 7"
\$ 1,250

Sink 003219

Bowl (A × B × C)
12" × 12" × 7"
Drain Ø 2"
\$ 1,250

Grid 200924

\$ 190



Overall (Z × Y)
13½" × 16½"

Sink 003228

Bowl (A × B × C)
12" × 15" × 7"
\$ 1,265

Sink 003229

Bowl (A × B × C)
12" × 15" × 7"
Drain Ø 2"
\$ 1,265

Grid 200925

\$ 195

Cabinet 21"



Overall (Z × Y)
16½" × 16½"

Sink 003225

Bowl (A × B × C)
15" × 15" × 7"
\$ 1,285

Sink 003227

Bowl (A × B × C)
15" × 15" × 7"
Drain Ø 2"
\$ 1,285

Grid 200926

\$ 205

À LA CARTE



À LA CARTE

Options

With the À la Carte options, you can transform any standard kitchen sink into a one-of-a-kind, ultra-functional work station.

This exclusive concept lets you personalize a sink with the options listed in this section. Getting the sink you want is easy. Just select a kitchen sink from our UrbanEdge®, J7®, or Classic standard collections and choose one or more options to customize it with functionalities you wouldn't find in a standard basin. Plus, our customized À la Carte sinks are certified CSA.

Use our online interactive tool to configure your new creation
homerefinelements.ca/configurator

To access the price of your creation, login by using the password
configHR01

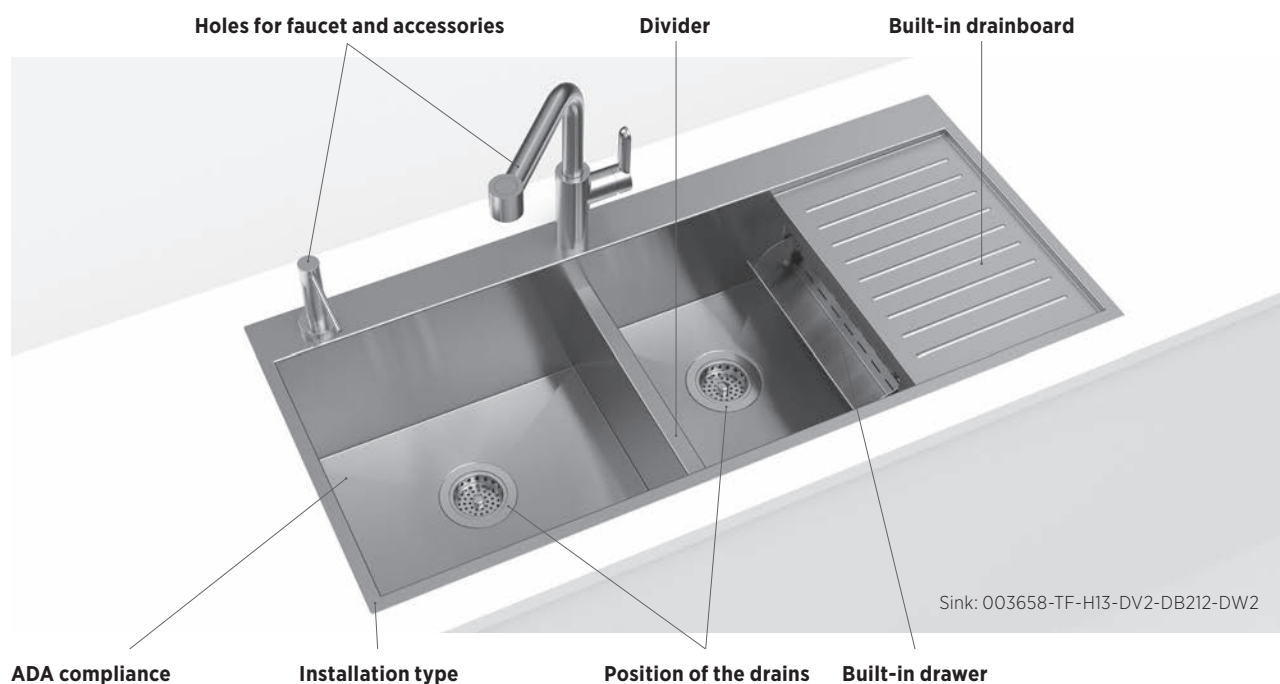

À la Carte options

Online interactive tool

With our online configuration tool, you can create an À la Carte sink in minutes. Select a model, add or remove options, see a technical drawing of your special sink, and submit it for pricing.

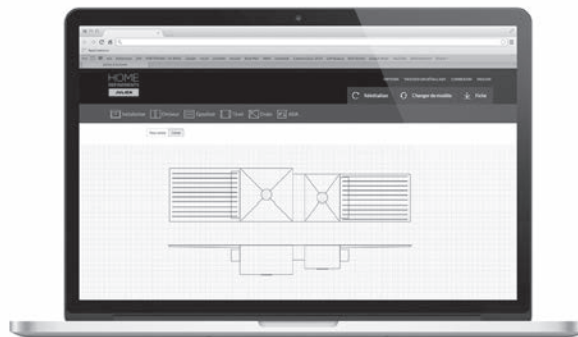

Visit homerefinements.ca/configurator

To access the price of your creation, login by using the password
configHR01

Installation type

By default, all kitchen sinks from our standard collections are designed for undermount installation. With the À la Carte options, you can now select one of the following alternative installation options:

Undermount with apron

Choosing a sink with an apron showcases the elegance of stainless steel.

- **Flat (UAF)**

This undermount sink with an apron flat is a modern version of the farmhouse style sink.

- **Curved (UAC)**

Adding a country feel is as simple as installing an undermount sink with an apron curved.

Topmount / Flushmount (TF)

A topmount installation model is perfect if you have a laminate, wood, or ceramic countertop or if you want to replace your sink without changing your stone countertop. These models can also be flush-mounted. Choosing this option will add a 3" platform at the back and ¾" flanges on the three other sides of the sink.



Description	Option	Price
Undermount with apron flat	UAF	\$ 720
Undermount with apron curved	UAC	\$ 720
Topmount / Flushmount ⁽¹⁾	TF	\$ 675

1. Please note that all of these sinks come with at least one standard 1 3/8" diameter hole. Refer to the option "Hole(s) for faucet and accessories" to determine its position.

À la Carte options

Hole(s) for faucet and accessories

Topmount or flushmount models are equipped with a 3" wide rear platform for faucet and accessories, and by default, the hole is centered (HP3). If you want a different hole configuration, you can determine the number and layout of the holes needed.

Far left (HP1)

The center of HP1 is 3" from the inner left wall of the sink.

Center left (HP2)

The center of HP2 is 4" from the center of HP3.

Center (HP3)

The center of the bowl. If you select a double bowl sink, this hole will be aligned with the divider.

Center right (HP4)

The center of HP4 is 4" from the center of HP3.

Far right (HP5)

The center of HP5 is 3" from the inner right wall of the sink.

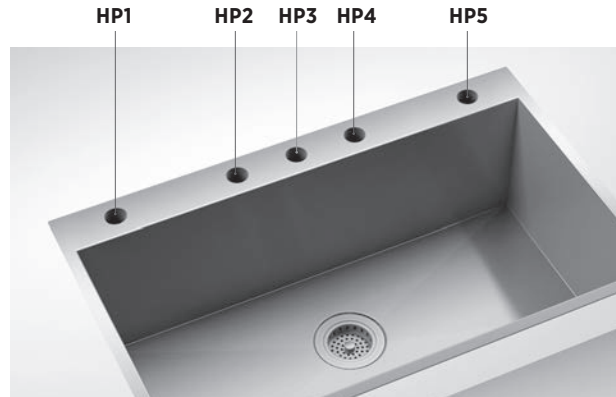

Description ⁽¹⁾	Option	Price
Far left hole	HP1	Free
Center left hole	HP2	Free
Center hole	HP3	Free
Center right hole	HP4	Free
Far right hole	HP5	Free

1. Depending on the width of the sink, which modifies the available space for drilling the holes, some limitations may apply. Only HP3 is available for 9" wide bowls and only HP2, HP3 and HP4 are available for 15", 18" and 21" wide bowls. In the case of double bowl sinks with a 9" wide bowl at the right or at the left, HP1 or HP5 may not be available.

ADA compliance



ADA compliant sinks are designed to make their use easier, more practical and comfortable for people with disabilities or limited mobility. By choosing this option, your bowl(s) depth becomes 6" and it leaves enough space underneath to allow for knee clearance.



Description	Option	Price
Bowl(s) depth 6"	ADA	Free

À la Carte options

Divider

For double bowl sinks, a standard divider is full height and 1" wide. If you would prefer something different, we offer three alternative types of dividers, each with its own specific functions.

1" wide, 1" from the top of the bowl (DV1)

This divider is designed to avoid spills because the water will drain into the other bowl before overflowing onto the counter.

1" wide, 3" from the top of the bowl (DV2)

This divider is perfect for washing large pots and pans because their handles will overhang into the other bowl. This type of divider makes going from one bowl to the other an easy transition.

4" wide, 3" from the top of the bowl (DV3)

This divider provides a resting place for pans that are very hot or being filled with water directly from the faucet. This type of divider makes going from one bowl to the other an easy transition.



Description	Option	Price
1" wide, 1" from the top of the bowl	DV1	\$ 650
1" wide, 3" from the top of the bowl	DV2	\$ 750
4" wide, 3" from the top of the bowl ⁽¹⁾	DV3	\$ 850

1. Please note that this type of divider will add 3" to the overall dimensions of your bowl, which will probably affect the size of your cabinet.

Built-in drainboard

Designed primarily to dry dishes without cluttering up the counter, the built-in drainboard can also be used as a work surface for cooking and cleaning. The drainboard is embossed for greater stability, and its dimension is adapted to the front-to-back dimensions of the bowl.

12" wide, left side (DB112)

18" wide, left side (DB118)

24" wide, left side (DB124)

12" wide, right side (DB212)

18" wide, right side (DB218)

24" wide, right side (DB224)

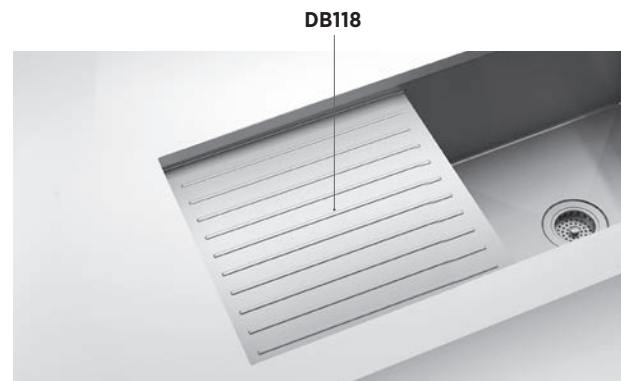
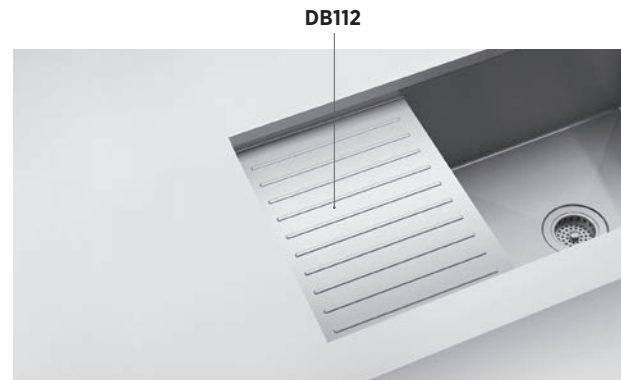

Description	Width	Option	Price
Left built-in drainboard	12"	DB112	\$ 825
	18"	DB118	\$ 925
	24"	DB124	\$ 1,025
Right built-in drainboard	12"	DB212	\$ 825
	18"	DB218	\$ 925
	24"	DB224	\$ 1,025

À la Carte options

Built-in drawer

A drawer built into the side of the bowl is the perfect place for storing small everyday cleaning items like brushes and scouring pads. The inside dimension, front to back, is 12". It is always installed 1½" from the top of the bowl.

Left wall (DW1)

Drawer in the left inner wall of the bowl

Right wall (DW2)

Drawer in the right inner wall of the bowl

DW2 (opened)



DW2 (closed)

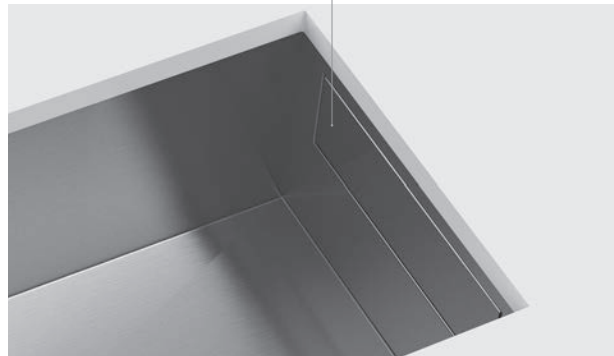

Description ⁽¹⁾⁽²⁾⁽³⁾	Option	Price
Left built-in drawer	DW1	\$ 525
Right built-in drawer	DW2	\$ 525

1. Please note that adding a drawer will add 3½" to the overall dimensions of your bowl, which will probably affect the size of your cabinet.
2. Due to the installation process of topmount sinks, it is not possible to add a built-in drawer when choosing the "Topmount/Flushmount" option. The only way to include a drawer on a topmount sink is to add a drainboard directly over it, on the same side.
3. When the ADA option is selected, it is not possible to add a built-in drawer.

Position of the drain(s)

This option lets you choose the drain position in the bowl. By default, the drain is in the rear center of the bowl (DP2). This is the position recommended by Home Refinements to maximize under-cabinet storage space and the flat surface area available at the bottom of the bowl. However, moving the drain to the following locations, while altering the style, will not sacrifice these benefits.

Rear left corner (DP1)

The center of DP1 is 4 ½" from the left inner wall and 4 ½" from the back inner wall of the bowl.

Rear right corner (DP3)

The center of DP3 is 4 ½" from the right inner wall and 4 ½" from the back inner wall of the bowl.

Center left (DP4)

The center of DP4 is 4 ½" from the left inner wall and is at the center of the front to back dimension of the bowl.

Center (DP5)

The center of DP5 is at the center of the bowl.

Center right (DP6)

The center of DP6 is 4 ½" from the right inner wall and is at the center of the front to back dimension of the bowl.

Center (DP55)

If you choose a double bowl sink, the default drain location is the center rear of the bowls. With this option, you can position them in the center of each bowl.

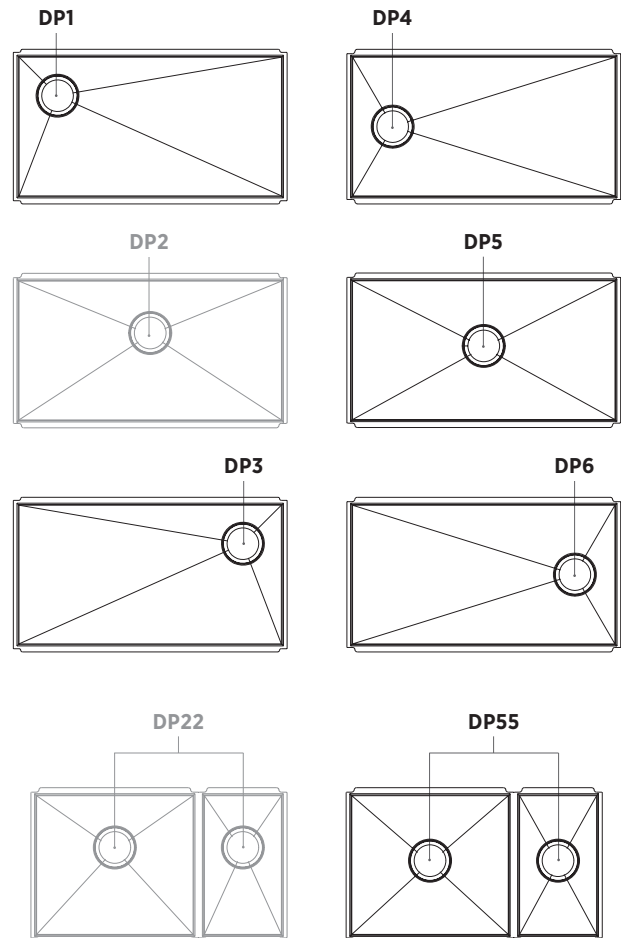

Description for single bowl ⁽¹⁾	Option	Price
Rear left corner of the bowl	DP1	\$ 200
Rear right corner of the bowl	DP3	\$ 200
Center left of the bowl	DP4	\$ 200
Center of the bowl	DP5	\$ 200
Center right of the bowl	DP6	\$ 200

Description for double bowl ⁽¹⁾	Option	Price
Center of the bowl	DP55	\$ 200

1. Please note that if you move the drain, the grid recommended for your sink will no longer fit properly. Contact customer service to order your custom grid.

À la Carte options

How to create your product number

An À la Carte product number is always composed of two types of information:

1. The model number of the chosen sink, taken from the standard collections, forms the basis for the number.
2. The code(s) referring to the various options added to the basic sink are set off by dashes.

Use this code to place your order.

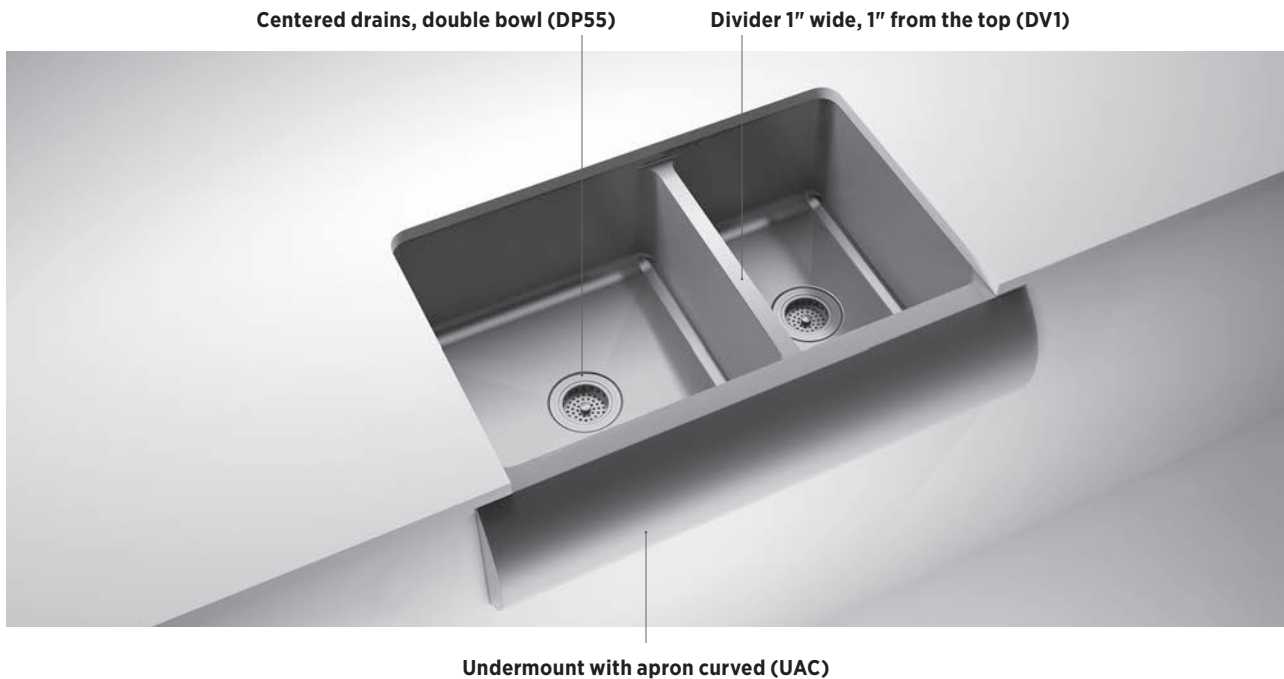
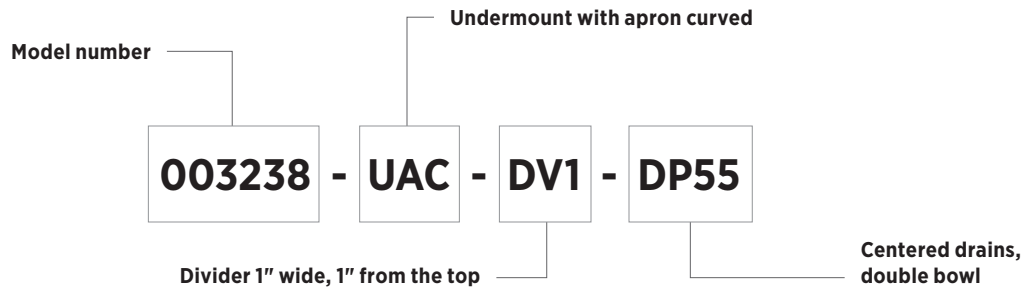

SIGNATURE



SIGNATURE

Custom stainless steel

As we've been working with stainless steel for 70 years for the world's most prestigious kitchens, we understand that some projects require creative and personalized solutions.

Through the Signature concept, we can manufacture custom stainless steel items for customers with unique needs and tastes. Looking for that special one-of-a-kind creation to perfectly match a new kitchen? Still haven't found the right product available on the market? Set your imagination free and design your very own Signature item.

To learn more about the Signature concept, visit our website.

homerefinelements.ca/signature

To request a quote, fill out the Signature forms available online or contact a member of our customer service department.

1 866 901-5624

customerservice@homerefinelements.ca

Signature sinks

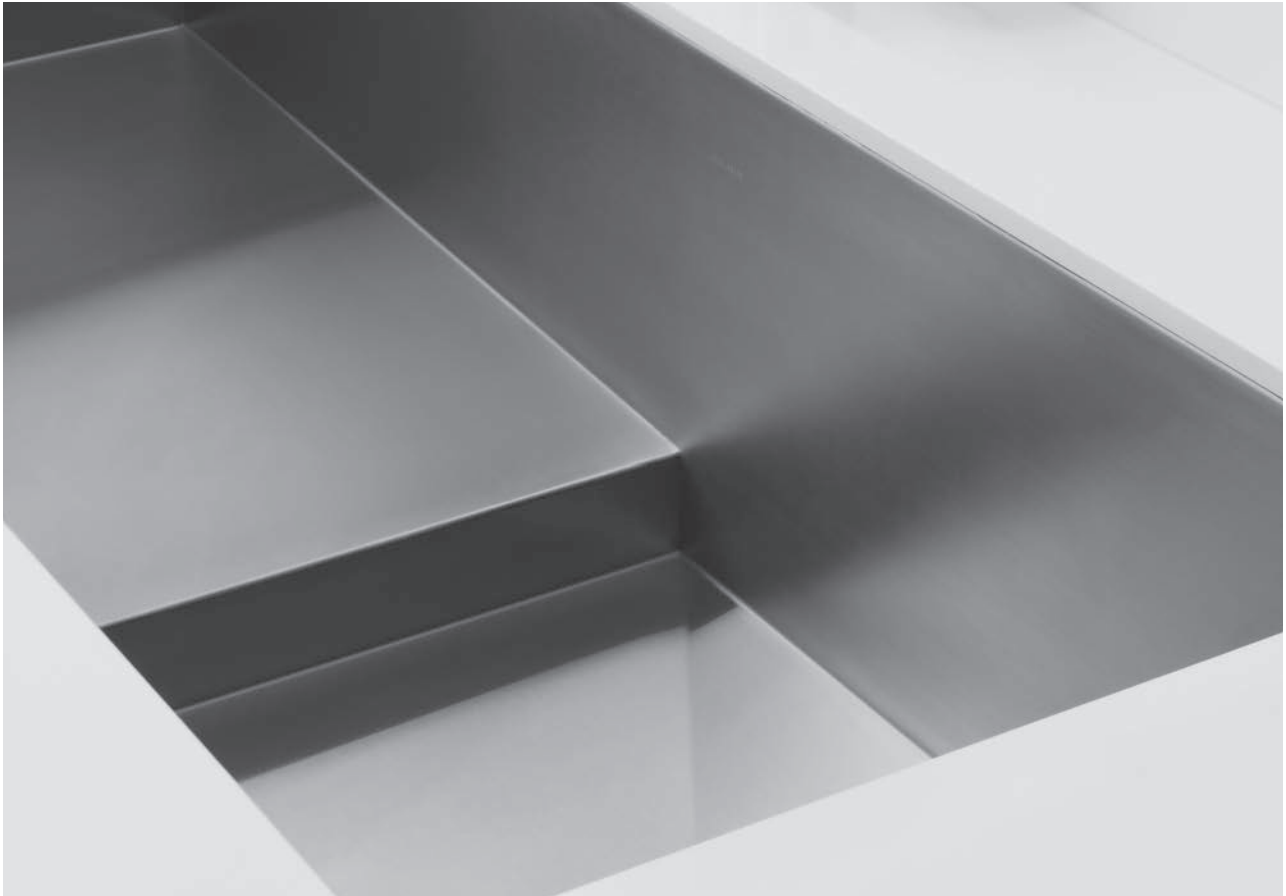

We design custom sinks for chefs with unique requirements, including original shapes, more than two bowls, non-standard dimensions, engraving and more. Looking for that special one-of-a-kind creation to complement your new kitchen? We can handcraft it for you in our plant in less than 4 weeks.

Signature countertops



Stainless steel is a preferred material for kitchen island counters. It has strong antibacterial properties, making it a very hygienic surface. What's more, hot pots can be placed on it without any risk.

Signature modules



By integrating a stainless steel module into your kitchen layout, you can enjoy a work surface inspired by top chefs. Custom-designed to your specifications, this unique item will fit perfectly with your décor.

Signature full kitchens



The professional-style kitchens put stainless steel in the foreground. Ease of maintenance and great anti-corrosion properties make this material a perfect fit for large restaurants and home kitchens alike. It can be fully integrated, from countertops to cabinet panels, drawers and, of course, the sink.

Other Signature items



Stainless steel can be shaped into a myriad of forms for use in a host of applications. Whether for a range hood, shelving, mantel-piece, railing... if it can be made of stainless steel, we can make it.

SMARTSTATION



NEW

SMARTSTATION

Functional in every way

The SmartStation sink with accessory ledge lets you slide your colander, cutting board, and drying rack from side to side along two levels, giving cooks the chance to flex their creative muscles. Available in black walnut or maple, the station comes with a sturdy stainless steel grid that protects the bottom surface.

Find out more at homerefinelements.ca/en/smartstation

Features

Handcrafted in Canada

Commercial quality stainless steel - 16 ga thickness

Corrosion resistant material - 304 series (18/10)

Unique design allowing the Home Refinements standard accessories to slide one over the other on two levels

½" accessory ledge on front and back of the bowl to accommodate any standard 17" Home Refinements accessory

Standard 18" Home Refinements accessories to be used directly on the countertop (undermount with overhang countertop installation necessary)

Three (3) accessories included, with a choice of maple or walnut handles: 17" drying rack to be used on accessory ledge and 18" cutting board and colander to be used on countertop

Bottom grid included to protect the surface of the sink

Attractive combination of UrbanEdge® and J7® collections : vertical square corners [0°] and slightly rounded corners [7mm] for bottom front and back folds

Environmentally friendly product, 100% recyclable

Elegant no. 4 brushed finish that matches the appliances

Highly efficient sound deadening pads

Practical flat sink bottom and straight bowl sides that maximize available space in the bowl

Stylish and functional bowl bottom grooves that facilitate water drainage

Rear or side ¾" drain placement

Mounting hardware included

Certifications: ASME A112.19.3, CSA B45.0, CSA B45.4

Kitchen sinks

Undermount installation

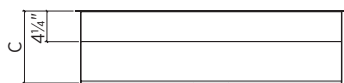
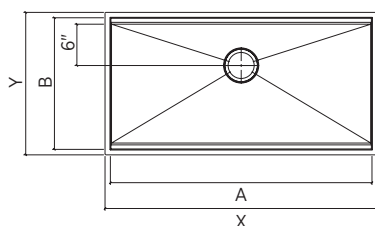
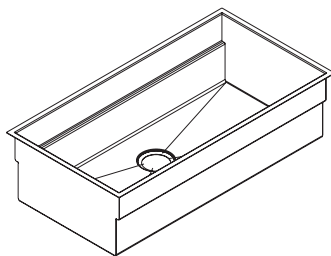

Cutting boards and accessories' handles:

(M): Maple
(W): Walnut

Cabinet 18"



Overall (X × Y)
13½" × 19⅝"

Sink 005400 (M)
Sink 005450 (W)

Bowl (A × B × C)
12" × 18" × 10"
\$ 1,900

Included



Grid
200930



Colander
205325 (M)
205225 (W)



Drying rack
215307 (M)
215207 (W)



Cutting board
210068 (M)
210067 (W)

Cabinet 30"

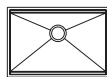

Overall (X × Y)
28½" × 19⅝"

Sink 005401 (M)
Sink 005451 (W)

Bowl (A × B × C)
27" × 18" × 10"
\$ 2,300

Included



Grid
200914



Colander
205325 (M)
205225 (W)



Drying rack
215307 (M)
215207 (W)



Cutting board
210068 (M)
210067 (W)

Cabinet 36"

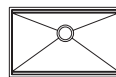

Overall (X × Y)
31½" × 19⅝"

Sink 005402 (M)
Sink 005452 (W)

Bowl (A × B × C)
30" × 18" × 10"
\$ 2,600

Included



Grid
200915



Colander
205325 (M)
205225 (W)



Drying rack
215307 (M)
215207 (W)



Cutting board
210068 (M)
210067 (W)

Cabinet 42"

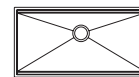

Overall (X × Y)
37½" × 19⅝"

Sink 005403 (M)
Sink 005453 (W)

Bowl (A × B × C)
36" × 18" × 10"
\$ 2,900

Included



Grid
200932



Colander
205325 (M)
205225 (W)



Drying rack
215307 (M)
215207 (W)



Cutting board
210068 (M)
210067 (W)

Available accessories

Visit the "ACCESSORIES - INOX" tab and choose any 17" bowl accessory to use with the in sink ledge or any 18" bowl accessory to use on the countertop. (undermount installation with countertop overhang necessary)

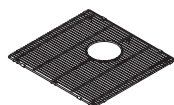

Grid(s)
Included

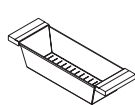

Colander 6" x 4¼"
Included

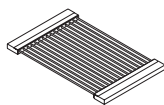

Drying rack
Included

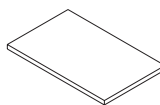

Cutting board
Included

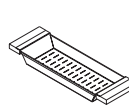

Colander 6" x 2¼"
\$ 220

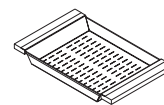

Colander 12" x 2¼"
\$ 265

Custom cabinet

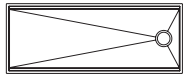

Overall (X × Y)
49½" × 19⅝"

Sink 005404 (M)
Sink 005454 (W)

Bowl (A × B × C)
48" × 18" × 10"
\$ 3,500

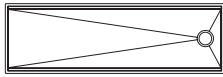

Overall (X × Y)
61½" × 19⅝"

Sink 005405 (M)
Sink 005455 (W)

Bowl (A × B × C)
60" × 18" × 10"
\$ 4,100

Included



Grids
200927
200929



Colander
205325 (M)
205225 (W)



Drying rack
215307 (M)
215207 (W)



Cutting board
210068 (M)
210067 (W)

Included



Grids
200927
200928



Colander
205325 (M)
205225 (W)



Drying rack
215307 (M)
215207 (W)



Cutting board
210068 (M)
210067 (W)

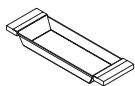

Tray 6" x 2¾"
\$ 220

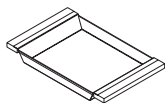

Tray 12" x 2¾"
\$ 265

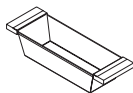

Bin 6" x 4¾"
\$ 245



VeggieScoop
\$ 75

Kitchen sinks

Undermount installation

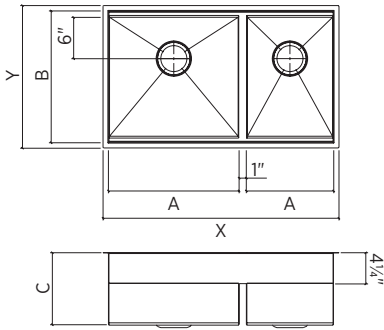
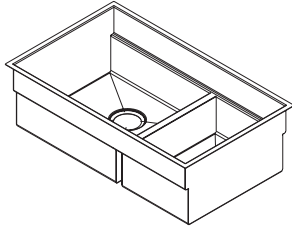

Cutting boards and accessories' handles:

(M): Maple
(W): Walnut

Cabinet 36"

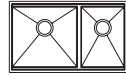

Overall (X × Y)
32½" × 19⅝"

Sink 005406 (M) Sink 005456 (W)

Bowl (A × B × C)
L 18" × 18" × 10"
R 12" × 18" × 10"
\$ 4,500

Included



Grids
200931 (L)
200930 (R)



Colander
205325 (M)
205225 (W)



Drying rack
215307 (M)
215207 (W)



Cutting board
210068 (M)
210067 (W)

Custom cabinet

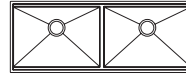

Overall (X × Y)
50½" × 19⅝"

Sink 005407 (M) Sink 005457 (W)

Bowl (A × B × C)
L 24" × 18" × 10"
R 24" × 18" × 10"
\$ 4,900

Included



Grids
200913 (L)
200913 (R)



Colander
205325 (M)
205225 (W)



Drying rack
215307 (M)
215207 (W)



Cutting board
210068 (M)
210067 (W)

Available accessories

Visit the "ACCESSORIES - INOX" tab and choose any 17" bowl accessory to use with the in sink ledge or any 18" bowl accessory to use on the countertop. (undermount installation with countertop overhang necessary)

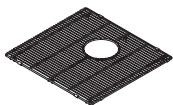

Grid(s)
Included

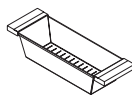

Colander 6" x 4¼"
Included

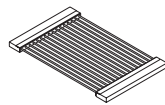

Drying rack
Included

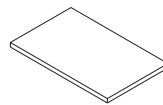

Cutting board
Included

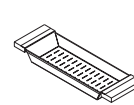

Colander 6" x 2¾"
\$ 220

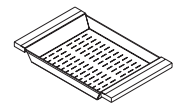

Colander 12" x 2¾"
\$ 265

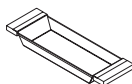

Tray 6" x 2³/₄"
\$ 220

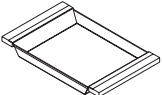

Tray 12" x 2³/₄"
\$ 265

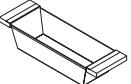

Bin 6" x 4³/₄"
\$ 245



VeggieScoop
\$ 75

À la carte SmartStation

SmartStation is the first and only special collection sink designed to accommodate some of our À la Carte options. You can make a sink even more functional by adding one or more options described in this section. For more information on any option, visit the "À LA CARTE - INOX" tab or pull out the tool at the end of this document. You can also see a drawing of your customized sink by using our online configuration tool at homerefine-ments.ca/configurator

Built-in drainboard

Perfect for drying the dishes without cluttering your counter or for washing and prepping ingredients, the integrated drainboard frees up extra working space.



Built-in drawer

Brushes, cleaning pads, and other cleaning supplies have a new place to hide: a clever built-in sink drawer.



Position of the drain(s)⁽¹⁾⁽²⁾

By moving the position of the drain, you can adjust the storage space under the sink area and the flat surface available at the bottom of the bowl.

1. In order to ensure optimal drainage, this option is not available on 48" (005404 / 005454) and 60" (005405 / 005455) SmartStation sinks.
2. The standard grid included with your sink will not be adapted to your new drain configuration. Please contact Julien's Customer Service to order a custom grid.

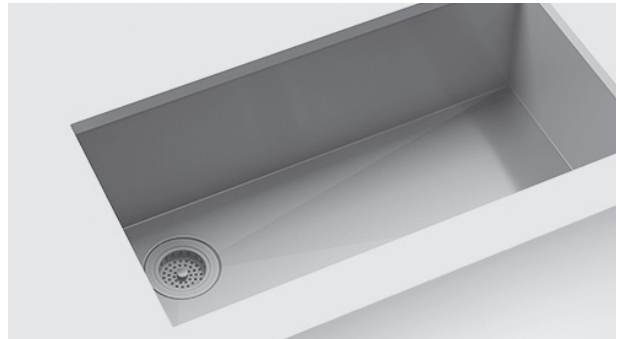

SmartStation Signature

Maybe you like the SmartStation sink but would like to make a few adjustments, like a larger divider or a deeper basin. Or maybe you'd like your SmartStation integrated into a stainless steel counter.

Bring your ideas to life by contacting our Customer Service team or filling out the form available at homerefine-ments.ca/en/signature



SPECIAL

SocialCorner • Vintage • Classic +



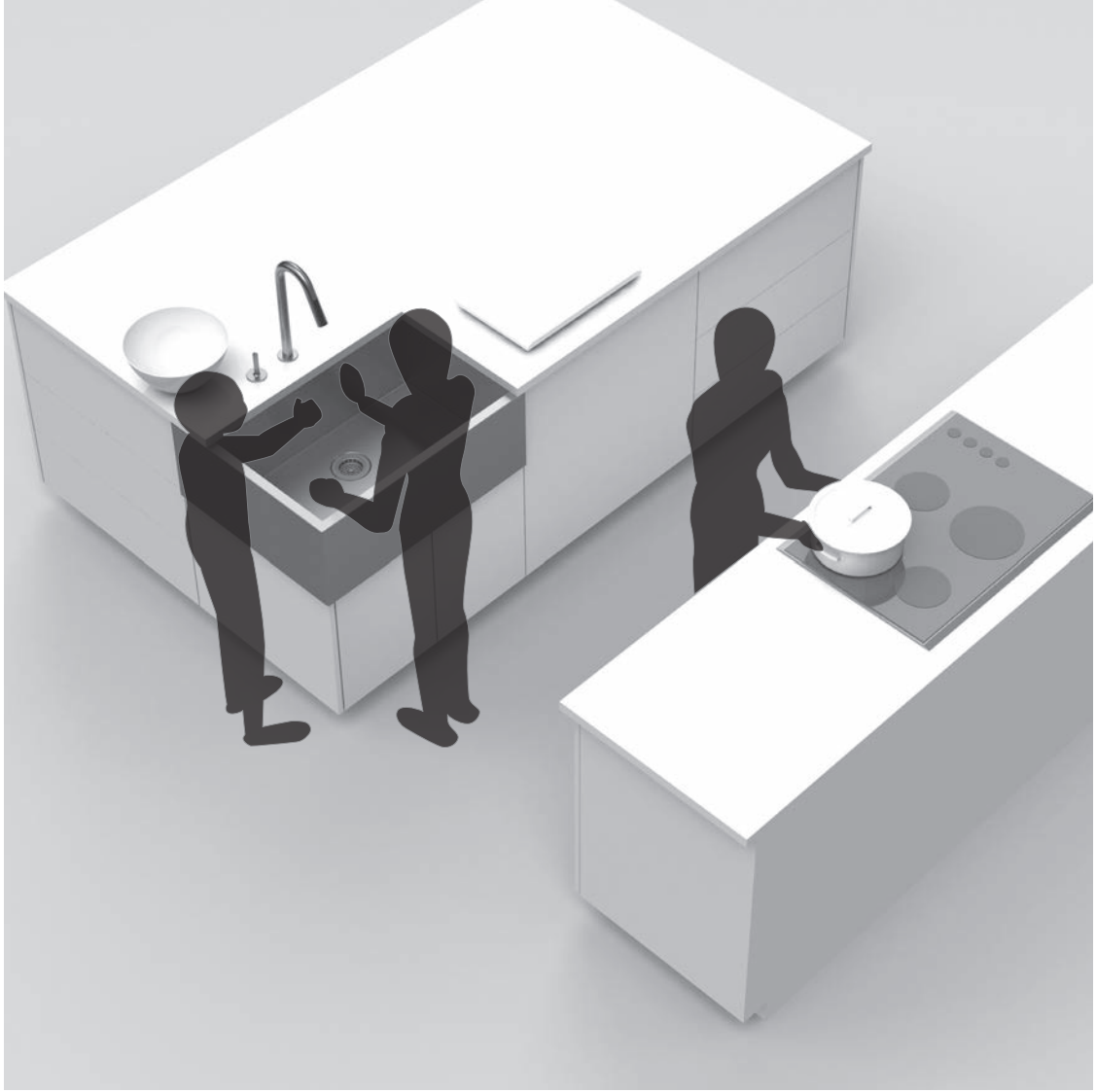

SOCIALCORNER

The cornerstone of your kitchen

These sinks maximize available work space on the countertop thanks to their corner installation on the kitchen island. The two distinct work areas provided by the stainless steel aprons on the front and side of the sink encourage interaction between users and improve work flow in the room by freeing up space designated for cooking, for example.

Features

Designed by Matthew Quinn

Handcrafted in Canada

Commercial quality stainless steel - 16 ga thickness

Corrosion resistant material - 304 series (18/10)

Environmentally friendly product, 100% recyclable

Elegant no. 4 brushed finish that matches the appliances

Unique island corner installation to allow two people to work at the sink at the same time

Designed for left or right corner installation

Highly efficient sound deadening pads

Practical flat sink bottom and straight bowl sides that maximize available space in the bowl

Stylish and functional bowl bottom grooves that facilitate water drainage

Rear 3½" drain placement

Mounting hardware included

Certifications: ASME A112.19.3, CSA B45.0, CSA B45.4

Kitchen sinks

Undermount installation with flat aprons

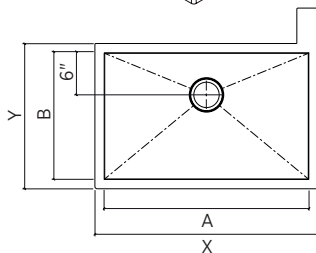
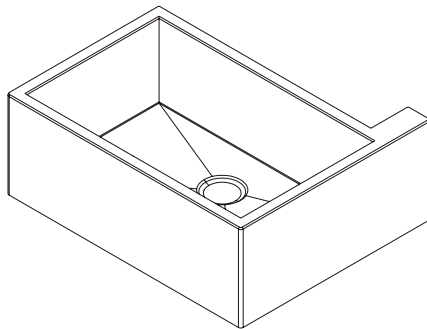
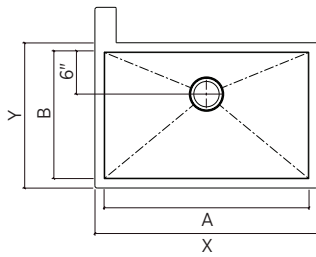
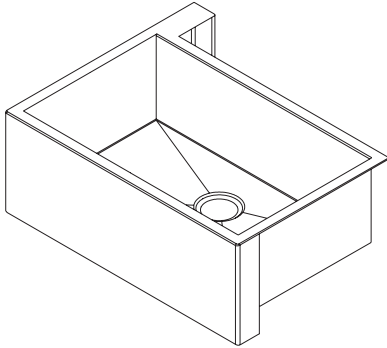

Installation on left corner of kitchen island

Cabinet 24"



Overall (X×Y×Z)
25½" × 25½" × 11¾"

Sink 005300

Bowl (A × B × C)
23" × 18" × 10"
\$ 2,750

Grid 200933

\$ 260

Cabinet 30"

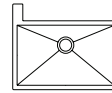

Overall (X×Y×Z)
31½" × 25½" × 11¾"

Sink 005302

Bowl (A × B × C)
29" × 18" × 10"
\$ 2,800

Grid 200934

\$ 280

Cabinet 36"

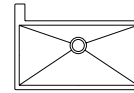

Overall (X×Y×Z)
37½" × 25½" × 11¾"

Sink 005304

Bowl (A × B × C)
35" × 18" × 10"
\$ 2,900

Grid 200935

\$ 300

Installation on right corner of kitchen island

Cabinet 24"



Overall (X×Y×Z)
25½" × 25½" × 11¾"

Sink 005301

Bowl (A × B × C)
23" × 18" × 10"
\$ 2,750

Grid 200933

\$ 260

Cabinet 30"

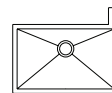

Overall (X×Y×Z)
31½" × 25½" × 11¾"

Sink 005303

Bowl (A × B × C)
29" × 18" × 10"
\$ 2,800

Grid 200934

\$ 280

Cabinet 36"

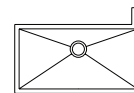

Overall (X×Y×Z)
37½" × 25½" × 11¾"

Sink 005305

Bowl (A × B × C)
35" × 18" × 10"
\$ 2,900

Grid 200935

\$ 300

VINTAGE

Retro-chic style

Skillfully combining traditional and modern styling, these sinks feature square corners that complement the rounded shape of the bowl.

Features

Handcrafted in Canada

Commercial quality stainless steel - 16 ga thickness

Corrosion resistant material - 304 series (18/10)

Environmentally friendly product, 100% recyclable

Elegant no. 4 brushed finish that matches the appliances

Highly efficient sound deadening pads

Practical flat sink bottom and straight bowl sides that maximize available space in the bowl

Stylish and functional bowl bottom grooves that facilitate water drainage

Rear 3½" drain placement

Mounting hardware and cutout template included

Certifications: ASME A112.19.3, CSA B45.0, CSA B45.4

Kitchen sinks

Undermount installation

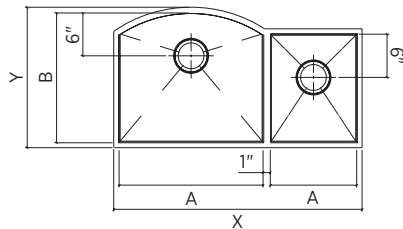
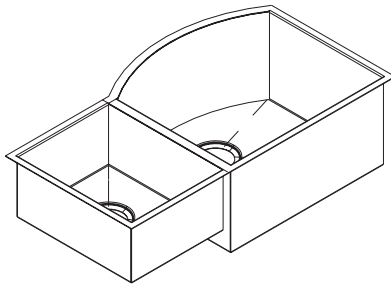
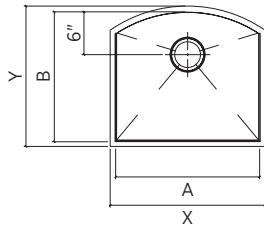
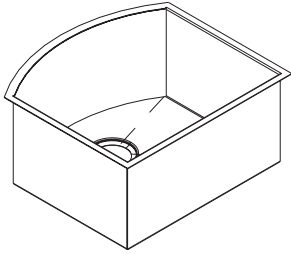

Cabinet 27"



Overall (X × Y)
21½" × 19½"

Sink 003505

Bowl (A × B × C)
20" × 18" × 8"
\$ 1,759

Sink 003500

Bowl (A × B × C)
20" × 18" × 10"
\$ 1,770

Grid 200901

\$ 237

Cabinet 36"

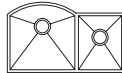

Overall (X × Y)
32½" × 19½"

Sink 003502

Bowl (A × B × C)
L 18" × 18" × 10"
R 12" × 15" × 7"
\$ 2,745

Grid 200900 (L)

\$ 232

Grid 200925 (R)

\$ 195

Cabinet 39"

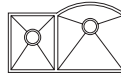

Overall (X × Y)
32½" × 19½"

Sink 003501

Bowl (A × B × C)
L 12" × 15" × 7"
R 18" × 18" × 10"
\$ 2,745

Grid 200925 (L)

\$ 195

Grid 200900 (R)

\$ 232

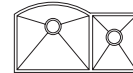

Overall (X × Y)
34½" × 19½"

Sink 003504

Bowl (A × B × C)
L 20" × 18" × 10"
R 12" × 15" × 7"
\$ 2,768

Grid 200901 (L)

\$ 237

Grid 200925 (R)

\$ 195

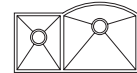

Overall (X × Y)
34½" × 19½"

Sink 003503

Bowl (A × B × C)
L 12" × 15" × 7"
R 20" × 18" × 10"
\$ 2,768

Grid 200925 (L)

\$ 195

Grid 200901 (R)

\$ 237

CLASSIC +

Enhanced style

Available in farmhouse or worktop configurations, with or without drawers, sinks in the Classic + collection are more than just sinks - they're unique design pieces.

Features

Handcrafted in Canada

Commercial quality stainless steel - 16 ga thickness

Corrosion resistant material - 304 series (18/10)

Environmentally friendly product, 100% recyclable

Elegant no. 4 brushed finish that matches the appliances

Highly efficient sound deadening pads

Practical flat sink bottom and straight bowl sides that maximize available space in the bowl

Stylish and functional bowl bottom grooves that facilitate water drainage

Integrated 1 $\frac{3}{8}$ " faucet hole

Rear 3 $\frac{1}{2}$ " drain placement

Mounting hardware included

Certifications: ASME A112.19.3, CSA B45.0, CSA B45.4

Kitchen sinks

Farmhouse installation

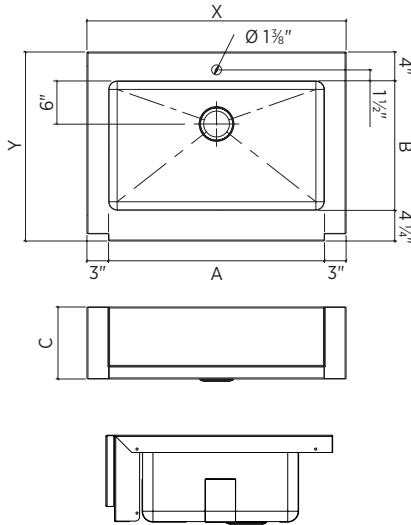
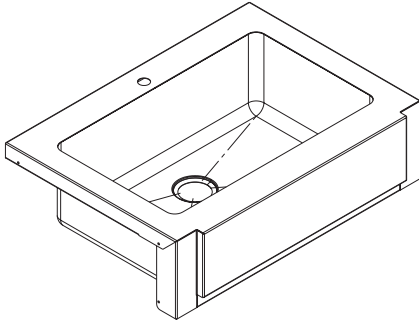

Cabinet 30"



Overall (X × Y)
30" × 26¼"

Cabinet 36"

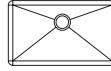

Overall (X × Y)
36" × 26¼"

Cabinet 42"

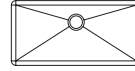

Overall (X × Y)
42" × 26¼"

Sink 000120

Bowl (A × B × C)
24" × 18" × 10"
\$ 2,550

Sink 000110

Bowl (A × B × C)
30" × 18" × 10"
\$ 2,592

Sink 000100

Bowl (A × B × C)
36" × 18" × 10"
\$ 2,675

Grid 200919

\$ 255

Grid 200921

\$ 290

Grid 200923

\$ 310

Kitchen sinks

Farmhouse installation

CLASSIC+

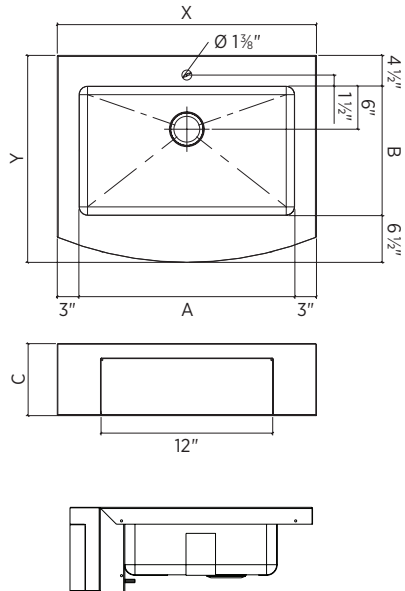
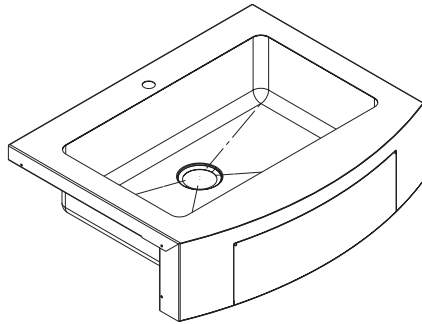

Cabinet 30"



Overall (X × Y)
30" × 28³/₄"

Sink 000161

Bowl (A × B × C)
24" × 18" × 8"
\$ 3,814

Cabinet 36"

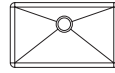

Overall (X × Y)
36" × 28³/₄"

Sink 000151

Bowl (A × B × C)
30" × 18" × 8"
\$ 3,867

Cabinet 42"

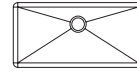

Overall (X × Y)
42" × 28³/₄"

Sink 000171

Bowl (A × B × C)
36" × 18" × 8"
\$ 3,950

Grid 200919

\$ 255

Grid 200921

\$ 290

Grid 200923

\$ 310

Kitchen sinks

Farmhouse installation

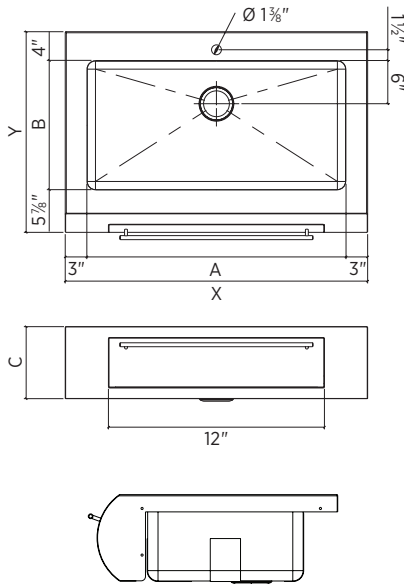
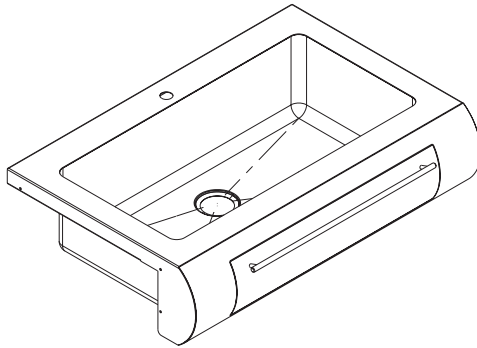

Cabinet 30"

Cabinet 36"

Cabinet 42"

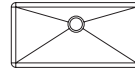
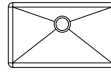

Overall (X × Y)
30" × 27⁷/₈"

Overall (X × Y)
36" × 27⁷/₈"

Overall (X × Y)
42" × 27⁷/₈"

Sink 000210

Bowl (A × B × C)
24" × 18" × 10"
\$ 3,720

Sink 000201

Bowl (A × B × C)
30" × 18" × 10"
\$ 3,762

Sink 000221

Bowl (A × B × C)
36" × 18" × 10"
\$ 3,846

Grid 200919

\$ 255

Grid 200921

\$ 290

Grid 200923

\$ 310

Kitchen sinks

Worktop installation

CLASSIC+

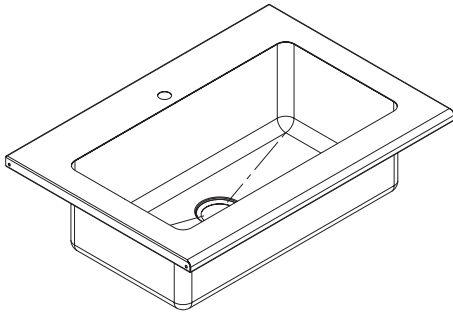

Cabinet 36"

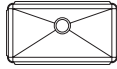

Overall (X × Y)
36" × 25¼"

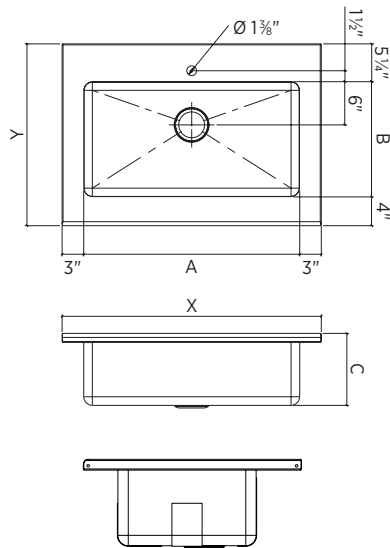

Sink 000253

Bowl (A × B × C)
30" × 16" × 10"
\$ 2,595

Grid 200909

\$ 280

ACCESSORIES

Stainless steel



ACCESSORIES

For stainless steel sinks

A sink is a lot more than a bowl to hold water. With the right accessories, it can become a real workstation. Take a look at our product offering to create additional workspace and improve efficiency in the kitchen.

Grids

Our solid stainless steel grids are all custom made to fit our sinks. By perfectly covering the bottom of the bowl, they provide effective protection against scrapes and early wear while allowing water to drain when items sit at the bottom of the sink.

Colanders, trays and bins

Our colanders, trays and bins are hand manufactured from tough stainless steel for greater durability. Placed on the counter or suspended above the sink, they are invaluable tools for straining, rinsing or serving food efficiently and hygienically.

Drying racks

Our drying racks can sit right over the sink to dry kitchen items or to rinse food. They can also be used on the counter as trivets.

Cutting boards

Our hardwood cutting boards provide extra work space and can double as trivets or serving platters.

Drains

Our drains come in a range of design options to match your kitchen and the style of your sink. All our drain strainers are removable for easy cleaning.

Care products and replacement parts

To preserve the finish of Home Refinements stainless steel sinks and accessories or to ensure proper installation, products and parts we recommend are essential.

Grids

For stainless steel sinks – Standard collections

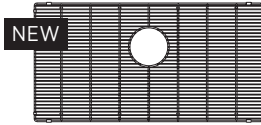

Collection	Drain	Bowl	Grid	Price
UrbanEdge®, J7®, Classic	Center	9" × 16"	200902	\$ 190
		12" × 12"	200924	\$ 190
		12" × 15"	200925	\$ 195
		12" × 16"	200903	\$ 200
		15" × 15"	200926	\$ 205
		15" × 16"	200904	\$ 210
		15" × 18"	200916	\$ 215
		18" × 16"	200905	\$ 220
		18" × 18"	200917	\$ 230
		21" × 16"	200906	\$ 230
		21" × 17"	200912	\$ 235
		21" × 18"	200918	\$ 245
		24" × 16"	200907	\$ 250
		24" × 17"	200913	\$ 250
		24" × 18"	200919	\$ 255
		27" × 16"	200908	\$ 265
		27" × 17"	200914	\$ 270
		27" × 18"	200920	\$ 275
		30" × 16"	200909	\$ 280
		30" × 17"	200915	\$ 285
30" × 18"	200921	\$ 290		
33" × 16"	200910	\$ 290		
33" × 18"	200922	\$ 300		
36" × 16"	200911	\$ 300		
36" × 18"	200923	\$ 310		

- Ideal for rinsing or draining food, or simply protecting the sink surface from scratching
- Rubber-tipped footings for better stability and protection
- Rubber protectors on all corners to protect from scratching bowl sides
- Corrosion resistant and 304 series stainless steel (18/10)

Grids

For stainless steel sinks – SmartStation

ACCESSORIES

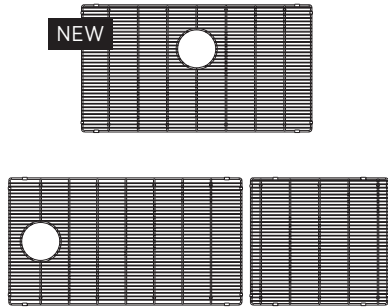

Collection	Drain	Bowl	Grid	Price
SmartStation	Center	12" × 17"	200930	\$ 205
		18" × 17"	200931	\$ 225
		24" × 17"	200913	\$ 250
		27" × 17"	200914	\$ 270
		30" × 17"	200915	\$ 285
		36" × 17"	200932	\$ 295
	Left or right	48" × 17"	200927 &	\$ 285
			200929*	\$ 225
		60" × 17"	200927 &	\$ 285
			200928*	\$ 285

*These grids come in two sections in order to fit the extra long basin.

- Ideal for rinsing or draining food, or simply protecting the sink surface from scratching
- Rubber-tipped footings for better stability and protection
- Rubber protectors on all corners to protect from scratching bowl sides
- Corrosion resistant and 304 series stainless steel (18/10)

Grids

For stainless steel sinks – Special collections

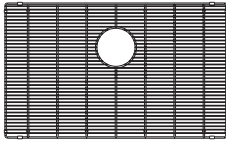

Collection	Drain	Bowl	Grid	Price
SocialCorner	Center	23" × 18"	200933	\$ 260
		29" × 18"	200934	\$ 280
		35" × 18"	200935	\$ 300

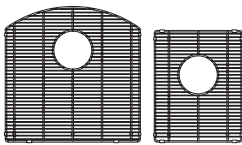

Collection	Drain	Bowl	Grid	Price
Vintage	Center	18" × 18"	200900	\$ 232
		20" × 18"	200901	\$ 237
	Center	12" × 15"	200925	\$ 195

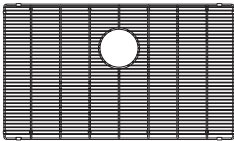

Collection	Drain	Bowl	Grid	Price
Classic +	Center	24" × 18"	200919	\$ 255
		30" × 16"	200909	\$ 280
		30" × 18"	200921	\$ 290
		36" × 18"	200923	\$ 310

- Ideal for rinsing or draining food, or simply protecting the sink surface from scratching
- Rubber-tipped footings for better stability and protection
- Rubber protectors on all corners to protect from scratching bowl sides
- Corrosion resistant and 304 series stainless steel (18/10)

Colanders

For stainless steel sinks

ACCESSORIES

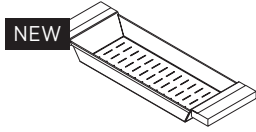

Handles	Bowl (front-to-back)	Dimensions	Colander	Price
Maple (M)	16"	6" x 17" x 2 1/4"	205317	\$ 220
	17"	6" x 18" x 2 1/4"	205318	\$ 220
	18"	6" x 19" x 2 1/4"	205319	\$ 220
Walnut (W)	16"	6" x 17" x 2 1/4"	205217	\$ 220
	17"	6" x 18" x 2 1/4"	205218	\$ 220
	18"	6" x 19" x 2 1/4"	205219	\$ 220

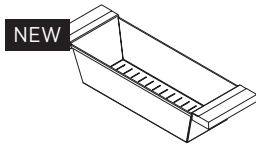

Handles	Bowl (front-to-back)	Dimensions	Colander	Price
Maple (M)	16"	6" x 17" x 4 1/4"	205323	\$ 245
	17"	6" x 18" x 4 1/4"	205324	\$ 245
	18"	6" x 19" x 4 1/4"	205325	\$ 245
Walnut (W)	16"	6" x 17" x 4 1/4"	205223	\$ 245
	17"	6" x 18" x 4 1/4"	205224	\$ 245
	18"	6" x 19" x 4 1/4"	205225	\$ 245

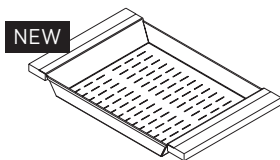

Handles	Bowl (front-to-back)	Dimensions	Colander	Price
Maple (M)	16"	12" x 17" x 2 1/4"	205329	\$ 265
	17"	12" x 18" x 2 1/4"	205330	\$ 265
	18"	12" x 19" x 2 1/4"	205331	\$ 265
Walnut (W)	16"	12" x 17" x 2 1/4"	205229	\$ 265
	17"	12" x 18" x 2 1/4"	205230	\$ 265
	18"	12" x 19" x 2 1/4"	205231	\$ 265

- Can be used on top of sink to create extra workspace or on countertop
- Ideal to rinse food or to dry dishes
- Innovative and functional design to match with other standard Home Refinements accessories
- 100% premium maple or walnut handles for high quality and durability
- Rubber-tipped footings for better stability and protection
- 304 series stainless steel (18/10)
- Elegant no. 4 brushed finish that matches the appliances

Trays

For stainless steel sinks

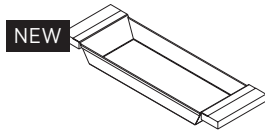

Handles	Bowl (front-to-back)	Dimensions	Tray	Price
Maple (M)	16"	6" × 17" × 2 1/4"	205320	\$ 220
	17"	6" × 18" × 2 1/4"	205321	\$ 220
	18"	6" × 19" × 2 1/4"	205322	\$ 220
Walnut (W)	16"	6" × 17" × 2 1/4"	205220	\$ 220
	17"	6" × 18" × 2 1/4"	205221	\$ 220
	18"	6" × 19" × 2 1/4"	205222	\$ 220

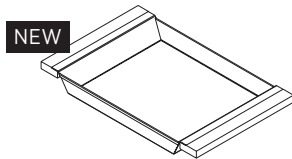

Handles	Bowl (front-to-back)	Dimensions	Tray	Price
Maple (M)	16"	12" × 17" × 2 1/4"	205332	\$ 265
	17"	12" × 18" × 2 1/4"	205333	\$ 265
	18"	12" × 19" × 2 1/4"	205334	\$ 265
Walnut (W)	16"	12" × 17" × 2 1/4"	205232	\$ 265
	17"	12" × 18" × 2 1/4"	205233	\$ 265
	18"	12" × 19" × 2 1/4"	205234	\$ 265

- Can be used on top of sink to create extra workspace or on countertop
- Ideal to prepare or to serve food
- Innovative and functional design to match with other standard Home Refinements accessories
- 100% premium maple or walnut handles for high quality and durability
- Rubber-tipped footings for better stability and protection
- 304 series stainless steel (18/10)
- Elegant no. 4 brushed finish that matches the appliances

Bins

For stainless steel sinks

ACCESSORIES

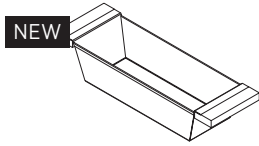

Handles	Bowl (front-to-back)	Dimensions	Bin	Price
Maple (M)	16"	6" × 17" × 4 1/4"	205326	\$ 245
	17"	6" × 18" × 4 1/4"	205327	\$ 245
	18"	6" × 19" × 4 1/4"	205328	\$ 245
Walnut (W)	16"	6" × 17" × 4 1/4"	205226	\$ 245
	17"	6" × 18" × 4 1/4"	205227	\$ 245
	18"	6" × 19" × 4 1/4"	205228	\$ 245

- Can be used on top of sink to create extra workspace or on countertop
- Ideal to prepare or to serve food
- Innovative and functional design to match with other standard Home Refinements accessories
- 100% premium maple or walnut handles for high quality and durability
- Rubber-tipped footings for better stability and protection
- 304 series stainless steel (18/10)
- Elegant no. 4 brushed finish that matches the appliances

Drying racks

For stainless steel sinks

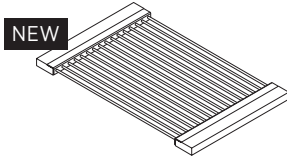

Handles	Bowl (front-to-back)	Dimensions	Rack	Price
Maple (M)	16"	12" × 17" × 1"	215306	\$ 280
	17"	12" × 18" × 1"	215307	\$ 280
	18"	12" × 19" × 1"	215308	\$ 280
Walnut (W)	16"	12" × 17" × 1"	215206	\$ 280
	17"	12" × 18" × 1"	215207	\$ 280
	18"	12" × 19" × 1"	215208	\$ 280

- Can be used on top of sink to create extra workspace or on countertop
- Ideal to rinse food or to dry dishes
- Innovative and functional design to match with other standard Home Refinements accessories
- 100% premium maple or walnut handles for high quality and durability
- 304 series stainless steel (18/10)
- Elegant no. 4 brushed finish that matches the appliances

Cutting boards

For stainless steel sinks

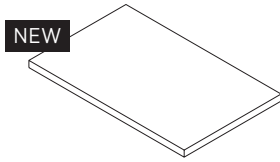

ACCESSORIES

Wood	Bowl (front-to-back)	Dimensions	Board	Price
Maple (M)	16"	12" × 17" × 1½"	210064	\$ 260
	17"	12" × 18" × 1½"	210066	\$ 260
	18"	12" × 19" × 1½"	210068	\$ 260
Walnut (W)	16"	12" × 17" × 1½"	210063	\$ 260
	17"	12" × 18" × 1½"	210065	\$ 260
	18"	12" × 19" × 1½"	210067	\$ 260

- Can be used on top of sink to create extra workspace or on countertop
- Innovative and functional design to match with other standard Home Refinements accessories
- 100% premium maple or walnut for high quality and durability
- Penetrating oil finish
- Safe for all food preparation

VeggieScoop

For cutting board



Handle	Bowl (front-to-back)	Dimensions	Scoop	Price
Maple (M)	-	6" × 8" × 2¼"	205338	\$ 75
Walnut (W)	-	6" × 8" × 2¼"	205238	\$ 75

- Ideal to serve and gather food on cutting boards
- Innovative and functional design to match with other standard Home Refinements accessories
- 100% premium maple or walnut handle for high quality and durability
- 304 series stainless steel (18/10)
- Elegant no. 4 brushed finish that matches the appliances

Drains

For stainless steel sinks

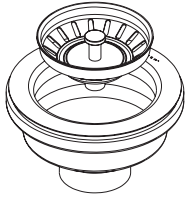

Diameter	Finish	Drain	Price
3 1/2"	Stainless steel	100056	\$ 31

- Stainless steel and plastic construction
- Removable stainless steel basket strainer
- 1 1/2" diameter and 4" long tailpiece included
- Available in one finish
- Fits standard 3 1/2" diameter drain opening
- Fits stainless steel sinks

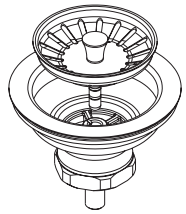

Diameter	Finish	Drain	Price
3 1/2"	Brushed nickel	100080	\$ 133
	Polished chrome	100081	\$ 99

- Solid brass construction
- Removable stainless steel basket strainer
- Available in two finishes
- Fits standard 3 1/2" diameter drain opening
- Fits stainless steel sinks and fireclay sinks up to 2" thick

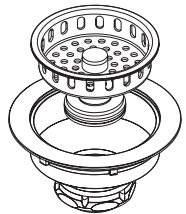

Diameter	Finish	Drain	Price
3 1/2"	Brushed nickel	100082	\$ 133
	Polished chrome	100083	\$ 99

- Solid brass construction
- Removable deep basket strainer
- Available in two finishes
- Fits standard 3 1/2" diameter drain opening
- Fits stainless steel sinks

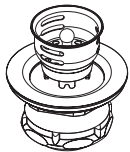

Diameter	Finish	Drain	Price
2"	Brushed nickel	100085	\$ 99
	Polished chrome	100086	\$ 78

- Solid brass construction
- Removable basket strainer
- Available in two finishes
- Fits standard 2" diameter drain opening
- Fits stainless steel sinks

Care products

For stainless steel sinks

ACCESSORIES



Description	Volume / unit	Qty	Product	Price
Stainless steel Cleaner	473 ml (16 fl. oz.)	1	215015	\$ 23
Stainless steel Cleaner	473 ml (16 fl. oz.)	6	215017	\$ 125

- Oil free, water-based
- Removes residues and stains
- Can also be used on stainless steel appliances

Stainless steel Polish	473 ml (16 fl. oz.)	1	215016	\$ 25
Stainless steel Polish	473 ml (16 fl. oz.)	6	215018	\$ 135

- Oil free, water-based
- Leaves a brilliant protective gloss
- Can also be used on stainless steel appliances



Description	Volume / unit	Qty	Product	Price
Maintenance wax for wood	70 g (2,5 fl. oz.)	1	215019	\$ 35

- Apply regularly on wooden kitchen accessories to restore moisture
- Contains beeswax, carnauba wax and bran rice oil
- Mineral oil free
- Available in 2,5 oz (70 g) container

Replacement parts

For stainless steel sinks

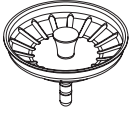

Description	Finish	Drain	Price
Basket strainer	Brushed nickel	100132	\$ 65
	Polished chrome	100133	\$ 50

- Replacement basket strainer for drain # 100080 and # 100081
- Available in two finishes

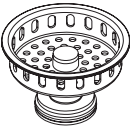

Description	Finish	Drain	Price
Basket strainer	Brushed nickel	100134	\$ 65
	Polished chrome	100135	\$ 50

- Replacement basket strainer for drain # 100082 and # 100083
- Available in two finishes

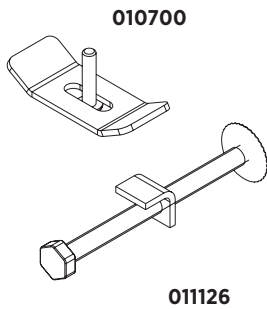

Description	Installation type	Qty	Part	Price
Mounting hardware	Undermount	5	010700	\$ 20
Mounting hardware	Topmount	5	011126	\$ 20

- Mounting hardware
- For undermount/topmount installation

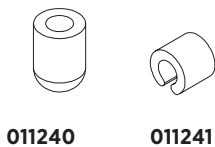

Description	Qty	Part	Price
Rubber-tipped footings	8	011240	\$ 20

- Protect from scratching the bottom of the sink
- Improve the stability of the grid

Rubber corner protectors	8	011241	\$ 20
--------------------------	---	---------------	-------

- Protect from scratching bowl sides

FIRA



NEW

FIRA

Timeless appeal

Our Fira fireclay sinks have a reversible apron front that's flat on one side and finished in Shaker style on the other, making them a perfect fit for contemporary and transitional interiors alike. To free up more counter space, choose one of the two Fira models with an accessory ledge and place a colander, drying rack, or the walnut cutting board that is included with the sink right on top of the basin.

Features

Designed in Canada, handcrafted in Italy

Two (2) sink models, 093319 and 091519, have an integrated accessory ledge that can be used with a full range of accessories, including the walnut cutting board that comes with the sink.

Reversible apron front design: flat or Shaker style

Deep 10" bowl and $\frac{3}{4}$ " thick walls for optimized work space

Product dimensional variability $\pm\frac{3}{16}$ ", due to manufacturing process

Made of fireclay and glazed on all sides, white gloss finish

Offset center $3\frac{1}{2}$ " drain

Sloped bottom for maximized drainage

Waste disposal unit compatible, recommended to confirm waste disposal or drain maximal thickness specifications

No template provided, recommended to have the sink on hand for final sizing of cabinet and countertop

ASME A112.19.2/CSA B45.1

Kitchen sinks with ledge

Undermount installation with apron

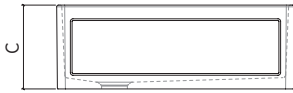
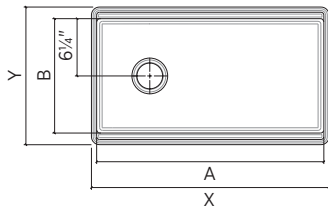
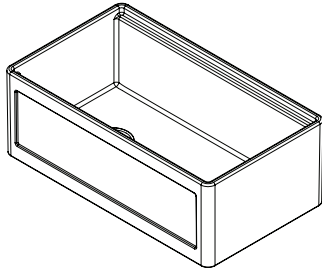

Cabinet 36"



Overall (X × Y)*
32³/₄" × 19"

Sink 093319

Bowl (A × B × C)*
31¹/₄" × 15³/₄" × 10"
\$ 1,625

Included



Cutting board
210060

Grid 200939

\$ 280

*Dimensions can
vary ±³/₁₆"

Available accessories

Visit the "ACCESSORIES - FIRECLAY" tab to enhance the functionality of your sink by choosing the right accessories to be used on the sink's ledge or the countertop.

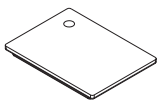

Board 12³/₄"x17³/₈"
Included 093319

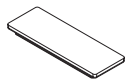

Board 6" x 17³/₈"
Included 091519



Grids
See p.92

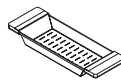

Colander 6" x 2¹/₄"
\$ 250

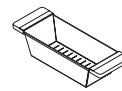

Colander 6" x 4¹/₄"
\$ 280

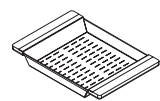

Colander 12" x 2¹/₄"
\$ 300

Bar sinks with ledge

Undermount installation with apron

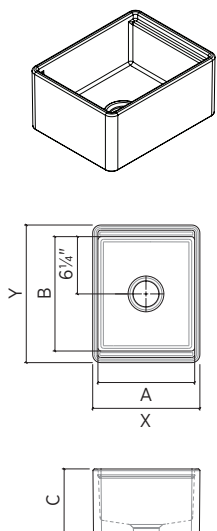

Cabinet 21"



Overall (X × Y)*
14 3/4" × 19"

Sink 091519

Bowl (A × B × C)*
13 1/4" × 15 3/4" × 7"
\$ 925

Included



Cutting board
210061

Grid 200936

\$ 200

*Dimensions can vary ±3/16"

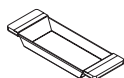

Tray 6" x 2 1/4"
\$ 250

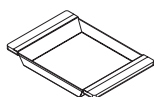

Tray 12" x 2 1/4"
\$ 300

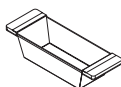

Bin 6" x 4 1/4"
\$ 280

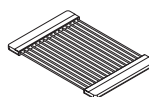

Drying rack
\$ 280

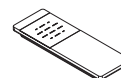

Presentation board
\$ 220

Kitchen sinks

Undermount installation with apron

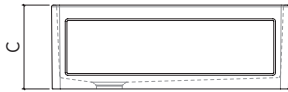
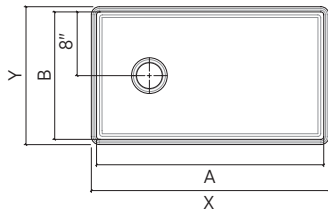
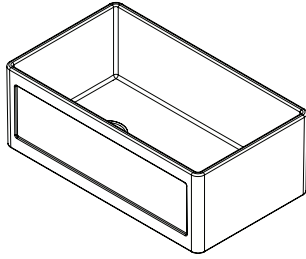

Cabinet 33"



Overall (X × Y)*
29¾" × 19"

Sink 083019

Bowl (A × B × C)*
28¼" × 17½" × 10"
\$ 1,225

Grid 200937

\$ 270

Cabinet 36"

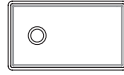

Overall (X × Y)*
32¾" × 19"

Sink 083319

Bowl (A × B × C)*
31¼" × 17½" × 10"
\$ 1,425

Grid 200938

\$ 280

Cabinet 42"



Overall (X × Y)*
38¾" × 19"

Sink 083919

Bowl (A × B × C)*
37¼" × 17½" × 10"
\$ 1,925

Grid 200940

\$ 300

*Dimensions can
vary ± $\frac{3}{16}$ "

ACCESSORIES

Fireclay



ACCESSORIES

For fireclay sinks

A sink is a lot more than a bowl to hold water. With the right accessories, it can become a real workstation. Take a look at our product offering to create additional workspace and improve efficiency in the kitchen.

Grids

Our solid stainless steel grids are all custom made to fit our sinks. By perfectly covering the bottom of the bowl, they provide effective protection against scrapes and early wear while allowing water to drain when items sit at the bottom of the sink.

Colanders, trays and bins

Our colanders, trays and bins are hand manufactured from tough stainless steel for greater durability. Placed on the counter or suspended above the sink, they are invaluable tools for straining, rinsing or serving food efficiently and hygienically.

Drying racks

Our drying rack can sit right over the sink to dry kitchen items or to rinse food. It can also be used on the counter as trivet.

Cutting boards

Our hardwood cutting board provides extra work space and can double as trivet or serving platter.

Drains

Our drains come in a range of design options to match your kitchen and the style of your sink. All our drain strainers are removable for easy cleaning.

Care products and replacement parts

To preserve the finish of Home Refinements Fira sinks and accessories, products and parts we recommend are essential.

Grids

For fireclay sinks

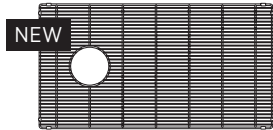
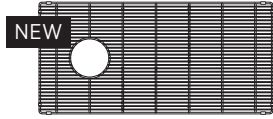

Collection	Drain	Bowl	Grid	Price
Fira with ledge	Left or right	$13\frac{1}{4}'' \times 15\frac{3}{4}''$	200936	\$ 200
		$31\frac{1}{4}'' \times 15\frac{3}{4}''$	200939	\$ 280

Collection	Drain	Bowl	Grid	Price
Fira	Left or right	$28\frac{1}{4}'' \times 17\frac{1}{2}''$	200937	\$ 270
		$31\frac{1}{4}'' \times 17\frac{1}{2}''$	200938	\$ 280
		$37\frac{1}{4}'' \times 17\frac{1}{2}''$	200940	\$ 300

- Ideal for rinsing or draining food, or simply protecting the sink surface from scratching
- Rubber-tipped footings for better stability and protection
- Rubber protectors on all corners to protect from scratching bowl sides
- Corrosion resistant and 304 series stainless steel (18/10)

Colanders

For fireclay sinks

ACCESSORIES

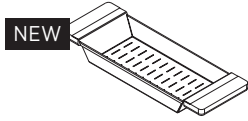

Collection	Bowl (front-to-back)	Dimensions	Colander	Price
Fira with ledge	15 3/4"	6" x 17 3/8" x 2 1/4"	205036	\$ 250

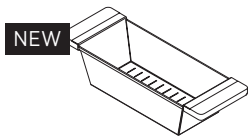

Collection	Bowl (front-to-back)	Dimensions	Colander	Price
Fira with ledge	15 3/4"	6" x 17 3/8" x 4 1/4"	205038	\$ 280

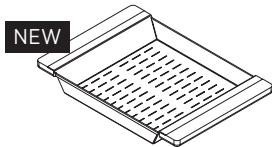

Collection	Bowl (front-to-back)	Dimensions	Colander	Price
Fira with ledge	15 3/4"	12" x 17 3/8" x 2 1/4"	205040	\$ 300

- Profiled to sit perfectly on 093319 and 091519 Fira sinks with accessory ledge, or be used on countertop
- Designed to match with other walnut accessories for Fira sinks with accessory ledge
- Ideal to rinse and prepare food
- Made of 304 series stainless steel (18/10) with solid walnut handles
- Rubber feet for better stability and protection

Trays

For fireclay sinks

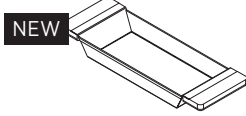

Collection	Bowl (front-to-back)	Dimensions	Tray	Price
Fira with ledge	15 3/4"	6" × 17 3/8" × 2 1/4"	205037	\$ 250

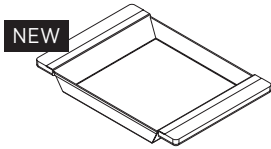

Collection	Bowl (front-to-back)	Dimensions	Tray	Price
Fira with ledge	15 3/4"	12" × 17 3/8" × 2 1/4"	205041	\$ 300

- Profiled to sit perfectly on 093319 and 091519 Fira sinks with accessory ledge, or be used on countertop
- Designed to match with other walnut accessories for Fira sinks with accessory ledge
- Ideal to prepare and serve food
- Made of 304 series stainless steel (18/10) with solid walnut handles
- Rubber feet for better stability and protection

Bins

For fireclay sinks

ACCESSORIES

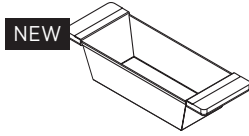

Collection	Bowl (front-to-back)	Dimensions	Bin	Price
Fira with ledge	15 3/4"	6" x 17 3/8" x 4 1/4"	205039	\$ 280

- Profiled to sit perfectly on 093319 and 091519 Fira sinks with accessory ledge, or be used on countertop
- Designed to match with other walnut accessories for Fira sinks with accessory ledge
- Ideal to prepare and serve food
- Made of 304 series stainless steel (18/10) with solid walnut handles
- Rubber feet for better stability and protection

Drying racks

For fireclay sinks

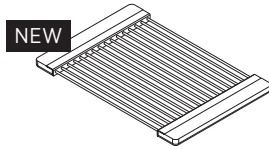

Collection	Bowl (front-to-back)	Dimensions	Rack	Price
Fira with ledge	15 3/4"	12" × 17 3/8" × 3/4"	215009	\$ 280

- Profiled to sit perfectly on 093319 and 091519 Fira sinks with accessory ledge, or be used on countertop
- Designed to match with other walnut accessories for Fira sinks with accessory ledge
- Ideal to rinse food or dry dishes
- Made of 304 series stainless steel (18/10) with solid walnut handles

Cutting boards

For fireclay sinks

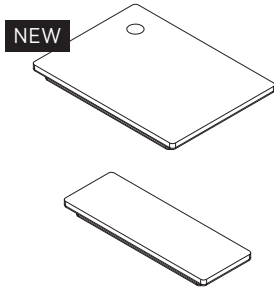

ACCESSORIES

Collection	Bowl (front-to-back)	Dimensions	Board	Price
Fira with ledge	15 3/4"	12 3/4" × 17 3/8" × 1 1/2"	210060*	\$ 270
	15 3/4"	6" × 17 3/8" × 1 1/2"	210061**	\$ 150

*Cutting board 210060 is included with sink 093319.

**Cutting board 210061 is included with sink 091519.

- Profiled to sit perfectly on 093319 and 091519 Fira sinks with accessory ledge, or be used on countertop
- Designed to match with other walnut accessories for Fira sinks with accessory ledge
- Made of 1 1/2" thick solid walnut, edge grain construction
- Treated with penetrating beeswax to seal the wood moisture
- Safe for all food preparation

Presentation boards

For fireclay sinks

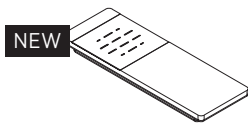

Collection	Bowl (front-to-back)	Dimensions	Board	Price
Fira with ledge	15 3/4"	6" × 17 3/8" × 1 1/2"	210062	\$ 220

- Profiled to sit perfectly on 093319 and 091519 Fira sinks with accessory ledge, or be used on countertop
- Designed to match with other walnut accessories for Fira sinks with accessory ledge
- Ideal as a presentation board or water station tray
- Made of 1 1/2" thick solid walnut, edge grain construction
- Includes 3 interchangeable magnetic stainless steel plates, for different applications
- Treated with penetrating beeswax
- Safe for all food preparation

Drains

For fireclay sinks

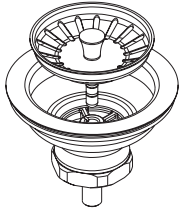

Diametre	Finish	Drain	Price
3 1/2"	Brushed nickel	100080	\$ 133
	Polished chrome	100081	\$ 99

- Solid brass construction
- Removable stainless steel basket strainer
- Fits standard 3 1/2" diameter drain opening
- Fits Home Refinements fireclay sinks up to 2" thick
- Available in two finishes

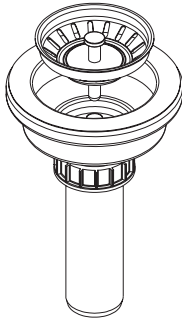

Diametre	Finish	Drain	Price
3 1/2"	Stainless steel	100130	\$ 55

- Stainless steel and polypropylene construction
- Removable stainless steel basket strainer
- 1 1/2" diameter and 4" long tailpiece included
- Fits standard 3 1/2" diameter drain opening
- Fits Home Refinements fireclay sinks up to 1 1/2" thick

Care products

For fireclay sinks



Description	Volume / unit	Qty	Product	Price
Maintenance wax for wood	70 g (2,5 oz.)	1	215019	\$ 35

- Apply regularly on wooden kitchen accessories to restore moisture
- Contains beeswax, carnauba wax and bran rice oil
- Mineral oil free
- Available in 2,5 oz (70 g) container



Description	Volume / unit	Qty	Product	Price
Porc-a-filler	57 ml (1,9 fl. oz.)	1	080998	\$ 25
Porc-a-fix	15 ml (0,5 fl. oz.)	1	080999	\$ 25

- Porc-a-filler: Designed to fill deep cracks and chips, to be used with Porc-a-fix touchup glaze
- Porc-a-fix: Touch-up glaze ideal for repairing minor cracks and scratches

ACCESSORIES

Replacement parts

For fireclay sinks

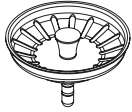

Description	Finish	Drain	Price
Basket strainer	Brushed nickel	100132	\$ 65
	Polished chrome	100133	\$ 50

- Replacement basket strainer for drain # 100080 and # 100081
- Available in two finishes



011240



011241

Description	Qty	Part	Price
Rubber-tipped footings	8	011240	\$ 20

- Protect from scratching the bottom of the sink
- Improve the stability of the grid

Rubber corner protectors	8	011241	\$ 20
--------------------------	---	---------------	-------

- Protect the inside of the sink

FAUCETS



FAUCETS

Our faucets were designed to increase both functionality and aesthetics of any kitchen sink. Made of solid brass, they will fulfill their duties for years to come.

Professional collection

Inspired by commercial kitchens, the professional collection's faucets are designed to deliver optimal performance worthy of the most seasoned chefs.

Pull-out and pull-down collection

Our pull-out and pull-down faucets offer great flexibility and are available in various configurations for kitchen and bar sinks. Their spray heads make preparing food and cleaning the sink a snap.

Accessories

Just like our sinks, our faucets come with optional accessories that enhance their functionality.

Professional collection

For kitchen sinks

3060X4

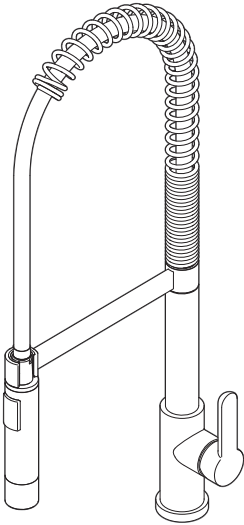

Name	Finish	Faucet	Price
Sky	Polished chrome	306004	\$ 2,227
	Brushed platinum	306014	\$ 3,342

- Made in Germany
- Solid brass construction
- Available in two finishes
- Single hole installation
- 360° swivel flexible spout
- Dual jet spray head
- Locking spray jet mode
- Descaling system, for easy cleaning
- 9 ½" projection
- Forward (90°) and lateral (30°) lever handle rotation, no interference with backsplash
- Braided stainless steel water supply hoses 16" long
- 2,2 gpm (8,3 L/min.) flow rate aerator
- Ceramic cartridge
- ASME A112.18.1 / CSA B125.1 (pending)
- NSF / ANSI 61 compliant, low lead content
- ADA compliant

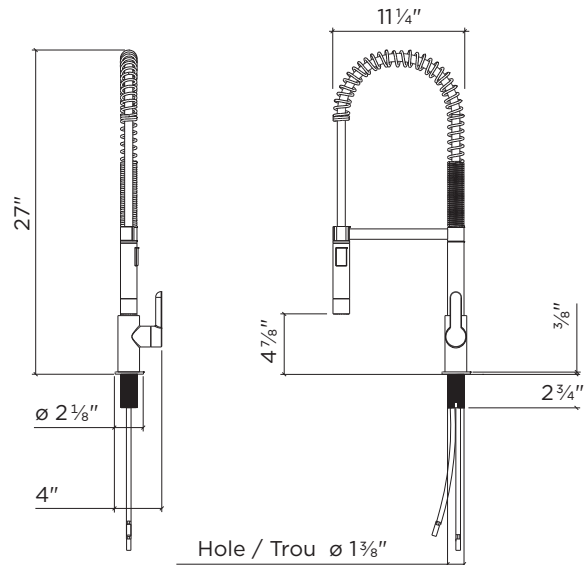

3062X6

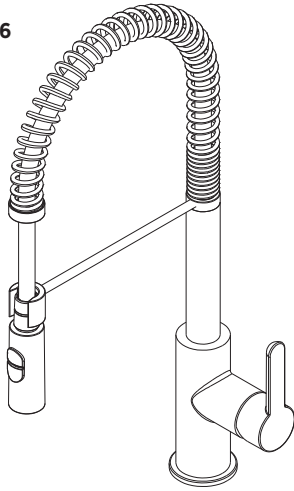

Name	Finish	Faucet	Price
Peak	Polished chrome	306206	\$ 769
	Brushed nickel	306216	\$ 999

- Made in Italy
- Solid brass construction
- Available in two finishes
- Single hole installation
- 360° swivel flexible spout
- Dual jet spray head
- Locking spray jet mode
- Descaling system, for easy cleaning
- 8 5/8" projection
- Forward (90°) and lateral (30°) lever handle rotation, no interference with backsplash
- Braided stainless steel water supply hoses 18" long, with 3/8" fittings
- 2,2 gpm (8,3 L/min.) flow rate aerator
- Ceramic cartridge
- ASME A112.18.1 / CSA B125.1 (pending)
- NSF / ANSI 61 compliant, low lead content
- ADA compliant

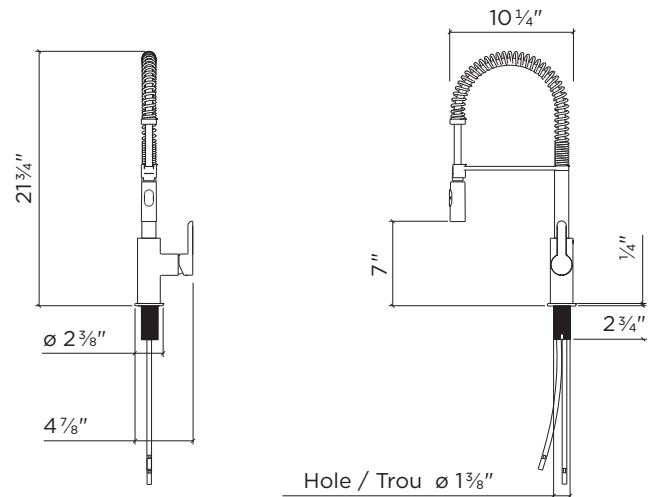

Professional collection

For kitchen sinks

3060X1

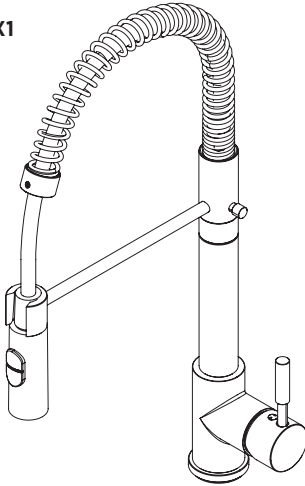

Name	Finish	Faucet	Price
Wave	Polished chrome	306001	\$ 625
	Brushed nickel	306011	\$ 789

- Made in Italy
- Solid brass construction
- Available in two finishes
- Single hole installation
- 360° swivel flexible spout
- Dual jet spray head
- Locking spray jet mode
- Descaling system, for easy cleaning
- 8 5/8" projection
- Forward (90°) and lateral (30°) lever handle rotation, no interference with backsplash
- Braided stainless steel water supply hoses 18" long, with 3/8" fittings
- 2,2 gpm (8,3 L/min.) flow rate aerator
- Ceramic cartridge
- ASME A112.18.1 / CSA B125.1
- NSF / ANSI 61 compliant, low lead content
- ADA compliant

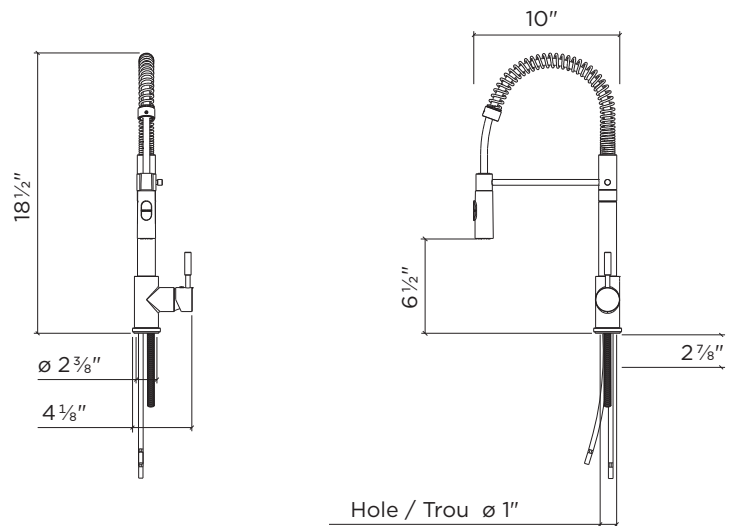

3062X7

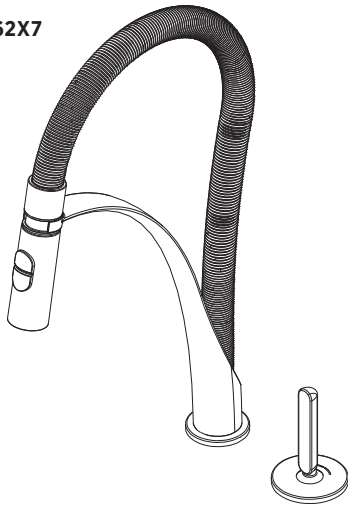

Name	Finish	Faucet	Price
Abyss	Polished chrome	306207	\$ 856
	Brushed nickel	306217	\$ 1,092

- Made in Italy
- Solid brass construction
- Available in two finishes
- Double hole installation
- 360° swivel flexible spout
- Dual jet spray head
- Locking spray jet mode
- Descaling system, for easy cleaning
- 8 ¼" projection
- Backward (30°) and bilateral (45°) lever handle rotation
- Braided stainless steel water supply hoses 18" long, with 3/8" fittings
- 2,2 gpm (8,3 L/min.) flow rate aerator
- Ceramic cartridge
- ASME A112.18.1 / CSA B125.1 (pending)
- NSF / ANSI 61 compliant, low lead content
- ADA compliant

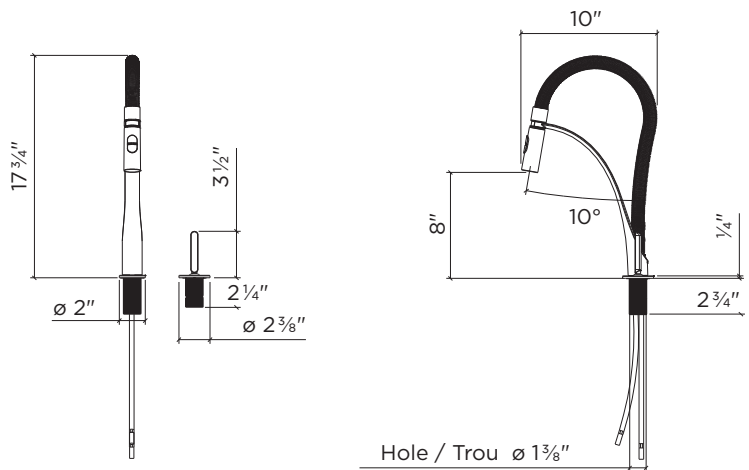

Pull-out collection

For kitchen sinks

3062X0

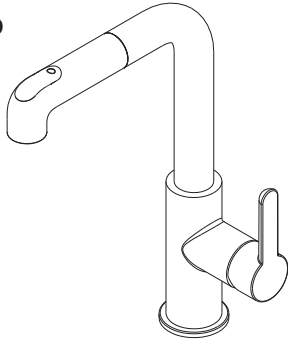

Name	Finish	Faucet	Price
Latitude	Polished chrome	306200	\$ 625
	Brushed nickel	306210	\$ 815

- Made in Italy
- Solid brass construction
- Available in two finishes
- Single hole installation
- 110° swivel spout
- Pull-out dual jet spray head
- Locking spray jet mode
- Descaling system, for easy cleaning
- 8" projection
- Forward (90°) and lateral (30°) lever handle rotation, no interference with backsplash
- Braided stainless steel water supply hoses 18" long, with 3/8" fittings
- 2,2 gpm (8,3 L/min.) flow rate aerator
- Ceramic cartridge
- ASME A112.18.1 / CSA B125.1 (pending)
- NSF / ANSI 61 compliant, low lead content
- ADA compliant

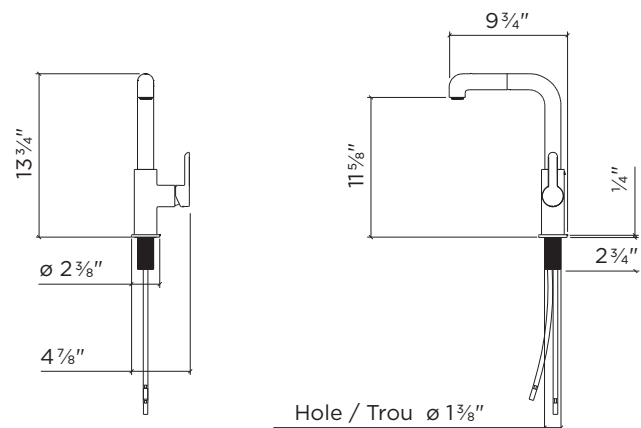

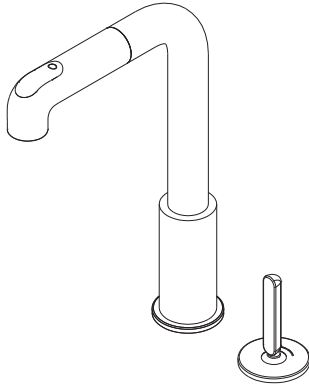
3062X1

Name	Finish	Faucet	Price
Latitude with remote single lever	Polished chrome	306201	\$ 728
	Brushed nickel	306211	\$ 948

- Made in Italy
- Solid brass construction
- Available in two finishes
- Double hole installation
- 110° swivel spout
- Pull-out dual jet spray head
- Locking spray jet mode
- Descaling system, for easy cleaning
- 8" projection
- Backward (30°) and bilateral (45°) lever handle rotation
- Braided stainless steel water supply hoses 18" long, with 3/8" fittings
- 2,2 gpm (8,3 L/min.) flow rate aerator
- Ceramic cartridge
- ASME A112.18.1 / CSA B125.1 (pending)
- NSF / ANSI 61 compliant, low lead content
- ADA compliant

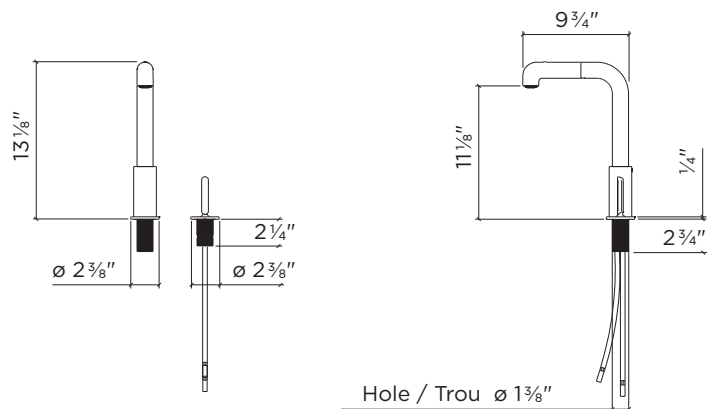

Pull-out collection

For kitchen sinks

3060X3

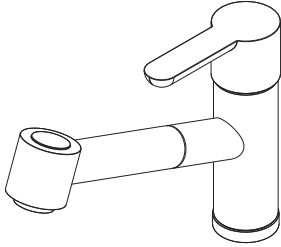

Name	Finish	Faucet	Price
Source	Polished chrome	306003	\$ 769
	Brushed platinum	306013	\$ 1,153

- Made in Germany
- Solid brass construction
- Available in two finishes
- Single hole installation
- 130° swivel spout
- Pull-out dual jet spray head
- Locking spray jet mode
- Descaling system, for easy cleaning
- 8 7/8" projection
- Top (30°) and lateral (60°) lever handle rotation, does not interfere with the backsplash
- Braided stainless steel water supply hoses 16" long
- 1,5 gpm (5,7 L/min.) flow rate aerator
- Ceramic cartridge
- ASME A112.18.1 / CSA B125.1 (pending)
- NSF / ANSI 61 compliant, low lead content
- ADA compliant

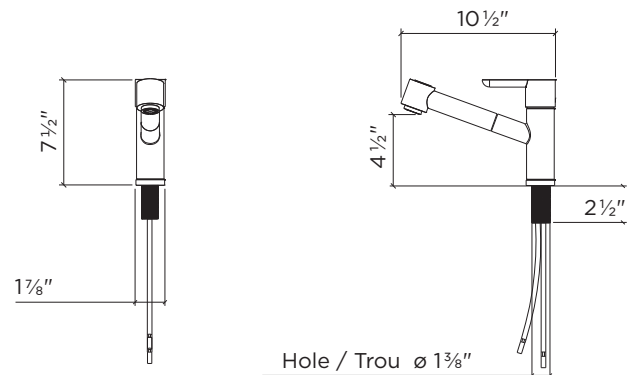

3060X2

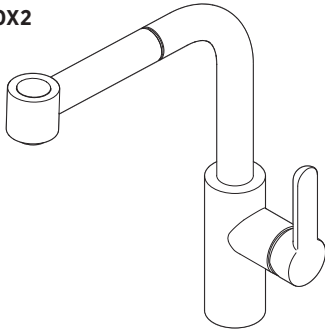

Name	Finish	Faucet	Price
Pure	Polished chrome	306002	\$ 1,517
	Brushed platinum	306012	\$ 2,278

- Made in Germany
- Solid brass construction
- Available in two finishes
- Single hole installation
- 360° swivel spout
- Pull-out dual jet spray head
- Locking spray jet mode
- Descaling system, for easy cleaning
- 9 ¼" projection
- Forward (90°) and lateral (30°) lever handle rotation, no interference with backsplash
- Braided stainless steel water supply hoses 16" long
- 1,5 gpm (5,7 L/min.) flow rate aerator
- Ceramic cartridge
- ASME A112.18.1 / CSA B125.1
- NSF / ANSI 61 compliant, low lead content
- ADA compliant

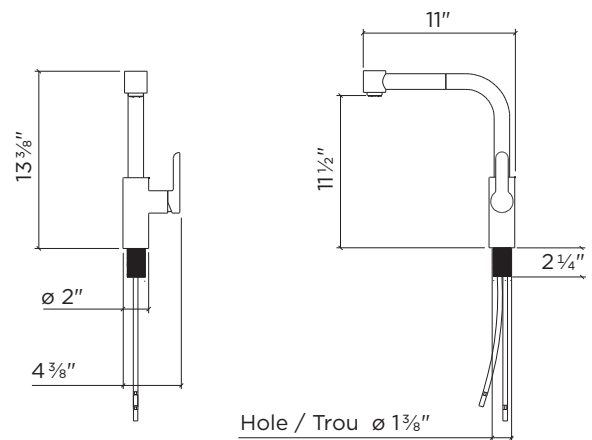

Pull-down collection

For kitchen sinks

3062X4

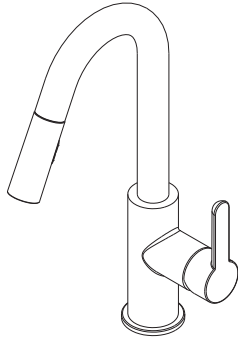

Name	Finish	Faucet	Price
Apex	Polished chrome	306204	\$ 610
	Brushed nickel	306214	\$ 794

- Made in Italy
- Solid brass construction
- Available in two finishes
- Single hole installation
- 110° swivel spout
- Pull-down dual jet spray head
- Locking spray jet mode
- Descaling system, for easy cleaning
- 7" projection
- Forward (90°) and lateral (30°) lever handle rotation, no interference with backsplash
- Braided stainless steel water supply hoses 18" long, with 3/8" fittings
- 2,2 gpm (8,3 L/min.) flow rate aerator
- Ceramic cartridge
- ASME A112.18.1 / CSA B125.1 (pending)
- NSF / ANSI 61 compliant, low lead content
- ADA compliant

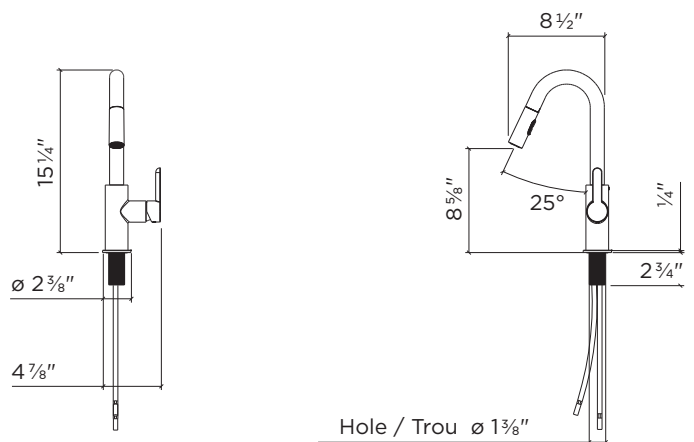

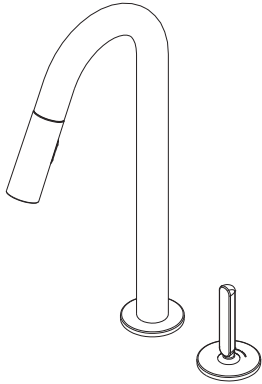
3062X5

Name	Finish	Faucet	Price
Apex with remote single lever	Polished chrome	306205	\$ 712
	Brushed nickel	306215	\$ 917

- Made in Italy
- Solid brass construction
- Available in two finishes
- Double hole installation
- 110° swivel spout
- Pull-down dual jet spray head
- Locking spray jet mode
- Descaling system, for easy cleaning
- 7" projection
- Backward (30°) and bilateral (45°) lever handle rotation
- Braided stainless steel water supply hoses 18" long, with 3/8" fittings
- 2,2 gpm (8,3 L/min.) flow rate aerator
- Ceramic cartridge
- ASME A112.18.1 / CSA B125.1 (pending)
- NSF / ANSI 61 compliant, low lead content
- ADA compliant

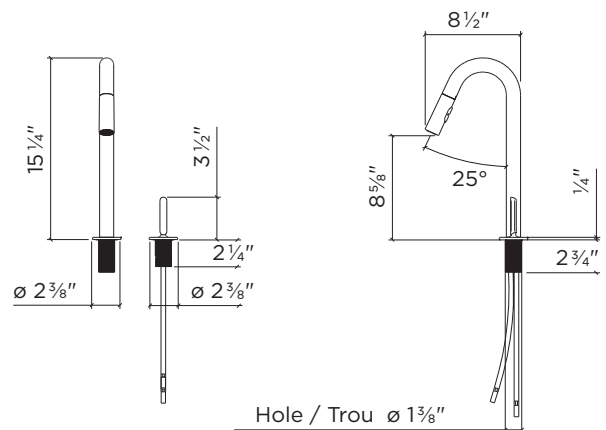

Pull-down collection

For bar sinks

3062X2

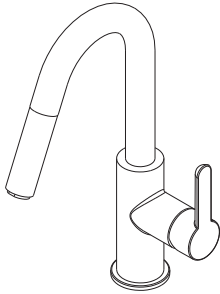

Name	Finish	Faucet	Price
Apex prep	Polished chrome	306202	\$ 564
	Brushed nickel	306212	\$ 733

- Made in Italy
- Solid brass construction
- Available in two finishes
- Single hole installation
- 110° swivel spout
- Pull-down spray head
- Descaling system, for easy cleaning
- 7" projection
- Forward (90°) and lateral (30°) lever handle rotation, no interference with backsplash
- Braided stainless steel water supply hoses 18" long, with 3/8" fittings
- 2,2 gpm (8,3 L/min.) flow rate aerator
- Ceramic cartridge
- ASME A112.18.1 / CSA B125.1 (pending)
- NSF / ANSI 61 compliant, low lead content
- ADA compliant

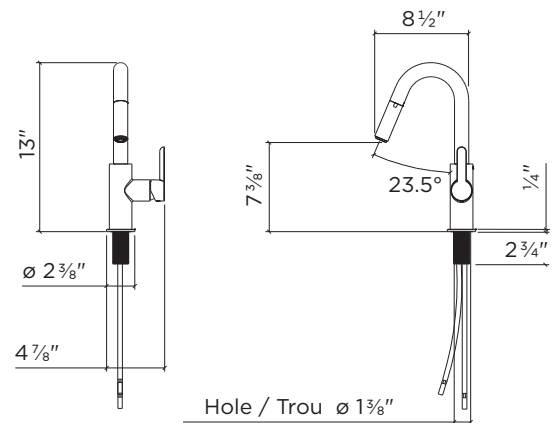

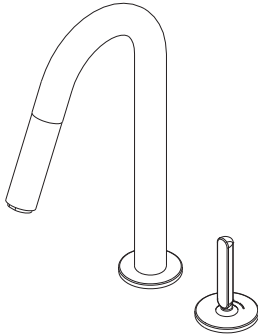
3062X3

Name	Finish	Faucet	Price
Apex prep with remote single lever	Polished chrome	306203	\$ 666
	Brushed nickel	306213	\$ 866

- Made in Italy
- Solid brass construction
- Available in two finishes
- Double hole installation
- 110° swivel spout
- Pull-down spray head
- Descaling system, for easy cleaning
- 7" projection
- Backward (30°) and bilateral (45°) lever handle rotation
- Braided stainless steel water supply hoses 18" long, with 3/8" fittings
- 2,2 gpm (8,3 L/min.) flow rate aerator
- Ceramic cartridge
- ASME A112.18.1 / CSA B125.1 (pending)
- NSF / ANSI 61 compliant, low lead content
- ADA compliant

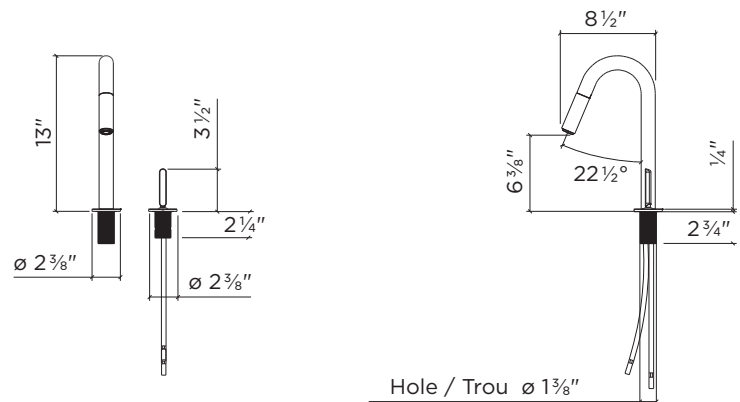

Pull-down collection

For kitchen sinks

3060X0

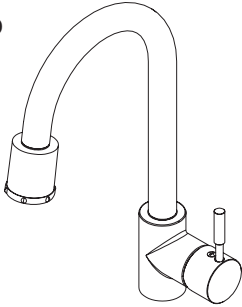

Name	Finish	Faucet	Price
Azur	Polished chrome	306000	\$ 610
	Brushed nickel	306010	\$ 820

- Made in Italy
- Solid brass construction
- Available in two finishes
- Single hole installation
- 360° swivel spout
- Pull-down dual jet spray head
- Locking spray jet mode
- Descaling system, for easy cleaning
- 7 7/8" projection
- Forward (90°) and lateral (30°) lever handle rotation, no interference with backsplash
- Braided stainless steel water supply hoses 18" long, with 3/8" fittings
- 2,2 gpm (8,3 L/min.) flow rate aerator
- Ceramic cartridge
- ASME A112.18.1 / CSA B125.1
- NSF / ANSI 61 compliant, low lead content

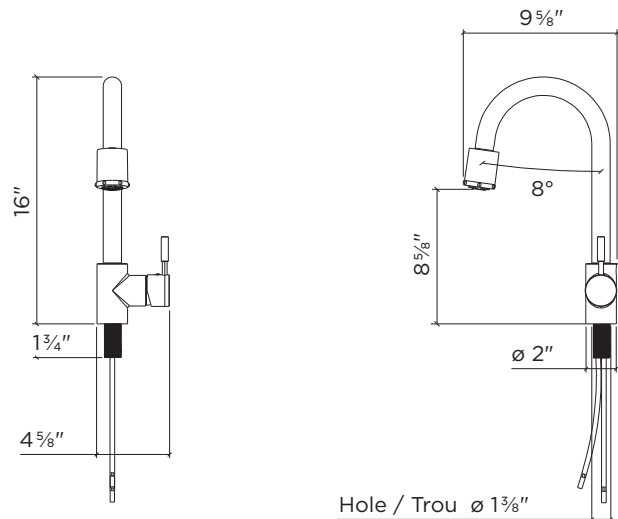

3060X5

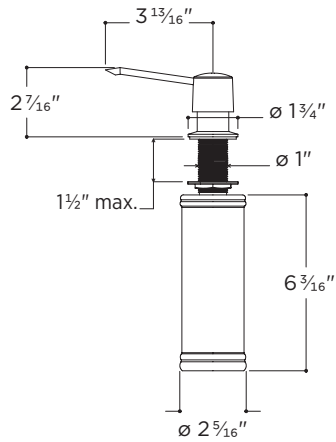
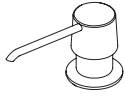

Name	Finish	Dispenser	Price
Soap dispenser	Polished chrome	306005	\$ 113
	Brushed nickel	306015	\$ 133

- Made in Italy
- Solid brass construction
- Available in two finishes
- Top recharge
- 12 fl. oz (355 ml) capacity

3060X6

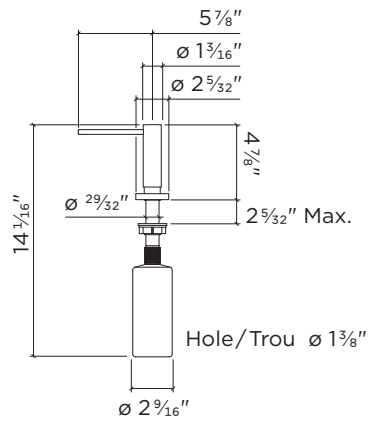
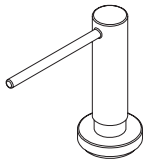

Name	Finish	Dispenser	Price
Soap dispenser	Polished chrome	306006	\$ 343
	Brushed platinum	306016	\$ 536

- Made in Germany
- Solid brass construction
- Available in two finishes
- Top recharge
- 17 fl. oz (500 ml) capacity

Accessories

For kitchen sinks

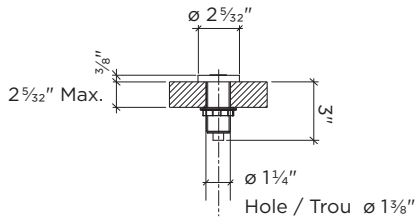
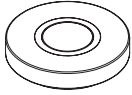

Name	Finish	Button	Price
Air activated switch button	Polished chrome	306007	\$ 180
	Brushed platinum	306017	\$ 272

- Made in Germany
- Available in two finishes
- For operating garbage disposal

Product index

Product	Page	Pkg.	Price
000100	70	72 lbs	\$ 2,675
000110	70	69 lbs	\$ 2,592
000120	70	65 lbs	\$ 2,550
000151	71	96 lbs	\$ 3,867
000161	71	87 lbs	\$ 3,814
000171	71	103 lbs	\$ 3,950
000201	72	115 lbs	\$ 3,762
000210	72	108 lbs	\$ 3,720
000221	72	144 lbs	\$ 3,846
000253	73	55 lbs	\$ 2,595
003202	36	17 lbs	\$ 1,605
003203	36	18 lbs	\$ 1,635
003204	36	19 lbs	\$ 1,680
003205	36	23 lbs	\$ 1,705
003206	37	25 lbs	\$ 1,745
003207	37	27 lbs	\$ 1,790
003209	37	28 lbs	\$ 1,820
003210	37	28 lbs	\$ 1,800
003211	37	30 lbs	\$ 1,855
003212	42	15 lbs	\$ 1,250
003213	37	33 lbs	\$ 1,890
003214	37	36 lbs	\$ 1,955
003215	37	39 lbs	\$ 1,995
003216	37	28 lbs	\$ 1,800
003217	37	30 lbs	\$ 1,840
003218	37	32 lbs	\$ 1,870
003219	42	15 lbs	\$ 1,250
003222	36	23 lbs	\$ 1,735
003224	37	29 lbs	\$ 1,815
003225	42	18 lbs	\$ 1,285
003226	37	34 lbs	\$ 1,885
003227	42	18 lbs	\$ 1,285
003228	42	17 lbs	\$ 1,265
003229	42	17 lbs	\$ 1,265
003232	39	40 lbs	\$ 2,375
003233	40	42 lbs	\$ 2,350
003234	40	42 lbs	\$ 2,350
003235	37	34 lbs	\$ 1,905
003236	41	44 lbs	\$ 2,365
003237	41	44 lbs	\$ 2,365

Product	Page	Pkg.	Price
003238	39	44 lbs	\$ 2,455
003239	41	44 lbs	\$ 2,375
003240	37	30 lbs	\$ 1,825
003241	41	44 lbs	\$ 2,375
003244	36	25 lbs	\$ 1,735
003246	38	35 lbs	\$ 2,300
003247	40	36 lbs	\$ 2,310
003248	38	40 lbs	\$ 2,310
003249	39	45 lbs	\$ 2,350
003251	39	38 lbs	\$ 2,285
003252	40	36 lbs	\$ 2,310
003253	39	45 lbs	\$ 2,350
003254	38	40 lbs	\$ 2,310
003256	38	35 lbs	\$ 2,300
003257	37	42 lbs	\$ 2,025
003258	36	26 lbs	\$ 1,775
003259	37	38 lbs	\$ 1,995
003277	38	38 lbs	\$ 2,285
003278	38	38 lbs	\$ 2,285
003280	37	32 lbs	\$ 1,855
003281	39	44 lbs	\$ 2,315
003282	39	44 lbs	\$ 2,315
003283	39	48 lbs	\$ 2,345
003284	37	33 lbs	\$ 1,845
003285	37	26 lbs	\$ 1,770
003290	37	36 lbs	\$ 1,925
003500	68	27 lbs	\$ 1,770
003501	68	36 lbs	\$ 2,745
003502	68	36 lbs	\$ 2,745
003503	68	38 lbs	\$ 2,768
003504	68	38 lbs	\$ 2,768
003505	68	24 lbs	\$ 1,759
003601	16	17 lbs	\$ 1,050
003602	16	18 lbs	\$ 1,080
003603	16	19 lbs	\$ 1,129
003604	16	23 lbs	\$ 1,165
003606	17	25 lbs	\$ 1,201
003607	17	27 lbs	\$ 1,255
003608	22	15 lbs	\$ 912
003609	22	18 lbs	\$ 960

Product	Page	Pkg.	Price
003610	17	26 lbs	\$ 1,231
003611	17	28 lbs	\$ 1,267
003612	17	30 lbs	\$ 1,327
003613	22	18 lbs	\$ 960
003614	22	17 lbs	\$ 936
003615	17	30 lbs	\$ 1,297
003616	22	17 lbs	\$ 936
003617	22	14 lbs	\$ 780
003618	17	28 lbs	\$ 1,267
003619	22	16 lbs	\$ 930
003621	17	32 lbs	\$ 1,345
003622	22	19 lbs	\$ 1,080
003626	16	23 lbs	\$ 1,195
003627	16	26 lbs	\$ 1,237
003628	17	29 lbs	\$ 1,279
003629	17	32 lbs	\$ 1,321
003631	17	34 lbs	\$ 1,357
003633	17	38 lbs	\$ 1,477
003634	17	42 lbs	\$ 1,519
003637	19	40 lbs	\$ 1,765
003638	20	42 lbs	\$ 1,729
003639	20	42 lbs	\$ 1,729
003640	21	44 lbs	\$ 1,753
003641	21	44 lbs	\$ 1,753
003642	19	50 lbs	\$ 1,849
003643	21	44 lbs	\$ 1,753
003644	21	44 lbs	\$ 1,753
003647	16	25 lbs	\$ 1,201
003648	18	35 lbs	\$ 1,669
003649	18	40 lbs	\$ 1,693
003651	20	36 lbs	\$ 1,681
003652	20	36 lbs	\$ 1,681
003653	19	38 lbs	\$ 1,657
003654	19	45 lbs	\$ 1,729
003657	19	45 lbs	\$ 1,729
003658	18	40 lbs	\$ 1,693
003659	18	35 lbs	\$ 1,669
003666	17	30 lbs	\$ 1,303
003667	17	34 lbs	\$ 1,381
003668	22	15 lbs	\$ 912

Product index

Product	Page	Pkg.	Price
003670	17	33 lbs	\$ 1,370
003672	17	36 lbs	\$ 1,399
003673	23	30 lbs	\$ 1,423
003674	23	32 lbs	\$ 1,465
003676	23	44 lbs	\$ 1,555
003677	18	38 lbs	\$ 1,656
003678	18	38 lbs	\$ 1,656
003679	19	44 lbs	\$ 1,709
003680	17	28 lbs	\$ 1,291
003681	19	44 lbs	\$ 1,709
003682	19	48 lbs	\$ 1,790
003685	17	33 lbs	\$ 1,363
003690	17	36 lbs	\$ 1,441
003695	17	39 lbs	\$ 1,525
003865	24	90 lbs	\$ 4,462
003903	26	17 lbs	\$ 1,420
003907	26	18 lbs	\$ 1,445
003908	27	33 lbs	\$ 1,710
003909	26	19 lbs	\$ 1,490
003910	27	26 lbs	\$ 1,590
003912	26	23 lbs	\$ 1,520
003913	27	25 lbs	\$ 1,560
003914	27	27 lbs	\$ 1,605
003915	27	30 lbs	\$ 1,645
003917	32	15 lbs	\$ 1,210
003918	27	28 lbs	\$ 1,640
003919	27	28 lbs	\$ 1,615
003920	27	30 lbs	\$ 1,655
003922	27	30 lbs	\$ 1,675
003923	32	15 lbs	\$ 1,210
003924	32	18 lbs	\$ 1,245
003925	27	34 lbs	\$ 1,725
003927	27	36 lbs	\$ 1,780
003928	27	39 lbs	\$ 1,820
003929	27	28 lbs	\$ 1,620
003931	32	18 lbs	\$ 1,245
003932	27	32 lbs	\$ 1,690
003933	32	17 lbs	\$ 1,220
003934	28	38 lbs	\$ 2,085
003935	27	36 lbs	\$ 1,745
003936	28	38 lbs	\$ 2,085
003937	26	23 lbs	\$ 1,550
003938	26	26 lbs	\$ 1,590
003939	27	29 lbs	\$ 1,635
003941	27	32 lbs	\$ 1,675
003942	27	34 lbs	\$ 1,705
003943	32	17 lbs	\$ 1,220
003944	27	38 lbs	\$ 1,820

Product	Page	Pkg.	Price
003946	27	42 lbs	\$ 1,850
003947	29	44 lbs	\$ 2,100
003948	29	44 lbs	\$ 2,100
003949	29	40 lbs	\$ 2,175
003952	30	42 lbs	\$ 2,150
003953	30	42 lbs	\$ 2,150
003954	31	44 lbs	\$ 2,165
003957	31	44 lbs	\$ 2,165
003958	29	50 lbs	\$ 2,250
003959	31	44 lbs	\$ 2,165
003962	31	44 lbs	\$ 2,165
003963	29	48 lbs	\$ 2,145
003967	32	14 lbs	\$ 1,135
003968	32	16 lbs	\$ 1,195
003969	32	19 lbs	\$ 1,245
003972	32	30 lbs	\$ 1,730
003973	33	32 lbs	\$ 1,775
003974	33	44 lbs	\$ 1,855
003981	26	25 lbs	\$ 1,560
003982	28	35 lbs	\$ 2,100
003983	28	40 lbs	\$ 2,110
003984	30	36 lbs	\$ 2,100
003986	29	45 lbs	\$ 2,150
003987	29	38 lbs	\$ 2,085
003988	30	36 lbs	\$ 2,100
003989	28	35 lbs	\$ 2,100
003991	28	40 lbs	\$ 2,110
003992	29	45 lbs	\$ 2,150
003995	27	33 lbs	\$ 1,650
005300	64	56 lbs	\$ 2,750
005301	64	56 lbs	\$ 2,750
005302	64	62 lbs	\$ 2,800
005303	64	62 lbs	\$ 2,800
005304	64	68 lbs	\$ 2,900
005305	64	68 lbs	\$ 2,900
005400(M)	60	60 lbs	\$ 1,900
005401(M)	60	72 lbs	\$ 2,300
005402(M)	60	75 lbs	\$ 2,600
005403(M)	60	79 lbs	\$ 2,900
005404(M)	61	94 lbs	\$ 3,500
005405(M)	61	102 lbs	\$ 4,100
005406(M)	62	83 lbs	\$ 4,500
005407(M)	62	99 lbs	\$ 4,900
005450(W)	60	60 lbs	\$ 1,900
005451(W)	60	72 lbs	\$ 2,300
005452(W)	60	75 lbs	\$ 2,600
005453(W)	60	79 lbs	\$ 2,900
005454(W)	61	94 lbs	\$ 3,500

Product	Page	Pkg.	Price
005455(W)	61	102 lbs	\$ 4,100
005456(W)	62	83 lbs	\$ 4,500
005457(W)	62	99 lbs	\$ 4,900
010700	86	0.1 lbs	\$ 20
011126	86	0.1 lbs	\$ 20
011240	86, 100	0,1 lbs	\$ 20
011241	86, 100	0,1 lbs	\$ 20
080998	99	0,5 lbs	\$ 25
080999	99	0,5 lbs	\$ 25
083019	90	103 lbs	\$ 1,225
083319	90	105 lbs	\$ 1,425
083919	90	122 lbs	\$ 1,925
091519	89	50 lbs	\$ 925
093319	88	107 lbs	\$ 1,625
100056	84	2 lbs	\$ 31
100080	84	2 lbs	\$ 133
100081	84	2 lbs	\$ 99
100082	84	2 lbs	\$ 133
100083	84	2 lbs	\$ 99
100085	84	2 lbs	\$ 99
100086	84	2 lbs	\$ 78
100132	86, 100	0.4 lbs	\$ 65
100133	86, 100	0.4 lbs	\$ 50
100134	86, 100	0.2 lbs	\$ 65
100135	86, 100	0.2 lbs	\$ 50
200900	78	7 lbs	\$ 232
200901	78	7 lbs	\$ 237
200902	76	6 lbs	\$ 190
200903	76	6 lbs	\$ 200
200904	76	6 lbs	\$ 210
200905	76	7 lbs	\$ 220
200906	76	7 lbs	\$ 230
200907	76	7 lbs	\$ 250
200908	76	7 lbs	\$ 265
200909	76, 78	8 lbs	\$ 280
200910	76	8 lbs	\$ 290
200911	76	8 lbs	\$ 300
200912	76	7 lbs	\$ 235
200913	76, 77	7 lbs	\$ 250
200914	76, 77	7 lbs	\$ 270
200915	76, 77	8 lbs	\$ 285
200916	76	6 lbs	\$ 215
200917	76	7 lbs	\$ 230
200918	76	7 lbs	\$ 245
200919	76, 78	7 lbs	\$ 255
200920	76	7 lbs	\$ 275
200921	76, 78	8 lbs	\$ 290
200922	76	8 lbs	\$ 300

Product	Page	Pkg.	Price
200923	76, 78	8 lbs	\$ 310
200924	76	6 lbs	\$ 190
200925	76, 78	6 lbs	\$ 195
200926	76	6 lbs	\$ 205
200927	77	8 lbs	\$ 285
200928	77	8 lbs	\$ 285
200929	77	7 lbs	\$ 225
200930	77	6 lbs	\$ 205
200931	77	7 lbs	\$ 225
200932	77	8 lbs	\$ 295
200933	78	7 lbs	\$ 260
200934	78	7 lbs	\$ 280
200935	78	8 lbs	\$ 300
200936	92	6 lbs	\$ 200
200937	92	7 lbs	\$ 270
200938	92	7 lbs	\$ 280
200939	92	7 lbs	\$ 280
200940	92	7 lbs	\$ 300
205036	93	9 lbs	\$ 250
205037	94	9 lbs	\$ 250
205038	93	11 lbs	\$ 280
205039	95	11 lbs	\$ 280
205040	93	12 lbs	\$ 300
205041	94	12 lbs	\$ 300
205217	79	9 lbs	\$ 220
205218	79	9 lbs	\$ 220
205219	79	9 lbs	\$ 220
205220	80	9 lbs	\$ 220
205221	80	9 lbs	\$ 220
205222	80	9 lbs	\$ 220
205223	79	11 lbs	\$ 245
205224	79	11 lbs	\$ 245
205225	79	11 lbs	\$ 245
205226	81	11 lbs	\$ 245
205227	81	11 lbs	\$ 245
205228	81	11 lbs	\$ 245
205229	79	12 lbs	\$ 265
205230	79	12 lbs	\$ 265
205231	79	12 lbs	\$ 265
205232	80	12 lbs	\$ 265
205233	80	12 lbs	\$ 265
205234	80	12 lbs	\$ 265
205238	83	4 lbs	\$ 75
205317	79	9 lbs	\$ 220
205318	79	9 lbs	\$ 220
205319	79	9 lbs	\$ 220
205320	80	9 lbs	\$ 220
205321	80	9 lbs	\$ 220

Product	Page	Pkg.	Price
205322	80	9 lbs	\$ 220
205323	79	11 lbs	\$ 245
205324	79	11 lbs	\$ 245
205325	79	11 lbs	\$ 245
205326	81	11 lbs	\$ 245
205327	81	11 lbs	\$ 245
205328	81	11 lbs	\$ 245
205329	79	12 lbs	\$ 265
205330	79	12 lbs	\$ 265
205331	79	12 lbs	\$ 265
205332	80	12 lbs	\$ 265
205333	80	12 lbs	\$ 265
205334	80	12 lbs	\$ 265
205338	83	4 lbs	\$ 75
210060	97	16 lbs	\$ 270
210061	97	8 lbs	\$ 150
210062	97	8 lbs	\$ 220
210063	83	16 lbs	\$ 260
210064	83	16 lbs	\$ 260
210065	83	16 lbs	\$ 260
210066	83	16 lbs	\$ 260
210067	83	16 lbs	\$ 260
210068	83	16 lbs	\$ 260
215009	96	12 lbs	\$ 280
215015	85	1 lbs	\$ 23
215016	85	1 lbs	\$ 25
215017	85	5 lbs	\$ 125
215018	85	5 lbs	\$ 135
215019	85, 99	0,5 lbs	\$ 35
215206	82	12 lbs	\$ 280
215207	82	12 lbs	\$ 280
215208	82	12 lbs	\$ 280
215306	82	12 lbs	\$ 280
215307	82	12 lbs	\$ 280
215308	82	12 lbs	\$ 280
306000	114	8 lbs	\$ 610
306001	104	8 lbs	\$ 625
306002	109	8 lbs	\$ 1,517
306003	108	7 lbs	\$ 769
306004	102	11 lbs	\$ 2,227
306005	115	3 lbs	\$ 113
306006	115	3 lbs	\$ 343
306007	116	3 lbs	\$ 180
306010	114	8 lbs	\$ 820
306011	104	8 lbs	\$ 789
306012	109	8 lbs	\$ 2,278
306013	108	7 lbs	\$ 1,153
306014	102	11 lbs	\$ 3,342

Product	Page	Pkg.	Price
306015	115	3 lbs	\$ 133
306016	115	3 lbs	\$ 536
306017	116	3 lbs	\$ 272
306200	106	8 lbs	\$ 625
306201	107	8 lbs	\$ 728
306202	112	7 lbs	\$ 564
306203	113	7 lbs	\$ 666
306204	110	8 lbs	\$ 610
306205	111	8 lbs	\$ 712
306206	103	9 lbs	\$ 769
306207	105	8 lbs	\$ 856
306210	106	8 lbs	\$ 815
360211	107	8 lbs	\$ 948
306212	112	7 lbs	\$ 733
306213	113	7 lbs	\$ 866
306214	110	8 lbs	\$ 794
306215	111	8 lbs	\$ 917
306216	103	9 lbs	\$ 999
306217	105	8 lbs	\$ 1,092

À la Carte options

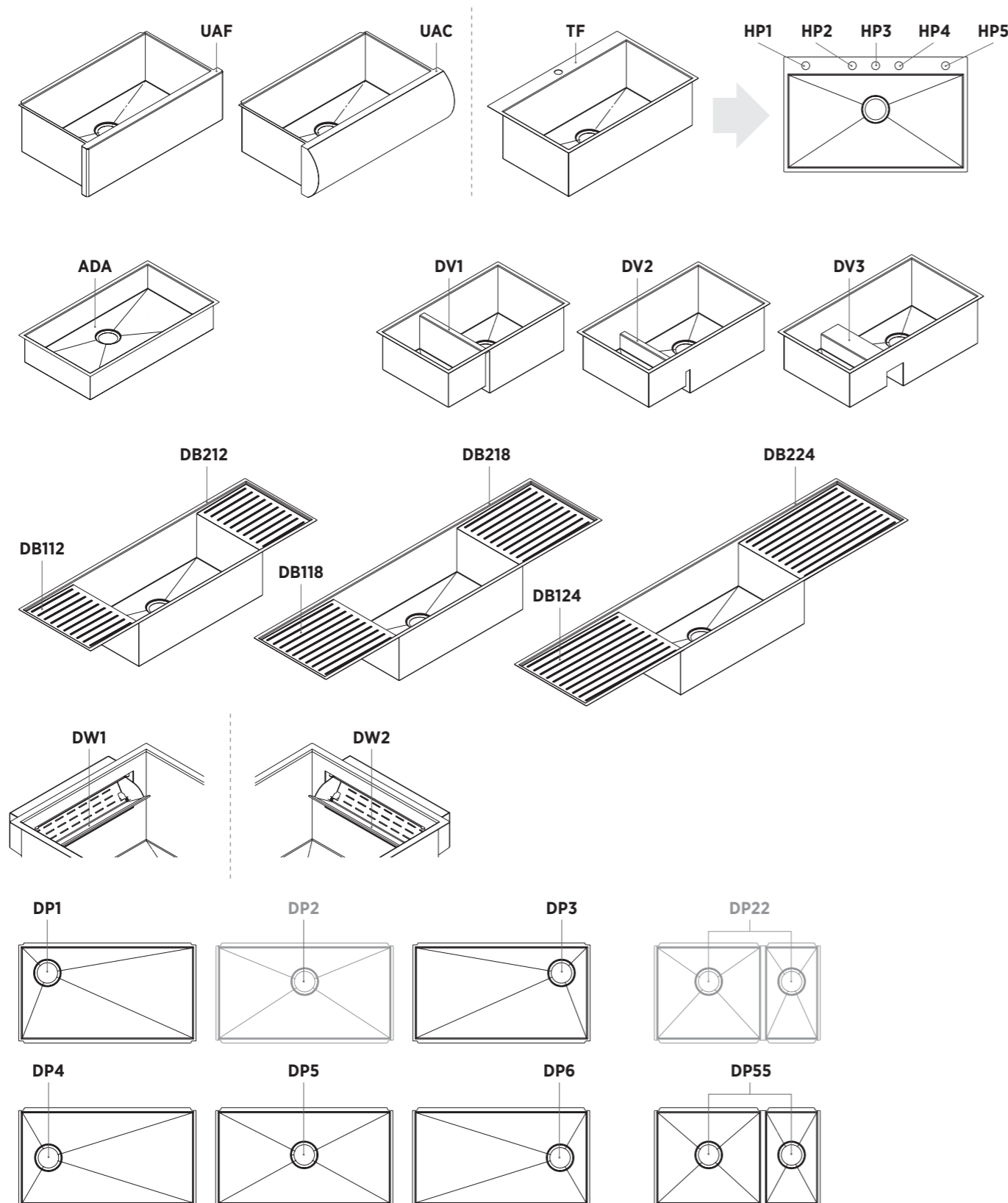

À la Carte options

Installation type	Option	Price
Undermount with apron flat	UAF	\$ 720
Undermount with apron curved	UAC	\$ 720
Topmount / Flushmount ⁽¹⁾	TF	\$ 675

1. Please note that all these sinks come with at least one standard 1 1/2" diameter hole. Refer to the option "Hole(s) for faucet and accessories" in the "À la Carte" tab to determine its position.

Hole(s) for faucet and accessories ⁽²⁾	Option	Price
Far left hole	HP1	Free
Center left hole	HP2	Free
Center hole	HP3	Free
Center right hole	HP4	Free
Far right hole	HP5	Free

2. Depending on the width of the sink, some hole positions may not be available. Please refer to the "À la Carte" tab

ADA	Option	Price
Bowl(s) depth 6"	ADA	Free

Divider	Option	Price
1" wide, 1" from the top of the bowl	DV1	\$ 650
1" wide, 3" from the top of the bowl	DV2	\$ 750
4" wide, 3" from the top of the bowl ⁽³⁾	DV3	\$ 850

3. Please note that this type of divider will add 3" to the overall dimensions of your bowl, which will probably affect the size of your cabinet.

Built-in drainboard	Width	Option	Price
Left built-in drainboard	12"	DB112	\$ 825
	18"	DB118	\$ 925
	24"	DB124	\$ 1,025
Right built-in drainboard	12"	DB212	\$ 825
	18"	DB218	\$ 925
	24"	DB224	\$ 1,025

Built-in drawer ⁽⁴⁾⁽⁵⁾⁽⁶⁾	Option	Price
Left built-in drawer	DW1	\$ 525
Right built-in drawer	DW2	\$ 525

4. Please note that adding a drawer will add 3 1/2" to the overall dimensions of your bowl, which will probably affect the size of your cabinet.

5. Built-in drawer may not be available if option "topmount/flushmount" is selected. Please refer to the "À la Carte" tab.

6. When the ADA option is selected, it is not possible to add a built-in drawer.

Position of the drain(s) – Single bowl ⁽⁷⁾	Option	Price
Rear left corner of the bowl	DP1	\$ 200
Rear right corner of the bowl	DP3	\$ 200
Center left of the bowl	DP4	\$ 200
Center of the bowl	DP5	\$ 200
Center right of the bowl	DP6	\$ 200

Position of the drain(s) – Double bowl ⁽⁷⁾	Option	Price
Center of the bowl	DP55	\$ 200

7. Please note that if you move the drain, the grid recommended for your sink will no longer fit properly. Contact customer service to order your custom grid.

Use our online interactive tool to configure your new creation
homerefinelements.ca/configurator

To access the price of your creation, login using the password
configHR01

JULIEN

955, rue Lachance, Quebec (Quebec) Canada G1P 2H3
T 1 866 901-5624 · 418 687-3630 | F 1 866 397-9090 · 418 687-9129
customerservice@homerefinelements.ca · homerefinelements.ca

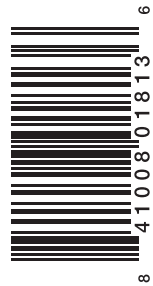

Product no.: 996312007

© Julien 2017. All rights reserved. Printed in Quebec, Canada.