

Introducing  
Module Cooktops



## INTRODUCING JENN-AIR MODULES



The 15" width allows consumers to take advantage of multiple cooking capabilities by adding individual appliances such as a griddle or wok, and provides installation options inside and outside the kitchen

Elegant brass burners effectively direct heat for desired cooking results and can be removed for easy cleaning

Intuitive controls are highly responsive to a light touch, increasing usability while making it easy to clean the cooking surface

A white LED light glows underneath the entire knob when the burner is lit to enhance the premium design



# MODULES FEATURES

A white LED light glows underneath the entire knob when the burner is lit to enhance the premium design

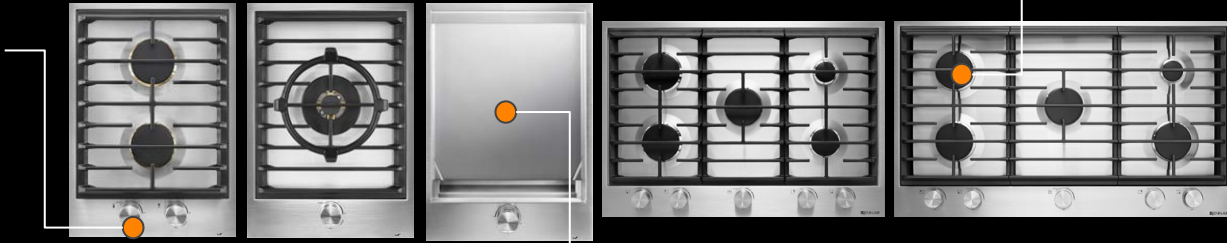

Brass Burners with Removable Base

Even heat distribution for precise results

These elements offer the flexibility to cook using different sizes of cookware on the same element

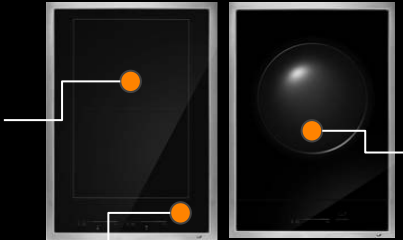

Combines the power and efficiency of induction technology with a unique design that accommodates a round bottom wok

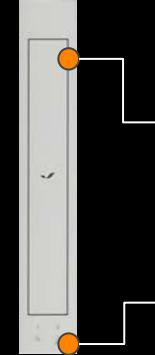

350 CFM convertible to duct-free

Tap touch backlit controls

Glass touch controls and easy-to-read LED display



# INDUCTION MODULES COMPETITIVE LANDSCAPE



JIE4115GS



JIC4715GS

N/A



CI152TS



VI414610

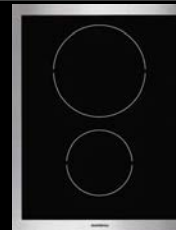

VI424610



CS1221SS

	JIE4115GS	JIC4715GS	N/A	CI152TS	VI414610	VI424610	CS1221SS
<b>Brand</b>	Jenn-Air	Jenn-Air	Wolf	Wolf	Gaggenau	Gaggenau	Miele
<b>Description</b>	15" Concave Induction Wok	15" Induction Flex	No Induction Wok	15" Induction	15" Induction Wok	15" Induction	15" Induction Wok
<b>Traditional Install</b>	Yes	Yes	N/A	Yes	Yes	Yes	No
<b>True Flush</b>	Yes	Yes	N/A	No	Yes	Yes	No
<b>Pricing</b>	\$1999*	\$1199*	N/A	\$1295**	\$3999**	\$2099**	\$1319**
<b>Surface</b>	<u>Concave!</u>	Flat	N/A	Flat	Flat	Flat	Flat
<b>Zones</b>	1	2 w/ Flex	N/A	2	1	2	1
<b>Boost Wattage</b>	3000	3700/3700	N/A	3150/1400	3600	3300/1800	3700

\*All quoted prices UMRP. Retailer alone determines actual resale and advertised price.

\*\*Competitor pricing displayed as publicly displayed in-store or on-line.



# GAS MODULES COMPETITIVE LANDSCAPE



JGC3215GS



JGC3115GS

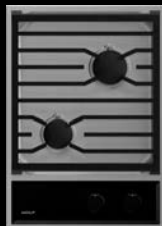

CG152TS



MM15TSX

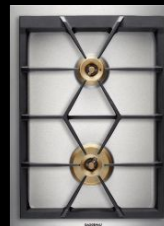

VG424210CA



VG414210CA



CS1028

Brand	Jenn-Air	Jenn-Air	Wolf	Wolf	Gaggenau	Gaggenau	Miele
Description	15" 2 gas burner	15" gas wok	15" 2 gas burner	15" gas wok	15" 2 gas burner	15" gas wok	15" gas wok
Traditional Install	Yes	Yes	Yes	Yes	Yes	Yes	No
True Flush	Yes	Yes	No	No	Yes	Yes	No
Pricing	\$899*	\$1149*	\$949**	\$1299**	\$2399**	\$2099**	\$1199**
BTU	15k/15k	20k	12k/9.2k	22k	14k/6.5k	18.8k	27.3k

\*All quoted prices UMRP. Retailer alone determines actual resale and advertised price.

\*\*Competitor pricing displayed as publicly displayed in-store or on-line.



# JENN-AIR MODULES PRICING



JGC3215GS



JGC3115GS



JEF3115GS



JIE4115GS



JIC4715GS



JVD0303GS



JGC3530GS  
JGC3536GS

Description	Gas 2 Burner	Gas Wok	Chrome Infused Griddle	Induction Wok	Induction Flex	Downdraft System	30"/36" Gas Cooktop
Open to Ship	6/5/17	6/5/17	6/5/17	9/5/17	9/5/17	11/6/17	6/5/17
UMRP	\$899	\$1149	\$1899	\$1999	\$1199	\$2299	\$1499/1599
Cost	\$629	\$804	\$1329	\$1399	\$839	\$1609	\$1049/1119
Trade Margin	30%	30%	30%	30%	30%	30%	30%

\*Prototype units will be available to floor in June of the induction wok, induction flex, and downdraft system



# JENN-AIR MODULES DISPLAY STRATEGY

## 1. Floor production models



JGC3215GS



JGC3115GS



JEF3115GS

## 2. Floor prototype models 6/5 and replace with production models when available



JIE4115GS



JIC4715GS



JVD0303GS

Induction wok production unit will have demo mode

Induction wok, induction flex, & griddle require 220v

Gas 2 burner, gas wok, & downdraft system require 110v



# MODULES TRANSITIONAL PLANNING

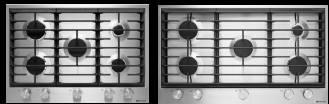

Current models

OTO: 2/8/17  
OTS: 6/5/17



D&O: 6/5/17 OTO: 2/8/17  
OTS: 6/5/17

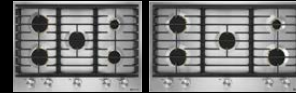

OTO: 2/8/17  
OTS: 9/5/17

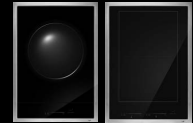

OTO: 8/7/17  
OTS: 11/6/17



Prototype units of induction wok, induction flex, and downdraft system OTO 3/6/17

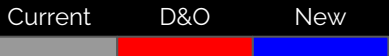

# MODULES PORTFOLIO



**JGC3215GS**  
\$899

- 15" 2 burner gas
- 15k stacked burner
- 15k burner
- Lighted knobs
- Brass burners
- Flush install option
- Matches JGC3530GS & JGC3536GS aesthetics



**JGC3115GS**  
\$1149

- 15" Gas wok
- 20k stacked burner
- Wok ring
- Lighted knobs
- Brass burner
- Flush install option
- Matches JGC3530GS & JGC3536GS aesthetics



**JEF3115GS**  
\$1899

- 15" Chrome infused griddle
- 1800W
- Lighted knobs
- Flush install option
- Pairs up with any module



**JIE4115GS**  
\$1999

- 15" Induction wok
- Touch activated control
- LED light interface
- 3kw boost, 2.3kw nominal
- Flush install option
- Pan detection
- Wifi connectivity



**JIC4715GS**  
\$1199

- 15" Induction flex
- Touch activated control
- LED light interface
- 3.6kw boost, 2.1kw nominal
- Flush install option
- Pan detection
- Wifi connectivity



**JVD0303GS**  
\$2299

- 4" width
- 350CFM
- Tap touch backlit controls
- Design matches modules
- Works with any updraft cooktop
- Flush install option
- Duct-free option



**JGC1530BS**  
\$1499

- 5 Burner 30"
- 19K Stacked
- 2-12K Burner
- 9K Burner
- 6K Burner
- Metal Barrel Knob
- Single point re-ignition

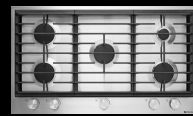

**JGC1536BS**  
\$1599

- 5 Burner 36"
- 20k stacked burner
- 2-12k burner
- 15K Burner
- 6K Burner
- Metal Barrel Knob



**JGC3530GS**  
\$1499

- 30" 5 burner
- Matches module aesthetics
- Removable brass burners
- Lighted knobs
- Flush install option



**JGC3536GS**  
\$1599

- 36" 5 burner
- Matches module aesthetics
- Removable brass burners
- Lighted knobs
- Flush install option

Mounting Bridge Kit	W11035420	Needed to mount any more than 1 cooktop next to each other
14" Round Wok	W11035424	For use with induction wok or gas wok with wok ring
Flat Bottom Wok	W11035423	For use with gas wok without wok ring
Wok Ring	W11035425	For use with gas wok
LP High Altitude Kit	W11027217	Accommodates cooks who reside at higher altitudes using LP
Gas High Altitude Kit	W11027218	Accommodates cooks who reside at higher altitudes using natural gas
Pro-Style Knob Kit	W10678586	For use on any gas module cooktop or griddle

### Mounting bridge kit

Required to install any more than 1 module cooktop next to each other

Available with any 15" module cooktop

Available with downdraft system



# CUSTOMIZABLE VENTILATION OPTIONS

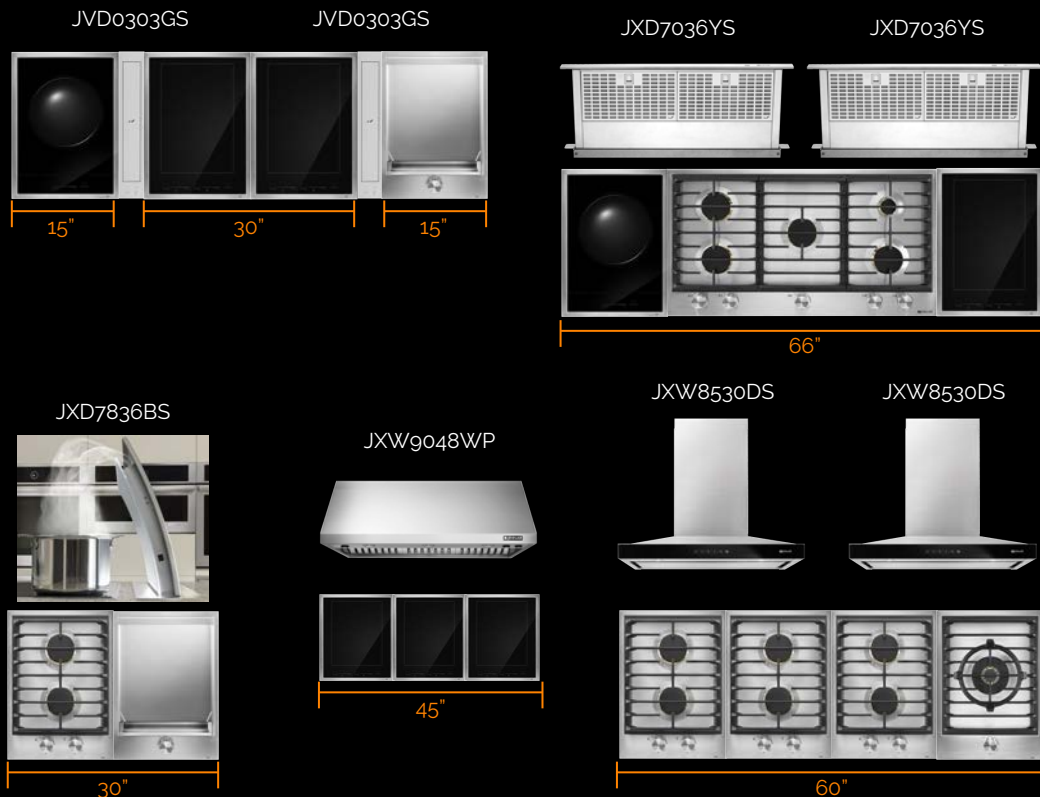

**Module cooktops** can be paired with updraft or downdraft ventilation systems

**One downdraft strip** for every two 15" modules or one 30" cooktop

**Any 30" hoods** for up to two 15" modules or up to one 30" cooktop

**Any 36" hoods** for up to two 15" modules or up to one 36" cooktop

**48" Hood** for up to three 15" modules or a 30" cooktop with one module

**For any combination over 48" width** combine multiple hoods to accommodate necessary width of cooktops



# MODULES PLANNING DIMENSIONS



JGC3215GS



JGC3115GS



JEF3115GS



JIE4115GS



JIC4715GS



JVD0303GS

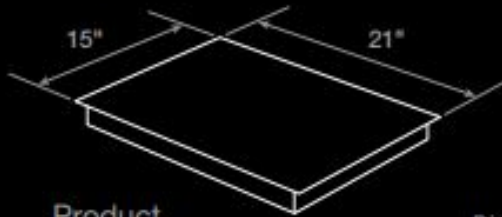

Product  
Dimensions

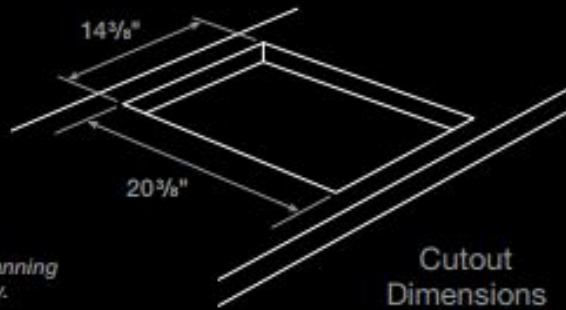

*Dimensions for planning  
purposes only.*

Cutout  
Dimensions

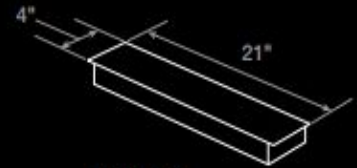

Product  
Dimensions



# MODULES PLANNING DIMENSIONS



JGC3536GS

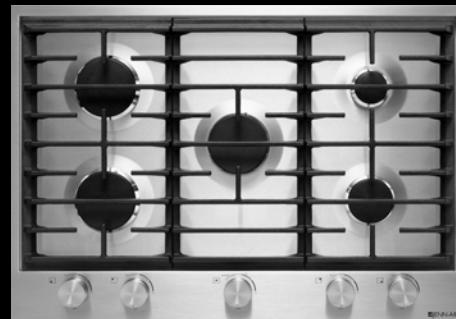
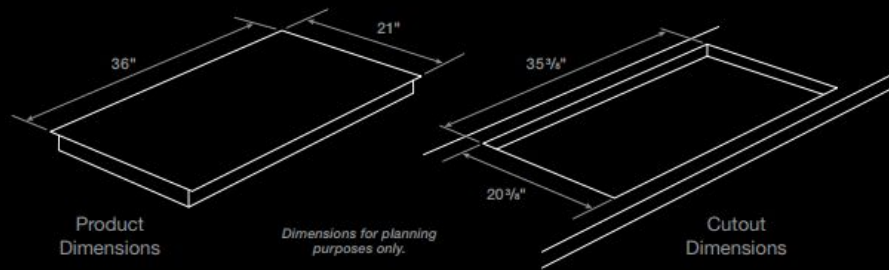

JGC3530GS

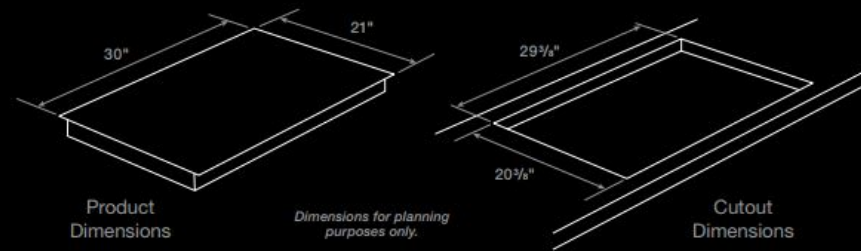

# MODULES COMBINATION INSPIRATION



Endless Possibilities... Always a Perfect Fit

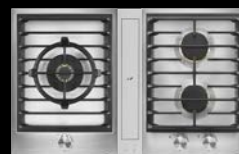
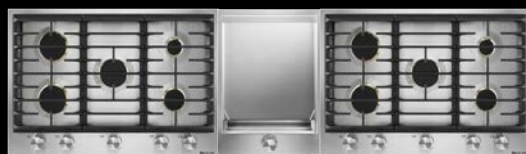
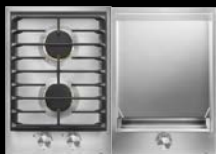
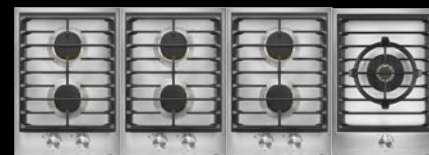

Any combination can be used with updraft or downdraft ventilation

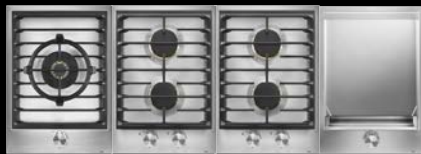

## SET YOUR FLOORS

Use the Modules Flooring Layout Kit:

Contents

Module templates

Actual-size, 3mm boards for each  
module conveniently packaged in a  
carry case

Delivered March week one



FLOORING MENU

1 Replacement

Countertop Installation  
and/or Extension

Drawer



## FLOORING MENU

### 2 Customize

Cut out additional space into an existing display

Add a module to with a new cooktop







## BUY FAIR PRESENCE

AVB, Orlando

Nationwide, New Orleans

Mega, New Orleans



**ENDLESS POSSIBILITIES... ALWAYS A PERFECT FIT.**

Jenn-Air® modular cooktops answer the question, "What if?" (What if a cooktop could truly be custom and truly modular design?) (What if a cooktop could seamlessly blend the benefits of gas and induction all in one cooktop the way you want?)

Our modular cooktops redefine the idea of a custom kitchen, which is exactly what you'd expect from Jenn-Air brand.

Come to our booth to see these remarkable modular cooktops.

Independent Thinking  
Magazine Ad





JennAir.biz (Desktop and Mobile)



Trade News  
Online Articles



Trade Print  
Advertising

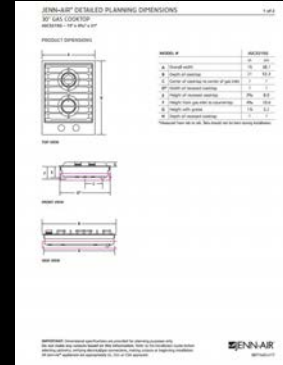

Jenn-Air Product  
Gallery and Mini  
Gallery



Spec Sheets and  
Dimension  
Guides



## AWARENESS



### Event Activations for Modules:

Key product focus in the Booth

Video news release for TV exposure nationally

Participation in media tour

### Media Outreach & Press Release



### Product Featured on Social Media

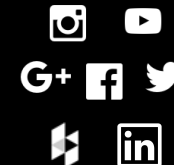

## CONSIDERATION / ACTIVE CONSIDERATION

Dealers | Showrooms | Live Chat | Product Help | Contact Us | My Account | Promotions | Cart |

**JENN-AIR** Appliances | Kitchen Planning | Designers & Trade Professionals | Parts & Accessories | Inspired Living | Customer Care

Home > Appliances > Cooktop > 36" Gas Cooktop

### 36" Gas Cooktop

JGC1536BS  
MSRP \$1,599

Print | Share | Zoom | 360 view

**Overview**

With a 20,000 BTU PowerBurner and a Simmer Burner reaching as low as 800 BTU, this luxury Jenn-Air® gas cooktop is perfect for precision cooking. Its extremely low profile allows for a minimal look or near-flush installation with your countertop.

**Styles**

[Connect with a Dealer](#)  
[Find a Dealer](#)  
[Live Chat](#) with a Customer Care Specialist  
[Sign up](#) for our newsletter

More images & videos

Features	Specifications	Parts & Accessories	Guides & Manuals	Warranty	CAD & Design Files
<p><b>20,000 BTU Dual-Stacked PowerBurner</b></p> <p>The most powerful cooktop burner offered by Jenn-Air, the 20,000 BTU Dual-Stacked PowerBurner can sear, create a rapid boil or achieve high heat for wok cooking, but is still gentle enough for soups, sauces and delicate simmering.</p>	<p><b>Low Profile Design</b></p> <p>With an extremely low profile, you can have a minimal look—nearly flush with the countertop—for an integrated transition to the cooktop.</p>				
				<p><b>Euro-Style Stainless Design</b></p> <p>A refined design that satisfies contemporary and traditional tastes and blends in with other Jenn-Air® Euro-Style Stainless appliances.</p>	



JennAir.com



## MOMENT OF PURCHASE



Product Brochure



Point of purchase  
Swatch Tool  
2"x 9" Double-Sided

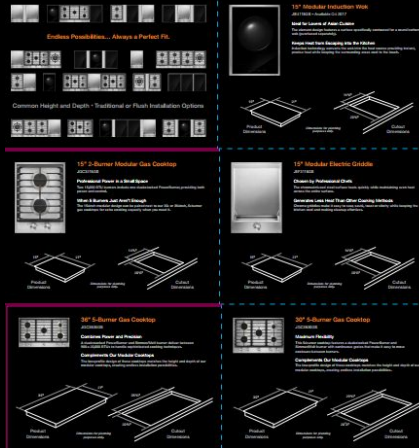

**FREE\***  
**APPLIANCES**  
 NEVER LOOKED SO GOOD.

With qualifying purchase(s), get up to **\$3,300** in instant credits to buy additional appliances.\*

**TIER 1: PURCHASE YOUR COOKING APPLIANCE(S) PLUS ADDITIONAL QUALIFYING PRODUCT AND RECEIVE A \$1,300 INSTANT CREDIT\***





**FREE APPLIANCE\***  
 with instant credit on select appliances. Customer pays any amount over \$1,300.

**TIER 2: PURCHASE A BUILT-IN REFRIGERATOR PLUS ADDITIONAL QUALIFYING PRODUCT AND RECEIVE AN ADDITIONAL \$2,000 INSTANT CREDIT\***



**FREE APPLIANCE\***  
 with instant credit on select appliances. Customer pays any amount over \$2,000.

**COMPLIMENTS OF JENN-AIR BRAND**

Plus, combine with *Installation On Us* for up to a **\$1,000** installation allowance by mail\*\*

OFFERS VALID JANUARY 1-JUNE 30, 2017

**JENN-AIR**

\*Offer only valid at participating Jenn-Air brand retailers in the U.S.A. Receive instant credit deducted from the retail price at the time of purchase. Customer pays difference if retail price of appliance is greater than credit amount. Valid in-store only. Must purchase qualified Jenn-Air brand products on a single receipt to receive instant credit. No substitutions allowed. Visit a participating retailer for complete details.

## 2017 Complements of Jenn-Air Enhancements:

- Integrated “FREE” concept
- One module cooktop qualifies as a cooktop purchase
- Expanded product offering:
  - Added
    - All hoods (even UXL60’s)
    - JMC3415ES microwave
    - Warming drawers
    - Steam oven to built-in package
- “Compliments Check” on-line calculator tool
  - Located under Links tab on .biz

Semi-Annual Program: Jan 1 - June 30, 2017

*\*Note: Built-in refrigeration still **does not** apply to freestanding package promotion in 2017*





# Master Class

JennAir.Biz Resource Web Site



Available on All Mobile & PC Platforms  
Points of Distinction  
Digital Training Guide  
eLearning Course & Quiz  
Quick Reference Guides



Training Incentives





**WARRANTY**



One-year Extended Service Coverage  
when appliances are installed by one of  
our 800 participating installers nationwide



- 1-800-JENN-AIR (536-6247)
- Domestic support 8am - 8pm EST
- 60 dedicated Jenn-Air Care Experts
  - Benton Harbor, MI
  - Cleveland, TN
- Pre-buy guidance
- Owner support for use & care
- Scheduling in-home service
- Parts ordering
- White glove follow-up
- Trade Customer support
  - Builders/Dealers
  - Service companies



- Over 100 major markets covered by the JAS network
- Complementing the JAS network is the larger network of Independent Service Companies extending to rural and remote areas providing coverage in over 96% of all populated U.S. zip codes
- Independent Service Companies (ISC)
  - Servicing Dealers (SD)
  - Self-servicing Dealers (SSD)

2-day service availability  
Pre-diagnostic support  
Priority parts ordering





Thank you.

And thank you for your business.



## APPENDIX





