



41180 Raintree Court
 Murrieta, CA 92562
 1-888-304-0660
 www.waterstoneco.com

ITEM NO: **5500-3**

STYLE: **PULLDOWN**

INTENDED USE:
 KITCHEN FAUCET / PULLDOWN

CUSTOMER NAME:

JOB NO:

DIMENSIONS MAY VARY AND ARE SUBJECT TO CHANGE. NO RESPONSIBILITY IS ASSUMED FOR USE OF SUPERCEDED OR VOIDED DATA

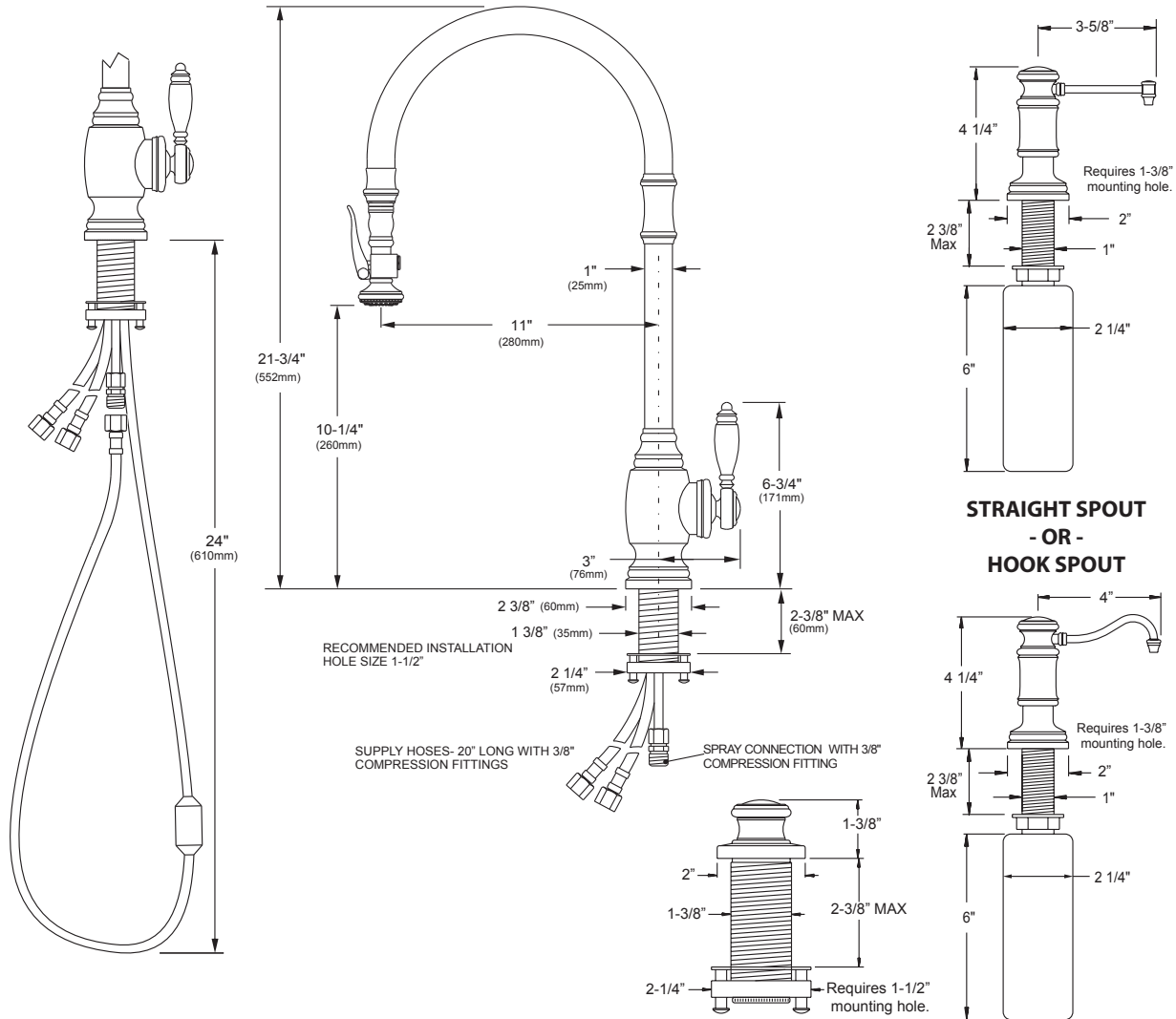

Technical Specifications

- Compatible with Reverse Osmosis filtration systems.
- Unique "PLP" positive lock holds spray head in place.
- Pre-positioned "Easy Pull" counterbalanced weight.
- Spray head extends 18" from spout.
- Toggle select spray or aerated stream.
- 1.75 gpm maximum flow rate with stream selected.
- Solid Brass or Stainless Steel construction.
- Single lever control hot/cold ceramic disk valve cartridge.
- Reversible/removable Hot & Cold indicator ring.
- Handle adjusts 45 degrees in either direction for clearance from backsplash.
- Braided connection hoses.
- Adjustable PTFE "Friction Lock" aids handle feel and prevents sag.
- 360 degree swivel spout.

Codes/Standards Applicable

Specified model meets or exceeds the following:

- ASME A112.18.1
- CSA B125.1
- NSF 61
- CALGreen
- AB 1953

DATE: 6-3-13



MADE IN THE USA