

VITRAFORM

RETAIL PRICE LIST | JUNE 1, 2012

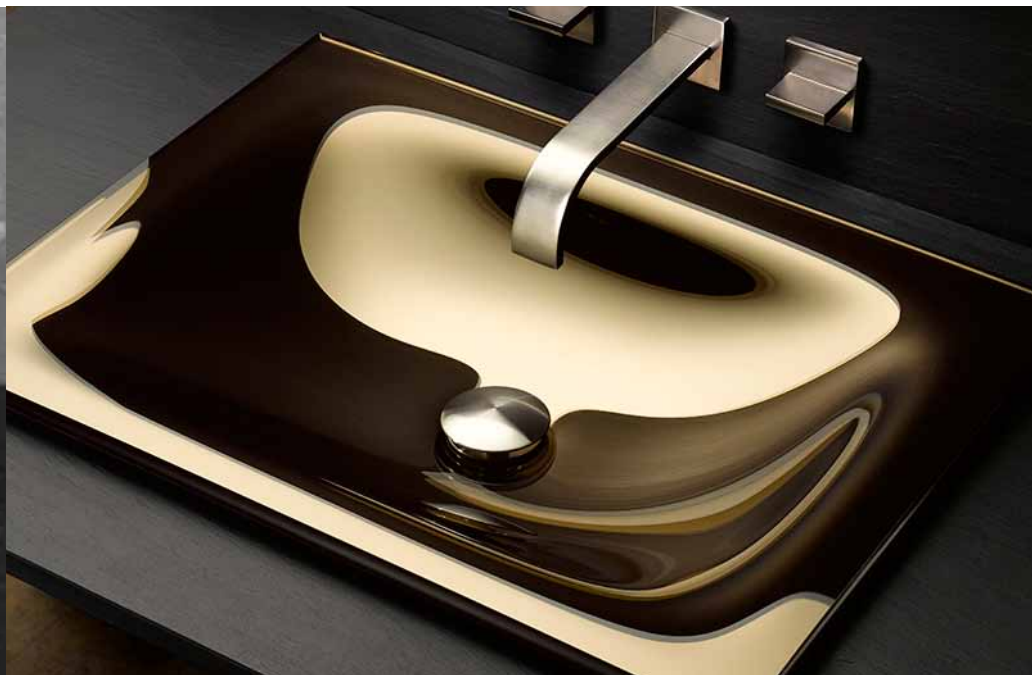

Table of Contents

Retail Price List

STANDARD BASINS



Standard Undermount	
Round and Oval with Overflow	1
Round and Oval without Overflow	2
Rectangular Basin with Overflow	3
Rectangular Basin without Overflow	4

NEW ITEM



Rimless Undermount	
Round with Overflow	7
Round without Overflow	8
Oval with Overflow	9
Oval without Overflow	10

FREESTANDING BASINS



Round	5
Oval	6

COUNTERSINKS



Round or Oval with Overflow	11
Round or Oval without Overflow	12
Rectangular with Overflow	13
Rectangular without Overflow	14

COUNTERTOPS



	15
--	----

WOOD VANITIES



	16
--	----

MIRRORS



	17
--	----

PEDESTALS



Arabesque and Battuto	18
Cono	19
Coppa	20
Cubetto	21
Glass Rod	22
Pullman	23-24

CONSOLES



	25-26
--	-------

WASH STANDS



	27-28
--	-------

DRAINS



	29
--	----

HARDWARE



	30-34
--	-------

ORDERING INFORMATION

	35
--	----

COLORS & FINISHES

	36
--	----

Standard Basin With Overflow To order, select an option in each of columns A–E. Order overflow and Drain separately. Include Item No. and Price. See Example at bottom of page.

Retail Price List

A Select Type of Basin

Price based on Color Groups.

Color Group 1 Pricing

Item	Description	Price
100	Round Undermount 17.5" Dia	\$ 790
150	Oval Undermount 20.75 x 16.25"	\$ 790
101	Round Drop-In 1 17.5" Dia	\$ 910
151	Oval Drop-In 1 20.75 x 16.25"	\$ 910

See NOTE below about color for Drop-in use.

Color Group 2 Pricing

Item	Description	Price
100	Round Undermount 17.5" Dia	\$ 980
150	Oval Undermount 20.75 x 16.25"	\$ 980
101	Round Drop-In 1 17.5" Dia	\$ 1,100
151	Oval Drop-In 1 20.75 x 16.25"	\$ 1,100

See NOTE below about color for Drop-in use.

Color Group 3 Pricing

Item	Description	Price
100	Round Undermount 17.5" Dia	\$ 1,335
150	Oval Undermount 20.75 x 16.25"	\$ 1,335
101	Round Drop-In 1 17.5" Dia	\$ 1,475
151	Oval Drop-In 1 20.75 x 16.25"	\$ 1,475

See NOTE below about color for Drop-in use.

1 Item 101 and 151 is provided with a gasket for Drop-in installation. Black, White and Cobalt polished glass, or any color with White Lami, Mirror or Satin Etched finish do not require a gasket for Drop-in installation. Item 100 and 150 is used for Drop-in installation in these colors or finishes.

B Glass Color

All Vitraform glass has color at the edge. None are devoid of color.

Color Group 1

Item	Color
C	Clear
S	Starphire
Z	Bronze
G	Grey
K	Black

Color Group 2

Item	Color
P	Peach
A	Azurlite
X	Solex

Color Group 3

Item	Color
T	Cobalt
B	Blue
W	White 1
L	Cristal
Q	Cristal Antiq

1 White color only available for engraved basins.

C Glass Finish

Item	Finish	Add
P	Polished	\$ 00
F	Frosted 1	\$ 40
O	White Lami 3	\$ 40
S	Satin Etched 2	\$ 110
M	Mirror 3	\$ 300

1 Frosted finish on bottom surface only.
 2 Satin Etched finish on inside and outside surface.
 3 Mirror or White Lamination is not available on Black, White or Cobalt.
 NOTE: FINISHES FOR ENGRAVINGS
 Frosted finish recommended for Undermount basins with engraving. For Polished finish contact factory. White Lami, Satin Etched and Mirror finishes cannot be engraved.

D Overflow

Overflow required but NOT included. Order separately. See Overflow column at right.

Item	Overflow
F	Overflow

E With Engraving Add

See NOTE in column C for available finishes on engraved basins.

Item	Engraving	Round	Oval
		Add	Add
00	None	\$ 00	\$ 00
11	Empire	\$ 1,240	\$ 1,410
12	Floral 1	\$ 970	\$ 1,145
13	Victorian	\$ 1,240	\$ 1,410
14	Deco	\$ 1,240	\$ 1,410
15	Tulip	\$ 1,240	\$ 1,410
16	Tulip Border	\$ 1,145	\$ 1,320
17	Traditional	\$ 1,145	\$ 1,320
18	Roman	\$ 1,060	\$ 1,235
20	Moderne 1	\$ 1,240	N/A
25	1960		
26	1930		
28	Fine Lines		
29	Bamboo		
30	Battuto		
31	Confetti		
33	Zebra		
34	Tebori		
36	Arabesque		
38	Palmier		
40	Entre Deux		

These engraved designs are not available on Standard Basins. Please refer to price pages 7-9 for Rimless Undermounts to be used with these engraved patterns.

1 Engraving on White see upcharge below. All other designs on White by quotation.

Engraving Color Upcharge

Upcharges for glass color to be added into price. Does not affect item number.

Glass Color	Add
Clear, Cristal, Cristal Antiq, Starphire	\$ 00
Bronze, Grey, Peach, Azurlite, Solex, Blue,	\$ 90
White	\$ 175

NOTE: Engraving on Black, Cobalt or Black & White are not appropriate for Undermount or Drop-in installations. Request assistance.

Overflow Required. Order separately.

See Metal Finish Codes below.

Item	Price	1	2	3	4
Overflow					
911.XX Round	\$ 210	\$ 210	\$ 215	\$ 235	
916.XX Oval	\$ 210	\$ 210	\$ 215	\$ 235	

Drain Optional. Order separately.

See Metal Finish Codes below.

Item	Price	1	2	3	4
Grid Strainer Set					
810.XX w US PTrap	\$ 220	\$ 400	\$ 550	\$ 605	
810.XX.S w Siphon	\$ 375	\$ 555	\$ 705	\$ 760	
Pivot Drain Set					
820.XX w US PTrap	\$ 220	\$ 400	\$ 550	\$ 605	
820.XX.S w Siphon	\$ 375	\$ 555	\$ 705	\$ 760	
Dome Open Set					
860.XX w US PTrap	\$ 220	\$ 400	\$ 550	\$ 605	
860.XX.S w Siphon	\$ 375	\$ 555	\$ 705	\$ 760	
Dome Pop-up Set					
862.XX w US PTrap	\$ 220	\$ 400	\$ 550	\$ 605	
862.XX.S w Siphon	\$ 375	\$ 555	\$ 705	\$ 760	

Metal Finish Codes

1	2	3	4
10 Pol. Chrome	12 Pol. Nickel 20 Sat. Chrome 22 Sat. Nickel	15 ORB 16 Pol. Brass*	13 Pol. Gold* 23 Sat. Gold*

* Brass and Gold Finishes are PVD.



Order Example	A	B	C	D	E	Engraving Color Upcharge	Select an option in each column A-E including Overflow (required) and Drain (optional).
Basin Item No.	100	P	F	F	14		
Basin Price	\$ 980	-	\$ 40	-	\$ 1,235	by Glass Color + \$ 90	Basin Price \$ 2,345
	Round Undermount	Peach	Frosted	Deco Engraving	Overflow		
Overflow Item No.	911	10	Round Overflow / Pol. Chrome Metal Finish (10)		Overflow Price	\$ + 210	
Drain Item No.	820	10	Pivot Drain / Overflow / US PTrap / Pol. Chrome Metal Finish (10)		Drain Price	\$ + 220	
					Total Price	\$ 2,775	

Standard Basin Without Overflow To order, select an option in each of columns A-E. Order Drain Collar and Drain separately. Include Item No. and Price. See Example at bottom of page.

Retail Price List

A Select Type of Basin

Price based on Color Groups.

Color Group 1 Pricing

Item	Description	Price
100	Round Undermount 17.5" Dia	\$ 790
150	Oval Undermount 20.75 x 16.25"	\$ 790
101	Round Drop-In 1 17.5" Dia	\$ 910
151	Oval Drop-In 1 20.75 x 16.25"	\$ 910

See NOTE below about color for Drop-in use.

Color Group 2 Pricing

Item	Description	Price
100	Round Undermount 17.5" Dia	\$ 980
150	Oval Undermount 20.75 x 16.25"	\$ 980
101	Round Drop-In 1 17.5" Dia	\$ 1,100
151	Oval Drop-In 1 20.75 x 16.25"	\$ 1,100

See NOTE below about color for Drop-in use.

Color Group 3 Pricing

Item	Description	Price
100	Round Undermount 17.5" Dia	\$ 1,335
150	Oval Undermount 20.75 x 16.25"	\$ 1,335
101	Round Drop-In 1 17.5" Dia	\$ 1,475
151	Oval Drop-In 1 20.75 x 16.25"	\$ 1,475

See NOTE below about color for Drop-in use.

1 Item 101 and 151 is provided with a gasket for Drop-in installation. Black, White and Cobalt polished glass, or any color with White Lami, Mirror or Satin Etched finish do not require a gasket for Drop-in installation. Item 100 and 150 is used for Drop-in installation in these colors or finishes.

B Glass Color

All Vitraform glass has color at the edge. None are devoid of color.

Color Group 1

Item	Color
C	Clear
S	Starphire
Z	Bronze
G	Grey
K	Black

Color Group 2

Item	Color
P	Peach
A	Azurlite
X	Solex

Color Group 3

Item	Color
T	Cobalt
B	Blue
W	White 1
L	Cristal
Q	Cristal Antiq

1 White color only available for engraved basins.

C Glass Finish

Item	Finish	Add
P	Polished	\$ 00
F	Frosted 1	\$ 40
O	White Lami 3	\$ 40
S	Satin Etched 2	\$ 110
M	Mirror 3	\$ 300

1 Frosted finish on bottom surface only.
 2 Satin Etched finish on inside and outside surface.
 3 Mirror or White Lamination is not available on Black, White or Cobalt.
NOTE: FINISHES FOR ENGRAVINGS
 Frosted finish recommended for Undermount basins with engraving. For Polished finish contact factory. White Lami, Satin Etched and Mirror finishes cannot be engraved.



D Drain Collar

Drain Collar is required but is NOT included. Order separately. See Drain Collar column at right.

Item	Drain Collar
C	Drain Collar

E With Engraving Add

See NOTE in column C for available finishes on engraved basins.

Item	Engraving	Round Add	Oval Add
00	None	\$ 00	\$ 00
11	Empire	\$ 1,240	\$ 1,410
12	Floral 1	\$ 970	\$ 1,145
13	Victorian	\$ 1,240	\$ 1,410
14	Deco	\$ 1,240	\$ 1,410
15	Tulip	\$ 1,240	\$ 1,410
16	Tulip Border	\$ 1,145	\$ 1,320
17	Traditional	\$ 1,145	\$ 1,320
18	Roman	\$ 1,060	\$ 1,235
20	Moderne 1	\$ 1,240	N/A
25	1960		
26	1930		
28	Fine Lines		
29	Bamboo		
30	Battuto		
31	Confetti		
33	Zebra		
34	Tebori		
36	Arabesque		
38	Palmier		
40	Entre Deux		

These engraved designs are not available on Standard Basins. Please refer to price pages 7-9 for Rimless Undermounts to be used with these engraved patterns.

1 Engraving on White see upcharge below. All other designs on White by quotatio

Engraving Color Upcharge

Upcharges for glass color to be added into price. Does not affect item number.

Glass Color	Add
Clear, Cristal, Cristal Antiq, Starphire	\$ 00
Bronze, Grey, Peach, Azurlite, Solex, Blue,	\$ 90
White	\$ 175

NOTE: Engraving on Black, Cobalt or Black & White are not appropriate for Undermount or Drop-in installations. Request assistance.

Drain Collar Required. Order separately.

See Metal Finish Codes below.

Item	Price	1	2	3	4
Drain Collar					
900.XX	\$ 42	\$ 42	\$ 45	\$ 50	

Drain Optional. Order separately.

See Metal Finish Codes below.

Item	Price	1	2	3	4
Grid Strainer Set					
811.XX w US PTrap	\$ 220	\$ 400	\$ 550	\$ 605	
811.XX.S w Siphon	\$ 375	\$ 555	\$ 705	\$ 760	

Pivot Drain Set

821.XX w US PTrap	\$ 220	\$ 400	\$ 550	\$ 605
821.XX.S w Siphon	\$ 375	\$ 555	\$ 705	\$ 760

Dome Open Set

861.XX w US PTrap	\$ 220	\$ 400	\$ 550	\$ 605
861.XX.S w Siphon	\$ 375	\$ 555	\$ 705	\$ 760

Dome Pop-up Set

863.XX w US PTrap	\$ 220	\$ 400	\$ 550	\$ 605
863.XX.S w Siphon	\$ 375	\$ 555	\$ 705	\$ 760

Metal Finish Codes

1	2	3	4
10 Pol. Chrome	12 Pol. Nickel	15 ORB	13 Pol. Gold*
	20 Sat. Chrome	16 Pol. Brass*	23 Sat. Gold*
	22 Sat. Nickel		

* Brass and Gold Finishes are PVD.

Order Example	A	B	C	D	E	Engraving Upcharge by Glass Color	Select an option in each column A-E including Drain Collar (required) and Drain (optional).
Basin Item No.	151	L	F	C	11		
Basin Price	\$ 1,475	-	\$ 40	-	\$ 1,410	+ \$ 00	Basin Price \$ 2,925
	Oval Drop-In Basin	Frosted	Empire Engraving				
	*Cristal		Drain Collar				
Drain Collar Item No.	900	10	Drain Collar / Pol. Chrome Metal Finish (10)				Drain Collar Price \$ + 42
Drain Item No.	861	10S	Dome Drain Set / Siphon / Pol. Chrome Metal Finish (10)				Drain Price \$ + 375
							Total Price \$ 3,342

Rectangular Basin With Overflow To order, select an option in each of columns A–E. Order overflow and Drain separately. Include Item No. and Price. See Example at bottom of page.

Retail Price List

A Select Type of Basin

Price based on Color Groups.

Color Group 1 Pricing

Item	Description	Price
170	Undermount 24"x 18"	\$ 2,530
171	Drop-In 1 24"x 18"	\$ 2,750

See NOTE below about color for Drop-in use.

Color Group 2 Pricing

Item	Description	Price
170	Undermount 24"x 18"	\$ 2,640
171	Drop-In 1 24"x 18"	\$ 2,860

See NOTE below about color for Drop-in use.

Color Group 3 Pricing

Item	Description	Price
170	Undermount 24"x 18"	\$ 3,345
171	Drop-In 1 24"x 18"	\$ 3,605

See NOTE below about color for Drop-in use.

1 Item 171 is provided with a gasket for Drop-in installation. Black, White and Cobalt polished glass, or any color with White Lami, Mirror or Satin Etched finish do not require a gasket for Drop-in installation. Item 170 is used for Drop-in installation in these colors or finishes.

B Glass Color

All Vitraform glass has color at the edge. None are devoid of color.

Color Group 1

Item	Color
C	Clear
S	Starphire
Z	Bronze
G	Grey
K	Black

Color Group 2

Item	Color
P	Peach
A	Azurlite
X	Solex

Color Group 3

Item	Color
T	Cobalt
B	Blue
W	White 1
L	Cristal
Q	Cristal Antiq

1 For White Color specify Starphire glass with White Lamination in Color Group 1.

C Glass Finish

Item	Finish	Add
P	Polished	\$ 00
F	Frosted 1	\$ 110
O	White Lami 3	\$ 110
S	Satin Etched 2	\$ 220
M	Mirror 3	\$ 600

1 Frosted finish on bottom surface only.
 2 Satin Etched finish on inside and outside surface.
 3 Mirror or White Lamination is not available on Black, White or Cobalt.

D Overflow

Overflow required but NOT included. Order separately. See Overflow column at right.

Item	Overflow
F	Overflow

E With Engraving Add

Item	Engraving
00	Request information on engraved designs.



Overflow Required. Order separately.

See Metal Finish Codes below.

Item	Price	1	2	3	4
918.XX Rectangular	\$ 210	\$ 210	\$ 215	\$ 235	

Drain Optional. Order separately.

See Metal Finish Codes below.

Item	Price	1	2	3	4
Grid Strainer Set					
810.XX w US PTrap	\$ 220	\$ 400	\$ 550	\$ 605	
810.XX.S w Siphon	\$ 375	\$ 555	\$ 705	\$ 760	

Pivot Drain Set

820.XX w US PTrap	\$ 220	\$ 400	\$ 550	\$ 605
820.XX.S w Siphon	\$ 375	\$ 555	\$ 705	\$ 760

Dome Open Set

860.XX w US PTrap	\$ 220	\$ 400	\$ 550	\$ 605
860.XX.S w Siphon	\$ 375	\$ 555	\$ 705	\$ 760

Dome Pop-up Set

862.XX w US PTrap	\$ 220	\$ 400	\$ 550	\$ 605
862.XX.S w Siphon	\$ 375	\$ 555	\$ 705	\$ 760

Metal Finish Codes

1	2	3	4
10 Pol. Chrome	12 Pol. Nickel 20 Sat. Chrome 22 Sat. Nickel	15 ORB 16 Pol. Brass*	13 Pol. Gold* 23 Sat. Gold*

* Brass and Gold Finishes are PVD.

Order Example	A	B	C	D	E	Select an option in each column A-E including Overflow (required) and Drain (optional).
Basin Item No.	170	S	F	F	00	
Basin Price	\$ 2,530	-	\$ 110	-	-	Basin Price \$ 2,640
	Rect Undermount	Starphire	Frosted	No Engraving		
Overflow Item No.	918	10	Rect Overflow / Pol. Chrome Metal Finish (10)			Overflow Price \$ + 210
Drain Item No.	820	10	Pivot Drain / Overflow / US PTrap / Pol. Chrome Metal Finish (10)			Drain Price \$ + 220
						Total Price \$ 3,070
Net Crating Charges per pedestal \$125.						
Freight additional, request quotation.						

Rectangular Basin Without Overflow To order, select an option in each of columns A-E. Order Drain Collar and Drain separately. Include Item No. and Price. See Example at bottom of page.

Retail Price List

A Select Type of Basin

Price based on Color Groups.

Color Group 1 Pricing

Item	Description	Price
170	Undermount 24"x 18"	\$ 2,530
171	Drop-In 1 24"x 18"	\$ 2,750

See NOTE below about color for Drop-in use.

Color Group 2 Pricing

Item	Description	Price
170	Undermount 24"x 18"	\$ 2,640
171	Drop-In 1 24"x 18"	\$ 2,860

See NOTE below about color for Drop-in use.

Color Group 3 Pricing

Item	Description	Price
170	Undermount 24"x 18"	\$ 3,345
171	Drop-In 1 24"x 18"	\$ 3,605

See NOTE below about color for Drop-in use.

1 Item 171 is provided with a gasket for Drop-in installation. Black, White and Cobalt polished glass, or any color with White Lami, Mirror or Satin Etched finish do not require a gasket for Drop-in installation. Item 170 is used for Drop-in installation in these colors or finishes.

B Glass Color

All Vitraform glass has color at the edge. None are devoid of color.

Color Group 1

Item	Color
C	Clear
S	Starphire
Z	Bronze
G	Grey
K	Black

Color Group 2

Item	Color
P	Peach
A	Azurlite
X	Solex

Color Group 3

Item	Color
T	Cobalt
B	Blue
W	White 1
L	Cristal
Q	Cristal Antiq

1 For White Color specify Starphire glass with White Lamination in Color Group 1.

C Glass Finish

Item	Finish	Add
P	Polished	\$ 00
F	Frosted 1	\$ 110
O	White Lami 3	\$ 110
S	Satin Etched 2	\$ 220
M	Mirror 3	\$ 600

1 Frosted finish on bottom surface only.
2 Satin Etched finish on inside and outside surface.
3 Mirror or White Lamination is not available on Black, White or Cobalt.



D Drain Collar

Drain Collar is required but is NOT included. Order separately. See Drain Collar column at right.

Item	Drain Collar
C	Drain Collar

E With Engraving Add

Item	Engraving
00	Request information on engraved designs.

Drain Collar Required. Order separately.

See Metal Finish Codes below.

Item	Price	1	2	3	4
Drain Collar					
900.XX	\$ 42	\$ 42	\$ 45	\$ 50	

Drain Optional. Order separately.

See Metal Finish Codes below.

Item	Price	1	2	3	4
Grid Strainer Set					
811.XX w US PTrap	\$ 220	\$ 400	\$ 550	\$ 605	
811.XX.S w Siphon	\$ 375	\$ 555	\$ 705	\$ 760	

Pivot Drain Set

821.XX w US PTrap	\$ 220	\$ 400	\$ 550	\$ 605
821.XX.S w Siphon	\$ 375	\$ 555	\$ 705	\$ 760

Dome Open Set

861.XX w US PTrap	\$ 220	\$ 400	\$ 550	\$ 605
861.XX.S w Siphon	\$ 375	\$ 555	\$ 705	\$ 760

Dome Pop-up Set

863.XX w US PTrap	\$ 220	\$ 400	\$ 550	\$ 605
863.XX.S w Siphon	\$ 375	\$ 555	\$ 705	\$ 760

Metal Finish Codes

1	2	3	4
10 Pol. Chrome	12 Pol. Nickel 20 Sat. Chrome 22 Sat. Nickel	15 ORB 16 Pol. Brass*	13 Pol. Gold* 23 Sat. Gold*

* Brass and Gold Finishes are PVD.

Order Example	A	B	C	D	E	
Basin Item No.	171	B	S	C	00	Select an option in each column A-E including Drain Collar (required) and Drain (optional).
Basin Price	\$ 3,605	-	\$ 220	-	-	Basin Price \$ 3,825
	Rect Drop-In Basin	Satin Etched	No Engraving			
	Blue	Drain Collar				
Drain Collar Item No.	900	10	Drain Collar / Pol. Chrome Metal Finish (10)	Drain Collar Price	\$ + 42	
Drain Item No.	861	10S	Dome Drain Set / Siphon / Pol. Chrome Metal Finish (10)	Drain Price	\$ + 375	
			Total Price	\$	4,242	

Net Crating Charges per pedestal \$125. Freight additional, request quotation.

Freestanding Basin Round

To order, select an option in each of columns A-F. Order Drain separately. Include Item No. and Price. See Example at bottom of page.

Retail Price List

A Select Type of Basin		
Price based on Color Groups.		
Color Group 1 Pricing		
Item	Round	Price
200	Small 14 5/8"	\$ 1,635
210	Large 16 3/4"	\$ 1,695
214	ADA 16 3/4"	\$ 1,695
230	Pencil Edge 17 1/2"	\$ 1,695
Color Group 2 Pricing		
Item	Round	Price
200	Small 14 5/8"	\$ 1,825
210	Large 16 3/4"	\$ 1,890
214	ADA 16 3/4"	\$ 1,890
230	Pencil Edge 17 1/2"	\$ 1,890
Color Group 3 Pricing		
Item	Round	Price
200	Small 14 5/8"	\$ 2,470
210	Large 16 3/4"	\$ 2,540
214	ADA 16 3/4"	\$ 2,540
230	Pencil Edge 17 1/2"	\$ 2,540

B Glass Color	
All Vitraform glass has color at the edge. None are devoid of color.	
Color Group 1	
Item	Color
C	Clear
S	Starphire
Z	Bronze
G	Grey
K	Black
Color Group 2	
Item	Color
P	Peach
A	Azurlite
X	Solex
Color Group 3	
Item	Color
T	Cobalt
B	Blue
W	White ¹
L	Cristal
Q	Cristal Antiq
V	Black & White ¹
¹ White color only available for engraved basins.	

C Glass Finish		
Item	Finish	Add
P	Polished	\$ 00
F	Frosted ¹	\$ 40
O	White Lami ³	\$ 40
S	Satin Etched ²	\$ 110
M	Mirror ³	\$ 300
¹ Frosted finish on bottom surface only. ² Satin Etched finish on top and bottom surface. ³ Mirror or White Lamination is not available on Black, White or Cobalt. NOTE: FINISHES FOR ENGRAVED AND PERLA BASINS: Freestanding basins may be engraved with Polished or Mirror finishes. For Frosted finish contact factory. White Lami and Satin Etched finishes cannot be engraved. PERLA not available with Frosted or Satin Etched finishes.		

D No Overflow	
Not available with overflow.	
Item	
N	No hole

E With Engraving or Perla Add			
		Small	Large
Item	Engraving	Add	Add
00	None	\$ 00	\$ 00
11	Empire	\$ 1,240	\$ 1,410
12	Floral ¹	\$ 970	\$ 1,145
13	Victorian	\$ 1,240	\$ 1,410
14	Deco	\$ 1,240	\$ 1,410
15	Tulip	\$ 1,240	\$ 1,410
16	Tulip Border	\$ 1,145	\$ 1,320
17	Traditional	\$ 1,145	\$ 1,320
18	Roman	\$ 1,060	\$ 1,235
20	Moderne ¹	\$ 1,240	\$ 1,410
25	1960 ^{1 2}	\$ 1,060	\$ 1,235
26	1930 ²	\$ 1,540	\$ 1,720
28	Fine Lines ^{1 2}	\$ 1,100	\$ 1,275
29	Bamboo ²	\$ 1,100	\$ 1,275
30	Battuto ²	\$ 1,940	\$ 2,115
31	Confetti ²	\$ 1,495	\$ 1,675
33	Zebra ²	\$ 1,100	\$ 1,275
34	Tebori ²	\$ 1,760	\$ 1,940
36	Arabesque ²	\$ 1,630	\$ 1,805
38	Palmier ²	\$ 2,510	\$ 2,685
40	Entre Deux ²	\$ 1,405	\$ 1,600
CC	PERLA	\$ 1,460	\$ 1,610
¹ Engraving on White see upcharge below. All other designs on White by quotation. ² Engraving not available on 230 Basin.			

F Base Mount Metal Finish		
Item	Finish	Add
10	Pol. Chrome	\$ 00
12	Pol. Nickel	\$ 00
20	Sat. Chrome	\$ 00
22	Sat. Nickel	\$ 00
15	ORB	\$ 85
16	PVD Pol. Brass	\$ 85
13	PVD Pol. Gold	\$ 145
23	PVD Sat. Gold	\$ 145

Drain Optional. Order separately.

See Metal Finish Codes below.					
Item		Price			
Grid Strainer Set		1	2	3	4
811.XX	w US PTrap	\$ 220	\$ 400	\$ 550	\$ 605
811.XX.S	w Siphon	\$ 375	\$ 555	\$ 705	\$ 760
Pivot Drain Set					
821.XX	w US PTrap	\$ 220	\$ 400	\$ 550	\$ 605
821.XX.S	w Siphon	\$ 375	\$ 555	\$ 705	\$ 760
Dome Open Set					
861.XX	w US PTrap	\$ 220	\$ 400	\$ 550	\$ 605
861.XX.S	w Siphon	\$ 375	\$ 555	\$ 705	\$ 760
Dome Pop-up Set					
863.XX	w US PTrap	\$ 220	\$ 400	\$ 550	\$ 605
863.XX.S	w Siphon	\$ 375	\$ 555	\$ 705	\$ 760



Order Example	A	B	C	D	E	F	Engraving Upcharge by Glass Color	Select an option in each column A-F and Drain (optional).
Basin Item No.	210	A	P	N	20	12		
Basin Price	\$ 1,890	-	\$ 00	-	\$ 1,410	\$ 00	+ \$ 90	Basin Price \$ 3,390
Lrg. Round Freestnd. Polished Moderne Engraving Azurlite No Overflow Pol. Nickel Base Finish								
Drain Item No.	861	10S	Dome Drain Set / Siphon / Pol. Chrome Metal Finish (10)			Drain Price	\$ + 375	
							Total Price	\$ 3,765

Engraving Color Upcharge	
Upcharges for glass color to be added into price for engraving only, not Perla. Does not affect item number.	
Glass Color	Add
Clear, Cristal, Cristal Antiq, Starphire	\$ 00
Bronze, Grey, Peach, Azurlite, Solex, Blue,	\$ 90
White	\$ 175
Black, Cobalt, Black & White	\$ 465

Metal Finish Codes			
1	2	3	4
10 Pol. Chrome	12 Pol. Nickel 20 Sat. Chrome 22 Sat. Nickel	15 ORB 16 Pol. Brass*	13 Pol. Gold* 23 Sat. Gold*

* Brass and Gold Finishes are PVD.

Freestanding Basin Oval To order, select an option in each of columns A-F. Order Drain separately. Include Item No. and Price. See Example at bottom of page.

Retail Price List

A Select Type of Basin

Price based on Color Groups.

Color Group 1 Pricing

Item	Oval	Price
250	Small 13" x 17"	\$ 1,635
260	Large 15" x 19"	\$ 1,695
264	ADA 15" x 19"	\$ 1,695

Color Group 2 Pricing

Item	Oval	Price
250	Small 13" x 17"	\$ 1,825
260	Large 15" x 19"	\$ 1,890
264	ADA 15" x 19"	\$ 1,890

Color Group 3 Pricing

Item	Oval	Price
250	Small 13" x 17"	\$ 2,470
260	Large 15" x 19"	\$ 2,540
264	ADA 15" x 19"	\$ 2,540

B Glass Color

All Vitraform glass has color at the edge. None are devoid of color.

Color Group 1

Item	Color
C	Clear
S	Starphire
Z	Bronze
G	Grey
K	Black

Color Group 2

Item	Color
P	Peach
A	Azurlite
X	Solex

Color Group 3

Item	Color
T	Cobalt
B	Blue
W	White ¹
L	Cristal
Q	Cristal Antiq
V	Black & White ¹

¹ White color only available for engraved basins.

C Glass Finish

Item	Finish	Add
P	Polished	\$ 00
F	Frosted ¹	\$ 40
O	White Lami ³	\$ 40
S	Satin Etched ²	\$ 110
M	Mirror ³	\$ 300

¹ Frosted finish on bottom surface only.
² Satin Etched finish on top and bottom surface.
³ Mirror or White Lamination is not available on Black, White or Cobalt.
 NOTE: FINISHES FOR ENGRAVED AND PERLA BASINS: Freestanding basins may be engraved with Polished or Mirror finishes. For Frosted finish contact factory. White Lami and Satin Etched finishes cannot be engraved. PERLA not available with Frosted or Satin Etched finishes.



D No Overflow

Not available with overflow.

Item	
N	No hole

E With Engraving or Perla Add

Refer to NOTE in column C for available finishes on engraved and PERLA basins.

Small Large

Item	Engraving	Add	Add
00	None	\$ 00	\$ 00
11	Empire	\$ 1,410	\$ 1,585
12	Floral ¹	\$ 1,145	\$ 1,320
13	Victorian	\$ 1,410	\$ 1,585
14	Deco	\$ 1,410	\$ 1,585
15	Tulip	\$ 1,410	\$ 1,585
16	Tulip Border	\$ 1,320	\$ 1,500
17	Traditional	\$ 1,320	\$ 1,500
18	Roman	\$ 1,235	\$ 1,410
20	Moderne ¹	N/A	N/A
25	1960 ¹	\$ 1,235	\$ 1,410
26	1930	\$ 1,720	\$ 1,895
28	Fine Lines ¹	\$ 1,275	\$ 1,455
29	Bamboo	\$ 1,275	\$ 1,455
30	Battuto	\$ 2,115	\$ 2,290
31	Confetti	\$ 1,675	\$ 1,850
33	Zebra	\$ 1,275	\$ 1,455
34	Tebori	\$ 1,940	\$ 2,115
36	Arabesque	\$ 1,805	\$ 1,980
38	Palmier	\$ 2,685	\$ 2,860
40	Entre Deux	\$ 1,600	\$ 1,790
CC	PERLA	\$ 1,610	\$ 2,135

¹ Engraving on White see upcharge below. All other designs on White by quotation.

Engraving Color Upcharge

Upcharges for glass color to be added into price for engraving only, not Perla. Does not affect item number.

Glass Color	Add
Clear, Cristal, Cristal Antiq, Starphire,	\$ 00
Bronze, Grey, Peach, Azurlite, Solex, Blue,	\$ 90
White	\$ 175
Black, Cobalt, Black & White	\$ 465

F Base Mount Metal Finish

Item	Finish	Add
10	Pol. Chrome	\$ 00
12	Pol. Nickel	\$ 00
20	Sat. Chrome	\$ 00
22	Sat. Nickel	\$ 00
15	ORB	\$ 85
16	PVD Pol. Brass	\$ 85
13	PVD Pol. Gold	\$ 145
23	PVD Sat. Gold	\$ 145

Drain Optional. Order separately.

See Metal Finish Codes below.

Item	Price	1	2	3	4
Grid Strainer Set					
811.XX w US PTrap	\$ 220	\$ 400	\$ 550	\$ 605	
811.XX.S w Siphon	\$ 375	\$ 555	\$ 705	\$ 760	

Item	Price	1	2	3	4
Pivot Drain Set					
821.XX w US PTrap	\$ 220	\$ 400	\$ 550	\$ 605	
821.XX.S w Siphon	\$ 375	\$ 555	\$ 705	\$ 760	

Item	Price	1	2	3	4
Dome Open Set					
861.XX w US PTrap	\$ 220	\$ 400	\$ 550	\$ 605	
861.XX.S w Siphon	\$ 375	\$ 555	\$ 705	\$ 760	

Item	Price	1	2	3	4
Dome Pop-up Set					
863.XX w US PTrap	\$ 220	\$ 400	\$ 550	\$ 605	
863.XX.S w Siphon	\$ 375	\$ 555	\$ 705	\$ 760	

Metal Finish Codes

1	2	3	4
10 Pol. Chrome	12 Pol. Nickel	15 ORB	13 Pol. Gold*
	20 Sat. Chrome	16 Pol. Brass*	23 Sat. Gold*
	22 Sat. Nickel		

* Brass and Gold Finishes are PVD.

Order Example	A	B	C	D	E	F	Engraving Upcharge by Glass Color	Select an option in each column A-F and Drain (optional).
Basin Item No.	250	X	P	N	34	22		
Basin Price	\$ 1,825	-	\$ 00	-	\$ 1,940	\$ 00	+ \$ 90	Basin Price \$ 3,855
	Small Oval Freestnd.	Solex	Polished	No Overflow	Tebori Engraving	Satin Nickel Base Finish		
Drain Item No.	861	22S	Dome Drain Set / Siphon / Satin Nickel Metal Finish (22)			Drain Price	\$ + 555	
						Total Price	\$ 4,410	

Round Rimless Undermount With Overflow To order, select an option in each of columns A-E. Order overflow and Drain separately. Include Item No. and Price. See Example at bottom of page. Retail Price List

A Select Type of Basin			B Glass Color	
Price based on Color Groups.			All Vitraform glass has color at the edge. None are devoid of color.	
Color Group 1 Pricing			Color Group 1	
Item	Round	Price	Item	Color
203	Small 13" Cutout	\$ 1,230	C	Clear
213	Large 15" Cutout	\$ 1,290	S	Starphire
			Z	Bronze
			G	Grey
			K	Black
Color Group 2 Pricing			Color Group 2	
Item	Round	Price	Item	Color
203	Small 13" Cutout	\$ 1,420	P	Peach
213	Large 15" Cutout	\$ 1,480	A	Azurlite
			X	Solex
Color Group 3 Pricing			Color Group 3	
Item	Round	Price	Item	Color
203	Small 13" Cutout	\$ 1,850	T	Cobalt
213	Large 15" Cutout	\$ 1,920	B	Blue
			W	White ¹
			L	Cristal
			Q	Cristal Antiq
			1 White color only available for engraved basins.	

C Glass Finish		
Item	Finish	Add
P	Polished	\$ 00
F	Frosted ¹	\$ 40
O	White Lami ³	\$ 40
S	Satin Etched ²	\$ 110
M	Mirror ³	\$ 300
¹ Frosted finish on bottom surface only. ² Satin Etched finish on inside and outside surface. ³ Mirror or White Lamination is not available on Black, White or Cobalt. NOTE: FINISHES FOR ENGRAVINGS Frosted finish recommended for Undermount basins with engraving. For Polished finish contact factory. White Lami, Satin Etched and Mirror finishes cannot be engraved. NOTE: Engraving on Black, Cobalt and Black & White are not recommended.		

D Overflow	
Overflow required but NOT included. Order separately. See Overflow column at right.	
Item	Price
F	Overflow

E With Engraving Add			
See NOTE in column C for available finishes on engraved basins.			
Item	Engraving	Small Add	Large Add
00	None	\$ 00	\$ 00
11	Empire	\$ 1,240	\$ 1,410
12	Floral ¹	\$ 970	\$ 1,145
13	Victorian	\$ 1,240	\$ 1,410
14	Deco	\$ 1,240	\$ 1,410
15	Tulip	\$ 1,240	\$ 1,410
16	TulipBorder	\$ 1,145	\$ 1,320
17	Traditional	\$ 1,145	\$ 1,320
18	Roman	\$ 1,060	\$ 1,235
20	Moderne ¹	\$ 1,240	\$ 1,410
25	1960 ¹	\$ 1,060	\$ 1,235
26	1930	\$ 1,540	\$ 1,720
28	Fine Lines ¹	\$ 1,100	\$ 1,275
29	Bamboo	\$ 1,100	\$ 1,275
30	Battuto	\$ 1,940	\$ 2,115
31	Confetti	\$ 1,495	\$ 1,675
33	Zebra	\$ 1,100	\$ 1,275
34	Tebori	\$ 1,760	\$ 1,940
36	Arabesque	\$ 1,630	\$ 1,805
38	Palmier	\$ 2,510	\$ 2,685
40	Entre Deux	\$ 1,405	\$ 1,600
1 Engraving on White see upcharge below. All other designs on White by quotation.			

Overflow Required. Order separately.					
See Metal Finish Codes below.					
Item	Price	1	2	3	4
Overflow					
911.XX Small Round	\$ 210	\$ 210	\$ 215	\$ 235	
912.XX Large Round	\$ 210	\$ 210	\$ 215	\$ 235	

Drain Optional. Order separately.					
See Metal Finish Codes below.					
Item	Price	1	2	3	4
Grid Strainer Set					
810.XX w US PTrap	\$ 220	\$ 400	\$ 550	\$ 605	
810.XX.S w Siphon	\$ 375	\$ 555	\$ 705	\$ 760	
Pivot Drain Set					
820.XX w US PTrap	\$ 220	\$ 400	\$ 550	\$ 605	
820.XX.S w Siphon	\$ 375	\$ 555	\$ 705	\$ 760	
Dome Open Set					
860.XX w US PTrap	\$ 220	\$ 400	\$ 550	\$ 605	
860.XX.S w Siphon	\$ 375	\$ 555	\$ 705	\$ 760	
Dome Pop-up Set					
862.XX w US PTrap	\$ 220	\$ 400	\$ 550	\$ 605	
862.XX.S w Siphon	\$ 375	\$ 555	\$ 705	\$ 760	

Metal Finish Codes			
1	2	3	4
10 Pol. Chrome	12 Pol. Nickel 20 Sat. Chrome 22 Sat. Nickel	15 ORB 16 Pol. Brass*	13 Pol. Gold* 23 Sat. Gold*
* Brass and Gold Finishes are PVD.			



Engraving Color Upcharge	
Upcharges for glass color to be added into price. Does not affect item number.	
Glass Color	Add
Clear, Cristal, Cristal Antiq, Starphire	\$ 00
Bronze, Grey, Peach, Azurlite, Solex, Blue,	\$ 90
White	\$ 175
NOTE: Engraving on Black, Cobalt or Black & White are not offered for Rimless Installation. Request assistance.	

Order Example	A	B	C	D	E	Engraving Upcharge by Glass Color	Select an option in each column A-E including Overflow (required) and Drain (optional).
Basin Item No.	213	P	F	F	20		
Basin Price	\$ 1,480	-	\$ 40	-	\$ 1,410	+ \$ 90	Basin Price \$ 3,020
	Lrg. Round Rimless	Peach	Frosted	Overflow	Moderne Engraving		
Overflow Item No.	912	12	Lg Round Overflow / Pol. Nickel Metal Finish (12)		Overflow Price	\$ + 210	
Drain Item No.	820	12	Pivot Drain / Overflow / US PTrap / Pol. Nickel Metal Finish (12)		Drain Price	\$ + 400	
					Total Price	\$ 3,630	

Round Rimless Undermount Without Overflow

To order, select an option in each of columns A-E. Order Drain Collar and Drain separately. Include Item No. and Price. See Example at bottom of page.

Retail Price List

A Select Type of Basin			B Glass Color	
Price based on Color Groups.			All Vitraform glass has color at the edge. None are devoid of color.	
Color Group 1 Pricing			Color Group 1	
Item	Round	Price	Item	Color
203	Small 13" Cutout	\$ 1,230	C	Clear
213	Large 15" Cutout	\$ 1,290	S	Starphire
			Z	Bronze
			G	Grey
			K	Black
Color Group 2 Pricing			Color Group 2	
Item	Round	Price	Item	Color
203	Small 13" Cutout	\$ 1,420	P	Peach
213	Large 15" Cutout	\$ 1,480	A	Azurlite
			X	Solex
Color Group 3 Pricing			Color Group 3	
Item	Round	Price	Item	Color
203	Small 13" Cutout	\$ 1,850	T	Cobalt
213	Large 15" Cutout	\$ 1,920	B	Blue
			W	White ¹
			L	Cristal
			Q	Cristal Antiq
			1 White color only available for engraved basins.	

C Glass Finish		
Item	Finish	Add
P	Polished	\$ 00
F	Frosted ¹	\$ 40
O	White Lami ³	\$ 40
S	Satin Etched ²	\$ 110
M	Mirror ³	\$ 300
¹ Frosted finish on bottom surface only. ² Satin Etched finish on inside and outside surface. ³ Mirror or White Lamination is not available on Black, White or Cobalt. NOTE: FINISHES FOR ENGRAVINGS Frosted finish recommended for Undermount basins with engraving. For Polished finish contact factory. White Lami, Satin Etched and Mirror finishes cannot be engraved. NOTE: Engraving on Black, Cobalt and Black & White are not recommended.		

D Drain Collar	
Drain Collar is required but is NOT included. Order separately. See Drain Collar column at right.	
Item	Price
C	Drain Collar

E With Engraving Add			
See NOTE in column C for available finishes on engraved basins.			
Item	Engraving	Small Add	Large Add
00	None	\$ 00	\$ 00
11	Empire	\$ 1,240	\$ 1,410
12	Floral ¹	\$ 970	\$ 1,145
13	Victorian	\$ 1,240	\$ 1,410
14	Deco	\$ 1,240	\$ 1,410
15	Tulip	\$ 1,240	\$ 1,410
16	Tulip Border	\$ 1,145	\$ 1,320
17	Traditional	\$ 1,145	\$ 1,320
18	Roman	\$ 1,060	\$ 1,235
20	Moderne ¹	\$ 1,240	\$ 1,410
25	1960 ¹	\$ 1,060	\$ 1,235
26	1930	\$ 1,540	\$ 1,720
28	Fine Lines ¹	\$ 1,100	\$ 1,275
29	Bamboo	\$ 1,100	\$ 1,275
30	Battuto	\$ 1,940	\$ 2,115
31	Confetti	\$ 1,495	\$ 1,675
33	Zebra	\$ 1,100	\$ 1,275
34	Tebori	\$ 1,760	\$ 1,940
36	Arabesque	\$ 1,630	\$ 1,805
38	Palmier	\$ 2,510	\$ 2,685
40	Entre Deux	\$ 1,405	\$ 1,600
1 Engraving on White see upcharge below. All other designs on White by quotation.			

Drain Collar Required. Order separately.				
See Metal Finish Codes below.				
Item	Price			
Drain Collar	1	2	3	4
900.XX	\$ 42	\$ 42	\$ 45	\$ 50

Drain Optional. Order separately.				
See Metal Finish Codes below.				
Item	Price			
Grid Strainer Set	1	2	3	4
811.XX w US PTrap	\$ 220	\$ 400	\$ 550	\$ 605
811.XX.S w Siphon	\$ 375	\$ 555	\$ 705	\$ 760

Pivot Drain Set				
821.XX w US PTrap	\$ 220	\$ 400	\$ 550	\$ 605
821.XX.S w Siphon	\$ 375	\$ 555	\$ 705	\$ 760

Dome Open Set				
861.XX w US PTrap	\$ 220	\$ 400	\$ 550	\$ 605
861.XX.S w Siphon	\$ 375	\$ 555	\$ 705	\$ 760

Dome Pop-up Set				
863.XX w US PTrap	\$ 220	\$ 400	\$ 550	\$ 605
863.XX.S w Siphon	\$ 375	\$ 555	\$ 705	\$ 760

Metal Finish Codes			
1	2	3	4
10 Pol. Chrome	12 Pol. Nickel 20 Sat. Chrome 22 Sat. Nickel	15 ORB 16 Pol. Brass*	13 Pol. Gold* 23 Sat. Gold*
* Brass and Gold Finishes are PVD.			



Order Example	A	B	C	D	E	Engraving Upcharge by Glass Color	Select an option in each column A-E including Drain Collar (required) and Drain (optional).
Basin Item No.	213	S	P	C	26		
Basin Price	\$ 1,290	-	\$ 00	-	\$ 1,720	+ \$ 00	Basin Price \$ 3,010
	Lrg. Round Rimless	Polished	Starphire	1930 Engraving	Drain Collar		
Drain Collar Item No.	900	12	Drain Collar / Pol. Nickel Metal Finish (12)		Drain Collar Price	\$	+ 42
Drain Item No.	861	12S	Dome Drain Set / Siphon / Pol. Nickel Metal Finish (12)		Drain Price	\$	+ 555
					Total Price	\$	3,607

Engraving Color Upcharge	
Upcharges for glass color to be added into price. Does not affect item number.	
Glass Color	Add
Clear, Cristal, Cristal Antiq, Starphire	\$ 00
Bronze, Grey, Peach, Azurlite, Solex, Blue,	\$ 90
White	\$ 175
NOTE: Engraving on Black, Cobalt or Black & White are not offered for Rimless Installation. Request assistance.	

Oval Rimless Undermount With Overflow To order, select an option in each of columns A-E. Order overflow and Drain separately. Include Item No. and Price. See Example at bottom of page. Retail Price List

A Select Type of Basin		
Price based on Color Groups.		
Color Group 1 Pricing		
Item	Oval	Price
253	Small 11 1/2" x 15" Cutout	\$ 1,230
263	Large 13 1/4" x 17 1/4" Cutout	\$ 1,290
Color Group 2 Pricing		
Item	Oval	Price
253	Small 11 1/2" x 15" Cutout	\$ 1,420
263	Large 13 1/4" x 17 1/4" Cutout	\$ 1,480
Color Group 3 Pricing		
Item	Oval	Price
253	Small 11 1/2" x 15" Cutout	\$ 1,850
263	Large 13 1/4" x 17 1/4" Cutout	\$ 1,920

B Glass Color	
All Vitraform glass has color at the edge. None are devoid of color.	
Color Group 1	
Item	Color
C	Clear
S	Starphire
Z	Bronze
G	Grey
K	Black
Color Group 2	
Item	Color
P	Peach
A	Azurlite
X	Solex
Color Group 3	
Item	Color
T	Cobalt
B	Blue
W	White ¹
L	Cristal
Q	Cristal Antiq
¹ White color only available for engraved basins.	

C Glass Finish		
Item	Finish	Add
P	Polished	\$ 00
F	Frosted ¹	\$ 40
O	White Lami ³	\$ 40
S	Satin Etched ²	\$ 110
M	Mirror ³	\$ 300
¹ Frosted finish on bottom surface only. ² Satin Etched finish on inside and outside surface. ³ Mirror or White Lamination is not available on Black, White or Cobalt. NOTE: FINISHES FOR ENGRAVINGS Frosted finish recommended for Undermount basins with engraving. For Polished finish contact factory. White Lami, Satin Etched and Mirror finishes cannot be engraved. NOTE: Engraving on Black, Cobalt and Black & White are not recommended.		

D Overflow	
Overflow required but NOT included. Order separately. See Overflow column at right.	
Item	Overflow
F	Overflow

E With Engraving Add			
See NOTE in column C for available finishes on engraved basins.			
Item	Engraving	Small Add	Large Add
00	None	\$ 00	\$ 00
11	Empire	\$ 1,410	\$ 1,585
12	Floral ¹	\$ 1,145	\$ 1,320
13	Victorian	\$ 1,410	\$ 1,585
14	Deco	\$ 1,410	\$ 1,585
15	Tulip	\$ 1,410	\$ 1,585
16	Tulip Border	\$ 1,320	\$ 1,500
17	Traditional	\$ 1,320	\$ 1,500
18	Roman	\$ 1,235	\$ 1,410
20	Moderne ¹	N/A	N/A
25	1960 ¹	\$ 1,235	\$ 1,410
26	1930	\$ 1,720	\$ 1,895
28	Fine Lines ¹	\$ 1,275	\$ 1,455
29	Bamboo	\$ 1,275	\$ 1,455
30	Battuto	\$ 2,115	\$ 2,290
31	Confetti	\$ 1,675	\$ 1,850
33	Zebra	\$ 1,275	\$ 1,455
34	Tebori	\$ 1,940	\$ 2,115
36	Arabesque	\$ 1,805	\$ 1,980
38	Palmier	\$ 2,685	\$ 2,860
40	Entre Deux	\$ 1,600	\$ 1,790

Overflow Required. Order separately.					
See Metal Finish Codes below.					
Item	Price	1	2	3	4
Overflow					
916.XX Small Oval	\$ 210	\$ 210	\$ 215	\$ 235	
917.XX Large Oval	\$ 210	\$ 210	\$ 215	\$ 235	
Drain Optional. Order separately.					
See Metal Finish Codes below.					
Item	Price	1	2	3	4
Grid Strainer Set					
810.XX w US PTrap	\$ 220	\$ 400	\$ 550	\$ 605	
810.XX.S w Siphon	\$ 375	\$ 555	\$ 705	\$ 760	
Pivot Drain Set					
820.XX w US PTrap	\$ 220	\$ 400	\$ 550	\$ 605	
820.XX.S w Siphon	\$ 375	\$ 555	\$ 705	\$ 760	
Dome Open Set					
860.XX w US PTrap	\$ 220	\$ 400	\$ 550	\$ 605	
860.XX.S w Siphon	\$ 375	\$ 555	\$ 705	\$ 760	
Dome Pop-up Set					
862.XX w US PTrap	\$ 220	\$ 400	\$ 550	\$ 605	
862.XX.S w Siphon	\$ 375	\$ 555	\$ 705	\$ 760	



¹ Engraving on White see upcharge below. All other designs on White by quotation.

Engraving Color Upcharge

Upcharges for glass color to be added into price. Does not affect item number.

Glass Color	Add
Clear, Cristal, Cristal Antiq, Starphire	\$ 00
Bronze, Grey, Peach, Azurlite, Solex, Blue,	\$ 90
White	\$ 175
NOTE: Engraving on Black, Cobalt or Black & White are not offered for Rimless Installation. Request assistance.	

Metal Finish Codes

1	2	3	4
10 Pol. Chrome	12 Pol. Nickel 20 Sat. Chrome 22 Sat. Nickel	15 ORB 16 Pol. Brass*	13 Pol. Gold* 23 Sat. Gold*

* Brass and Gold Finishes are PVD.

Order Example	A	B	C	D	E	Engraving Upcharge by Glass Color	Select an option in each column A-E including Overflow (required) and Drain (optional).
Basin Item No.	263	L	P	F	30		
Basin Price	\$ 1,920	-	\$ 00	-	\$ 2,290	+ \$ 00	Basin Price \$ 4,210
Lrg. Oval Rimless		Polished		Battuto Engraving			
Cristal		Overflow					
Overflow Item No.	917	13	Lg Oval Overflow / PVD Pol. Gold Metal Finish (13)			Overflow Price	\$ + 235
Drain Item No.	820	13	Pivot Drain / Overflow / US PTrap / PVD Pol. Gold Metal Finish (13)			Drain Price	\$ + 605
						Total Price	\$ 5,050

Oval Rimless Undermount Without Overflow Retail Price List

A Select Type of Basin

Price based on Color Groups.

Color Group 1 Pricing

Item	Oval	Price
253	Small 11 1/2" x 15" Cutout	\$ 1,230
263	Large 13 1/4" x 17 1/4" Cutout	\$ 1,290

Color Group 2 Pricing

Item	Oval	Price
253	Small 11 1/2" x 15" Cutout	\$ 1,420
263	Large 13 1/4" x 17 1/4" Cutout	\$ 1,480

Color Group 3 Pricing

Item	Oval	Price
253	Small 11 1/2" x 15" Cutout	\$ 1,850
263	Large 13 1/4" x 17 1/4" Cutout	\$ 1,920

B Glass Color

All Vitraform glass has color at the edge. None are devoid of color.

Color Group 1

Item	Color
C	Clear
S	Starphire
Z	Bronze
G	Grey
K	Black

Color Group 2

Item	Color
P	Peach
A	Azurlite
X	Solex

Color Group 3

Item	Color
T	Cobalt
B	Blue
W	White ¹
L	Cristal
Q	Cristal Antiq

¹ White color only available for engraved basins.

C Glass Finish

Item	Finish	Add
P	Polished	\$ 00
F	Frosted ¹	\$ 40
O	White Lami ³	\$ 40
S	Satin Etched ²	\$ 110
M	Mirror ³	\$ 300

¹ Frosted finish on bottom surface only.
² Satin Etched finish on inside and outside surface.
³ Mirror or White Lamination is not available on Black, White or Cobalt.
 NOTE: FINISHES FOR ENGRAVINGS
 Frosted finish recommended for Undermount basins with engraving. For Polished finish contact factory. White Lami, Satin Etched and Mirror finishes cannot be engraved.
 NOTE: Engraving on Black, Cobalt and Black & White are not recommended.

D Drain Collar

Drain Collar is required but is NOT included. Order separately. See Drain Collar column at right.

Item	Price
C	Drain Collar

E With Engraving Add

See NOTE in column C for available finishes on engraved basins.

Item	Engraving	Small Add	Large Add
00	None	\$ 00	\$ 00
11	Empire	\$ 1,410	\$ 1,585
12	Floral ¹	\$ 1,145	\$ 1,320
13	Victorian	\$ 1,410	\$ 1,585
14	Deco	\$ 1,410	\$ 1,585
15	Tulip	\$ 1,410	\$ 1,585
16	Tulip Border	\$ 1,320	\$ 1,500
17	Traditional	\$ 1,320	\$ 1,500
18	Roman	\$ 1,235	\$ 1,410
20	Moderne ¹	N/A	N/A
25	1960 ¹	\$ 1,235	\$ 1,410
26	1930	\$ 1,720	\$ 1,895
28	Fine Lines ¹	\$ 1,275	\$ 1,455
29	Bamboo	\$ 1,275	\$ 1,455
30	Battuto	\$ 2,115	\$ 2,290
31	Confetti	\$ 1,675	\$ 1,850
33	Zebra	\$ 1,275	\$ 1,455
34	Tebori	\$ 1,940	\$ 2,115
36	Arabesque	\$ 1,805	\$ 1,980
38	Palmier	\$ 2,685	\$ 2,860
40	Entre Deux	\$ 1,600	\$ 1,790

¹ Engraving on White see upcharge below. All other designs on White by quotation.

Engraving Color Upcharge

Upcharges for glass color to be added into price. Does not affect item number.

Glass Color	Add
Clear, Cristal, Cristal Antiq, Starphire	\$ 00
Bronze, Grey, Peach, Azurlite, Solex, Blue,	\$ 90
White	\$ 175

NOTE: Engraving on Black, Cobalt or Black & White are not offered for Rimless Installation. Request assistance.

Drain Collar Required. Order separately.

See Metal Finish Codes below.

Item	Price
Drain Collar	1 2 3 4
900.XX	\$ 42 \$ 42 \$ 45 \$ 50

Drain Optional. Order separately.

See Metal Finish Codes below.

Item	Price
Grid Strainer Set	1 2 3 4
811.XX w US PTrap	\$ 220 \$ 400 \$ 550 \$ 605
811.XX.S w Siphon	\$ 375 \$ 555 \$ 705 \$ 760

Pivot Drain Set

821.XX w US PTrap	\$ 220 \$ 400 \$ 550 \$ 605
821.XX.S w Siphon	\$ 375 \$ 555 \$ 705 \$ 760

Dome Open Set

861.XX w US PTrap	\$ 220 \$ 400 \$ 550 \$ 605
861.XX.S w Siphon	\$ 375 \$ 555 \$ 705 \$ 760

Dome Pop-up Set

863.XX w US PTrap	\$ 220 \$ 400 \$ 550 \$ 605
863.XX.S w Siphon	\$ 375 \$ 555 \$ 705 \$ 760

Metal Finish Codes

1	2	3	4
10 Pol. Chrome	12 Pol. Nickel	15 ORB	13 Pol. Gold*
	20 Sat. Chrome	16 Pol. Brass*	23 Sat. Gold*
	22 Sat. Nickel		

* Brass and Gold Finishes are PVD.



Order Example	A	B	C	D	E	Engraving Upcharge by Glass Color	Select an option in each column A-E including Drain Collar (required) and Drain (optional).
Basin Item No.	253	Z	F	C	15		
Basin Price	\$ 1,230	-	\$ 40	-	\$ 1,410	+ \$ 90	Basin Price \$ 2,770
	Small Oval Rimless	Bronze	Frosted	Drain Collar	Tulip Engraving		
Drain Collar Item No.	900	10	Drain Collar / Pol. Chrome Metal Finish (10)		Drain Collar Price	\$ + 42	
Drain Item No.	861	10S	Dome Drain Set / Siphon / Pol. Chrome Metal Finish (10)		Drain Price	\$ + 375	
					Total Price	\$ 3,187	

Countersink/Round or Oval Basin With Overflow To order, select an option in each of columns A-E. Order overflow and Drain separately. Include Item No. and Price. See Example at bottom of page. Retail Price List

A Specify Model

Single Basin	
Item	Description
Rectangular Front	
300	Single Round Basin
350	Single Oval Basin
Radius front	
400	Single Round Basin
450	Single Oval Basin
Double Basin	
Rectangular Front	
302	Double Round Basin
352	Double Oval Basin
Radius front	
402	Double Round Basin
452	Double Oval Basin
Triple Basin	
Rectangular Front	
303	Triple Round Basin
353	Triple Oval Basin
Radius front	
403	Triple Round Basin
453	Triple Oval Basin

B Glass Color

All Vitraform glass has color at the edge. None are devoid of color.

Color Group 1	
Item	Color
C	Clear
S	Starphire
Z	Bronze
G	Grey
K	Black
Color Group 2	
P	Peach
A	Azurlite
X	Solex
Color Group 3	
T	Cobalt
B	Blue
W	White ¹

¹ For White Color specify Starphire glass with White Lamination in Color Group 1.

C Glass Finish

Item	Finish	Add
P	Polished	\$ 00
F	Frosted ¹	
	24"-36" width	\$ 160
	37"-60" width	\$ 195
	61"-84" width	\$ 245
O	White Lami ³	
	24"-36" width	\$ 160
	37"-60" width	\$ 195
	61"-84" width	\$ 245
S	Satin Etched ²	
	24"-36" width	\$ 320
	37"-60" width	\$ 390
	61"-84" width	\$ 490

¹ Frosted finish on bottom surface only.
² Satin Etched finish on top and bottom surface.
³ White Lamination is not available on Black, White or Cobalt.

D Overflow

Overflow required but NOT included. Order separately. See Overflow column at right.

Item	Price
F	Overflow

E Specify Width

Priced in 6" increments. Drawings provided by Vitraform to exact dimension required.

Single Basin by Color Group				
Item	Group 1	Group 2	Group 3	
24"	\$ 2,827	\$ 2,943	\$ 3,720	
30"	\$ 2,992	\$ 3,135	\$ 4,010	
36"	\$ 3,157	\$ 3,333	\$ 4,306	
42"	\$ 3,322	\$ 3,526	\$ 4,602	
48"	\$ 3,487	\$ 3,718	\$ 4,890	
54"	\$ 3,652	\$ 3,911	\$ 5,187	
60"	\$ 3,817	\$ 4,109	\$ 5,483	
66"	\$ 3,982	\$ 4,301	\$ 5,779	
72"	\$ 4,142	\$ 4,494	\$ 6,069	
78"	\$ 4,307	\$ 4,686	\$ 6,365	
84"	\$ 4,472	\$ 4,879	\$ 6,660	
Double Basin by Color Group				
Item	Group 1	Group 2	Group 3	
48"	\$ 4,945	\$ 5,176	\$ 6,596	
54"	\$ 5,110	\$ 5,368	\$ 6,892	
60"	\$ 5,275	\$ 5,561	\$ 7,188	
66"	\$ 5,434	\$ 5,759	\$ 7,484	
72"	\$ 5,599	\$ 5,951	\$ 7,774	
78"	\$ 5,764	\$ 6,144	\$ 8,070	
84"	\$ 5,929	\$ 6,336	\$ 8,366	
Triple Basin by Color Group				
Item	Group 1	Group 2	Group 3	
72"	\$ 7,057	\$ 7,409	\$ 9,479	
78"	\$ 7,222	\$ 7,601	\$ 9,775	
84"	\$ 7,387	\$ 7,794	\$ 10,071	



Overflow Required. Order separately.

For double and triple counters order two or three overflows.

See Metal Finish Codes below.

Item	Single Price			
Overflow	1	2	3	4
911.XX Round	\$ 210	\$ 210	\$ 215	\$ 235
916.XX Oval	\$ 210	\$ 210	\$ 215	\$ 235

Drain Optional. Order separately.

For double and triple counters order two or three drains.

See Metal Finish Codes below.

Item	Single Price			
Grid Strainer Set	1	2	3	4
810.XX w US PTrap	\$ 220	\$ 400	\$ 550	\$ 605
810.XX.S w Siphon	\$ 375	\$ 555	\$ 705	\$ 760
Pivot Drain Set				
820.XX w US PTrap	\$ 220	\$ 400	\$ 550	\$ 605
820.XX.S w Siphon	\$ 375	\$ 555	\$ 705	\$ 760
Dome Open Set				
860.XX w US PTrap	\$ 220	\$ 400	\$ 550	\$ 605
860.XX.S w Siphon	\$ 375	\$ 555	\$ 705	\$ 760
Dome Pop-up Set				
862.XX w US PTrap	\$ 220	\$ 400	\$ 550	\$ 605
862.XX.S w Siphon	\$ 375	\$ 555	\$ 705	\$ 760

Metal Finish Codes

1	2	3	4
10 Pol. Chrome	12 Pol. Nickel 20 Sat. Chrome 22 Sat. Nickel	15 ORB 16 Pol. Brass*	13 Pol. Gold* 23 Sat. Gold*

* Brass and Gold Finishes are PVD.

Order Example	A	B	C	D	E	Select an option in each column A-E including Overflow (required) and Drain (optional).	
Countersink Item No.	450	B	F	F	66"	Basin Price	\$ 6,024
Countersink Price	-	-	\$245	-	\$5,779		
	Single Oval Basin	Blue	Frosted	Overflow	Width		
Overflow Item No.	916	12	Oval Overflow / Pol. Nickel Metal Finish (12)			Overflow Price	\$ + 210
Drain Item No.	820	12	Pivot Drain / Overflow / US PTrap / Pol. Nickel Metal Finish (12)			Drain Price	\$ + 400
						Total Price	\$ 6,634
Net Crating Charges: 24-42" width: \$125, 43-60" width: \$165, 61-84" width: \$220. Up to 2 Countersinks per crate. Freight additional, request quotation.							
For Mounting Hardware see pages 30-33							

Countersink/Round or Oval Basin Without Overflow To order, select an option in each of columns A-E. Order Drain Collar and Drain separately. See Order Example at bottom.

Retail Price List

A Specify Model		B Glass Color		C Glass Finish			D Drain Collar	
Single Basin		All Vitraform glass has color at the edge. None are devoid of color.					Drain Collar is required but is NOT included. Order separately. See Drain Collar column at right.	
Item	Description	Item	Color	Item	Finish	Add	Item	
Rectangular Front		C	Clear	P	Polished	\$ 00	C	Drain Collar
300	Single Round Basin	S	Starphire	F	Frosted ¹			
350	Single Oval Basin	Z	Bronze		24"-36" width	\$ 160		
Radius front		G	Grey		37"-60" width	\$ 195		
400	Single Round Basin	K	Black		61"-84" width	\$ 245		
450	Single Oval Basin	Color Group 2		O	White Lami ³			
Double Basin		P	Peach		24"-36" width	\$ 160		
Rectangular Front		A	Azurlite		37"-60" width	\$ 195		
302	Double Round Basin	X	Solex		61"-84" width	\$ 245		
352	Double Oval Basin	Color Group 3		S	Satin Etched ²			
Radius front		T	Cobalt		24"-36" width	\$ 320		
402	Double Round Basin	B	Blue		37"-60" width	\$ 390		
452	Double Oval Basin	W	White ¹		61"-84" width	\$ 490		
Triple Basin		1 For White Color specify Starphire glass with White Lamination in Color Group 1.		1 Frosted finish on bottom surface only. 2 Satin Etched finish on top and bottom surface. 3 White Lamination is not available on Black, White or Cobalt.				
Rectangular Front								
303	Triple Round Basin							
353	Triple Oval Basin							
Radius front								
403	Triple Round Basin							
453	Triple Oval Basin							



E Specify Width			
Priced in 6" increments. Drawings provided by Vitraform to exact dimension required.			
Single Basin by Color Group			
Item	Group 1	Group 2	Group 3
24"	\$ 2,827	\$ 2,943	\$ 3,720
30"	\$ 2,992	\$ 3,135	\$ 4,010
36"	\$ 3,157	\$ 3,333	\$ 4,306
42"	\$ 3,322	\$ 3,526	\$ 4,602
48"	\$ 3,487	\$ 3,718	\$ 4,890
54"	\$ 3,652	\$ 3,911	\$ 5,187
60"	\$ 3,817	\$ 4,109	\$ 5,483
66"	\$ 3,982	\$ 4,301	\$ 5,779
72"	\$ 4,142	\$ 4,494	\$ 6,069
78"	\$ 4,307	\$ 4,686	\$ 6,365
84"	\$ 4,472	\$ 4,879	\$ 6,660
Double Basin by Color Group			
Item	Group 1	Group 2	Group 3
48"	\$ 4,945	\$ 5,176	\$ 6,596
54"	\$ 5,110	\$ 5,368	\$ 6,892
60"	\$ 5,275	\$ 5,561	\$ 7,188
66"	\$ 5,434	\$ 5,759	\$ 7,484
72"	\$ 5,599	\$ 5,951	\$ 7,774
78"	\$ 5,764	\$ 6,144	\$ 8,070
84"	\$ 5,929	\$ 6,336	\$ 8,366
Triple Basin by Color Group			
Item	Group 1	Group 2	Group 3
72"	\$ 7,057	\$ 7,409	\$ 9,479
78"	\$ 7,222	\$ 7,601	\$ 9,775
84"	\$ 7,387	\$ 7,794	\$ 10,071

Drain Collar Required. Order separately.				
For double and triple counters order two or three overflows.				
See Metal Finish Codes below.				
Item	Single Price			
Drain Collar	1	2	3	4
900.XX	\$ 42	\$ 42	\$ 45	\$ 50

Drain Optional. Order separately.					
For double and triple counters order two or three drains.					
See Metal Finish Codes below.					
Item	Single Price				
Grid Strainer Set	1	2	3	4	
811.XX	w US PTrap	\$ 220	\$ 400	\$ 550	\$ 605
811.XX.S	w Siphon	\$ 375	\$ 555	\$ 705	\$ 760
Pivot Drain Set					
821.XX	w US PTrap	\$ 220	\$ 400	\$ 550	\$ 605
821.XX.S	w Siphon	\$ 375	\$ 555	\$ 705	\$ 760
Dome Open Set					
861.XX	w US PTrap	\$ 220	\$ 400	\$ 550	\$ 605
861.XX.S	w Siphon	\$ 375	\$ 555	\$ 705	\$ 760
Dome Pop-up Set					
863.XX	w US PTrap	\$ 220	\$ 400	\$ 550	\$ 605
863.XX.S	w Siphon	\$ 375	\$ 555	\$ 705	\$ 760

Metal Finish Codes			
1	2	3	4
10 Pol. Chrome	12 Pol. Nickel 20 Sat. Chrome 22 Sat. Nickel	15 ORB 16 Pol. Brass*	13 Pol. Gold* 23 Sat. Gold*
* Brass and Gold Finishes are PVD.			

Order Example	A	B	C	D	E	Select an option in each column A-E including Drain Collar (required) and Drain (optional).	
Countersink Item No.	300	S	O	C	36"		
Countersink Price	-	-	\$160	-	\$3,157	Basin Price	\$ 3,317
	Single Round Basin	White Lami Starphire	White Lami Starphire	Drain Collar	Width		
Drain Collar Item No.	900	16	Drain Collar / PVD Pol. Brass Metal Finish (16)		Drain Collar Price	\$	+ 45
Drain Item No.	861	16S	Dome Drain Set / Siphon / PVD Pol. Brass Metal Finish (16)		Drain Price	\$	+ 705
					Total Price	\$	4,067
Net Crating Charges: 24-42" width: \$125, 43-60" width: \$165, 61-84" width: \$220. Up to 2 Countersinks per crate. Freight additional, request quotation.							
For Mounting Hardware see pages 30-33							

Countersink/Rectangular Basin With Overflow

To order, select an option in each of columns A-E. Order overflow and Drain separately. Include Item No. and Price. See Example at bottom of page.

Retail Price List

A Specify Model		B Glass Color		C Glass Finish			D Overflow		E Specify Width				
Single Basin		Color Group 1					Overflow required but NOT included. Order separately. See Overflow column at right.		Priced in 6" increments. Drawings provided by Vitraform to exact dimension required.				
Item	Description	Item	Color	Item	Finish	Add	Item		Item	Group 1	Group 2	Group 3	
370	Single Rect. Basin	C	Clear	P	Polished	\$ 00	F	Overflow	30"	\$ 2,992	\$ 3,135	\$ 4,010	
Double Basin		Color Group 2							Single Basin by Color Group				
372	Double Rect. Basin	S	Starphire	F	Frosted ¹				36"	\$ 3,157	\$ 3,333	\$ 4,306	
		Z	Bronze		30"-36" width	\$ 160			42"	\$ 3,322	\$ 3,526	\$ 4,602	
		G	Grey		37"-60" width	\$ 195			48"	\$ 3,487	\$ 3,718	\$ 4,890	
		K	Black		61"-84" width	\$ 245			54"	\$ 3,652	\$ 3,911	\$ 5,187	
		Color Group 3		O	White Lami ³				60"	\$ 3,817	\$ 4,109	\$ 5,483	
		P	Peach		30"-36" width	\$ 160			66"	\$ 3,982	\$ 4,301	\$ 5,779	
		A	Azurlite		37"-60" width	\$ 195			72"	\$ 4,142	\$ 4,494	\$ 6,069	
		X	Solex		61"-84" width	\$ 245			78"	\$ 4,307	\$ 4,686	\$ 6,365	
		T	Cobalt	S	Satin Etched ²				84"	\$ 4,472	\$ 4,879	\$ 6,660	
		B	Blue		30"-36" width	\$ 320			Double Basin by Color Group				
		W	White ¹		37"-60" width	\$ 390			Item	Group 1	Group 2	Group 3	
		1 For White Color specify Starphire glass with White Lamination in Color Group 1.			61"-84" width	\$ 490			60"	\$ 5,275	\$ 5,561	\$ 7,188	
				M	Mirror ³				66"	\$ 5,434	\$ 5,759	\$ 7,484	
					30"-36" width	\$ 600			72"	\$ 5,599	\$ 5,951	\$ 7,774	
					37"-60" width	\$ 900			78"	\$ 5,764	\$ 6,144	\$ 8,070	
					61"-84" width	\$ 1260			84"	\$ 5,929	\$ 6,336	\$ 8,366	
				1 Frosted finish on bottom surface only.									
				2 Satin Etched finish on top and bottom surface.									
				3 Mirror or White Lami is not available on Black, White or Cobalt.									

Overflow Required. Order separately.

For double counters order two overflows.

See Metal Finish Codes below.

Item	Single Price			
Overflow	1	2	3	4
918.XX Rectangular	\$ 210	\$ 210	\$ 215	\$ 235

Drain Optional. Order separately.

For double counters order two drains.

See Metal Finish Codes below.

Item	Single Price			
Grid Strainer Set	1	2	3	4
810.XX w US PTrap	\$ 220	\$ 400	\$ 550	\$ 605
810.XX.S w Siphon	\$ 375	\$ 555	\$ 705	\$ 760
Pivot Drain Set				
820.XX w US PTrap	\$ 220	\$ 400	\$ 550	\$ 605
820.XX.S w Siphon	\$ 375	\$ 555	\$ 705	\$ 760
Dome Open Set				
860.XX w US PTrap	\$ 220	\$ 400	\$ 550	\$ 605
860.XX.S w Siphon	\$ 375	\$ 555	\$ 705	\$ 760
Dome Pop-up Set				
862.XX w US PTrap	\$ 220	\$ 400	\$ 550	\$ 605
862.XX.S w Siphon	\$ 375	\$ 555	\$ 705	\$ 760

Metal Finish Codes

1	2	3	4
10 Pol. Chrome	12 Pol. Nickel 20 Sat. Chrome 22 Sat. Nickel	15 ORB 16 Pol. Brass*	13 Pol. Gold* 23 Sat. Gold*

* Brass and Gold Finishes are PVD.

Order Example	A	B	C	D	E	Select an option in each column A-E including Overflow (required) and Drain (optional).	
Countersink Item No.	370	P	F	F	72"	Basin Price	\$ 4,739
Countersink Price	-	-	\$ 245	-	\$ 4,494		
	Single Rect. Basin	Peach	Frosted	Overflow	Width		
Overflow Item No.	918	10	Rectangular Overflow / Pol. Chrome Metal Finish (10)			Overflow Price	\$ + 210
Drain Item No.	820	10	Pivot Drain / Overflow / US PTrap / Pol. Chrome Metal Finish (10)			Drain Price	\$ + 220
					Total Price	\$ 5,169	
Net Crating Charges: 30-42" width: \$125, 43-60" width: \$165, 61-84" width: \$220. Up to 2 Countersinks per crate. Freight additional, request quotation.							
For Mounting Hardware see pages 30-33							



Countersink/Rectangular Basin Without Overflow

To order, select an option in each of columns A-E. Order Drain Collar and Drain separately. See Example at bottom of page.

Retail Price List

A Specify Model

Single Basin	
Item	Description
370	Single Rect. Basin
Double Basin	
372	Double Rect. Basin

B Glass Color

All Vitraform glass has color at the edge. None are devoid of color.

Color Group 1	
Item	Color
C	Clear
S	Starphire
Z	Bronze
G	Grey
K	Black
Color Group 2	
P	Peach
A	Azurlite
X	Solex
Color Group 3	
T	Cobalt
B	Blue
W	White ¹

¹ For White Color specify Starphire glass with White Lamination in Color Group 1.

C Glass Finish

Item	Finish	Add
P	Polished	\$ 00
F	Frosted ¹	
	30"-36" width	\$ 160
	37"-60" width	\$ 195
	61"-84" width	\$ 245
O	White Lami ³	
	30"-36" width	\$ 160
	37"-60" width	\$ 195
	61"-84" width	\$ 245
S	Satin Etched ²	
	30"-36" width	\$ 320
	37"-60" width	\$ 390
	61"-84" width	\$ 490
M	Mirror ³	
	30"-36" width	\$ 600
	37"-60" width	\$ 900
	61"-84" width	\$ 1260

¹ Frosted finish on bottom surface only.
² Satin Etched finish on top and bottom surface.
³ Mirror or White Lami is not available on Black, White or Cobalt.

D Drain Collar

Drain Collar is required but is NOT included. Order separately. See Drain Collar column at right.

Item	Description
C	Drain Collar

E Specify Width

Priced in 6" increments. Drawings provided by Vitraform to exact dimension required.

Single Basin by Color Group			
Item	Group 1	Group 2	Group 3
30"	\$ 2,992	\$ 3,135	\$ 4,010
36"	\$ 3,157	\$ 3,333	\$ 4,306
42"	\$ 3,322	\$ 3,526	\$ 4,602
48"	\$ 3,487	\$ 3,718	\$ 4,890
54"	\$ 3,652	\$ 3,911	\$ 5,187
60"	\$ 3,817	\$ 4,109	\$ 5,483
66"	\$ 3,982	\$ 4,301	\$ 5,779
72"	\$ 4,142	\$ 4,494	\$ 6,069
78"	\$ 4,307	\$ 4,686	\$ 6,365
84"	\$ 4,472	\$ 4,879	\$ 6,660
Double Basin by Color Group			
Item	Group 1	Group 2	Group 3
60"	\$ 5,275	\$ 5,561	\$ 7,188
66"	\$ 5,434	\$ 5,759	\$ 7,484
72"	\$ 5,599	\$ 5,951	\$ 7,774
78"	\$ 5,764	\$ 6,144	\$ 8,070
84"	\$ 5,929	\$ 6,336	\$ 8,366

Drain Collar Required. Order separately.

For double counters order two overflows.

See Metal Finish Codes below.

Item	Single Price			
Drain Collar	1	2	3	4
900.XX	\$ 42	\$ 42	\$ 45	\$ 50

Drain Optional. Order separately.

For double counters order two drains.

See Metal Finish Codes below.

Item	Single Price			
Grid Strainer Set	1	2	3	4
811.XX w US PTrap	\$ 220	\$ 400	\$ 550	\$ 605
811.XX.S w Siphon	\$ 375	\$ 555	\$ 705	\$ 760
Pivot Drain Set				
821.XX w US PTrap	\$ 220	\$ 400	\$ 550	\$ 605
821.XX.S w Siphon	\$ 375	\$ 555	\$ 705	\$ 760
Dome Open Set				
861.XX w US PTrap	\$ 220	\$ 400	\$ 550	\$ 605
861.XX.S w Siphon	\$ 375	\$ 555	\$ 705	\$ 760
Dome Pop-up Set				
863.XX w US PTrap	\$ 220	\$ 400	\$ 550	\$ 605
863.XX.S w Siphon	\$ 375	\$ 555	\$ 705	\$ 760

Metal Finish Codes

1	2	3	4
10 Pol. Chrome	12 Pol. Nickel 20 Sat. Chrome 22 Sat. Nickel	15 ORB 16 Pol. Brass*	13 Pol. Gold* 23 Sat. Gold*

* Brass and Gold Finishes are PVD.

Order Example	A	B	C	D	E	Select an option in each column A-E including Drain Collar (required) and Drain (optional).	
Countersink Item No.	370	C	P	C	42"	Basin Price	\$ 3,322
Countersink Price	-	-	\$ 00	-	\$3,322		
Single Rect. Basin		Polished	Width				
Clear		Drain Collar					
Drain Collar Item No.	900	12	Drain Collar / Pol. Nickel Metal Finish (12)		Drain Collar Price	\$ + 42	
Drain Item No.	861	12S	Dome Drain Set / Siphon / Pol. Nickel Metal Finish (12)		Drain Price	\$ + 555	
					Total Price	\$ 3,919	
Net Crating Charges: 30-42" width: \$125, 43-60" width: \$165, 61-84" width: \$220.							
Up to 2 Countersinks per crate. Freight additional, request quotation.							
For Mounting Hardware see pages 30-33							



Countertop To order, select an option in each of columns A through E. Include Item No. and Price. See Example at bottom of page.

Retail Price List

A Specify Model		B Glass Color		C Glass Finish			D Basin Hole(s)		E Specify Width				
		All Vitraform glass has color at the edge. None are devoid of color.					Included in Counter Price. For holes to accommodate customer's own sink please request price and drawing.		Priced in 6" increments. Drawings provided by Vitraform to exact dimension required.				
With 1 Hole for Single Basin		Color Group 1							Single Basin by Color Group				
Item	Description	Item	Color	Item	Finish	Add	Item		Group 1	Group 2	Group 3		
Rectangular Front		C	Clear	P	Polished	\$ 00	N		\$ 1,153	\$ 1,300	\$ 1,741		
500	Single Round Basin	S	Starphire	F	Frosted ¹			18"	\$ 1,342	\$ 1,458	\$ 1,976		
550	Single Oval Basin	Z	Bronze		18"-36" width	\$ 160		24"	\$ 1,507	\$ 1,650	\$ 2,272		
Radius front		G	Grey		37"-60" width	\$ 195		30"	\$ 1,667	\$ 1,843	\$ 2,561		
600	Single Round Basin	K	Black		61"-84" width	\$ 245		36"	\$ 1,832	\$ 2,035	\$ 2,857		
650	Single Oval Basin			O	White Lami ³			42"	\$ 1,997	\$ 2,228	\$ 3,153		
		Color Group 2			18"-36" width	\$ 160		48"	\$ 1,997	\$ 2,228	\$ 3,153		
With 2 Holes for Double Basin		P	Peach		37"-60" width	\$ 195		54"	\$ 2,162	\$ 2,426	\$ 3,450		
Rectangular Front		A	Azurlite	S	Satin Etched ²			60"	\$ 2,327	\$ 2,618	\$ 3,740		
502	Double Round Basin	X	Solex		18"-36" width	\$ 320		66"	\$ 2,492	\$ 2,811	\$ 4,035		
552	Double Oval Basin				37"-60" width	\$ 390		72"	\$ 2,657	\$ 3,003	\$ 4,331		
Radius front		Color Group 3			61"-84" width	\$ 245		78"	\$ 2,822	\$ 3,196	\$ 4,627		
602	Double Round Basin	T	Cobalt	M	Mirror ³			84"	\$ 2,984	\$ 3,394	\$ 4,923		
652	Double Oval Basin	B	Blue		18"-36" width	\$ 480		Double Basin by Color Group					
		W	White ¹		37"-60" width	\$ 580		Item	Group 1	Group 2	Group 3		
With 3 Holes for Triple Basin		L	Cristal ²		61"-84" width	\$ 725		48"	\$ 2,332	\$ 2,563	\$ 3,540		
Rectangular Front		Q	Cristal Antiq ²						54"	\$ 2,492	\$ 2,756	\$ 3,835	
503	Triple Round Basin	1 For White Color specify Starphire glass with White Lamination.			1 Frosted finish on bottom surface only.				60"	\$ 2,657	\$ 2,948	\$ 4,131	
553	Triple Oval Basin	2 For Cristal and Cristal Antiq contact factory for availability based on size.			2 Satin Etched finish on top and bottom surface.				66"	\$ 2,822	\$ 3,141	\$ 4,427	
Radius front					3 Mirror or White Lami is not available on Black, White or Cobalt.				72"	\$ 2,987	\$ 3,339	\$ 4,718	
603	Triple Round Basin								78"	\$ 3,152	\$ 3,531	\$ 5,014	
653	Triple Oval Basin								84"	\$ 3,317	\$ 3,724	\$ 5,310	

Order Example	A	B	C	D	E	To order, select an option in each of columns A through E, and add Crating Charges.	
Countertop Item No.	600	Z	M	N	60"	Price	\$ 2,907
Countertop Price	-	-	\$580	-	\$2,327		
	Single Round Basin	Mirror Finish	Width				
	Bronze	No Overflow					
Net Crating Charges: 18-42" width: \$125, 43-60" width: \$165, 61-84" width: \$220.							
Up to 2 Countertops per crate. Freight additional, request quotation.							
For Mounting Hardware see pages 30-33							



Wood Vanities

Retail Price List

A Specify Model

The Oval Vanity for Countersink may be used with a Vitraform Countersink or Rimless under mount basin with stone or glass CounterTop. Custom finish by quotation.

Oval Vanity for Countersink (34" height)		
Item	Description	Price
VF1AN	Anigre Veneer	\$ 4,755
VF1EB	Ebony Veneer	\$ 4,755
VF1SA	Sapele Veneer	\$ 4,755
VF1SY	Sycamore Veneer	\$ 4,950
VF1TK	Teak Veneer	\$ 4,755
VF1WA	Walnut Veneer	\$ 4,755
VF1WE	Wenge Veneer	\$ 4,755
VF1ZE	Zebra Veneer	\$ 4,755



Coordinating products for this item:

1. Countersinks see pg 11-12
 2. Countertops see pg 15
 3. Rimless Under Mounts see pg 7-10
 4. Support Legs Item No. 780, 790 & 791 see pg 30
 5. Cabinet Pulls Item VCP see pg 30
 6. Drains see pg 28
- Customer's own basin, counter and hardware may also be used.

The Oval Vanity for Freestanding Basin may be used with a Vitraform Freestanding basin and glass CounterTop. Custom finish by quotation.

Oval Vanity for Freestanding Basin (30" height)		
Item	Description	Price
VF2AN	Anigre Veneer	\$ 4,755
VF2EB	Ebony Veneer	\$ 4,755
VF2SA	Sapele Veneer	\$ 4,755
VF2SY	Sycamore Veneer	\$ 4,950
VF2TK	Teak Veneer	\$ 4,755
VF2WA	Walnut Veneer	\$ 4,755
VF2WE	Wenge Veneer	\$ 4,755
VF2ZE	Zebra Veneer	\$ 4,755



Coordinating products for this item:

1. Freestanding Basins see pg 5-6
 2. Countertops see pg 15
 3. Support Legs Item No. 780, 790 & 791 see pg 30
 4. Cabinet Pulls Item VCP see pg 30
 5. Drains see pg 28
- Customer's own basin, counter and hardware may also be used.

The "T" Vanity is designed for wall hung installation. Custom Finish by quotation.

"T" Vanity (Available in Standard 36" or 25" widths)		
Item	Description	Price
VF3AN	Anigre Veneer	\$ 2,820
VF3EB	Ebony Veneer	\$ 2,820
VF3SA	Sapele Veneer	\$ 2,820
VF3SY	Sycamore Veneer	\$ 3,015
VF3TK	Teak Veneer	\$ 2,820
VF3WA	Walnut Veneer	\$ 2,820
VF3WE	Wenge Veneer	\$ 2,820
VF3ZE	Zebra Veneer	\$ 2,820



Coordinating products for this item:

1. Freestanding Basins see pg 5-6
 2. Drains see pg 28
- Customer's own basin, counter and hardware may also be used.

The G. N. Vanity may be installed with or without legs to the floor. Provide adequate support for wall mounted cabinet without legs. Custom Finish by quotation.

G.N. Vanity (36" width)		
Item	Description	Price
VF4AN	Anigre Veneer	\$ 2,475
VF4EB	Ebony Veneer	\$ 2,475
VF4SA	Sapele Veneer	\$ 2,475
VF4SY	Sycamore Veneer	\$ 2,675
VF4TK	Teak Veneer	\$ 2,475
VF4WA	Walnut Veneer	\$ 2,475
VF4WE	Wenge Veneer	\$ 2,475
VF4ZE	Zebra Veneer	\$ 2,475



Coordinating products for this item:

1. Countersinks see pg 11-12
 2. Countertops see pg 15
 3. Freestanding Basins see pg 5-6
 4. Support Legs: Item No. 780, 790 & 791 see pg 30
 5. Cabinet Pulls: Item VCP see pg 30
 6. Drains see pg 28
- Customer's own basin, counter and hardware may also be used. Custom sizes and optional drawers by quotation.

Vanity Order Example		A	
Vanity Item No.	VF2SY		
Vanity Price	\$ 4,950	Total Price	\$ 4,950
Oval Vanity for Freestanding Basin with Sycamore Veneer			
Net Crating Charges: \$165 per Vanity. Freight additional, request quotation.			

Wall Mirrors To order, select an option in each of columns A through E. Include Item No. and Price. See Example at bottom of page.

Retail Price List

A Select Wall Mirror

Prices are the same for all Vitraform glass colors.

Mirror Style		
Item	Description	Price
M100	Round Wall Mirror	\$ 850
M150	Oval Wall Mirror	\$ 850
M175	Square Wall Mirror	\$ 1,000
M175	Rectangular Wall Mirror	\$ 1,200

Mirror includes mounting hardware.
Engraving on Mirrors by quotation.

B Glass Color

All Vitraform glass has color at the edge. None are devoid of color.

Glass Colors	
Item	Color
C	Clear
S	Starphire
Z	Bronze
G	Grey
K	Black
P	Peach
A	Azurlite
X	Solex
T	Cobalt
B	Blue
W	White





C Glass Finish

Item	Finish	Add
P	Polished	\$ 00
F	Frosted ¹	\$ 160
O	Translucent White ³	\$ 110
S	Satin Etched ²	\$ 110
M	Mirror Finish ³	\$ 480

¹ Frosted finish on back surface only.
² Satin etched on front and back surface.
³ Mirror finish or Translucent White finish is not available on Black or White or Cobalt glass.

D Mirror Size

Custom sizes available by quotation.

Item	Description	Size	Shape
24	Round	24" Dia.	
2228	Oval ¹	22w" x 28h"	
2424	Square	24" x 24"	
3624	Rectangular ¹	36w" x 24h"	

¹ Please specify orientation of mirror for Rectangle and Oval shapes.

E Metal Finish

Item	Description	Add
10	Pol. Chrome	\$ 00
12	Pol. Nickel	\$ 00
20	Sat. Chrome	\$ 00
22	Sat. Nickel	\$ 00
15	ORB	\$ 55
16	PVD Pol. Brass	\$ 55
13	PVD Pol. Gold	\$ 85
23	PVD Sat. Gold	\$ 85

Mirror Order	A	B	C	D	E	To order, select an option in each of columns A through E and Crating Charges.
Item No.	M175	Z	M	2424	10	
Price	\$ 1,000	-	\$ 110	-	\$ 00	Mirror Price \$ 1,110
	Rectangular Wall Mirror	Mirror Finish	Polished Chrome Hardw. Metal Finish			
	Bronze Glass	Rect Dimension				

Crating \$110.00 Shipped via Truck Line only.
Request Quote for freight charges.



Arabesque and Battuto Pedestal To order, select an option in each of columns A and B. Include Item No. and Price. See Example at bottom of page.

Retail Price List

A Select Pedestal Item

Prices are for complete Pedestal*

Black glass with Arabesque Engraving

Item	Description	Price
726KP36	Black Polished glass	\$ 16,625
M100KP22.XX.36	Matching Engraved Mirror	\$ 2,855

Variation for Battuto Engraving

Item	Description	Price
726LP30	Cristal Polished glass	\$ 18,275
M100LP22.XX.30	Matching Engraved Mirror	\$ 2,505

* Includes Sink, Countertop, Pedestal Base, Drain Set and Surface Clips.

Dome drain and Euro Siphon included as standard. Contact factory to substitute a US P-trap or any other Vitraform drain with the Pedestal.

Arabesque and Battuto bases are mouth blown and will exhibit variations due to process.

Matching engraved mirrors as shown. Provide metal finish for clips where XX is shown. Request quote for additional sizes or variations. See Mirror page for other sizes and variations.

B Metal Finish

Metal Finish upcharge for Pedestal

Item	Description	Add
10	Pol. Chrome	\$ 00
12	Pol. Nickel	\$ 180
20	Sat. Chrome	\$ 180
22	Sat. Nickel	\$ 180
15	ORB	\$ 500
16	PVD Pol. Brass	\$ 500
13	PVD Pol. Gold	\$ 665
23	PVD Sat. Gold	\$ 665

Metal Finish upcharge for Mirror

Item	Description	Add
10	Pol. Chrome	\$ 00
12	Pol. Nickel	\$ 00
20	Sat. Chrome	\$ 00
22	Sat. Nickel	\$ 00
15	ORB	\$ 55
16	PVD Pol. Brass	\$ 55
13	PVD Pol. Gold	\$ 85
23	PVD Sat. Gold	\$ 85



Arabesque shown with matching Engraved Mirror

Order Example	A	B	To order, select an option in each of columns A and B and add Crating Charge.	
Pedestal Item No.	726LP30	22		
Pedestal Price	\$ 18,275	\$ 180	Total Price	\$ 18,455
Battuto Pedestal Cristal Polished Glass				
Sat. Nickel Hardware				
Net Crating Charges per pedestal \$165. Freight additional, request quotation.				

Cono Pedestal To order, select an option in each of columns A and B. Include Item No. and Price. See Example at bottom of page.

Retail Price List

A Select Pedestal Item

Prices are for complete Pedestal*

Standard Cristal glass

Item	Description	Price
724LP	Cristal Polished glass	\$ 10,780

Standard solid color glass

Item	Description	Price
724WP	White Polished glass	\$ 12,430
724KP	Black Polished glass	\$ 11,610
724TP	Cobalt Polished glass	\$ 12,430

Standard threaded color glass

Item	Description	Price
724PP	Peach Polished, Threaded glass	\$ 13,570
724AP	Azurlite Polished, Threaded glass	\$ 13,570
724XP	Solex Polished, Threaded glass	\$ 13,570
724ZP	Bronze Polished, Threaded glass	\$ 13,265

* Includes Sink, Countertop, Pedestal Base, Drain Set and Surface Clips.
 Dome drain and Euro Siphon included as standard. Contact factory to substitute a US P-trap or any other Vitraform drain with the Pedestal.
 Prices as shown in photos for each color. Variations in color for basin or counter by quotation.
 Cono bases are mouth blown and will exhibit variations due to process.

B Metal Finish

Item	Description	Add
10	Pol. Chrome	\$ 00
12	Pol. Nickel	\$ 180
20	Sat. Chrome	\$ 180
22	Sat. Nickel	\$ 180
15	ORB	\$ 500
16	PVD Pol. Brass	\$ 500
13	PVD Pol. Gold	\$ 665
23	PVD Sat. Gold	\$ 665

Order Example	A	B	To order, select an option in each of columns A and B and add Crating Charge.	
Pedestal Item No.	724ZP	10	Total Price	\$ 13,265
Pedestal Price	\$ 13,265	\$ 00		
Bronze Polished Threaded Glass Pol. Chrome Hardware				
Net Crating Charges per pedestal \$165. Freight additional, request quotation.				



Coppa Pedestal To order, select an option in each of columns A and B. Include Item No. and Price. See Example at bottom of page.

Retail Price List

A Select Pedestal Item

Prices are for complete Pedestal*

Standard Cristal glass

Item	Description	Price
722LP	Cristal Polished glass	\$ 10,780

Standard solid color glass

Item	Description	Price
722WP	White Polished glass	\$ 12,430
722KP	Black Polished glass	\$ 11,610
722TP	Cobalt Polished glass	\$ 12,430

Standard threaded color glass

Item	Description	Price
722PP	Peach Polished, Threaded glass	\$ 13,570
722AP	Azurlite Polished, Threaded glass	\$ 13,570
722XP	Solex Polished, Threaded glass	\$ 13,570
722ZP	Bronze Polished, Threaded glass	\$ 13,265

* Includes Sink, Countertop, Pedestal Base, Drain Set and Surface Clips.
 Dome drain and Euro Siphon included as standard. Contact factory to substitute a US P-trap or any other Vitraform drain with the Pedestal.
 Prices as shown in photos for each color. Variations in color for basin or counter by quotation.
 Coppa bases are mouth blown and will exhibit variations due to process.

B Metal Finish

Item	Description	Add
10	Pol. Chrome	\$ 00
12	Pol. Nickel	\$ 180
20	Sat. Chrome	\$ 180
22	Sat. Nickel	\$ 180
15	ORB	\$ 500
16	PVD Pol. Brass	\$ 500
13	PVD Pol. Gold	\$ 665
23	PVD Sat. Gold	\$ 665

Order Example	A	B	To order, select an option in each of columns A and B and add Crating Charge.	
Pedestal Item No.	722WP	16		
Pedestal Price	\$ 12,430	\$ 500	Total Price	\$ 12,930
White Polished Glass PVD Pol. BrassHardware				
Net Crating Charges per pedestal \$165. Freight additional, request quotation.				



Cubetto Pedestal To order, select an option in each of columns A and B. Include Item No. and Price. See Example at bottom of page.

Retail Price List

A Select Pedestal Item		
Prices are for complete Pedestal*		
Standard Cristal glass		
Item	Description	Price
725LP	Cristal Polished glass	\$ 10,580
Standard solid color glass		
Item	Description	Price
725WP	White Polished glass	\$ 12,230
725KP	Black Polished glass	\$ 11,760
725TP	Cobalt Polished glass	\$ 12,230
* Includes Sink, Countertop, Pedestal Base, Drain Set and Surface Clips. Dome drain and Euro Siphon included as standard. Contact factory to substitute a US P-trap or any other Vitraform drain with the Pedestal. Prices as shown in photos for each color. Variations in color for basin or counter by quotation. Cubetto bases are mouth blown and will exhibit variations due to process.		

B Metal Finish		
Item	Description	Add
10	Pol. Chrome	\$ 00
12	Pol. Nickel	\$ 180
20	Sat. Chrome	\$ 180
22	Sat. Nickel	\$ 180
15	ORB	\$ 500
16	PVD Pol. Brass	\$ 500
13	PVD Pol. Gold	\$ 665
23	PVD Sat. Gold	\$ 665

Order Example	A	B	To order, select an option in each of columns A and B and add Crating Charge.	
Pedestal Item No.	725KP	13		
Pedestal Price	\$ 11,760	\$ 665	Total Price	\$ 12,425
	Black Polished Glass	Pol. Gold Hardware		
Net Crating Charges per pedestal \$165. Freight additional, request quotation.				



Glass Rod Pedestal To order, select an option in each of columns A and B. Include Item No. and Price. See Example at bottom of page.

Retail Price List

A Select Pedestal Item

Prices are for complete Pedestal*

Standard Cristal glass

Item	Description	Price
721LP	Cristal Polished glass	\$ 6,015

* Includes Sink, 18" Countertop, 18" Towel Bar, Pedestal Base, Drain Set and Surface Clips.

Dome drain and Euro Siphon included as standard. Contact factory to substitute a US P-trap or any other Vitraform drain with the Pedestal.

Price for all Cristal components. Variations of basin and Countertop color by quotation.

Variations of Countertop and Towel Bar size by quotation.

Available without Towel Bar by quotation.

B Metal Finish

Item	Description	Add
10	Pol. Chrome	\$ 00
12	Pol. Nickel	\$ 180
20	Sat. Chrome	\$ 180
22	Sat. Nickel	\$ 180
15	ORB	\$ 720
16	PVD Pol. Brass	\$ 720
13	PVD Pol. Gold	\$ 999
23	PVD Sat. Gold	\$ 999

Order Example	A	B	To order, select an option in each of columns A and B and add Crating Charge.	
Pedestal Item No.	721LP	10	Total Price	\$ 6,015
Pedestal Price	\$ 6,015	\$ 00		
Cristal Polished Glass Pol. Chrome Hardware				
Net Crating Charges per pedestal \$165. Freight additional, request quotation.				



Pullman Pedestal With Overflow To order, select an option in each of columns A through E. Include Item No. and Price. See Example at bottom of page.

Retail Price List

A Select Pedestal Item			B Glass Color		C Glass Finish			D Overflow		E Metal Finish		
Prices are for complete Pedestal *			All Vitraform glass has color at the edge. None are devoid of color.					Overflow included.				
Color Group 1 Pricing			Color Group 1									
Item	Round	Price	Item	Color	Item	Finish	Add	Item		Item	Description	Add
723	Pullman Pedestal	\$ 3,333	C	Clear	P	Polished ⁴	\$ 00	F	Overflow	10	Pol. Chrome	\$ 00
			S	Starphire	O	White Lami ³	\$ 00			12	Pol. Nickel	\$ 180
			Z	Bronze	S	Satin Etched ²	\$ 440			20	Sat. Chrome	\$ 180
			G	Grey	M	Mirror ³	\$ 950			22	Sat. Nickel	\$ 180
			K	Black	² Satin Etched finish on inside and outside surface of glass components. ³ Mirror or White Lamination is not available on Black or Cobalt. ⁴ Polished finish on glass colors other than Black or Cobalt is not recommended. Assembly by experienced glass installer using optically clear adhesive is necessary.					15	ORB	\$ 545
Color Group 2 Pricing			Color Group 2									
Item	Round	Price	Item	Color								
723	Pullman Pedestal	\$ 3,780	P	Peach								
			A	Azurlite								
			X	Solex								
Color Group 3 Pricing			Color Group 3									
Item	Round	Price	Item	Color								
723	Pullman Pedestal	\$ 4,230	T	Cobalt								
			B	Blue								
			W	White ¹								
* Includes Glass Panels, Sink, Drain Set, Overflow and Base Ring. Dome Pop-up drain and Euro Siphon included as standard. Contact factory to substitute a US P-trap or any other Vitraform drain with the Pedestal.			¹ For White Color specify Starphire glass with White Lamination in Color Group 1.									



Order Example	A	B	C	D	E	To order, select an option in each of columns A through E and add Crating Charges.
Pedestal Item No.	723	P	S	F	22	
Pedestal Price	\$ 3,780	-	\$ 440	-	\$ 180	Total Price \$ 4,400
	Pullman Pedestal	Peach Glass	Satin Etched	Overflow	Sat. Nickel Metal Finish	
Net Crating Charges per pedestal \$165. Freight additional, request quotation.						

Pullman Pedestal Without Overflow To order, select an option in each of columns A through E. Include Item No. and Price. See Example at bottom of page.

Retail Price List

A Select Pedestal Item			B Glass Color		C Glass Finish			D Drain Collar		E Metal Finish		
Prices are for complete Pedestal *			All Vitraform glass has color at the edge. None are devoid of color.					Drain Collar Included				
Color Group 1 Pricing			Color Group 1									
Item	Round	Price	Item	Color	Item	Finish	Add	Item		Item	Description	Add
723	Pullman Pedestal	\$ 3,170	C	Clear	P	Polished ⁴	\$ 00	C	Drain Collar	10	Pol. Chrome	\$ 00
			S	Starphire	O	White Lami ³	\$ 00			12	Pol. Nickel	\$ 180
			Z	Bronze	S	Satin Etched ²	\$ 440			20	Sat. Chrome	\$ 180
			G	Grey	M	Mirror ³	\$ 950			22	Sat. Nickel	\$ 180
			K	Black	² Satin Etched finish on inside and outside surface of glass components. ³ Mirror or White Lamination is not available on Black or Cobalt. ⁴ Polished finish on glass colors other than Black or Cobalt is not recommended. Assembly by experienced glass installer using optically clear adhesive is necessary.					15	ORB	\$ 540
										16	PVD Pol. Brass	\$ 540
Color Group 2 Pricing			Color Group 2									
Item	Round	Price	Item	Color								
723	Pullman Pedestal	\$ 3,615	P	Peach								
			A	Azurlite								
			X	Solex								
Color Group 3 Pricing			Color Group 3									
Item	Round	Price	Item	Color								
723	Pullman Pedestal	\$ 4,065	T	Cobalt								
			B	Blue								
			W	White ¹								
* Includes Glass Panels, Sink, Drain Set, Drain Collar and Base Ring. Dome drain and Euro Siphon included as standard. Contact factory to substitute a US P-trap or any other Vitraform drain with the Pedestal.			¹ For White Color specify Starphire glass with White Lamination in Color Group 1.									



Order Example	A	B	C	D	E	To order, select an option in each of columns A through E and add Crating Charges.	
Pedestal Item No.	723	S	O	C	10	Pedestal Price	\$ 3,170
		-	\$ 00	-	\$ 00	Total Price	\$ 3,170
	Pullman Pedestal	White Lami	Pol. Chrome Metal Finish				
	Starphire Glass	Drain Collar					
Net Crating Charges per pedestal \$165. Freight additional, request quotation.							

Console With Overflow

To order, select an option in each of columns A through F. Include Item No. and Price. See Example at bottom of page.

Retail Price List

A Specify Model	
Prices are for complete Console *	
Single Basin	
Item	Description
Rectangular Front	
330	Single Round Basin
380	Single Oval Basin
Radius front	
430	Single Round Basin
480	Single Oval Basin
Double Basin	
Rectangular Front	
332	Double Round Basin
382	Double Oval Basin
Radius front	
432	Double Round Basin
482	Double Oval Basin
* Includes CounterSink, Drain Set, Shelf, Mounting Clips, Console Legs, Towel Bar and Overflow. Dome Pop-up drain and Euro Siphon included as standard. Contact factory to substitute a US P-trap or any other Vitraform drain with the Console.	

B Glass Color	
All Vitraform glass has color at the edge. None are devoid of color.	
Color Group 1	
Item	Color
C	Clear
S	Starphire
Z	Bronze
G	Grey
K	Black
Color Group 2	
P	Peach
A	Azurlite
X	Solex
Color Group 3	
T	Cobalt
B	Blue
W	White ¹
1 For White Color specify Starphire glass with White Lamination in Color Group 1.	

C Glass Finish		
Item	Finish	Add
P	Polished	\$ 00
F	Frosted ¹	
	20"-36" width	\$ 320
	37"-60" width	\$ 385
O	White Lami ³	
	20"-36" width	\$ 320
	37"-60" width	\$ 385
S	Satin Etched ²	
	20"-36" width	\$ 640
	37"-60" width	\$ 770
1 Frosted finish is on bottom surfaces of glass components only.		
2 Satin Etched finish on top and bottom surfaces of glass components.		
3 White Lamination is not available on Black, White or Cobalt.		

D Overflow	
Overflow included.	
Item	Overflow
F	Overflow

E Specify Width				
Single Basin Pricing				
Item	Group 1	Group 2	Group 3	
24"	\$ 6,661	\$ 6,892	\$ 7,359	
30"	\$ 6,991	\$ 7,277	\$ 7,860	
36"	\$ 7,315	\$ 7,667	\$ 8,360	
42"	\$ 7,645	\$ 8,052	\$ 8,866	
48"	\$ 7,975	\$ 8,437	\$ 9,367	
54"	\$ 8,305	\$ 8,828	\$ 9,873	
60"	\$ 8,635	\$ 9,218	\$ 10,373	
Double Basin Pricing				
Item	Group 1	Group 2	Group 3	
48"	\$ 10,104	\$ 10,566	\$ 11,490	
54"	\$ 10,428	\$ 10,951	\$ 11,996	
60"	\$ 10,758	\$ 11,336	\$ 12,502	

F Select Metal Finish			
		Single	Double
Item	Description	Add	Add
10	Pol. Chrome	\$ 00	\$ 00
12	Pol. Nickel	\$ 180	\$ 365
20	Sat. Chrome	\$ 180	\$ 365
22	Sat. Nickel	\$ 180	\$ 365
15	ORB	\$ 490	\$ 825
16	PVD Pol. Brass	\$ 490	\$ 825
13	PVD Pol. Gold	\$ 850	\$ 1255
23	PVD Sat. Gold	\$ 850	\$ 1255



Order Example	A	B	C	D	E	F	To order, select an option in each of columns A through F and add Crating Charges.	
Console Item No.	380	X	P	F	54"	22		
Console Price	-	-	\$ 00	-	\$ 8,828	\$ 180	Total Price	\$ 9,008

Single Oval Basin	Polished Finish	Width of Counter
Solex Glass	Overflow	Sat. Nickel Metal Finish
Net Crating Charges: 24-42" width: \$125, 43-60" width: \$165. Freight additional, request quotation.		

Console Without Overflow To order, select an option in each of columns A through F. Include Item No. and Price. See Example at bottom of page.

Retail Price List

A Specify Model	
Prices are for complete Console *	
Single Basin	
Item	Description
Rectangular Front	
330	Single Round Basin
380	Single Oval Basin
Radius front	
430	Single Round Basin
480	Single Oval Basin
Double Basin	
Rectangular Front	
332	Double Round Basin
382	Double Oval Basin
Radius front	
432	Double Round Basin
482	Double Oval Basin
* Includes CounterSink, Drain Set, Shelf, Mounting Clips, Console Legs, Towel Bar and Drain Collar.	
Dome drain and Euro Siphon included as standard. Contact factory to substitute a US P-trap or any other Vitraform drain with the Console.	

B Glass Color	
All Vitraform glass has color at the edge. None are devoid of color.	
Color Group 1	
Item	Color
C	Clear
S	Starphire
Z	Bronze
G	Grey
K	Black
Color Group 2	
P	Peach
A	Azurlite
X	Solex
Color Group 3	
T	Cobalt
B	Blue
W	White ¹
1 For White Color specify Starphire glass with White Lamination in Color Group 1.	

C Glass Finish		
Item	Finish	Add
P	Polished	\$ 00
F	Frosted ¹	
	20"-36" width	\$ 320
	37"-60" width	\$ 385
O	White Lami ³	
	20"-36" width	\$ 320
	37"-60" width	\$ 385
S	Satin Etched ²	
	20"-36" width	\$ 640
	37"-60" width	\$ 770
1 Frosted finish is on bottom surfaces of glass components only.		
2 Satin Etched finish on top and bottom surfaces of glass components.		
3 White Lamination is not available on Black, White or Cobalt.		

D Drain Collar	
Drain Collar included	
Item	
C	Drain Collar

E Specify Width				
Single Basin Pricing				
Item	Group 1	Group 2	Group 3	
24"	\$ 6,493	\$ 6,724	\$ 7,192	
30"	\$ 6,823	\$ 7,109	\$ 7,692	
36"	\$ 7,148	\$ 7,500	\$ 8,193	
42"	\$ 7,478	\$ 7,885	\$ 8,699	
48"	\$ 7,808	\$ 8,270	\$ 9,199	
54"	\$ 8,138	\$ 8,660	\$ 9,705	
60"	\$ 8,468	\$ 9,051	\$ 10,206	
Double Basin Pricing				
Item	Group 1	Group 2	Group 3	
48"	\$ 9,769	\$ 10,231	\$ 11,155	
54"	\$ 10,094	\$ 10,616	\$ 11,661	
60"	\$ 10,424	\$ 11,001	\$ 12,167	

F Select Metal Finish			
		Single	Double
Item	Description	Add	Add
10	Pol. Chrome	\$ 00	\$ 00
12	Pol. Nickel	\$ 180	\$ 365
20	Sat. Chrome	\$ 180	\$ 365
22	Sat. Nickel	\$ 180	\$ 365
15	ORB	\$ 485	\$ 820
16	PVD Pol. Brass	\$ 485	\$ 820
13	PVD Pol. Gold	\$ 835	\$ 1,225
23	PVD Sat. Gold	\$ 835	\$ 1,225



Order Example	A	B	C	D	E	F	To order, select an option in each of columns A through F and add Crating Charges.	
Console Item No.	482	X	P	C	54"	22		
Console Price	-	-	\$ 00	-	\$ 10,616	\$ 365	Total Price	\$ 10,981
	Double Oval Basin	Polished Finish	Width of Counter					
	Solex Glass	Drain Collar	Sat. Nickel Metal Finish					
Net Crating Charges: 24-42" width: \$125, 43-60" width: \$165. Freight additional, request quotation.								

Washstand/Round or Oval Basin With Overflow To order, select an option in each of columns A through F. Include Item No. and Price. See Example at bottom of page.

Retail Price List

A Specify Model	
Prices are for complete Washstand*	
Single Basin	
Item	Description
Rectangular Front	
310	Single Round Basin
360	Single Oval Basin
Double Basin	
Rectangular Front	
312	Double Round Basin
362	Double Oval Basin
* Includes Countersink, Drain Set, Shelf, Side Panels, Mounting Clips and Overflow.	
Dome Pop-up drain and Euro Siphon included as standard. Contact factory to substitute a US P-trap or any other Vitraform drain with the Washstand.	

B Glass Color	
All Vitraform glass has color at the edge. None are devoid of color.	
Color Group 1	
Item	Color
C	Clear
S	Starphire
Z	Bronze
G	Grey
K	Black
Color Group 2	
P	Peach
A	Azurlite
X	Solex
Color Group 3	
T	Cobalt
B	Blue
W	White ¹
¹ For White Color specify Starphire glass with White Lamination in Color Group 1.	

C Glass Finish		
Item	Finish	Add
P	Polished ⁴	\$ 00
O	White Lami ³	
	20"-36" width	\$ 320
	37"-60" width	\$ 385
S	Satin Etched ²	
	20"-36" width	\$ 640
	37"-60" width	\$ 770
² Satin Etched finish on top and bottom surfaces of glass components.		
³ White Lamination is not available on Black, White or Cobalt.		
⁴ Polished finish on glass colors other than Black, White or Cobalt is not recommended. Assembly by experienced glass installer using optically clear adhesive is necessary.		

D Overflow	
Overflow included.	
Item	
F	Overflow

E Specify Width				
Single Basin Washstand Pricing				
Item	Group 1	Group 2	Group 3	
24"	\$ 7,788	\$ 8,371	\$ 9,532	
30"	\$ 8,118	\$ 8,756	\$ 10,032	
36"	\$ 8,443	\$ 9,147	\$ 10,533	
42"	\$ 8,773	\$ 9,532	\$ 11,039	
48"	\$ 9,103	\$ 9,917	\$ 11,539	
54"	\$ 9,433	\$ 10,307	\$ 12,045	
60"	\$ 9,763	\$ 10,698	\$ 12,546	
Double Basin Washstand Pricing				
Item	Group 1	Group 2	Group 3	
48"	\$ 10,978	\$ 11,792	\$ 13,415	
54"	\$ 11,308	\$ 12,183	\$ 13,921	
60"	\$ 11,638	\$ 12,568	\$ 14,421	

F Select Metal Finish			
		Single	Double
Item	Description	Add	Add
10	Pol. Chrome	\$ 00	\$ 00
12	Pol. Nickel	\$ 180	\$ 365
20	Sat. Chrome	\$ 180	\$ 365
22	Sat. Nickel	\$ 180	\$ 365
15	ORB	\$ 385	\$ 725
16	PVD Pol. Brass	\$ 385	\$ 725
13	PVD Pol. Gold	\$ 540	\$ 945
23	PVD Sat. Gold	\$ 540	\$ 945

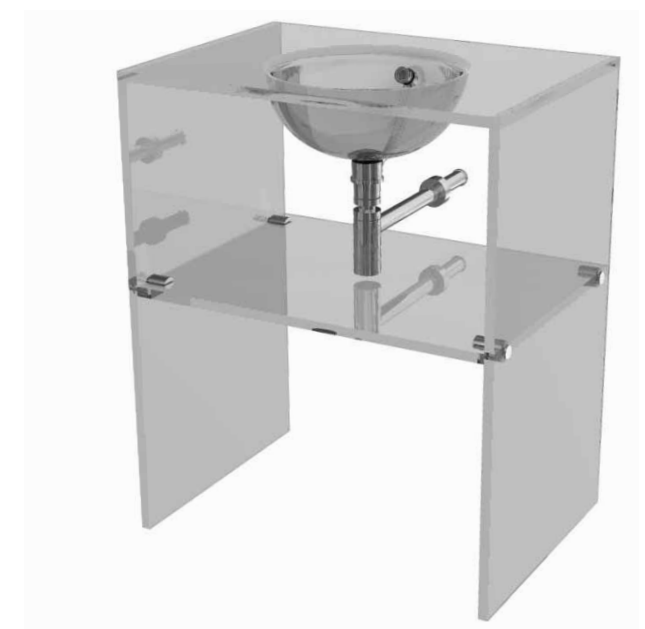

Order Example	A	B	C	D	E	F	To order, select an option in each of columns A through F and add Crating Charges.	
Washstand Item No.	360	S	S	F	54"	22		
Washstand Price	-	-	\$ 770	-	\$ 9,433	\$ 180	Total Price	\$ 10,383
Single Oval Basin Satin Etched Finish Width of Counter Starphire Glass Overflow Sat. Nickel Metal Finish								
Net Crating Charges per Washstand: 24-42" width: \$125, 43-60" width: \$165 Freight additional, request quotation.								

Washstand/Round or Oval Basin Without Overflow To order, select an option in each of columns A through F. Include Item No. and Price. See Example at bottom of page.

Retail Price List

A Specify Model	
Prices are for complete Washstand*	
Single Basin	
Item	Description
Rectangular Front	
310	Single Round Basin
360	Single Oval Basin
Double Basin	
Rectangular Front	
312	Double Round Basin
362	Double Oval Basin
* Includes Countersink, Drain Set, Shelf, Side Panels, Mounting Clips and Drain Collar.	
Dome Pop-up drain and Euro Siphon included as standard. Contact factory to substitute a US P-trap or any other Vitraform drain with the Washstand.	

B Glass Color	
All Vitraform glass has color at the edge. None are devoid of color.	
Color Group 1	
Item	Color
C	Clear
S	Starphire
Z	Bronze
G	Grey
K	Black
Color Group 2	
P	Peach
A	Azurlite
X	Solex
Color Group 3	
T	Cobalt
B	Blue
W	White ¹
¹ For White Color specify Starphire glass with White Lamination in Color Group 1.	

C Glass Finish		
Item	Finish	Add
P	Polished ⁴	\$ 00
O	White Lami ³	
	20"-36" width	\$ 320
	37"-60" width	\$ 385
S	Satin Etched ²	
	20"-36" width	\$ 640
	37"-60" width	\$ 770
² Satin Etched finish on top and bottom surfaces of glass components.		
³ White Lamination is not available on Black, White or Cobalt.		
⁴ Polished finish on glass colors other than Black, White or Cobalt is not recommended. Assembly by experienced glass installer using optically clear adhesive is necessary.		

D Drain Collar	
Drain Collar included.	
Item	Drain Collar
C	Drain Collar

E Specify Width				
Single Basin Washstand Pricing				
Item	Group 1	Group 2	Group 3	
24"	\$ 7,621	\$ 8,204	\$ 9,364	
30"	\$ 7,951	\$ 8,589	\$ 9,865	
36"	\$ 8,275	\$ 8,979	\$ 10,365	
42"	\$ 8,605	\$ 9,364	\$ 10,871	
48"	\$ 8,935	\$ 9,749	\$ 11,372	
54"	\$ 9,265	\$ 10,140	\$ 11,878	
60"	\$ 9,595	\$ 10,530	\$ 12,378	
Double Basin Washstand Pricing				
Item	Group 1	Group 2	Group 3	
48"	\$ 10,644	\$ 11,458	\$ 13,080	
54"	\$ 10,974	\$ 11,848	\$ 13,586	
60"	\$ 11,304	\$ 12,233	\$ 14,087	









F Select Metal Finish			
		Single	Double
Item	Description	Add	Add
10	Pol. Chrome	\$ 00	\$ 00
12	Pol. Nickel	\$ 180	\$ 365
20	Sat. Chrome	\$ 180	\$ 365
22	Sat. Nickel	\$ 180	\$ 365
15	ORB	\$ 380	\$ 715
16	PVD Pol. Brass	\$ 380	\$ 715
13	PVD Pol. Gold	\$ 525	\$ 915
23	PVD Sat. Gold	\$ 525	\$ 915

Order Example	A	B	C	D	E	F	To order, select an option in each of columns A through F and add Crating Charges.	
Washstand Item No.	360	P	S	C	54"	22		
Washstand Price	-	-	\$ 770	-	\$ 10,140	\$ 180	Total Price	\$ 11,090
	Single Oval Basin	Satin Etched Finish	Width of Counter					
		Peach Glass	Drain Collar			Sat. Nickel Metal Finish		
Net Crating Charges per Washstand: 24-42" width: \$125, 43-60" width: \$165 Freight additional, request quotation.								



Drains All Drain Sets include either US P-Trap or Euro-Siphon. To order, select Item Number and Metal Finish Code to replace "XX". See Example at bottom of page.

Retail Price List

		Finish Group 1	Finish Group 2	Finish Group 3	Finish Group 4		
		10 Pol. Chrome	12 Pol. Nickel 20 Sat. Chrome 22 Sat. Nickel	15 ORB 16 PVD Pol. Brass	13 PVD Pol. Gold 23 PVD Sat. Gold		
Grid Strainer Set						US P-Trap	Euro-Siphon
Item	Description						
810.XX	with Overflow with US P-Trap	\$ 220	\$ 400	\$ 550	\$ 605		
811.XX	without Overflow with US P-Trap	\$ 220	\$ 400	\$ 550	\$ 605		
810.XX.S	with Overflow with Euro-Siphon	\$ 375	\$ 555	\$ 705	\$ 760		
811.XX.S	without Overflow with Euro-Siphon	\$ 375	\$ 555	\$ 705	\$ 760		
Pivot Drain Set						US P-Trap	Euro-Siphon
Item	Description						
820.XX	with Overflow with US P-Trap	\$ 220	\$ 400	\$ 550	\$ 605		
821.XX	without Overflow with US P-Trap	\$ 220	\$ 400	\$ 550	\$ 605		
820.XX.S	with Overflow with Euro-Siphon	\$ 375	\$ 555	\$ 705	\$ 760		
821.XX.S	without Overflow with Euro-Siphon	\$ 375	\$ 555	\$ 705	\$ 760		
Dome Drain Open Set						US P-Trap	Euro-Siphon
Item	Description						
860.XX	with Overflow with US P-Trap	\$ 220	\$ 400	\$ 550	\$ 605		
861.XX	without Overflow with US P-Trap	\$ 220	\$ 400	\$ 550	\$ 605		
860.XX.S	with Overflow with Euro-Siphon	\$ 375	\$ 555	\$ 705	\$ 760		
861.XX.S	without Overflow with Euro-Siphon	\$ 375	\$ 555	\$ 705	\$ 760		
Dome Drain Pop-up Set						US P-Trap	Euro-Siphon
Item	Description						
862.XX	with Overflow with US P-Trap	\$ 220	\$ 400	\$ 550	\$ 605		
863.XX	without Overflow with US P-Trap	\$ 220	\$ 400	\$ 550	\$ 605		
862.XX.S	with Overflow with Euro-Siphon	\$ 375	\$ 555	\$ 705	\$ 760		
863.XX.S	without Overflow with Euro-Siphon	\$ 375	\$ 555	\$ 705	\$ 760		

Order Example	Item No.	Finish Code	Price ea.	Qty	Total
Drain Item No.	862	22.S	\$ 555	1	\$ 555
Dome Drain Pop-up Set with Overflow with Euro-Siphon Sat. Nickel Metal Finish					

Hardware To order, select Item Number and Metal Finish Code to replace "XX". See Example at bottom of page. Retail Price List

Available only for use with Vitraform Products.		Finish Group 1	Finish Group 2	Finish Group 3	Finish Group 4
		10 Pol. Chrome	12 Pol. Nickel 20 Sat. Chrome 22 Sat. Nickel	15 ORB 16 PVD Pol. Brass	13 PVD Pol. Gold 23 PVD Sat. Gold

Mono Mount for Freestanding Basins					
Item	Description				
711.XX	Each	\$ 440	\$ 440	\$ 490	\$ 525

Hardware only. Mount does not include Basin or Drain.
Order Basin and Drain separately.



In-Wall Mount Trim and Rough					
Item	Description				
750.XX	12" Arm Each	\$ 355	\$ 355	\$ 385	\$ 430

Includes U-Channel rough.



In-Wall Mount Trim and Rough with Towel Bar					
Item	Description				
751.XX	Two 18" Arms with Straight Towel Bar Set	\$ 1,078	\$ 1,078	\$ 1,175	\$ 1,290
755.XX	Two 12" Arms with Curved Towel Bar Set (Use with OVAL Bowl with 6" to 8" Wall Mount Faucet)	\$ 1,078	\$ 1,078	\$ 1,175	\$ 1,290
756.XX	Two 18" Arms with Curved Towel Bar Set (Use with ROUND Bowl & OVAL Bowl with 6" to 9" Wall or Deck Mount Faucet)	\$ 1,125	\$ 1,125	\$ 1,220	\$ 1,335

Includes U-Channel rough.



In-Wall Mount Trim and Rough for Masonry					
Item	Description				
753.XX	12" Arm Each	\$ 355	\$ 355	\$ 385	\$ 430

Includes U-Channel rough.



Order Example	Item No.	Finish Code	Price ea.	Qty	Total
Hardware Item	750	16	\$ 385	2	\$ 770
In-Wall Mount		PVD Pol. Brass Metal Finish			

Hardware To order, select Item Number and Metal Finish Code to replace "XX". See Example at bottom of page.

Retail Price List

Available only for use with Vitraform Products.		Finish Group 1	Finish Group 2	Finish Group 3	Finish Group 4
		10 Pol. Chrome	12 Pol. Nickel 20 Sat. Chrome 22 Sat. Nickel	15 ORB 16 PVD Pol. Brass	13 PVD Pol. Gold 23 PVD Sat. Gold
Cabinet Pull					
Item	Description				
VCP.XX	Each	\$ 18	\$ 18	\$ 25	\$ 30
Side Wall Mount Trim and Rough					
Item	Description				
741.XX	Each	\$ 110	\$ 110	\$ 125	\$ 145
Surface Clip					
Item	Description				
760.XX	Each	\$ 100	\$ 100	\$ 120	\$ 140
Flush Clip					
Item	Description				
761.XX	Each	\$ 135	\$ 135	\$ 145	\$ 160
U-Channel					
Item	Description				
751.54	Price Per Linear Foot. Aluminum.	\$ 30			
Six Inch Tapered Leg					
Item	Description				
780.XX	Each	\$ 265	\$ 265	\$ 290	\$ 300
Counter Support Leg					
Item	Description				
790.XX	Two Part (Round) Each	\$ 175	\$ 175	\$ 240	\$ 290
791.XX	Rectangular Each	\$ 345	\$ 345	\$ 405	\$ 450



Order Example	Item No.	Finish Code	Price ea.	Qty	Total
Hardware Item	761	15	\$ 145	1	\$ 145
 Flush Clip Oil Rubbed Bronze Metal Finish					

Hardware To order, select Item Number and Metal Finish Code to replace "XX". See Example at bottom of page.

Retail Price List

Hardware only. Does not include glass. Available only for use with Vitraform Products.		Finish Group 1	Finish Group 2	Finish Group 3	Finish Group 4	Hardware only. Set does not include glass.
		10 Pol. Chrome	12 Pol. Nickel 20 Sat. Chrome 22 Sat. Nickel	15 ORB 16 PVD Pol. Brass	13 PVD Pol. Gold 23 PVD Sat. Gold	

Round Console Legs without Shelf (Tubular metal)

Item	Description				
775.XX	Console Legs (Pair)	\$ 685	\$ 685	\$ 760	\$ 950



Round Console Legs with Towel Bar

Item	Description				
776.XX	Console Legs (Pair) with Straight Towel Bar in front	\$ 1,034	\$ 1,034	\$ 1,122	\$ 1,320
777.XX	Console Legs (Pair) with Curved Towel Bar in front	\$ 1,078	\$ 1,078	\$ 1,188	\$ 1,408



Round Console Legs with Shelf

Item	Description				
775.XX.S	Console Legs (Pair) No Towel Bar	\$ 905	\$ 905	\$ 980	\$ 1,165
776.XX.S	Console Legs (Pair) with Straight Towel Bar	\$ 1,254	\$ 1,254	\$ 1,342	\$ 1,540
777.XX.S	Console Legs (Pair) with Curved Towel Bar	\$ 1,300	\$ 1,300	\$ 1,410	\$ 1,630



Order Example	Item No.	Finish Code	Price ea.	Qty	Total
Hardware Item	777	22	\$ 1,078	1	\$ 1,078
Round Console Legs (Pair) with cuved Towel Bar Sat. Nickel Metal Finish					

Hardware To order, select Item Number and Metal Finish Code to replace "XX". See Example at bottom of page.

Retail Price List

Hardware only. Does not include glass. Available only for use with Vitraform Products.		Finish Group 1	Finish Group 2	Finish Group 3	Finish Group 4	Hardware only. Set does not include glass.
		10 Pol. Chrome	12 Pol. Nickel 20 Sat. Chrome 22 Sat. Nickel	15 ORB 16 PVD Pol. Brass	13 PVD Pol. Gold 23 PVD Sat. Gold	

Rectangular Console Legs without Shelf

Item	Description				
785.XX	Console Legs (Pair)	\$ 1,155	\$ 1,155	\$ 1,275	\$ 1,510



Rectangular Console Legs with 1 Towel Bar

Item	Description				
786.XX	Console Legs (Pair) with Straight Towel Bar in front	\$ 1,680	\$ 1,680	\$ 1,766	\$ 1,965



Rectangular Console Legs with up to 3 Towel Bars

Item	Description				
787.XX	Console Legs (Pair) w Straight Towel Bar Front & 1 Side	\$ 2,080	\$ 2,080	\$ 2,180	\$ 2,390
788.XX	Console Legs (Pair) Straight Towel Bar Front & 2 Sides	\$ 2,475	\$ 2,475	\$ 2,585	\$ 2,805



Order Example	Item No.	Finish Code	Price ea.	Qty	Total
Hardware Item	786	16	\$ 1,766	1	\$ 1,766
Rectangular Console Legs (Pair) with Straight Towel Bar in Front PVD Pol. Brass Metal Finish					

Hardware To order, select Item Number and Metal Finish Code to replace "XX". See Example at bottom of page.

Retail Price List

Hardware only. Does not include counter. Available only for use with Vitraform Products.	Finish Group 1	Finish Group 2	Finish Group 3	Finish Group 4	Hardware only. Set does not include glass.
	10 Pol. Chrome	12 Pol. Nickel 20 Sat. Chrome 22 Sat. Nickel	15 ORB 16 PVD Pol. Brass	13 PVD Pol. Gold 23 PVD Sat. Gold	

Cristal Glass Rod Console Legs

Item	Description				
771.LP.XX	Polished Glass (Pair) for glass counters	\$ 880	\$ 880	\$ 1,045	\$ 1,210
771.LF.XX	Frosted Glass (Pair) for glass counters	\$ 990	\$ 990	\$ 1,155	\$ 1,320
771.LP.XX.ST	Polished Glass (Pair) for stone counters	\$ 880	\$ 880	\$ 1,045	\$ 1,210
771.LF.XX.ST	Frosted Glass (Pair) for stone counters	\$ 990	\$ 990	\$ 1,155	\$ 1,320



Cristal Glass Rod Towel Bar

Item	Description				
772.LP.XX	Polished Glass with Two Supports	\$ 430	\$ 430	\$ 540	\$ 650
772.LF.XX	Frosted Glass with Two Supports	\$ 485	\$ 485	\$ 595	\$ 705



Order Example	Item No.	Finish Code	Price ea.	Qty	Total
Hardware Item	771.LF	15	\$ 1,155	1	\$ 1,155
Cristal Frosted Glass Rod Console Legs		ORB Metal Finish			

Ordering information

Retail Price List

Warranty

Vitraform warrants for a period of five years that the product will be free from defects in material and Workmanship in accordance with Glass Industry Standards, when installed in Lavatory applications. This Warranty is expressly made in lieu of any and all other warranties, expressed or implied, which are hereby expressly disclaimed. This Warranty does not cover damage caused to the goods during shipment, or by improper installation techniques, modifications, physical force or other abuse and does not cover any related labor charges, removal and reinstallation expense, freight or postage. Vitraform shall only be responsible for repairing or replacing any part or parts that do not comply with this Warranty, as determined by Vitraform. Vitraform's total liability under this Warranty will not exceed the purchase price for the goods and will not include consequential damages.

Warranty Claims

Any warranty claims must be made in writing to Vitraform, 3500 Blake Street, Denver, CO 80205. Please include original Vitraform Sales Order or Invoice number, date of purchase, item(s) description and description of claim.

Shortage

Claims for shortages must be made in writing to Vitraform within 5days of receipt of shipment.

Freight Claims

Claims for freight damage must be made with the carrier. Note visible damage to cartons or crates upon receipt and inspect shipment. Request inspection by the carrier within the time limit allowed by the carrier.

Returns

All return goods must be accompanied by a Return Goods Authorization form provided by and at the discretion of Vitraform within 6 months of receipt of product. All products accepted for return will bear a 25% restock fee. Due to the broad range of options and potentially custom nature of some items, Vitraform may not accept return of products in certain colors, finishes or engraved designs. Please order carefully. RGA requests must be submitted in writing by the authorized Vitraform Dealer that purchased the item. Provide original purchase order number and date, description of item(s) to be returned and reason for return. Items that have been installed will only be accepted for return if warranty is involved. If Vitraform accepts the return for evaluation, a copy of a written RGA form will be provided to include with the returned item. The item must be returned within 30 days of receipt of written RGA form. Items accepted for return must be packed in original box with original packing, insured and shipped prepaid. New Vitraform boxes may be ordered for safe return if original box is unavailable. A \$15.00 box charge and outbound freight will be charged. If damage occurs during shipping, due to improper packing, no credit will be issued. Vitraform will inspect the condition of the product upon receipt and evaluate the amount of credit or repair charges due, if any.

Prices

Vitraform reserves the right to change prices without notice at any time before confirmation of your order. Prices shown are Retail prices with the exception of Freight and Crating, which are Net. Additional charges exist and are referred to as: shipping, delivery, insurance, export documentation, handling and storage. All prices shown are F.O.B. Denver, CO.

Shipping and Crating

Vitraform Standard Basins, Freestanding Basins and Hardware are packed in boxes and may be shipped via UPS, Federal Express, or Common Carrier. There are no box charges for these items. Countersinks, Countertops, Vanities, Pedstals and Mirrors are crated to be shipped Common Carrier. Crating charges are listed on the Price List page for those items.

Freight Charges

All freight charges are Net. Retail prices for products do not include freight charges. Please refer to the table below to estimate freight for Vitraform products. Most carriers have web sites that allow you to use box size and weight shown below to quote freight. Remember to add insurance.

Size and Weight for Standard Vitraform Products

	Box Size	Domestic Dimensional Weight	International Dimensional Weight	Actual Weight
	Depth x Width x Height			
Standard Basins				
Undermount & Drop-in Round	20 x 22 x 12"	30 lbs.	42 lbs.	25 lbs.
Undermount & Drop-in Oval	26 x 22 x 12"	30 lbs.	42 lbs.	28 lbs.
Freestanding Basins and Rimless Undermount Basins				
Small Round	21 x 18 x 10"	20 lbs.	23 lbs.	20 lbs.
Large Round	20 x 22 x 12"	30 lbs.	42 lbs.	30 lbs.
Small Oval	23 x 18 x 10"	22 lbs.	25 lbs.	20 lbs.
Large Oval	26 x 22 x 12"	30 lbs.	42 lbs.	30 lbs.
Large Round with Pencil Edge	20 x 22 x 12"	30 lbs.	42 lbs.	25 lbs.

CounterSinks, CounterTops, Vanities and Pedestals

Request quotation

Vitraform Finishes

Glass Colors

	Polished	Frosted	White Lami	Satin Etched	Mirror
White		NA	NA	NA	NA
Clear					
Starphire					
Cristal					NA
Cristal Antique		NA	NA	NA	
Solex					
Azurlite					
Blue					
Cobalt			NA		NA
Grey					
Black			NA	NA	NA
Bronze					
Peach					

Glass colors offered only with the finishes shown. Contact Factory for custom options.

Engraved Designs



Empire Floral Victorian Deco Tulip



Tulip Border Traditional Roman Moderne 1960

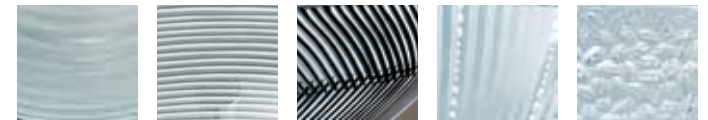

1930 Fine Lines Bamboo Battuto Confetti



Zebra Tabori Arabesque Palmier Entre Deux

Wood Finishes



Anigre Ebony Sapele Sycamore Teak



Walnut Wenge

Gilded Finishes

Please refer to Gilded Price List for gold finishes.